

# Behavioral Health Collection



## Krug Behavioral Health

Comprehensive Solutions for High Intensity Environments

Krug, in consultation with senior healthcare designers and clinicians, has developed a series of highly functional, extremely durable, easily cleanable, attractive behavioral healthcare furniture solutions containing numerous security features including ligature and elopement resistant designs, soft edges, restricted access points, tamper resistant hardware and supplemental weight for enhanced patient and staff safety. The fulsome offering includes a broad range of options for day-room, dining, and activity areas as well as intake, consult spaces and patient rooms. Almost all major components are field replaceable, ensuring minimal downtime for repairs and exceptional ROI.





## Juno Behavioral Health

Juno Behavioral Health Casegoods are built to last. Meticulously designed and engineered with numerous enhanced safety features such as sloped tops, inset, fixed shelves, rounded edges, tamper resistant hardware, Juno Behavioral Health Casegoods provide the highest level of safety for both patients and staff. For additional security, beds, cabinets, and desks can be anchored to the floor or wall.

## Solis Behavioral Health

Solis Behavioral Health guest and patient chairs, available in multiple sizes and configurations, are designed with durable steel frame construction, rounded edges, staple covers and tamper resistant hardware. To further increase safety, chairs can be anchored to the floor and supplemental weight can be specified to minimize the risk of weaponization. Any 21" or 24" guest or patient chair can be optioned with kinetic back hardware. Guest and patient chairs can also be optioned with springless construction and a tamper resistant splashguard. 21" and 24" guest and patient chairs are rated to 500 lbs, 30" guest and patient chairs, and 44" guest chairs, are rated to 750 lbs.

## Faeron Behavioral Health Guest & Patient

We've expanded the award-winning (Nightingale Gold Award) Faeron Metal collection to include customizable options that make this series an ideal choice for Behavioral Health environments. Guest and Patient chairs are available in multiple sizes and designed with durable steel frame construction, tamper resistant hardware, staple covers, rounded edges, and are standard with a sled base. Additional options to increase safety include supplemental weight to minimize risk of weaponization and floor anchor brackets. Back height options include mid back or high back and optional kinetic back hardware is also available on any 21" or 24" guest or patient chair. Guest chairs are rated to a minimum of 500 lbs. per chair for all 21" and 24" models and 750 lbs. for 30" and 44" plus size models. Ganged seating is also available in a range of different configurations. Coordinates seamlessly with Faeron Behavioral Health Lounge and Zola Behavioral Health Tables.





## Faeron Lounge Behavioral Health

A powerful blend of form and function, Faeron Behavioral Health Lounge combines an attractive residential look with uncompromising safety features including anti-ligature design, soft edges, supplemental weight, tamper resistant hardware and staple covers, restricted access points and anti-ligature features for the safety and security of patients and staff. Additional safety features are available such as supplemental weight, under-seat shields and anchoring hardware. Faeron Behavioral Health Lounge is a superior choice for dayrooms, activity areas, intake spaces and lobbies. The offering coordinates seamlessly with Faeron Behavioral Health guest and patient seating as well as Zola Behavioral Health tables. Weight ratings range from 500 lbs.-1200 lbs.





# Leyton

## Behavioral Health

Leyton Behavioral Health exemplifies sophisticated elegance while offering a multitude of standard features for enhanced patient and staff safety. Leyton's minimalist silhouette belies its heavy-duty robust construction which make it an ideal choice for intense environments. Standard safety features include tamper resistant hardware, staple covers, secured glides and restricted access points. The contemporary sled base design can be bolted to the floor with optional anchor brackets and supplemental weight and a steel under-seat shield can be optioned to further increase staff and patient safety. The offering includes lounge chairs, loveseats, sofas and tables. Weight ratings for Leyton Behavioral Health range from 750 lbs-1200 lbs.













## Zola Behavioral Health

Zola Behavioral Health has been developed through a meticulous and extensive research process. We've consulted with, and had this product reviewed by, leading facilities professionals, specifiers and consultants specializing in behavioral health environments. We set out to create a market-leading, durable solution for the protection and safety of patients and care-givers - and yet with an aesthetic appeal that contributes to making behavioral health environments less clinical, by adding warmth and a less institutional sensibility. The offering includes lounge chairs, loveseats, sofas and coordinating tables which are standard with a multitude of standard safety features including tamper resistant hardware, staple covers, secure glides and springless seat construction. For additional safety, seating and tables can be specified with supplemental weight and anchoring brackets.

# Behavioral Health



## Karma

An exceptional choice for any area where a lighter weight chair is needed. Designed with a steel frame, sled base, tamper resistant hardware and staple covers for patient and staff safety. The integrated steel rail spans between the front and rear legs which are fitted with non-removable black nylon glides. Available with or without arms and with fully upholstered or wood backs. Supplemental weight is an additional option. Karma chairs are available in multiple sizes, 18.5", 22" and 26" and each is rated to 500 lbs.

## Chit Chat Tables

Laminate or Solid Surface Tops are available in a range of sizes and shapes with steel base design. Safety features include soft edges, tamper resistant hardware and optional floor brackets to anchor base.



# Tate Benches Behavioral Health



**FLEX BACK**  
The ergonomically-designed back has a slight flexing action, which significantly enhances comfort.



**WALL SAVER**  
The angle of the back and the rear legs are designed to keep the back away from the wall, to prevent wear and damage to both the chairs and to the walls of the facility.



**SLED BASE**  
The metal side frames legs have the option to be tied front to back with a steel rail, this will strengthen the frames and eliminate the option of having legs.



**TAMPER RESISTANT HARDWARE**  
All screws used on all the Behavioral Health units have been replaced with tamper resistant security screws.

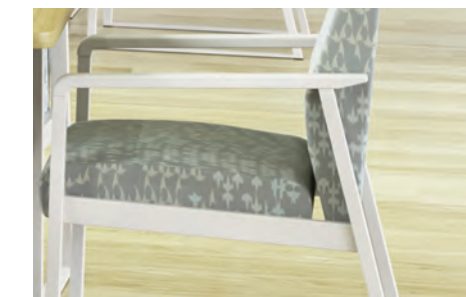

**CLEAN OUT**  
A clean-out space between the seat and back makes for easier cleaning and maintenance.



**SECURED GLIDES**  
Behavioral Health chairs have their glides secured in place to prevent their removal and damage.

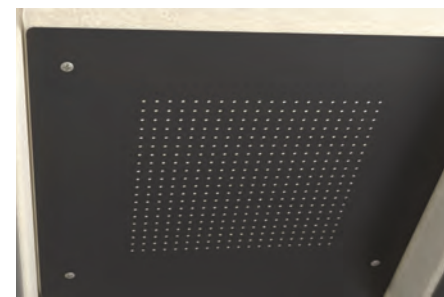

**BOTTOM STAPLE COVER/SHIELD**  
This cover is designed to prevent access to the upholstery staples of the seat and to prevent the hiding of objects underneath the seat. The cover is also designed to allow for regular ganging hardware and proper seat ventilation.



**BACK STAPLE COVER STRIP**  
Behavioral Health back upholstery has been altered to allow a staple cover strip to be attached; this will prevent access to the upholstery staples. The cover strip is nylon coated galvanized steel with vinyl coated ends to prevent any sharp edges.

Tate features an elegant design and sophisticated lines. Built with safety features such as tamper resistant hardware and staple covers, Tate is an ideal choice for patient corridor seating, lobbies and common areas. Supplemental weight is optional as are anchor brackets to affix the sled base design to the floor. Tate weight ratings range from 975 lbs.-1,200 lbs.

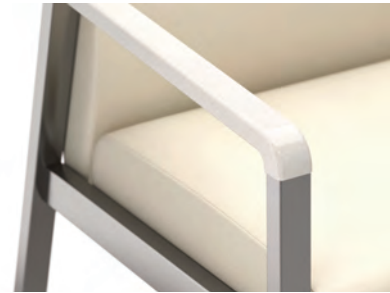

**SOLID SURFACE ARM**

Optional Solid Surface Arms provide a fully seamless, durable, easy to clean armrest. Available in 8 standard Corian colors and replaceable as a full side frame.



**SECURED WOODEN ARM**

Wood Arm caps are fastened to the side frames with tamper resistant security screws. Wood arms are available in solid beech hardwood and in 22 Krug standard finishes.



**NO SPRING SEATS**

The springs in the seat have been removed and replaced with a solid plywood seat pan. Additional foam has also been added in place of the springs for comfort.

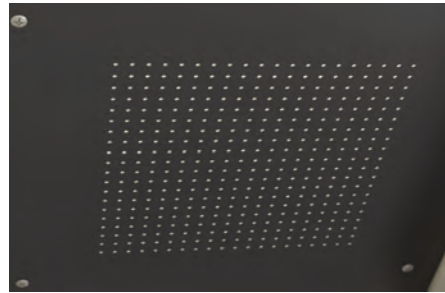

**WEIGHTED SHIELD**

This steel shield option is designed to add enough weight for the product to be a minimum of 80 lbs.



**TAMPER-RESISTANT SPLASHGUARD**

A coated steel moisture barrier that covers and enclosed the underside of the seat (while still allowing air transfer and ventilation in and out of the seat cushion).



**FLOOR ANCHOR BRACKETS**

Floor mounting brackets are supplied to be secured to the bottom of the sleigh base with tamper resistant security screws. (The hardware to attach the brackets to the floor is not provided by Krug.)



**KINETIC BACK**

This optional feature provides the chair back with a very pleasant and comfortable rocking motion, which can significantly enhance long-term sitting for patients and guests. The durable spring-loaded mechanism provides a range of motion of 20 degrees, and can be field-installed or replaced



**COMBINATION UPHOLSTERY**

Combination upholstery option includes more than one upholstery cover within the same unit. Back, Seat, Closed or Semi-closed arm can be specified in a different fabric selection.

**Faeron Guest**

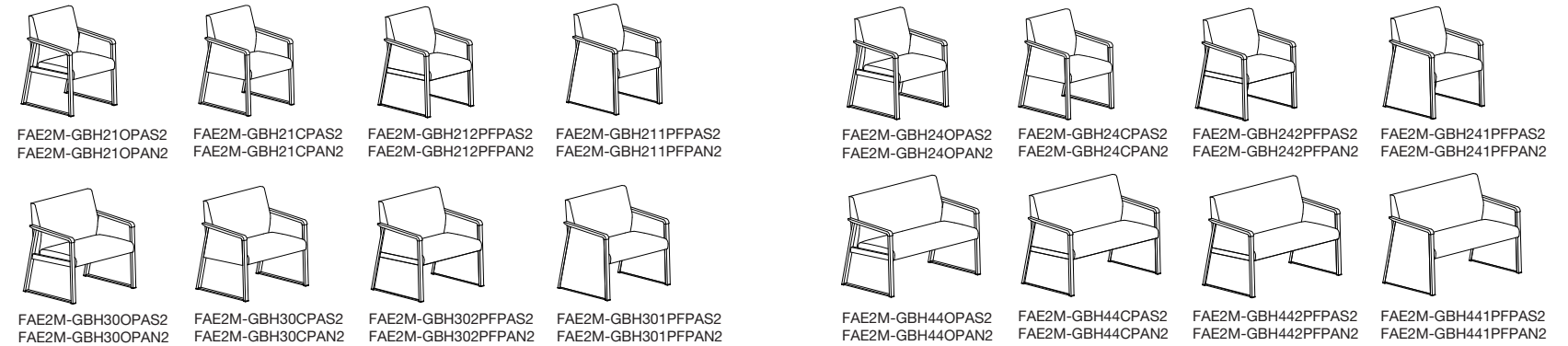

**Faeron Patient**

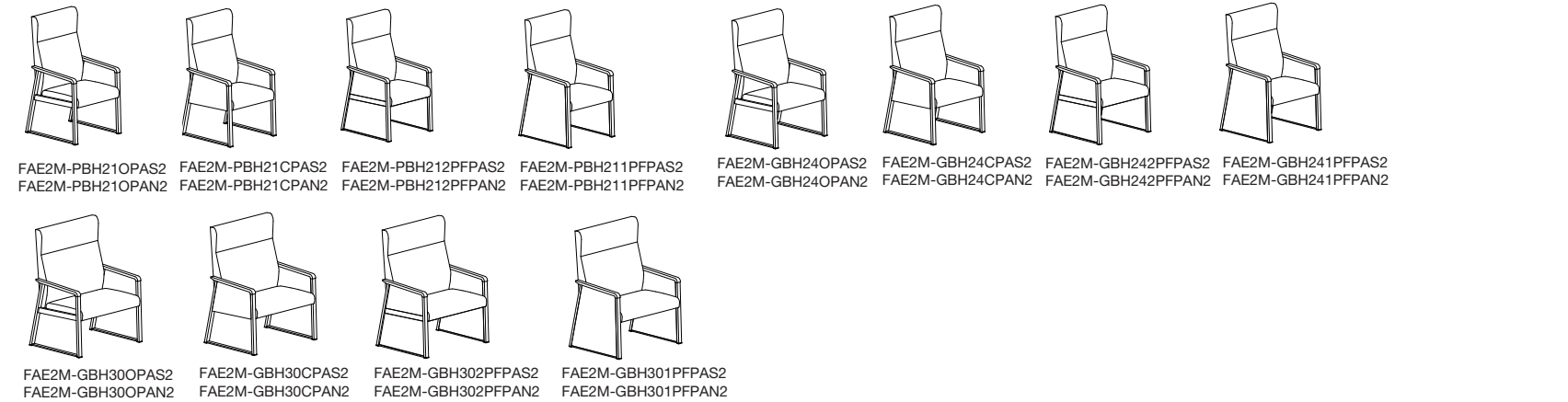

**Faeron Multiple Seating (also available in Patient back)**

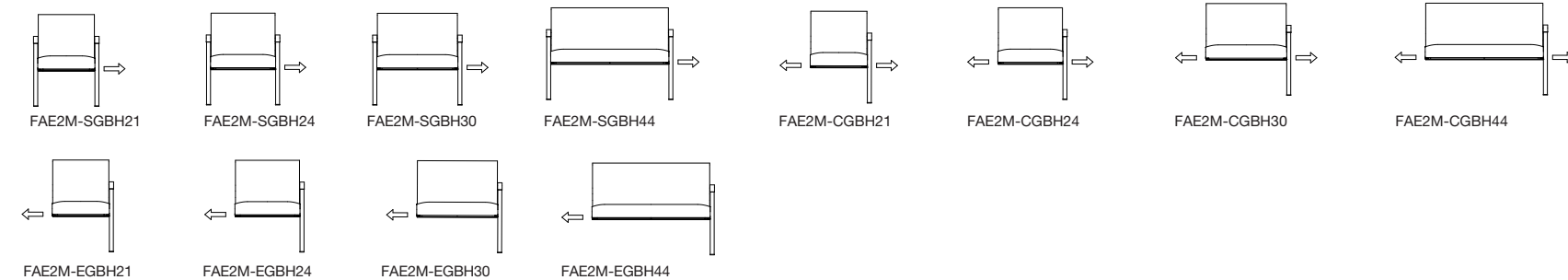

### Faeron Lounge

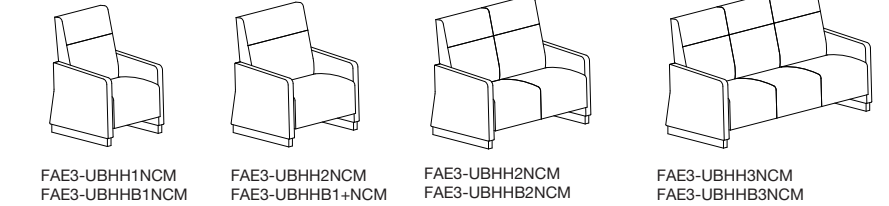
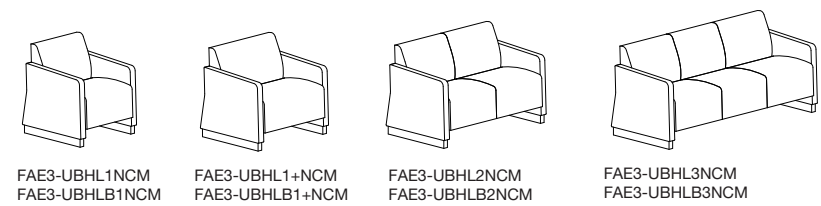
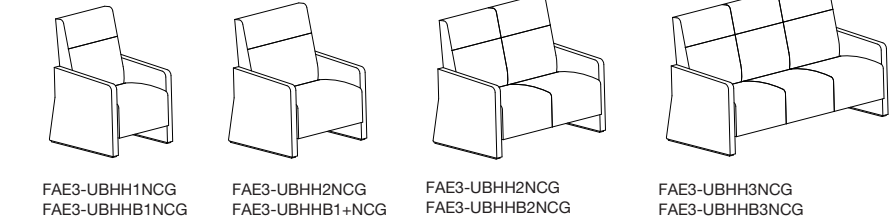
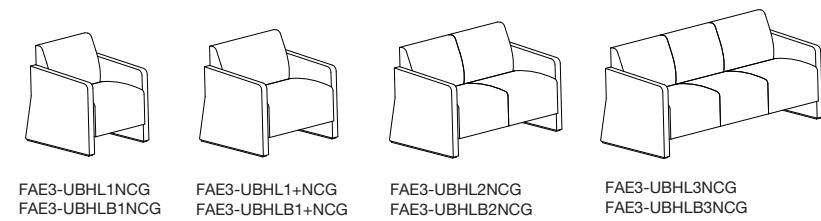
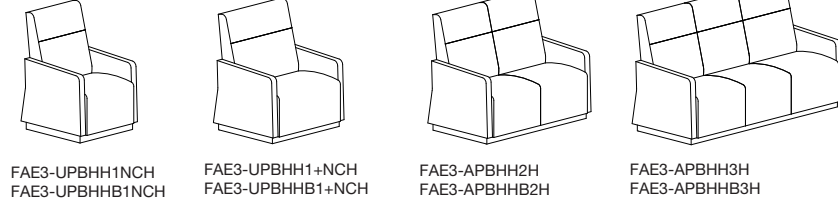
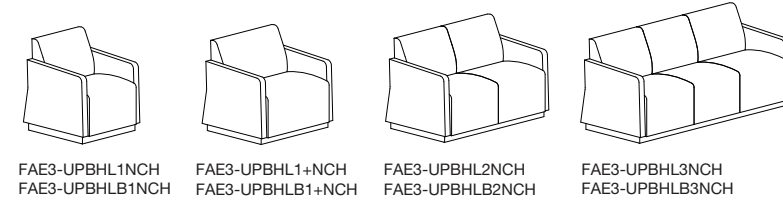
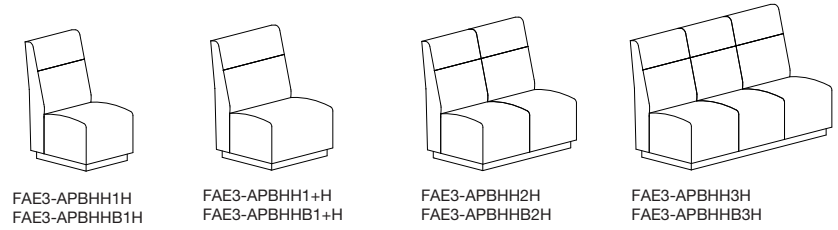
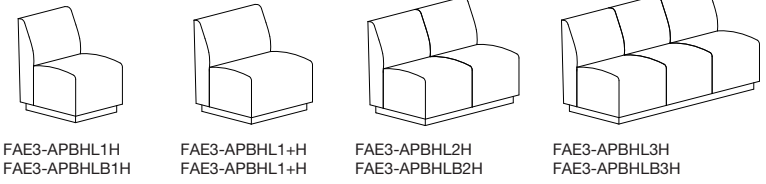

### Zola Behavioral Health Tables | Perfect solution to accompany Faeron Behavioral Health Seating

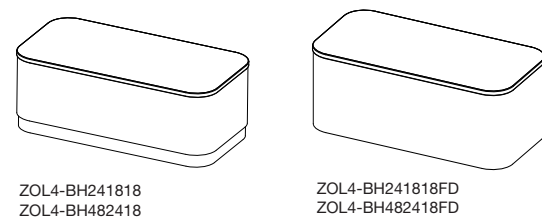
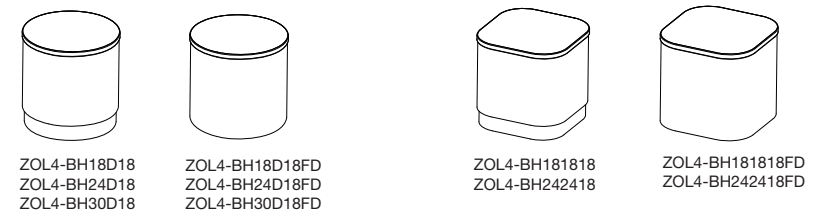

### Solis Guest & Patient

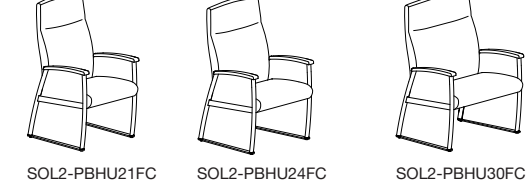
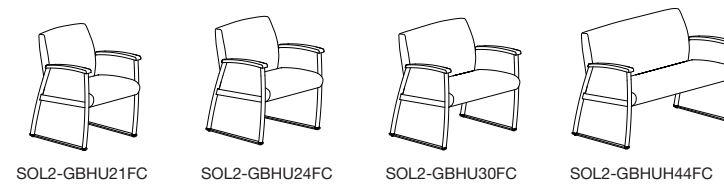
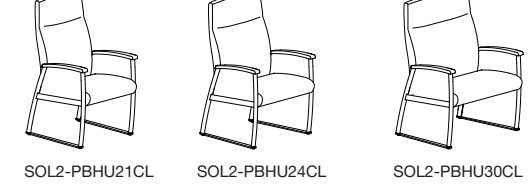
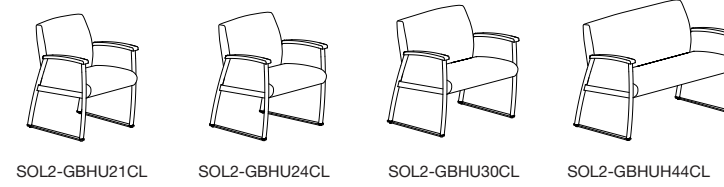
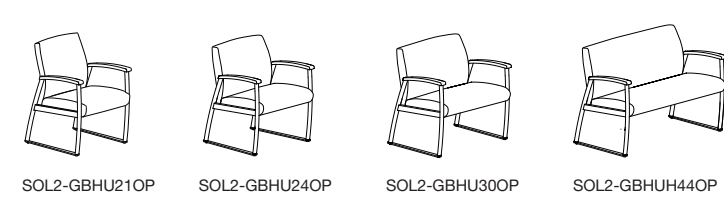

### Solis Multiple Seating (also available in Patient back)

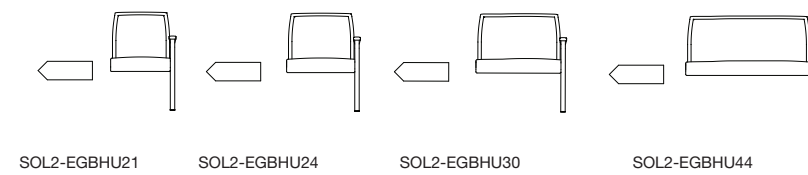
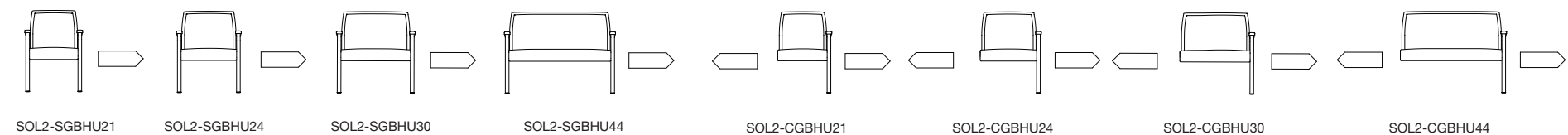



### Leyton Lounge & Tables

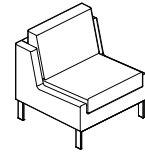

LEY3-BH1UN0

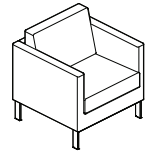

LEY3-BH1UF0

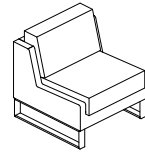

LEY3-BH1UN1

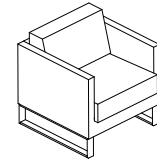

LEY3-BH1UF1

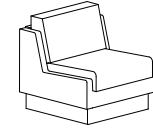

LEY3-BH1UN2

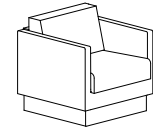

LEY3-BH1UF2

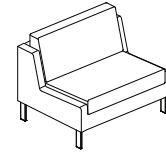

LEY3-BH1.5UN0

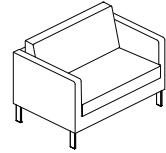

LEY3-BH1.5UF0

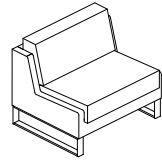

LEY3-BH1.5UN1

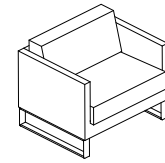

LEY3-BH1.5UF1

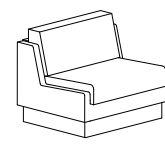

LEY3-BH1.5UN2

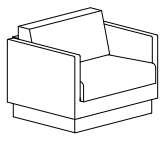

LEY3-BH1.5UF2

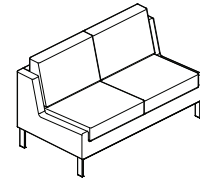

LEY3-BH2UN0

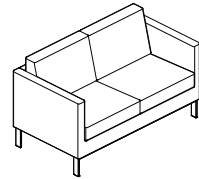

LEY3-BH2UF0

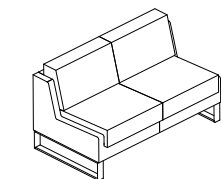

LEY3-BH2UN1

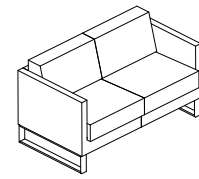

LEY3-BH2UF1

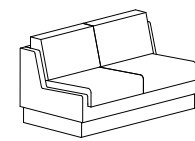

LEY3-BH2UN2

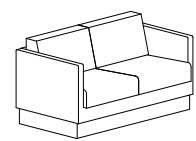

LEY3-BH2UF2

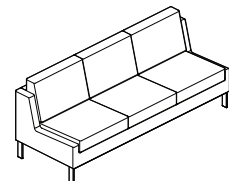

LEY3-BH3UN0

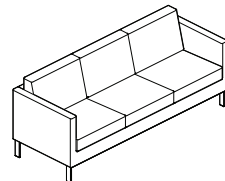

LEY3-BH3UF0

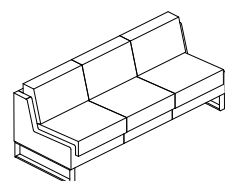

LEY3-BH3UN1

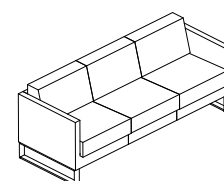

LEY3-BH3UF1

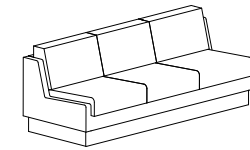

LEY3-BH3UN2

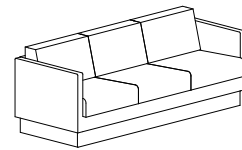

LEY3-BH3UF2

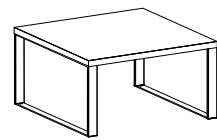

LEY4BH182416  
LEY4BH242416  
LEY4BH302416  
LEY4BH362416  
LEY4BH422416

LEY4BH183016  
LEY4BH243016  
LEY4BH303016  
LEY4BH363016  
LEY4BH423016

### Tate

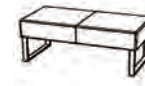

TAT5-2210



TAT5-2260



TAT5-3210



TAT5-3260

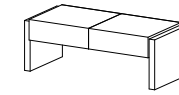

TAT5-2212

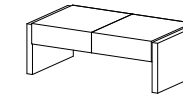

TAT5-2262

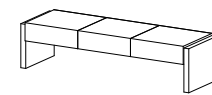

TAT5-3212

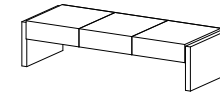

TAT5-3262

### Karma



KAR2-18.5S\_PNAS



KAR2-18.5S\_UNAS



KAR2-18.5S\_WNAS



KAR2-18.5S\_PA\_S



KAR2-18.5S\_UA\_S



KAR2-18.5S\_WA\_S



KAR2-22S\_UNAS



KAR2-22S\_WNAS

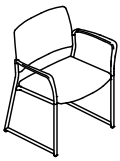

KAR2-22S\_UA\_S



KAR2-22S\_WA\_S

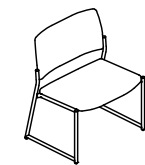

KAR2-26S\_UNAS



KAR2-26S\_WNAS

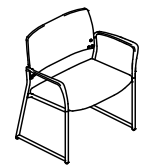

KAR2-26S\_UA\_S

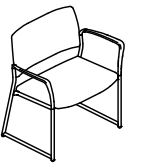

KAR2-26S\_WA\_S

### Chit Chat

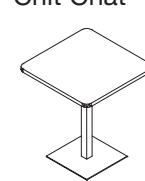

7261242429SQ  
7261303029SQ  
7261363629SQ

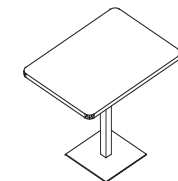

7261233029SQ  
7261243029SQ  
7261463029SQ

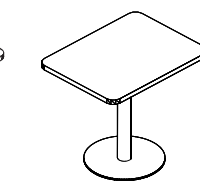

7261233029DB  
7261243029DB  
7261463029DB

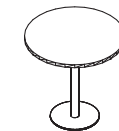

72052429DB  
72053029DB  
72053629DB

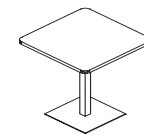

7261242416SQ  
7261303016SQ  
7261363616SQ

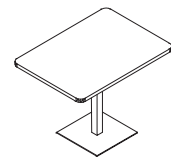

7261233016SQ  
7261243016SQ  
7261463016SQ

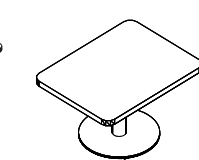

7261233016DB  
7261243016DB  
7261463016DB



72052416DB  
72053016DB  
72053616DB

7261483016SQ  
7261693016SQ  
7261723016SQ

7261483016DB  
7261693016DB  
7261723016DB

Juno Casegoods

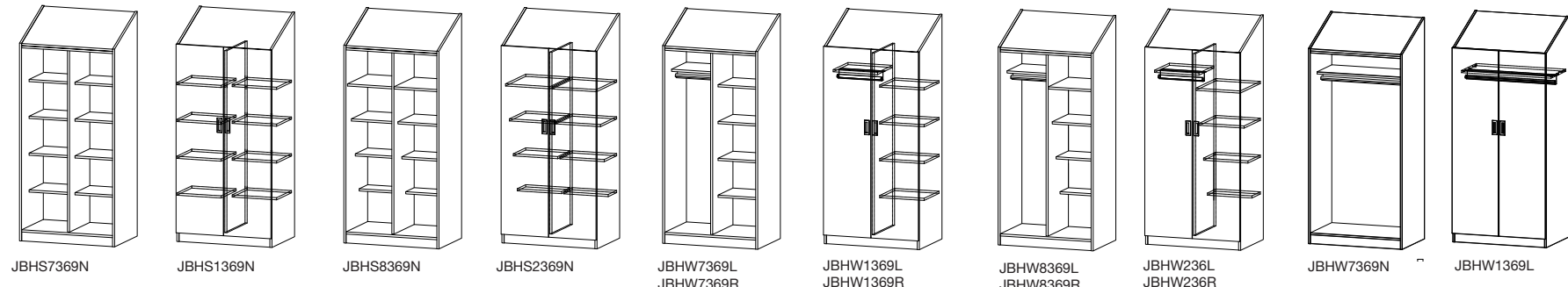
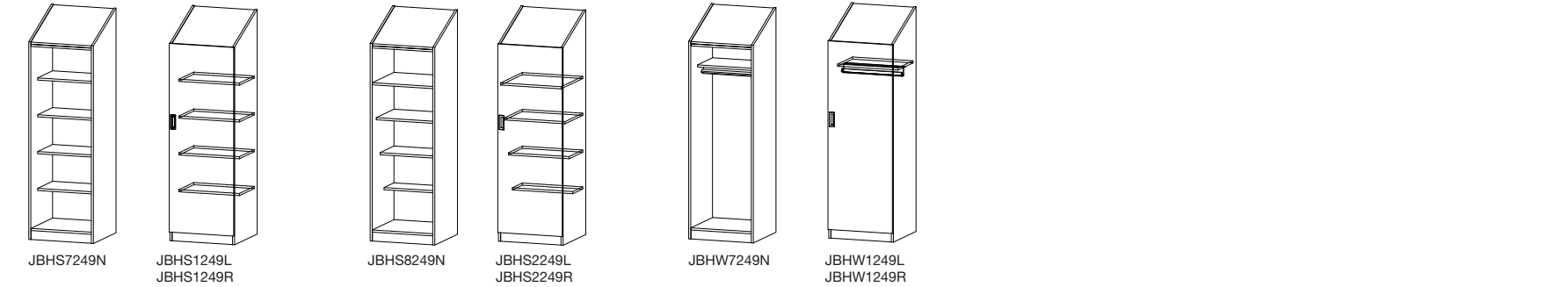
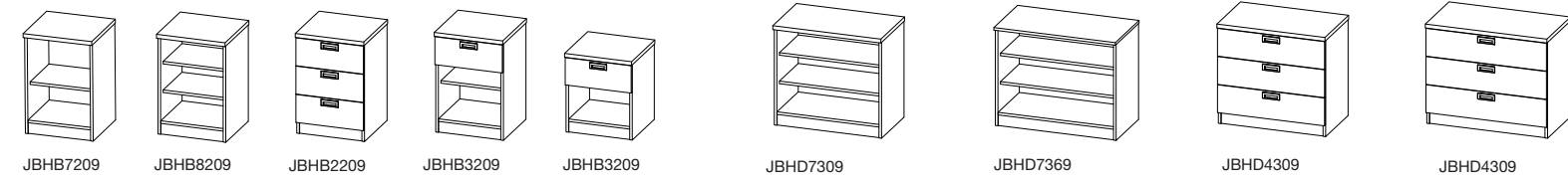

Juno Casegoods

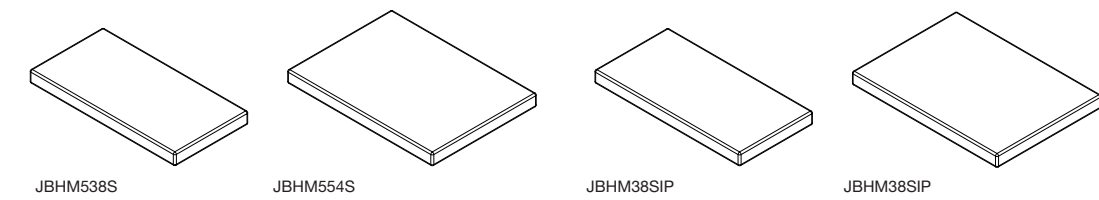
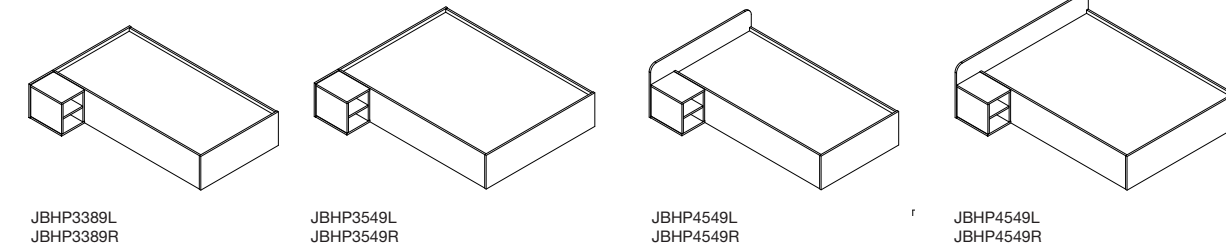
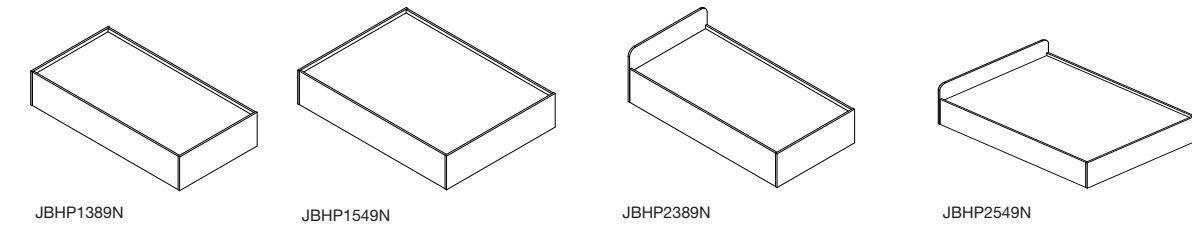



Solis & Zola Behavioral Health



FSC  
www.fsc.org  
FSC® C021699

The mark of responsible forestry



All products are air emissions certified and are available as FSC® certified

**krug** HEALTHCARE 

solutions@krug.ca | www.krug.ca | 1.888.578.KRUG