

Behavioral Health Collection



krug HEALTHCARE 

“We are committed to developing well built, thoughtfully designed furniture solutions that support safe, nurturing, restorative environments, focused on patient care, healing and well-being.”

Len Ruby, President



krug HEALTHCARE 

Krug Behavioral Health

A Complete Solution

Krug, in consultation with senior healthcare designers and clinicians, has developed a series of highly functional, extremely durable, easily cleanable, attractive behavioral healthcare furniture solutions, containing numerous security features including; ligature and elopement resistant designs, soft edges, restricted access points, tamper resistant hardware and supplemental weight for enhanced patient and staff safety. The fulsome offering includes a broad range of options for dayroom, dining, and activity areas as well as intake, consult spaces and patient rooms. Almost all major components are field replaceable, ensuring minimal downtime for repairs and exceptional return on investment.





Zola Behavioral Health

Zola Behavioral Health has been developed through a meticulous and extensive research process. We've consulted with leading healthcare facilities, designers and consultants specializing in behavioral health environments to create a market-leading, durable solution for the protection and safety of patients and care-givers - with an aesthetic appeal that contributes to making behavioral health environments less clinical, adding warmth and a less institutional sensibility. The offering includes lounge seating and coordinating tables which are standard with a multitude of safety features including tamper resistant hardware, staple covers, secure glides and springless seat construction. For additional safety, seating and tables can be specified with supplemental weight and anchoring brackets.

Faeron Behavioral Health Guest & Patient

We've expanded the award-winning (Nightingale Gold Award) Faeron Metal collection to include customizable options that make this series an ideal choice for Behavioral Health environments. Guest and Patient chairs are available in multiple sizes and designed with durable steel frame construction, tamper resistant hardware, staple covers, rounded edges, and are standard with a sled base. Additional options to increase safety include supplemental weight to minimize risk of weaponization and floor anchor brackets. Back height options include mid back or high back and optional kinetic back hardware is also available on any 21" or 24" guest or patient chair. Guest chairs are rated to a minimum of 500 lbs. per chair for all 21" and 24" models and 750 lbs. for 30" and 44" plus size models. Ganged seating is also available in a range of different configurations. Coordinates seamlessly with Faeron Behavioral Health Lounge and Zola Behavioral Health Tables.





Faeron Lounge Behavioral Health

A powerful blend of form and function, Faeron Behavioral Health Lounge combines an attractive residential look with uncompromising safety features including anti-ligature design, soft edges, supplemental weight, tamper resistant hardware and staple covers, restricted access points and anti-ligature features for the safety and security of patients and staff. Additional safety features are available, such as supplemental weight, under-seat shields and anchoring hardware. Faeron Behavioral Health Lounge is a superior choice for dayrooms, activity areas, intake spaces and lobbies. The offering coordinates seamlessly with Faeron Behavioral Health guest and patient seating as well as Zola Behavioral Health tables. Weight ratings range from 500 lbs.-1200 lbs





Faeron & Zola Behavioral Health

Leyton

Behavioral Health

Leyton Behavioral Health exemplifies sophisticated elegance while offering a multitude of standard features for enhanced patient and staff safety. Leyton's minimalist silhouette belies its heavy-duty robust construction which make it an ideal choice for intense environments. Standard safety features include tamper resistant hardware, staple covers, secured glides and restricted access points. The contemporary sled base design can be bolted to the floor with optional anchor brackets and supplemental weight and a steel under-seat shield can be optioned to further increase staff and patient safety. The offering includes lounge chairs, loveseats, sofas and tables. Weight ratings for Leyton Behavioral Health range from 750 lbs-1200 lbs.









Tate Benches Behavioral Health



Tate features an elegant design and sophisticated lines. Built with safety features such as tamper resistant hardware and staple covers, Tate is an ideal choice for patient corridor seating, lobbies and common areas. Supplemental weight is optional, as are anchor brackets to affix the sled base design to the floor. Tate weight ratings range from 975 lbs. - 1,200 lbs.



Karma

An exceptional choice for any area where a lighter weight chair is needed. Designed with a steel frame, sled base, tamper resistant hardware and staple covers for patient and staff safety. The integrated steel rail spans between the front and rear legs which are fitted with non-removable black nylon glides. Available with or without arms and with fully upholstered or wood backs. Supplemental weight is an additional option. Karma chairs are available in multiple sizes, 18.5", 22" and 26" and each is rated to 500 lbs.

Chit Chat Tables

Laminate or Solid Surface Tops are available in a range of sizes and shapes with steel base design. Safety features include soft edges, tamper resistant hardware and optional floor brackets to anchor base.



Juno Behavioral Health

Designed to perform at the highest level, our safe and attractive Juno Behavioral Health collection includes single and double beds, mattresses, wardrobes, bedside tables and desks for higher-risk patient room spaces. Featuring a durable laminate exterior, available in a vast array of finishes, Juno Behavioral Health is built with a broad range of safety features including double wall construction and restricted access on beds, soft corners on bedside tables and desks, and sloped tops and inset shelves on wardrobes. Additional safety features include restraints for beds and anchor brackets to secure beds, bedside tables, desks and wardrobes to the floor.







FEATURES



TAMPER RESISTANT HARDWARE
All screws used on all the Behavioral Health units have been replaced with tamper resistant security screws.



SECURED GLIDES
Behavioral Health chairs have their glides secured in place to prevent their removal and damage.



INACCESSIBLE STAPLES
All staples on this product are covered and made inaccessible with a secondary barrier, which is fastened with tamper-resistant hardware.



UNDERSEAT SHIELD
A metal underseat shield that minimizes the risk of access to the upholstery staples. It also minimizes the ability to hide contraband under the seat. The vented shield is compatible with ganging brackets and is installed with tamper resistant hardware.



LIGATURE RISK REDUCTION
This product has been designed to minimize the ability to use it for ligature - the closed arm panels, the elimination of legs, and the option of Restricted Access Upholstery significantly reduce the points on the product that could be used for ligature.



RESTRICTED ACCESS UPHOLSTERY
This feature provides complete closure and elimination of the normal gap between upholstered seat, back and arm panels in the seat area of the product - hindering the use of these areas for hiding weapons and contraband. This option further reduces the ability to utilize the product for ligature.



PLUS UPGRADE
The offering includes a standard plus-size 1-seater model, as well as the option to specify plus weight rating for all other models in the offering - this provides a weight rating that exceeds 750 lbs, and includes additional seat support and an additional back leg on the 2- and 3-seat models only.



TABLES
A range of occasional tables designed specifically for behavioral health environments is included in this product offering, with a similar range of features and options to provide safety and security to patients and care-givers.

OPTIONS



SUPPLEMENTAL WEIGHT
For additional safety and to minimize risk of weaponization.



FLOOR ANCHOR BRACKETS
Floor mounting brackets are supplied to be secured to the bottom of the sled base with tamper resistant security screws. (The hardware to attach the brackets to the floor is not provided by Krug.)



SLED BASE
This option minimizes the risk of the chair being weaponized. Optional anchor brackets are available to bolt the base to the floor for additional security.



SPRINGLESS SEATS
The springs in the seats can be replaced with an optional plywood seat pan and dual density foam.

STATEMENT OF LINE

Zola Lounge

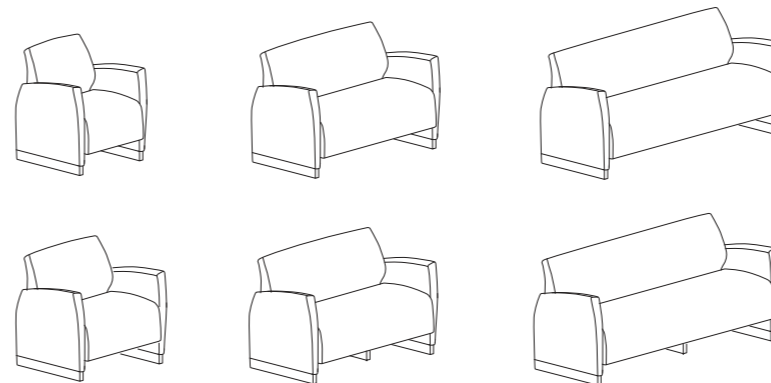

Zola Tables

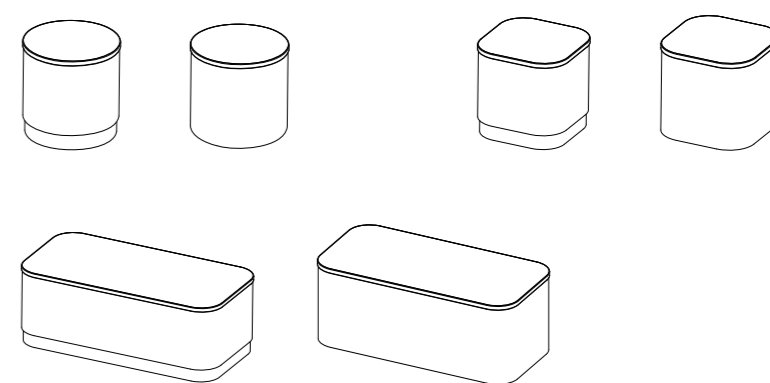



POLYMER ARM
 Faeron Metal Behavioral Health guest and patient chairs are standard with tamper resistant polymer arms that are durable, comfortable, and long lasting. Available in Black, Grey and Taupe.



CLEAN OUT
 A clean-out space between the seat and back makes for easier cleaning and maintenance.



FLEX BACK
 The ergonomically-designed back has a slight flexing action, which significantly enhances comfort.



WALL SAVER
 The angle of the back and the rear legs are designed to keep the back away from the wall, to prevent wear and damage to both the chairs and to the walls of the facility.



SOLID SURFACE ARM
 Optional Solid Surface Arms provide a fully seamless, durable, easy to clean armrest. Available in 8 standard Corian colors and replaceable as a full side frame.



SECURED WOODEN ARM
 Wood Arm caps are fastened to the side frames with tamper resistant security screws. Wood arms are available in solid beech hardwood and in 22 Krug standard finishes.



KINETIC BACK
 This optional feature a very pleasant and comfortable rocking motion, which can significantly enhance long-term sitting for patients and guests. The durable spring-loaded back mechanism provides a range of motion of 20 degrees, and can be field-installed or replaced



COMBINATION UPHOLSTERY
 Combination upholstery option includes more than one upholstery cover within the same unit. Back, seat, or arm panels can be specified in a different fabric selection.

STATEMENT OF LINE

Faeron Guest

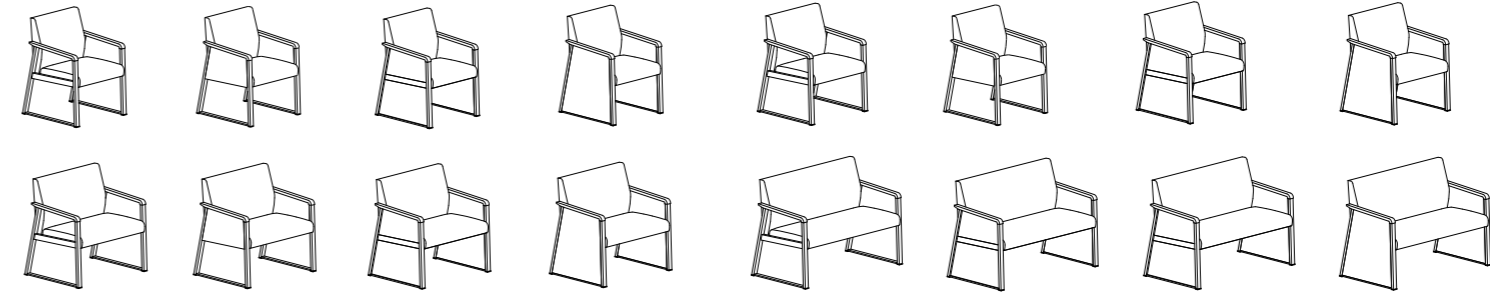

Faeron Patient

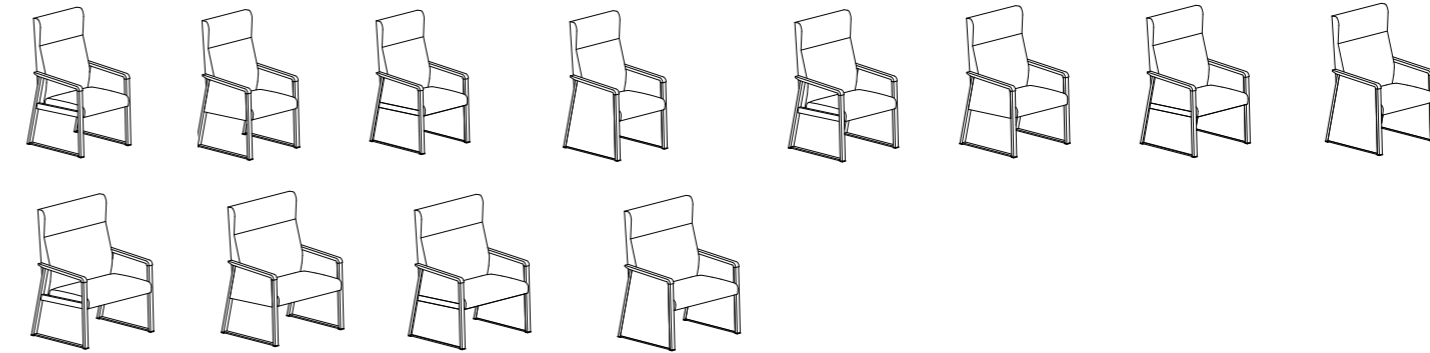

Faeron Multiple Seating (also available in Patient back)

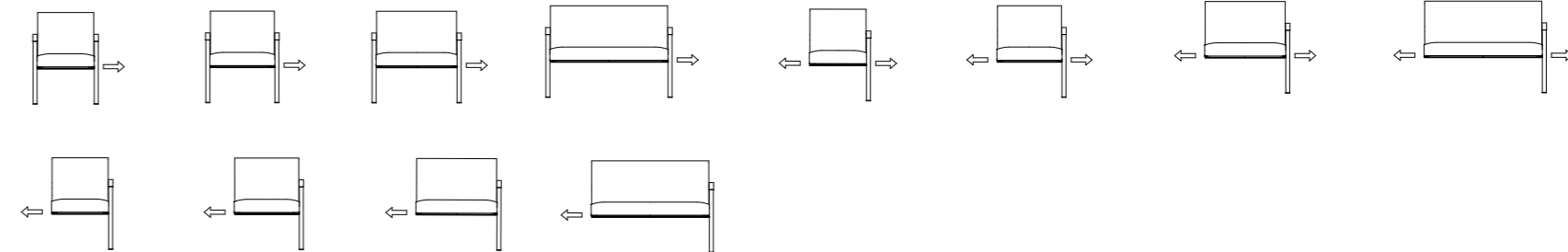

Faeron Lounge

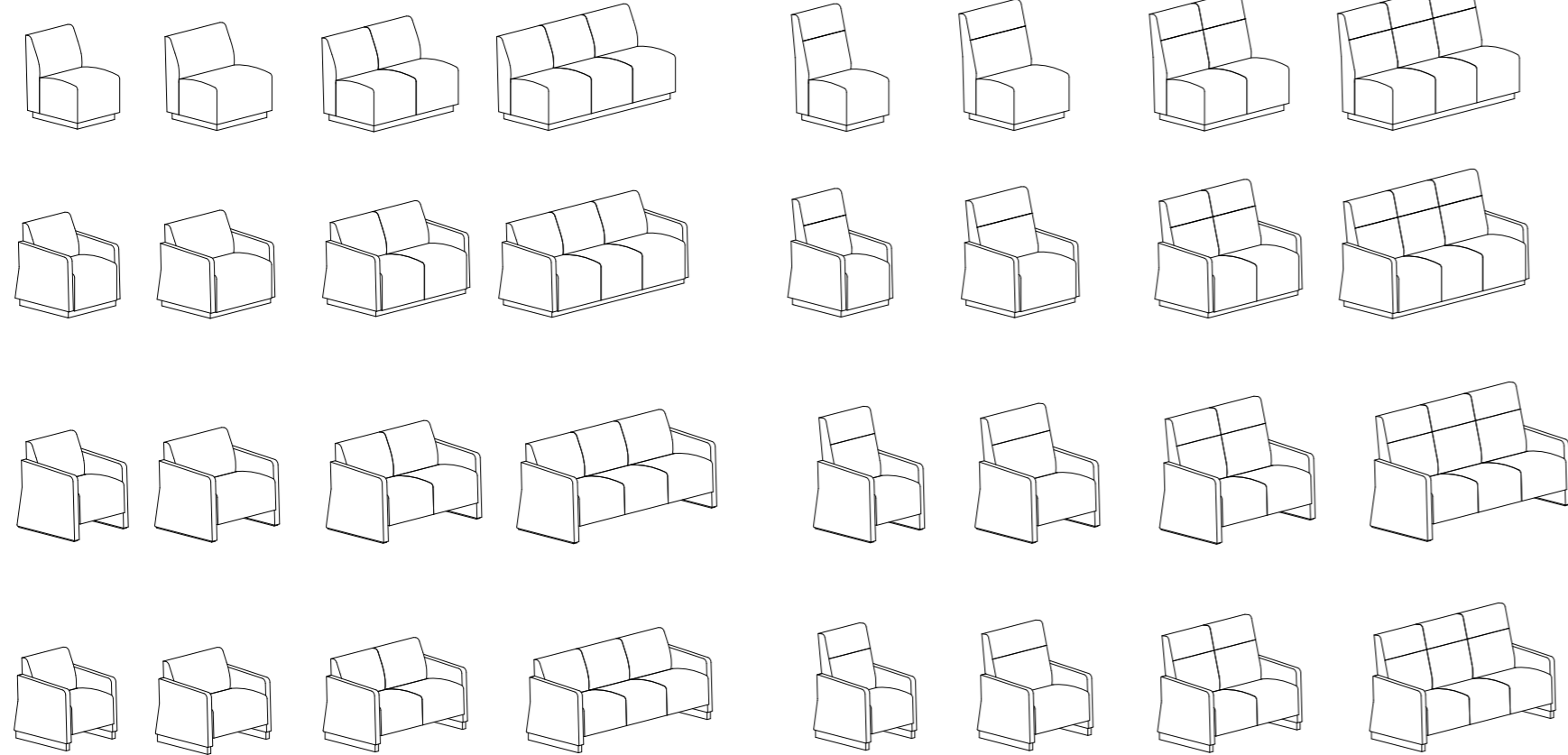

RESTRICTED ACCESS UPHOLSTERY

This model has been designed to minimize the ability to use it for ligature - the closed arm panels, the elimination of legs, and the option of Restricted Access Upholstery significantly reduce the points on the product that could be used for ligature.

POLYMER PLINTH BASE

Leyton Behavioral Health lounge seating is also available with an Grey polymer plinth base that restricts access to the interior of the chair and dirt and debris from accumulating under the chair.

FLOOR ANCHORING

This can be provided when the product is ordered, or can be added in the field. The fastening hardware attaching the steel floor anchoring brackets to the product is tamper-resistant.

TABLES

A range of occasional tables designed with sled base for behavioral health environments is included in this product offering, with a similar range of features to provide safety and security to patients and care-givers.

STATEMENT OF LINE

Leyton Lounge

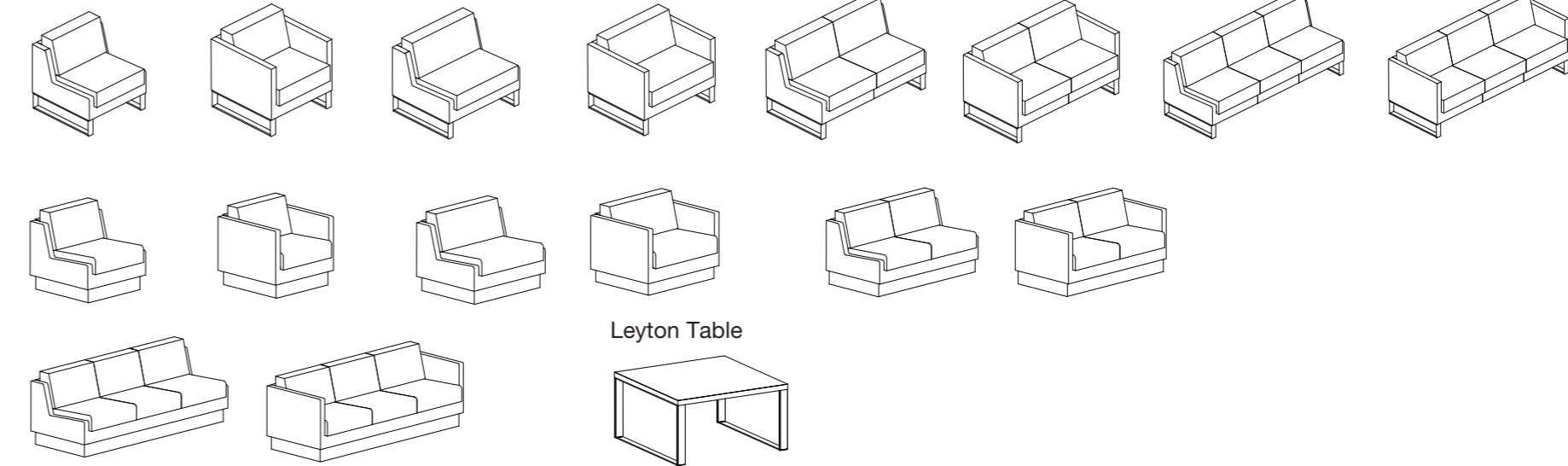



LIGATURE RISK REDUCTION, FULL GABLE END

This model has been designed to minimize the ability to use it for ligature - the elimination of legs with the closed end, significantly reduce the points on the product that could be used for ligature.



LEGS

Tate Bench legs feature polished chrome structural steel legs with non-marring glides. Legs are field replaceable.



BOTTOM SHIELD

This hinders access to the interior frame and components. The bottom shield has venting to allow circulation (venting holes are small enough to hinder use for concealment or ligature), and is fastened with tamper resistant hardware.



FLOOR ANCHORING

This can be provided when the product is ordered, or can be added in the field. The fastening hardware attaching the steel floor anchoring brackets to the product is tamper resistant.

STATEMENT OF LINE

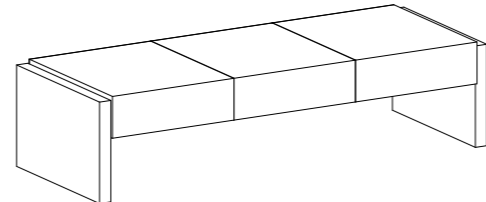
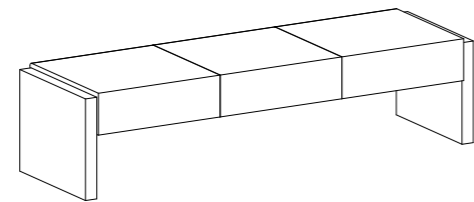
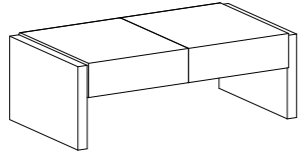
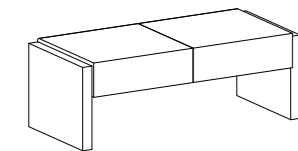
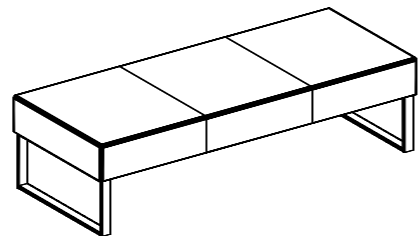
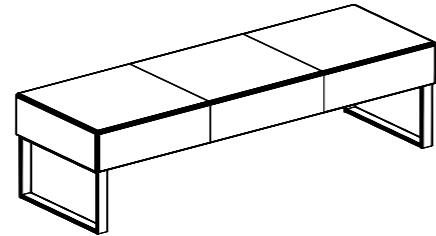
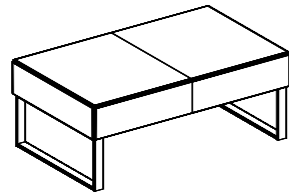
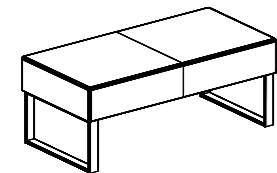

FULLY CLOSED ARM, SLED BASE

The fully closed arm adds a second upholstered arm panel between the middle rail on the side frame and the sleigh base bottom.



SECURED WOODEN ARM

Solis Wood Arm caps are fastened to the side frames with tamper resistant security screws. Wood arms are available in either beech or maple hardwood and in 22 Krug standard finishes.



KINETIC BACK

This optional feature provides a very pleasant and comfortable rocking motion, which can significantly enhance long-term sitting for patients and guests. The durable spring-loaded back mechanism provides a range of motion of 20 degrees, and can be field-installed or replaced.



REPLACEABLE COMPONENTS

Solis chairs are designed to allow components to be field replaced, providing a very cost effective means to significantly extend the life of the product. Seats, backs, arms and frames are field replaceable.

STATEMENT OF LINE

Solis Guest

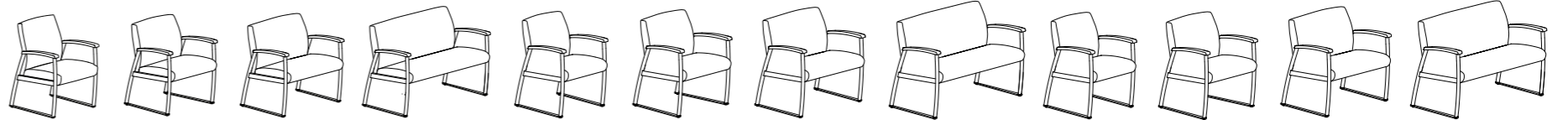

Solis Patient



Solis Multiple Seating (also available in Patient back)

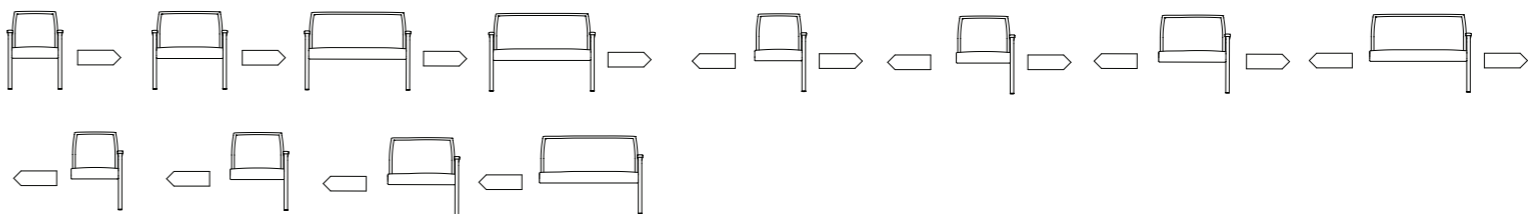

KARMA



NON-ACCESSIBLE STAPLES

The Karma back upholstery has been altered to allow a nylon staple cover strip to be attached; this will prevent access to the upholstery staples. The back cover strip is fastened to the unit with tamper-resistant security screws.

TAMPER RESISTANT ARMS

Polymer arms are equipped with added hardware, internal to the tube frame making them tamper resistant to removal from the tube. Available in four colors; Black, Grey, Light Grey & Taupe.

STATEMENT OF LINE

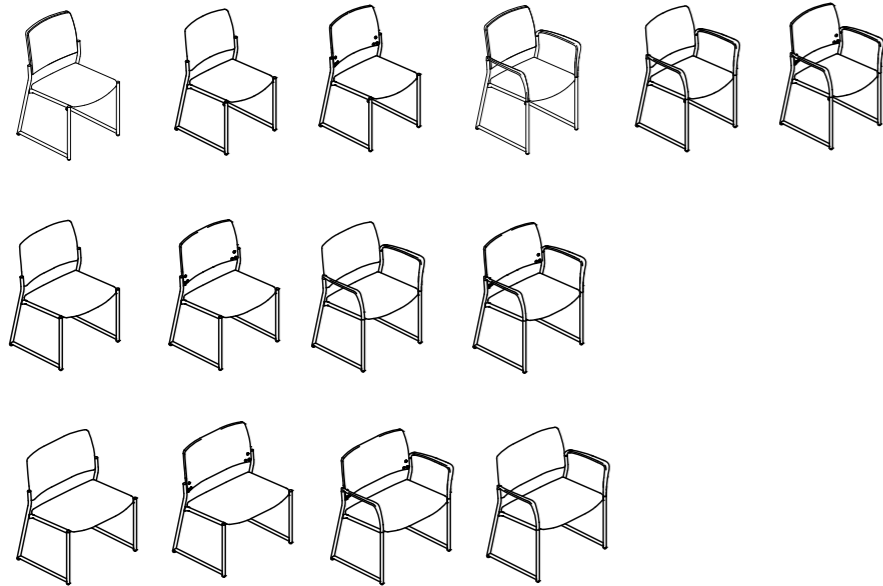

CHIT CHAT



ANCHOR BRACKETS

Heavy duty tamper-resistant anchor brackets are available to secure the chair to the floor.

SUPPLEMENTAL WEIGHT

Additional weighting is achieved through steel plating that is fastened to the under side of the base, making it secure and inaccessible.

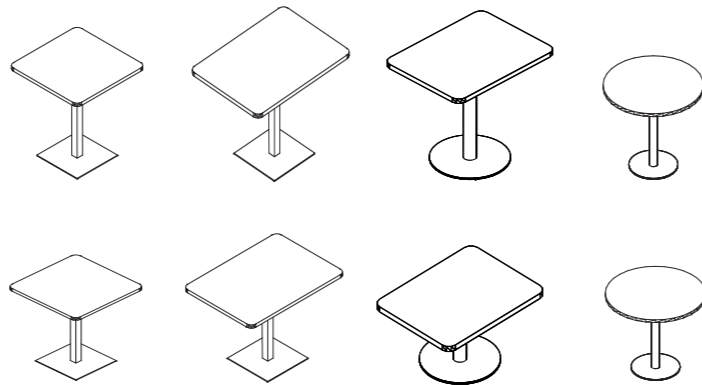

PLATFORM BEDS

Juno Behavioral Health platform beds feature double wall construction and are completely enclosed. Fixed in place, non-pickable caulking is installed around the deck perimeter, minimizing the risk of access to the core and reducing the risk of fluids seeping into the interior.



ANCHOR BRACKETS

Tamper resistant anchor brackets are available to attach casegoods and beds to the floor for additional safety and security.



SHELVES

Shelves on bedside tables, dressers and desks are inset 2", fixed and non-removeable. Shelves on wardrobes are inset 7", fixed and non-removeable. Reverse stair step shelving is also available on wardrobes.



LOWER WARDROBE SHELF

Wardrobes with J-Bars are available with an optional lower shelf that is 12" above finished base panel.



DRAWERS

Drawers feature white metal sides with integrated glides for easy cleaning and disinfection. Drawers are fixed and non-removable. Drawer fronts are 3/4" thick low-pressure laminate with 3mm polymer edge-banding and are installed with tamper resistant hardware.



RESTRAINT BRACKETS

Four stainless steel restraint brackets are installed on both sides of the bed.



TAMPER RESISTANT HARDWARE

All hardware is tamper resistant.



HIGH PRESSURE LAMINATE

Casegoods can be specified in high pressure laminate for an upcharge.

Bedside Tables



Dressers

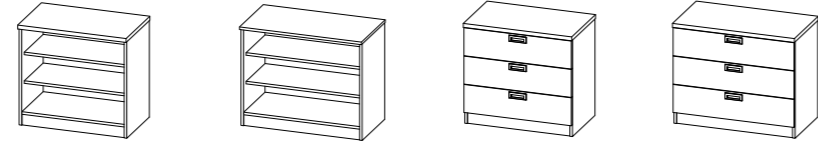

Storage & Wardrobes

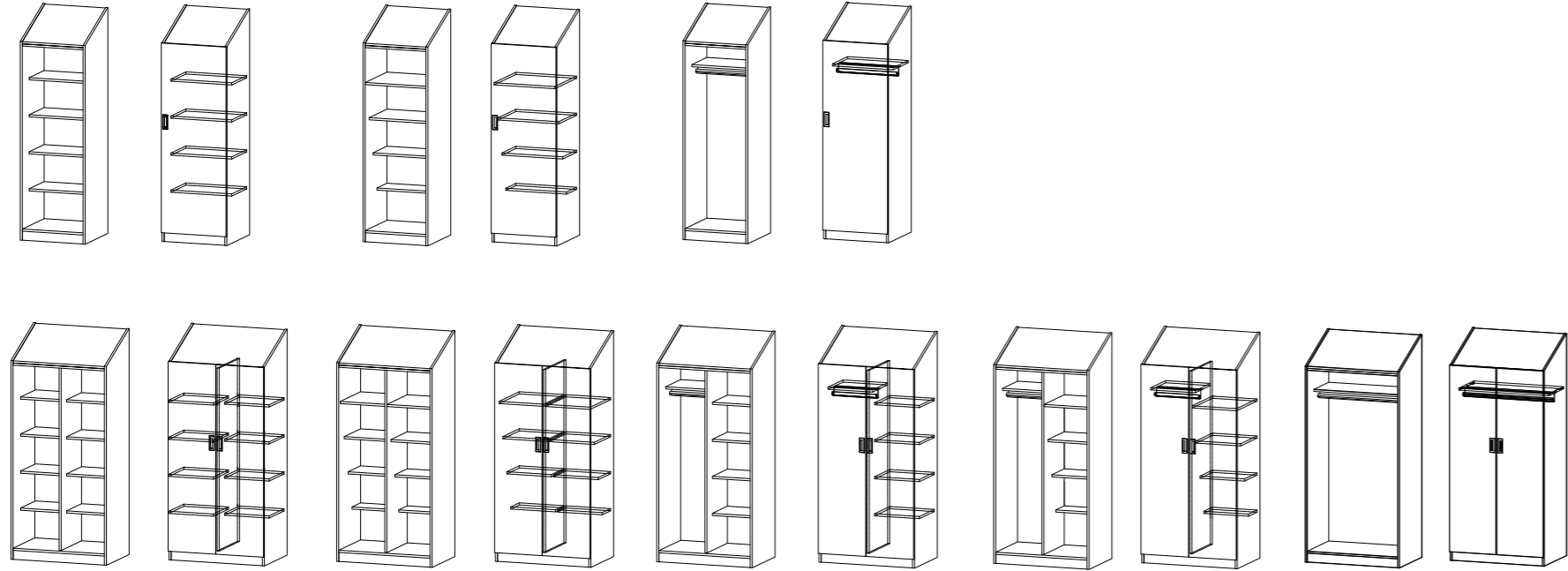

Desks



Platform Beds

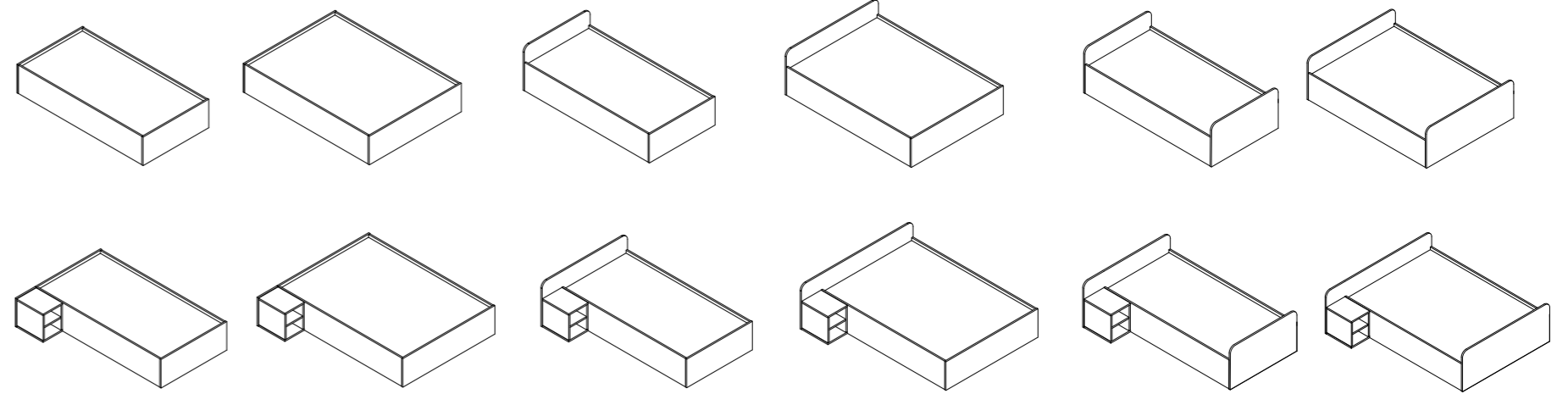

Mattresses

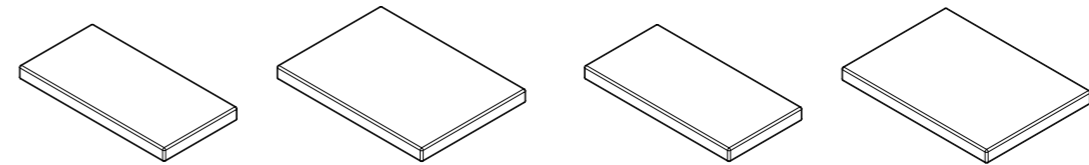



Solis & Zola Behavioral Health



FSC
www.fsc.org
FSC® C021699

The mark of responsible forestry



All products are air emissions certified and are available as FSC® certified

krug HEALTHCARE 

solutions@krug.ca | www.krug.ca | 1.888.578.KRUG