

**CASEGOODS**  
Price and Specification Guide  
**GSA**  
**GS-03F-084DA**



Effective, January 1, 2025

**krug**

Advancing Design Through Innovation

# TERMS & CONDITIONS | INFORMATION FOR ORDERING ACTIVITIES

**General Services Administration  
Federal Supply Schedule**

FSC Groups 7110, 7125  
 Subcategory: Furniture  
 CONTRACT NUMBER: GS-03F-084DA  
 CONTRACT PERIOD: April 1, 2016 through March 31, 2026  
 CONTRACTOR/ ADMINISTRATOR: Mira Jaksic-Husic  
 Krug Inc.  
 421 Manitou Drive  
 Kitchener, Ontario, Canada  
 Tel: 1-800-265-2796  
 Fax: 1-800-265-2798

**1. List of Special Item Numbers on Contract**

- 33721P Packaged Office Furniture w Ancillary Installation Services
- 33721 Office Furniture w Ancillary Installation Services
- 339113H Healthcare Furniture w Ancillary Installation Services
- OLM Order Level Materials

2. SPECIAL ITEM NUMBER	MAXIMUM ORDER
33721P	\$5,000,000
33721	\$250,000
339113H	\$500,000
OLM	\$250,000

3. SPECIAL ITEM NUMBER	MINIMUM ORDER
33721P	\$100.00
33721	\$100.00
339113H	\$100.00
OLM	NA

**4. Geographic Coverage**

48 contiguous States and Washington, DC

**5. Point of Production**

Krug Inc.  
 421 Manitou Drive  
 Kitchener, Ontario, CANADA  
 N2C 15L

**6. Discount from List Prices**

- 33721P Package Office Furniture Krug Product Discounts As Below  
 GSA Teaming Partner Products at their  
 Approved GSA Discount Terms. Krug  
 Installation Charge 12.75% of Net Order  
 (Max.). No Charge for Project Mgt Services.
- |  |                                   |
|--|-----------------------------------|
| 33721 Office Furniture                   |                                   |
| Executive Office Furniture               | 56.6%                             |
| Executive Conference Furniture           | 56.6%                             |
| Tables and Accessories                   | 56.6%                             |
| Fully Upholstered Lounge Furniture       | 56.6%                             |
| Multiple Seating                         | 56.6%                             |
| Multi-Purpose Seating                    | 56.6%                             |
| Stacking Chairs                          | 56.6%                             |
| Installation Ancillary to these products | 12.75% Charge of Net Order (Max.) |
- 
- |  |                                   |
|--|-----------------------------------|
| 339113H Healthcare Furniture               |                                   |
| Hospital Patient Room Furniture            | 56.6%                             |
| Hospital Geriatric Chairs & Lounge Seating | 56.6%                             |
| Patient Service Systems                    | 56.6%                             |
| Installation Ancillary to these products   | 12.75% Charge of Net Order (Max.) |

**7. Quantity Discounts (off Net pricing)**

Multiple Seating, Multipurpose Seating, Stacking  
 Chairs

25,001 – 50,000	1%
50,001 – 100,000	2%
100,001 – 150,000	3%
150,001 – 250,000	4%

Lounge Seating, Tables & Accessories

25,000 – 50,000	1%
50,001 – 75,000	2%
75,001 – 100,000	3%
100,001 – 180,000	4%
180,001 – 200,000	5%
200,001 – 250,000	6%

Hosp/Geriatric Chairs and Lounge, Patient Room  
 Furniture, Patient Service Systems

\$100,000 - \$200,000	1%
\$200,000.01 - \$300,000	1.5%
\$300,000.01 - \$400,000	2%
\$400,000.01 - \$500,000	2.5%

Quantity Discounts for Executive Office and  
 Executive Conference are no longer applicable  
 based on the MAS Consolidation revisions to  
 Maximum Order Limits.

**8. Prompt Payment Terms**

Net 30 Days

**9. Visa and MasterCard** are accepted above and

below the micro-purchase threshold.  
 NOTE: No additional discount will be offered on  
 orders placed using credit cards.

**10. Foreign Items**

All items manufactured in Canada.

**11a. Time of Delivery**

60-90 Days ARO for all items.

**11b. Expedited Delivery**

Please contract Krug GSA Customer Service for  
 information on Expedited Delivery/Krug Express  
 Program. 1-800-265-2796

**11c. Overnight & 2 day Delivery**

N/A

**11d. Urgent Requirements**

Please contact Krug for urgent requirements.

**12. F.O.B. Point**

Destination

**13. Payment Address**

Same as above

# TERMS & CONDITIONS | INFORMATION FOR ORDERING ACTIVITIES

## 14. Warranty

For commercial products, Krug warrants the construction and the finish of all our products to be free from defects in materials and workmanship for a period of 10 years from the date of purchase. For Krug Healthcare products (as outlined in the US Healthcare price and specification Guide dated March 1, 2019), Krug warrants the construction and finish of all Healthcare products to be free from defects in materials and workmanship for the lifetime of their use. This warranty is applicable to products in use by their original purchaser. This warranty does not apply to components not manufactured by Krug including textiles, which are subject to the specific warranties of those manufacturers, if any. Textiles (fabric, leather, vinyl, or any other covering material) suppliers do not guarantee their products for durability and color fastness, and nor does Krug.

Casters, mechanical and electrical components have a warranty of five years from the date of purchase. The Krug warranty does not apply to COM-specified materials, damage caused by a carrier other than Krug, or variation in wood finishes due to natural wood color variation. Krug cannot be held responsible for variations in fabric dye lots from order to order. All fabric is carefully inspected when it is received, but a degree of variation in color should be expected. Repairs or replacement of any defect covered under this warranty by Krug will be made, at our option and method, at no charge to the original purchaser during the warranty period. Krug's judgement is final and binding with respect to the nature or cause of defects or damage, and the necessity or manner of repair or replacement.

This warranty does not apply to defects or damage resulting from:

- normal wear and tear occurring with the use of the product
- negligence, misuse, excessive use, alteration, improper cleaning or repair
- substitution or use of incorrect or unauthorized components or material
- handling or installation that is incorrect, or that causes damage or defect
- damage incurred by a freight carrier other than Krug
- wearing of finishes and fabrics, and normal variations in materials (including dye lot variations)
- properties of natural materials, including wood and leather
- exposure to environments with uncontrolled temperature and humidity (products must be transported, stored and used in climate controlled conditions)

Note, specific warranties for components and materials not manufactured by Krug: Height Adjustable Mechanism Warranty Krug warrants to the original consumer purchaser its Height Adjustable Mechanism that it will be free from defects in material and workmanship. This limited warranty covers material and manufacturing defects, which cause a non-conformance in the function of a table base and is limited to the following products and warranty term determined from their dates of purchase: a) Electronic components such as control boxes, hand switches and motors – two (2) years b) Mechanical components such as crank drives, spindles – five (5) years c) Structural components such as J-channels, feet and top supports – ten (10) years. The start of the warranty period is the documented date of your purchase of the product. The warranty herein is made to and for the benefit of the original consumer purchaser of the product and is non-transferable. If you discover a defect in material or workmanship during the warranty period, and Krug agrees that the defect exists, Krug will, at its option, repair or replace the Product at no charge to you, provided it is returned during the warranty period. In the unlikely event that your product should require repair or replacement during the warranty period, please contact Krug to obtain warranty service. The warranty period on replacement products is the remainder of the warranty on the original product or 30 days, whichever is longer.

Jordan Sleepers Heavy-Duty Mechanism, made with heavy gauge steel and minimal moving parts - is backed by a 5-year warranty on the mechanism itself, in addition to the lifetime warranty on the rest of the product. If it does become damaged or degraded, the mechanism can be field-replaced. Juno and Trevisa Overbed Tables have a 2-year warranty.

## 15. Export Packing Charges

Quoted upon request

## 16. Terms and Conditions of Government Commercial Credit Card

ACCEPTANCE: KRUG will accept the government commercial credit card but will not Offer any additional discount for orders placed using the credit card

## 17. Term and Conditions of Rental Maintenance and Repair.

N/A

## 18. Term and Conditions of Installation

N/A

## 19. Term and Conditions of Repair

N/A

## 20a. Term and Conditions for any other services

N/A

## 20. Service and Distribution points

Call contractor

## 21. Participating Dealers

Call contractor

## 22. Preventative Maintenance

N/A

## 23. Environmental Attributes

Krug maintains a program to reduce the impact on the environment of our products and operations.

## 24. Data Universal Number System (DUNS) number

251476669

## 25. Notification regarding registration in SAM.

Krug Inc.'s registration in SAM is current, accurate and valid.

## 26 Cage Code: 37310

# CASEGOODS | TABLE OF CONTENTS

- i GSA Terms & Conditions
- 2 Adesso
- 109 Vestrada
- 244 Millennium
- 323 Artemis
- 444 Artemis Laminate
- 517 Latitude
- 577 Stratford
  
- 624 General Information
- 624 Warranty
- 626 Krug Textiles
- 627 C.O.M. & Laminates Program

**ADESSO | TABLE OF CONTENTS**

3	Environmental Summary
4	Veneers & Finishes
4	Veneer Grain Direction
5	Guidelines and Pricing Methods
5	Edge Profile, Pulls & Lock
6	General Product Specification
7	Connectivity
7	Height Adjustable Worksurface with Base Enclosure
8	Cable Management
9	Credenza Information
9	Linking Unit Information
10	Hutches, Overheads & Tackboard Information
11	Filing Configuration
11	Media Hub Information
12	Sample Configurations
13	Desk Runoffs for Full Height Credenzas
17	Desk Runoffs for 3/4 Height Credenzas
22	Linking Runoff Tops
23	Desks with Extended 3/4 Pedestals
24	Height Adjustable Worksurfaces
32	Open Desks
36	Desks
38	Returns
40	Linking Tops
41	Desk Height Credenzas
46	3/4 Height Credenzas
55	Overheads
59	Wall Mounted Back-Painted Glass
60	Panel Walls
63	Piers
64	Hutches
66	Storage
71	Wardrobes
73	Mobile Pedestals
73	Benches
75	Reception & Administrative Workstations
79	Media Hub
98	Modular Pedestals with Finished Backs
101	Modular Tops & Supports
105	PowerPorts/Data Connections & Cable Management

# ADESSO | ENVIRONMENTAL SUMMARY

## LEED CERTIFICATION



MATERIAL CONTENT:

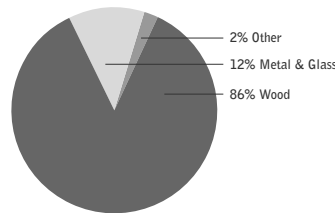

PRE-CONSUMER RECYCLED CONTENT - 81%  
 POST-CONSUMER RECYCLED CONTENT - 3%

		CONTRIBUTES To
Credit 2.1 - 2.2	Construction Waste Management	1-
Credit 4.1	Recycled Content	1 point
Credit 4.2	Recycled Content	1 point
Credit 4.5	Low Emitting Materials, (MUST BE REQUESTED )	
	Composite Wood & Laminate Adhesives	1 point
Credit 5.1	Regional Materials*	1 point
Credit 7	Certified Wood (MUST BE REQUESTED )	1 point

\*This credit is only applicable if in total 20% of the combined value of the procurement of construction materials and in the furniture are manufactured within a radius of 500 miles. This credit will apply if the installation of the finished product occurs within 500 miles of Kitchener, Ontario.

### level® CERTIFICATION



BIFMA's e3 Furniture Sustainability Standard is a voluntary, multi-attribute standard that measures the degree of sustainability of furniture. This standard evaluates product and company environmental attributes and compliance systems in a wide range of elements which include Materials, Energy & Atmosphere, Human & Ecosystem Health and Social Responsibility. Adesso products have earned level®, BIFMA's sustainability certification program for furniture, certification through third-party verification against the e3 standard. All Adesso products can be supplied with level® certification. In order to accomplish this, the product must also be ordered with the air-emissions-certification option. Contact customer service for information and upcharges.

### AIR-EMISSIONS

All Adesso products can be supplied with air-emissions-certified materials. Contact customer service for information and upcharges.



FSC®  
 www.fsc.org  
 FSC® C021699

the mark of responsible forest

### FSC®

FSC® In 2005, Krug received Forest Stewardship Council® (FSC®) Chain-of-Custody certification for our manufacturing facilities. The FSC® Chain-of-Custody tracks certified wood from seedling to final sale. It verifies that the material for our FSC® certified products only come from well-managed, FSC®-certified forests and other controlled sources. FSC® is dedicated to the promotion of responsible forest management worldwide helping to take care of forests for future generations. Adesso and other Krug products can be specified with FSC® Certification. Contact customer service for further information, pricing and lead times.

In addition, architects, designers, and building professionals can specify FSC®-certified products in order to achieve a point from the US. Green Building Council's Leadership in Energy and Environmental Design (LEED) Rating System.



**WOOD FINISHES**

Standard wood finishes are:

SPECIES	FINISH
<b>OAK</b>	Light Oak SilverGrey on Oak Espresso Oak Harvest Oak Mahogany Oak Medium Cherry on Oak Mellow Oak Walnut on Oak
<b>CHERRY</b>	American Cherry Appalachian Cherry Light Cherry Sable Cherry
<b>MAPLE</b>	Clear Maple Wheat Maple
<b>WALNUT</b>	Natural Walnut SilverGrey on Walnut Regular Walnut Dark Walnut Cordovan Walnut
<b>ANIGRE</b>	Clear Anigre Medium Anigre

**PALETTE FINISHES**

- Black
- White
- Sand
- Soft Green
- Steel Blue
- Slate

**WOOD FINISHES TO MATCH STANDARD LAMINATES**

- Willow on Rift Oak
- Dune on Rift Oak
- Portobello on Rift Oak
- Ash on Rift Oak
- Copper on Cherry
- Shiraz Cherry
- Park Avenue Walnut
- Chocolate on Walnut
- Nutmeg on Walnut
- Dark Walnut
- Hardrock Maple

**VENEERS**

Adesso veneers are quarter cut, except for White Oak, which is rift cut - both quarter cut and rift cut veneers provide a straight grain appearance. The grain direction of the veneers on vertical faces is horizontal.

**NON-STANDARD VENEER SPECIES**

In addition to range of standard wood species, Adesso can be made with virtually any commercially available veneers. To specify Sycamore, Mozambique or Zebrano add 5% List to Walnut list price. Mozambique, Zebrano & Sycamore are available in clear finish only. Other veneers are also available on Adesso, please contact customer service for more information and pricing on additional wood species not included in Adesso's standard offering.

**NATURAL CHARACTERISTICS OF WOOD**

Wood is a natural product with inherent color variations that will never be fully mitigated by the finishing process. Please anticipate variation in colors within a single unit, from piece to piece, and from Krug wood finish samples. If a very close match is required, a sample must be provided with the order and an upcharge will apply. Exact color matches are not possible.

**CUSTOM WOOD FINISHES**

Add 10% list to your order for special finishes, minimum upcharge is \$600 list per finish per order. (For example, on all orders up to \$6000 list, an upcharge of \$600 will apply, on orders \$6000 and up add 10% list to your order.)

For orders with special finishes, a sample that is a minimum 3" by 3" must be received with the order. Special finishes may add an additional lead time to production schedules. Since wood is a natural product, some variations in grain, color and stain acceptance will occur. In our finishing processes, we try to minimize variations, but some variation between samples and finished goods should be anticipated.

**FINISH**

Adesso Casegoods feature Krug's finish, a proprietary catalyzed varnish formulation, that has repeatedly shown through independent laboratory testing to be the industry leader in durability and abrasion resistance. The Krug finish looks better longer than competitors and is uniquely suited to the demands of high traffic environments.

**ADESSO | VENEER GRAIN DIRECTION**

Adesso grain direction runs left to right on all cases. Providing a consistent wood grain direction is important in maintaining consistent color on adjacent worksurface. The arrows on the illustrations below show the grain direction on typical worksurfaces and case fronts.

Desks

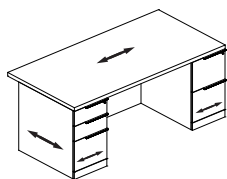

Credenza

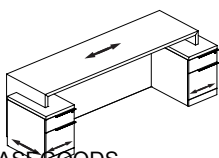

Curvilinear Desks

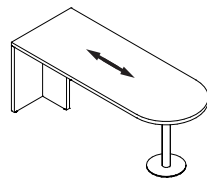

Returns & Linking Units

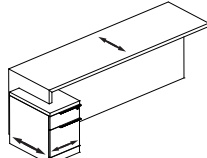

Rectangular Runoffs

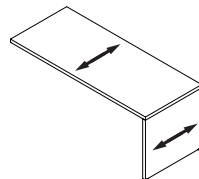

Hutches and Overheads

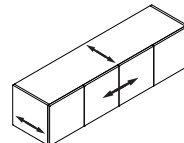

Curvilinear Runoffs

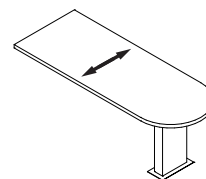

Storage

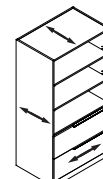

Drawer and Door Fronts

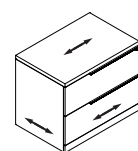

# ADESSO | GUIDELINES AND PRICING METHODS

## PRICING METHODS

Custom widths: Apply the price that is one standard size larger than the desired case size (but same depth).

Example: The required custom dimension is 74" x 30". The first standard size above this is 78" x 30", so in this case you would apply the price of the 78" x 30" unit.

Custom depths: Apply the price of the same unit one size deeper (but same width).

Example: The required custom dimension is 72" x 26". The first standard size above this is 72" x 30", so in this case you would apply the price of the 72" x 30" unit.

Custom width & depth: Apply the price of the same unit both one size wider and one size deeper.

Example: The required custom dimension is 74" x 26". The first standard size above this is 84" x 30", so in this case you would apply the price of the 84" x 30" unit.

## OTHER PRICING METHODS

Custom height of desk height cases: Add 18% (31-32" hi)

Grommets in non-standard positions, **add: \$152 list**

To remove hutch or overhead doors, deduct: 4% list

Bookcase with optional vent in back (includes 2 vents and 1 grommet), **add: \$302 list**

2 lateral files and 3 or 4 closed shelves - convert to half open, half closed shelves, add: 15% list

2 lateral files and 3 or 4 closed shelves - convert to half open, half wardrobe, add: 15% list

To remove storage doors for open shelves, deduct: 4% list

## EXCEPTIONS TO THE PRICING METHODS ABOVE

Sizes larger than largest shown in Price List.

Glass door – any style.

Cases with curvilinear tops where the radius becomes non-standard.

Please contact Krug Customer Service at 1.888.578.KRUG if you require assistance.

PLEASE NOTE: Cases with non-standard features do not apply to the rules above.

Contact Krug Customer Service if you require assistance.

# ADESSO | EDGE PROFILE & PULLS

## ADESSO EDGE PROFILE

Desks, Credenzas, Curvilinear Desks, Returns, Linking Units, Bookcases have profiles on all edges



## ADESSO PULL STYLE

Pulls are available in Clear Satin Anodized Aluminum. Adesso pulls are located on the top right corner of each drawer front and cover 2/3rds of the drawer front. Pulls on storage doors are placed in the top corner opposite the door hinges. Pulls are not available on storage doors above the worksurface. These cases will feature a touch latch operation.





# ADESSO | GENERAL PRODUCT SPECIFICATIONS

## WORK SURFACES

Tops are 1 1/2" thick veneered particle board & MDF core with face and back veneer.

## MODESTY PANELS

Modesty panels are standard on all desks, and optional on shaped tops, returns, linking units and credenzas. Modesty panels are 3/4" thick, with the exception of linking unit modesty panels which are 1 1/8" thick.

## VENEER

Adesso veneers are quarter cut, except for White Oak, which is rift cut - both quarter cut and rift cut veneers provide a straight grain appearance. The grain direction of the veneers on vertical faces is horizontal.

## FINISH

A five step catalyzed varnish finish that when dry has a sheen value of 32°, is applied to all finished cases. A lower sheen topcoat, 20°, can also be specified at standard pricing. All purchase orders must clearly note "lower sheen finish" in order to receive the optional selection.

## LOCKS

Locks are provided as standard features on all pedestals, except bookcase pedestals, including those in desks, credenzas, and lateral file storage units. Satin Aluminum lock plugs are located on the fronts of all cases.

Locks are available on the bookcase doors at an **upcharge of \$152 list per set** of (2) doors, please specify at time of order. If a hutch or overhead has an uneven amount of doors the single lock required is **also \$152**. Locks for bookcase doors are generally located on the top inside corner of the door front. Locks for hutch and overhead doors are generally located on the lower inside corners. Suites can be keyed alike at no upcharge, please specify on purchase order.

## LATCHES

All hutch, overhead and bookcase hinged doors (above the worksurface height), are equipped with touch latches mounted inside the top edge of the door.

## DRAWERS

Desk box drawers have fully progressive full extension slides and are load rated at 100 lbs. per drawer.

Desk file drawers have a load bearing capacity of 130 lbs per drawer.

All other pedestal file drawers have fully progressive, full extension slides and are load rated at 100 lbs. per drawer.

All file drawers are equipped for letter and legal filing.

All box and pedestal file drawer slides have an optional soft-closing feature. Lateral file drawers do not have this option.

All drawer interiors are veneer on plywood, constructed with finger dovetail joints.

All box/box/file pedestals in desks are supplied with one molded black pencil tray.

## GLIDES

Adjustable glides are 1 1/4" long and allow for a range of adjustment of 1". Glide inserts are installed at factory, glides need to be field installed.

## METAL LEGS

The metal legs in Adesso have a Brushed Stainless finish.

## HINGES

Hinges on all hutch, overhead and bookcase doors are European style with 110 degree opening. All hinges are fully adjustable.

## PULLS

Pulls are Clear Satin Anodized Aluminum. Pulls are supplied on all drawers, and doors below desk height.

## TESTING INFORMATION

Adesso meets or exceeds the testing requirements of ANSI/BIFMA X5.5-2014 and/or X5.9 - 2012.



## ADESSO | CONNECTIVITY



### POWERPORT

A PowerPort is a unique worksurface mounted module that can be specified to a location that best serves the user's needs. It includes a UL approved electrical, voice and data power bar, containing two 115 - volt electrical simplex outlets which are accessible from the work surface, plus a utility outlet at the end for daisy chaining purposes. 3 data versions are available, please see page 110 for options.



### PORT

A service module having no power bar will serve as a large grommet. A hinged lid easily enables the passage of several cables and devices.

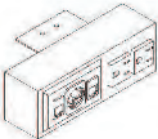

### UNDER MOUNT POWER DATA MODULE

The Power Data Module is mounted under the worksurface to provide connectivity to the user. The unit contains 2 simplex receptacles, 1 RJ11, 1 RJ45 and 1 USB Type A/B port. This power data module can be used for charging with a USB patch cord connected to a transformer. This provides the user a simple and convenient way to charge their electronic devices. Patch cords and transformer are conveniently available at most local electronic stores.



### GROMMETS - Optional (Top Only)

All cases may be specified with one grommet in a standard position at no upcharge. A **\$152 list upcharge** will apply to additional grommets in standard positions and for grommets requested in non-standard positions a **\$152 list upcharge** will apply. The grommet position must be indicated for each case on the order. Please specify location of grommet when ordering.

### Grommets - Round

The round grommet in an aluminum finish with an open and shut mouse hole serves to provide cable passage for areas not requiring a large opening. The grommet position must be indicated for each case on the order. Grommets can be field installed with a power drill, 60 mm hole saw. Please keep in mind the location of the grommets when specifying pier hatches for use with worksurfaces. For example, a paper manager on the left-hand side may be used with a "C", "BR" or "AR" grommet.

## ADESSO | HEIGHT ADJUSTABLE WORKSURFACE WITH BASE ENCLOSURE

### Single Stage Mechanism With Base Enclosure

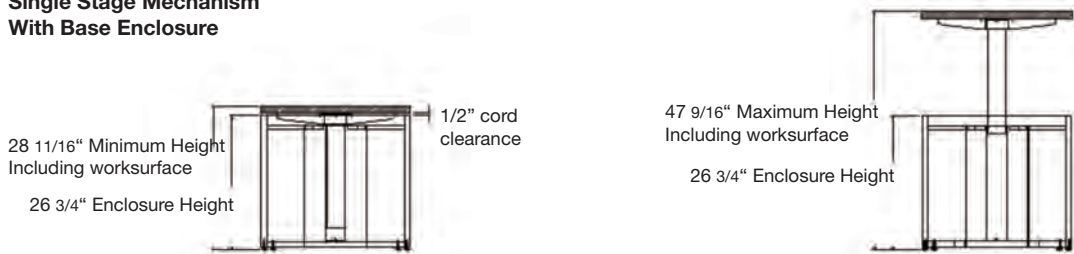

The Single Stage mechanism with Base Enclosure has an adjustable height range of 28 11/16 - 47 9/16 inches. When the worksurface is at the lowest stage - desk height, the space between underside of the worksurface and the top of the Base Enclosure is 1/2 inch.

### Dual Stage Mechanism With Base Enclosure

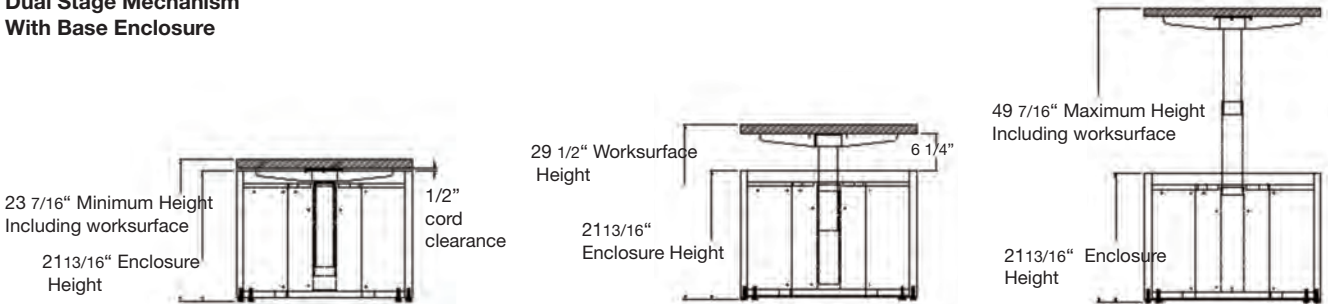

The Dual Stage mechanism with Base Enclosure has an adjustable height range of 23 7/16 - 49 7/16 inches. When the worksurface is at the standard desk height setting of 29 1/2", the space between underside of the worksurface and the top of the Base Enclosure is 6 1/4 inches. This allows for the full range of height adjustments.

Custom Base Enclosures for the Dual Stage are available decreasing the gap below the worksurface to 1/2 inch.

Caution: this eliminates the ability to use the lower stage settings.

Custom Base Enclosures to further lower the minimum worksurface height are also available, removing the inside enclosure floor completely and allowing a minimum desk height of 22 7/16". Contact customer service for a quote.

**STANDARD GROMMET & POWERPORT POSITIONS**

**Desks, Credenzas, Link Units & Returns**

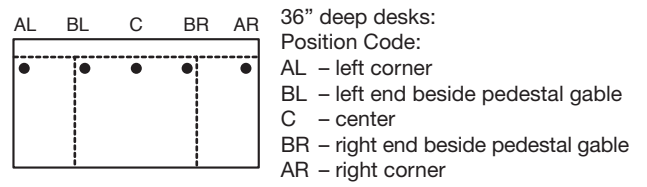
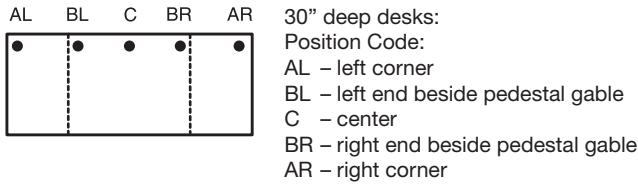

"BR" and "BL" are only available on tops 60" or longer.

**3/4 height Credenzas for Mounted Runoffs with Power/Data Option**

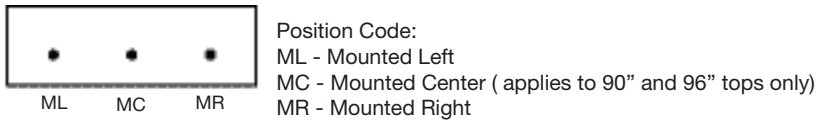

**Rectangular Runoff Top Grommet & PowerPort**

Guest Side

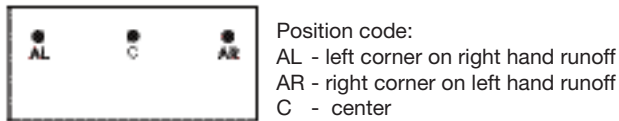

"AL" grommet and PowerPort locations apply to **rectangular runoffs**.

**Curvilinear Runoffs and desks**  
Grommet and PowerPort locations

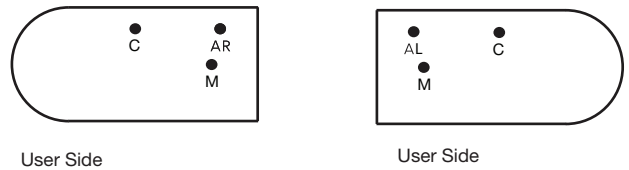

**PEDESTAL ACCESS CABLE MANAGEMENT**



All Adesso casegood desks, returns and credenzas allow for wire management behind the pedestal drawers. Pedestal gables feature a standard cable management opening allowing access to the rear of the pedestal cavity. By specifying a wiring grommet in a standard AL or AR position (see grommet locations above) cable can be conveniently threaded behind the pedestal drawers and through the wire management access grommet.

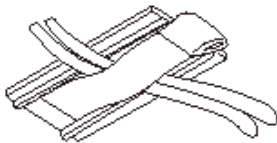

**Velcro Cable Manager**  
A velcro wire management strip is available to assist in containing the cables



**Cable Management PVC Trough**  
PVC Cable manager is used in credenzas, L and U workstations.



**Cable Management for Runoffs**  
The Silver Metallic Trough is used to route cables from desk runoffs to credenza and out to the source.



**Cable Management with Runoff and Wood Base**  
This represents cables running from desk runoffs through the Silver Metallic Trough and into the wood/metal base to a floor monument source.

# ADESSO | CREDENZAS & LINKING UNITS

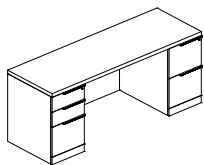

### CREDENZAS - Desk Height

Adecco offers a wide variety of credenzas for use as stand alone storage pieces, part of a connected worksurface configuration, or behind a desk.

Choose from single or double pedestal options, with fixed or hinged modesty panel.

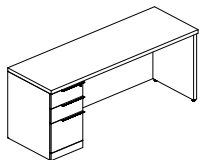

### MODESTY PANELS

Credenzas with hinged modesty panels provide easy access to wall mounted electrical sources without wiring difficulties.

Credenzas with modesty panels have an added finished look, and all cases are available with a wiring grommet in a standard position for added cable management, please specify on your order. Wiring grommets can be specified above the pedestal location.

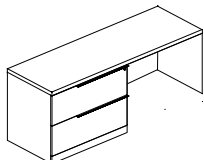

### PEDESTALS

Adecco credenzas are available with single, lateral file, combination pedestals or bookcase pedestals.

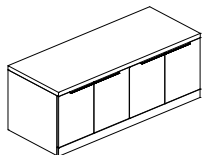

### FULL FACE CREDENZAS

Full face credenzas are available in a variety of lateral file/bookcase & open bookcase combinations in 3/4 and full height cases

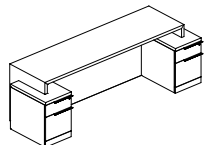

### EXTENDED PEDESTALS CREDENZAS

These are offered in both single & double pedestal options. Pedestals extend 6" beyond the end and front of the case.

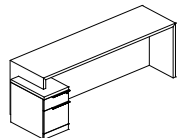

### CREDENZAS - 3/4 HEIGHT

A large offering of Credenza sizes and configurations are available in single pedestal and full face versions.

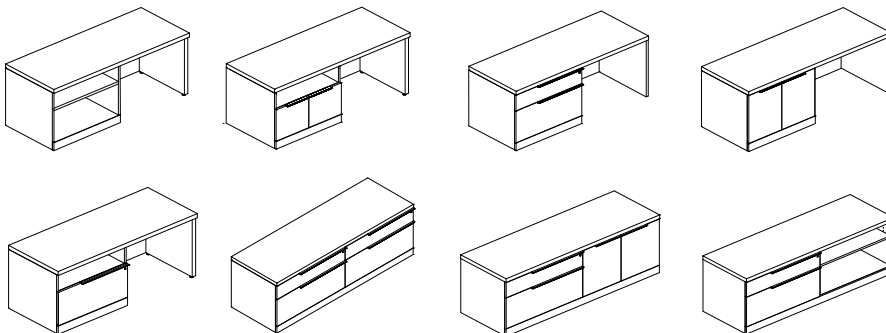

### LINKING UNITS

Adecco linking units are available in a range of sizes for ease of use in configuring a connected worksurface.

Linking Units are for use between desks and credenzas in creating a U-shaped configuration, and must be supported at both ends. They are available with or without modesty panels.

### Linking Units, Tops and Returns

It is important that the main units (desk, credenza) to which the linking unit or return is being attached be in their final position and leveled. Units are connected with mending plates under the worksurface from the modesty to the end panels. Attach the mending plates under the worksurface, ensure cases are level and if necessary adjust the glides to achieve flush and firm joints before completing installation of mending plates to the modesty and end panels.

## ADESSO | HUTCHES, OVERHEADS, TACKBOARDS & WALL UNIT



### Hutches and Overheads

Adesso offers hutch and overhead options for use in a work area configuration. All hutches and overheads include L.E.D. tasklights that are factory installed and require no field adjustment. Tasklights are mounted beneath the cabinet.

A variety of hutches are available with aluminum framed, back-painted white glass doors.

### Doors

Doors are equipped with fully adjustable European style hinges. Locks are optional and can be specified at time of order for an **upcharge of \$152 per set** of (2) doors. If an uneven amount of doors require locks, the lock on the single door is **also \$152**. Locks are not available on glass doors.

### Hutch Power/ Data/ Voice Module

Access to power and data is made simple by using a hutch with a power/data/voice module built right into the tackboard. The module is fully installed at the factory but can be removed to connect data links on site. It features a flip door that retracts into the case of the unit when open.



### Tackboards

All hutches come standard with grade 1 tackboards. For other tackboard grade pricing, see chart on page 70, please note, not all fabrics are suitable for tackboard application. Tackboard fabric selections should be supplied with the order information.

Tackboards are not included with overheads, see page 63 for pricing. Overhead tackboards include wall mounting hardware and instructions.

Only hutches and overhead tackboards in Krug panel fabrics are available on KrugExpress.

### Wall Mounted Back-Painted Glass

Glass panels are 4mm clear finish tempered back-painted glass with aluminum frame. Magnetic backpainted glass is also available. Back-painted glass is available in nine colors; White, Giada, Silk, Mandarino, Rosso, Pearl, Caffè, Black.

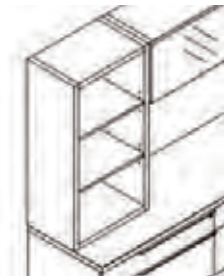

### Piers

Piers are used in conjunction with overhead/hutches, glass wall panels & tackboards

### L.E.D. Tasklights

Tasklights are included with hutches and overheads. On hutches, the tasklight cord is threaded behind the hutch through a standard access grommet on the upper right hand side of the back panel.

Tasklights are installed on the underside of overhead units. Cords run down the right hand side of the tasklight to the worksurface where they can be routed behind the worksurface top. The use of a wall mounted

### Overhead

tackboard, back-painted glass wall panel or wood wall panel conceals the cord from view.

### Installation

Hutch and overhead installation instructions are included with every case. All mounting hardware required is included with the product.



### Sliding door wall units

Sliding door wall units on page 68 of the price guide feature a Coplanar mechanism, meaning - when the doors are closed the faces are flush, when a door is opened it moves forward in front of the other door.

This feature is not available on overheads or hutches.



# ADESSO | FILING CONFIGURATIONS & MEDIA HUB SPECIFICATIONS

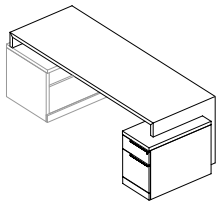

Drawers will be offered for letter and legal size filing. All units are equipped with file bars that are fixed in place for shipping.

## DESK RUNOFFS & DESK PEDESTAL FILE DRAWERS

### Filing Capacity

15" drawers:  
 21" of letter filing front to back or  
 12" of legal filling side to side  
 22" pedestal drawer depths allow only one row of side to side files.

Weight capacity of pedestal file drawers is 100 lbs.

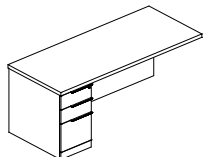

## CREDENZA AND RETURN PEDESTAL FILE DRAWERS

### Filing Capacity

15" drawers:  
 15" of letter filing front to back or  
 12" of legal filling side to side  
 16" pedestal drawer depths allow only one row of side to side files.

Weight capacity of pedestal file drawers is 100 lbs.

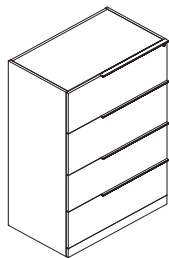

## CREDENZA, RETURN OR STORAGE LATERAL FILE DRAWERS

### Filing Capacity

30" wide drawers:  
 30" letter filing front to back, or  
 25" legal filing side to side  
 15" or legal filing front to back.

When filing front to back, 30" lateral file drawer widths allow two rows of letter filing, but only one row of legal file width.

### Filing capacity

36" wide drawers:  
 30" letter filing front to back, or  
 36" legal filing side to side, or  
 30" legal filing front to back.

Weight capacity of lateral file drawers is 130 lbs.

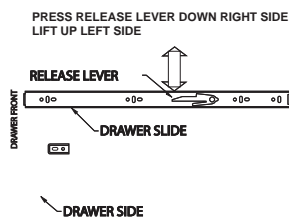

### Drawer Removal

Pull drawer and slide out to the full extension position. With index finger, lift up the release lever on the left and press down the release lever on the right side of the drawer (as shown).

Pull out the drawer with the attached drawer channel from the cabinet member.

To re-assemble, insert the drawer through the guide.

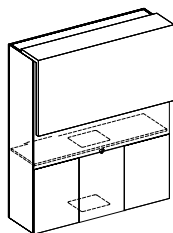

### Media Hub:

Bookcase storage comes with touch latch doors.  
 Wire management cutout in the base of center bookcase is 10-1/4" x 12-3/4".

Optional hangover panel comes standard in any of our palette finishes and can be specified with or without white boards.

Optional runoff tops and bases sold separately and available in both desk and bar heights.  
 Desk height runoff tops are mounted at 29.5" in height.  
 Bar height runoff tops are mounted at 42" in height.

Bank of drawers includes 3 box drawers.  
 Back of unit is finished.

# ADESSO | SAMPLE CONFIGURATIONS

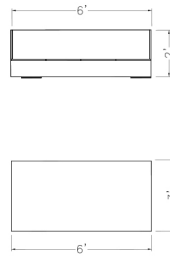
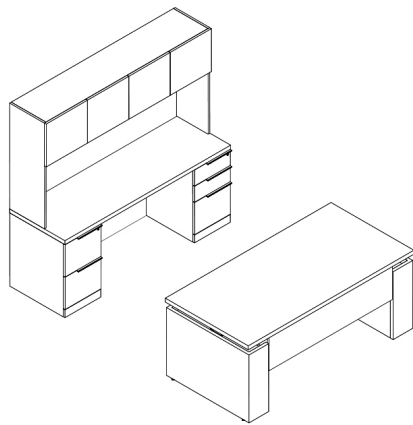

	Model	Cherry Maple Oak	Anigre Walnut
Height Adj. Desk	88HA7236ETSGV21	7840	8623
Hutch	88HT721640	4193	4611
Credenza	88C72244LDRF	4995	5275
<b>TOTAL</b>		<b>17,028</b>	<b>18,509</b>

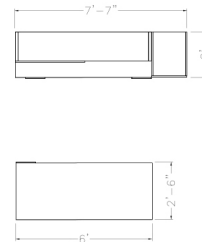
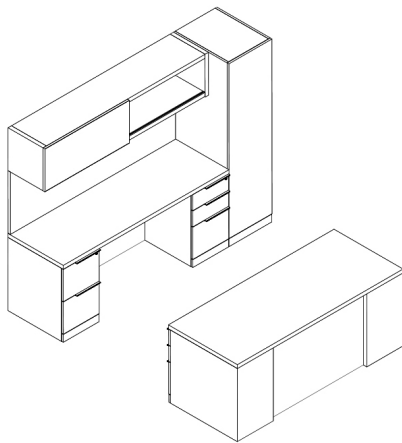

	Model	Cherry Maple Oak	Anigre Walnut
Desk	88D72304LORF	4796	5274
Overhead	88OSW721616Z	3082	3391
Tackboard	88TBOHW7224	521	521
Credenza	88C72244LDRF	4797	5275
Storage	88ST19246911R	3153	3467
<b>TOTAL</b>		<b>16,349</b>	<b>17,928</b>

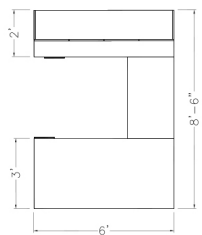
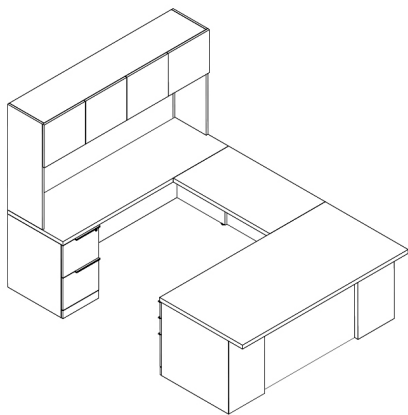

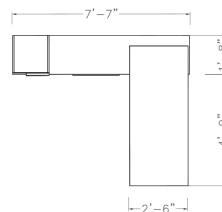
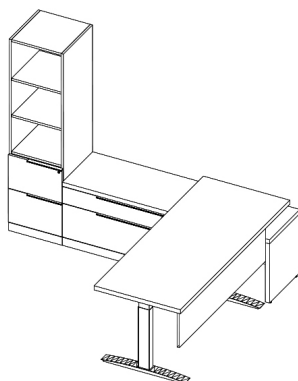

	Model	Cherry Maple Oak	Anigre Walnut
Desk	88D72364LORF	4833	5317
Link Unit	88LU4224HX41	1666	1833
Hutch	88HT721640	4193	4611
Credenza	88C72244LDR0	4337	4772
<b>TOTAL</b>		<b>15,029</b>	<b>16,533</b>



	Model	Cherry Maple Oak	Anigre Walnut
Height Adj. Desk	88HA7230ETSO16V21	4756	5231
Storage	88ST19206990	2620	2882
Credenza	88CY72203L3616R0	4555	5012
<b>TOTAL</b>		<b>11,931</b>	<b>13,125</b>

# ADESSO | DESK RUNOFFS FOR FULL HEIGHT CREDENZAS

Description	Model	Oak		W	D	H	KW	Shipping Weight	Cubic Feet
		Cherry Maple	Anigre Walnut						
 Rectangular Desk Runoff with Aluminum Leg	88DR60304LLG	2636	2899	59.75	30	29.5	57.5	112	6
	88DR60304RLG	2636	2899	59.75	30	29.5	57.5	112	6
	88DR66304LLG	2681	2948	65.75	30	29.5	63.5	121	6.5
	88DR66304RLG	2681	2948	65.75	30	29.5	63.5	121	6.5
	88DR66364LLG	2787	3066	65.75	36	29.5	63.5	140	7.25
	88DR66364RLG	2787	3066	65.75	36	29.5	63.5	140	7.25
	88DR72304LLG	2802	3080	71.5	30	29.5	69	130	6.75
	88DR72304RLG	2802	3080	71.5	30	29.5	69	130	6.75
	88DR72364LLG	2830	3113	71.5	36	29.5	69	151	7.75
	88DR72364RLG*	2830	3113	71.5	36	29.5	69	151	7.75
	88DR78304LLG	2936	3232	77.5	30	29.5	75	139	7.25
	88DR78304RLG	2936	3232	77.5	30	29.5	75	139	7.25
	88DR78364LLG	3057	3363	77.5	36	29.5	75	161	8.5
	88DR78364RLG	3057	3363	77.5	36	29.5	75	161	8.5
	88DR84304LLG	3179	3495	83.5	30	29.5	81	147	7.75
	88DR84304RLG	3179	3495	83.5	30	29.5	81	147	7.75
88DR84364LLG	3327	3662	83.5	36	29.5	81	172	9	
88DR84364RLG	3327	3662	83.5	36	29.5	81	172	9	

 Rectangular Desk Runoffs with Disc Base	88DR60304LDB	2696	2965	59.75	30	29.5	43.5	124	12
	88DR60304RDB	2696	2965	59.75	30	29.5	43.5	124	12
	88DR66304LDB	2802	3080	65.75	30	29.5	49.5	133	12.5
	88DR66304RDB	2802	3080	65.75	30	29.5	49.5	133	12.5
	88DR66364LDB	2952	3246	65.75	36	29.5	46.5	152	13.25
	88DR66364RDB	2952	3246	65.75	36	29.5	46.5	152	13.25
	88DR72304LDB	2966	3265	71.5	30	29.5	55	141	12.75
	88DR72304RDB	2966	3265	71.5	30	29.5	55	141	12.75
	88DR72364LDB	2996	3295	71.5	36	29.5	52	162	13.75
	88DR72364RDB*	2996	3295	71.5	36	29.5	52	162	13.75
	88DR78304LDB	3102	3411	77.5	30	29.5	61	150	13.25
	88DR78304RDB	3102	3411	77.5	30	29.5	61	150	13.25
	88DR78364LDB	3221	3543	77.5	36	29.5	58	173	14.5
	88DR78364RDB	3221	3543	77.5	36	29.5	58	173	14.5
	88DR84304LDB	3388	3727	83.5	30	29.5	67	159	13.75
	88DR84304RDB	3388	3727	83.5	30	29.5	67	159	13.75
88DR84364LDB	3493	3844	83.5	36	29.5	64	183	15	
88DR84364RDB	3493	3844	83.5	36	29.5	64	183	15	

**ORDERING NOTES:**

All desk runoffs are available with three floating modesty panel options: wood, acrylic and back-painted glass. For floating modesty panel upcharges, please see page 40. To order, add the floating modesty panel reference number to the end of the runoff model number.

**ORDERING PROCEDURE**

- To order, please specify the following:
- 1) Krug product model number
  - 2) Wood species and finish
  - 3) Grommet location and style if applicable

\* Indicates model illustrated by line drawing

**CODE DESCRIPTION**

- 4 - over full height credenza
- L - left-handed position
- R - right-handed position
- LG - aluminum legs
- DB - disc base
- V21 - floating wood modesty panel
- V29 - floating acrylic modesty panel
- V24 - floating back-painted glass modesty panel

**STANDARD FINISHES**

For a complete list of standard wood finishes please see page 9. Disc bases and metal legs are available in a Brushed Stainless finish.

**GROMMETS**

One wiring grommet in standard position is optional at no charge. See page 12 for more information.



# ADESSO | DESK RUNOFFS FOR FULL HEIGHT CREDENZAS

Description	Model	Oak		W	D	H	KW	Shipping Weight	Cubic Feet
		Cherry Maple	Anigre Walnut						
 Rectangular Desk Runoffs with Gable Base	88DR60304LGB	3088	3396	59.75	30	29.5	58	120	39
	88DR60304RGB	3088	3396	59.75	30	29.5	58	120	39
	88DR66304LGB	3133	3445	65.75	30	29.5	64	129	43
	88DR66304RGB	3133	3445	65.75	30	29.5	64	129	43
	88DR66364LGB	3238	3562	65.75	36	29.5	64	148	50.5
	88DR66364RGB	3238	3562	65.75	36	29.5	64	148	50.5
	88DR72304LGB	3251	3578	71.5	30	29.5	70	138	46.5
	88DR72304RGB	3251	3578	71.5	30	29.5	70	138	46.5
	88DR72364LGB	3283	3609	71.5	36	29.5	70	159	54.5
	88DR72364RGB*	3283	3609	71.5	36	29.5	70	159	54.5
	88DR78304LGB	3388	3727	77.5	30	29.5	76	147	50
	88DR78304RGB	3388	3727	77.5	30	29.5	76	147	50
	88DR78364LGB	3538	3893	77.5	36	29.5	76	169	59
	88DR78364RGB	3538	3893	77.5	36	29.5	76	169	59
	88DR84304LGB	3630	3993	83.5	30	29.5	82	155	54
	88DR84304RGB	3630	3993	83.5	30	29.5	82	155	54
	88DR84364LGB	3781	4158	83.5	36	29.5	82	180	63.5
	88DR84364RGB	3781	4158	83.5	36	29.5	82	180	63.5

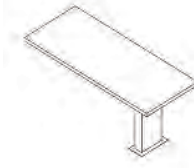
 Rectangular Desk Runoff with Wood/Aluminum Base	88DR60304LWB	3238	3562	59.75	30	29.5	43	127	7.5
	88DR60304RWB	3238	3562	59.75	30	29.5	43	127	7.5
	88DR66304LWB	3283	3609	65.75	30	29.5	49	136	8
	88DR66304RWB	3283	3609	65.75	30	29.5	49	136	8
	88DR66364LWB	3388	3727	65.75	36	29.5	45	155	8.75
	88DR66364RWB	3388	3727	65.75	36	29.5	45	155	8.75
	88DR72304LWB	3403	3742	71.5	30	29.5	55	145	8.25
	88DR72304RWB	3403	3742	71.5	30	29.5	55	145	8.25
	88DR72364LWB	3432	3774	71.5	36	29.5	51	166	9.25
	88DR72364RWB*	3432	3774	71.5	36	29.5	51	166	9.25
	88DR78304LWB	3538	3893	77.5	30	29.5	61	154	8.75
	88DR78304RWB	3538	3893	77.5	30	29.5	61	154	8.75
	88DR78364LWB	3661	4024	77.5	36	29.5	57	176	10
	88DR78364RWB	3661	4024	77.5	36	29.5	57	176	10
	88DR84304LWB	3781	4158	83.5	30	29.5	67	162	9.25
	88DR84304RWB	3781	4158	83.5	30	29.5	67	162	9.25
	88DR84364LWB	3931	4322	83.5	36	29.5	63	187	10.5
	88DR84364RWB	3931	4322	83.5	36	29.5	63	187	10.5

**ORDERING NOTES:**

All desk runoffs are available with three floating modesty panel options: wood, acrylic and back-painted glass. For floating modesty panel upcharges, please see page 40. To order, add the floating modesty panel reference number to the end of the runoff model number.

**DIMENSION KEY**

W — width  
 D — depth  
 H — height of worksurface  
 KW — kneehole width

Dimensions are in inches and approximate. Contact Customer Service if dimensions are critical.

**CODE DESCRIPTION**

4 - over full height credenza  
 L - left-handed position  
 R - right-handed position  
 GB - gable base  
 WB - wood/aluminum base  
 V21 - floating wood modesty panel  
 V29 - floating acrylic modesty panel  
 V24 - floating back-painted glass modesty panel



**STANDARD FINISHES**

For a complete list of standard wood finishes please see page 9. Disc bases and metal legs are available in a Brushed Stainless finish.

**GROMMETS**

One wiring grommet in standard position is optional at no charge. See page 12 for more information.

# ADESSO | DESK RUNOFFS FOR FULL HEIGHT CREDENZA

Description	Model	Oak Cherry Maple	Anigre Walnut	W	D	H	KW	Shipping Weight	Cubic Feet
 Arc Desk Runoffs with Disc Base	88DRA60304LDB	2696	2965	59.75	30	29.5	43.5	124	12
	88DRA60304RDB	2696	2965	59.75	30	29.5	43.5	124	12
	88DRA66304LDB	2802	3080	65.75	30	29.5	49.5	133	12.5
	88DRA66304RDB	2802	3080	65.75	30	29.5	49.5	133	12.5
	88DRA66364LDB	2952	3246	65.75	36	29.5	46.5	152	13.25
	88DRA66364RDB	2952	3246	65.75	36	29.5	46.5	152	13.25
	88DRA72304LDB	2966	3265	71.5	30	29.5	55	141	12.75
	88DRA72304RDB	2966	3265	71.5	30	29.5	55	141	12.75
	88DRA72364LDB	2996	3295	71.5	36	29.5	52	162	13.75
	88DRA72364RDB*	2996	3295	71.5	36	29.5	52	162	13.75
	88DRA78304LDB	3102	3411	77.5	30	29.5	61	150	13.25
	88DRA78304RDB	3102	3411	77.5	30	29.5	61	150	13.25
	88DRA78364LDB	3221	3543	77.5	36	29.5	58	173	14.5
	88DRA78364RDB	3221	3543	77.5	36	29.5	58	173	14.5
	88DRA84304LDB	3388	3727	83.5	30	29.5	67	159	13.75
	88DRA84304RDB	3388	3727	83.5	30	29.5	67	159	13.75
	88DRA84364LDB	3493	3844	83.5	36	29.5	64	183	15
	88DRA84364RDB	3493	3844	83.5	36	29.5	64	183	15
 Arc Desk Runoff with Wood/Aluminum Base	88DRA60304LWB	3238	3562	59.75	30	29.5	43	127	7.5
	88DRA60304RWB	3238	3562	59.75	30	29.5	43	127	7.5
	88DRA66304LWB	3283	3609	65.75	30	29.5	49	136	8
	88DRA66304RWB	3283	3609	65.75	30	29.5	49	136	8
	88DRA66364LWB	3388	3727	65.75	36	29.5	45	155	8.75
	88DRA66364RWB	3388	3727	65.75	36	29.5	45	155	8.75
	88DRA72304LWB	3403	3742	71.5	30	29.5	55	145	8.25
	88DRA72304RWB	3403	3742	71.5	30	29.5	55	145	8.25
	88DRA72364LWB	3432	3774	71.5	36	29.5	51	166	9.25
	88DRA72364RWB*	3432	3774	71.5	36	29.5	51	166	9.25
	88DRA78304LWB	3538	3893	77.5	30	29.5	61	154	8.75
	88DRA78304RWB	3538	3893	77.5	30	29.5	61	154	8.75
	88DRA78364LWB	3661	4024	77.5	36	29.5	57	176	10
	88DRA78364RWB	3661	4024	77.5	36	29.5	57	176	10
	88DRA84304LWB	3781	4158	83.5	30	29.5	67	162	9.25
	88DRA84304RWB	3781	4158	83.5	30	29.5	67	162	9.25
	88DRA84364LWB	3931	4322	83.5	36	29.5	63	187	10.5
	88DRA84364RWB	3931	4322	83.5	36	29.5	63	187	10.5

**ORDERING NOTES:**

All desk runoffs are available with three floating modesty panel options: wood, acrylic and back-painted glass. For floating modesty panel upcharges, please see page 40. To order, add the floating modesty panel reference number to the end of the runoff model number.

**ORDERING PROCEDURE**

- To order, please specify the following:
- 1) Krug product model number
  - 2) Wood species and finish
  - 3) Grommet location and style if applicable.

\* Indicates model illustrated by line drawing

**CODE DESCRIPTION**

- 4 - over full height credenza
- L - left-handed position
- R - right-handed position
- DB - disc base
- WB - wood/aluminum base
- V21 - floating wood modesty panel
- V29 - floating acrylic modesty panel
- V24 - floating back-painted glass modesty panel



**STANDARD FINISHES**

For a complete list of standard wood finishes please see page 9. Disc bases and metal legs are available in a Brushed Stainless finish.

**GROMMETS**

One wiring grommet in standard position is optional at no charge. See page 12 for more information.

# ADESSO | DESK RUNOFFS FOR FULL HEIGHT CREDENZA

Description	Model	Oak	Anigre	W	D	H	KW	Shipping Weight	Cubic Feet	
		Cherry Maple	Walnut							
Bullet Desk Runoff with Disc Base 	88DRB60304LDB	2696	2965	59.75	30	29.5	43.5	124	12	
	88DRB60304RDB	2696	2965	59.75	30	29.5	43.5	124	12	
	88DRB66304LDB	2802	3080	65.75	30	29.5	49.5	133	12.5	
	88DRB66304RDB	2802	3080	65.75	30	29.5	49.5	133	12.5	
	88DRB66364LDB	2952	3246	65.75	36	29.5	46.5	152	13.25	
	88DRB66364RDB	2952	3246	65.75	36	29.5	46.5	152	13.25	
	88DRB72304LDB	2966	3265	71.5	30	29.5	55	141	12.75	
	88DRB72304RDB	2966	3265	71.5	30	29.5	55	141	12.75	
	88DRB72364LDB	2996	3295	71.5	36	29.5	52	162	13.75	
	88DRB72364RDB*	2996	3295	71.5	36	29.5	52	162	13.75	
	88DRB78304LDB	3102	3411	77.5	30	29.5	61	150	13.25	
	88DRB78304RDB	3102	3411	77.5	30	29.5	61	150	13.25	
	88DRB78364LDB	3221	3543	77.5	36	29.5	58	173	14.5	
	88DRB78364RDB	3221	3543	77.5	36	29.5	58	173	14.5	
	88DRB84304LDB	3388	3727	83.5	30	29.5	67	159	13.75	
	88DRB84304RDB	3388	3727	83.5	30	29.5	67	159	13.75	
	88DRB84364LDB	3493	3844	83.5	36	29.5	64	183	15	
	88DRB84364RDB	3493	3844	83.5	36	29.5	64	183	15	
	Bullet Desk Runoff with Wood/Aluminum Base 	88DRB60304LWB	3238	3562	59.75	30	29.5	43	127	7.5
		88DRB60304RWB	3238	3562	59.75	30	29.5	43	127	7.5
88DRB66304LWB		3283	3609	65.75	30	29.5	49	136	8	
88DRB66304RWB		3283	3609	65.75	30	29.5	49	136	8	
88DRB66364LWB		3388	3727	65.75	36	29.5	45	155	8.75	
88DRB66364RWB		3388	3727	65.75	36	29.5	45	155	8.75	
88DRB72304LWB		3403	3742	71.5	30	29.5	55	145	8.25	
88DRB72304RWB		3403	3742	71.5	30	29.5	55	145	8.25	
88DRB72364LWB		3432	3774	71.5	36	29.5	51	166	9.25	
88DRB72364RWB*		3432	3774	71.5	36	29.5	51	166	9.25	
88DRB78304LWB		3538	3893	77.5	30	29.5	61	154	8.75	
88DRB78304RWB		3538	3893	77.5	30	29.5	61	154	8.75	
88DRB78364LWB		3661	4024	77.5	36	29.5	57	176	10	
88DRB78364RWB		3661	4024	77.5	36	29.5	57	176	10	
88DRB84304LWB		3781	4158	83.5	30	29.5	67	162	9.25	
88DRB84304RWB		3781	4158	83.5	30	29.5	67	162	9.25	
88DRB84364LWB		3931	4322	83.5	36	29.5	63	187	10.5	
88DRB84364RWB		3931	4322	83.5	36	29.5	63	187	10.5	

**ORDERING NOTES:**

All desk runoffs are available with three floating modesty panel options: wood, acrylic and back-painted glass. For floating modesty panel upcharges, please see page 40. To order, add the floating modesty panel reference number to the end of the runoff model number.

**DIMENSION KEY**

W — width  
 D — depth  
 H — height of worksurface  
 KW— kneehole width

Dimensions are in inches and approximate. Contact Customer Service if dimensions are critical.

**CODE DESCRIPTION**

4 - over full height credenza  
 L - left-handed position  
 R - right-handed position  
 DB - disc base  
 WB - wood/aluminum base  
 V21 - floating wood modesty panel  
 V29 - floating acrylic modesty panel  
 V24 - floating back-painted glass modesty panel

**STANDARD FINISHES**

For a complete list of standard wood finishes, please see page 9.  
 Disc bases and metal legs are available in an Brushed Stainless finish.

**GROMMETS**

One grommet in a standard position is optional at no charge. See page 12 for more information.

# ADESSO | DESK RUNOFFS FOR 3/4 HEIGHT CREDENZAS

Description	Model	Oak		W	D	H	KW	Shipping Weight	Cubic Feet
		Cherry Maple	Anigre Walnut						
 Rectangular Desk Runoff with Aluminum Legs	88DR60303LLG	2860	3146	59.75	30	29.5	36	120	16
	88DR60303RLG	2860	3146	59.75	30	29.5	36	120	16
	88DR66303LLG	2907	3197	65.75	30	29.5	42	131	17.5
	88DR66303RLG	2907	3197	65.75	30	29.5	42	131	17.5
	88DR66363LLG	3011	3313	65.75	36	29.5	42	151	20
	88DR66363RLG	3011	3313	65.75	36	29.5	42	151	20
	88DR72303LLG	3028	3329	71.5	30	29.5	48	138	18.5
	88DR72303RLG	3028	3329	71.5	30	29.5	48	138	18.5
	88DR72363LLG*	3057	3363	71.5	36	29.5	48	160	21.5
	88DR72363RLG	3057	3363	71.5	36	29.5	48	160	21.5
	88DR78303LLG	3162	3477	77.5	30	29.5	54	147	20
	88DR78303RLG	3162	3477	77.5	30	29.5	54	147	20
	88DR78363LLG	3283	3609	77.5	36	29.5	54	170	23.5
	88DR78363RLG	3283	3609	77.5	36	29.5	54	170	23.5
	88DR84303LLG	3403	3742	83.5	30	29.5	60	155	21.5
	88DR84303RLG	3403	3742	83.5	30	29.5	60	155	21.5
	88DR84363LLG	3554	3909	83.5	36	29.5	60	181	25
	88DR84363RLG	3554	3909	83.5	36	29.5	60	181	25

 Rectangular Desk Runoffs with Disc Base	88DR66303LDB	2921	3214	65.75	30	29.5	27.5	141	23.5
	88DR66303RDB	2921	3214	65.75	30	29.5	27.5	141	23.5
	88DR66363LDB	3028	3329	65.75	36	29.5	24.5	161	26
	88DR66363RDB	3028	3329	65.75	36	29.5	24.5	161	26
	88DR72303LDB	3179	3495	71.5	30	29.5	33	149	24.5
	88DR72303RDB	3179	3495	71.5	30	29.5	33	149	24.5
	88DR72363LDB*	3192	3512	71.5	36	29.5	30	171	27.5
	88DR72363RDB	3192	3512	71.5	36	29.5	30	171	27.5
	88DR78303LDB	3221	3543	77.5	30	29.5	39	158	26
	88DR78303RDB	3221	3543	77.5	30	29.5	39	158	26
	88DR78363LDB	3327	3662	77.5	36	29.5	36	182	29.5
	88DR78363RDB	3327	3662	77.5	36	29.5	36	182	29.5
	88DR84303LDB	3449	3792	83.5	30	29.5	45	167	27.5
	88DR84303RDB	3449	3792	83.5	30	29.5	45	167	27.5
	88DR84363LDB	3613	3975	83.5	36	29.5	42	192	31
	88DR84363RDB	3613	3975	83.5	36	29.5	42	192	31



**ORDERING NOTES:**

All desk runoffs are available with three floating modesty panel options: wood, acrylic and back-painted glass. For floating modesty panel upcharges, please see page 40. To order, add the floating modesty panel reference number to the end of the runoff model number. To replace a standard wood riser with a metal riser for 3/4 height desk runoffs add suffix M to the end of the model # and **\$152 list** to the price e.g. 88DR84363LLGM

**ORDERING PROCEDURE**

- To order, please specify the following:
- 1) Krug product model number
  - 2) Wood species and finish
  - 3) Grommet location and style if applicable.

\* Indicates model illustrated by line drawing

**CODE DESCRIPTION**

- 3 - over 3/4 height credenza
- L - left-handed position
- R - right-handed position
- LG - aluminum legs
- DB - disc base
- V21 - floating wood modesty panel
- V29 - floating acrylic modesty panel
- V24 - floating back-painted glass modesty panel
- M - metal riser

**STANDARD FINISHES**

For a complete list of standard wood finishes please see page 9. Disc bases and metal legs are available in a Brushed Stainless finish.

**GROMMETS**

One wiring grommet in standard position is optional at no charge. See page 12 for more information.

# ADESSO | DESK RUNOFFS FOR 3/4 HEIGHT CREDENZAS

Description	Model	Oak	Anigre	W	D	H	KW	Shipping Weight	Cubic Feet
		Cherry	Walnut						
		Maple							
	88DR60303LGB	3313	3643	59.75	30	29.5	36.4	152	39
	88DR60303RGB	3313	3643	59.75	30	29.5	36.4	152	39
	88DR66303LGB	3357	3693	65.75	30	29.5	42.4	162	43
	88DR66303RGB	3357	3693	65.75	30	29.5	42.4	162	43
	88DR66363LGB	3462	3811	65.75	36	29.5	42.4	188	50.5
	88DR66363RGB	3462	3811	65.75	36	29.5	42.4	188	50.5
	88DR72303LGB	3479	3827	71.5	30	29.5	48.1	171	46.5
	88DR72303RGB	3479	3827	71.5	30	29.5	48.1	171	46.5
	88DR72363LGB*	3509	3859	71.5	36	29.5	48.1	199	54.5
	88DR72363RGB	3509	3859	71.5	36	29.5	48.1	199	54.5
	88DR78303LGB	3613	3975	77.5	30	29.5	54.1	181	50
	88DR78303RGB	3613	3975	77.5	30	29.5	54.1	181	50
	88DR78363LGB	3763	4140	77.5	36	29.5	54.1	210	59
	88DR78363RGB	3763	4140	77.5	36	29.5	54.1	210	59
	88DR84303LGB	3854	4239	83.5	30	29.5	60.1	191	54
	88DR84303RGB	3854	4239	83.5	30	29.5	60.1	191	54
88DR84363LGB	4005	4404	83.5	36	29.5	60.1	222	63.5	
88DR84363RGB	4005	4404	83.5	36	29.5	60.1	222	63.5	

	88DR60303LWB	3432	3774	59.75	30	29.5	21	135	17.5
	88DR60303RWB	3432	3774	59.75	30	29.5	21	135	17.5
	88DR66303LWB	3522	3876	65.75	30	29.5	27	146	19
	88DR66303RWB	3522	3876	65.75	30	29.5	27	146	19
	88DR66363LWB	3630	3993	65.75	36	29.5	24	166	21.5
	88DR66363RWB	3630	3993	65.75	36	29.5	24	166	21.5
	88DR72303LWB	3706	4072	71.5	30	29.5	33	153	20
	88DR72303RWB	3706	4072	71.5	30	29.5	33	153	20
	88DR72363LWB*	3793	4173	71.5	36	29.5	30	175	23
	88DR72363RWB	3793	4173	71.5	36	29.5	30	175	23
	88DR78303LWB	3885	4272	77.5	30	29.5	39	162	21.5
	88DR78303RWB	3885	4272	77.5	30	29.5	39	162	21.5
	88DR78363LWB	3991	4391	77.5	36	29.5	36	185	25
	88DR78363RWB	3991	4391	77.5	36	29.5	36	185	25
	88DR84303LWB	4095	4505	83.5	30	29.5	45	170	23
	88DR84303RWB	4095	4505	83.5	30	29.5	45	170	23
88DR84363LWB	4203	4620	83.5	36	29.5	42	196	26.5	
88DR84363RWB	4203	4620	83.5	36	29.5	42	196	26.5	



**ORDERING NOTES:**

All desk runoffs are available with three floating modesty panel options: wood, acrylic and back-painted glass. For floating modesty panel upcharges, please see page 40. To order, add the floating modesty panel reference number to the end of the runoff model number. To replace a standard wood riser with a metal riser for 3/4 height desk runoffs add suffix M to the end of the model # and **\$152 list** to the price e.g. 88DR84363LLGM

**DIMENSION KEY**

W — width  
 D — depth  
 H — height of worksurface  
 KW— kneehole width

Dimensions are in inches and approximate. Contact Customer Service if dimensions are critical.

**CODE DESCRIPTION**

3 - over 3/4 height credenza  
 L - left-handed position  
 R - right-handed position  
 GB - gable base  
 WB - wood/aluminum base  
 V21 - floating wood modesty panel  
 V29 - floating acrylic modesty panel  
 V24 - floating back-painted glass modesty panel  
 M - metal riser

**STANDARD FINISHES**

For a complete list of standard wood finishes please see page 9. Disc bases and metal legs are available in a Brushed Stainless finish.

**GROMMETS**

One wiring grommet in standard position is optional at no charge. See page 12 for more information.

# ADESSO | DESK RUNOFFS FOR 3/4 HEIGHT CREDENZAS

Description	Model	Oak		W	D	H	KW	Shipping Weight	Cubic Feet	
		Cherry Maple	Anigre Walnut							
	Rectangular Desk Runoff with 3/4	88DRPM60303L3F	3418	3760	36	65.75	29.5	29	257	51
	88DRPM60303R3F	3418	3760	36	65.75	29.5	29	257	51	
	Height Extended Pedestal	88DRPM66303L3F	3522	3876	36	71.75	29.5	35	269	55.5
	88DRPM66303R3F	3522	3876	36	71.75	29.5	35	269	55.5	
	88DRPM66363L3F	3630	3993	42	71.75	29.5	35	308	64	
	88DRPM66363R3F	3630	3993	42	71.75	29.5	35	308	64	
	88DRPM72303L3F	3706	4072	36	77.5	29.5	40.5	281	60	
	88DRPM72303R3F	3706	4072	36	77.5	29.5	40.5	281	60	
	88DRPM72363L3F	3793	4173	42	77.5	29.5	40.5	321	69	
	88DRPM72363R3F*	3793	4173	42	77.5	29.5	40.5	321	69	
	88DRPM78303L3F	3885	4272	36	83.5	29.5	46.5	293	64	
	88DRPM78303R3F	3885	4272	36	83.5	29.5	46.5	293	64	
	88DRPM78363L3F	3991	4391	42	83.5	29.5	46.5	336	74	
	88DRPM78363R3F	3991	4391	42	83.5	29.5	46.5	336	74	
	88DRPM84303L3F	4095	4505	36	89.5	29.5	52.5	305	68.5	
	88DRPM84303R3F	4095	4505	36	89.5	29.5	52.5	305	68.5	
	88DRPM84363L3F	4203	4620	42	89.5	29.5	52.5	350	78.5	
	88DRPM84363R3F	4203	4620	42	89.5	29.5	52.5	350	78.5	

	Single Pedestal Desk Runoff	88DR60303L4F	3915	4308	59.75	30	29.5	29	269	39
	88DR60303R4F	3915	4308	59.75	30	29.5	29	269	39	
	88DR60303L4D	3960	4355	59.75	30	29.5	29	269	39	
	88DR60303R4D	3960	4355	59.75	30	29.5	29	269	39	
	88DR66303L4F	3975	4371	65.75	30	29.5	35	281	43	
	88DR66303R4F	3975	4371	65.75	30	29.5	35	281	43	
	88DR66303L4D	4021	4422	65.75	30	29.5	35	281	43	
	88DR66303R4D	4021	4422	65.75	30	29.5	35	281	43	
	88DR66363L4F	4036	4437	65.75	36	29.5	35	296	50.5	
	88DR66363R4F	4036	4437	65.75	36	29.5	35	296	50.5	
	88DR66363L4D	4081	4488	65.75	36	29.5	35	296	50.5	
	88DR66363R4D	4081	4488	65.75	36	29.5	35	296	50.5	
	88DR72303L4F*	4095	4505	71.5	30	29.5	40.5	293	46.5	
	88DR72303R4F	4095	4505	71.5	30	29.5	40.5	293	46.5	
	88DR72303L4D	4141	4557	71.5	30	29.5	40.5	293	46.5	
	88DR72303R4D	4141	4557	71.5	30	29.5	40.5	293	46.5	

**ORDERING NOTES:**

All desk runoffs are available with three floating modesty panel options: wood, acrylic and back-painted glass. For floating modesty panel upcharges, please see page 40. To order, add the floating modesty panel reference number to the end of the runoff model number. Pedestals are available with a soft-closing drawer option, add "S" to the model # and **\$152 list** per pedestal. e.g. 88DR84363L4FS. To specify an Extended Pedestal in Palette finish, add the suffix "P" to the end of the model number. e.g. 88DRPM72303L3FP. To replace a standard wood riser with a metal riser for 3/4 height desk runoffs add suffix M to the end of the model # and **\$152 list** to the price. e.g. 88DR84363LLGM

**ORDERING PROCEDURE**

- To order, please specify the following:
- 1) Krug product model number
  - 2) Wood species and finish
  - 3) Grommet location and style if applicable.

\* Indicates model illustrated by line drawing

**CODE DESCRIPTION**

- 3 - over 3/4 height credenza
- L - left-handed position
- R - right-handed position
- 3F - 1 box, 1 file drawer
- 4F - box, box, file drawer
- 4D - file, file drawer
- V21 - floating wood modesty panel
- V29 - floating acrylic modesty panel
- V24 - floating back-painted glass modesty panel
- M - metal riser

**STANDARD FINISHES**

For a complete list of standard wood finishes please see page 9. Disc bases and metal legs are available in a Brushed Stainless finish.

**GROMMETS**

One wiring grommet in standard position is optional at no charge. See page 12 for more information.

# ADESSO | DESK RUNOFFS FOR 3/4 HEIGHT CREDENZAS

Description	Model	Oak	Anigre	W	D	H	KW	Shipping Weight	Cubic Feet
		Cherry Maple	Walnut						
Single Pedestal Desk Runoff, continued	88DR72363L4F*	4155	4571	71.5	36	29.5	40.5	333	54.5
	88DR72363R4F	4155	4571	71.5	36	29.5	40.5	333	54.5
	88DR72363L4D	4203	4620	71.5	36	29.5	40.5	333	54.5
	88DR72363R4D	4203	4620	71.5	36	29.5	40.5	333	54.5
	88DR78303L4F	4215	4637	77.75	30	29.5	46.5	305	50
	88DR78303R4F	4215	4637	77.75	30	29.5	46.5	305	50
	88DR78303L4D	4261	4686	77.75	30	29.5	46.5	305	50
	88DR78303R4D	4261	4686	77.75	30	29.5	46.5	305	50
	88DR78363L4F	4277	4705	77.75	36	29.5	46.5	348	59
	88DR78363R4F	4277	4705	77.75	36	29.5	46.5	348	59
	88DR78363L4D	4321	4754	77.75	36	29.5	46.5	348	59
	88DR78363R4D	4321	4754	77.75	36	29.5	46.5	348	59
	88DR84303L4F	4336	4769	83.5	30	29.5	52.5	317	61
	88DR84303R4F	4336	4769	83.5	30	29.5	52.5	317	61
	88DR84303L4D	4381	4819	83.5	30	29.5	52.5	317	61
	88DR84303R4D	4381	4819	83.5	30	29.5	52.5	317	61
	88DR84363L4F	4396	4837	83.5	36	29.5	52.5	362	63.5
	88DR84363R4F	4396	4837	83.5	36	29.5	52.5	362	63.5
88DR84363L4D	4442	4887	83.5	36	29.5	52.5	362	63.5	
88DR84363R4D	4442	4887	83.5	36	29.5	52.5	362	63.5	

Description	Model	Oak	Anigre	W	D	H	KW	Shipping Weight	Cubic Feet
		Cherry Maple	Walnut						
Arc Desk Runoffs with Disc Base	88DRA66303LDB	2921	3214	65.75	30	29.5	27.5	141	23.5
	88DRA66303RDB	2921	3214	65.75	30	29.5	27.5	141	23.5
	88DRA66363LDB	3028	3329	65.75	36	29.5	24.5	161	26
	88DRA66363RDB	3028	3329	65.75	36	29.5	24.5	161	26
	88DRA72303LDB	3179	3495	71.5	30	29.5	33	149	24.5
	88DRA72303RDB	3179	3495	71.5	30	29.5	33	149	24.5
	88DRA72363LDB*	3192	3512	71.5	36	29.5	30	171	27.5
	88DRA72363RDB	3192	3512	71.5	36	29.5	30	171	27.5
	88DRA78303LDB	3221	3543	77.75	30	29.5	39	158	26
	88DRA78303RDB	3221	3543	77.75	30	29.5	39	158	26
	88DRA78363LDB	3327	3662	77.75	36	29.5	36	182	29.5
	88DRA78363RDB	3327	3662	77.75	36	29.5	36	182	29.5
	88DRA84303LDB	3449	3792	83.5	30	29.5	45	167	27.5
	88DRA84303RDB	3449	3792	83.5	30	29.5	45	167	27.5
	88DRA84363LDB	3613	3975	83.5	36	29.5	42	192	31
	88DRA84363RDB	3613	3975	83.5	36	29.5	42	192	31

**ORDERING NOTES:**

All desk runoffs are available with three floating modesty panel options: wood, acrylic and back-painted glass. For floating modesty panel upcharges, please see page 40. To order, add the floating modesty panel reference number to the end of the runoff model number. Pedestals are available with a soft-closing drawer option, add "S" to the model # and **\$152 list** per pedestal. e.g. 88DR84363L4F**S**. To replace a standard wood riser with a metal riser for 3/4 height desk runoffs add suffix M to the end of the model # and **\$152 list** to the price. e.g. 88DR84363LL**GM**

**DIMENSION KEY**

W — width  
 D — depth  
 H — height of worksurface  
 KW — kneehole width

Dimensions are in inches and approximate.  
 Contact Customer Service if dimensions are critical.

**CODE DESCRIPTION**

3 - over 3/4 height credenza  
 L - left-handed position  
 R - right-handed position  
 4 - full height pedestal  
 F - box, box, file drawer  
 D - file, file drawer  
 DB - disc base  
 V21 - floating wood modesty panel  
 V29 - floating acrylic modesty panel  
 V24 - floating back-painted glass modesty panel

**STANDARD FINISHES**

For a complete list of standard wood finishes please see page 9. Disc bases and metal legs are available in a Brushed Stainless finish.

One wiring grommet in standard position is optional at no charge. See page 12 for more information.

# ADESSO | DESK RUNOFFS FOR 3/4 HEIGHT CREDENZAS

Description	Model	Oak		W	D	H	KW	Shipping Weight	Cubic Feet
		Cherry Maple	Anigre Walnut						
 Arc Desk Runoffs with Wood/Aluminum Base	88DRA60303LWB	3462	3811	59.75	30	29.5	36.5	152	39
	88DRA60303RWB	3462	3811	59.75	30	29.5	36.5	152	39
	88DRA66303LWB	3509	3859	65.75	30	29.5	42.5	162	43
	88DRA66303RWB	3509	3859	65.75	30	29.5	42.5	162	43
	88DRA66363LWB	3613	3975	65.75	36	29.5	42.5	188	50.5
	88DRA66363RWB	3613	3975	65.75	36	29.5	42.5	188	50.5
	88DRA72303LWB	3630	3993	71.5	30	29.5	48	171	46.5
	88DRA72303RWB	3630	3993	71.5	30	29.5	48	171	46.5
	88DRA72363LWB*	3661	4024	71.5	36	29.5	48	199	54.5
	88DRA72363RWB	3661	4024	71.5	36	29.5	48	199	54.5
	88DRA78303LWB	3763	4140	77.5	30	29.5	54	181	50
	88DRA78303RWB	3763	4140	77.5	30	29.5	54	181	50
	88DRA78363LWB	3885	4272	77.5	36	29.5	54	210	59
	88DRA78363RWB	3885	4272	77.5	36	29.5	54	210	59
	88DRA84303LWB	4005	4404	83.5	30	29.5	60	191	54
	88DRA84303RWB	4005	4404	83.5	30	29.5	60	191	54
	88DRA84363LWB	4155	4571	83.5	36	29.5	60	222	63.5
	88DRA84363RWB	4155	4571	83.5	36	29.5	60	222	63.5

 Bullet Desk Runoffs with Disc Base	88DRB66303LDB	2921	3214	65.75	30	29.5	27.5	141	23.5
	88DRB66303RDB	2921	3214	65.75	30	29.5	27.5	141	23.5
	88DRB66363LDB	3028	3329	65.75	36	29.5	24.5	161	26
	88DRB66363RDB	3028	3329	65.75	36	29.5	24.5	161	26
	88DRB72303LDB	3179	3495	71.5	30	29.5	33.5	149	24.5
	88DRB72303RDB	3179	3495	71.5	30	29.5	33.5	149	24.5
	88DRB72363LDB*	3192	3512	71.5	36	29.5	30	171	27.5
	88DRB72363RDB	3192	3512	71.5	36	29.5	30	171	27.5
	88DRB78303LDB	3221	3543	77.5	30	29.5	39	158	26
	88DRB78303RDB	3221	3543	77.5	30	29.5	39	158	26
	88DRB78363LDB	3327	3662	77.5	36	29.5	36	182	29.5
	88DRB78363RDB	3327	3662	77.5	36	29.5	36	182	29.5
	88DRB84303LDB	3449	3792	83.5	30	29.5	45	167	27.5
	88DRB84303RDB	3449	3792	83.5	30	29.5	45	167	27.5
	88DRB84363LDB	3613	3975	83.5	36	29.5	42	192	31
	88DRB84363RDB	3613	3975	83.5	36	29.5	42	192	31



**ORDERING NOTES:**

All desk runoffs are available with three floating modesty panel options: wood, acrylic and back-painted glass. For floating modesty panel upcharges, please see page 40. To order, add the floating modesty panel reference number to the end of the runoff model number. To replace a standard wood riser with a metal riser for 3/4 height desk runoffs add suffix M to the end of the model # and **\$152 list** to the price. e.g. 88DR84363LLGM

**ORDERING PROCEDURE**

- To order, please specify the following:
- 1) Krug product model number
  - 2) Wood species and finish
  - 3) Grommet location and style if applicable.

\* Indicates model illustrated by line drawing

**CODE DESCRIPTION**

- 3 - over 3/4 height credenza
- L - left-handed position
- R - right-handed position
- WB - wood/aluminum base
- DB - disc base
- V21- floating wood modesty panel
- V29- floating acrylic modesty panel
- V24- floating back-painted glass modesty panel

**STANDARD FINISHES**

For a complete list of standard wood finishes please see page 9. Disc bases and metal legs are available in a Brushed Stainless fin-ish.

**GROMMETS**

One wiring grommet in standard position is optional at no charge. See page 12 for more information.





# ADESSO | DESK RUNOFFS FOR 3/4 HEIGHT CREDENZAS & LINKING RUNOFF TOPS

Description	Model	Oak	Anigre	W	D	H	KW	Shipping Weight	Cubic Feet
		Cherry Maple	Walnut						
 Bullet Desk Runoffs with Wood/Aluminum Base	88DRB60303LWB	3462	3811	59.75	30	29.5	36.5	152	39
	88DRB60303RWB	3462	3811	59.75	30	29.5	36.5	152	39
	88DRB66303LWB	3509	3859	65.75	30	29.5	42.5	162	43
	88DRB66303RWB	3509	3859	65.75	30	29.5	42.5	162	43
	88DRB66363LWB	3613	3975	65.75	36	29.5	42.5	188	50.5
	88DRB66363RWB	3613	3975	65.75	36	29.5	42.5	188	50.5
	88DRB72303LWB	3630	3993	71.5	30	29.5	48	171	46.5
	88DRB72303RWB	3630	3993	71.5	30	29.5	48	171	46.5
	88DRB72363LWB*	3661	4024	71.5	36	29.5	48	199	54.5
	88DRB72363RWB	3661	4024	71.5	36	29.5	48	199	54.5
	88DRB78303LWB	3763	4140	77.5	30	29.5	54	181	50
	88DRB78303RWB	3763	4140	77.5	30	29.5	54	181	50
	88DRB78363LWB	3885	4272	77.5	36	29.5	54	210	59
	88DRB78363RWB	3885	4272	77.5	36	29.5	54	210	59
	88DRB84303LWB	4005	4404	83.5	30	29.5	60	191	54
	88DRB84303RWB	4005	4404	83.5	30	29.5	60	191	54
88DRB84363LWB	4155	4571	83.5	36	29.5	60	222	63.5	
88DRB84363RWB	4155	4571	83.5	36	29.5	60	222	63.5	

**ORDERING NOTES:**

All desk runoffs are available with three floating modesty panel options: wood, acrylic and back-painted glass. For floating modesty panel upcharges, please see page 40. To order, add the floating modesty panel reference number to the end of the runoff model number. To replace a standard wood riser with a metal riser for 3/4 height desk runoffs add suffix M to the end of the model # and **\$152 list** to the price. e.g. 88DR84363LLGM

 Linking Runoff Tops	Model	Oak	Anigre	W	D	H	KW	Shipping Weight	Cubic Feet
	88LU6024H3L	1173	1292	56	24	-	36	4	
	88LU6024H3R	1173	1292	56	24	-	36	4	
	88LU6624H3L	1251	1376	62	24	-	42	4.5	
	88LU6624H3R	1251	1376	62	24	-	42	4.5	
	88LU7224H3L	1341	1477	68	24	-	48	5	
88LU7224H3R*	1341	1477	68	24	-	48	5		

 Linking Runoff with Fixed modesty Panel For 20" & 24" deep Credenzas	Model	Oak	Anigre	W	D	H	KW	Shipping Weight	Cubic Feet
	88LU6024H3LX41-20	2470	2716	56	24	29.5	92	6	
	88LU6024H3RX41-20	2470	2716	56	24	29.5	92	6	
	88LU6624H3LX41-20	2590	2849	62	24	29.5	100	6.5	
	88LU6624H3RX41-20	2590	2849	62	24	29.5	100	6.5	
	88LU7224H3LX41-20*	2696	2965	68	24	29.5	108	7	
	88LU7224H3RX41-20	2696	2965	68	24	29.5	108	7	
	88LU6024H3LX41-24	2470	2716	56	24	29.5	92	6	
	88LU6024H3RX41-24	2470	2716	56	24	29.5	92	6	
	88LU6624H3LX41-24	2590	2849	62	24	29.5	100	6.5	
	88LU6624H3RX41-24	2590	2849	62	24	29.5	100	6.5	
	88LU7224H3LX41-24*	2696	2965	68	24	29.5	108	7	
	88LU7224H3RX41-24	2696	2965	68	24	29.5	108	7	

**ORDERING NOTES:**

Half gables are required for additional support on all link runoff tops 60" and greater, please see page 109 for model number and list price. To replace the standard wood riser with a metal riser for 3/4 height desk runoffs add suffix "M" to the end of the model # and **\$152 list** to the price. e.g. 88LU7224H3LM.

**DIMENSION KEY**

- W — width
- D — depth
- H — height of worksurface
- KW — kneehole width

Dimensions are in inches and approximate. Contact Customer Service if dimensions are critical.

**CODE DESCRIPTION**

- 3 - over 3/4 height credenza
- L - left-handed position
- R - right-handed position
- WB - wood/aluminum base
- X41 - full height fixed wood modesty
- V21 - floating wood modesty panel
- V29 - floating acrylic modesty panel
- V24 - back-painted glass modesty panel

**STANDARD FINISHES**

For a complete list of standard wood finishes please see page 9.

**GROMMETS**

One wiring grommet in standard position is optional at no charge. See page 12 for more information.

# ADESSO | DESKS WITH EXTENDED 3/4 PEDESTALS

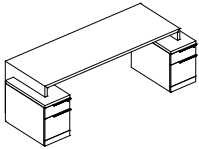
Description	Model	Oak		W	D	H	KW	Shipping Weight	Cubic Feet
		Cherry Maple	Anigre Walnut						
 Rectangular Desk with 3/4 Height Extended Double Pedestals	88DP60303LFRF	7661	8430	71.75	36	29.5	40.5	334	39
	88DP66303LFRF	7703	8474	77.75	36	29.5	46.5	346	43
	88DP66363LFRF	7732	8506	77.75	42	29.5	46.5	365	50.5
	88DP72303LFRF	7770	8548	83.5	36	29.5	52	358	46.5
	88DP72363LFRF*	7816	8595	83.5	42	29.5	52	379	54.5
	88DP78303LFRF	7856	8641	89.5	36	29.5	58	369	50
	88DP78363LFRF	7894	8682	89.5	42	29.5	58	392	59
	88DP84363LFRF	7973	8771	95.5	42	29.5	64	406	63.5

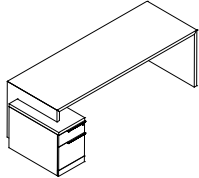
 Rectangular Desk with 3/4 Height Extended Single Pedestal	88DP60303LFR0	5510	6061	65.75	36	29.5	48.5	272	39
	88DP60303LORF	5510	6061	65.75	36	29.5	48.5	272	39
	88DP66303LFR0	5552	6107	71.75	36	29.5	54.5	284	43
	88DP66303LORF	5552	6107	71.75	36	29.5	54.5	284	43
	88DP66363LFR0	5589	6149	71.75	42	29.5	54.5	304	50.5
	88DP66363LORF	5589	6149	71.75	42	29.5	54.5	304	50.5
	88DP72303LFR0*	5632	6192	77.5	36	29.5	60	296	46.5
	88DP72303LORF	5632	6192	77.5	36	29.5	60	296	46.5
	88DP72363LFR0	5671	6240	77.5	42	29.5	60	317	54.5
	88DP72363LORF	5671	6240	77.5	42	29.5	60	317	54.5
	88DP78303LFR0	5730	6304	83.5	36	29.5	66	308	50
	88DP78303LORF	5730	6304	83.5	36	29.5	66	308	50
	88DP78363LFR0	5758	6334	83.5	42	29.5	66	330	59
	88DP78363LORF	5758	6334	83.5	42	29.5	66	330	59
	88DP84363LFR0	5813	6394	89.5	42	29.5	72	344	63.5
88DP84363LORF	5813	6394	89.5	42	29.5	72	344	63.5	

**ORDERING NOTES:**

All desk runoffs are available with three floating modesty panel options: wood, acrylic and back-painted glass. For floating modesty panel upcharges, please see page 40. To order, add the floating modesty panel reference number to the end of the runoff model number. Pedestals are available with a soft-closing drawer option, add "S" to the model # and **\$152 list** per pedestal. e.g. 88DR84363L4FS. To specify an Extended Pedestal in Palette finish, add the suffix "P" to the end of the model number. e.g. 88DRPM72303L3FP. To replace a standard wood riser with a metal riser for 3/4 height desk runoffs add suffix M to the end of the model # and **\$152 list** to the price. e.g. 88DR84363LLGM

**ORDERING PROCEDURE**

- To order, please specify the following:
- 1) Krug product model number
  - 2) Wood species and finish
  - 3) Grommet location and style if applicable.

\* Indicates model illustrated by line drawing

**CODE DESCRIPTION**

- P - Pedestal Mount
- 3 - 3/4 height pedestal
- L - left-handed pedestal position
- R - right-handed pedestal position
- F - 1 box, 1 file drawer
- 0 - no pedestal
- V21 - floating wood modesty panel
- V29 - floating acrylic modesty panel
- V24 - floating back-painted glass modesty panel

**STANDARD FINISHES**

For a complete list of standard wood finishes please see page 9. Disc bases and metal legs are available in a Brushed Stainless finish.

**GROMMETS**

One wiring grommet in standard position is optional at no charge. See page 12 for more information.

# ADESSO | HEIGHT ADJUSTABLE DESK WORKSURFACES

Description	Model	Oak		W	D	H	KW	Shipping Weight	Cubic Feet
		Cherry Maple	Anigre Walnut						
 Electronic Height Adjustable Worksurface	88HA3024ETS	3032	3339	29.75	24	-	17	108.5	11.5
	88HA3624ETS	3142	3457	35.75	24	-	23	109	14
	88HA4224ETS	3255	3580	41.75	24	-	29	109	16.5
	88HA4824ETS	3307	3638	47.75	24	-	35	109.5	19
	88HA5424ETS	3431	3773	53.5	24	-	41	110	21.5
	88HA6024ETS	3495	3846	59.75	24	-	47	111	24
	88HA6624ETS	3831	4215	65.75	24	-	53	114	26.5
	88HA7224ETS	4061	4466	71.75	24	-	59	119.5	29
	88HA7824ETS	4179	4595	77.75	24	-	65	122.5	31.5
	88HA8424ETS	4439	4885	83.75	24	-	71	127	34
	88HA3030ETS	3099	3409	29.75	30	-	17	121.5	36.75
	88HA3630ETS	3408	3746	35.75	30	-	23	122	14.25
	88HA4230ETS	3557	3911	41.75	30	-	29	122	17.5
	88HA4830ETS	3712	4084	47.75	30	-	35	122.5	20.5
	88HA5430ETS	3849	4236	53.5	30	-	41	123	23.5
	88HA6030ETS	4116	4529	59.75	30	-	47	124	26.5
	88HA6630ETS	4265	4692	65.75	30	-	53	131	29.75
	88HA7230ETS	4397	4838	71.75	30	-	59	132.5	32.75
	88HA7830ETS*	4663	5128	77.75	30	-	65	142.5	35.75
	88HA8430ETS	4809	5286	83.75	30	-	71	143.5	38.75
88HA3036ETS	3175	3491	29.75	36	-	17	121.5	42	
88HA3636ETS	3538	3893	35.75	36	-	23	122	45.5	
88HA4236ETS	3819	4203	41.75	36	-	29	122	17.25	
88HA4836ETS	3977	4372	47.75	36	-	35	122.5	20.75	
88HA5436ETS	4245	4669	53.5	36	-	41	123	24.5	
88HA6036ETS	4380	4818	59.75	36	-	47	124	28.25	
88HA6636ETS	4663	5128	65.75	36	-	53	134	32	
88HA7236ETS	4793	5273	71.75	36	-	59	151.5	35.5	
88HA7836ETS	5109	5617	77.75	36	-	65	158.5	39.25	
88HA8436ETS	5203	5721	83.75	36	-	71	159.5	43	

**ORDERING NOTES:**

To order a height adjustable return worksurface in place of a return or linking unit insert RH into the model number before the ETS. e.g. 88HA6024RHETS.

To order a height adjustable worksurface with a top overhang of 16" at one end add O16 to the end of the model number. e.g. 88HA6024ETSO16. Please note that this option is not available on electronic height adjustable worksurfaces that are 42" or less in length. This option is not available on dual stage electronic height adjustable worksurfaces.

To order a dual stage height adjustable base add **\$674 list** and replace ETS with ETD. eg. 88HA6030ETD.

Lifts come standard with an up/down button. Standard colors are Silver Metallic & Black, please contact customer service for other available colors. A 4 position programmable display is available, please see page 70 for price and model number.

Standard base is a T-base. A C base can be specified at the same price. To order a C-base on worksurfaces, up to 30" deep only, replace "T" with "C" e.g. 88HA8430ECS

Single stage height adjustable range: 26" - 45.5"  
 Dual stage height adjustable range: 21" - 47"  
 Power cord is 10 feet long.

**DIMENSION KEY**

W — width  
 D — depth  
 H — height of worksurface  
 KW— kneehole width

Dimensions are in inches and approximate. Contact Customer Service if dimensions are critical.

**CODE DESCRIPTION**

HA - height adjustable  
 E - electric  
 T - T- base  
 C - C- base  
 S - single stage  
 D - dual stage  
 RH - top with cross grain  
 V21- half height floating wood modesty panel  
 V22- half height floating palette modesty panel  
 V26- half height floating laminate modesty panel

**STANDARD FINISHES**

For a complete list of standard wood finishes please see page 10. Disc bases and metal legs are available in a Brushed Stainless finish.

**GROMMETS**

One wiring grommet in standard position is optional at no charge. See page 13 for more information.

# ADESSO | HEIGHT ADJUSTABLE DESK WORKSURFACES

Description	Model	Oak	Anigre	W	D	H	KW	Shipping Weight	Cubic Feet
		Cherry Maple	Walnut						
Electronic Height Adjustable Worksurface with Floating Wood Modesty Panel	88HA3024ETSV21	3564	3921	29.75	24	-	17	114.5	11.5
	88HA3624ETSV21	3704	4071	35.75	24	-	23	117	14
	88HA4224ETSV21	3843	4224	41.75	24	-	29	118	16.5
	88HA4824ETSV21	3921	4315	47.75	24	-	35	119.5	19
	88HA5424ETSV21	4077	4484	53.5	24	-	41	122	21.5
	88HA6024ETSV21	4173	4591	59.75	24	-	47	124	24
	88HA6624ETSV21	4540	4995	65.75	24	-	53	128	26.5
	88HA7224ETSV21	4798	5280	71.75	24	-	59	134.5	29
	88HA7824ETSV21	4946	5441	77.75	24	-	65	139.5	31.5
	88HA8424ETSV21	5238	5761	83.75	24	-	71	145	34
	88HA3030ETSV21	3631	3994	29.75	30	-	17	127.5	36.75
	88HA3630ETSV21	3965	4363	35.75	30	-	23	130	14.25
	88HA4230ETSV21	4142	4558	41.75	30	-	29	131	17.5
	88HA4830ETSV21	4327	4759	47.75	30	-	35	132.5	20.5
	88HA5430ETSV21	4496	4945	53.5	30	-	41	135	23.5
	88HA6030ETSV21	4794	5274	59.75	30	-	47	137	26.5
	88HA6630ETSV21	4973	5471	65.75	30	-	53	145	29.75
	88HA7230ETSV21*	5137	5649	71.75	30	-	59	147.5	32.75
	88HA7830ETSV21	5429	5972	77.75	30	-	65	159.5	35.75
	88HA8430ETSV21	5605	6164	83.75	30	-	71	161.5	38.75
	88HA3036ETSV21	3708	4079	29.75	36	-	17	127.5	42
	88HA3636ETSV21	4098	4507	35.75	36	-	23	130	45.5
	88HA4236ETSV21	4405	4845	41.75	36	-	29	131	17.25
	88HA4836ETSV21	4591	5050	47.75	36	-	35	132.5	20.75
	88HA5436ETSV21	4890	5381	53.5	36	-	41	135	24.5
	88HA6036ETSV21	5059	5563	59.75	36	-	47	137	28.25
	88HA6636ETSV21	5368	5906	65.75	36	-	53	148	32
	88HA7236ETSV21	5531	6083	71.75	36	-	59	166.5	35.5
	88HA7836ETSV21	5876	6465	77.75	36	-	65	175.5	39.25
	88HA8436ETSV21	6000	6602	83.75	36	-	71	177.5	43



**ORDERING NOTES:**

To order a height adjustable return worksurface in place of a return or linking unit insert RH into the model number before the ETS. e.g. 88HA6024RHETS

To order a height adjustable worksurface with a top overhang of 16" at one end add O16 to the end of the model number. e.g. 88HA6024ETSO16. Please note that this option is not available on electronic height adjustable worksurfaces that are 42" or less in length. This option is not available on dual stage electronic height adjustable worksurfaces.

To order a dual stage height adjustable base add \$674 to the list price and replace ETS with ETD. eg. 88HA6030ETD.

Lifts come standard with an up/down button. Standard colors are Silver Metallic & Black, please contact customer service for other available colors. A 4 position programmable display is available, please see page 70 for price and model number.

Standard base is a T-base. A C base can be specified at the same price. To order a C-base on worksurfaces, up to 30" deep only, replace "T" with "C" e.g. 88HA8430ECS

Single stage height adjustable range: 26" - 45.5"  
 Dual stage height adjustable range: 21" - 47"  
 Power cord is 10 feet long.

**ORDERING PROCEDURE**

- To order, please specify the following:
- 1) Krug product model number
  - 2) Wood species and finish
  - 3) Grommet location and style if applicable.

\* Indicates model illustrated by line drawing

**CODE DESCRIPTION**

- HA - height adjustable
- E - electric
- T - T- base
- C - C- base
- S - single stage
- D - dual stage
- RH - top with cross grain
- V21- half height floating wood modesty panel
- V22- half height floating palette modesty panel
- V26- half height floating laminate modesty panel

**STANDARD FINISHES**

For a complete list of standard wood finishes please see page 10. Disc bases and metal legs are available in a Brushed Stainless finish.

**GROMMETS**

One wiring grommet in standard position is optional at no charge. See page 13 for more information.

# ADESSO | HEIGHT ADJUSTABLE DESK WORKSURFACES

Description	Model	Oak		W	D	H	KW	Shipping Weight	Cubic Feet
		Cherry Maple	Anigre Walnut						
 Electronic Height Adjustable Worksurface with Base Enclosures	88HA4224ETSG	5510	6061	41.75	24	-	24	154	16.5
	88HA4824ETSG	5562	6119	47.75	24	-	30	154.5	19
	88HA5424ETSG	5688	6256	53.5	24	-	36	155	21.5
	88HA6024ETSG	5752	6328	59.75	24	-	42	156	24
	88HA6624ETSG	6088	6697	65.75	24	-	48	159	26.5
	88HA7224ETSG	6317	6948	71.75	24	-	54	164.5	29
	88HA7824ETSG	6435	7079	77.75	24	-	60	167.5	31.5
	88HA8424ETSG	6693	7365	83.75	24	-	66	172	34
	88HA4230ETSG	6080	6688	41.75	30	-	24	177	17.5
	88HA4830ETSG	6237	6861	47.75	30	-	30	177.5	20.5
	88HA5430ETSG	6374	7014	53.5	30	-	36	178	23.5
	88HA6030ETSG	6641	7304	59.75	30	-	42	179	26.5
	88HA6630ETSG	6791	7468	65.75	30	-	48	186	29.75
	88HA7230ETSG	6923	7615	71.75	30	-	54	187.5	32.75
	88HA7830ETSG*	7185	7905	77.75	30	-	60	197.5	35.75
	88HA8430ETSG	7331	8062	83.75	30	-	66	198.5	38.75
	88HA4236ETSG	6604	7264	41.75	36	-	24	187	17.25
	88HA4836ETSG	6760	7437	47.75	36	-	30	187.5	20.75
	88HA5436ETSG	7029	7732	53.5	36	-	36	188	24.5
	88HA6036ETSG	7163	7881	59.75	36	-	42	189	28.25
88HA6636ETSG	7445	8190	65.75	36	-	48	199	32	
88HA7236ETSG	7577	8337	71.75	36	-	54	216.5	35.5	
88HA7836ETSG	7893	8682	77.75	36	-	60	223.5	39.25	
88HA8436ETSG	7986	8785	83.75	36	-	66	224.5	3	

**ORDERING NOTES:**

To order a height adjustable return worksurface in place of a return or linking unit insert RH into the model number before the ETS. e.g. 88HA6024RHETS.

To order a height adjustable worksurface with a top overhang of 16" at one end add O16 to the end of the model number. e.g. 88HA6024ETSO16. Please note that this option is not available on electronic height adjustable worksurfaces that are 42" or less in length. This option is not available on dual stage electronic height adjustable worksurfaces.

To order a dual stage height adjustable base add **\$674** to the list price and replace ETS with ETD. eg. 88HA6030ETD.

Lifts come standard with an up/down button. Standard colors are Silver Metallic & Black, please contact customer service for other avail-able colors. A 4 position programmable display is available, please see page 70 for price and model number.

Standard base is a T-base. A C base can be specified at the same price. To order a C-base on worksurfaces, up to 30" deep only, replace "T" with "C" e.g. 88HA8430ECS

Single stage height adjustable range: 26" - 45.5"  
 Dual stage height adjustable range: 21" - 47"  
 Power cord is 10 feet long.

**DIMENSION KEY**

W — width  
 D — depth  
 H — height of worksurface  
 KW— kneehole width

Dimensions are in inches and approximate.  
 Contact Customer Service if dimensions are critical.

**CODE DESCRIPTION**

HA - height adjustable  
 E - electric  
 T - T- base  
 C - C- base  
 S - single stage  
 D - dual stage  
 RH - top with cross grain  
 V21- half height floating wood modesty panel  
 V22- half height floating palette modesty panel  
 V26- half height floating laminate modesty panel

**STANDARD FINISHES**

For a complete list of standard wood finishes please see page 10. Disc bases and metal legs are available in a Brushed Stainless finish.

**GROMMETS**

One wiring grommet in standard position is optional at no charge. See page 13 for more information.

# ADESSO | HEIGHT ADJUSTABLE DESK WORKSURFACES

Description	Model	Oak Cherry Maple	Anigre Walnut	W	D	H	KW	Shipping Weight	Cubic Feet
Electronic Height Adjustable Work Surface with Base Enclosures and Floating Wood Modesty Panel	88HA4224ETSGV21	5927	6519	41.75	24	-	24	163	16.5
	88HA4824ETSGV21	6070	6676	47.75	24	-	30	164.5	19
	88HA5424ETSGV21	6213	6835	53.5	24	-	36	167	21.5
	88HA6024ETSGV21	6300	6933	59.75	24	-	42	169	24
	88HA6624ETSGV21	6499	7150	65.75	24	-	48	173	26.5
	88HA7224ETSGV21	6641	7304	71.75	24	-	54	179.5	29
	88HA7824ETSGV21	7082	7791	77.75	24	-	60	184.5	31.5
	88HA8424ETSGV21	7416	8158	83.75	24	-	66	190	34
	88HA4230ETSGV21	6717	7392	41.75	30	-	24	186	17.5
	88HA4830ETSGV21	6907	7596	47.75	30	-	30	187.5	20.5
	88HA5430ETSGV21	7078	7786	53.5	30	-	36	190	23.5
	88HA6030ETSGV21	7379	8118	59.75	30	-	42	192	26.5
	88HA6630ETSGV21	7603	8364	65.75	30	-	48	200	29.75
	88HA7230ETSGV21	7810	8592	71.75	30	-	54	202.5	32.75
	88HA7830ETSGV21*	8180	8998	77.75	30	-	60	214.5	35.75
	88HA8430ETSGV21	8431	9273	83.75	30	-	66	216.5	38.75
	88HA4236ETSGV21	7241	7966	41.75	36	-	24	196	17.25
	88HA4836ETSGV21	7430	8172	47.75	36	-	30	197.5	20.75
	88HA5436ETSGV21	7732	8505	53.5	36	-	36	200	24.5
	88HA6036ETSGV21	7903	8694	59.75	36	-	42	202	28.25
	88HA6636ETSGV21	8258	9084	65.75	36	-	48	213	32
	88HA7236ETSGV21	8467	9312	71.75	36	-	54	231.5	35.5
	88HA7836ETSGV21	8887	9774	77.75	36	-	60	240.5	39.25
	88HA8436ETSGV21	9086	9993	83.75	36	-	66	242.5	43



**ORDERING NOTES:**

To order a height adjustable return worksurface to use in place of a return or linking unit insert RH into the model number before the ETS. e.g. 88HA6024RHETSGV21.

To order a height adjustable worksurface with a top overhang of 16" at one end insert O16 into the model number after ETS. e.g. 88HA6024ETSO16GV21. Please note that this option is not available on height adjustable work surfaces that have base enclosures and are 48" or less in length. This option is not available on dual stage elec-tronic height adjustable .worksurfaces.

To order a dual stage height adjustable base **add \$674** to the list price and replace ETS with ETD. eg. 88HA6030ETDGV21. Lifts come standard with an up/down button. Standard colors are Silver Metallic & Black, please contact customer service for other available colors. A 4 position programmable display is available, please see page 70 for price and model number.

Modesty panels are available in low pressure laminate, please replace V21 with V26 for this option. e.g. 88HA6030ETSGV26.

Modesty panels are also available in palette, please replace V21 with V22 for this option. e.g. 88HA6030ETSGV22.

Single stage height adjustable range: 26" - 45.5"

Dual stage height adjustable range: 21" - 47"

Power cord is 10 feet long.

**ORDERING PROCEDURE**

- To order, please specify the following:
- 1) Krug product model number
  - 2) Wood species and finish
  - 3) Grommet location and style if applicable.

\* Indicates model illustrated by line drawing

**CODE DESCRIPTION**

- HA - height adjustable
- E - electric
- T - T- base
- C - C- base
- S - single stage
- D - dual stage
- RH - top with cross grain
- V21- half height floating wood modesty panel
- V22- half height floating palette modesty panel
- V26- half height floating laminate modesty panel

**STANDARD FINISHES**

For a complete list of standard wood finishes please see page 10. Disc bases and metal legs are available in a Brushed Stainless finish.

**GROMMETS**

One wiring grommet in standard position is optional at no charge. See page 13 for more information.

# ADESSO | HEIGHT ADJUSTABLE RETURN WORKSURFACES

Description	Model	Oak		W	D	H	KW	Shipping Weight	Cubic Feet	
		Cherry Maple	Anigre Walnut							
	Electronic Height Adjustable Return Worksurface	88HA4824RHETS	3307	3638	47.75	24	-	35	109.5	19
	88HA5424RHETS	3431	3773	53.5	24	-	41	110	21.5	
	88HA6024RHETS	3495	3846	59.75	24	-	47	111	24	
	88HA6624RHETS	3831	4215	65.75	24	-	53	114	26.5	
	88HA7224RHETS	4061	4466	71.75	24	-	59	119.5	29	
	88HA7824RHETS	4179	4595	77.75	24	-	65	122.5	31.5	
	88HA8424RHETS	4439	4885	83.75	24	-	71	127	34	
	88HA4830RHETS	3712	4084	47.75	30	-	35	122.5	20.5	
	88HA5430RHETS	3849	4236	53.5	30	-	41	123	23.5	
	88HA6030RHETS	4116	4529	59.75	30	-	47	124	26.5	
88HA6630RHETS	4265	4692	65.75	30	-	53	131	29.75		
88HA7230RHETS	4397	4838	71.75	30	-	59	132.5	32.75		
88HA7830RHETS*	4663	5128	77.75	30	-	65	142.5	35.75		
88HA8430RHETS	4809	5286	83.75	30	-	71	143.5	38.75		
88HA4836RHETS	3977	4372	47.75	36	-	35	122.5	20.75		
88HA5436RHETS	4245	4669	53.5	36	-	41	123	24.5		
88HA6036RHETS	4380	4818	59.75	36	-	47	124	28.25		
88HA6636RHETS	4663	5128	65.75	36	-	53	134	32		
88HA7236RHETS	4793	5273	71.75	36	-	59	151.5	35.5		
88HA7836RHETS	5109	5617	77.75	36	-	65	158.5	39.25		
88HA8436RHETS	5203	5721	83.75	36	-	71	159.5	43		

**ORDERING NOTES:**

To order a height adjustable return worksurface in place of a return or linking unit insert RH into the model number before the ETS. e.g. 88HA6024RHETS.

To order a height adjustable worksurface with a top overhang of 16" at one end add O16 to the end of the model number. e.g. 88HA6024ETSO16. Please note that this option is not available on electronic height adjustable worksurfaces that are 42" or less in length. This option is not available on dual stage electronic height adjustable worksurfaces.

To order a dual stage height adjustable base add **\$674** to the list price and replace ETS with ETD. eg. 88HA6030ETD.

Lifts come standard with an up/down button. Standard colors are Silver Metallic & Black, please contact customer service for other available colors. A 4 position programmable display is available, please see page 70 for price and model number.

Standard base is a T-base. A C base can be specified at the same price. To order a C-base on worksurfaces, up to 30" deep only, replace "T" with "C" e.g. 88HA8430ECS

Single stage height adjustable range: 26" - 45.5"

Dual stage height adjustable range: 21" - 47"

Power cord is 10 feet long.

**DIMENSION KEY**

- W — width
- D — depth
- H — height of worksurface
- KW— kneehole width

Dimensions are in inches and approximate. Contact Customer Service if dimensions are critical.

**CODE DESCRIPTION**

- HA - height adjustable
- RH - Return (cross grain)
- E - electric
- T - T- base
- C - C- base
- S - single stage
- D - dual stage

**STANDARD FINISHES**

For a complete list of standard wood finishes please see page 9.

**GROMMETS**

One wiring grommet in standard position is optional at no charge. See page 12 for more information.

# ADESSO | HEIGHT ADJUSTABLE RETURN WORKSURFACES

Description	Model	Oak Cherry Maple	Anigre Walnut	W	D	H	KW	Shipping Weight	Cubic Feet	
	Electronic Height Adjustable Return Worksurface	88HA4824RHETSV21	3921	4315	47.75	24	-	35	119.5	19
	88HA5424RHETSV21	4077	4484	53.5	24	-	41	122	21.5	
	88HA6024RHETSV21	4173	4591	59.75	24	-	47	124	24	
	with Floating Wood Modesty Panel	88HA6624RHETSV21	4540	4995	65.75	24	-	53	128	26.5
	88HA7224RHETSV21	4798	5280	71.75	24	-	59	134.5	29	
	88HA7824RHETSV21	4946	5441	77.75	24	-	65	139.5	31.5	
	88HA8424RHETSV21	5238	5761	83.75	24	-	71	145	34	
	88HA4830RHETSV21	4327	4759	47.75	30	-	35	132.5	20.5	
	88HA5430RHETSV21	4496	4945	53.5	30	-	41	135	23.5	
	88HA6030RHETSV21	4794	5274	59.75	30	-	47	137	26.5	
88HA6630RHETSV21	4973	5471	65.75	30	-	53	145	29.75		
88HA7230RHETSV21*	5137	5649	71.75	30	-	59	147.5	32.75		
88HA7830RHETSV21	5429	5972	77.75	30	-	65	159.5	35.75		
88HA8430RHETSV21	5605	6164	83.75	30	-	71	161.5	38.75		
88HA4836RHETSV21	4591	5050	47.75	36	-	35	132.5	20.75		
88HA5436RHETSV21	4890	5381	53.5	36	-	41	135	24.5		
88HA6036RHETSV21	5059	5563	59.75	36	-	47	137	28.25		
88HA6636RHETSV21	5368	5906	65.75	36	-	53	148	32		
88HA7236RHETSV21	5531	6083	71.75	36	-	59	166.5	35.5		
88HA7836RHETSV21	5876	6465	77.75	36	-	65	175.5	39.25		
88HA8436RHETSV21	6000	6602	83.75	36	-	71	177.5	43		

**ORDERING NOTES:**

To order a height adjustable return work surface in place of a return or linking unit insert RH into the model number before the ETS. e.g. 88HA6024RHETS

To order a height adjustable work surface with a top overhang of 16" at one end add O16 to the end of the model number. e.g. 88HA6024ETSO16. Please note that this option is not available on electronic height adjustable work surfaces that are 42" or less in length. This option is not available on dual stage electronic height adjustable work surfaces.

To order a dual stage height adjustable base add \$674 to the list price and replace ETS with ETD. eg. 88HA6030ETD.

Lifts come standard with an up/down button. Standard colors are Silver Metallic & Black, please contact customer service for other available colors. A 4 position programmable display is available, please see page 70 for price and model number.

Standard base is a T-base. A C base can be specified at the same price. To order a C-base on work surfaces, up to 30" deep only, replace "T" with "C" e.g. 88HA8430ECS

Single stage height adjustable range: 26" - 45.5"  
 Dual stage height adjustable range: 21" - 47"  
 Power cord is 10 feet long.

**ORDERING PROCEDURE**

- To order, please specify the following:
- 1) Krug product model number
  - 2) Wood species and finish
  - 3) Grommet location and style if applicable.

\* Indicates model illustrated by line drawing

**CODE DESCRIPTION**

- HA - height adjustable
- RH - Return (cross grain)
- E - electric
- T - T- base
- C - C- base
- S - single stage
- D - dual stage
- V21 - 1/2 height floating wood modesty panel

**STANDARD FINISHES**

For a complete list of standard wood finishes please see page 9. Disc bases and metal legs are available in a Brushed Stainless finish.

**GROMMETS**

One wiring grommet in standard position is optional at no charge. See page 12 for more information.



## ADESSO | HEIGHT ADJUSTABLE RETURN WORKSURFACES

Description	Model	Oak		W	D	H	KW	Shipping Weight	Cubic Feet
		Cherry Maple	Anigre Walnut						
 Electronic Height Adjustable Return Worksurface with Base Enclosures	88HA4824RHETSG	5562	6119	47.75	24	-	30	154.5	19
	88HA5424RHETSG	5688	6256	53.5	24	-	36	155	21.5
	88HA6024RHETSG	5752	6328	59.75	24	-	42	156	24
	88HA6624RHETSG	6088	6697	65.75	24	-	48	159	26.5
	88HA7224RHETSG	6317	6948	71.75	24	-	54	164.5	29
	88HA7824RHETSG	6435	7079	77.75	24	-	60	167.5	31.5
	88HA8424RHETSG	6693	7365	83.75	24	-	66	172	34
	88HA4830RHETSG	6237	6861	47.75	30	-	30	177.5	20.5
	88HA5430RHETSG	6374	7014	53.5	30	-	36	178	23.5
	88HA6030RHETSG	6641	7304	59.75	30	-	42	179	26.5
88HA6630RHETSG	6791	7468	65.75	30	-	48	186	29.75	
88HA7230RHETSG	6923	7615	71.75	30	-	54	187.5	32.75	
88HA7830RHETSG*	7185	7905	77.75	30	-	60	197.5	35.75	
88HA8430RHETSG	7331	8062	83.75	30	-	66	198.5	38.75	
88HA4836RHETSG	6760	7437	47.75	36	-	30	187.5	20.75	
88HA5436RHETSG	7029	7732	53.5	36	-	36	188	24.5	
88HA6036RHETSG	7163	7881	59.75	36	-	42	189	28.25	
88HA6636RHETSG	7445	8190	65.75	36	-	48	199	32	
88HA7236RHETSG	7577	8337	71.75	36	-	54	216.5	35.5	
88HA7836RHETSG	7893	8682	77.75	36	-	60	223.5	39.25	
88HA8436RHETSG	7986	8785	83.75	36	-	66	224.5	3	

**ORDERING NOTES:**

To order a height adjustable return work surface in place of a return or linking unit insert RH into the model number before the ETS. e.g. 88HA6024RHETS.

To order a height adjustable work surface with a top overhang of 16" at one end add O16 to the end of the model number. e.g. 88HA6024ETSO16. Please note that this option is not available on electronic height adjustable work surfaces that are 42" or less in length. This option is not available on dual stage electronic height adjustable work surfaces.

To order a dual stage height adjustable base **add \$674** to the list price and replace ETS with ETD. eg. 88HA6030ETD.

Lifts come standard with an up/down button. Standard colors are Silver Metallic & Black, please contact customer service for other available colors. A 4 position programmable display is available, please see page 70 for price and model number.

Standard base is a T-base. A C base can be specified at the same price. To order a C-base on work surfaces, up to 30" deep only, replace "T" with "C" e.g. 88HA8430ECS

Single stage height adjustable range: 26" - 45.5"

Dual stage height adjustable range: 21" - 47"

Power cord is 10 feet long.

**DIMENSION KEY**

- W — width
- D — depth
- H — height of work surface
- KW— kneehole width

Dimensions are in inches and approximate. Contact Customer Service if dimensions are critical.

**CODE DESCRIPTION**

- HA - height adjustable
- RH - Return (cross grain)
- E - electric
- T - T- base
- C - C- base
- S - single stage
- D - dual stage

**STANDARD FINISHES**

For a complete list of standard wood finishes please see page 9. Disc bases and metal legs are available in a Brushed Stainless finish.

**GROMMETS**

One wiring grommet in standard position is optional at no charge. See page 12 for more information.

# ADESSO | HEIGHT ADJUSTABLE RETURN WORKSURFACES

Description	Model	Oak		W	D	H	KW	Shipping Weight	Cubic Feet
		Cherry	Maple						
Electronic Height Adjustable Return	88HA4824RHETSGV21	6070	6676	47.75	24	-	30	164.5	19
Worksurface with Base Enclosures and Floating Wood Modesty Panel	88HA5424RHETSGV21	6213	6835	53.5	24	-	36	167	21.5
	88HA6024RHETSGV21	6300	6933	59.75	24	-	42	169	24
	88HA6624RHETSGV21	6499	7150	65.75	24	-	48	173	26.5
	88HA7224RHETSGV21	6641	7304	71.75	24	-	54	179.5	29
	88HA7824RHETSGV21	7082	7791	77.75	24	-	60	184.5	31.5
	88HA8424RHETSGV21	7416	8158	83.75	24	-	66	190	34
	88HA4830RHETSGV21	6907	7596	47.75	30	-	30	187.5	20.5
	88HA5430RHETSGV21	7078	7786	53.5	30	-	36	190	23.5
	88HA6030RHETSGV21	7379	8118	59.75	30	-	42	192	26.5
	88HA6630RHETSGV21	7603	8364	65.75	30	-	48	200	29.75
88HA7230RHETSGV21	7810	8592	71.75	30	-	54	202.5	32.75	
88HA7830RHETSGV21*	8180	8998	77.75	30	-	60	214.5	35.75	
88HA8430RHETSGV21	8431	9273	83.75	30	-	66	216.5	38.75	
88HA4836RHETSGV21	7430	8172	47.75	36	-	30	197.5	20.75	
88HA5436RHETSGV21	7732	8505	53.5	36	-	36	200	24.5	
88HA6036RHETSGV21	7903	8694	59.75	36	-	42	202	28.25	
88HA6636RHETSGV21	8258	9084	65.75	36	-	48	213	32	
88HA7236RHETSGV21	8467	9312	71.75	36	-	54	231.5	35.5	
88HA7836RHETSGV21	8887	9774	77.75	36	-	60	240.5	39.25	
88HA8436RHETSGV21	9086	9993	83.75	36	-	66	242.5	43	



**ORDERING NOTES:**

To order a height adjustable return worksurface to use in place of a return or linking unit insert RH into the model number before the ETS. e.g. 88HA6024RHETSGV21.

To order a height adjustable worksurface with a top overhang of 16" at one end insert O16 into the model number after ETS. e.g. 88HA6024ETSO16GV21. Please note that this option is not available on height adjustable work surfaces that have base enclosures and are 48" or less in length. This option is not available on dual stage elec-tronic height adjustable .worksurfaces.

To order a dual stage height adjustable base add **\$674** to the list price and replace ETS with ETD. eg. 88HA6030ETDGV21. Lifts come standard with an up/down button. Standard colors are Silver Metallic & Black, please contact customer service for other available colors. A 4 position programmable display is available, please see page 70 for price and model number.

Modesty panels are available in low pressure laminate, please replace V21 with V26 for this option. e.g. 88HA6030ETSGV26.

Modesty panels are also available in palette, please replace V21 with V22 for this option. e.g. 88HA6030ETSGV22.

Single stage height adjustable range: 26" - 45.5"

Dual stage height adjustable range: 21" - 47"

Power cord is 10 feet long.

**ORDERING PROCEDURE**

- To order, please specify the following:
- 1) Krug product model number
  - 2) Wood species and finish
  - 3) Grommet location and style if applicable.

\* Indicates model illustrated by line drawing

**CODE DESCRIPTION**

- HA - height adjustable
- RH - Return (cross grain)
- E - electric
- T - T- base
- C - C- base
- S - single stage
- D - dual stage
- V21 - 1/2 height floating wood modesty panel

**STANDARD FINISHES**

For a complete list of standard wood finishes please see page 9. Disc bases and metal legs are available in a Brushed Stainless finish.

**GROMMETS**

One wiring grommet in standard position is optional at no charge. See page 12 for more information.

Description	Model	Oak Cherry Maple	Anigre Walnut	W	D	H	KW	Shipping Weight	Cubic Feet
 Rectangular Desk with Aluminum Leg	88DQ60304LLG	3841	4223	59.75	30	29.5	53	152	39
	88DQ60304RLG	3841	4223	59.75	30	29.5	53	152	39
	88DQ66304LLG	3870	4258	65.75	30	29.5	59	161	43
	88DQ66304RLG	3870	4258	65.75	30	29.5	59	161	43
	88DQ66364LLG	3915	4308	65.75	36	29.5	59	186	50.5
	88DQ66364RLG	3915	4308	65.75	36	29.5	59	186	50.5
	88DQ72304LLG	4005	4404	71.5	30	29.5	65	170	46.5
	88DQ72304RLG	4005	4404	71.5	30	29.5	65	170	46.5
	88DQ72364LLG	4036	4437	71.5	36	29.5	65	196	54.5
	88DQ72364RLG*	4036	4437	71.5	36	29.5	65	196	54.5
	88DQ78304LLG	4111	4524	77.5	30	29.5	71	178	50
	88DQ78304RLG	4111	4524	77.5	30	29.5	71	178	50
	88DQ78364LLG	4203	4620	77.5	36	29.5	71	207	59
	88DQ78364RLG	4203	4620	77.5	36	29.5	71	207	59
	88DQ84304LLG	4291	4720	83.5	30	29.5	77	187	54
	88DQ84304RLG	4291	4720	83.5	30	29.5	77	187	54
	88DQ84364LLG	4426	4868	83.5	36	29.5	77	217	63.5
	88DQ84364RLG	4426	4868	83.5	36	29.5	77	217	63.5

 Rectangular Desk with Disc Base	88DQ60304LDB	3991	4391	59.75	30	29.5	42	164	39
	88DQ60304RDB	3991	4391	59.75	30	29.5	42	164	39
	88DQ66304LDB	4021	4422	65.75	30	29.5	48	173	43
	88DQ66304RDB	4021	4422	65.75	30	29.5	48	173	43
	88DQ66364LDB	4065	4471	65.75	36	29.5	45	198	50.5
	88DQ66364RDB	4065	4471	65.75	36	29.5	45	198	50.5
	88DQ72304LDB	4155	4571	71.5	30	29.5	54	181	46.5
	88DQ72304RDB	4155	4571	71.5	30	29.5	54	181	46.5
	88DQ72364LDB	4185	4604	71.5	36	29.5	50.5	208	54.5
	88DQ72364RDB*	4185	4604	71.5	36	29.5	50.5	208	54.5
	88DQ78304LDB	4261	4686	77.5	30	29.5	60	190	50
	88DQ78304RDB	4261	4686	77.5	30	29.5	60	190	50
	88DQ78364LDB	4352	4786	77.5	36	29.5	57	218	59
	88DQ78364RDB	4352	4786	77.5	36	29.5	57	218	59
	88DQ84304LDB	4442	4887	83.5	30	29.5	66	199	54
	88DQ84304RDB	4442	4887	83.5	30	29.5	66	199	54
	88DQ84364LDB	4576	5034	83.5	36	29.5	62.5	229	63.5
	88DQ84364RDB	4576	5034	83.5	36	29.5	62.5	229	63.5

**ORDERING NOTES:**

All desk runoffs are available with three floating modesty panel options: wood, acrylic and back-painted glass. For floating modesty panel upcharges, please see page 40. To order, add the floating modesty panel reference number to the end of the runoff model number.

**DIMENSION KEY**

W — width  
D — depth  
H — height of worksurface  
KW— kneehole width

Dimensions are in inches and approximate. Contact Customer Service if dimensions are critical.

**CODE DESCRIPTION**

4 - desk height  
L - left-handed position  
R - right-handed position  
LG - aluminum legs  
DB - disc base  
V21- floating wood modesty panel  
V29- floating acrylic modesty panel  
V24- back-painted glass modesty panel

**STANDARD FINISHES**

For a complete list of standard wood finishes, please see page 9.

Disc bases and metal legs are available in an Brushed Stainless finish.

**GROMMETS**

One grommet in a standard position is optional at no charge. See page 12 for more information.

# ADESSO | OPEN DESKS

Description	Model	Oak		W	D	H	KW	Shipping Weight	Cubic Feet
		Cherry Maple	Anigre Walnut						
 Rectangular Desk with Wood/Aluminum Base	88DQ60304LWB	4442	4887	59.75	30	29.5	41.5	167	39
	88DQ60304RWB	4442	4887	59.75	30	29.5	41.5	167	39
	88DQ66304LWB	4471	4920	65.75	30	29.5	47.5	176	43
	88DQ66304RWB	4471	4920	65.75	30	29.5	47.5	176	43
	88DQ66364LWB	4515	4968	65.75	36	29.5	44.5	201	50.5
	88DQ66364RWB	4515	4968	65.75	36	29.5	44.5	201	50.5
	88DQ72304LWB	4608	5066	71.5	30	29.5	53.5	185	46.5
	88DQ72304RWB	4608	5066	71.5	30	29.5	53.5	185	46.5
	88DQ72364LWB	4637	5099	71.5	36	29.5	50.5	211	54.5
	88DQ72364RWB*	4637	5099	71.5	36	29.5	50.5	211	54.5
	88DQ78304LWB	4728	5201	77.5	30	29.5	59.5	193	50
	88DQ78304RWB	4728	5201	77.5	30	29.5	59.5	193	50
	88DQ78364LWB	4802	5284	77.5	36	29.5	56.5	222	59
	88DQ78364RWB	4802	5284	77.5	36	29.5	56.5	222	59
	88DQ84304LWB	4893	5384	83.5	30	29.5	65	202	54
	88DQ84304RWB	4893	5384	83.5	30	29.5	65	202	54
	88DQ84364LWB	5030	5531	83.5	36	29.5	62	232	63.5
	88DQ84364RWB	5030	5531	83.5	36	29.5	62	232	63.5

 Arc Desk with Disc Base	88DA60304LDB	4036	4437	59.75	30	29.5	41.5	164	39
	88DA60304RDB	4036	4437	59.75	30	29.5	41.5	164	39
	88DA66304LDB	4065	4471	65.75	30	29.5	47.5	173	43
	88DA66304RDB	4065	4471	65.75	30	29.5	47.5	173	43
	88DA66364LDB	4111	4524	65.75	36	29.5	44.5	198	50.5
	88DA66364RDB	4111	4524	65.75	36	29.5	44.5	198	50.5
	88DA72304LDB	4203	4620	71.5	30	29.5	53.5	181	46.5
	88DA72304RDB	4203	4620	71.5	30	29.5	53.5	181	46.5
	88DA72364LDB	4233	4654	71.5	36	29.5	50.5	208	54.5
	88DA72364RDB*	4233	4654	71.5	36	29.5	50.5	208	54.5
	88DA78304LDB	4336	4769	77.5	30	29.5	59.5	190	50
	88DA78304RDB	4336	4769	77.5	30	29.5	59.5	190	50
	88DA78364LDB	4396	4837	77.5	36	29.5	56.5	218	59
	88DA78364RDB	4396	4837	77.5	36	29.5	56.5	218	59
	88DA84304LDB	4471	4920	83.5	30	29.5	65.5	199	54
	88DA84304RDB	4471	4920	83.5	30	29.5	65.5	199	54
	88DA84364LDB	4622	5084	83.5	36	29.5	62.5	229	63.5
	88DA84364RDB	4622	5084	83.5	36	29.5	62.5	229	63.5

**ORDERING NOTES:**

All desks are available with three floating modesty panel options: wood, acrylic and back-painted glass. For floating modesty panel upcharges, please see page 40. To order, add the floating modesty panel reference number to the end of the runoff model number.

**ORDERING PROCEDURE**

- To order, please specify the following:
- 1) Krug product model number
  - 2) Wood species and finish
  - 3) Grommet location and style if applicable.

\* Indicates model illustrated by line drawing

**CODE DESCRIPTION**

- 4 - desk height
- L - left-handed position
- R - right-handed position
- WB- wood/aluminum base
- DB - disc base
- V21- floating wood modesty panel
- V29- floating acrylic modesty panel
- V24- back-painted glass modesty panel

**STANDARD FINISHES**

For a complete list of standard wood finishes, please see page 9.

**GROMMETS**

One grommet in a standard position is optional at no charge. See page 12 for more information.

Description	Model	Oak		W	D	H	KW	Shipping Weight	Cubic Feet
		Cherry Maple	Anigre Walnut						
 Arc Desk with Wood/Aluminum Base	88DA60304LWB	4486	4933	59.75	30	29.5	41.5	167	39
	88DA60304RWB	4486	4933	59.75	30	29.5	41.5	167	39
	88DA66304LWB	4515	4968	65.75	30	29.5	47.5	176	43
	88DA66304RWB	4515	4968	65.75	30	29.5	47.5	176	43
	88DA66364LWB	4562	5017	65.75	36	29.5	44.5	201	50.5
	88DA66364RWB	4562	5017	65.75	36	29.5	44.5	201	50.5
	88DA72304LWB	4653	5116	71.5	30	29.5	53.5	185	46.5
	88DA72304RWB	4653	5116	71.5	30	29.5	53.5	185	46.5
	88DA72364LWB	4683	5152	71.5	36	29.5	50.5	211	54.5
	88DA72364RWB*	4683	5152	71.5	36	29.5	50.5	211	54.5
	88DA78304LWB	4788	5264	77.5	30	29.5	59.5	193	50
	88DA78304RWB	4788	5264	77.5	30	29.5	59.5	193	50
	88DA78364LWB	4846	5332	77.5	36	29.5	56.5	222	59
	88DA78364RWB	4846	5332	77.5	36	29.5	56.5	222	59
	88DA84304LWB	4939	5430	83.5	30	29.5	65	202	54
	88DA84304RWB	4939	5430	83.5	30	29.5	65	202	54
	88DA84364LWB	5075	5582	83.5	36	29.5	62	232	63.5
88DA84364RWB	5075	5582	83.5	36	29.5	62	232	63.5	

 Bullet Desk with Disc Base	88DB60304LDB	4095	4505	59.75	30	29.5	41.5	152	39
	88DB60304RDB	4095	4505	59.75	30	29.5	41.5	152	39
	88DB66304LDB	4127	4537	65.75	30	29.5	47.5	161	43
	88DB66304RDB	4127	4537	65.75	30	29.5	47.5	161	43
	88DB66364LDB	4171	4588	65.75	36	29.5	44.5	186	50.5
	88DB66364RDB	4171	4588	65.75	36	29.5	44.5	186	50.5
	88DB72304LDB	4261	4686	71.5	30	29.5	53.5	170	46.5
	88DB72304RDB	4261	4686	71.5	30	29.5	53.5	170	46.5
	88DB72364LDB	4291	4720	71.5	36	29.5	50.5	196	54.5
	88DB72364RDB*	4291	4720	71.5	36	29.5	50.5	196	54.5
	88DB78304LDB	4381	4819	77.5	30	29.5	59.5	178	50
	88DB78304RDB	4381	4819	77.5	30	29.5	59.5	178	50
	88DB78364LDB	4457	4902	77.5	36	29.5	56.5	207	59
	88DB78364RDB	4457	4902	77.5	36	29.5	56.5	207	59
	88DB84304LDB	4532	4986	83.5	30	29.5	65.5	187	54
	88DB84304RDB	4532	4986	83.5	30	29.5	65.5	187	54
	88DB84364LDB	4683	5152	83.5	36	29.5	62.5	217	63.5
88DB84364RDB	4683	5152	83.5	36	29.5	62.5	217	63.5	

**ORDERING NOTES:**

All desks are available with three floating modesty panel options: wood, acrylic and back-painted glass. For floating modesty panel upcharges, please see page 40. To order, add the floating modesty panel reference number to the end of the runoff model number.

**DIMENSION KEY**

W — width  
 D — depth  
 H — height of worksurface  
 KW— kneehole width

Dimensions are in inches and approximate. Contact Customer Service if dimensions are critical.

**CODE DESCRIPTION**

4 - desk height  
 L - left-handed position  
 R - right-handed position  
 WB- wood/aluminum base  
 DB - disc base

**STANDARD FINISHES**

For a complete list of standard wood finishes, please see page 9.  
 Disc bases and metal legs are available in an Brushed Stainless finish.

**GROMMETS**

One grommet in a standard position is optional at no charge. See page 12 for more information.

# ADESSO | OPEN DESKS

Description	Model	Oak	Anigre	W	D	H	KW	Shipping Weight	Cubic Feet
		Cherry Maple	Walnut						
 Bullet Desk with Wood/ Aluminum Base	88DB60304LWB	4546	5002	59.75	30	29.5	41.5	167	39
	88DB60304RWB	4546	5002	59.75	30	29.5	41.5	167	39
	88DB66304LWB	4576	5034	65.75	30	29.5	47.5	196	43
	88DB66304RWB	4576	5034	65.75	30	29.5	47.5	196	43
	88DB66364LWB	4622	5084	65.75	36	29.5	44.5	201	50.5
	88DB66364RWB	4622	5084	65.75	36	29.5	44.5	201	50.5
	88DB72304LWB	4712	5185	71.5	30	29.5	53.5	185	46.5
	88DB72304RWB	4712	5185	71.5	30	29.5	53.5	185	46.5
	88DB72364LWB	4788	5264	71.5	36	29.5	50.5	211	54.5
	88DB72364RWB*	4788	5264	71.5	36	29.5	50.5	211	54.5
	88DB78304LWB	4863	5349	77.5	30	29.5	59.5	193	50
	88DB78304RWB	4863	5349	77.5	30	29.5	59.5	193	50
	88DB78364LWB	4923	5416	77.5	36	29.5	56.25	222	59
	88DB78364RWB	4923	5416	77.5	36	29.5	56.25	222	59
	88DB84304LWB	4998	5498	83.5	30	29.5	65	202	54
	88DB84304RWB	4998	5498	83.5	30	29.5	65	202	54
88DB84364LWB	5135	5647	83.5	36	29.5	62	232	63.5	
88DB84364RWB	5135	5647	83.5	36	29.5	62	232	63.5	

1/2 Height Floating Wood modesty Panels	V21-60	678	746	-	0.75	12		11	-
	V21-66*	708	780	-	0.75	12		12	-
	V21-72	739	811	-	0.75	12		14	-
	V21-78	768	846	-	0.75	12		15	-
	V21-84	799	879	-	0.75	12		16	-

1/2 Height Floating Back-Painted Glass modesty Panels	V24-60	1068		-	0.75	12		15	-
	V24-66*	1116		-	0.75	12		16	-
	V24-72	1162		-	0.75	12		18	-
	V24-78	1205		-	0.75	12		19	-
	V24-84	1266		-	0.75	12		20	-

1/2 Height Floating Acrylic modesty Panels	V29-60	633		-	0.75	12		9	-
	V29-66*	664		-	0.75	12		10	-
	V29-72	694		-	0.75	12		12	-
	V29-78	723		-	0.75	12		13	-
	V29-84	768		-	0.75	12		14	-

### ORDERING PROCEDURE

To order, please specify the following:

- 1) Krug product model number
- 2) Wood species and finish
- 3) Grommet location and style if applicable.

\* Indicates model illustrated by line drawing

### CODE DESCRIPTION

- 4 - desk height
- L - left-handed position
- R - right-handed position
- WB- wood/aluminum base
- V21- floating wood modesty panel
- V29- floating acrylic modesty panel
- V24- back-painted glass modesty panel

### STANDARD FINISHES

For a complete list of standard wood finishes, please see page 9. Disc bases and metal legs are available in a Brushed Stainless finish.

### GROMMETS

One grommet in a standard position is optional at no charge. See page 12 for more information.

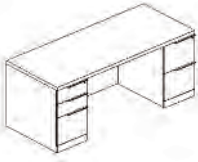
Description	Model	Oak		W	D	H	KW	Shipping Weight	Cubic Feet
		Cherry Maple	Anigre Walnut						
 Rectangular Desk with Full Height Double Pedestals	88D60304LDRF	6760	7436	59.75	30	29.5	28.5	334	39
	88D60304LFRD	6760	7436	59.75	30	29.5	28.5	334	39
	88D60304LFRF	6760	7436	59.75	30	29.5	28.5	334	39
	88D66304LDRF	6798	7481	65.75	30	29.5	34.5	346	43
	88D66304LFRD	6798	7481	65.75	30	29.5	34.5	346	43
	88D66304LFRF	6798	7481	65.75	30	29.5	34.5	346	43
	88D66364LDRF	6829	7512	65.75	36	29.5	34.5	365	50.5
	88D66364LFRD	6829	7512	65.75	36	29.5	34.5	365	50.5
	88D66364LFRF	6829	7512	65.75	36	29.5	34.5	365	50.5
	88D72304LDRF	6868	7553	71.5	30	29.5	40.5	358	46.5
	88D72304LFRD	6868	7553	71.5	30	29.5	40.5	358	46.5
	88D72304LFRF	6868	7553	71.5	30	29.5	40.5	358	46.5
	88D72364LDRF	6912	7603	71.5	36	29.5	40.5	379	54.5
	88D72364LFRD*	6912	7603	71.5	36	29.5	40.5	379	54.5
	88D72364LFRF	6912	7603	71.5	36	29.5	40.5	379	54.5
	88D78304LDRF	6953	7647	77.5	30	29.5	46.5	369	50
	88D78304LFRD	6953	7647	77.5	30	29.5	46.5	369	50
	88D78304LFRF	6953	7647	77.5	30	29.5	46.5	369	50
	88D78364LDRF	6991	7688	77.5	36	29.5	46.5	392	59
	88D78364LFRD	6991	7688	77.5	36	29.5	46.5	392	59
88D78364LFRF	6991	7688	77.5	36	29.5	46.5	392	59	
88D84364LDRF	7071	7780	83.5	36	29.5	52.5	406	63.5	
88D84364LFRD	7071	7780	83.5	36	29.5	52.5	406	63.5	
88D84364LFRF	7071	7780	83.5	36	29.5	52.5	406	63.5	

 Rectangular Desk with Full Height, Single Pedestal	88D60304LFR0	5061	5566	59.75	30	29.5	42.5	272	39
	88D60304LORF	5061	5566	59.75	30	29.5	42.5	272	39
	88D66304LFR0	5099	5611	65.75	30	29.5	48.5	284	43
	88D66304LORF	5099	5611	65.75	30	29.5	48.5	284	43
	88D66364LFR0	5139	5652	65.75	36	29.5	48.5	304	50.5
	88D66364LORF	5139	5652	65.75	36	29.5	48.5	304	50.5
	88D72304LFR0	5179	5695	71.5	30	29.5	54.5	296	46.5
	88D72304LORF	5179	5695	71.5	30	29.5	54.5	296	46.5
	88D72364LFR0*	5218	5741	71.5	36	29.5	54.5	317	54.5
	88D72364LORF	5218	5741	71.5	36	29.5	54.5	317	54.5
	88D78304LFR0	5280	5809	77.5	30	29.5	60.5	308	50
	88D78304LORF	5280	5809	77.5	30	29.5	60.5	308	50
	88D78364LFR0	5307	5838	77.5	36	29.5	60.5	330	59
	88D78364LORF	5307	5838	77.5	36	29.5	60.5	330	59
	88D84364LFR0	5363	5897	83.5	36	29.5	66.5	344	63.5
	88D84364LORF	5363	5897	83.5	36	29.5	66.5	344	63.5

**ORDERING NOTES:**

Pedestals are available with a soft closing drawer option. Please add "S" to the model # and **\$152 list** per pedestal. e.g. 88D84364LDRFS

**DIMENSION KEY**

W — width  
 D — depth  
 H — height of worksurface  
 KW — kneehole width

Dimensions are in inches and approximate. Contact Customer Service if dimensions are critical.

**CODE DESCRIPTION**

4 - full height pedestal  
 L - left-handed pedestal position  
 R - right-handed pedestal position  
 D - 2 file drawers  
 F - 2 box, 1 file drawer  
 0 - no pedestal

**STANDARD FINISHES**

For a complete list of standard wood finishes, please see page 9. Disc bases and metal legs are available in a Brushed Stainless finish.

**GROMMETS**

One grommet in a standard position is optional at no charge. See page 12 for more information.

# ADESSO | DESK TOP OPTIONS

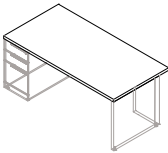
Description	Model	Oak	Anigre	W	D	H	Shipping Weight	Cubic Feet
		Cherry Maple	Walnut					
	OT88D6036	228	250	-	36	-	84	-
	OT88D6636	242	267	-	36	-	92	-
	OT88D6642	258	283	-	42	-	106	-
	OT88D7236	271	299	-	36	-	99	-
	OT88D7242	287	317	-	42	-	114	-
	OT88D7836*	302	333	-	36	-	107	-
	OT88D7842	318	348	-	42	-	123	-
	OT88D8442	333	365	-	42	-	132	-

**ORDERING NOTES:** Add OT before any standard size desk model number and apply upcharge. Add 15 lbs. to standard desk weight for over hang top option.

	88RHP3620L3FX41	3932	4323	42.75	26	29.5	27	132	17.5
	88RHP3620R3FX41	3932	4323	42.75	26	29.5	27	132	17.5
	88RHP3624L3FX41	3948	4340	42.75	30	29.5	27	147	20.5
	88RHP3624R3FX41	3948	4340	42.75	30	29.5	27	147	20.5
	88RHP4220L3FX41	3983	4381	47.75	26	29.5	32	138	20
	88RHP4220R3FX41	3983	4381	47.75	26	29.5	32	138	20
	88RHP4224L3FX41	4038	4441	47.75	30	29.5	32	154	23.5
	88RHP4224R3FX41	4038	4441	47.75	30	29.5	32	154	23.5
	88RHP4820L3FX41	4063	4469	53.75	26	29.5	38	144	22.5
	88RHP4820R3FX41	4063	4469	53.75	26	29.5	38	144	22.5
	88RHP4824L3FX41	4086	4496	53.75	30	29.5	38	161	26.5
	88RHP4824R3FX41	4086	4496	53.75	30	29.5	38	161	26.5
	88RHP6024L3FX41	4299	4732	65.75	30	29.5	50	175	32.5
	88RHP6024R3FX41	4299	4732	65.75	30	29.5	50	175	32.5
	88RHP6624L3FX41	4534	4988	71.75	30	29.5	56	182	35.5
	88RHP6624R3FX41	4534	4988	71.75	30	29.5	56	182	35.5
	88RHP7224L3FX41	4675	5142	77.5	30	29.5	62	189	38.5
	88RHP7224R3FX41*	4675	5142	77.5	30	29.5	62	189	38.5
	88RHP8424L3FX41	4933	5428	89.5	30	29.5	74	203	44.5
	88RHP8424R3FX41	4933	5428	89.5	30	29.5	74	203	44.5

**ORDERING PROCEDURE**

To order, please specify the following:

- 1) Krug product model number
- 2) Wood species and finish
- 3) Grommet location and style if applicable.

\* Indicates model illustrated by line drawing

**CODE DESCRIPTION**

OT - over hang top

**STANDARD FINISHES**

For a complete list of standard wood finishes, please see page 9. Disc bases and metal legs are available in a Brushed Stainless finish.

**GROMMETS**

One grommet in a standard position is optional at no charge. See page 12 for more information.



Description	Model	Oak		W	D	H	KW	Shipping Weight	Cubic Feet
		Cherry Maple	Anigre Walnut						
	88RH3620L4DX41	3481	3828	35.75	20	29.5	20.5	132	17.5
	88RH3620L4FX41	3481	3828	35.75	20	29.5	20.5	132	17.5
	88RH3620R4DX41	3481	3828	35.75	20	29.5	20.5	132	17.5
	88RH3620R4FX41	3481	3828	35.75	20	29.5	20.5	132	17.5
	88RH3624L4DX41	3494	3845	35.75	24	29.5	20.5	147	20.5
	88RH3624L4FX41	3494	3845	35.75	24	29.5	20.5	147	20.5
	88RH3624R4DX41	3494	3845	35.75	24	29.5	20.5	147	20.5
	88RH3624R4FX41	3494	3845	35.75	24	29.5	20.5	147	20.5
	88RH4220L4DX41	3533	3886	41.75	20	29.5	26.5	138	20
	88RH4220L4FX41	3533	3886	41.75	20	29.5	26.5	138	20
	88RH4220R4DX41	3533	3886	41.75	20	29.5	26.5	138	20
	88RH4220R4FX41	3533	3886	41.75	20	29.5	26.5	138	20
	88RH4224L4DX41	3587	3946	41.75	24	29.5	26.5	154	23.5
	88RH4224L4FX41*	3587	3946	41.75	24	29.5	26.5	154	23.5
	88RH4224R4DX41	3587	3946	41.75	24	29.5	26.5	154	23.5
	88RH4224R4FX41	3587	3946	41.75	24	29.5	26.5	154	23.5
	88RH4820L4DX41	3609	3972	47.75	20	29.5	32.5	144	22.5
	88RH4820L4FX41	3609	3972	47.75	20	29.5	32.5	144	22.5
	88RH4820R4DX41	3609	3972	47.75	20	29.5	32.5	144	22.5
	88RH4820R4FX41	3609	3972	47.75	20	29.5	32.5	144	22.5
	88RH4824L4DX41	3635	3997	47.75	24	29.5	32.5	161	26.5
	88RH4824L4FX41	3635	3997	47.75	24	29.5	32.5	161	26.5
	88RH4824R4DX41	3635	3997	47.75	24	29.5	32.5	161	26.5
	88RH4824R4FX41	3635	3997	47.75	24	29.5	32.5	161	26.5
	88RH6024L4DX41	3849	4236	59.75	24	29.5	44.5	175	32.5
	88RH6024L4FX41	3849	4236	59.75	24	29.5	44.5	175	32.5
	88RH6024R4DX41	3849	4236	59.75	24	29.5	44.5	175	32.5
	88RH6024R4FX41	3849	4236	59.75	24	29.5	44.5	175	32.5
	88RH6624L4DX41	4084	4491	65.75	24	29.5	50.5	182	35.5
	88RH6624L4FX41	4084	4491	65.75	24	29.5	50.5	182	35.5
88RH6624R4DX41	4084	4491	65.75	24	29.5	50.5	182	35.5	
88RH6624R4FX41	4084	4491	65.75	24	29.5	50.5	182	35.5	
88RH7224L4DX41	4222	4645	71.5	24	29.5	56	189	38.5	
88RH7224L4FX41*	4222	4645	71.5	24	29.5	56	189	38.5	
88RH7224R4DX41	4222	4645	71.5	24	29.5	56	189	38.5	
88RH7224R4FX41	4222	4645	71.5	24	29.5	56	189	38.5	
88RH8424L4DX41	4484	4931	83.5	24	29.5	68	203	44.5	
88RH8424L4FX41	4484	4931	83.5	24	29.5	68	203	44.5	
88RH8424R4DX41	4484	4931	83.5	24	29.5	68	203	44.5	
88RH8424R4FX41	4484	4931	83.5	24	29.5	68	203	44.5	

**ORDERING NOTES:**

For the hinged modesty panel option add Y after RH and add a 10% upcharge. e.g. 88RHY6024L4DX41. Optional grommets are available in modesty panels for cable management. Half gables are required for additional support for unsupported spans greater than 60", please see page 107 for model number and list price. Pedestals are available with a soft-closing drawer option. Please add "S" to the model number and **\$152 list** per pedestal. e.g.88RH6024L4DX41S.

**DIMENSION KEY**

W — width  
 D — depth  
 H — height of worksurface  
 KW— kneehole width

Dimensions are in inches and approximate.  
 Contact Customer Service if dimensions are critical.

**CODE DESCRIPTION**

L - left-handed position  
 R - right-handed position  
 3 - 3/4 heightpedestal  
 4 - desk height pedestal  
 D - 2 file drawers  
 F - 2 box, 1 file drawer  
 X41- full height modesty panel  
 Y - hinged modesty panel





**STANDARD FINISHES**

For a complete list of standard wood finishes, please see page 9.

**GROMMETS**

One grommet in a standard position is optional at no charge. See page 12 for more information.

# ADESSO | RETURNS

Description	Model	Oak Cherry Maple	Anigre Walnut	W	D	H	KW	Shipping Weight	Cubic Feet
Single Pedestal	88RH5424L3001X41*	4372	4813	53.75	24	29.5	24	235	29.5
Return, Lateral File	88RH5424R3001X41	4372	4813	53.75	24	29.5	24	235	29.5
or Combination	88RH5424L3601X41	4414	4855	53.75	24	29.5	18	252	29.5
Pedestals	88RH5424R3601X41	4414	4855	53.75	24	29.5	18	252	29.5
01 	88RH5424L3602X41***	4515	4968	53.75	24	29.5	18	263	29.5
	88RH5424R3604X41	4515	4968	53.75	24	29.5	18	263	29.5
	88RH5424L3015X41**	4525	4977	53.75	24	29.5	24	218	29.5
	88RH5424R3015X41	4525	4977	53.75	24	29.5	24	218	29.5
	88RH5424L3615X41	4562	5017	53.75	24	29.5	18	233	29.5
	88RH5424R3615X41	4562	5017	53.75	24	29.5	18	233	29.5
	88RH6024L3001X41	4462	4911	59.75	24	29.5	30	245	32.5
	88RH6024R3001X41	4462	4911	59.75	24	29.5	30	245	32.5
	88RH6024L3601X41	4503	4952	59.75	24	29.5	24	262	32.5
	88RH6024R3601X41	4503	4952	59.75	24	29.5	24	262	32.5
02 	88RH6024L3602X41	4608	5066	59.75	24	29.5	24	273	32.5
	88RH6024R3604X41	4608	5066	59.75	24	29.5	24	273	32.5
	88RH6024L3015X41	4614	5077	59.75	24	29.5	30	228	32.5
	88RH6024R3015X41	4614	5077	59.75	24	29.5	30	228	32.5
	88RH6024L3615X41	4653	5116	59.75	24	29.5	24	243	32.5
	88RH6024R3615X41	4653	5116	59.75	24	29.5	24	243	32.5
	88RH7224L3001X41*	4675	5142	71.5	24	29.5	42	266	38.5
	88RH7224R3001X41	4675	5142	71.5	24	29.5	42	266	38.5
	88RH7224L3601X41	4712	5185	71.5	24	29.5	36	283	38.5
	88RH7224R3601X41	4712	5185	71.5	24	29.5	36	283	38.5
04 	88RH7224L3602X41***	4817	5299	71.5	24	29.5	36	293	38.5
	88RH7224R3604X41	4817	5299	71.5	24	29.5	36	293	38.5
	88RH7224L3015X41**	4823	5308	71.5	24	29.5	42	248	38.5
	88RH7224R3015X41	4823	5308	71.5	24	29.5	42	248	38.5
	38RH7224L3615X41	4863	5349	71.5	24	29.5	36	263	38.5
	38RH7224R3615X41	4863	5349	71.5	24	29.5	36	263	38.5
	38RH8424L3001X41	4974	5473	83.5	24	29.5	54	286	44.5
	38RH8424R3001X41	4974	5473	83.5	24	29.5	54	286	44.5
	38RH8424L3601X41	5012	5516	83.5	24	29.5	48	303	44.5
	38RH8424R3601X41	5012	5516	83.5	24	29.5	48	303	44.5
15 	38RH8424L3602X41	5117	5632	83.5	24	29.5	48	314	44.5
	88RH8424R3604X41	5117	5632	83.5	24	29.5	48	314	44.5
	88RH8424L3015X41	5125	5638	83.5	24	29.5	54	269	44.5
	88RH8424R3015X41	5125	5638	83.5	24	29.5	54	269	44.5
	88RH8424L3615X41	5166	5681	83.5	24	29.5	48	284	44.5
	88RH8424R3615X41	5166	5681	83.5	24	29.5	48	284	44.5

**ORDERING NOTES:**

For the hinged modesty panel option add Y after RH and add a 10% upcharge. e.g. 88RHY6024L4DX41. Optional grommets are available in modesty panels for cable management. Half gables are required for additional support for unsupported spans greater than 60", please see page 107 for model number and list price. Pedestals with box and file drawers are available with a soft-closing drawer option. Please add "S" to the model # and **\$152 list** per pedestal. e.g.88RH6024L4DX41S. Lateral file drawers are not available with the soft closing drawer option.

**ORDERING PROCEDURE**

- To order, please specify the following:
- 1) Krug product model number
  - 2) Wood species and finish
  - 3) Grommet location and style if applicable.

\* Indicates model illustrated by line drawing

**CODE DESCRIPTION**

- L - left handed pedestal position
- R - right handed pedestal position
- 30 - 30" wide pedestal
- 36 - 36" wide pedestal
- 01 - lateral file
- 02 - box, box on right, file on left, lateral file
- 04 - file on right, box, box on left, lateral file
- 15 - top open, lateral file
- Y - hinged modesty panel

**STANDARD FINISHES**

For a complete list of standard wood finishes, please see page 9.

**GROMMETS**

One grommet in a standard position is optional at no charge. See page 12 for more information.

Description	Model	Oak		W	D	H	Shipping Weight	Cubic Feet
		Cherry Maple	Anigre Walnut					
	88LU3024H	799	879	29.75	24	-	35	2.25
	88LU3620H	816	898	35.75	20	-	35	2.25
	88LU3624H	835	917	35.75	24	-	40	2.5
	88LU4220H	866	953	41.75	20	-	39	2.5
	88LU4224H	883	973	41.75	24	-	45	3
	88LU4820H	900	989	47.75	20	-	43	2.75
	88LU4824H*	922	1015	47.75	24	-	50	3.25
	88LU5424H	942	1037	54.75	24	-	55	3.75
	88LU6024H	962	1061	59.75	24	-	60	4
	88LU6624H	1011	1110	65.75	24	-	65	4.5
	88LU7224H	1098	1210	71.5	24	-	65	4.5

	Linking Unit with Modesty Panel	88LU3024HX41	1539	1693	29.75	24	-	51.3	25
		88LU3620HX41	1643	1808	35.75	20	-	54	3.75
		88LU3624HX41	1714	1885	35.75	24	-	59	3.75
		88LU4220HX41	1772	1949	41.75	20	-	61	4.25
		88LU4224HX41	1798	1979	41.75	24	-	67	4.25
		88LU4820HX41	1852	2034	47.75	20	-	69	4.75
		88LU4824HX41*	1887	2077	47.75	24	-	75	4.75
		88LU5424HX41	1974	2170	54.75	24	-	83	5.5
		88LU6024HX41	1944	2136	59.75	24	-	92	6
		88LU6624HX41	2003	2205	65.75	24	-	100	6.5
		88LU7224HX41	2063	2271	71.5	24	-	108	7

	Linking Unit with Hinged Modesty Panel	88LUY3024HX41	1749	1924	29.75	24	-	51	3
		88LUY3620HX41	1808	1988	35.75	20	-	54	3.5
		88LUY3624HX41	1858	2043	35.75	24	-	59	3.5
		88LUY4220HX41	1909	2100	41.75	20	-	61	4
		88LUY4224HX41	1960	2157	41.75	24	-	67	4
		88LUY4820HX41	2012	2214	47.75	20	-	69	4.75
		88LUY4824HX41*	2063	2271	47.75	24	-	75	4.75
		88LUY5424HX41	2103	2312	54.75	24	-	83	5.25
		88LUY6024HX41	2138	2353	59.75	24	-	92	5.75
		88LUY6624HX41	2214	2434	65.75	24	-	100	6.25
		88LUY7224HX41	2287	2518	71.5	24	-	108	6.75

**ORDERING NOTES:**

Half gables are required for additional support for unsupported spans greater than 60", please see page 107 for model number and list price.

**DIMENSION KEY**

W — width  
 D — depth  
 H — height of worksurface  
 KW— kneehole width

Dimensions are in inches and approximate. Contact Customer Service if dimensions are critical.

**CODE DESCRIPTION**

H - Desk Height  
 X41- full height modesty  
 Y - hinged modesty panel

**STANDARD FINISHES**

For a complete list of standard wood finishes, please see page 9.

# ADESSO | DESK HEIGHT CREDENZAS WITH EXTENDED PEDESTALS

Description	Model	Oak Cherry Maple	Anigre Walnut	W	D	H	KW	Shipping Weight	Cubic Feet
Double Pedestal	88CP60203LFRF	5332	5866	65.75	26	29.5	34.5	242	27.5
Credenza with 3/4 Height Extended Pedestals	88CP60243LFRF	5408	5947	65.75	30	29.5	34.5	269	32.5
	88CP66203LFRF	5444	5991	71.5	26	29.5	40	247	30.25
	88CP66243LFRF	5519	6073	71.5	30	29.5	40	276	35.5
	88CP72203LFRF	5558	6112	77.5	26	29.5	46.5	253	33
	88CP72243LFRF	5633	6193	77.5	26	29.5	46.5	253	33
	88CP78203LFRF	5668	6237	83.5	26	29.5	52	259	35.5
	88CP78243LFRF	5745	6319	83.5	30	29.5	52	290	41.5
	88CP84203LFRF	5782	6359	95.5	26	29.5	58	265	38
	88CP84243LFRF*	5859	6442	95.5	30	29.5	58	297	44.5
	88CP96203LFRF	6007	6608	101.5	26	29.5	70	277	43
	88CP96243LFRF	6082	6690	101.5	30	29.5	70	311	50.5
Single Pedestal	88CP60203LFR0	4992	5493	65.75	26	29.5	48.5	198	27.5
Credenza with Extended Pedestal	88CP60203LORF	4992	5493	65.75	26	29.5	48.5	198	27.5
	88CP60243LFR0	5028	5530	65.75	30	29.5	48.5	221	32.5
	88CP60243LORF	5028	5530	65.75	30	29.5	48.5	221	32.5
	88CP66203LFR0	5043	5548	71.5	26	29.5	54.5	207	30.25
	88CP66203LORF	5043	5548	71.5	26	29.5	54.5	207	30.25
	88CP66243LFR0	5082	5589	71.5	30	29.5	54.5	231	35.5
	88CP66243LORF	5082	5589	71.5	30	29.5	54.5	231	35.5
	88CP72203LFR0	5099	5611	77.5	26	29.5	60.5	216	33
	88CP72203LORF	5099	5611	77.5	26	29.5	60.5	216	33
	88CP72243LFR0	5137	5649	77.5	30	29.5	60.5	241	38.5
	88CP72243LORF	5137	5649	77.5	30	29.5	60.5	241	38.5
	88CP78203LFR0	5154	5668	83.5	26	29.5	66.5	225	35.5
	88CP78203LORF	5154	5668	83.5	26	29.5	66.5	225	35.5
	88CP78243LFR0	5190	5710	83.5	30	29.5	66.5	252	41.5
	88CP78243LORF	5190	5710	83.5	30	29.5	66.5	252	41.5
	88CP84203LFR0	5210	5729	89.5	26	29.5	72.5	234	38
	88CP84203LORF	5210	5729	89.5	26	29.5	72.5	234	38
	88CP84243LFR0	5244	5767	89.5	30	29.5	72.5	262	44.5
	88CP84243LORF*	5244	5767	89.5	30	29.5	72.5	262	44.5
	88CP96203LFR0	5327	5860	101.5	26	29.5	84.5	252	43
	88CP96203LORF	5327	5860	101.5	26	29.5	84.5	252	43
	88CP96243LFR0	5381	5917	101.5	30	29.5	84.5	283	50.5
	88CP96243LORF	5381	5917	101.5	30	29.5	84.5	283	50.5

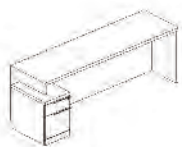
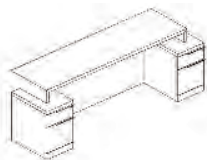

**ORDERING NOTES:**

Optional grommets are available in modesty panels for cable management. Half gables are required for additional support for unsupported spans greater than 60", please see page 107 for model number and list price. To specify an Extended Pedestal in Palette finish, add th suffix "P" to the end of the model number. e.g. 88DRPM72303L3FP. Pedestals are available with a soft-closing drawer option. Please add "S" to the model # and **\$152 list** per pedestal. e.g. 88C6024LDRFS.

**ORDERING PROCEDURE**

- To order, please specify the following:
- 1) Krug product model number
  - 2) Wood species and finish
  - 3) Grommet location and style if applicable.

\* Indicates model illustrated by line drawing

**CODE DESCRIPTION**

- L - left-handed position
- R - right-handed position
- F - 2 file pedestal
- 0 - no pedestal

**STANDARD FINISHES**

For a complete list of standard wood finishes, please see page 9.

**GROMMETS**

One grommet in a standard position is optional at no charge. See page 12 for more information.

# ADESSO | DESK HEIGHT CREDENZAS

Description	Model	Oak Cherry Maple	Anigre Walnut	W	D	H	KW	Shipping Weight	Cubic Feet
Double Pedestal Credenza	88C60204LDRF	4882	5367	59.75	20	29.5	28.5	242	27.5
	88C60204LFRD	4882	5367	59.75	20	29.5	28.5	242	27.5
	88C60204LDRD	4882	5367	59.75	20	29.5	28.5	242	27.5
	88C60204LFRF	4882	5367	59.75	20	29.5	28.5	242	27.5
	88C60244LDRF	4957	5452	59.75	24	29.5	28.5	269	32.5
	88C60244LFRD	4957	5452	59.75	24	29.5	28.5	269	32.5
	88C60244LDRD	4957	5452	59.75	24	29.5	28.5	269	32.5
	88C60244LFRF	4957	5452	59.75	24	29.5	28.5	269	32.5
	88C66204LDRF	4994	5495	65.75	20	29.5	34	248	30.25
	88C66204LFRD	4994	5495	65.75	20	29.5	34	248	30.25
	88C66204LDRD	4994	5495	65.75	20	29.5	34	248	30.25
	88C66204LFRF	4994	5495	65.75	20	29.5	34	248	30.25
	88C66244LDRF	5068	5576	65.75	24	29.5	34	276	35.5
	88C66244LFRD	5068	5576	65.75	24	29.5	34	276	35.5
	88C66244LDRD	5068	5576	65.75	24	29.5	34	276	35.5
	88C66244LFRF	5068	5576	65.75	24	29.5	34	276	35.5
	88C72204LDRF	5107	5615	71.5	20	29.5	40.5	253	33
	88C72204LFRD	5107	5615	71.5	20	29.5	40.5	253	33
	88C72204LDRD	5107	5615	71.5	20	29.5	40.5	253	33
	88C72204LFRF	5107	5615	71.5	20	29.5	40.5	253	33
	88C72244LDRF	5181	5696	71.5	24	29.5	40.5	283	38.5
	88C72244LFRD*	5181	5696	71.5	24	29.5	40.5	283	38.5
	88C72244LDRD	5181	5696	71.5	24	29.5	40.5	283	38.5
	88C72244LFRF	5181	5696	71.5	24	29.5	40.5	283	38.5
	88C78204LDRF	5217	5740	77.5	20	29.5	46	260	35.5
	88C78204LFRD	5217	5740	77.5	20	29.5	46	260	35.5
	88C78204LDRD	5217	5740	77.5	20	29.5	46	260	35.5
	88C78204LFRF	5217	5740	77.5	20	29.5	46	260	35.5
	88C78244LDRF	5293	5824	77.5	24	29.5	46	290	41.5
	88C78244LFRD	5293	5824	77.5	24	29.5	46	290	41.5
88C78244LDRD	5293	5824	77.5	24	29.5	46	290	41.5	
88C78244LFRF	5293	5824	77.5	24	29.5	46	290	41.5	
88C84204LDRF	5329	5863	83.5	20	29.5	52.5	265	38	
88C84204LFRD	5329	5863	83.5	20	29.5	52.5	265	38	
88C84204LDRD	5329	5863	83.5	20	29.5	52.5	265	38	
88C84204LFRF	5329	5863	83.5	20	29.5	52.5	265	38	
88C84244LDRF	5407	5946	83.5	24	29.5	52.5	297	44.5	
88C84244LFRD	5407	5946	83.5	24	29.5	52.5	297	44.5	
88C84244LDRD	5407	5946	83.5	24	29.5	52.5	297	44.5	
88C84244LFRF	5407	5946	83.5	24	29.5	52.5	297	44.5	
88C96204LDRF	5556	6111	95.5	20	29.5	64.5	277	43	
88C96204LFRD	5556	6111	95.5	20	29.5	64.5	277	43	
88C96204LDRD	5556	6111	95.5	20	29.5	64.5	277	43	
88C96204LFRF	5556	6111	95.5	20	29.5	64.5	277	43	
88C96244LDRF	5633	6193	95.5	24	29.5	64.5	311	50.5	
88C96244LFRD	5633	6193	95.5	24	29.5	64.5	311	50.5	
88C96244LDRD	5633	6193	95.5	24	29.5	64.5	311	50.5	
88C96244LFRF	5633	6193	95.5	24	29.5	64.5	311	50.5	

**DIMENSION KEY**

W — width  
 D — depth  
 H — height of worksurface  
 KW— kneehole width

Dimensions are in inches and approximate.  
 Contact Customer Service if dimensions  
 are critical.

**CODE DESCRIPTION**

L - left-handed position  
 R - right-handed position  
 D - 2 file pedestal  
 F - 2 box, file pedestal

**STANDARD FINISHES**

For a complete list of standard wood  
 finishes, please see page 9.

**GROMMETS**

One grommet in a standard position is  
 optional at no charge. See page 12 for more  
 information.

# ADESSO | DESK HEIGHT CREDENZAS

Description	Model	Oak			W	D	H	KW	Shipping Weight	Cubic Feet
		Cherry	Anigre	Maple						
Single Pedestal Credenza	88C60204LDR0	4539	4994		59.5	20	29.5	42.5	172	27.5
	88C60204LFR0	4539	4994		59.5	20	29.5	42.5	172	27.5
	88C60204LORD	4539	4994		59.5	20	29.5	42.5	172	27.5
	88C60204LORF	4539	4994		59.5	20	29.5	42.5	172	27.5
	88C60244LDR0	4574	5033		59.5	24	29.5	42.5	192	32.5
	88C60244LFR0	4574	5033		59.5	24	29.5	42.5	192	32.5
	88C60244LORD	4574	5033		59.5	24	29.5	42.5	192	32.5
	88C60244LORF	4574	5033		59.5	24	29.5	42.5	192	32.5
	88C66204LDR0	4595	5054		65.5	20	29.5	48.5	180	30
	88C66204LFR0	4595	5054		65.5	20	29.5	48.5	180	30
	88C66204LORD	4595	5054		65.5	20	29.5	48.5	180	30
	88C66204LORF	4595	5054		65.5	20	29.5	48.5	180	30
	88C66244LDR0	4631	5093		65.5	24	29.5	48.5	200	35
	88C66244LFR0	4631	5093		65.5	24	29.5	48.5	200	35
	88C66244LORD	4631	5093		65.5	24	29.5	48.5	200	35
	88C66244LORF	4631	5093		65.5	24	29.5	48.5	200	35
	88C72204LDR0	4648	5112		71.5	20	29.5	54.5	187	33
	88C72204LFR0	4648	5112		71.5	20	29.5	54.5	187	33
	88C72204LORD	4648	5112		71.5	20	29.5	54.5	187	33
	88C72204LORF	4648	5112		71.5	20	29.5	54.5	187	33
	88C72244LDR0	4684	5153		71.5	24	29.5	54.5	209	38.5
	88C72244LFR0*	4684	5153		71.5	24	29.5	54.5	209	38.5
	88C72244LORD	4684	5153		71.5	24	29.5	54.5	209	38.5
	88C72244LORF	4684	5153		71.5	24	29.5	54.5	209	38.5
	88C78204LDR0	4705	5173		77.5	20	29.5	60.5	195	35.5
	88C78204LFR0	4705	5173		77.5	20	29.5	60.5	195	35.5
	88C78204LORD	4705	5173		77.5	20	29.5	60.5	195	35.5
	88C78204LORF	4705	5173		77.5	20	29.5	60.5	195	35.5
	88C78244LDR0	4738	5214		77.5	24	29.5	60.5	217	41.25
	88C78244LFR0	4738	5214		77.5	24	29.5	60.5	217	41.25
	88C78244LORD	4738	5214		77.5	24	29.5	60.5	217	41.25
	88C78244LORF	4738	5214		77.5	24	29.5	60.5	217	41.25
	88C84204LDR0	4757	5233		83.5	20	29.5	66.5	202	38
	88C84204LFR0	4757	5233		83.5	20	29.5	66.5	202	38
	88C84204LORD	4757	5233		83.5	20	29.5	66.5	202	38
	88C84204LORF	4757	5233		83.5	20	29.5	66.5	202	38
	88C84244LDR0	4793	5273		83.5	24	29.5	66.5	226	44.5
	88C84244LFR0	4793	5273		83.5	24	29.5	66.5	226	44.5
	88C84244LORD	4793	5273		83.5	24	29.5	66.5	226	44.5
	88C84244LORF	4793	5273		83.5	24	29.5	66.5	226	44.5
	88C96204LDR0	4874	5363		95.5	20	29.5	78.5	217	43
	88C96204LFR0*	4874	5363		95.5	20	29.5	78.5	217	43
	88C96204LORD	4874	5363		95.5	20	29.5	78.5	217	43
	88C96204LORF	4874	5363		95.5	20	29.5	78.5	217	43
	88C96244LDR0	4928	5420		95.5	24	29.5	78.5	243	50.5
	88C96244LFR0	4928	5420		95.5	24	29.5	78.5	243	50.5
	88C96244LORD	4928	5420		95.5	24	29.5	78.5	243	50.5
	88C96244LORF	4928	5420		95.5	24	29.5	78.5	243	50.5



**ORDERING NOTES:**

For the hinged modesty panel option add Y after C and add a 10% upcharge. e.g. 88CY6024LORD. Optional grommets are available in modesty panels for cable management. Half gables are required for additional support for unsupported spans greater than 60", please see page 107 for model number and list price. Pedestals with box and file drawers are available with a soft-closing drawer option. Please add "S" to the model # and **\$152 list** per pedestal. e.g.88C6024LDRFS. Lateral file drawers are not available with this option.

**ORDERING PROCEDURE**

- To order, please specify the following:
- 1) Krug product model number
  - 2) Wood species and finish
  - 3) Grommet location and style if applicable.

\* Indicates model illustrated by line drawing

**CODE DESCRIPTION**

- 4 - full height pedestal
- L - left-handed pedestal position
- R - right-handed pedestal position
- D - 2 file drawers
- F - 2 box, 1 file drawer
- Y - hinged modesty

**STANDARD FINISHES**

For a complete list of standard wood finishes, please see page 9.

**GROMMETS**

One grommet in a standard position is optional at no charge. See page 12 for more information.

# ADESSO | DESK HEIGHT CREDENZAS

Description	Model	Oak		W	D	H	KW	Shipping Weight	Cubic Feet
		Cherry Maple	Anigre Walnut						
Single Pedestal	88C60204L3001R0	4127	4537	59.75	20	29.5	28	197	28
Credenza Lateral	88C60204L0R3001	4127	4537	59.75	20	29.5	28	197	28
File or Bookcase	88C60204L0R3011	4203	4620	59.75	20	29.5	28	197	28
with Modesty Panel	88C60204L3011R0	4203	4620	59.75	20	29.5	28	197	28
	88C60244L3001R0	4171	4588	59.75	24	29.5	28	217	32
	38C60244L0R3001	4171	4588	59.75	24	29.5	28	217	32
	38C60244L3011R0	4245	4669	59.75	24	29.5	28	217	32
	38C60244L0R3011	4245	4669	59.75	24	29.5	28	217	32
	38C66204L3601R0	4208	4631	65.75	20	29.5	28	205	30
	38C66204L0R3601	4208	4631	65.75	20	29.5	28	205	30
	38C66204L3611R0	4284	4711	67.75	20	29.5	28	205	30
	38C66204L0R3611	4284	4711	65.75	20	29.5	28	205	30
	38C66244L3601R0	4252	4679	65.75	24	29.5	28	225	35
	88C66244L0R3601	4252	4679	65.75	24	29.5	28	225	35
	88C66244L3611R0	4321	4754	67.75	24	29.5	28	225	35
	88C66244L0R3611	4321	4754	65.75	24	29.5	28	225	35
	88C72204L3601R0*	4291	4720	71.5	20	29.5	36	212	32.75
	88C72204L0R3601	4291	4720	71.5	20	29.5	36	212	32.75
	88C72204L3611R0	4366	4801	71.5	20	29.5	36	212	32.75
	88C72204L0R3611	4366	4801	71.5	20	29.5	36	212	32.75
	88C72244L3601R0	4336	4769	71.5	24	29.5	36	234	38.25
	88C72244L0R3601	4336	4769	71.5	24	29.5	36	234	38.25
	88C72244L3611R0	4414	4855	71.5	24	29.5	36	234	38.25
	88C72244L0R3611	4414	4855	71.5	24	29.5	36	234	38.25
	88C78204L3601R0	4381	4819	77.5	20	29.5	40	227	35.5
	88C78204L0R3601	4381	4819	77.5	20	29.5	40	227	35.5
	88C78204L3611R0	4457	4902	77.5	20	29.5	40	227	35.5
	88C78204L0R3611	4457	4902	77.5	20	29.5	40	227	35.5
	88C78244L3601R0	4426	4868	77.5	24	29.5	40	251	41.25
	88C78244L0R3601	4426	4868	77.5	24	29.5	40	251	41.25
	88C78244L3611R0	4515	4968	77.5	24	29.5	40	251	41.25
	88C78244L0R3611	4515	4968	77.5	24	29.5	40	251	41.25
	88C84204L3601R0	4471	4920	83.5	20	29.5	46	242	38
	88C84204L0R3601	4471	4920	83.5	20	29.5	46	242	38
	88C84204L3611R0	4562	5017	83.5	20	29.5	46	242	38
	88C84204L0R3611	4562	5017	83.5	20	29.5	46	242	38
	88C84244L3601R0	4525	4977	83.5	24	29.5	46	268	44.25
	88C84244L0R3601	4525	4977	83.5	24	29.5	46	268	44.25
	88C84244L3611R0	4614	5077	83.5	24	29.5	46	268	44.25
	88C84244L0R3611	4614	5077	83.5	24	29.5	46	268	44.25

**ORDERING NOTES:**

For the hinged modesty panel option add Y after C and add a 10% upcharge. e.g. 88CY6024L0RD. Optional grommets are available in modesty panels for cable management. Half gables are required for additional support for unsupported spans greater than 60", please see page 107 for model number and list price. Add the suffix "P" to the end of the model number if Palette pedestals are required e.g. 88CP60243LFRFP. Pedestals are available with a soft-closing drawer option. Please add "S" to the model # and **\$152 list** per pedestal. e.g. 88C6024LDRFS.

**DIMENSION KEY**

W — width  
 D — depth  
 H — height of worksurface  
 KW— kneehole width

Dimensions are in inches and approximate. Contact Customer Service if dimensions are critical.

**CODE DESCRIPTION**

4 - full height pedestal  
 L - left-handed pedestal position  
 R - right-handed pedestal position  
 30 - 30" wide pedestal  
 36 - 36" wide pedestal  
 01 - lateral file  
 11 - closed storage  
 0 - no pedestal  
 Y - hinged modesty

**STANDARD FINISHES**

For a complete list of standard wood finishes, please see page 9.

**GROMMETS**

One grommet in a standard position is optional at no charge. See page 12 for more information.

# ADESSO | DESK HEIGHT CREDENZAS

Description	Model	Oak Cherry Maple	Anigre Walnut	W	D	H	KW	Shipping Weight	Cubic Feet
Single Pedestal	88C90204L3601R0	4576	5034	89.5	20	29.5	52	257	41
Credenza Lateral	88C90204LOR3601	4576	5034	89.5	20	29.5	52	257	41
File or Bookcase	88C90204L3611R0	4622	5084	89.5	20	29.5	52	257	41
with Modesty Panel,	88C90204LOR3611	4622	5084	89.5	20	29.5	52	257	41
continued	88C90244L3601R0	4637	5099	89.5	24	29.5	52	285	48
	88C90244LOR3601	4637	5099	89.5	24	29.5	52	285	48
	88C90244L3611R0	4683	5152	89.5	24	29.5	52	285	48
	88C90244LOR3611	4683	5152	89.5	24	29.5	52	285	48
	88C96204L3601R0*	4667	5135	95.5	20	29.5	58	272	43.5
	88C96204LOR3601	4667	5135	95.5	20	29.5	58	272	43.5
	88C96204L3611R0	4728	5201	95.5	20	29.5	58	272	43.5
	88C96204LOR3611	4728	5201	95.5	20	29.5	58	272	43.5
	88C96244L3601R0	4743	5217	95.5	24	29.5	58	302	51
	88C96244LOR3601	4743	5217	95.5	24	29.5	58	302	51
	88C96244L3611R0	4802	5284	95.5	24	29.5	58	302	51
	88C96244LOR3611	4802	5284	95.5	24	29.5	58	302	51
Single 36"	88C66204L3602R0	4291	4720	65.5	20	29.5	30	205	30
Combination	88C66204LOR3604	4291	4720	65.5	20	29.5	30	205	30
Ped Credenza with	88C66244L3602R0	4471	4920	65.5	24	29.5	30	225	35
Modesty Panel	88C66244LOR3604	4471	4920	65.5	24	29.5	30	225	35
	88C72204L3602R0	4486	4933	71.75	20	29.5	30	212	32.75
	88C72204LOR3604	4486	4933	71.75	24	29.5	30	234	38.25
	88C72244L3602R0	4653	5116	71.75	24	29.5	30	234	38.25
	88C72244LOR3604	4653	5116	71.75	24	29.5	30	234	38.25
	88C78204L3602R0	4878	5365	77.5	20	29.5	40	227	35.5
	88C78204LOR3604	4878	5365	77.5	20	29.5	40	227	35.5
	88C78244L3602R0	5012	5516	77.5	24	29.5	40	251	41.25
	88C78244LOR3604*	5012	5516	77.5	24	29.5	40	251	41.25
	88C84204L3602R0	5106	5614	83.5	20	29.5	46	242	38
	88C84204LOR3604	5106	5614	83.5	20	29.5	46	242	38
	88C84244L3602R0	5240	5762	83.5	24	29.5	46	268	44.25
	88C84244LOR3604	5240	5762	83.5	24	29.5	46	268	44.25
Full Face Desk	88C60204L3001R3001	5632	6192	59.75	20	29.5		288	28
Height Credenza	88C60204L3001R3011	5827	6409	59.75	20	29.5		257	28
	88C60204L3011R3001	5827	6409	59.75	20	29.5		257	28
	88C60204L3011R3011	6069	6674	59.75	20	29.5		226	28
	88C60244L3001R3001	5751	6325	59.75	24	29.5		312	32
	88C60244L3001R3011*	5946	6542	59.75	24	29.5		281	32
	88C60244L3011R3001	5946	6542	59.75	24	29.5		281	32
	88C60244L3011R3011	6337	6972	59.75	24	29.5		250	32
	88C72204L3601R3601	5992	6590	71.5	20	29.5		309	32.75
	88C72204L3601R3611	6187	6807	71.5	20	29.5		278	32.75
	88C72204L3611R3601	6187	6807	71.5	20	29.5		278	32.75
	88C72204L3611R3611	6580	7237	71.5	20	29.5		309	32.75
	88C72244L3601R3601	6141	6757	71.5	24	29.5		338	38.25
	88C72244L3601R3611	6337	6972	71.5	24	29.5		307	38.25
	88C72244L3611R3601	6337	6972	71.5	24	29.5		307	38.25
	88C72244L3611R3611	6731	7402	71.5	24	29.5		271	38.25

### ORDERING PROCEDURE

To order, please specify the following:

- 1) Krug product model number
- 2) Wood species and finish
- 3) Grommet location and style if applicable.

\* Indicates model illustrated by line drawing

### CODE DESCRIPTION

- 4 - full height pedestal
- L - left-handed pedestal position
- R - right-handed pedestal position
- 30 - 30" wide pedestal
- 36 - 36" wide pedestal
- 01 - lateral file
- 11 - closed storage
- 0 - no pedestal

### STANDARD FINISHES

For a complete list of standard wood finishes, please see page 9.

### GROMMETS





One grommet in a standard position is optional at no charge. See page 12 for more information.

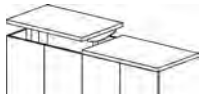

# ADESSO | 3/4 HEIGHT CREDENZAS

Description	Model	Oak Cherry Maple	Anigre Walnut	W	D	H	KW	Shipping Weight	Cubic Feet	
	Credenza with	88C6024LBRHAES	6846	7498	59.75	24	29.5	-	176	28
	Height Adjustable	88C6024LHAESRB*	6846	7498	59.75	24	29.5	-	192	28
	Electric Lift	88C6024LFRHAES	7482	8195	59.75	24	29.5	-	192	28
	(Single Stage)	88C6024LHAESRF	7482	8195	59.75	24	29.5	-	248	28
		88C7224LBRHAES	7833	8578	71.75	24	29.5	-	192	33
		88C7224LHAESRB	7833	8578	71.75	24	29.5	-	210	33
		88C7224LFRHAES	8207	8990	71.75	24	29.5	-	210	33
		88C7224LHAESRF	8207	8990	71.75	24	29.5	-	230	33

**ORDERING NOTE:** Height range of electric lift is 29.5" to 46.5".

3/4 Height Single Pedestal Credenza	88C60203L3011R0*	4442	4887	59.75	20	23	28	153	21
	88C60203L0R3011	4442	4887	59.75	20	23	28	153	21
	88C60203L3015R0	4336	4769	59.75	20	23	28	167	21
	88C60203L0R3015	4336	4769	59.75	20	23	28	167	21
	88C60203L3016R0****	4171	4588	59.75	20	23	28	171	21
	88C60203L0R3016	4171	4588	59.75	20	23	28	171	21
	88C60203L3017R0***	4291	4720	59.75	20	23	28	143	21
	88C60203L0R3017	4291	4720	59.75	20	23	28	143	21
	88C60203L3018R0**	4503	4952	59.75	20	23	28	150	21
	88C60203L0R3018	4503	4952	59.75	20	23	28	150	21
	88C60243L3011R0	4592	5052	59.75	24	23	28	175	25
	88C60243L0R3011	4592	5052	59.75	24	23	28	175	25
	88C60243L3015R0	4486	4933	59.75	24	23	28	186	25
	88C60243L0R3015	4486	4933	59.75	24	23	28	186	25
	88C60243L3016R0	4321	4754	59.75	24	23	28	188	25
	88C60243L0R3016	4321	4754	59.75	24	23	28	188	25
	88C60243L3017R0	4442	4887	59.75	24	23	28	165	25
	88C60243L0R3017	4442	4887	59.75	24	23	28	165	25
	88C60243L3018R0	4653	5116	59.75	24	23	28	172	25
	88C60243L0R3018	4653	5116	59.75	24	23	28	172	25
	88C66203L3011R0	4592	5052	65.5	20	23	34	153	21
	88C66203L0R3011	4592	5052	65.5	20	23	34	153	21
	88C66203L3015R0	4486	4933	65.5	20	23	34	167	21
	88C66203L0R3015	4486	4933	65.5	20	23	34	167	21
	88C66203L3016R0	4321	4754	65.5	20	23	34	171	21
	88C66203L0R3016	4321	4754	65.5	20	23	34	171	21
	88C66203L3017R0	4442	4887	65.5	20	23	34	143	21
	88C66203L0R3017	4442	4887	65.5	20	23	34	143	21
	88C66203L3018R0	4653	5116	65.5	20	23	34	150	21
	88C66203L0R3018	4653	5116	65.5	20	23	34	150	21
	88C66243L3011R0	4743	5217	65.5	24	23	34	175	25
	88C66243L0R3011	4743	5217	65.5	24	23	34	175	25
	88C66243L3015R0	4637	5099	65.5	24	23	34	186	25
	88C66243L0R3015	4637	5099	65.5	24	23	34	186	25
88C66243L3016R0	4471	4920	65.5	24	23	34	188	25	
88C66243L0R3016	4471	4920	65.5	24	23	34	188	25	

**ORDERING NOTES:** For the hinged modesty panel option add Y after C and add a 10% upcharge. e.g. 88CY60243L0R3011. If a runoff with power/data option is to be mounted onto a 3/4 height credenza please specify location ML -Mounted Left or MR-Mounted Right. This will ensure that access grommets will be drilled in the credenza top and back. Pedestals with box and file drawers are available with a soft-closing drawer option. Please add "S" to the model # and **\$152 list** per pedestal. e.g. 88C6024LDRFS. Lateral file drawers are not available with this option.

**DIMENSION KEY**

W — width  
 D — depth  
 H — height of worksurface  
 KW— kneehole width

Dimensions are in inches and approximate. Contact Customer Service if dimensions are critical.

**CODE DESCRIPTION**

3 - 3/4 height pedestal  
 L - left-handed pedestal position  
 R - right-handed pedestal position  
 B - bookcase  
 30 - 30" wide pedestal  
 36 - 36" wide pedestal  
 11 - closed storage  
 15 - open, lateral file  
 16 - box, lateral file  
 17 - bookcase  
 18 - open, closed bookcase

**STANDARD FINISHES**

For a complete list of standard wood finishes, please see page 9.

**GROMMETS**

One grommet in a standard position is optional at no charge. See page 12 for more information.

# ADESSO | 3/4 HEIGHT CREDENZAS

Description	Model	Oak		W	D	H	KW	Shipping Weight	Cubic Feet
		Cherry Maple	Anigre Walnut						
3/4 Height Single Pedestal Credenza	88C66243L3017R0	4592	5052	65.5	24	23	34	165	25
cont.	88C66243L0R3017	4592	5052	65.5	24	23	34	165	25
	88C66243L3018R0	4802	5284	65.5	24	23	34	172	25
	88C66243L0R3018	4802	5284	65.5	24	23	34	172	25
	88C72203L3611R0*	4743	5217	71.5	20	23	34	176	25.5
	88C72203L0R3611	4743	5217	71.5	20	23	34	176	25.5
	88C72203L3615R0****	4637	5099	71.5	20	23	34	191	25.5
	88C72203L0R3615	4637	5099	71.5	20	23	34	191	25.5
	88C72203L3616R0***	4471	4920	71.5	20	23	34	195	25.5
	88C72203L0R3616	4471	4920	71.5	20	23	34	195	25.5
	88C72203L3617R0**	4592	5052	71.5	20	23	34	164	25.5
	88C72203L0R3617	4592	5052	71.5	20	23	34	164	25.5
	88C72203L3618R0**	4802	5284	71.5	20	23	34	172	25.5
	88C72203L0R3618	4802	5284	71.5	20	23	34	172	25.5
	88C72243L3611R0	4893	5384	71.5	24	23	34	202	30
	88C72243L0R3611	4893	5384	71.5	24	23	34	202	30
	88C72243L3615R0	4788	5264	71.5	24	23	34	211	30
	88C72243L0R3615	4788	5264	71.5	24	23	34	211	30
	88C72243L3616R0***	4622	5084	71.5	24	23	34	215	30
	88C72243L0R3616	4622	5084	71.5	24	23	34	215	30
	88C72243L3617R0	4743	5217	71.5	24	23	34	189	30
	88C72243L0R3617	4743	5217	71.5	24	23	34	189	30
	88C72243L3618R0	4953	5448	71.5	24	23	34	199	30
	88C72243L0R3618	4953	5448	71.5	24	23	34	199	30
	88C78203L3611R0	4893	5384	77.5	20	23	40	185	27.5
	88C78203L0R3611	4893	5384	77.5	20	23	40	185	27.5
	88C78203L3615R0	4788	5264	77.5	20	23	40	199	27.5
	88C78203L0R3615	4788	5264	77.5	20	23	40	199	27.5
	88C78203L3616R0	4622	5084	77.5	20	23	40	203	27.5
	88C78203L0R3616	4622	5084	77.5	20	23	40	203	27.5
	88C78203L3617R0	4743	5217	77.5	20	23	40	172	27.5
	88C78203L0R3617	4743	5217	77.5	20	23	40	172	27.5
	88C78203L3618R0	4953	5448	77.5	20	23	40	180	27.5
	88C78203L0R3618	4953	5448	77.5	20	23	40	180	27.5
	88C78243L3611R0	5043	5548	77.5	24	23	40	211	32.5
	88C78243L0R3611	5043	5548	77.5	24	23	40	211	32.5
	88C78243L3615R0	4939	5430	77.5	24	23	40	220	32.5
	88C78243L0R3615	4939	5430	77.5	24	23	40	220	32.5
	88C78243L3616R0	4773	5250	77.5	24	23	40	225	32.5
	88C78243L0R3616	4773	5250	77.5	24	23	40	225	32.5
	88C78243L3617R0	4893	5384	77.5	24	23	40	198	32.5
	88C78243L0R3617	4893	5384	77.5	24	23	40	198	32.5
	88C78243L3618R0	5106	5614	77.5	24	23	40	209	32.5
	88C78243L0R3618	5106	5614	77.5	24	23	40	209	32.5
	88C84203L3611R0*	5043	5548	83.5	20	23	46	193	29.5
	88C84203L0R3611	5043	5548	83.5	20	23	46	193	29.5
	88C84203L3615R0	4939	5430	83.5	20	23	46	208	29.5
	88C84203L0R3615	4939	5430	83.5	20	23	46	208	29.5

**ORDERING NOTES:** For the hinged modesty panel option add Y after C and add a 10% upcharge. e.g. 88CY60243L0R3011. If a runoff with power/data option is to be mounted onto a 3/4 height credenza please specify location ML -Mounted Left or MR-Mounted Right. This will ensure that access grommets will be drilled in the credenza top and back. Pedestals with box and file drawers are available with a soft-closing drawer option. Please add "S" to the model # and **\$152 list** per pedestal. e.g. 88C6024LDRFS. Lateral file drawers are not available with this option.

**ORDERING PROCEDURE**

- To order, please specify the following:
- 1) Krug product model number
  - 2) Wood species and finish
  - 3) Grommet location and style if applicable.

\* Indicates model illustrated by line drawing

**CODE DESCRIPTION**

- 3 - 3/4 height pedestal
- L - left-handed pedestal position
- R - right-handed pedestal position
- 30 - 30" wide pedestal
- 36 - 36" wide pedestal
- 11 - closed storage
- 15 - open, lateral file
- 16 - box, lateral file
- 17 - bookcase
- 18 - open, closed bookcase

**STANDARD FINISHES**

For a complete list of standard wood finishes, please see page 9.

**GROMMETS**

One grommet in a standard position is optional at no charge. See page 12 for more information.

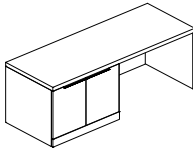
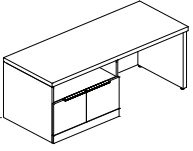
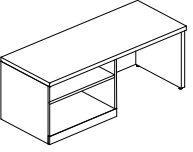
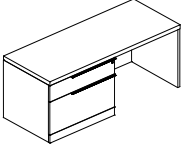
Description	Model	Oak		W	D	H	KW	Shipping Weight	Cubic Feet
		Cherry Maple	Anigre Walnut						
3/4 Height Single Pedestal Credenza	88C84203L3616R0****	4773	5250	83.5	20	23	46	212	29.5
	88C84203L0R3616	4773	5250	83.5	20	23	46	212	29.5
	88C84203L3617R0***	4893	5384	83.5	20	23	46	180	29.5
	88C84203L0R3617	4893	5384	83.5	20	23	46	180	29.5
	88C84203L3618R0**	5106	5614	83.5	20	23	46	189	29.5
	88C84203L0R3618	5106	5614	83.5	20	23	46	189	29.5
	88C84243L3611R0	5194	5715	83.5	24	23	46	221	35
	88C84243L0R3611	5194	5715	83.5	24	23	46	221	35
	88C84243L3615R0	5087	5598	83.5	24	23	46	230	35
	88C84243L0R3615	5087	5598	83.5	24	23	46	230	35
	88C84243L3616R0	4923	5416	83.5	24	23	46	235	35
	88C84243L0R3616	4923	5416	83.5	24	23	46	235	35
	88C84243L3617R0	5043	5548	83.5	24	23	46	208	35
	88C84243L0R3617	5043	5548	83.5	24	23	46	208	35
	88C84243L3618R0	5256	5781	83.5	24	23	46	218	35
	88C84243L0R3618	5256	5781	83.5	24	23	46	218	35
	88C90203L3611R0	5345	5881	89.5	20	23	52	201	31.5
	88C90203L0R3611	5345	5881	89.5	20	23	52	201	31.5
	88C90203L3615R0	5240	5762	89.5	20	23	52	216	31.5
	88C90203L0R3615	5240	5762	89.5	20	23	52	216	31.5
	88C90203L3616R0	5075	5582	89.5	20	23	52	221	31.5
	88C90203L0R3616	5075	5582	89.5	20	23	52	221	31.5
	88C90203L3617R0	5194	5715	89.5	20	23	52	189	31.5
	88C90203L0R3617	5194	5715	89.5	20	23	52	189	31.5
	88C90203L3618R0	5406	5945	89.5	20	23	52	197	31.5
	88C90203L0R3618	5406	5945	89.5	20	23	52	197	31.5
	88C90243L3611R0	5496	6045	89.5	24	23	52	230	37
	88C90243L0R3611	5496	6045	89.5	24	23	52	230	37
	88C90243L3615R0	5390	5929	89.5	24	23	52	239	37
	88C90243L0R3615	5390	5929	89.5	24	23	52	239	37
	88C90243L3616R0	5223	5746	89.5	24	23	52	244	37
	88C90243L0R3616	5223	5746	89.5	24	23	52	244	37
	88C90243L3617R0	5345	5881	89.5	24	23	52	217	37
	88C90243L0R3617	5345	5881	89.5	24	23	52	217	37
	88C90243L3618R0	5556	6111	89.5	24	23	52	227	37
	88C90243L0R3618	5556	6111	89.5	24	23	52	227	37

**ORDERING NOTES:** For the hinged modesty panel option add Y after C and add a 10% upcharge. e.g. 88CY60243L0R3011. If a runoff with power/data option is to be mounted onto a 3/4 height credenza please specify location ML -Mounted Left or MR-Mounted Right. This will ensure that access grommets will be drilled in the credenza top and back. Pedestals with box and file drawers are available with a soft-closing drawer option. Please add "S" to the model # and **\$152 list** per pedestal. e.g. 88C6024LDRFS. Lateral file drawers are not available with this option.

**Height Adjustable** - To specify with Height Adjustable Desk as a Runoff add "H" after the designated pedestal position and **\$261 list**. Example: 88C90243L0RH3618

**DIMENSION KEY**

- W — width
- D — depth
- H — height of worksurface
- KW— kneehole width

Dimensions are in inches and approximate. Contact Customer Service if dimensions are critical.



**STANDARD FINISHES**

For a complete list of standard wood finishes, please see page 9.

**GROMMETS**

One grommet in a standard position is optional at no charge. See page 12 for more information.

# ADESSO | 3/4 HEIGHT CREDENZAS

Description	Model	Oak		W	D	H	KW	Shipping Weight	Cubic Feet
		Cherry Maple	Anigre Walnut						
 3/4 Height Single Pedestal Credenza	88C96203L3611R0*	5646	6211	95.5	20	23	58	210	36.5
	88C96203L0R3611	5646	6211	95.5	20	23	58	210	36.5
	88C96203L3615R0****	5539	6093	95.5	20	23	58	224	36.5
	* 88C96203L0R3615	5539	6093	95.5	20	23	58	224	36.5
	88C96203L3616R0***	5373	5913	95.5	20	23	58	229	36.5
	88C96203L0R3616	5373	5913	95.5	20	23	58	229	36.5
	88C96203L3617R0	5496	6045	95.5	20	23	58	197	36.5
	88C96203L0R3617	5496	6045	95.5	20	23	58	197	36.5
	88C96203L3618R0**	5706	6277	95.5	20	23	58	206	36.5
	88C96203L0R3618	5706	6277	95.5	20	23	58	206	36.5
	88C96243L3611R0	5796	6375	95.5	24	23	58	240	40
	88C96243L0R3611	5796	6375	95.5	24	23	58	240	40
	88C96243L3615R0	5691	6260	95.5	24	23	58	249	40
	88C96243L0R3615	5691	6260	95.5	24	23	58	249	40
	88C96243L3616R0	5527	6078	95.5	24	23	58	254	40
	88C96243L0R3616	5527	6078	95.5	24	23	58	254	40
	88C96243L3617R0	5646	6211	95.5	24	23	58	227	40
	88C96243L0R3617	5646	6211	95.5	24	23	58	227	40
	88C96243L3618R0	5857	6441	95.5	24	23	58	237	40
	88C96243L0R3618	5857	6441	95.5	24	23	58	237	40
 Full Face 3/4 Height Credenza	88C60203L3011R3011	6007	6608	59.75	20	23		186	21.5
	88C60203L3011R3015	5796	6375	59.75	20	23		196	21.5
	88C60203L3011R3016*	5796	6375	59.75	20	23		196	21.5
	88C60203L3011R3017	5660	6227	59.75	20	23		171	21.5
	88C60203L3011R3018	6007	6608	59.75	20	23		186	21.5
	88C60203L3015R3011	5796	6375	59.75	20	23		196	21.5
	88C60203L3016R3011	5796	6375	59.75	20	23		196	21.5
	88C60203L3017R3011	5660	6227	59.75	20	23		171	21.5
	88C60203L3018R3011	6007	6608	59.75	20	23		186	21.5
	88C60203L3016R3016	5450	5994	59.75	20	23		207	21.5
	88C60203L3016R3015	5450	5994	59.75	20	23		207	21.5
	88C60203L3016R3017	5646	6211	59.75	20	23		179	21.5
	88C60203L3016R3018	5796	6375	59.75	20	23		196	21.5
	88C60203L3015R3016	5450	5994	59.75	20	23		207	21.5
	88C60203L3017R3016	5646	6211	59.75	20	23		179	21.5
	88C60203L3018R3016	5796	6375	59.75	20	23		196	21.5
	88C60203L3017R3017	5316	5847	59.75	20	23		156	21.5
	88C60203L3017R3015	5646	6211	59.75	20	23		179	21.5
	88C60203L3017R3018	5660	6227	59.75	20	23		171	21.5
	88C60203L3015R3017	5646	6211	59.75	20	23		179	21.5
88C60203L3018R3017	5660	6227	59.75	20	23		171	21.5	
88C60203L3018R3015	5796	6375	59.75	20	23		196	21.5	
88C60203L3015R3018	5796	6375	59.75	20	23		196	21.5	
88C60243L3011R3011	6158	6772	59.75	24	23		193	25	
88C60243L3011R3015	5946	6542	59.75	24	23		204	25	
88C60243L3011R3016	5946	6542	59.75	24	23		204	25	
88C60243L3011R3017	5811	6391	59.75	24	23		178	25	
88C60243L3011R3018	6158	6772	59.75	24	23		193	25	

**ORDERING NOTES:** The -15 open/file module can be used in place of the -16 box/file module at the same price. The -18 open/closed module can be used in place of the -11 closed module at the same price. Please contact customer service for other available combinations. Pedestals with box and file drawers are available with a soft-closing drawer option. Please add "S" to the model # and **\$152 list** per pedestal. e.g.88C6024LDRFS. Lateral file drawers are not available with this option.

**ORDERING PROCEDURE**

- To order, please specify the following:
- 1) Krug product model number
  - 2) Wood species and finish
  - 3) Grommet location and style if applicable.

\* Indicates model illustrated by line drawing

**CODE DESCRIPTION**

- 3 - 3/4 height credenza
- L - left-handed position
- R - right-handed position
- 30 - 30" wide pedestal
- 36 - 36" wide pedestal
- 11 - closed bookcase
- 15 - open, lateral file
- 16 - box, lateral file
- 17 - bookcase
- 18 - open, closed bookcase

**STANDARD FINISHES**

For a complete list of standard wood finishes, please see page 9.

**GROMMETS**

One grommet in a standard position is optional at no charge. See page 12 for more information.

# ADESSO | 3/4 HEIGHT CREDENZAS

Description	Model	Oak Cherry Maple	Anigre Walnut	W	D	H	Shipping Weight	Cubic Feet
Full Face 3/4 Height Credenza, Continued	88C60243L3015R3011	5946	6542	59.75	24	23	204	25
	88C60243L3015R3016	5602	6161	59.75	24	23	214	25
	88C60243L3015R3017	5796	6375	59.75	24	23	186	25
	38C60243L3015R3018	5946	6542	59.75	24	23	204	25
	38C60243L3016R3011	5946	6542	59.75	24	23	204	25
	38C60243L3016R3016	5602	6161	59.75	24	23	214	25
	38C60243L3016R3015	5602	6161	59.75	24	23	214	25
	38C60243L3016R3017	5796	6375	59.75	24	23	186	25
	38C60243L3016R3018	5946	6542	59.75	24	23	204	25
	38C60243L3017R3011	5811	6391	59.75	24	23	178	25
	38C60243L3017R3015	5796	6375	59.75	24	23	186	25
	88C60243L3017R3016*	5796	6375	59.75	24	23	186	25
	88C60243L3017R3017	5466	6012	59.75	24	23	163	25
	88C60243L3017R3018	5811	6391	59.75	24	23	178	25
	88C60243L3018R3011	6158	6772	59.75	24	23	193	25
	88C60243L3018R3017	5811	6391	59.75	24	23	178	25
	88C60243L3018R3015	5946	6542	59.75	24	23	204	25
	88C60243L3018R3016	5946	6542	59.75	24	23	204	25
	88C72203L3611R3611	6308	6939	71.5	24	23	197	25.5
	88C72203L3611R3615	6098	6708	71.5	20	23	208	25.5
	88C72203L3611R3616	6098	6708	71.5	20	23	208	25.5
	88C72203L3611R3617	5962	6557	71.5	20	23	182	25.5
	88C72203L3611R3618	6308	6939	71.5	20	23	197	25.5
	88C72203L3615R3611	6098	6708	71.5	20	23	208	25.5
	88C72203L3616R3611	6098	6708	71.5	20	23	208	25.5
	88C72203L3617R3611	5962	6557	71.5	20	23	182	25.5
	88C72203L3618R3611	6308	6939	71.5	20	23	197	25.5
	88C72203L3616R3615	5751	6325	71.5	20	23	197	25.5
	88C72203L3616R3616	5751	6325	71.5	20	23	220	25.5
	88C72203L3616R3617	5946	6542	71.5	20	23	190	25.5
88C72203L3616R3618	6098	6708	71.5	20	23	208	25.5	
88C72203L3617R3616	5946	6542	71.5	20	23	190	25.5	
88C72203L3618R3616	6098	6708	71.5	20	23	208	25.5	
88C72203L3617R3617	5615	6180	71.5	20	23	167	25.5	
88C72203L3617R3615	5946	6542	71.5	20	23	190	25.5	
88C72203L3617R3618	5962	6557	71.5	20	23	182	25.5	
88C72203L3615R3617	5946	6542	71.5	20	23	190	25.5	
88C72203L3618R3617	5962	6557	71.5	20	23	182	25.5	
88C72203L3618R3615	6098	6708	71.5	20	23	208	25.5	
88C72203L3615R3618	6098	6708	71.5	20	23	208	25.5	
88C72243L3611R3611	6461	7105	71.5	24	23	200	30	
88C72243L3611R3615	6247	6872	71.5	24	23	216	30	
88C72243L3611R3616	6247	6872	71.5	24	23	216	30	
88C72243L3611R3617	6112	6722	71.5	24	23	185	30	
88C72243L3611R3618	6461	7105	71.5	24	23	200	30	
88C72243L3615R3611	6247	6872	71.5	24	23	216	30	
88C72243L3616R3611	6247	6872	71.5	24	23	216	30	
88C72243L3617R3611	6112	6722	71.5	24	23	185	30	
88C72243L3618R3611	6461	7105	71.5	24	23	200	30	

**ORDERING NOTES:** The -15 open/file module can be used in place of the -16 box/file module at the same price. The -18 open/closed module can be used in place of the -11 closed module at the same price. Please contact customer service for other available combinations. Pedestals with box and file drawers are available with a soft-closing drawer option. Please add "S" to the model # and **\$152 list** per pedestal. e.g.88C6024LDRFS. Lateral file drawers are not available with this option.

**DIMENSION KEY**

W — width  
 D — depth  
 H — height of worksurface  
 KW— kneehole width

Dimensions are in inches and approximate.  
 Contact Customer Service if dimensions are critical.

**CODE DESCRIPTION**

3 - 3/4 height credenza  
 L - left-handed position  
 R - right-handed position  
 30 - 30" wide pedestal  
 36 - 36" wide pedestal  
 11 - closed bookcase  
 15 - top open, lateral file  
 16 - box, lateral file  
 17 - bookcase  
 18 - top open, closed bookcase

**STANDARD FINISHES**

For a complete list of standard wood finishes, please see page 9.

**GROMMETS**

One grommet in a standard position is optional at no charge. See page 12 for more information.

# ADESSO | 3/4 HEIGHT CREDENZAS

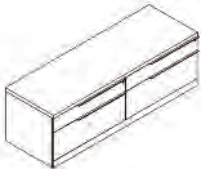
Description	Model	Oak Cherry Maple	Anigre Walnut	W	D	H	Shipping Weight	Cubic Feet
Full Face 3/4 Height Credenza, Continued	88C72243L3616R3616	5902	6493	71.5	24	23	227	30
	88C72243L3616R3615	5902	6493	71.5	24	23	227	30
	88C72243L3616R3617	6098	6708	71.5	24	23	197	30
	88C72243L3616R3618	6247	6872	71.5	24	23	216	30
	88C72243L3615R3616	5902	6493	71.5	24	23	227	30
	88C72243L3617R3616	6098	6708	71.5	24	23	197	30
	88C72243L3618R3616	6247	6872	71.5	24	23	216	30
	88C72243L3617R3617	5766	6343	71.5	24	23	170	30
	88C72243L3617R3615	6098	6708	71.5	24	23	197	30
	88C72243L3617R3618	6112	6722	71.5	24	23	185	30
	88C72243L3615R3617	6098	6708	71.5	24	23	197	30
	88C72243L3618R3617	6112	6722	71.5	24	23	185	30
	88C72243L3618R3615	6247	6872	71.5	24	23	216	30
	88C72243L3615R3618	6247	6872	71.5	24	23	216	30
	88C84203L2411C3015R3016	6744	7418	83.5	20	23	293	29.5
	88C84203L2411C3016R3011	7016	7715	83.5	20	23	276	29.5
	88C84203L2411C3016R3015	6744	7418	83.5	20	23	293	29.5
	88C84203L2411C3016R3016	6744	7418	83.5	20	23	293	29.5
	88C84203L2411C3016R3017*	6881	7569	83.5	20	23	266	29.5
	88C84203L2411C3017R3011	7152	7866	83.5	20	23	269	29.5
	88C84203L2411C3017R3016	6881	7569	83.5	20	23	269	29.5
	88C84203L3011C3016R2411	7016	7715	83.5	20	23	276	29.5
88C84203L3011C3017R2411	7152	7866	83.5	20	23	269	29.5	
88C84203L3011C3018R2411	7152	7866	83.5	20	23	284	29.5	
88C84203L3015C3016R2411	6744	7418	83.5	20	23	293	29.5	
88C84203L3016C3015R2411	6744	7418	83.5	20	23	293	29.5	
88C84203L3016C3016R2411	6744	7418	83.5	20	23	293	29.5	
88C84203L3016C3017R2411	6881	7569	83.5	20	23	266	29.5	
88C84203L3017C3016R2411	6881	7569	83.5	20	23	266	29.5	
88C84243L2411C3015R3016	6895	7585	83.5	24	23	328	35	
88C84243L2411C3016R3011	7164	7882	83.5	24	23	315	35	
88C84243L2411C3016R3015	6895	7585	83.5	24	23	328	35	
88C84243L2411C3016R3016	6895	7585	83.5	24	23	328	35	
88C84243L2411C3016R3017	7031	7733	83.5	24	23	305	35	
88C84243L2411C3017R3011	7302	8032	83.5	24	23	269	35	
88C84243L2411C3017R3016	7031	7733	83.5	24	23	305	35	
88C84243L3011C3016R2411	7164	7882	83.5	24	23	315	35	
88C84243L3011C3017R2411	7302	8032	83.5	24	23	269	35	
88C84243L3011C3018R2411	7302	8032	83.5	24	23	284	35	
88C84243L3015C3016R2411*	6895	7585	83.5	24	23	328	35	
88C84243L3016C3015R2411	6895	7585	83.5	24	23	328	35	
88C84243L3016C3016R2411	6895	7585	83.5	24	23	328	35	
88C84243L3016C3017R2411	7031	7733	83.5	24	23	305	35	
88C84243L3017C3016R2411	7031	7733	83.5	24	23	305	35	
88C90203L3011C3015R3017	7709	8478	89.5	20	23	271	32	
88C90203L3011C3016R3017	7709	8478	89.5	20	23	271	32	
88C90203L3011C3017R3015	7709	8478	89.5	20	23	271	32	
88C90203L3011C3017R3016	7709	8478	89.5	20	23	271	32	

**ORDERING NOTES:**

The -15 open/file module can be used in place of the -16 box/file module at the same price.  
 The -18 open/closed module can be used in place of the -11 closed module at the same price.  
 Please contact customer service for other available combinations. Pedestals with box and file drawers are available with a soft-closing drawer option. Please add "S" to the model # and **\$152 list** per pedestal. e.g.88C6024LDRFS. Lateral file drawers are not available with this option.

**ORDERING PROCEDURE**

To order, please specify the following:  
 1) Krug product model number  
 2) Wood species and finish  
 3) Grommet location and style if applicable.

\* Indicates model illustrated by line drawing

**CODE DESCRIPTION**

- 3 - 3/4 height credenza
- L - left-handed position
- R - right-handed position
- 30 - 30" wide pedestal
- 36 - 36" wide pedestal
- 11 - closed bookcase
- 15 - top open, lateral file
- 16 - box, lateral file
- 17 - bookcase
- 18 - top open, closed bookcase

**STANDARD FINISHES**

For a complete list of standard wood finishes, please see page 9.

**GROMMETS**

One grommet in a standard position is optional at no charge. See page 12 for more information.

# ADESSO | 3/4 HEIGHT CREDENZAS

Description	Model	Oak Cherry Maple	Anigre Walnut	W	D	H	Shipping Weight	Cubic Feet
Full Face 3/4 Height Credenza, Continued	88C90203L3011C3018R3011	8010	8810	89.5	20	23	274	32
	88C90203L3011C3018R3015	7843	8627	89.5	20	23	274	32
	88C90203L3011C3018R3016	7843	8627	89.5	20	23	271	32
	88C90203L3011C3018R3017	7873	8661	89.5	20	23	274	32
	88C90203L3011C3018R3018	8010	8810	89.5	20	23	274	32
	88C90203L3015C3011R3011	7843	8627	89.5	20	23	286	32
	88C90203L3015C3011R3015	7679	8446	89.5	20	23	318	32
	88C90203L3015C3011R3016	7679	8446	89.5	20	23	318	32
	88C90203L3015C3011R3017	7709	8478	89.5	20	23	271	32
	88C90203L3015C3011R3018	7843	8627	89.5	20	23	271	32
	88C90203L3015C3015R3011	7679	8446	89.5	20	23	318	32
	88C90203L3015C3015R3016	7393	8131	89.5	20	23	311	32
	88C90203L3015C3015R3017	7543	8296	89.5	20	23	300	32
	88C90203L3015C3015R3018	7679	8446	89.5	20	23	318	32
	88C90203L3015C3016R3011*	7679	8446	89.5	20	23	318	32
	88C90203L3015C3016R3015	7393	8131	89.5	20	23	311	32
	88C90203L3015C3017R3015	7453	8198	89.5	20	23	300	32
	88C90203L3015C3017R3016	7453	8198	89.5	20	23	300	32
	88C90203L3015C3018R3015	7679	8446	89.5	20	23	318	32
	88C90203L3016C3016R3016	7393	8131	89.5	20	23	311	32
	88C90203L3016C3017R3011	7709	8478	89.5	20	23	271	32
	88C90203L3016C3017R3016	7543	8296	89.5	20	23	300	32
	88C90203L3016C3017R3018	7709	8478	89.5	20	23	271	32
	88C90203L3017C3016R3011	7709	8478	89.5	20	23	271	32
	88C90203L3018C3011R3018	8010	8810	89.5	20	23	274	32
	88C90203L3018C3015R3018	7843	8627	89.5	20	23	274	32
	88C90203L3018C3017R3015	7709	8478	89.5	20	23	271	32
	88C90203L3018C3017R3016	7709	8478	89.5	20	23	271	32
	88C90203L3018C3017R3018	7873	8661	89.5	20	23	264	32
	88C90203L3018C3018R3011	8010	8810	89.5	20	23	264	32
	88C90243L3011C3015R3017	7766	8544	89.5	24	23	282	37
	88C90243L3011C3016R3017	7766	8544	89.5	24	23	282	37
	88C90243L3011C3017R3015	7766	8544	89.5	24	23	282	37
	88C90243L3011C3017R3016	7766	8544	89.5	24	23	282	37
	88C90243L3011C3018R3011	8070	8875	89.5	24	23	271	37
	88C90243L3011C3018R3015	7965	8760	89.5	24	23	292	37
	88C90243L3011C3018R3016	7965	8760	89.5	24	23	300	37
	88C90243L3011C3018R3017	7934	8727	89.5	24	23	260	37
	88C90243L3011C3018R3018	8070	8875	89.5	24	23	271	37
	88C90243L3015C3011R3011	7965	8760	89.5	24	23	292	37
88C90243L3015C3011R3015	7785	8562	89.5	24	23	304	37	
88C90243L3015C3011R3016	7785	8562	89.5	24	23	314	37	
88C90243L3015C3011R3017	7766	8544	89.5	24	23	282	37	
88C90243L3015C3011R3018	7965	8760	89.5	24	23	292	37	
88C90243L3015C3015R3011	7785	8562	89.5	24	23	304	37	
88C90243L3015C3015R3016	7572	8330	89.5	24	23	312	37	
88C90243L3015C3015R3017	7679	8446	89.5	24	23	293	37	
88C90243L3015C3015R3018	7785	8562	89.5	24	23	304	37	



**ORDERING NOTES:**

The -15 open/file module can be used in place of the -16 box/file module at the same price.

The -18 open/closed module can be used in place of the -11 closed module at the same price.

Please contact customer service for other available combinations. Pedestals with box and file drawers are available with a soft-closing drawer option. Please add "S" to the model # and **\$152 list** per pedestal. e.g.88C6024LDRFS. Lateral file drawers are not available with this option.

**DIMENSION KEY**

W — width  
D — depth  
H — height of worksurface  
KW— kneehole width

Dimensions are in inches and approximate.  
Contact Customer Service if dimensions are critical.

**CODE DESCRIPTION**

3 - 3/4 height credenza  
L - left-handed position  
R - right-handed position  
30 - 30" wide pedestal  
36 - 36" wide pedestal  
11 - closed bookcase  
15 - top open, lateral file  
16 - box, lateral file  
17 - bookcase  
18 - top open, closed bookcase

**STANDARD FINISHES**

For a complete list of standard wood finishes, please see page 9.

**GROMMETS**

One grommet in a standard position is optional at no charge. See page 12 for more information.

# ADESSO | 3/4 HEIGHT CREDENZAS

Description	Model	Oak		W	D	H	Shipping Weight	Cubic Feet
		Cherry Maple	Anigre Walnut					
	88C90243L3015C3016R3011	7785	8562	89.5	24	23	318	37
	88C90243L3015C3016R3015	7572	8330	89.5	24	23	312	37
	88C90243L3015C3017R3015	7647	8412	89.5	24	23	293	37
	88C90243L3015C3017R3016	7647	8412	89.5	24	23	293	37
	88C90243L3015C3018R3015	7785	8562	89.5	24	23	304	37
	88C90243L3016C3016R3016	7572	8330	89.5	24	23	312	37
	88C90243L3016C3017R3011	7766	8544	89.5	24	23	282	37
	88C90243L3016C3017R3016	7647	8412	89.5	24	23	293	37
	88C90243L3016C3017R3018	7766	8544	89.5	24	23	282	37
	88C90243L3017C3016R3011	7766	8544	89.5	24	23	282	37
	88C90243L3018C3011R3018	8070	8875	89.5	24	23	271	37
	88C90243L3018C3015R3018	7905	8695	89.5	24	23	292	37
	88C90243L3018C3017R3015	7766	8544	89.5	24	23	282	37
	88C90243L3018C3017R3016	7766	8544	89.5	24	23	282	37
	88C90243L3018C3017R3018	7934	8727	89.5	24	23	260	37
	88C90243L3018C3018R3011	8070	8875	89.5	24	23	271	37
	88C96203L2411C3615R3616	8264	9090	95.5	20	23	326	36.5
	88C96203L2411C3616R3611	8537	9388	95.5	20	23	307	36.5
	88C96203L2411C3616R3615	8264	9090	95.5	20	23	326	36.5
	88C96203L2411C3616R3616	8264	9090	95.5	20	23	326	36.5
	88C96203L2411C3616R3617	8398	9240	95.5	20	23	294	36.5
	88C96203L2411C3617R3611	8565	9421	95.5	20	23	262	36.5
	88C96203L2411C3617R3616	8398	9240	95.5	20	23	294	36.5
	88C96203L2411C3618R3611	8700	9572	95.5	20	23	278	36.5
	88C96203L3611C3616R2411	8537	9388	95.5	20	23	307	36.5
	88C96203L3611C3617R2411	8565	9421	95.5	20	23	262	36.5
	88C96203L3611C3618R2411	8700	9572	95.5	20	23	278	36.5
	88C96203L3615C3616R2411	8264	9090	95.5	20	23	326	36.5
	88C96203L3616C3615R2411	8264	9090	95.5	20	23	326	36.5
	88C96203L3616C3616R2411	8264	9090	95.5	20	23	326	36.5
	88C96203L3616C3617R2411	8398	9240	95.5	20	23	304	36.5
	88C96203L3617C3616R2411	8398	9240	95.5	20	23	304	36.5
	88C96203L3011C3016R3617	8398	9240	95.5	20	23	304	36.5
	88C96203L3011C3617R3016	8398	9240	95.5	20	23	304	36.5
	88C96203L3011C3618R3011*	8700	9572	95.5	20	23	290	36.5
	88C96203L3015C3611R3015	8415	9257	95.5	20	23	310	36.5
	88C96203L3015C3616R3015	8190	9009	95.5	24	23	348	40
	88C96203L3015C3617R3015	8280	9109	95.5	24	23	336	40
	88C96203L3015C3617R3016	8280	9109	95.5	24	23	336	40
	88C96203L3015C3618R3015	8415	9257	95.5	24	23	332	40
88C96203L3016C3615R3016	8190	9009	95.5	24	23	348	40	
88C96203L3016C3616R3016	8190	9009	95.5	24	23	348	40	
88C96203L3016C3616R3017	8280	9109	95.5	24	23	304	40	
88C96203L3016C3617R3011	8398	9240	95.5	24	23	304	40	
88C96203L3016C3617R3015	8280	9109	95.5	24	23	304	40	
88C96203L3016C3617R3016	8280	9109	95.5	24	23	336	40	
88C96203L3016C3617R3018	8398	9240	95.5	24	23	304	40	
88C96203L3617C3016R3016	8280	9109	95.5	24	23	336	40	

**ORDERING NOTES:**

The -15 open/file module can be used in place of the -16 box/file module at the same price.  
 The -18 open/closed module can be used in place of the -11 closed module at the same price.  
 Please contact customer service for other available combinations. Pedestals with box and file drawers are available with a soft-closing drawer option. Please add "S" to the model # and **\$152 list** per pedestal. e.g.88C6024LDRFS. Lateral file drawers are not available with this option.

**ORDERING PROCEDURE**

- To order, please specify the following:  
 1) Krug product model number  
 2) Wood species and finish  
 3) Grommet location and style if applicable.

\* Indicates model illustrated by line drawing

**CODE DESCRIPTION**

- 3 - 3/4 height credenza
- L - left-handed position
- R - right-handed position
- 30 - 30" wide pedestal
- 36 - 36" wide pedestal
- 11 - closed bookcase
- 15 - top open, lateral file
- 16 - box, lateral file
- 17 - bookcase
- 18 - top open, closed bookcase

**STANDARD FINISHES**

For a complete list of standard wood finishes, please see page 9.

**GROMMETS**

One grommet in a standard position is optional at no charge. See page 12 for more information.



# ADESSO | 3/4 HEIGHT CREDENZAS

Description	Model	Oak		W	D	H	Shipping Weight	Cubic Feet
		Cherry Maple	Anigre Walnut					
	88C96203L3617C3016R3011	8398	9240	95.5	24	23	304	40
	88C96203L3018C3611R3018	8415	9257	95.5	24	23	290	40
	88C96203L3018C3615R3018	8537	9388	95.5	24	23	332	40
	88C96203L3018C3617R3016	8398	9240	95.5	24	23	304	40
	88C96243L2411C3615R3616	8415	9257	95.5	20	23	334	36.5
	88C96243L2411C3616R3611	8718	9588	95.5	20	23	320	36.5
	88C96243L2411C3616R3615	8415	9257	95.5	20	23	334	36.5
	88C96243L2411C3616R3616	8415	9257	95.5	20	23	334	36.5
	88C96243L2411C3616R3617	8550	9406	95.5	20	23	320	36.5
	88C96243L2411C3617R3611	8718	9588	95.5	20	23	288	36.5
	88C96243L2411C3617R3616	8550	9406	95.5	20	23	320	36.5
	88C96243L2411C3618R3611	8852	9736	95.5	20	23	304	36.5
	88C96243L3611C3616R2411	8718	9588	95.5	20	23	320	36.5
	88C96243L3611C3617R2411	8718	9588	95.5	20	23	288	36.5
	88C96243L3611C3618R2411	8852	9736	95.5	20	23	304	36.5
	88C96243L3615C3616R2411	8415	9257	95.5	20	23	334	36.5
	88C96243L3616C3615R2411	8415	9257	95.5	20	23	334	36.5
	88C96243L3616C3616R2411	8415	9257	95.5	20	23	334	36.5
	88C96243L3616C3617R2411	8550	9406	95.5	20	23	320	36.5
	88C96243L3617C3616R2411	8550	9406	95.5	20	23	320	36.5
	88C96243L3011C3016R3617	8550	9406	95.5	20	23	316	36.5
	88C96243L3011C3617R3016	8550	9406	95.5	20	23	316	36.5
	88C96243L3011C3618R3011*	8852	9736	95.5	20	23	202	36.5
	88C96243L3015C3611R3015	8565	9421	95.5	20	23	222	36.5
	88C96243L3015C3616R3015	8190	9009	95.5	24	23	360	40
	88C96243L3015C3617R3015	8431	9273	95.5	24	23	328	40
	88C96243L3015C3617R3016	8431	9273	95.5	24	23	328	40
	88C96243L3015C3618R3015	8565	9421	95.5	24	23	324	40
	88C96243L3016C3615R3016	8340	9173	95.5	24	23	360	40
	88C96243L3016C3616R3016	8340	9173	95.5	24	23	360	40
88C96243L3016C3616R3017	8431	9273	95.5	24	23	328	40	
88C96243L3016C3617R3011	8550	9406	95.5	24	23	316	40	
88C96243L3016C3617R3015	8431	9273	95.5	24	23	328	40	
88C96243L3016C3617R3016	8431	9273	95.5	24	23	328	40	
88C96243L3016C3617R3018	8550	9406	95.5	24	23	316	40	
88C96243L3617C3016R3016	8431	9273	95.5	24	23	328	40	
88C96243L3617C3016R3011	8550	9406	95.5	24	23	316	40	
88C96243L3018C3611R3018	8852	9736	95.5	24	23	290	40	
88C96243L3018C3615R3018	8565	9421	95.5	24	23	324	40	
88C96243L3018C3617R3016	8550	9406	95.5	24	23	316	40	

**ORDERING NOTES:**

The -15 open/file module can be used in place of the -16 box/file module at the same price.

The -18 open/closed module can be used in place of the -11 closed module at the same price.

Please contact customer service for other available combinations.

Pedestals with box and file drawers are available with a soft-closing drawer option. Please add "S" to the model # and **\$152 list** per pedestal. e.g.88C6024LDRFS. Lateral file drawers are not available with this option.

**DIMENSION KEY**

- W — width
- D — depth
- H — height of worksurface
- KW— kneehole width

Dimensions are in inches and approximate. Contact Customer Service if dimensions are critical.

**CODE DESCRIPTION**

- 3 - 3/4 height credenza
- L - left-handed position
- R - right-handed position
- 30 - 30" wide pedestal
- 36 - 36" wide pedestal
- 11 - closed bookcase
- 15 - top open, lateral file
- 16 - box, lateral file
- 17 - bookcase
- 18 - top open, closed bookcase

**STANDARD FINISHES**

For a complete list of standard wood finishes, please see page 9.

**GROMMETS**

One grommet in a standard position is optional at no charge. See page 12 for more information.

# ADESSO | OVERHEADS

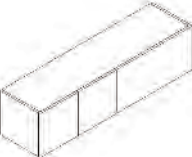
Description	Model	Oak Cherry Maple	Anigre Walnut	W	D	H	Doors	Shipping Weight	Cubic Feet
1 Hi Wall Mounted Overhead, Wood Doors 	88OHW361616	1967	2166	35.75	16	16	2	64	7.5
	88OHW421616	2160	2374	41.75	16	16	2	71	8.5
	88OHW481616	2348	2585	47.75	16	16	3	82	10
	88OHW541616	2440	2683	53.75	16	16	4	89	11
	88OHW601616	2536	2790	59.75	16	16	4	96	12
	88OHW661616	2636	2899	65.75	16	16	4	102	13
	88OHW721616	2727	2999	71.5	16	16	4	109	14.5
	88OHW781616	2891	3181	77.5	16	16	4	117	15.5
	88OHW841616	3057	3363	83.5	16	16	4	125	16.5
	88OHW901616	3221	3543	89.5	16	16	6	134	17.5
88OHW961616	3388	3727	95.5	16	16	6	146	19	

**ORDERING NOTES:**

All overheads include factory installed L.E.D. lights & mounting brackets. Add "P" to the end of the model number if Palette doors are required. See page 4 for tackboard fabric options and grading information.

1 Hi Wall Mounted Overhead, Back Painted Glass Doors 	88OHW361616Z	2269	2496	35.75	16	16	2	64	7.5
	88OHW421616Z	2460	2705	41.75	16	16	2	71	8.5
	88OHW481616Z	2650	2916	47.75	16	16	3	82	10
	88OHW541616Z	2741	3014	53.75	16	16	4	89	11
	88OHW601616Z	2838	3121	59.75	16	16	4	96	12
	88OHW661616Z	2936	3232	65.75	16	16	4	102	13
	88OHW721616Z	3029	3330	71.5	16	16	4	109	14.5
	88OHW781616Z	3192	3512	77.5	16	16	4	117	15.5
	88OHW841616Z	3357	3693	83.5	16	16	4	125	16.5
	88OHW901616Z	3522	3876	89.5	16	16	6	134	17.5
88OHW961616Z	3688	4059	95.5	16	16	6	146	19	

**ORDERING NOTES:**

All overheads include factory installed L.E.D. lights & mounting brackets. See page 4 for tackboard fabric options and grading information.

1 Hi Wall Mounted Overhead, Sliding Wood Doors 	88OSW481616	2650	2916	47.75	16	16	1	95	10
	88OSW601616	2838	3121	59.75	16	16	1	112	12
	88OSW661616	2936	3232	65.75	16	16	1	121	13
	88OSW721616	3029	3330	71.5	16	16	1	129	14.5
	88OSW781616	3192	3512	77.5	16	16	2	148	15.5
	88OSW841616	3357	3693	83.5	16	16	2	157	16.5
	88OSW901616	3522	3876	89.5	16	16	2	166	17.5
	88OSW961616	3688	4059	95.5	16	16	2	174	19

**ORDERING NOTES:**

All overheads include factory installed L.E.D. lights & mounting brackets. Add "P" to the end of the model number if Palette doors are required. See page 4 for tackboard fabric options and grading information.

**ORDERING PROCEDURE**

- To order, please specify the following:
- 1) Krug product model number
  - 2) Wood species and finish
  - 3) Grommet location and style if applicable.

\* Indicates model illustrated by line drawing

**CODE DESCRIPTION**

- OSW - overhead with sliding doors
- OHW - overhead with hinged doors
- Z - back-painted glass doors

**STANDARD FINISHES**

For a complete list of standard wood finishes, please see page 9.

**GROMMETS**

One grommet in a standard position is optional at no charge. See page 12 for more information.

Description	Model	Oak		W	D	H	Doors	Shipping Weight	Cubic Feet
		Cherry Maple	Anigre Walnut						
1 Hi Wall Mounted Overhead, Sliding Back Painted Glass Doors	88OSW481616Z	2954	3246	47.75	16	16	1	99	10
	88OSW601616Z	3138	3454	59.75	16	16	1	117	12
	88OSW661616Z	3238	3562	65.75	16	16	1	126	13
	88OSW721616Z	3329	3663	71.5	16	16	1	134	14.5
	88OSW781616Z	3493	3844	77.5	16	16	2	156	15.5
	88OSW841616Z	3661	4024	83.5	16	16	2	165	16.5
	88OSW901616Z	3781	4158	89.5	16	16	2	174	17.5
	88OSW961616Z	3991	4391	95.5	16	16	2	183	19

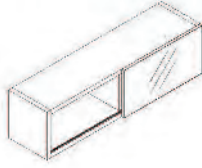

**ORDERING NOTES:**

All overheads include factory installed L.E.D. lights & mounting brackets. See page 4 for tackboard fabric options and grading information.

2 Hi Wall Mounted Overhead, Hinged Wood Doors	88OHW361630	3147	3462	35.75	16	30	2	100	13
	88OHW421630	3453	3795	41.75	16	30	2	112	15
	88OHW481630	3759	4133	47.75	16	30	3	130	17
	88OHW541630	3903	4292	53.75	16	30	4	148	18.5
	88OHW601630	4060	4466	59.75	16	30	4	166	20.5
	88OHW661630	4215	4637	65.75	16	30	4	184	22.5
	88OHW721630	4362	4796	71.5	16	30	4	202	24.5
	88OHW781630	4626	5086	77.5	16	30	4	220	26.5
	88OHW841630	4889	5380	83.5	16	30	4	238	28.5
	88OHW901630	5154	5668	89.5	16	30	6	256	30.5
	88OHW961630	5420	5962	95.5	16	30	6	274	32.5



**ORDERING NOTES:**

All overheads include factory installed L.E.D. lights & mounting brackets. Add "P" to the end of the model number if Palette doors are required. See page 4 for tackboard fabric options and grading information.

2 Hi Wall Mounted Overhead, Back Painted Glass Doors	88OHW361630Z	3631	3994	35.75	16	30	2	100	13
	88OHW421630Z	3933	4324	41.75	16	30	2	112	15
	88OHW481630Z	4239	4665	47.75	16	30	3	130	17
	88OHW541630Z	4385	4822	53.75	16	30	4	148	18.5
	88OHW601630Z	4540	4995	59.75	16	30	4	166	20.5
	88OHW661630Z	4697	5168	65.75	16	30	4	184	22.5
	88OHW721630Z	4843	5328	71.5	16	30	4	202	24.5
	88OHW781630Z	5108	5616	77.5	16	30	4	220	26.5
	88OHW841630Z	5369	5910	83.5	16	30	4	238	28.5
	88OHW901630Z	5636	6199	89.5	16	30	6	256	30.5
	88OHW961630Z	5902	6493	95.5	16	30	6	274	32.5



**ORDERING NOTES:**

All overheads include factory installed L.E.D. lights & mounting brackets. See page 4 for tackboard fabric options and grading information.

**DIMENSION KEY**

W — width  
 D — depth  
 H — height of worksurface  
 KW— kneehole width

Dimensions are in inches and approximate. Contact Customer Service if dimensions are critical.

**CODE DESCRIPTION**

OSW - overhead with sliding doors  
 OHW - overhead with hinged doors  
 Z - back-painted glass doors





**STANDARD FINISHES**

For a complete list of standard wood finishes, please see page 9.

**GROMMETS**

One grommet in a standard position is optional at no charge. See page 12 for more information.

# ADESSO | OVERHEADS

Description	Model	Oak Cherry Maple	Anigre Walnut	W	D	H	Doors	Shipping Weight	Cubic Feet
2 Hi Wall Mounted Overhead, Sliding Wood Doors 	88OSW481630	4239	4665	47.75	16	30	1	122	17
	88OSW601630	4540	4995	59.75	16	30	1	158	20.5
	88OSW661630	4697	5168	65.75	16	30	1	175	22.5
	88OSW721630	4843	5328	71.5	16	30	1	194	24.5
	88OSW781630	5108	5616	77.5	16	30	2	211	26.5
	88OSW841630	5369	5910	83.5	16	30	2	230	28.5
	88OSW961630	5902	6493	95.5	16	30	2	256	32.5
2 Hi Wall Mounted Overhead, Sliding Back Painted Glass Doors 	88OSW481630Z	4721	5194	47.75	16	30	1	122	17
	88OSW601630Z	5023	5527	59.75	16	30	1	158	20.5
	88OSW661630Z	5179	5695	65.75	16	30	1	175	22.5
	88OSW721630Z	5324	5859	71.5	16	30	2	194	24.5
	88OSW781630Z	5588	6147	77.5	16	30	2	211	26.5
	88OSW841630Z	5853	6438	83.5	16	30	2	230	28.5
	88OSW961630Z	6385	7020	95.5	16	30	2	256	32.5
2 Hi Wall Mounted Overhead, Wood Door, Doors/Open Below, Wood Doors 	88OHW601630-1512	4361	4795	59.75	16	30	4	156	20.5
	88OHW661630-1512	4663	5130	65.75	16	30	4	174	22.5
	88OHW721630-1512	4817	5299	71.5	16	30	4	192	24.5
	88OHW781630-1512	4965	5460	77.5	16	30	4	210	26.5
	88OHW841630-1512	5229	5748	83.5	16	30	4	228	28.5
	88OHW901630-1512	5493	6042	89.5	16	30	6	246	30.5
	88OHW961630-1512	6021	6624	95.5	16	30	4	264	32.5
2-Hi Wall Mounted Overhead - Back-Painted Glass Door, Doors / Open Below, Back-Painted Glass Door 	88OHW601630-1512Z	4842	5327	59.75	16	30	4	156	20.5
	88OHW661630-1512Z	5142	5658	65.75	16	30	4	174	22.5
	88OHW721630-1512Z	5299	5830	71.5	16	30	4	192	24.5
	88OHW781630-1512Z	5444	5991	77.5	16	30	4	210	26.5
	88OHW841630-1512Z	5710	6281	83.5	16	30	4	228	28.5
	88OHW901630-1512Z	5972	6571	89.5	16	30	6	246	30.5
	88OHW961630-1512Z	6504	7154	95.5	16	30	6	264	32.5

### ORDERING PROCEDURE

- To order, please specify the following:
- 1) Krug product model number
  - 2) Wood species and finish
  - 3) Grommet location and style if applicable

\* Indicates model illustrated by line drawing

### CODE DESCRIPTION

- OSW - overhead with sliding doors  
 OHW - overhead with hinged doors  
 Z - back-painted glass doors

### STANDARD FINISHES

For a complete list of standard wood finishes, please see page 9.

### GROMMETS

One grommet in a standard position is optional at no charge. See page 12 for more information.

# ADESSO | OVERHEADS & TACKBOARD UPCHARGES

Description	Model	Oak		W	D	H	Doors	Shipping Weight	Cubic Feet
		Cherry Maple	Anigre Walnut						
 1 Hi Wall Mounted Overhead, Open End, Sliding Wood Doors	88OSOEW721616	2847	3132	71.5	16	16	1	91	14.5
	88OSOEW781616*	2966	3265	77.5	16	16	2	99	15.5
	88OSOEW841616	3088	3396	83.5	16	16	2	103	16.5
	88OSOEW901616	3283	3609	89.5	16	16	2	118	18.5
	88OSOEW961616	3479	3827	95.5	16	16	2	126	19.5
	88OSOEW1201616	3706	4072	120	16	16	2	162	24
	88OSOEW1441616	3946	4339	144	16	16	2	188	28.5

**ORDERING NOTES:**

All overheads include factory installed L.E.D. lights & mounting brackets. Add "P" to the end of the model number if Palette doors are required. See page 4 for tackboard fabric options and grading information.

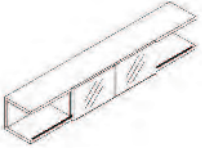
 1 Hi Wall Mounted Overhead, Open End, Sliding Back Painted Glass Doors	88OSOEW721616Z	3088	3396	71.5	16	16	1	91	14.5
	88OSOEW781616Z*	3283	3609	77.5	16	16	2	99	15.5
	88OSOEW841616Z	3479	3827	83.5	16	16	2	103	16.5
	88OSOEW901616Z	3672	4040	89.5	16	16	2	118	18.5
	88OSOEW961616Z	3870	4258	95.5	16	16	2	126	19.5
	88OSOEW1201616Z	4215	4637	120	16	16	2	162	24
	88OSOEW1441616Z	4503	4952	144	16	16	2	188	28.5

**ORDERING NOTES:**

All overheads include factory installed L.E.D. lights & mounting brackets. See page 4 for tackboard fabric options and grading information.

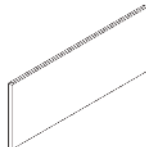
Description	Model	1	2	3	4	5	6	7	8	9	W	H	Weight	COM
 Wall Mounted Tackboard 24" high - for Overheads	88TBOHW3624	333	369	407	465	605	741	875	1018	1198	35.75	23.5	12	1.5
	88TBOHW4224	369	497	529	654	785	908	1038	1199	1421	41.75	23.5	14	1.5
	88TBOHW4824	411	512	536	673	807	924	1066	1228	1478	47.75	23.5	16	1.75
	88TBOHW5424	434	537	561	706	846	971	1120	1288	1551	53.75	23.5	18	1.75
	88TBOHW6024	468	624	655	816	982	1163	1345	1527	1815	59.75	23.5	20	2
	88TBOHW6624	513	697	746	909	1089	1295	1473	1683	2006	65.75	23.5	22	2
	88TBOHW7224*	562	864	898	1192	1464	1483	1702	1942	2264	71.5	23.5	26	2.25
	88TBOHW7824	619	949	988	1311	1612	1633	1872	2135	2491	77.5	23.5	28	2.5
	88TBOHW8424	723	1109	1155	1534	1884	1908	2191	2500	2913	83.5	23.5	31	2.5
	88TBOHW9024	761	1165	1215	1611	1982	2004	2302	2629	3061	89.5	23.5	33	2.75
	88TBOHW9624	791	1212	1265	1676	2061	2087	2396	2736	3187	95.5	23.5	35	3

**NOTE:** Use between wall mounted overheads and desk height credenza.

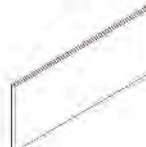
 Wall Mounted Tackboard 30" high - for Overheads	88TBOHW3630	399	444	488	559	727	888	1052	1222	1437	35.75	30	13	1.5
	88TBOHW4230	444	552	633	784	943	1088	1247	1439	1697	41.75	30	15	1.5
	88TBOHW4830	493	614	642	806	967	1108	1281	1473	1771	47.75	30	15	1.75
	88TBOHW5430	520	644	674	848	1016	1165	1346	1547	1860	53.75	30	19	1.75
	88TBOHW6030	561	749	784	979	1177	1394	1612	1833	2177	59.75	30	21	2
	88TBOHW6630	615	837	894	1090	1307	1555	1765	2018	2407	65.75	30	23	2
	88TBOHW7230*	674	1033	1074	1428	1755	1778	2039	2329	2715	71.5	30	27	2.25
	88TBOHW7830	741	1138	1187	1572	1935	1957	2247	2566	2989	77.5	30	28	2.5
	88TBOHW8430	869	1331	1386	1841	2261	2287	2630	2999	3495	83.5	30	32	2.5
	88TBOHW9030	913	1398	1458	1934	2378	2407	2763	3153	3673	89.5	30	34	2.75
88TBOHW9630	952	1456	1518	2014	2478	2506	2878	3280	3825	95.5	30	36	3	

**NOTE:** Use between wall mounted overheads and 3/4 height credenza.

**DIMENSION KEY**

W – width  
 D – depth  
 H – height of worksurface  
 KW – kneehole width

Dimensions are in inches and approximate. Contact Customer Service if dimensions are critical.

**CODE DESCRIPTION**

OSOEW - overhead with sliding doors and open ends  
 Z- back-painted glass doors

**STANDARD FINISHES**

For a complete list of standard wood finishes, please see page 9.

**GROMMETS**

One grommet in a standard position is optional at no charge. See page 12 for more information.

# ADESSO | WALL MOUNTED & MAGNETIC BACK-PAINTED GLASS

Description	Model	Price	W	D	H	Shipping Weight	Cubic Feet	
	Wall Mounted Back Painted Glass 23.5"	88GPW3624	1854	35.75	-	23.5	48	1.5
		88GPW4224	1944	41.75	-	23.5	56	1.75
		88GPW4824	2033	47.75	-	23.5	64	2
		88GPW5424	2124	53.75	-	23.5	72	2.25
		88GPW6024	2243	59.75	-	23.5	80	2.5
		88GPW6624	2410	65.75	-	23.5	88	2.75
		88GPW7224	2576	71.5	-	23.5	96	3
		88GPW7824	2770	77.5	-	23.5	104	3.25
		88GPW8424	2952	83.5	-	23.5	112	3.5
		88GPW9024	3418	89.5	-	23.5	120	3.75
		88GPW9624	3554	95.5	-	23.5	128	4

**ORDERING NOTES:** Use between wall mounted overheads and desk height credenzas. Magnets are not supplied with magnetic glass. Wall mounted Back-Painted glass panels 90" and longer are 2-pieces.

	Wall Mounted Back Painted Glass 30"	88GPW3630	2214	35.75	-	30	60	2
		88GPW4230	2334	41.75	-	30	70	2.25
		88GPW4830	2440	47.75	-	30	80	2.5
		88GPW5430	2530	53.75	-	30	90	2.75
		88GPW6030	2696	59.75	-	30	100	3.25
		88GPW6630	2907	65.75	-	30	110	3.5
		88GPW7230	3133	71.5	-	30	120	3.75
		88GPW7830	3343	77.5	-	30	130	4
		88GPW8430	3599	83.5	-	30	140	4.25
		88GPW9030	3811	89.5	-	30	150	4.75
		88GPW9630	3991	95.5	-	30	160	5

**ORDERING NOTES:** Use between wall mounted overheads and 3/4 height credenzas. Magnets are not supplied with back painted glass. Wall mounted Back-Painted glass panels 90" and longer are 2-pieces.

	Magnetic Back Painted Glass 23.5"	88GPW3624M	2033	35.75	-	23.5	48	1.5
		88GPW4224M	2155	41.75	-	23.5	56	1.75
		88GPW4824M	2274	47.75	-	23.5	64	2
		88GPW5424M	2394	53.75	-	23.5	72	2.25
		88GPW6024M	2545	59.75	-	23.5	80	2.5
		88GPW6624M	2756	65.75	-	23.5	88	2.75
		88GPW7224M	2966	71.5	-	23.5	96	3
		88GPW7824M	3208	77.5	-	23.5	104	3.25
		88GPW8424M	3432	83.5	-	23.5	112	3.5
		88GPW9024M	3946	89.5	-	23.5	120	3.75
		88GPW9624M	4127	95.5	-	23.5	128	4

**ORDERING NOTES:** Use between wall mounted overheads and desk height credenzas. Magnets are not supplied with magnetic glass. Wall mounted Back-Painted glass panels 90" and longer are 2-pieces.

	Magnetic Back Painted Glass 30"	88GPW3630M	2440	35.75	-	30	60	2
		88GPW4230M	2590	41.75	-	30	70	2.25
		88GPW4830M	2726	47.75	-	30	80	2.5
		88GPW5430M	2860	53.75	-	30	90	2.75
		88GPW6030M	3057	59.75	-	30	100	3.25
		88GPW6630M	3313	65.75	-	30	110	3.5
		88GPW7230M	3582	71.5	-	30	120	3.75
		88GPW7830M	3841	77.5	-	30	130	4
		88GPW8430M	4141	83.5	-	30	140	4.25
		88GPW9030M	4396	89.5	-	30	150	4.75
		88GPW9630M	4622	95.5	-	30	160	5

**ORDERING NOTES:** Use between wall mounted overheads and 3/4 height credenzas. Magnets are not supplied with back painted glass. Wall mounted Back-Painted glass panels 90" and longer are 2-pieces.

**ORDERING PROCEDURE**

- To order, please specify the following:
- 1) Krug product model number
  - 2) Wood species and finish
  - 3) Grommet location and style if applicable

\* Indicates model illustrated by line drawing

**CODE DESCRIPTION**

- M - magnetic back-painted glass
- WP - panel wall

**STANDARD FINISHES**

For a complete list of standard wood finishes, please see page 9.

**GROMMETS**

One grommet in a standard position is optional at no charge. See page 12 for more information.

Description	Model	Oak Cherry Maple	Anigre Walnut	W	D	H	Shipping Weight	Cubic Feet
5 Hi Panel Walls	88WP3069	1266	1391	30	1.5	69	60	5.25
	88WP3669	1492	1641	36	1.5	69	70	6.25
	38WP4269	1764	1940	42	1.5	69	80	7.25

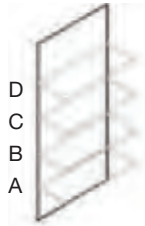

**ORDERING NOTES:** Panel Wall can be plain or machined to accommodate shelves in any of the locations shown. Please specify each location by adding the appropriate suffix to the model #. e.g. 2 shelves, one in location B and on in location D would be 88WP3069BD Please order the shelf type and number of shelves required from page 67 Wall mounting brackets are included.

6 Hi Panel Wall	88WP3083	1777	1955	30	1.5	83	68	6.25
	88WP3683	1988	2188	36	1.5	83	81	7.5
	88WP4283	2229	2451	42	1.5	83	95	8.5

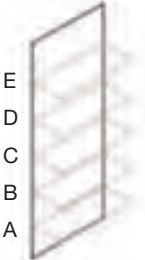

**ORDERING NOTES:** Panel Wall can be plain or machined to accommodate shelves in any of the locations shown. Please specify each location by adding the appropriate suffix to the model #. e.g. 2 shelves, one in location B and on in location D would be 88WP3069BD Please order the shelf type and number of shelves required from page 67. Wall mounting brackets are included.

Panel Wall - 24" high	88WP4824	799	879	48	1.5	23.5	40	3.25
	88WP6024	962	1061	60	1.5	23.5	46	4
	88WP7224	1131	1244	72	1.5	23.5	53	4.75
	88WP8424	1327	1458	84	1.5	23.5	60	5.5
	88WP9024	1522	1672	90	1.5	23.5	65	5.75
	88WP9624	1716	1887	96	1.5	23.5	72	6.25
	88WP10824	1957	2154	108	1.5	23.5	81	5.25
	88WP12024	2304	2535	120	1.5	23.5	90	5.75



**ORDERING NOTES:** Panel Wall can be plain or machined to accommodate shelves in any of the locations shown. Please specify each location by adding the appropriate suffix to the model #. e.g. 2 shelves, one in locations B and on in location D would be 88WP3069BD Please order the shelf type and number of shelves required from page 67. Use between Full Height Credenzas and Wall Mounted Overheads. 108" & 120" Panel Walls are shipped in two pieces. Wall mounting brackets are included.

Panel Wall - 40" high	88WP4840	1086	1194	48	1.5	40	60	5.25
	88WP6040	1222	1342	60	1.5	40	73	6.25
	88WP7240	1386	1526	72	1.5	40	86	7.5
	88WP8440	1554	1706	84	1.5	40	99	8.75
	88WP9040	1732	1907	90	1.5	40	110	9.25
	88WP9640	1957	2154	96	1.5	40	118	9.75
	88WP10840	2304	2535	108	1.5	40	132	8.25
	88WP12040	2681	2948	120	1.5	40	147	9

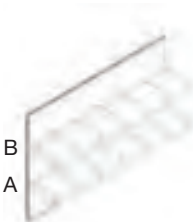

**ORDERING NOTES:** Panel Wall can be plain or machined to accommodate shelves in any of the locations shown. Please specify each location by adding the appropriate suffix to the model #. e.g. 2 shelves, one in locations B and on in location D would be 88WP3069BD Please order the shelf type and number of shelves required from page 67. Use with Full Height Credenzas to obtain 5hi height. 108" & 120" Panel Walls are shipped in two pieces. Wall mounting brackets are included.

**DIMENSION KEY**

W — width  
D — depth  
H — height of worksurface  
KW— kneehole width

Dimensions are in inches and approximate. Contact Customer Service if dimensions are critical.

**CODE DESCRIPTION**

M - magnetic back-painted glass  
WP - panel wall  
D - divider

**BACK PAINTED GLASS**

Standard finish is white. Please see page 15 for options on back painted glass.

# ADESSO | PANEL WALLS

Description	Model	Oak Cherry Maple	Anigre Walnut	W	D	H	Shipping Weight	Cubic Feet
	88WP4853	1282	1409	48	1.5	53	79	6.75
	88WP6053	1461	1609	60	1.5	53	92	8.25
	88WP7253	1671	1840	72	1.5	53	105	9.75
	88WP8453	1897	2087	84	1.5	53	118	11.25
	88WP9053	2108	2319	90	1.5	53	131	12
	88WP9653	2334	2568	96	1.5	53	144	12.75
	88WP10853	2545	2800	108	1.5	53	162	10.25
	88WP12053	2830	3113	120	1.5	53	180	12

**ORDERING NOTES:** Panel Wall can be plain or machined to accommodate shelves in any of the locations shown. Please specify each location by adding the appropriate suffix to the model #. e.g. 2 shelves, one in locations B and on in location D would be 88WP3069BD Please order the shelf type and number of shelves required from page 67. Use with Full Height Credenzas to obtain 6hi height. 108" & 120" Panel Walls are shipped in two pieces. Wall mounting brackets are included.

	88WP4830	889	979	48	1.5	30	49	4
	88WP6030	1026	1126	60	1.5	30	58	4.75
	88WP7230	1192	1310	72	1.5	30	67	5.75
	88WP8430	1386	1526	84	1.5	30	75	6.75
	88WP9030	1583	1741	90	1.5	30	88	7
	88WP9630	1777	1955	96	1.5	30	93	7.5
	88WP10830	2033	2238	108	1.5	30	105	6.25
	88WP12030	2364	2602	120	1.5	30	118	7

**ORDERING NOTES:** Panel Wall can be plain or machined to accommodate shelves in any of the locations shown. Please specify each location by adding the appropriate suffix to the model #. e.g. 2 shelves, one in locations B and on in location D would be 88WP3069BD Please order the shelf type and number of shelves required from page 67. Use between 3/4 Height Credenzas and Wall Mounted Overheads. 108" & 120" Panel Walls are shipped in two pieces. Wall mounting brackets are included. Please note that shelves in A position can not be used when a runoff for 3/4 Height Credenzas is selected.

	88WP4846	1131	1244	48	1.5	46	70	5.75
	88WP6046	1266	1391	60	1.5	46	82	7.25
	88WP7246	1431	1573	72	1.5	46	94	8.5
	88WP8446	1596	1755	84	1.5	46	106	9.75
	88WP9046	1777	1955	90	1.5	46	118	10.5
	88WP9646	2003	2205	96	1.5	46	130	11.25
	88WP10846	2348	2585	108	1.5	46	147	9.25
	88WP12046	2726	2998	120	1.5	46	163	10

**ORDERING NOTES:** Panel Wall can be plain or machined to accommodate shelves in any of the locations shown. Please specify each location by adding the appropriate suffix to the model #. e.g. 2 shelves, one in locations B and on in location D would be 88WP3069BD Please order the shelf type and number of shelves required from page 67. Use with 3/4 Height Credenzas to obtain 5Hi height. 108" & 120" Panel Walls are shipped in two pieces. Wall mounting brackets are included. Please note that shelves in A position can not be used when a runoff for 3/4 Height Credenzas is selected.

**ORDERING PROCEDURE**

To order, please specify the following:  
 1) Krug product model number  
 2) Wood species and finish  
 3) Grommet location and style if applicable.

**CODE DESCRIPTION**

M - magnetic back-painted glass  
 WP - panel wall  
 D - divider

**STANDARD FINISHES**

For a complete list of standard wood finishes, please see page 9.

**GROMMETS**

One grommet in a standard position is optional at no charge. See page 12 for more information.

\* Indicates model illustrated by line drawing

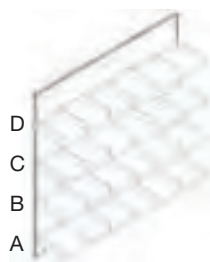

Description	Model	Oak Cherry Maple	Anigre Walnut	W	D	H	Shipping Weight	Cubic Feet
Panel Wall - 59" high 	88WP4859	1327	1458	48	1.5	59	78	7.5
	88WP6059	1506	1659	60	1.5	59	96	9
	88WP7259	1716	1887	72	1.5	59	114	10.75
	88WP8459	1944	2136	84	1.5	59	132	12.5
	88WP9059	2155	2369	90	1.5	59	152	13.25
	88WP9659	2381	2615	96	1.5	59	170	14.25

**ORDERING NOTES:**

Panel Wall can be plain or machined to accommodate shelves in any of the locations shown. Please specify each location by adding the appropriate suffix to the model #. e.g. 2 shelves, one in locations B and on in location D would be 88WP3069BD Please order the shelf type and number of shelves required from below. Use with 3/4 Height Credenzas to obtain 6Hi height. 108" & 120" Panel Walls are shipped in two pieces. Wall mounting brackets are included.  
Please note that shelves in A position can not be used when a runoff for 3/4 Height Credenzas is selected.

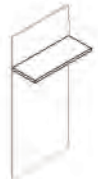
		437	481					
Panel Wall Shelf 	88WPS30	453	497	30	12	1.13	9.75	1.0
	88WPS36	468	515	36	12	1.13	11.75	1.1
	88WPS42	483	532	42	12	1.13	13.75	1.2
	88WPS48	513	564	48	12	1.13	15.75	1.3
	88WPS54	542	597	54	12	1.13	17.75	1.4
	88WPS60	633	696	60	12	1.13	19.75	1.5
	88WPS72	723	795	72	12	1.13	23.75	1.7
	88WPS84	812	895	84	12	1.13	27.75	1.9
	88WPS90	952	1044	90	12	1.13	29.75	2.0
	88WPS96			96	12	1.13	31.75	2.1

**ORDERING NOTES:**

Shelves and Shelves with dividers can be intermixed on the same Panel Wall both horizontally or vertically.

Panel Wall Shelf with Dividers 	88WPSD30	859	946	30	12	3	13	1.2
	88WPSD36	873	960	36	12	3	15	1.4
	88WPSD42	905	994	42	12	3	18	1.5
	88WPSD48	934	1029	30	12	3	20	1.7
	88WPSD54	962	1061	54	12	3	22.75	1.8
	88WPSD60	1011	1110	60	12	3	25.25	2.0
	88WPSD72	1143	1260	72	12	3	30.75	2.2
	88WPSD84	1295	1423	84	12	3	35	2.5
	88WPSD90	1446	1590	90	12	3	37.25	2.7
	88WPSD96	1612	1773	96	12	3	40.0	2.8

**ORDERING NOTES:**

Shelves and Shelves with dividers can be intermixed on the same Panel Wall both horizontally or vertically.

**DIMENSION KEY**

W — width  
D — depth  
H — height of worksurface  
KW— kneehole width

Dimensions are in inches and approximate.  
Contact Customer Service if dimensions are critical.





**CODE DESCRIPTION**

M - magnetic back-painted glass  
WP - panel wall  
D - divider

**BACK PAINTED GLASS**

Standard finish is white. Please see page 15 for options on back painted glass.

# ADESSO | PIERS

Description	Model	Oak		W	D	H	Shipping Weight	Cubic Feet
		Cherry Maple	Anigre Walnut					
 Sliding Door Wall Units	88BWC601640	9019	9918	60	16	40	207	23.5
	88BWC721640	9153	10067	72	16	40	245	28
	88BWC841640	9410	10349	84	16	40	278	32.5
	88BWC961640	9650	10616	96	16	40	312	37.5
	88BWC602040	9109	10019	60	20	40	248	31
	88BWC722040	9289	10218	72	20	40	294	37
	88BWC842040	9529	10484	84	20	40	334	43.5
	88BWC962040	9778	10756	96	20	40	375	49.5
 Pier Paper Manager, 3 Drawers/Open	88PR241640146	2486	2735	24	16	40	80	11.25
	88PR241646146	2560	2816	24	16	46	95	12.75
	88PR241653146	2650	2916	24	16	53	110	14.75
	88PR241659146	2741	3014	24	16	59	125	16.5
 Pier Open	88PR24164017	1944	2136	24	16	40	107	11.25
	88PR24164617	2018	2219	24	16	46	115	12.75
	88PR24165317	2108	2319	24	16	53	126	14.75
	88PR24165917	2197	2418	24	16	59	135	16.5
 Pier Closed, Hinged Wood Door	88PR24164011L	2185	2403	24	16	40	123	11.25
	88PR24164011R	2185	2403	24	16	40	123	11.25
	88PR24164611L	2287	2518	24	16	46	134	12.75
	88PR24164611R	2287	2518	24	16	46	134	12.75
	88PR24165311L	2394	2635	24	16	53	148	14.75
	88PR24165311R	2394	2635	24	16	53	148	14.75
	88PR24165911L	2500	2747	24	16	59	159	16.5
88PR24165911R	2500	2747	24	16	59	159	16.5	
 Pier Closed, Hinged Back Painted Glass Door	88PR24164011ZL	2712	2983	24	16	40	130	11.25
	88PR24164011ZR	2712	2983	24	16	40	130	11.25
	88PR24164611ZL	2817	3097	24	16	46	142	12.75
	88PR24164611ZR	2817	3097	24	16	46	142	12.75
	88PR24165311ZL	2921	3214	24	16	53	156	14.75
	88PR24165311ZR	2921	3214	24	16	53	156	14.75
	88PR24165911ZL	3028	3329	24	16	59	168	16.5
	88PR24165911ZR	3028	3329	24	16	59	168	16.5

**ORDERING PROCEDURE**

To order, please specify the following:  
 1) Krug product model number  
 2) Wood species and finish

**CODE DESCRIPTION**

146 - open pier with 3 drawers  
 17 - open pier  
 11 - closed pier  
 L - left hinged  
 R - right hinged  
 Z - back-painted glass

**STANDARD FINISHES**

For a complete list of standard wood finishes, please see page 9.

**LOCKS**

Locks are available on hinged wood door overheads at an upcharge of **\$152 list** per set of (2) doors. Glass door overheads cannot be specified with locks

Description	Model	Oak		W	D	H	Shipping Weight	Cubic Feet
		Cherry	Anigre					
 5 Hi Hutch, Hinged Wood Doors	88HT601640	3849	4236	59.75	16	40	144	23.5
	88HT661640	4187	4608	65.75	16	40	155	26
	88HT721640	4528	4979	71.5	16	40	167	28
	88HT781640	4863	5349	77.5	16	40	178	30.5
	88HT841640	5203	5721	83.5	16	40	190	32.5
	88HT901640	5562	6119	89.5	16	40	202	35
	88HT961640	5946	6542	95.5	16	40	214	37.5

**ORDERING NOTES:**

All hutches include factory installed L.E.D. lights & mounting brackets. Add "P" to the end of the model number if Palette doors are required. To specify a Voice/Power/Data module with any hutch, please add a "W" to the end of the model number and a **\$252 list upcharge**, e.g. 88HT601653W. Please see chart on page 70 for other tackboard price grades.

 5 Hi Hutch, Hinged Back Painted Glass Doors	88HT601640Z	4439	4885	59.75	16	40	144	23.5
	88HT661640Z	4830	5314	65.75	16	40	155	26
	88HT721640Z	5218	5741	71.5	16	40	167	28
	88HT781640Z	5611	6171	77.5	16	40	178	30.5
	88HT841640Z	5999	6600	83.5	16	40	190	32.5
	88HT901640Z	6399	7040	89.5	16	40	202	35
	88HT961640Z	6791	7468	95.5	16	40	214	37.5

**ORDERING NOTES:**

All hutches include factory installed L.E.D. lights & mounting brackets. To specify a Voice/Power/Data module with any hutch, please add a "W" to the end of the model number and a **\$252 list upcharge**, e.g. 88HT601653W. Please see chart on page 70 for other tackboard price grades.

 6 Hi Hutch, Hinged Wood Doors	88HT601653	4258	4683	59.75	16	53	197	31
	88HT661653	4755	5231	65.75	16	53	211	34.5
	88HT721653	5250	5775	71.5	16	53	235	37.5
	88HT781653	5746	6321	77.5	16	53	251	40.5
	88HT841653	6243	6868	83.5	16	53	268	43.5
	88HT901653	6731	7402	89.5	16	53	285	46.5
	88HT961653	7227	7948	95.5	16	53	302	49.5

**ORDERING NOTES:**

All hutches include factory installed L.E.D. lights & mounting brackets. Add "P" to the end of the model number if Palette doors are required. To specify a Voice/Power/Data module with any hutch, please add a "W" to the end of the model number and a **\$252 list upcharge**, e.g. 88HT601653W. Please see chart on page 70 for other tackboard price grades.

 6 Hi Hutch, Hinged Back Painted Glass Doors	88HT601653Z	4911	5399	59.75	16	53	197	31
	88HT661653Z	5483	6032	65.75	16	53	211	34.5
	88HT721653Z	6057	6662	71.5	16	53	235	37.5
	88HT781653Z	6629	7292	77.5	16	53	251	40.5
	88HT841653Z	7204	7924	83.5	16	53	268	43.5
	88HT901653Z	7785	8562	89.5	16	53	285	46.5
	88HT961653Z	8358	9191	95.5	16	53	302	49.5

**ORDERING NOTES:**

All hutches include factory installed L.E.D. lights & mounting brackets. To specify a Voice/Power/Data module with any hutch, please add a "W" to the end of the model number and a **\$252 list upcharge**, e.g. 88HT601653W. Please see chart on page 70 for other tackboard price grades.

**DIMENSION KEY**

W - width  
D - depth  
H - height

**CODE DESCRIPTION**

146 - open pier with 3 drawers  
17 - open pier  
11 - closed pier  
Z - back-painted glass  
PM - paper manager

**STANDARD FINISHES**

For a complete list of standard wood finishes, please see page 9.

**LOCKS**

Locks are available on hinged wood door overheads at an upcharge of **\$152 list** per set of (2) doors. Glass door overheads cannot be specified with locks.

# ADESSO | HUTCH TACKBOARD FABRIC UPGRADE, KEYBOARD & ACCESSORIES

Hutches include a tackboard, priced at Gr 1/COM. Use this chart to get the upcharges for tackboard fabrics graded 2-9, and add it to the list price of the hutch

Fabric Grades

	2	3	4	5	6	7	8	9	Yardage
60" Tackboard	143	309	468	633	799	962	799	962	2
66" Tackboard	165	359	521	697	869	1021	869	1021	2
72" Tackboard	199	426	622	837	1036	1236	1036	1236	2.25
78" Tackboard	234	500	735	974	1206	1443	1206	1443	2.5
84" Tackboard	278	580	859	1136	1414	1690	1414	1690	2.5
90" Tackboard	287	601	894	1179	1467	1755	1467	1755	2.75
96" Tackboard	299	626	930	1228	1528	1827	1528	1827	3

Description	Model	Oak Cherry Maple	Anigre Walnut	W	D	H	Shipping Weight	Cubic Feet
Paper Manager with Drawers	88PM18122001	1017	1119	18	12	19.75	50	3



Drawer Organizer with Pencil Tray	88DO3215	415		32.25	15	4	12	1.5
-----------------------------------	----------	-----	--	-------	----	---	----	-----



**ORDERING NOTES:**  
For use in 3" x 36" box drawers

Paper Sorter with Pencil Tray	88PS3215	464		32.25	15	4	16	1.5
-------------------------------	----------	-----	--	-------	----	---	----	-----

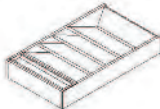

Articulating Keyboard with Palm Rest & Mouse Tray	88KBMT1912	481		27	-	7	20	2
---	------------	-----	--	----	---	---	----	---



Height Adjustable Table Programmable Display- 4 Position Memory	88HAPD	376		-	-	-	-	-
---	--------	-----	--	---	---	---	---	---







**ORDERING PROCEDURE**

To order, please specify the following:  
1) Krug product model number  
2) Wood species and finish

**STANDARD FINISHES**

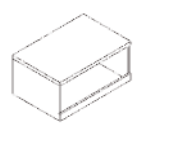
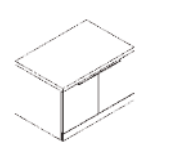
For a complete list of standard wood finishes, please see page 9.

Description	Model	Oak		W	D	H	Shipping Weight	Cubic Feet
		Cherry Maple	Anigre Walnut					
 1 Hi Storage Unit, Lateral File	88ST30201701	1732	1907	29.75	20	17	110	7
	88ST30241701	1764	1940	29.75	24	17	120	8.25
	88ST36201701*	1792	1971	35.75	20	17	112	8.25
	88ST36241701	1822	2004	35.75	24	17	124	9.75
 1 Hi Storage Unit, Closed Bookcase	88ST30201711	1883	2070	29.75	20	17	62	7
	88ST30241711	1913	2105	29.75	24	17	72	8.25
	88ST36201711*	1944	2136	35.75	20	17	66	8.25
	88ST36241711	1974	2170	35.75	24	17	76	9.75
 1 Hi Storage Unit, Open Bookcase	88ST30201717	1808	1988	29.75	20	17	52	7
	88ST30241717	1837	2020	29.75	24	17	62	8.25
	88ST36201717*	1867	2055	35.75	20	17	56	8.25
	88ST36241717	1897	2087	35.75	24	17	66	9.75
 1.5 Hi Storage Unit, Closed Bookcase	88ST30202311	2348	2585	29.75	20	23	92	9.25
	88ST30242311	2381	2615	29.75	24	23	96	11
	88ST36202311*	2410	2650	35.75	20	23	94	11
	88ST36242311	2440	2683	35.75	24	23	98	13
 1.5 Hi Storage Unit, Open/Lateral File	88ST30202315	2229	2451	29.75	20	23	135	9.25
	88ST30242315	2257	2486	29.75	24	23	155	11
	88ST36202315*	2287	2518	35.75	20	23	137	11
	88ST36242315	2319	2552	35.75	24	23	149	13
 1.5 Hi Storage Unit, Lateral Box/Lateral File	88ST30202316	2155	2369	29.75	20	23	145	9.25
	88ST30242316	2185	2403	29.75	24	23	165	11
	88ST36202316*	2214	2434	35.75	20	23	147	11
	88ST36242316	2243	2466	35.75	24	23	159	13

**ORDERING NOTES:**

Box and pedestal file drawers are available with a soft-closing drawer option. Please add 'S' to the end of the model number and **add \$152**. e.g. 88ST36241316S.

**DIMENSION KEY**

W - width  
D - depth  
H - height

**CODE DESCRIPTION**

- 01 - lateral file
- 11 - closed bookcase
- 17 - open bookcase
- 16 - lateral box, lateral file
- 15 - open, lateral file





**STANDARD FINISHES**

For a complete list of standard wood finishes, please see page 9.

**STORAGE BOOKCASES**

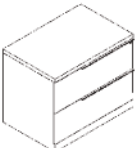
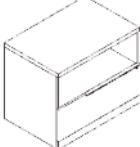
Shelves are adjustable in 1.25" increments.

# ADESSO | STORAGE

Description	Model	Oak Cherry Maple	Anigre Walnut	W	D	H	Shipping Weight	Cubic Feet
 1.5 Hi Storage Unit, Open Bookcase	88ST30202317	2274	2503	29.75	20	23	82	9.25
	88ST30242317	2304	2535	29.75	24	23	86	11
	88ST36202317*	2334	2568	35.75	20	23	84	11
	88ST36242317	2364	2602	35.75	24	23	88	13
 2 Hi Storage Unit, Lateral File	88ST30203001	3410	3752	29.75	20	29.5	194	11.5
	88ST30243001	3455	3797	29.75	24	29.5	180	13.75
	88ST36203001*	3543	3898	35.75	20	29.5	198	13.75
	88ST36243001	3591	3952	35.75	24	29.5	184	16.25
 2 Hi Storage Unit, Open/Lateral File	88ST30203015	3630	3993	29.75	20	29.5	174	11.5
	88ST30243015	3672	4040	29.75	24	29.5	160	13.75
	88ST36203015*	3793	4173	35.75	20	29.5	178	13.75
	88ST36243015	3841	4223	35.75	24	29.5	164	16.25
 2 Hi Storage Unit, Closed Bookcase	88ST30203011	2609	2870	29.75	20	29.5	102	11.5
	88ST30243011	2646	2912	29.75	24	29.5	106	13.75
	88ST36203011*	2697	2966	35.75	20	29.5	104	13.75
	88ST36243011	2742	3015	35.75	24	29.5	108	16.25
 2 Hi Storage Unit, Open Bookcase	88ST30203017	1959	2155	29.75	20	29.5	xx	11.5
	88ST30243017	1998	2197	29.75	24	29.5	xx	13.75
	88ST36203017*	2040	2244	35.75	20	29.5	xx	13.75
	88ST36243017	2079	2285	35.75	24	29.5	xx	16.25
 4 Hi Lateral File	88ST36205501	5174	5692	35.75	20	55	176	25
	88ST36245501*	5329	5863	35.75	24	55	196	30

**ORDERING PROCEDURE**

To order, please specify the following:  
 1) Krug product model number  
 2) Wood species and finish

**CODE DESCRIPTION**



01 - lateral file  
 15 - open, lateral file  
 17 - open bookcase  
 11 - closed bookcase

**STANDARD FINISHES**

For a complete list of standard wood finishes, please see page 9.

**STORAGE BOOKCASES**

Shelves are adjustable in 1.25" increments.

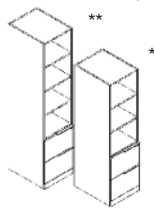
Description	Model	Oak		W	D	H	Shipping Weight	Cubic Feet
		Cherry Maple	Anigre Walnut					
 Bookcase, Open Shelves	88BC301655	3885	4272	29.75	16	55	64	17.5
	88BC361655*	4049	4456	35.75	16	55	72	21
	88BC301669	4155	4571	29.75	16	69	100	22
	88BC361669	4321	4754	35.75	16	69	112	26
	88BC301683	4442	4887	29.75	16	83	136	26
	88BC361683	4608	5066	35.75	16	83	148	31
 5 & 6 - Hi Storage Unit Closed Bookcase	88ST19206911L	3324	3658	18.75	20	69	118	16.75
	88ST19206911R	3324	3658	18.75	20	69	118	16.75
	88ST19246911L	3404	3743	18.75	24	69	132	20
	88ST19246911R	3404	3743	18.75	24	69	132	20
	88ST19208311L	3881	4269	18.75	20	83	148	20
	88ST19208311R	3881	4269	18.75	20	83	148	20
	88ST19248311L	3931	4322	18.75	24	83	160	24
	88ST19248311R	3931	4322	18.75	24	83	160	24
 5&6 Hi Storage Unit, Closed Bookcase, Back-Painted Glass Doors	88ST19206911LZ	4381	4819	18.75	20	69	118	16.75
	88ST19206911RZ	4381	4819	18.75	20	69	118	16.75
	88ST19246911LZ	4457	4902	18.75	24	69	132	20
	88ST19246911RZ	4457	4902	18.75	24	69	132	20
	88ST19208311LZ	4846	5332	18.75	20	83	148	20
	88ST19208311RZ	4846	5332	18.75	20	83	148	20
	88ST19248311LZ	4923	5416	18.75	24	83	160	24
	88ST19248311RZ	4923	5416	18.75	24	83	160	24
 5 & 6 Hi Storage Unit, 2 File, Remainder Open	88ST19206990	2830	3113	18.75	20	69	174	18
	88ST19246990	2952	3246	18.75	24	69	186	20.5
	88ST19208390	3117	3429	18.75	20	83	197	18
	88ST19248390	3238	3562	18.75	24	83	213	20.5

**ORDERING NOTES:**

Box and pedestal file drawers are available with a soft-closing drawer option. Please add 'S' to the end of the model number and **add \$152** . e.g. 88ST19248390S.

**DIMENSION KEY**

W - width  
D - depth  
H - height

**CODE DESCRIPTION**

11 - closed bookcase  
L - hinged left  
R - hinged right  
90 - file/file, remainder open

**STANDARD FINISHES**

For a complete list of standard wood finishes, please see page 9.

**STORAGE BOOKCASES**

Shelves are adjustable in 1.25" increments.

# ADESSO | STORAGE

Description	Model	Cherry Maple	Anigre Walnut	W	D	H	Oak	
							Shipping Weight	Cubic Feet
5 & 6 Hi Storage Unit, 2 File, Remainder Closed	88ST19206991L	2878	3164	18.75	20	69	189	18
	88ST19206991R	2878	3164	18.75	20	69	189	18
	88ST19246991L	2996	3295	18.75	24	69	201	20.5
	88ST19246991R	2996	3295	18.75	24	69	201	20.5
	88ST19208391L	3162	3477	18.75	20	83	212	18
	88ST19208391R	3162	3477	18.75	20	83	212	18
	88ST19248391L	3283	3609	18.75	24	83	225	20.5
	88ST19248391R	3283	3609	18.75	24	83	225	20.5



**ORDERING NOTES:**

Box and pedestal file drawers are available with a soft-closing drawer option. Please add 'S' to the end of the model number and **add \$152**. e.g. 88ST19248391RS.

5 & 6 Hi Storage Unit, 2 File, Remainder Closed Back Painted Glass Doors	88ST19206991LZ	3479	3827	18.75	20	69	189	18
	88ST19206991RZ	3479	3827	18.75	20	69	189	18
	88ST19246991LZ	3599	3959	18.75	24	69	201	20.5
	88ST19246991RZ	3599	3959	18.75	24	69	201	20.5
	88ST19208391LZ	3763	4140	18.75	20	83	212	18
	88ST19208391RZ	3763	4140	18.75	20	83	212	18
	88ST19248391LZ	3885	4272	18.75	24	83	225	20.5
	88ST19248391RZ	3885	4272	18.75	24	83	225	20.5



**ORDERING NOTES:**

Box and pedestal file drawers are available with a soft-closing drawer option. Please add 'S' to the end of the model number and **add \$152** e.g. 88ST19248391RZS.

5 & 6 Hi Storage, 2 Lateral Files, Remainder Closed	88ST30206904	5012	5516	29.75	20	69	213	27
	88ST30246904	5106	5614	29.75	24	69	255	33
	88ST36206904	5223	5746	35.75	20	69	260	32
	88ST36246904	5316	5847	35.75	24	69	306	38
	88ST30208304	5691	6260	29.75	20	83	246	32.5
	88ST30248304	5811	6391	29.75	24	83	291	38.5
	88ST36208304	6007	6608	35.75	20	83	297	39
	88ST36248304	6127	6739	35.75	24	83	351	46



5 & 6 Hi Storage Unit, 2 Lateral Files, Remainder Closed Back Painted Glass Doors	88ST30206904Z	5917	6510	29.75	20	69	213	27
	88ST30246904Z	6007	6608	29.75	24	69	255	33
	88ST36206904Z	6127	6739	35.75	20	69	260	32
	88ST36246904Z	6218	6840	35.75	24	69	306	38
	88ST30208304Z	6595	7255	29.75	20	83	246	32.5
	88ST30248304Z	6714	7386	29.75	24	83	291	38.5
	88ST36208304Z	6911	7602	35.75	20	83	297	39
	88ST36248304Z	7031	7733	35.75	24	83	351	46



**ORDERING PROCEDURE**

To order, please specify the following:  
 1) Krug product model number  
 2) Wood species and finish

**CODE DESCRIPTION**

91 - file/file, remainder closed  
 04 - lateral file, remainder closed  
 L - hinged left  
 R - hinged right  
 Z - back-painted glass

**STANDARD FINISHES**

For a complete list of standard wood finishes, please see page 9.



Description	Model	Oak Cherry Maple	Anigre Walnut	W	D	H	Shipping Weight	Cubic Feet
 5 & 6 Hi Storage, 2 Lateral Files, Remainder Open	88ST30206903	4712	5185	29.75	20	69	190	27
	88ST30246903	4802	5284	29.75	24	69	202	33
	88ST36206903	4923	5416	35.75	20	69	207	32
	88ST36246903	5012	5516	35.75	24	69	219	38
	88ST30208303	5345	5881	29.75	20	83	240	32.5
	88ST30248303	5466	6012	29.75	24	83	252	38.5
	88ST36208303	5660	6227	35.75	20	83	257	39
	88ST36248303	5782	6359	35.75	24	83	269	46

 5 & 6 Hi Storage Unit, 2 Closed, Remainder Open	88ST30206913	4863	5349	29.75	20	69	180	27
	88ST30246913	4953	5448	29.75	24	69	192	33
	88ST36206913	5075	5582	35.75	20	69	197	32
	88ST36246913	5166	5681	35.75	24	69	209	38
	88ST30208313	5496	6045	29.75	20	83	230	32.5
	88ST30248313	5615	6731	29.75	24	83	242	38.5
	88ST36208313	5811	6391	35.75	20	83	247	39
88ST36248313	5932	6524	35.75	24	83	269	46	

 5 & 6 Hi Storage Unit, 2 Closed Back Painted Glass Doors, Remainder Open	88ST30206913Z	5166	5681	29.75	20	69	180	27
	88ST30246913Z	5256	5781	29.75	24	69	192	33
	88ST36206913Z	5373	5913	35.75	20	69	197	32
	88ST36246913Z	5527	6078	35.75	24	69	209	38
	88ST30208313Z	5796	6375	29.75	20	83	230	32.5
	88ST30248313Z	5917	6510	29.75	24	83	242	38.5
	88ST36208313Z	6112	6722	35.75	20	83	247	39
88ST36248313Z	6232	6857	35.75	24	83	269	46	

 5 & 6 Hi Storage Unit, 4 File, Remainder Closed	88ST30206907	4396	4837	29.75	20	69	220	27
	88ST30246907	4503	4952	29.75	24	69	230	33
	88ST36206907	4667	5135	35.75	20	69	230	32
	88ST36246907	4773	5250	35.75	24	69	240	38
	88ST30208307	4802	5284	29.75	20	83	235	32.5
	88ST30248307	4906	5397	29.75	24	83	245	38.5
	88ST36208307	5087	5598	35.75	20	83	245	39
	88ST36248307	5194	5715	35.75	24	83	255	46

**DIMENSION KEY**

W - width  
D - depth  
H - height

**CODE DESCRIPTION**

03 - lateral file, remainder open  
13 - 2 closed bookcase, remainder open  
Z - back-painted glass  
07 - 4 lateral file, remainder closed

**STANDARD FINISHES**

For a complete list of standard wood finishes, please see page 9.

# ADESSO | WARDROBES

Description	Model	Oak Cherry Maple	Anigre Walnut	W	D	H	Shipping Weight	Cubic Feet
5 & 6 - Hi Single Width Wardrobe	88WR19246902L	3432	3774	18.75	24	69	132	20.5
	88WR19246902R	3432	3774	18.75	24	69	132	20.5
	88WR19248302L	3630	3993	18.75	24	83	153	20.5
	88WR19248302R	3630	3993	18.75	24	83	153	20.5



5 & 6 - Hi Single Width Wardrobe Back-Painted	88WR19246902LZ	4352	4786	18.75	24	69	132	20.5
	88WR19246902RZ	4352	4786	18.75	24	69	132	20.5
Glass doors	88WR19248302LZ	4622	5084	18.75	24	83	153	20.5
	88WR19248302RZ	4622	5084	18.75	24	83	153	20.5

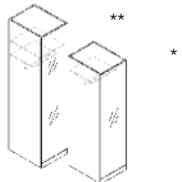

**ORDERING NOTES:**

For optional door mounted mirror add "M" to the end of the item number and **\$229 list.**

5 & 6 Hi Full Width Wardrobe	88WR36246902	5149	5662	35.75	24	69	198	38
	88WR36248302	5390	5929	35.75	24	83	218	46



5 & 6 Hi Full Width Wardrobe, Back Painted Glass Doors	88WR36246902Z	6308	6939	35.75	24	69	198	38
	88WR36248302Z	6549	7205	35.75	24	83	218	46



**ORDERING PROCEDURE**

To order, please specify the following:  
 1) Krug product model number  
 2) Wood species and finish

**CODE DESCRIPTION**

02 - closed wardrobe  
 L - hinged left  
 R - hinged right  
 Z - back-painted glass

**STANDARD FINISHES**

For a complete list of standard wood finishes, please see page 9.

**STORAGE BOOKCASES**

Shelves are adjustable in 1.25" increments.

**LOCK OPTION**

Locks are available on wood doors for an upcharge of **\$152 list** per lock. 24", 30" & 36" wardrobes require 2 locks.

Description	Model	Oak Cherry Maple	Anigre Walnut	W	D	H	Shipping Weight	Cubic Feet
5 & 6 Hi Wardrobe, Closed Shelves	88WR36246901	4299	4732	35.75	24	69	156	37.5
	88WR36246903	4299	4732	35.75	24	69	164	37.5
	88WR36248301	4506	4957	35.75	24	83	172	44.5
	88WR36248303	4506	4957	35.75	24	83	172	44.5



**ORDERING NOTES:**

Locks are available on wood doors for an upcharge of **\$152 list** per lock. Adesso wardrobes require 2 locks.

5 & 6 Hi Wardrobe, Closed Shelves, Back Painted Glass Doors	88WR36246901Z	4645	5110	35.75	24	69	156	37.5
	88WR36246903Z	4645	5110	35.75	24	69	164	37.5
	88WR36248301Z	4870	5361	35.75	24	83	172	44.5
	88WR36248303Z	4870	5361	35.75	24	83	172	44.5



5 & 6 Hi Wardrobe, 2 File & Closed Shelves	88WR36246914	5679	6246	35.75	24	69	182	37.5
	88WR36246915	5679	6246	35.75	24	69	182	37.5
	88WR36248314	6187	6807	35.75	24	83	212	44.5
	88WR36248315	6187	6807	35.75	24	83	212	44.5



**ORDERING NOTES:**

Box and pedestal file drawers are available with a soft-closing drawer option. Please add 'S' to the end of the model number and **add \$152**. e.g. 88ST36241316S.

5 & 6 Hi Wardrobe, 2 File & Closed Shelves Back Painted Glass Doors	88WR36246914Z	6135	6745	35.75	24	69	182	37.5
	88WR36246915Z	6135	6745	35.75	24	69	182	37.5
	88WR36248314Z	6684	7350	35.75	24	83	212	44.5
	88WR36248315Z	6684	7350	35.75	24	83	212	44.5



**ORDERING NOTES:**

Box and pedestal file drawers are available with a soft-closing drawer option. Please add 'S' to the end of the model number and **add \$152**. e.g. 88ST36241316S.

**DIMENSION KEY**

W - width  
D - depth  
H - height

**CODE DESCRIPTION**

01 - shelves/ wardrobe  
03 - wardrobe/ shelves  
14 - closed left shelves, 2 file drawers  
closed right wardrobe.  
15 - closed left shelves, 2 file drawers  
closed right wardrobe.  
Z - back-painted glass

**STANDARD FINISHES**

For a complete list of standard wood finishes, please see page 9.

**STORAGE BOOKCASES**

Shelves are adjustable in 1.25" increments.

**LOCK OPTION**

Locks are available on wood doors for an upcharge of **\$152 list** per lock. 24", 30" & 36" wardrobes require 2 locks.

# ADESSO | MOBILE PEDESTALS & BENCHES

Description	Model	Oak		W	D	H	Shipping Weight	Cubic Feet
		Cherry Maple	Anigre Walnut					
Mobile Pedestal, Box/Box/File	88MP16204F	2322	2554	16	20	27.75	82	5.75



Mobile Pedestal, File/File	88MP16204D	2136	2352	16	20	27.75	86	5.75
----------------------------	------------	------	------	----	----	-------	----	------



**ORDERING NOTES:**

Box and pedestal file drawers are available with a soft-closing drawer option. Please add 'S' to the end of the model number and **add \$152** e.g. 88MP16204FS.

1 Hi Bench, Lateral File	88BN30201701	2381	2615	29.75	20	17	122	7
	88BN30241701	2410	2650	29.75	24	17	118	8.25
	88BN36201701*	2486	2735	35.75	30	17	134	8.25
	88BN36241701	2516	2767	35.75	24	17	132	9.75



1 Hi Bench, Closed Bookcase	88BN30201711	2530	2781	29.75	20	17	64	7
	88BN30241711	2560	2816	29.75	24	17	62	8.25
	88BN36201711*	2636	2899	35.75	20	17	76	8.25
	88BN36241711	2665	2933	35.75	24	17	84	9.75



1 Hi Bench, Open Bookcase	88BN30201717	2440	2683	29.75	20	17	54	7
	88BN30241717	2470	2716	29.75	24	17	62	8.25
	88BN36201717*	2516	2767	35.75	20	17	66	8.25
	88BN36241717	2545	2800	35.75	24	17	74	9.75

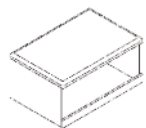

**ORDERING PROCEDURE**

To order, please specify the following:  
 1) Krug product model number  
 2) Wood species and finish

**CODE DESCRIPTION**

01 - shelves/ wardrobe  
 11 - closed bookcase  
 17 - open bookcase  
 F - 2 box, 1 file drawer  
 D - 2 file drawer

**STANDARD FINISHES**

For a complete list of standard wood finishes, please see page 9.

**STORAGE BOOKCASES**

Shelves are adjustable in 1.25" increments.

Description	Model	Oak Cherry Maple	Anigre Walnut	W	D	H	Shipping Weight	Cubic Feet
1.5 Hi Bench, Lateral Box/Lateral File	88BN30202316	2650	2916	29.75	20	23	147	9.25
	88BN30242316	2681	2948	29.75	24	23	153	11
	88BN36202316*	2741	3014	35.75	20	23	159	11
	88BN36242316	2787	3066	35.75	24	23	167	13

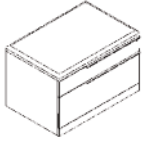

1.5 - Hi Bench Open/Lateral File	88BN30202315	2726	2998	29.75	20	23	137	9.25
	88BN30242315	2756	3031	29.75	24	23	143	11
	88BN36202315*	2802	3080	35.75	20	23	149	11
	88BN36242315	2891	3181	35.75	24	23	157	13

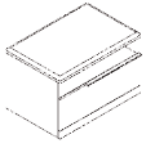

1.5 - Hi Bench Closed Bookcase	88BN30202311	2936	3232	29.75	20	23	92	9.25
	88BN30242311	2983	3279	29.75	24	23	96	11
	88BN36202311*	3040	3345	35.75	20	23	94	11
	88BN36242311	3088	3396	35.75	24	23	98	13

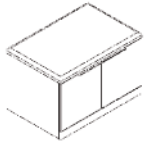

1.5 Hi Bench Open Bookcase	88BN30202317	2817	3097	29.75	20	23	82	9.25
	88BN30242317	2847	3132	29.75	24	23	86	11
	88BN36202317*	2921	3214	35.75	20	23	84	11
	88BN36242317	2966	3265	35.75	24	23	88	13

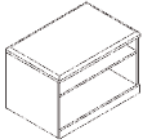

**UPHOLSTERED CUSHION UPCHARGES FOR BENCHES:**

COM and Grade 1 textiles can be specified at no upcharge. For Grade 2-9 textiles, use the chart below to find the upcharge and add it to the price of the bench. For Krug stocked and graded-in textiles, please see our textile cards Box and pedestal file drawers are available with a self-closing drawer option. Please add "S" to the end of the model number and **add \$152** list per pedestal. Lateral file drawers are not available with this option.

**Bench Fabric Grades upcharges**

	2	3	4	5	6	7	8	9
30" Bench	52	102	160	259	361	460	561	661
36" Bench	59	116	174	288	403	517	633	746

**DIMENSION KEY**

W - width  
D - depth  
H - height

**CODE DESCRIPTION**

11 - closed bookcase  
15 - open, lateral fil  
16 - lateral box, lateral file  
17 - open bookcase

**STANDARD FINISHES**

For a complete list of standard wood finishes, please see page 9.

**STORAGE BOOKCASES**

Shelves are adjustable in 1.25" increments.

# ADESSO | RECEPTION & ADMINISTRATIVE WORKSTATIONS

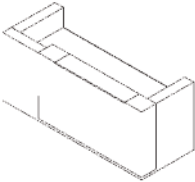
Description	Model	Oak Cherry Maple	Anigre Walnut	W	D	H	Shipping Weight	Cubic Feet	
	Stand Alone Desk	88GDS6036TCL	8971	9868	61.25	37.5	43.5	466	65.5
	with Offset	88GDS6036TCR	8971	9868	61.25	37.5	43.5	466	65.5
	Transaction Counter	88GDS6636TCL	9363	10300	67.25	37.5	43.5	506	71.5
		88GDS6636TCR	9363	10300	67.25	37.5	43.5	506	71.5
		88GDS7236TCL	9710	10680	73	37.5	43.5	544	78
		88GDS7236TCR	9710	10680	73	37.5	43.5	544	78
		88GDS7836TCL	10221	11243	79	37.5	43.5	584	84
		88GDS7836TCR	10221	11243	79	37.5	43.5	584	84
		88GDS8436TCL	10480	11524	85	37.5	43.5	621	90
		88GDS8436TCR	10480	11524	85	37.5	43.5	621	90
		88GDS9636TCL*	10929	12021	97	37.5	43.5	694	102.5
		88GDS9636TCR	10929	12021	97	37.5	43.5	694	102.5

**ORDERING NOTES:**

Please note that Transaction Counter comes standard in veneer. For a Transaction Counter with Palette finish add "P" to the end of the model number. e.g. 88GDS9636TCLP. Transaction Counters are available with a solid surface insert, to order this option please contact customer service for quote. Reception desk with Palette Transaction Counter and solid surface insert e.g. 88GDS9636TCLPS. Worksurfaces are 30" deep.

	Desk with Offset	88GDR6036TCL	8250	9074	61.25	37.5	43.5	466	65.5
	Transaction Counter	88GDL6036TCR	8250	9074	61.25	37.5	43.5	466	65.5
	for L&U Work Station	88GDR6636TCL	8537	9388	67.25	37.5	43.5	506	71.5
	Configurations	88GDL6636TCR	8537	9388	67.25	37.5	43.5	506	71.5
		88GDR7236TCL	8852	9736	73	37.5	43.5	544	78
		88GDL7236TCR	8537	9388	73	37.5	43.5	544	78
		88GDR7836TCL	8537	9388	79	37.5	43.5	584	84
		88GDL7836TCR	9168	10085	79	37.5	43.5	584	84
		88GDR8436TCL	9499	10451	85	37.5	43.5	621	90
		88GDL8436TCR	9499	10451	85	37.5	43.5	621	90
		88GDR9636TCL*	9831	10813	97	37.5	43.5	694	102.5
		88GDL9636TCR			97	37.5	43.5	694	102.5

**ORDERING NOTES:**

Please note that Transaction Counter comes standard in veneer. For a Transaction Counter with Palette finish add "P" to the end of the model number. e.g. 88GDS9636TCLP. Transaction Counters are available with a solid surface insert, to order this option please contact customer service for quote. Reception desk with Palette Transaction Counter and solid surface insert e.g. 88GDS9636TCLPS. Worksurfaces are 30" deep.

	Modular Pedestals	88P16284F*	1854	2037	15.75	28	28	74	9
	for Administrative/ Reception Stations	88P16284D	1854	2037	15.75	28	28	74	9

**ORDERING NOTES:**

Box and pedestal file drawers are available with a soft-closing drawer option. Please add 'S' to the end of the model number and **add \$152**. e.g. 88MP16204FS.

**ORDERING PROCEDURE**

To order, please specify the following:  
 1) Krug product model number  
 2) Wood species and finish

**CODE DESCRIPTION**

GD - gallery desk  
 TC - transaction counter  
 L - left handed position  
 R - right handed position  
 F - 2 box, 1 fil  
 D - 2 fil

**STANDARD FINISHES**

For a complete list of standard wood finishes, please see page 9.

**STORAGE BOOKCASES**

Shelves are adjustable in 1.25" increments.

# ADESSO | RECEPTION & ADMINISTRATIVE WORKSTATIONS

Description	Model	Oak		W	D	H	Shipping Weight	Cubic Feet
		Cherry Maple	Anigre Walnut					
	88GLW72L	4155	4571	71.5	6	42	142	15
	88GLW72R	4277	4705					
	88GLW78L	4277	4705	77.5	6	42	134	17.5
	88GLW78R	4396	4837					
	88GLW84L	4396	4837	83.5	6	42	168	18.5
	88GLW78R	4486	4933					
	88GLW86L	4486	4933	85.3	6	42	169	19
	88GLW86R	4592	5052					
	88GLW90L	4592	5052	89.5	6	42	178	19.5
	88GLW90R	4697	5168					
	88GLW92L	4697	5168	91.5	6	42	182	20
	88GLW92R*	4863	5349					
	88GLW96L	4863	5349	95.5	6	42	189	21
	88GLW96R	4968	5465					
	88GLW98L	4968	5465	97.5	6	42	193	21.5
	88GLW98R	5135	5647					
	88GLW102L	5135	5647	101.5	6	42	201	22.5
	88GLW102R							

L Work Station Configuration	Linking Wall Size	Desk Worksurface Depth	Return Length
	72"	30"	42"
	78"	30"	48"
	84"	30"	54"
	90"	30"	60"
	96"	30"	66"
	102"	30"	72"

U Work Station Configuration	Linking Wall Size	Desk Worksurface Depth	Linking top Length	Credenza Worksurface Depth
	86"	30"	36"	20"
	90"	30"	36"	24"
	92"	30"	42"	20"
	96"	30"	42"	24"
	98"	30"	48"	20"
	102"	30"	48"	24"

**DIMENSION KEY**

W - width  
D - depth  
H - height





**CODE DESCRIPTION**

GLW- gallery linking wall  
L - left handed position  
R - right handed position

**STANDARD FINISHES**

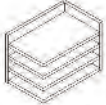
For a complete list of standard wood finishes, please see page 9.

# ADESSO | RECEPTION & ADMINISTRATIVE WORKSTATIONS

Description	Model	Oak		W	D	H	Shipping Weight	Cubic Feet
		Cherry Maple	Anigre Walnut					
Paper Manager Units 	88PMG16111204L	994	1093	16	11	12	20	2
	88PMG16111204R*	994	1093	16	11	12	20	2
Reception Linking Top 	88GLT3624	912	1003	35.75	24	-	33	2.5
	88GLT4224	981	1080	41.75	24	-	38	5.3
	88GLT4824*	1046	1153	47.75	24	-	44	3.25
Reception Linking Runoffs for 3/4 Height Credenzas 	88GLT60243L	1626	1789	56	24	-	60	4.5
	88GLT60243R	1626	1789	56	24	-	60	4.5
	88GLT66243L	1764	1940	62	24	-	66	5
	88GLT66243R	1764	1940	62	24	-	66	5
	88GLT72243L*	1897	2087	68	24	-	71	5.5
88GLT72243R	1897	2087	68	24	-	71	5.5	
Return 	88GRH4226L	5660	6227	71.75	26	41.5	264	16.5
	88GRH4226R	5660	6227	71.75	26	41.5	264	16.5
	88GRH4230L	5811	6377	71.75	30	41.5	273	17
	88GRH4230R	5811	6377	71.75	30	41.5	273	17
	88GRH4826L	5766	6333	77.75	26	41.5	283	18
	88GRH4826R	5766	6333	77.75	26	41.5	283	18
	88GRH4830L	5917	6483	77.75	30	41.5	293	18.5
	88GRH4830R	5917	6483	77.75	30	41.5	293	18.5
	88GRH5426L	5870	6438	83.75	26	41.5	303	19.5
	88GRH5426R	5919	6438	83.75	26	41.5	303	19.5
	88GRH5430L	6021	6586	83.75	30	41.5	314	20.25
	88GRH5430R	6021	6586	83.75	30	41.5	314	20.25
	88GRH6026L	5977	6543	89.75	26	41.5	322	21.25
	88GRH6026R	5977	6543	89.75	26	41.5	322	21.25
	88GRH6030L	6127	6692	89.75	30	41.5	334	21.75
	88GRH6030R	6127	6692	89.75	30	41.5	334	21.75
	88GRH6626L	6081	6648	95.75	26	41.5	342	22.5
	88GRH6626R	6081	6648	95.75	26	41.5	342	22.5
	88GRH6630L	6232	6797	95.75	30	41.5	354	23.25
	88GRH6630R	6232	6797	95.75	30	41.5	354	23.25
88GRH7226L	6187	6754	101.75	26	41.5	361	24.25	
88GRH7226R	6187	6754	101.75	26	41.5	361	24.25	
88GRH7230L	6337	6905	101.75	30	41.5	376	25	
88GRH7230R*	6337	6905	101.75	30	41.5	376	25	
Return with Gables 	88GRHG4230L	6549	7205	71.75	30	41.5	292	19.5
	88GRHG4230R	6549	7205	71.75	30	41.5	292	19.5
	88GRHG4830L	6835	7519	77.75	30	41.5	315	24
	88GRHG4830R	6835	7519	77.75	30	41.5	315	24
	88GRHG6030L	7091	7800	89.75	30	41.5	356	28
	88GRHG6030R	7091	7800	89.75	30	41.5	356	28
	88GRHG7230L	7512	8263	101.75	30	41.5	396	32.5
	88GRHG7230R*	7512	8263	101.75	30	41.5	396	32.5

**ORDERING PROCEDURE**

To order, please specify the following:  
 1) Krug product model number  
 2) Wood species and finish

**CODE DESCRIPTION**

L - left handed position  
 R - right handed position  
 F - 2 box, 1 file  
 D - 2 file

**STANDARD FINISHES**

For a complete list of standard wood finishes, please see page 9.



# ADESSO | RECEPTION & ADMINISTRATIVE WORKSTATIONS

Description	Model	Oak		W	D	H	Shipping Weight	Cubic Feet
		Cherry Maple	Anigre Walnut					
Single Pedestal	88GRH4226L4D	6911	7602	71.75	26	41.5	317	24
Return, continued	88GRH4226R4D	6911	7602	71.75	26	41.5	317	24
	88GRH4226L4F	6956	7651	71.75	26	41.5	317	24
	88GRH4226R4F	6956	7651	71.75	26	41.5	317	24
	88GRH4230L4D	7212	7933	71.75	30	41.5	328	25
	88GRH4230R4D	7212	7933	71.75	30	41.5	328	25
	88GRH4230L4F	7257	7982	71.75	30	41.5	328	25
	88GRH4230R4F	7257	7982	71.75	30	41.5	328	25
	88GRH4826L4D	7152	7866	77.75	26	41.5	337	26
	88GRH4826R4D	7152	7866	77.75	26	41.5	337	26
	88GRH4826L4F	7195	7915	77.75	26	41.5	337	26
	88GRH4826R4F	7195	7915	77.75	26	41.5	337	26
	88GRH4830L4D	7452	8197	77.75	30	41.5	349	28
	88GRH4830R4D	7452	8197	77.75	30	41.5	349	28
	88GRH4830L4F	7497	8248	77.75	30	41.5	349	28
	88GRH4830R4F	7497	8248	77.75	30	41.5	349	28
	88GRH5426L4D	7422	8164	83.75	26	41.5	356	27.25
	88GRH5426R4D	7422	8164	83.75	26	41.5	356	27.25
	88GRH5426L4F	7466	8213	83.75	26	41.5	356	27.25
	88GRH5426R4F	7466	8213	83.75	26	41.5	356	27.25
	88GRH5430L4D	7724	8496	83.75	30	41.5	369	29.25
	88GRH5430R4D	7724	8496	83.75	30	41.5	369	29.25
	88GRH5430L4F	7766	8544	83.75	30	41.5	369	29.25
	88GRH5430R4F	7766	8544	83.75	30	41.5	369	29.25
	88GRH6026L4D	7617	8380	89.75	26	41.5	376	30
	88GRH6026R4D	7617	8380	89.75	26	41.5	376	30
	88GRH6026L4F	7661	8430	89.75	26	41.5	376	30
	88GRH6026R4F	7661	8430	89.75	26	41.5	376	30
	88GRH6030L4D	7919	8709	89.75	30	41.5	389	32
	88GRH6030R4D	7919	8709	89.75	30	41.5	389	32
	88GRH6030L4F	7965	8760	89.75	30	41.5	389	32
	88GRH6030R4F	7965	8760	89.75	30	41.5	389	32
	88GRH6626L4D	7814	8594	95.75	26	41.5	396	32
	88GRH6626R4D	7814	8594	95.75	26	41.5	396	32
	88GRH6626L4F	7860	8644	95.75	26	41.5	396	32
	88GRH6626R4F	7860	8644	95.75	26	41.5	396	32
	88GRH6630L4D	8116	8925	95.75	30	41.5	410	34
	88GRH6630R4D	8116	8925	95.75	30	41.5	410	34
	88GRH6630L4F	8159	8975	95.75	30	41.5	410	34
	88GRH6630R4F	8159	8975	95.75	30	41.5	410	34
	88GRH7226L4D	8039	8843	101.75	26	41.5	414	33.5
	88GRH7226R4D	8039	8843	101.75	26	41.5	414	33.5
	88GRH7226L4F	8085	8893	101.75	26	41.5	414	33.5
	88GRH7226R4F*	8085	8893	101.75	26	41.5	414	33.5
	88GRH7230L4D	8340	9173	101.75	30	41.5	429	35.5
	88GRH7230R4D	8340	9173	101.75	30	41.5	429	35.5
	88GRH7230L4F	8386	9224	101.75	30	41.5	429	35.5
	88GRH7230R4F	8386	9224	101.75	30	41.5	429	35.5

**ORDERING NOTES:**

Box and pedestal file drawers are available with a soft-closing drawer option. Please add 'S' to the end of the model number and **add \$152** e.g. 88MP16204FS.

**DIMENSION KEY**

W - width  
D - depth  
H - height

**CODE DESCRIPTION**

L - left handed position  
R - right handed position  
F - 2 box, 1 file  
D - 2 file

**STANDARD FINISHES**

For a complete list of standard wood finishes, please see page 9.

# ADESSO MEDIA HUB | 1 TV AREA

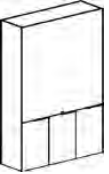
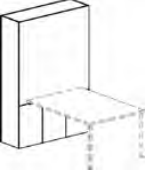
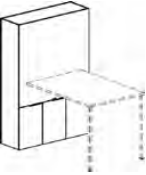
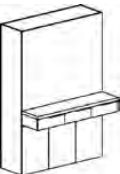
Description	Model	Oak		W	D	H	Shipping Weight	Cubic Feet
		Cherry Maple	Anigre Walnut					
Media Hub, 1 TV Area no Runoff 	88MH54187211S1	6346	6981	53.75	17.75	72	359	57.75
	88MH54188011S1	6536	7189	53.75	17.75	80	399	63.75
	88MH60187211S1*	6665	7333	59.75	17.75	72	385	63.5
	88MH60188011S1	6867	7552	59.75	17.75	80	437	70.25
Media Hub, 1 TV Area, Desk Ht. Runoff 	88MH54187211S14	6346	6981	53.75	17.75	72	359	57.75
	88MH54188011S14	6536	7189	53.75	17.75	80	399	63.75
	88MH60187211S14*	6665	7333	59.75	17.75	72	385	63.5
	88MH60188011S14	6867	7552	59.75	17.75	80	437	70.25
Media Hub, 1 TV Area, Bar Ht. Runoff 	88MH54187211S16	6346	6981	53.75	17.75	72	359	57.75
	88MH54188011S16	6536	7189	53.75	17.75	80	399	63.75
	88MH60187211S16*	6665	7333	59.75	17.75	72	385	63.5
	88MH60188011S16	6867	7552	59.75	17.75	80	437	70.25
Media Hub, 1 TV Area, Drawers 	88MH54187211S1B	8833	9716	53.75	17.75	72	359	57.75
	88MH54188011S1B	9022	9922	53.75	17.75	80	399	63.75
	88MH60187211S1B*	9231	10155	59.75	17.75	72	385	63.5
	88MH60188011S1B	9432	10375	59.75	17.75	80	437	70.25

**ORDERING NOTES:**

Please note that runoff tops and bases are sold separately, please see pages 98-100 for item numbers and pricing.

**ORDERING PROCEDURE**

To order, please specify the following:  
 1) Krug product model number  
 2) Wood species and finish



**CODE DESCRIPTION**

S1 - 1 TV area  
 11 - closed bookcase  
 B - drawer bank  
 4 - use with desk height runoff  
 6 - use with bar height runoff

**STANDARD FINISHES**

For a complete list of standard wood finishes, please see page 9.

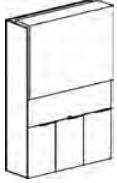
## ADESSO MEDIA HUB | 1 TV AREA, 1 HANG OVER PANEL

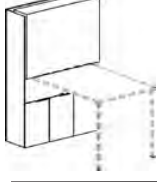
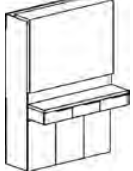
Description	Model	Oak		W	D	H	Shipping Weight	Cubic Feet
		Cherry Maple	Anigre Walnut					
Media Hub, 1 Hang-over Panel, 1 TV Area no Runoff 	88MH54217211S1	8393	9231	53.75	20.75	72	442	65.25
	88MH54218011S1	8644	9508	53.75	20.75	80	493	72.25
	88MH60217211S1*	8919	9812	59.75	20.75	72	468	71.75
	88MH60218011S1	9187	10106	59.75	20.75	80	543	79.5
Media Hub, 1 Hang-over Panel, 1 TV Area no Runoff 	88MH54217211S14	8393	9231	53.75	20.75	72	442	65.25
	88MH54218011S14	8644	9508	53.75	20.75	80	493	72.25
	88MH60217211S14*	8919	9812	59.75	20.75	72	468	71.75
	88MH60218011S14	9187	10106	59.75	20.75	80	543	79.5
Media Hub, 1 Hang-over Panel, 1 TV Area, Bar Ht. Runoff 	88MH54217211S16	8393	9231	53.75	20.75	72	442	65.25
	88MH54218011S16	8644	9508	53.75	20.75	80	493	72.25
	88MH60217211S16*	8919	9812	59.75	20.75	72	468	71.75
	88MH60218011S16	9187	10106	59.75	20.75	80	543	79.5
Media Hub, 1 Hang-over Panel, 1 TV Area, Drawers 	88MH54211011S1B	10881	11967	53.75	20.75	72	442	65.25
	88MH54218011S1B	11130	12244	53.75	20.75	80	493	72.25
	88MH60217211S1B*	11484	12634	59.75	20.75	72	468	71.75
	88MH60218011S1B	11750	12926	59.75	20.75	80	543	79.5

**ORDERING NOTES:**

Please note that runoff tops and bases are sold separately, please see pages 98-100 for item numbers and pricing. Hangover panel is available in veneer or palette. If not specified white palette is default.

**DIMENSION KEY**

W - width  
D - depth  
H - height

**CODE DESCRIPTION**

S1 - 1 TV area  
11 - closed bookcase  
B - drawer bank  
4 - use with desk height runoff  
6 - use with bar height runoff

**STANDARD FINISHES**

For a complete list of standard wood finishes, please see page 9.

# ADESSO MEDIA HUB | 1 TV AREA, 1 HANG OVER PANEL, WHITE BOARD

Description	Model	Oak		W	D	H	Shipping Weight	Cubic Feet
		Cherry Maple	Anigre Walnut					
Media Hub, 1 Hang-over Panel with White Board, 1 TV Area, no Runoff	88MH54217211S1WB	10179	11197	53.75	20.75	72	455	65.25
	88MH54218011S1WB	10486	11535	53.75	20.75	80	506	72.25
	88MH60217211S1WB*	11182	12300	59.75	20.75	72	481	71.75
	88MH60218011S1WB	11517	12669	59.75	20.75	80	556	79.5

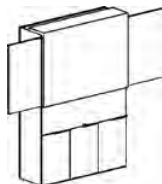

Media Hub, 1 Hang-over Panel with White Board, 1 TV Area, Desk Ht. Runoff	88MH54217211S1WB14	10179	11197	53.75	20.75	72	455	65.25
	88MH54218011S1WB14	10486	11535	53.75	20.75	80	506	72.25
	88MH60217211S1WB14*	11182	12300	59.75	20.75	72	481	71.75
	88MH60218011S1WB14	11517	12669	59.75	20.75	80	556	79.5



Media Hub, 1 Hang-over Panel with White Board, 1 TV Area, Bar Ht. Runoff	88MH54217211S1WB16	10179	11197	53.75	20.75	72	455	65.25
	88MH54218011S1WB16	10486	11535	53.75	20.75	80	506	72.25
	88MH60217211S1WB16*	11182	12300	59.75	20.75	72	481	71.75
	88MH60218011S1WB16	11517	12669	59.75	20.75	80	556	79.5

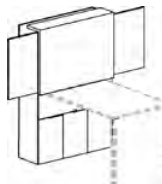

Media Hub, 1 Hang-over Panel with White Board, 1 TV Area, Drawers	88MH54221011S1WB1B	12667	13933	53.75	20.75	72	455	65.25
	88MH54218011S1WB1B	12972	14270	53.75	20.75	80	506	72.25
	88MH60217211S1WB1B*	13746	15121	59.75	20.75	72	481	71.75
	88MH60218011S1WB1B	14082	15489	59.75	20.75	80	556	79.5

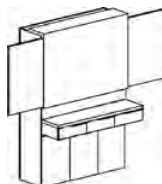

**ORDERING NOTES:**

Please note that hangover tops and bases are sold separately, please see pages 98-100 for item numbers and pricing. Hangover panel is available in veneer or palette. If not specified white palette is default.

**ORDERING PROCEDURE**

To order, please specify the following:  
 1) Krug product model number  
 2) Wood species and finish

**CODE DESCRIPTION**

S1 - 1 TV area  
 WB - white board  
 11 - closed bookcase  
 B - drawer bank  
 4 - use with desk height runoff  
 6 - use with bar height runoff

**STANDARD FINISHES**

For a complete list of standard wood finishes, please see page 9.

## ADESSO MEDIA HUB | 1 TV AREA, 1 HANG OVER PANEL

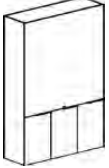
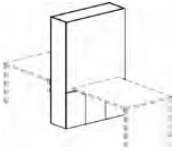
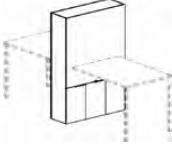
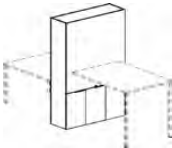
Description	Model	Oak Cherry Maple	Anigre Walnut	W	D	H	Shipping Weight	Cubic Feet
Media Hub, 2 TV Areas no Runoff 	88MH54187211S2	6440	7084	53.75	17.75	72	359	57.75
	88MH54188011S2	6633	7296	53.75	17.75	80	399	63.75
	88MH60187211S2*	6766	7443	59.75	17.75	72	385	63.5
	88MH60188011S2	6970	7668	59.75	17.75	80	437	70.25
Media Hub, 2 TV Areas, Desk Ht. Runoff 	88MH54187211S244	6440	7084	53.75	17.75	72	359	57.75
	88MH54188011S244	6633	7296	53.75	17.75	80	399	63.75
	88MH60187211S244*	6766	7443	59.75	17.75	72	385	63.5
	88MH60188011S244	6970	7668	59.75	17.75	80	437	70.25
Media Hub, 2 TV Areas, Bar Ht. Runoff 	88MH54187211S266	6440	7084	53.75	17.75	72	359	57.75
	88MH54188011S266	6633	7296	53.75	17.75	80	399	63.75
	88MH60187211S266*	6766	7443	59.75	17.75	72	385	63.5
	88MH60188011S266	6970	7668	59.75	17.75	80	437	70.25
Media Hub, 2 TV Areas, 1 Desk & 1 Bar Ht. Runoff 	88MH54187211S246	6440	7084	53.75	17.75	72	359	57.75
	88MH54188011S246	6633	7296	53.75	17.75	80	399	63.75
	88MH60187211S246*	6766	7443	59.75	17.75	72	385	63.5
	88MH60188011S246	6970	7668	59.75	17.75	80	437	70.25

**ORDERING NOTES:**

Please note that runoff tops and bases are sold separately, please see pages 98-100 for item numbers and pricing.

**DIMENSION KEY**

W - width  
 D - depth  
 H - height

**CODE DESCRIPTION**

S1 - 1 TV area  
 S2 - 2 TV areas  
 WB - white board  
 11 - closed bookcase  
 B - drawer bank  
 4 - use with desk height runoff  
 6 - use with bar height runoff

**STANDARD FINISHES**

For a complete list of standard wood finishes, please see page 9.

# ADESSO MEDIA HUB | 2 TV AREAS

Description	Model	Oak		W	D	H	Shipping Weight	Cubic Feet
		Cherry Maple	Anigre Walnut					
Media Hub, 2 TV Areas, Drawers/Desk Ht. Runoff	88MH54187211S2B4	8930	9820	53.75	17.75	72	359	57.75
	88MH54188011S2B4	9120	10033	53.75	17.75	80	399	63.75
	88MH60187211S2B4*	9333	10264	59.75	17.75	72	385	63.5
	88MH60188011S2B4	9536	10488	59.75	17.75	80	437	70.25

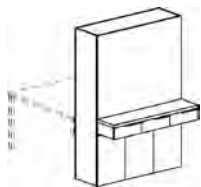

Media Hub, 2 TV Areas, Drawers/Bar Ht. Runoff	88MH54187211S2B6	8930	9820	53.75	17.75	72	359	57.75
	88MH54188011S2B6	9120	10033	53.75	17.75	80	399	63.75
	88MH60187211S2B6*	9333	10264	59.75	17.75	72	385	63.5
	88MH60188011S2B6	9536	10488	59.75	17.75	80	437	70.25

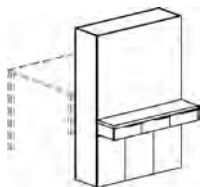

Media Hub, 2 TV Areas, 2 Drawers	88MH54187211S2BB	11415	12556	53.75	17.75	72	359	57.75
	88MH54188011S2BB	11609	12771	53.75	17.75	80	399	63.75
	88MH60187211S2BB*	11896	13087	59.75	17.75	72	385	63.5
	88MH60188011S2BB	12098	13309	59.75	17.75	80	437	70.25

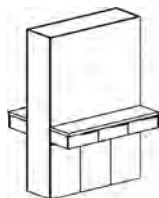

**ORDERING NOTES:**

Please note that runoff tops and bases are sold separately, please see pages 98-100 for item numbers and pricing.

**ORDERING PROCEDURE**

To order, please specify the following:  
 1) Krug product model number  
 2) Wood species and finis

**CODE DESCRIPTION**

S1 - 1 TV area  
 S2 - 2 TV areas  
 WB - white board  
 11 - closed bookcase  
 B - drawer bank  
 4 - use with desk height runoff  
 6 - use with bar height runoff

**STANDARD FINISHES**

For a complete list of standard wood finishes, please see page 9.

## ADESSO MEDIA HUB | 2 TV AREAS, 1 HANG OVER PANEL

Description	Model	Oak Cherry Maple	Anigre Walnut	W	D	H	Shipping Weight	Cubic Feet
Media Hub, 1 Hang-over Panel, 2 TV Areas no Runoff	88MH54217211S2	10534	11588	53.75	20.75	72	442	65.25
	88MH54218011S2	10851	11937	53.75	20.75	80	493	72.25
	88MH60217211S2*	11182	12300	59.75	20.75	72	468	71.75
	88MH60218011S2	11517	12669	59.75	20.75	80	543	79.5

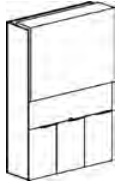

Media Hub, 1 Hang-over Panel, 2 TV Areas, Desk Ht. Runoff	88MH54217211S244	10534	11588	53.75	20.75	72	442	65.25
	88MH54218011S244	10851	11937	53.75	20.75	80	493	72.25
	88MH60217211S244*	11182	12300	59.75	20.75	72	468	71.75
	88MH60218011S244	11517	12669	59.75	20.75	80	543	79.5

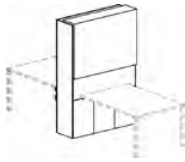

Media Hub, 1 Hang-over Panel, 2 TV Areas, Bar Ht. Runoff	88MH54217211S266	10534	11588	53.75	20.75	72	442	65.25
	88MH54218011S266	10851	11937	53.75	20.75	80	493	72.25
	88MH60217211S266*	11182	12300	59.75	20.75	72	468	71.75
	88MH60218011S266	11517	12669	59.75	20.75	80	543	79.5

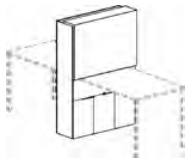

Media Hub, 1 Hang-over Panel, 2 TV Areas, Desk Ht./ Bar Ht. Runoff	88MH54217211S246	10534	11588	53.75	20.75	72	442	65.25
	88MH54218011S246	10851	11937	53.75	20.75	80	493	72.25
	88MH60217211S246*	11182	12300	59.75	20.75	72	468	71.75
	88MH60218011S246	11517	12669	59.75	20.75	80	543	79.5

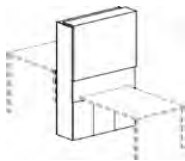

**ORDERING NOTES:**

Please note that runoff tops and bases are sold separately, please see pages 98-100 for item numbers and pricing. Hangover panel is available in veneer or palette. If not specified white palette is default.

**DIMENSION KEY**

W - width  
D - depth  
H - height

**CODE DESCRIPTION**

S2 - 2 TV areas  
11 - closed bookcase  
B - drawer bank  
4 - use with desk height runoff  
6 - use with bar height runoff

**STANDARD FINISHES**

For a complete list of standard wood finishes, please see page 9.

# ADESSO MEDIA HUB | 2 TV AREAS, 1 HANG OVER PANEL

Description	Model	Oak		W	D	H	Shipping Weight	Cubic Feet
		Cherry Maple	Anigre Walnut					
Media Hub, 1 Hang-over Panel, 2 TV	88MH54217211S264	10534	11588	53.75	20.75	72	442	65.25
Areas, Bar Ht./ Desk	88MH54218011S264	10851	11107	53.75	20.75	80	493	72.25
Ht. Runoff	88MH60217211S264*	11182	12300	59.75	20.75	72	468	71.75
	88MH60218011S264	11517	12669	59.75	20.75	80	543	79.5

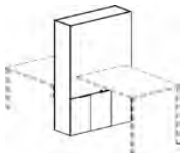

Media Hub, 1 Hang-over Panel, 2 TV	88MH54217211S2B4	13021	14323	53.75	20.75	72	442	65.25
Areas, Drawers/	88MH54218011S2B4	13340	14671	53.75	20.75	80	493	72.25
Desk Ht. Runoff	88MH60217211S2B4*	13746	15121	59.75	20.75	72	468	71.75
	88MH60218011S2B4	14082	15489	59.75	20.75	80	543	79.5

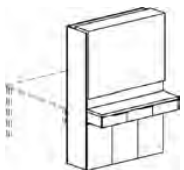

Media Hub, 1 Hang-over Panel, 2 TV	88MH54217211S24B	13021	14323	53.75	20.75	72	442	65.25
Areas, Desk	88MH54218011S24B	13340	14671	53.75	20.75	80	493	72.25
Ht. Runoff/Drawers	88MH60217211S24B*	13746	15121	59.75	20.75	72	468	71.75
	88MH60218011S24B	14082	15489	59.75	20.75	80	543	79.5

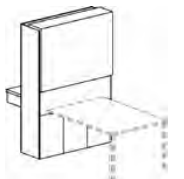

Media Hub, 1 Hang-over Panel, 2 TV	88MH54217211S2B6	13021	14075	53.75	20.75	72	442	65.25
Areas, Drawers/ Bar	88MH54218011S2B6	13340	14424	53.75	20.75	80	493	72.25
Ht. Runoff	88MH60217211S2B6*	13746	14865	59.75	20.75	72	468	71.75
	88MH60218011S2B6	14082	15234	59.75	20.75	80	543	79.5

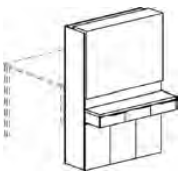

**ORDERING NOTES:**

Please note that runoff tops and bases are sold separately, please see pages 98-100 for item numbers and pricing. Hangover panel is available in veneer or palette. If not specified white palette is default.

**ORDERING PROCEDURE**

To order, please specify the following:  
 1) Krug product model number  
 2) Wood species and finish

**CODE DESCRIPTION**

S2 - 2 TV areas  
 WB - white board  
 11 - closed bookcase  
 B - drawer bank  
 4 - use with desk height runoff  
 6 - use with bar height runoff

**STANDARD FINISHES**

For a complete list of standard wood finishes, please see page 9.



## ADESSO MEDIA HUB | 2 TV AREAS, 1 HANG OVER PANEL

Description	Model	Oak Cherry Maple	Anigre Walnut	W	D	H	Shipping Weight	Cubic Feet
Media Hub, 1 Hang-over Panel, 2 TV Areas, Bar Ht. Runoff/Drawers	88MH54217211S26B	13021	14075	53.75	20.75	72	442	65.25
	88MH54218011S26B	13340	14424	53.75	20.75	80	493	72.25
	88MH60217211S26B*	13746	14865	59.75	20.75	72	468	71.75
	88MH60218011S26B	14082	15234	59.75	20.75	80	543	79.5

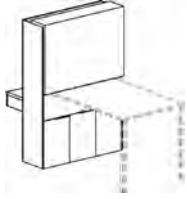

Media Hub, 1 Hang-over Panel, 2 TV Areas, 2 Drawers	88MH54217211S2BB	15509	17059	53.75	20.75	72	442	65.25
	88MH54218011S2BB	15825	17409	53.75	20.75	80	493	72.25
	88MH60217211S2BB*	16312	17942	59.75	20.75	72	468	71.75
	88MH60218011S2BB	16647	18312	59.75	20.75	80	543	79.5

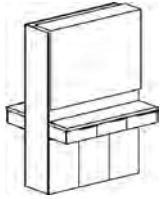

**ORDERING NOTES:**

Please note that runoff tops and bases are sold separately, please see pages 98-100 for item numbers and pricing. Hangover panel is available in veneer or palette. If not specified white palette is default.

**DIMENSION KEY**

W - width  
D - depth  
H - height

**CODE DESCRIPTION**

S2 - 2 TV areas  
WB - white board  
11 - closed bookcase  
B - drawer bank  
4 - use with desk height runoff  
6 - use with bar height runoff

**STANDARD FINISHES**

For a complete list of standard wood finishes, please see page 9.

# ADESSO MEDIA HUB | 2 TV AREAS, 1 HANG OVER PANEL, WHITE BOARD

Description	Model	Oak		W	D	H	Shipping Weight	Cubic Feet
		Cherry Maple	Anigre Walnut					
Media Hub, 1 Hang-over Panel with White Board, 2 TV Areas no Runoff	88MH54217211S2WB	12322	13556	53.75	20.75	72	455	65.25
	88MH54218011S2WB	12693	13962	53.75	20.75	80	506	72.25
	88MH60217211S2WB*	12971	14269	59.75	20.75	72	481	71.75
	88MH60218011S2WB	13359	14696	59.75	20.75	80	556	79.5

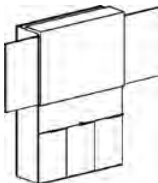

Media Hub, 1 Hang-over Panel with White Board, 2 TV Areas, Desk Ht. Runoff	88MH54217211S244WB	12322	13556	53.75	20.75	72	455	65.25
	88MH54218011S244WB	12693	13962	53.75	20.75	80	506	72.25
	88MH60217211S244WB*	12971	14269	59.75	20.75	72	481	71.75
	88MH60218011S244WB	13359	14696	59.75	20.75	80	556	79.5

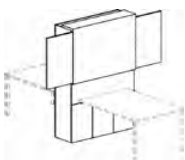

Media Hub, 1 Hang-over Panel with White Board, 2 TV Areas, Bar Ht. Runoff	88MH54217211S266WB	12322	13556	53.75	20.75	72	455	65.25
	88MH54218011S266WB	12693	13962	53.75	20.75	80	506	72.25
	88MH60217211S266WB*	12971	14269	59.75	20.75	72	481	71.75
	88MH60218011S266WB	13359	14696	59.75	20.75	80	556	79.5

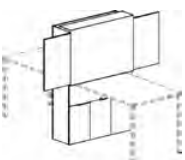

Media Hub, 1 Hang-over Panel with White Board, 2 TV Areas, Desk Ht./ Bar Ht. Runoff	88MH54217211S246WB	12322	13556	53.75	20.75	72	455	65.25
	88MH54218011S246WB	12693	13962	53.75	20.75	80	506	72.25
	88MH60217211S246WB*	12971	14269	59.75	20.75	72	481	71.75
	88MH60218011S246WB	13359	14696	59.75	20.75	80	556	79.5

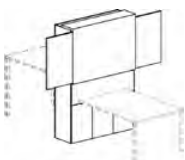

**ORDERING NOTES:**

Please note that runoff tops and bases are sold separately, please see pages 98-100 for item numbers and pricing. Hangover panel is available in veneer or palette. If not specified white palette is default.

**ORDERING PROCEDURE**

To order, please specify the following:  
 1) Krug product model number  
 2) Wood species and finish

**CODE DESCRIPTION**

S2 - 2 TV areas  
 WB - white board  
 11 - closed bookcase  
 B - drawer bank  
 4 - use with desk height runoff  
 6 - use with bar height runoff

**STANDARD FINISHES**

For a complete list of standard wood finishes, please see page 9.

# ADESSO MEDIA HUB | 2 TV AREAS, 1 HANG OVER PANEL, WHITE BOARD

Description	Model	Oak		W	D	H	Shipping Weight	Cubic Feet
		Cherry Maple	Anigre Walnut					
Media Hub, 1 Hang-over Panel with White Board, 2 TV Areas, Drawers/Desk Ht. Runoff	88MH54217211S2B4WB	14812	16290	53.75	20.75	72	455	65.25
	88MH54218011S2B4WB	15181	16697	53.75	20.75	80	506	72.25
	88MH60217211S2B4WB*	15535	17089	59.75	20.75	72	481	71.75
	88MH60218011S2B4WB	15925	17518	59.75	20.75	80	556	79.5

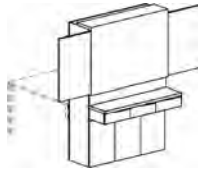

Media Hub, 1 Hang-over Panel with White Board, 2 TV Areas, Drawers/Bar Ht. Runoff	88MH54217211S2B6WB	14812	16290	53.75	20.75	72	455	65.25
	88MH54218011S2B6WB	15181	16697	53.75	20.75	80	506	72.25
	88MH60217211S2B6WB*	15535	17089	59.75	20.75	72	481	71.75
	88MH60218011S2B6WB	15925	17518	59.75	20.75	80	556	79.5

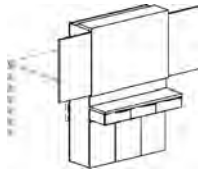

Media Hub, 1 Hang-over Panel with White Board, 2 TV Areas & 2 Drawers	88MH54217211S2BBWB	17297	19027	53.75	20.75	72	455	65.25
	88MH54218011S2BBWB	17667	19434	53.75	20.75	80	506	72.25
	88MH60217211S2BBWB*	18100	19912	59.75	20.75	72	481	71.75
	88MH60218011S2BBWB	18489	20338	59.75	20.75	80	556	79.5

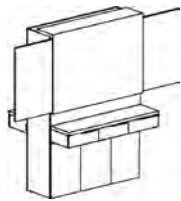

**ORDERING NOTES:**

Please note that runoff tops and bases are sold separately, please see pages 98-100 for item numbers and pricing. Hangover panel is available in veneer or palette. If not specified white palette is default.

**DIMENSION KEY**

W - width  
D - depth  
H - height

**CODE DESCRIPTION**

S2 - 2 TV areas  
WB - white board  
11 - closed bookcase  
B - drawer bank  
4 - use with desk height runoff  
6 - use with bar height runoff

**STANDARD FINISHES**

For a complete list of standard wood finishes, please see page 9.

# ADESSO MEDIA HUB | 2 HANG OVER PANELS, 2 TV AREAS

Description	Model	Oak		W	D	H	Shipping Weight	Cubic Feet
		Cherry Maple	Anigre Walnut					
Media Hub, 2 Hang-over Panels, 2 TV Areas no Runoff	88MH54247211S2	10534	11588	53.75	23.75	72	532	72.75
	88MH54248011S2	10851	11937	53.75	23.75	80	594	80.75
	88MH60247211S2*	11182	12300	59.75	23.75	72	558	80.25
	88MH60248011S2	11517	12669	59.75	23.75	80	656	89

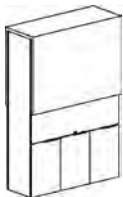

Media Hub, 2 Hang-over Panels, 2 TV Areas, Desk Ht. Runoff	88MH54247211S244	10534	11588	53.75	23.75	72	532	72.75
	88MH54248011S244	10851	11937	53.75	23.75	80	594	80.75
	88MH60247211S244*	11182	12300	59.75	23.75	72	558	80.25
	88MH60248011S244	11517	12669	59.75	23.75	80	656	89

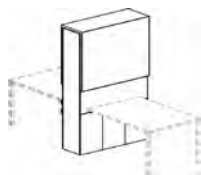

Media Hub, 2 Hang-over Panels, 2 TV Areas, Bar Ht. Runoff	88MH54247211S266	10534	11588	53.75	23.75	72	532	72.75
	88MH54248011S266	10851	11937	53.75	23.75	80	594	80.75
	88MH60247211S266*	11182	12300	59.75	23.75	72	558	80.25
	88MH60248011S266	11517	12669	59.75	23.75	80	656	89

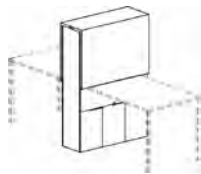

Media Hub, 2 Hang-over Panels, 2 TV Areas, Desk Ht. & Bar Ht. Runoff	88MH54247211S246	10534	11588	53.75	23.75	72	532	72.75
	88MH54248011S246	10851	11937	53.75	23.75	80	594	80.75
	88MH60247211S246*	11182	12300	59.75	23.75	72	558	80.25
	88MH60248011S246	11517	12669	59.75	23.75	80	656	89

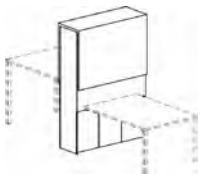

**ORDERING NOTES:**

Please note that runoff tops and bases are sold separately, please see pages 98-100 for item numbers and pricing. Hangover panel is available in veneer or palette. If not specified white palette is default.

**ORDERING PROCEDURE**

To order, please specify the following:  
 1) Krug product model number  
 2) Wood species and finis

**CODE DESCRIPTION**

S2 - 2 TV areas  
 WB - white board  
 11 - closed bookcase  
 B - drawer bank  
 4 - use with desk height runoff  
 6 - use with bar height runoff

**STANDARD FINISHES**

For a complete list of standard wood finishes, please see page 9.

## ADESSO MEDIA HUB | 2 HANG OVER PANELS, 2 TV AREAS

Description	Model	Oak		W	D	H	Shipping Weight	Cubic Feet
		Cherry Maple	Anigre Walnut					
Media Hub, 2 Hang-over Panels, 2 TV Areas, Drawers/ Desk Ht. Runoff	88MH54247211S2B4	13021	14323	53.75	23.75	72	532	72.75
	88MH54248011S2B4	13340	14671	53.75	23.75	80	594	80.75
	88MH60247211S2B4*	13746	15121	59.75	23.75	72	558	80.25
	88MH60248011S2B4	14082	15489	59.75	23.75	80	656	89

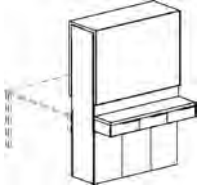

Media Hub, 2 Hang-over Panels, 2 TV Areas, Drawers/ Bar Ht. Runoff	88MH54247211S2B6	13021	14323	53.75	23.75	72	532	72.75
	88MH54248011S2B6	13340	14671	53.75	23.75	80	594	80.75
	88MH60247211S2B6*	13746	15121	59.75	23.75	72	558	80.25
	88MH60248011S2B6	14082	15489	59.75	23.75	80	656	89

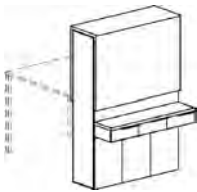

Media Hub, 2 Hang-over Panels, 2 TV Areas, 2 Drawers	88MH54247211S2BB	15509	17059	53.75	23.75	72	532	72.75
	88MH54248011S2BB	15825	17409	53.75	23.75	80	594	80.75
	88MH60247211S2BB*	16312	17942	59.75	23.75	72	558	80.25
	88MH60248011S2BB	16647	18312	59.75	23.75	80	656	89

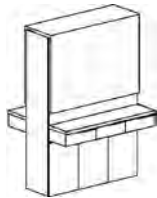

**ORDERING NOTES:**

Please note that runoff tops and bases are sold separately, please see pages 98-100 for item numbers and pricing. Hangover panel is available in veneer or palette. If not specified white palette is default.

**DIMENSION KEY**

W - width  
D - depth  
H - height

**CODE DESCRIPTION**

S2 - 2 TV areas  
WB - white board  
11 - closed bookcase  
B - drawer bank  
4 - use with desk height runoff  
6 - use with bar height runoff

**STANDARD FINISHES**

For a complete list of standard wood finishes, please see page 9.

# ADESSO MEDIA HUB | 2 HANG OVER PANELS, WHITE BOARD

Description	Model	Oak		W	D	H	Shipping Weight	Cubic Feet
		Cherry Maple	Anigre Walnut					
Media Hub, 2 Hang-over Panels with White Board, 2 TV Areas no Runoff	88MH54247211S2WB	12322	13556	53.75	23.75	72	559	72.75
	88MH54248011S2WB	12693	13962	53.75	23.75	80	621	80.75
	88MH60247211S2WB*	12971	14269	59.75	23.75	72	585	80.25
	88MH60248011S2WB	13359	14696	59.75	23.75	80	683	89

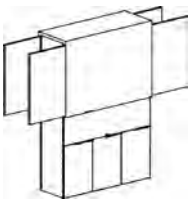

Media Hub, 2 Hang-over Panels with White Board, 2 TV Areas/ Desk Ht. Runoff	88MH54247211S244WB	12322	13556	53.75	23.75	72	559	72.75
	88MH54248011S244WB	12693	13962	53.75	23.75	80	621	80.75
	88MH60247211S244WB*	12971	14269	59.75	23.75	72	585	80.25
	88MH60248011S244WB	13359	14696	59.75	23.75	80	683	89

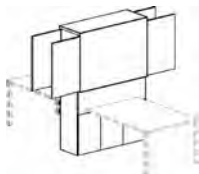

Media Hub, 2 Hang-over Panels with White Board, 2 TV Areas, Bar Ht. Runoff	88MH54247241S266WB	12322	12322	53.75	23.75	72	559	72.75
	88MH54248011S266WB	12693	12693	53.75	23.75	80	621	80.75
	88MH60247241S266WB*	12971	12971	59.75	23.75	72	585	80.25
	88MH60248011S266WB	13359	13359	59.75	23.75	80	683	89

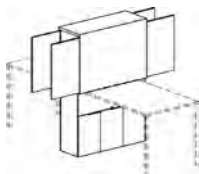

Media Hub, 2 Hang-over Panels with White Board, 2 TV Areas, Desk Ht. & Bar Ht. Runoff	88MH54247241S246WB	12322	13556	53.75	23.75	72	559	72.75
	88MH54248011S246WB	12693	13962	53.75	23.75	80	621	80.75
	88MH60247211S246WB*	12971	14269	59.75	23.75	72	585	80.25
	88MH60248011S246WB	13359	14696	59.75	23.75	80	683	89

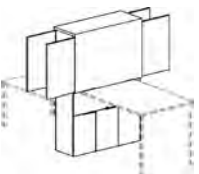

**ORDERING NOTES:**

Please note that runoff tops and bases are sold separately, please see pages 98-100 for item numbers and pricing. Hangover panel is available in veneer or palette. If not specified white palette is default.

**ORDERING PROCEDURE**

To order, please specify the following:

- 1) Krug product model number
- 2) Wood species and finish

**CODE DESCRIPTION**

- S2 - 2 TV areas
- WB - white board
- 11 - closed bookcase
- B - drawer bank
- 4 - use with desk height runoff
- 6 - use with bar height runoff

**STANDARD FINISHES**

For a complete list of standard wood finishes, please see page 9.

## ADESSO MEDIA HUB | 2 HANG OVER PANELS, WHITE BOARD

Description	Model	Oak		W	D	H	Shipping Weight	Cubic Feet
		Cherry Maple	Anigre Walnut					
Media Hub, 2 Hang-over Panels with White Board, 2 TV Areas, Drawers/ Desk Ht. Runoff	88MH54247211S2B4WB	14812	16290	53.75	23.75	72	559	72.75
	88MH54248011S2B4WB	15181	16697	53.75	23.75	80	621	80.75
	88MH60247211S2B4WB*	15535	17089	59.75	23.75	72	585	80.25
	88MH60248011S2B4WB	15925	17518	59.75	23.75	80	683	89

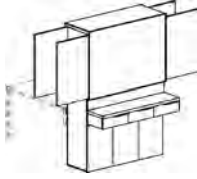

Media Hub, 2 Hang-over Panels with White Board, 2 TV Areas, Drawers/ Bar Ht. Runoff	88MH54247211S2B6WB	14812	16290	53.75	23.75	72	559	72.75
	88MH54248011S2B6WB	15181	16697	53.75	23.75	80	621	80.75
	88MH60247211S2B6WB*	15535	17089	59.75	23.75	72	585	80.25
	88MH60248011S2B6WB	15925	17518	59.75	23.75	80	683	89

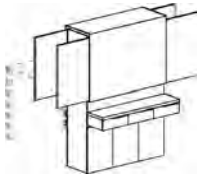

Media Hub, 2 Hang-over Panels with White Board, 2 TV Areas, 2 Drawers	88MH54247211S2BBWB	17297	19027	53.75	23.75	72	559	72.75
	88MH54248011S2BBWB	17667	19434	53.75	23.75	80	621	80.75
	88MH60247211S2BBWB*	18100	19912	59.75	23.75	72	585	80.25
	88MH60248011S2BBWB	18489	20338	59.75	23.75	80	683	89

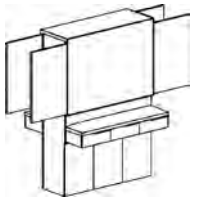

**ORDERING NOTES:**

Please note that runoff tops and bases are sold separately, please see pages 98-100 for item numbers and pricing. Hangover panel is available in veneer or palette. If not specified white palette is default.

**DIMENSION KEY**

W - width  
D - depth  
H - height





**CODE DESCRIPTION**

S2 - 2 TV areas  
WB - white board  
11 - closed bookcase  
B - drawer bank  
4 - use with desk height runoff  
6 - use with bar height runoff

**STANDARD FINISHES**

For a complete list of standard wood finishes, please see page 9.

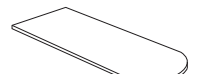
# ADESSO MEDIA HUB | DESK HEIGHT RUNOFF TOPS

Description	Model	Oak			W	D	H	Shipping Weight	Cubic Feet
		Cherry Maple	Anigre Walnut	Laminate					
 Desk Height, Rectangular Runoff Top	88MHR60364	1866	2054	1866	59.5	35.75	29.5	85	5
	88MHR60424	1981	2177	1981	59.5	41.75	29.5	98	6
	88MHR66364	1920	2110	1920	65.5	35.75	29.5	93	5.5
	88MHR66424	2035	2240	2035	65.5	41.75	29.5	106	6.5
	88MHR72364	1970	2167	1970	71.5	35.75	29.5	100	6
	88MHR72424	2089	2299	2089	71.5	41.75	29.5	115	7
	88MHR78364	2161	2377	2161	77.5	35.75	29.5	108	6.5
	88MHR78424	2291	2520	2291	77.5	41.75	29.5	118	7.5
	88MHR84364	2212	2432	2212	83.5	35.75	29.5	115	7
	88MHR84424	2670	2936	2670	83.5	41.75	29.5	135	8
	88MHR96364	2641	2907	2641	95.5	35.75	29.5	140	7.5
	88MHR96424	2795	3076	2795	95.5	41.75	29.5	160	9
 Desk Height, Arc Runoff Top	88MHAR60364	1976	2172	1976	59.5	35.75	29.5	85	5
	88MHAR60424	2087	2297	2087	59.5	41.75	29.5	98	6
	88MHAR66364	2020	2221	2020	65.5	35.75	29.5	93	5.5
	88MHAR66424	2134	2347	2134	65.5	41.75	29.5	106	6.5
	88MHAR72364	2065	2273	2065	71.5	35.75	29.5	100	6
	88MHAR72424	2185	2403	2185	71.5	41.75	29.5	115	7
	88MHAR78364	2452	2697	2452	77.5	35.75	29.5	108	6.5
	88MHAR78424	2559	2812	2559	77.5	41.75	29.5	118	7.5
	88MHAR84364	2849	3135	2849	83.5	35.75	29.5	115	7
	88MHAR84424	3008	3308	3008	83.5	41.75	29.5	135	8
	88MHAR96364	3354	3688	3354	95.5	35.75	29.5	140	7.5
	88MHAR96424	3535	3890	3535	95.5	41.75	29.5	160	9
 Desk Height, Bullet Runoff Top	88MHR60364	1976	2172	1976	59.5	35.75	29.5	85	5
	88MHR60424	2087	2297	2087	59.5	41.75	29.5	98	6
	88MHR66364	2020	2221	2020	65.5	35.75	29.5	93	5.5
	88MHR66424	2134	2347	2134	65.5	41.75	29.5	106	6.5
	88MHR72364	2065	2273	2065	71.5	35.75	29.5	100	6
	88MHR72424	2185	2403	2185	71.5	41.75	29.5	115	7
	88MHR78364	2452	2697	2452	77.5	35.75	29.5	108	6.5
	88MHR78424	2557	2812	2557	77.5	41.75	29.5	118	7.5
	88MHR84364	2849	3135	2849	83.5	35.75	29.5	115	7
	88MHR84424	3008	3308	3008	83.5	41.75	29.5	135	8
	88MHR96364	3354	3688	3354	95.5	35.75	29.5	140	7.5
	88MHR96424	3535	3890	3535	95.5	41.75	29.5	160	9
<b>ORDERING NOTES:</b> Please note that 2" Square Metal legs cannot be specified with the Bullet Runoff top.									
 Desk Height, VISIO Runoff Top	88MHVR6036-424	2117	2328	2117	59.5	35.75	29.5	98	6
	88MHVR6042-484	2236	2459	2236	59.5	41.75	29.5	110	6.5
	88MHVR6636-424	2172	2390	2172	65.5	35.75	29.5	106	6.5
	88MHVR6642-484	2295	2524	2295	65.5	41.75	29.5	120	7
	88MHVR7236-424	2227	2448	2227	71.5	35.75	29.5	115	7
	88MHVR7242-484	2353	2587	2353	71.5	41.75	29.5	130	7.5
	88MHVR7836-424	2551	2805	2551	77.5	35.75	29.5	118	7.5
	88MHVR7842-484	2659	2924	2659	77.5	41.75	29.5	145	8
	88MHVR8436-424	2963	3260	2963	83.5	35.75	29.5	135	8
	88MHVR8442-484	3129	3439	3129	83.5	41.75	29.5	155	9
	88MHVR9636-424	3488	3836	3488	95.5	35.75	29.5	160	9
	88MHVR9642-484	3678	4042	3678	95.5	35.75	29.5	175	10

**ORDERING PROCEDURE**

To order, please specify the following:  
 1) Krug product model number  
 2) Wood species and finish

**STANDARD FINISHES**





For a complete list of standard wood finishes, please see page 9.

**GROMMETS**

One wiring grommet in standard position is optional at no charge. See page 12 for more information.



# ADESSO MEDIA HUB | BAR HEIGHT RUNOFFS

Description	Model	Oak	Anigre	Laminate	W	D	H	Shipping Weight	Cubic Feet
		Cherry Maple	Walnut						
Bar Height, Rectangular Runoff 	88MHR60366	1866	2054	1866	59.5	35.75	29.5	85	5.25
	88MHR60426	1981	2177	1981	59.5	41.75	29.5	98	5.75
	88MHR66366	1920	2110	1920	65.5	35.75	29.5	93	5.5
	88MHR66426	2035	2240	2035	65.5	41.75	29.5	106	6.5
	88MHR72366	1970	2167	1970	71.5	35.75	29.5	100	6
	88MHR72426	2089	2299	2089	71.5	41.75	29.5	115	7
	88MHR78366	2161	2377	2161	77.5	35.75	29.5	108	6.5
	88MHR78426	2291	2520	2291	77.5	41.75	29.5	118	7.5
	88MHR84366	2212	2432	2212	83.5	35.75	29.5	115	7
	88MHR84426	2670	2936	2670	83.5	41.75	29.5	135	8
	88MHR96366	2641	2907	2641	95.5	35.75	29.5	140	8
	88MHR96426	2795	3076	2795	95.5	41.75	29.5	160	9
Bar Height, Arc Runoff 	88MHAR60366	1976	2172	1976	59.5	35.75	41.5	85	5.25
	88MHAR60426	2087	2297	2087	59.5	41.75	41.5	98	5.75
	88MHAR66366	2020	2221	2020	65.5	35.75	41.5	93	5.5
	88MHAR66426	2134	2347	2134	65.5	41.75	41.5	106	6.5
	88MHAR72366	2065	2273	2065	71.5	35.75	41.5	100	6
	88MHAR72426	2185	2403	2185	71.5	41.75	41.5	115	7
	88MHAR78366	2452	2697	2452	77.5	35.75	41.5	108	6.5
	88MHAR78426	2559	2812	2559	77.5	41.75	41.5	118	7.5
	88MHAR84366	2849	3135	2849	83.5	35.75	41.5	115	7
	88MHAR84426	3008	3308	3008	83.5	41.75	41.5	135	8
	88MHAR96366	3354	3688	3354	95.5	35.75	41.5	140	8
	88MHAR96426	3535	3890	3535	95.5	41.75	41.5	160	9
Bar Height, Bullet Runoff 	88MHBR60366	1976	2172	1976	59.5	35.75	41.5	85	5.25
	88MHBR60426	2087	2297	2087	59.5	41.75	41.5	98	5.75
	88MHBR66366	2020	2221	2020	65.5	35.75	41.5	93	5.5
	88MHBR66426	2134	2347	2134	65.5	41.75	41.5	106	6.5
	88MHBR72366	2065	2273	2065	71.5	35.75	41.5	100	6
	88MHBR72426	2185	2403	2185	71.5	41.75	41.5	115	7
	88MHBR78366	2452	2697	2452	77.5	35.75	41.5	108	6.5
	88MHBR78426	2557	2812	2557	77.5	41.75	41.5	118	7.5
	88MHBR84366	2849	3135	2849	83.5	35.75	41.5	115	7
	88MHBR84426	3008	3308	3008	83.5	41.75	41.5	135	8
	88MHBR96366	3354	3688	3354	95.5	35.75	41.5	140	8
	88MHBR96426	3535	3890	3535	95.5	41.75	41.5	160	9
Bar Height, Visio Runoff 	88MHVR6036-426	2117	2328	2117	59.5	35.75	41.5	98	6
	88MHVR6042-486	2236	2459	2236	59.5	41.75	41.5	110	6.5
	88MHVR6636-426	2172	2390	2172	65.5	35.75	41.5	106	6.5
	88MHVR6642-486	2295	2524	2295	65.5	41.75	41.5	120	7
	88MHVR7236-426	2227	2448	2227	71.5	35.75	41.5	115	7
	88MHVR7242-486	2353	2587	2353	71.5	41.75	41.5	130	7.5
	88MHVR7836-426	2551	2805	2551	77.5	35.75	41.5	118	7.5
	88MHVR7842-486	2659	2924	2659	77.5	41.75	41.5	145	8
	88MHVR8436-426	2963	3260	2963	83.5	35.75	41.5	135	8
	88MHVR8442-486	3129	3439	3129	83.5	41.75	41.5	155	9
	88MHVR9636-426	3488	3836	3488	95.5	35.75	41.5	160	9
	88MHVR9642-486	3678	4042	3678	95.5	41.75	41.5	175	10

**ORDERING NOTES:**

Please note that 2" Square Metal legs cannot be specified with the Bullet Runoff top.

**DIMENSION KEY**

W - width  
D - depth  
H - height





**STANDARD FINISHES**

For a complete list of standard wood finishes, please see page 9.

**GROMMETS**

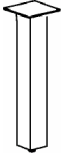
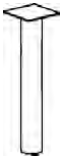
One wiring grommet in standard position is optional at no charge. See page 13 for more information.

# ADESSO MEDIA HUB | BAR HEIGHT RUNOFFS & BASES

Description	Model	Oak Cherry Maple	Anigre Walnut	Laminate	W	D	H	Shipping Weight	Cubic Feet
	88MHVAR6036-426	2155	2369	2155	59.5	41.75	41.5	98	6
	88MHVAR6042-486	2266	2492	2266	65.5	35.75	41.5	110	6.5
	88MHVAR6636-426	2201	2421	2201	65.5	41.75	41.5	106	6.5
	88MHVAR6642-486	2315	2545	2315	71.5	35.75	41.5	120	7
	88MHVAR7236-426	2250	2476	2250	71.5	41.75	41.5	115	7
	88MHVAR7242-486	2316	2549	2316	77.5	35.75	41.5	130	7.5
	88MHVAR7836-426	2518	2770	2518	77.5	41.75	41.5	118	7.5
	88MHVAR7842-486	2641	2907	2641	83.5	35.75	41.5	145	8
	88MHVAR8436-426	2917	3208	2917	83.5	41.75	41.5	135	8
	88MHVAR8442-486	3066	3371	3066	95.5	35.75	41.5	155	9
	88MHVAR9636-426	3423	3763	3423	95.5	35.75	41.5	160	9
	88MHVAR9642-486	3595	3955	3595	59.5	41.75	41.5	175	10
	88LG429S1	556	611		4	4	28	-	1
	88LG442S1	516	568		4	4	41	-	1.5
<b>Legs required per runoff: 1</b>									
	88LG429D8	811			4	4	28	-	1
	88LG442D8	759			4	4	41	-	1.5
<b>Legs required per runoff: 1</b>									
	88141828	644			18	18	28.5	30	8
	88141842	676			18	18	41	35	8.5
<b>Legs required per runoff: 1</b>									
	88LG229M	465			2	2	28	19	3
	88LGX242M	706			2	2	41	-	4
<b>Legs required per runoff: 2</b>									
<b>ORDERING NOTES:</b> Please note that 2" Square Metal legs cannot be specified with the Bullet Runoff top									
	88LG2029TR5	480			3	20	28	-	1
	88LG2042TR5	537			3	20	41	-	1.5
<b>Legs required per runoff: 1</b>									

**ORDERING PROCEDURE**

To order, please specify the following:  
 1) Krug product model number  
 2) Wood species and finish

**STANDARD FINISHES**

For a complete list of standard wood finishes, please see page 9.

**BASE**

A 29" base is to be used to achieve a desk height runoff, 42" base is to be used for bar height runoff.

# ADESSO MEDIA HUB | STORAGE

Description	Model	Oak		W	D	H	Shipping Weight	Cubic Feet
		Cherry Maple	Anigre Walnut					
Media Hub Storage & Waste/Recycling 	88MHST241872103L	5117	5632	24	17.75	72	132	20
	88MHST241872103R	5117	5632	24	17.75	72	132	20
	88MHST241880103L*	5194	5715	24	17.75	80	156	22.5
	88MHST241880103R	5194	5715	24	17.75	80	156	22.5

Media Hub Storage, 5 Closed 	88MHST24187211L	4334	4765	24	17.75	72	160	20
	88MHST24187211R	4334	4765	24	17.75	72	160	20
	88MHST24188011L*	4398	4839	24	17.75	80	188	22.25
	88MHST24188011R	4398	4839	24	17.75	80	188	22.25

Media Hub Storage, 5 Closed Back Painted Glass Doors 	88MHST24187211ZL	5881	6472	24	17.75	72	160	20
	88MHST24187211ZR	5881	6472	24	17.75	72	160	20
	88MHST24188011ZL*	6685	7354	24	17.75	80	188	22.25
	88MHST24188011ZR	6685	7354	24	17.75	80	188	22.25

Media Hub Storage, 2 Box/1 File drawer/ 3 Closed 	88MHST24187293L	4510	4709	24	17.75	72	118	20
	88MHST24187293R	4510	4709	24	17.75	72	118	20
	88MHST24188093L*	4580	4784	24	17.75	80	152	22.25
	88MHST24188093R	4580	4784	24	17.75	80	152	22.25

**DIMENSION KEY**

W - width  
 D - depth  
 H - height

**STANDARD FINISHES**

For a complete list of standard wood finishes, please see page 9.

# ADESSO MEDIA HUB | STORAGE

Description	Model	Oak Cherry Maple	Anigre Walnut	W	D	H	Shipping Weight	Cubic Feet
Media Hub Storage, 2 Box/1File Drawer/ 3 Closed Back Painted Glass Doors	88MHST24187293ZL 88MHST24187293ZR 88MHST24188093ZL* 88MHST24188093ZR	5527 5527 5889 5889	5742 5742 6117 6117	24 24 24 24	17.75 17.75 17.75 17.75	72 72 80 80	118 118 152 152	20 20 22.25 22.25

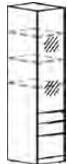

Media Hub Wardrobe, Coat Hooks & Shelf	88MHWR24187201L 88MHWR24187201R 88MHWR24188001L* 88MHWR24188001R	3707 3707 3761 3761	4074 4074 4138 4138	24 24 24 24	17.75 17.75 17.75 17.75	72 72 80 80	148 148 174 174	20 20 22.5 22.5
---	---	------------------------------	------------------------------	----------------------	----------------------------------	----------------------	--------------------------	--------------------------



Media Hub Wardrobe, Coat Hooks & Shelf Back Painted Glass Doors	88MHWR24187201ZL 88MHWR24187201ZR 88MHWR24188001ZL* 88MHWR24188001ZR	5619 5619 6024 6024	6183 6183 6628 6628	24 24 24 24	17.75 17.75 17.75 17.75	72 72 80 80	148 148 174 174	20 20 22.5 22.5
--	---	------------------------------	------------------------------	----------------------	----------------------------------	----------------------	--------------------------	--------------------------



HDMI Technology Bay, Graphite Gray	88HDMITB	9746		13.25	8	9.5	-	-
---------------------------------------	----------	------	--	-------	---	-----	---	---



HDMI to VGA Adaptor pack & Audio Support	88HDMI/ VGA	599		-	-	-	-	-
---	-------------	-----	--	---	---	---	---	---



HDMI to Display Port & Adaptor Pack	88HDMI/DP	187		60	2.5	1	5	0.75
--	-----------	-----	--	----	-----	---	---	------



HDMI to Mini Display Port & Thunderbolt Adaptor Pack	88HDMI/ MDP	164		3.5	1.75	-	5.0	25
--	-------------	-----	--	-----	------	---	-----	----



This module includes: 4 simplex receptacles, 4 HDMI show me cables, HDMI 4 position switchbox, 2 plate cutouts, 15' HDMI monitor cable, 108" power cord.

**NOTES:** This module is mounted in the runoff tops near the meadia hub cabinet. This module is large and knee clearance can be an issue on 36" deep tops if someone is seated next to it. Technology adaptors are available for use in the 2 plate cutouts.

### ORDERING PROCEDURE

To order, please specify the following:

- 1) Krug product model number
- 2) Wood species and finish

### STANDARD FINISHES

For a complete list of standard wood finishes, please see page 9.

## ADESSO | MODULAR PEDESTALS WITH FINISHED BACKS

Description	Model	Oak		W	D	H	Shipping Weight	Cubic Feet
		Cherry Maple	Anigre Walnut					
Pedestal Desk Height, 2 Box, 1 File	88PFB16204F	1676	1856	15.75	20	28	62	6.25
	88PFB16244F*	1777	1955	15.75	24	28	66.7	25
	88PFB16304F	1913	2105	15.75	30	28	74	9



Pedestal Desk Height, 2 File	88PFB16204D	1642	1806	15.75	20	28	60	6.25
	88PFB16244D*	1732	1907	15.75	24	28	66	7.25



Pedestal Desk Height, Open, 1 File	88PFB16202815	1897	2087	15.75	20	28	46	6.25
	88PFB16242815*	1974	2170	15.75	24	28	52	7.75
	88PFB16302815	2092	2303	15.75	30	28	61	9



Desk Height, Equipment Pedestal with Pull Out Shelf	88PFBPCPU162428	2348	2585	15.75	24	28	65	7.25
---	-----------------	------	------	-------	----	----	----	------

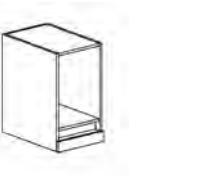

**ORDERING NOTES:**

Box and pedestal file drawers are available with a soft-closing drawer option. Please add 'S' to the end of the model number and **\$152 list.** e.g. 88MP16204FS.

**DIMENSION KEY**

W - width  
D - depth  
H - height

**CODE DESCRIPTION**

4 - desk height  
D - 2 file drawer  
F - 2 box, 1 file drawer  
15- open, 1 file

**STANDARD FINISHES**

For a complete list of standard wood finishes, please see page 9.

# ADESSO MEDIA HUB | MODULAR PEDESTALS WITH FINISHED BACKS

Description	Model	Oak		W	D	H	Shipping Weight	Cubic Feet
		Cherry Maple	Anigre Walnut					
Pedestal Desk	88PFB30202801	2952	3246	29.75	20	28	164	11.25
Height, 2 Lateral File	88PFB36202801	3088	3396	35.75	20	28	170	13.5
	88PFB30242801	3133	3445	29.75	24	28	168	13.25
	88PFB36242801*	3238	3562	35.75	24	28	174	16



Combination Pedestal Desk	88PFB362042802	3661	4024	35.75	20	28	178	13.5
Height	88PFB362442802*	3793	4173	35.75	24	28	162	16
	88PFB362042804	3661	4024	35.75	20	28	178	13.5
	88PFB362442804	3793	4173	35.75	24	28	162	16



Combination Pedestal Desk	88PFB302042815	3449	3793	29.75	20	28	175	11.25
Height Open, File	88PFB362042815	3582	3940	35.75	20	28	178	13.5
	88PFB302442815	3630	3993	29.75	24	28	160	13.25
	88PFB362442815*	3718	4090	35.75	24	28	162	16



Recycle Center Pedestal, Desk Height	88PFBRC16244L	3432	3774	15.75	24	28	80	7.25
	88PFBRC16244R*	3432	3774	15.75	24	28	80	7.25



**ORDERING NOTES:**

Box and pedestal file drawers are available with a soft-closing drawer option. Please add 'S' to the end of the model number and **\$152 list.** e.g. 88MP16204FS.

**ORDERING PROCEDURE**

To order, please specify the following:  
 1) Krug product model number  
 2) Wood species and finish

**CODE DESCRIPTION**

4 - desk height  
 F - 2 box, 1 file drawer  
 01 - 2 lateral file  
 02 - box, box on right, file on left, lateral file  
 15 - open, lateral file

**STANDARD FINISHES**

For a complete list of standard wood finishes, please see page 9.

## ADESSO | 3/4 HEIGHT MODULAR PEDESTALS WITH FINISHED BACKS

Description	Model	Oak Cherry Maple	Anigre Walnut	W	D	H	Shipping Weight	Cubic Feet
Printer Pedestal, Desk Height	88PFBPP24244	3688	3828	23.75	24	28	65	9



Pedestal 3/4 Height, Box,File	88PFB16203F	1386	1534	15.75	20	23	50	5
	88PFB16243F*	1478	1619	15.75	24	23	54	5.75



Pedestal 3/4 Height, Box, Lateral	88PFB1620315	1431	1584	15.75	20	23	40	5
	88PFB1624315*	1522	1795	15.75	24	23	44	5.75

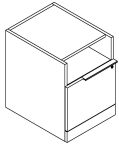

Pedestal 3/4 Height, Box, Lateral	88PFB30202316	2726	3008	29.75	20	23	135	9
	88PFB30242316	2817	3099	29.75	24	23	137	10.75
	88PFB36202316*	2830	3122	35.75	20	23	155	10.5
	88PFB36242316	2921	3208	35.75	24	23	149	12.5



**ORDERING NOTES:**

Box and pedestal file drawers are available with a soft-closing drawer option. Please add 'S' to the end of the model number and **\$152 list**. e.g. 88MP16204FS.

**DIMENSION KEY**

W - width  
D - depth  
H - height



**CODE DESCRIPTION**

4 - desk height  
F - 2 box, 1 file drawer  
01- 2 lateral file  
15- open, lateral file  
16- box, lateral file

**STANDARD FINISHES**

For a complete list of standard wood finishes, please see page 9.

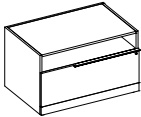
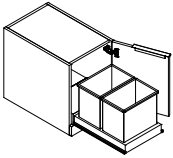
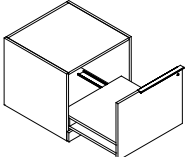
# ADESSO | 3/4 HEIGHT MODULAR PEDESTALS WITH FINISHED BACKS

Description	Model	Oak Cherry Maple	Anigre Walnut	W	D	H	Shipping Weight	Cubic Feet
Pedestal 3/4 Height, Open, Lateral  	88PFB30202315	2860	3158	29.75	20	23	125	9
	88PFB30242315	2952	3247	29.75	24	23	127	10.75
	88PFB36202315*	2966	3289	35.75	20	23	139	10.5
	88PFB36242315	3214	3529	35.75	24	23	145	12.5
Recycle Center Pedestal, 3/4 Height  	88PFBRC16243L	3146	3461	15.75	24	23	55	7.25
	88PFBRC16243R*	3146	3461	15.75	24	23	55	7.25
Printer Pedestal, 3/4 Height  	88PFBPP242423	3208	3530	23.75	24	23	55	8.5
Work Surfaces  	88TP3020	694	763	29.75	20	-	30	2
	88TP3024	723	795	29.75	24	-	35	2.25
	88TP3030	833	915	29.75	30	-	35	2
	88TP3036	1109	1222	29.75	36	-	38	2.75
	88TP3620	753	829	35.75	20	-	35	2.25
	88TP3624	830	913	35.75	24	-	40	2.5
	88TP3630	1109	1222	35.75	30	-	38	2.75
	88TP3636	1246	1372	35.75	36	-	38	2.75
	88TP4220	833	915	42	20	-	32	2.25
	88TP4224	971	1065	42	24	-	36	2.75
	88TP4230	1246	1372	42	30	-	43	3.25
	88TP4236	1526	1676	42	36	-	50	3.75
	88TP4820	919	1012	47.75	20	-	42	2.75
	88TP4824	1066	1171	47.75	24	-	45	3
	88TP4830	1386	1526	47.75	30	-	48	3.5
	88TP4836	1663	1828	47.75	36	-	56	4.25
	88TP5420	1039	1142	53.75	20	-	52	3.25
	88TP5424*	1068	1178	53.75	24	-	54	3.5
	88TP5430	1526	1676	53.75	30	-	53	4
	88TP5436	1940	2133	53.75	36	-	62	4.75
88TP6020	1098	1210	59.75	20	-	56	3.5	
88TP6024	1131	1244	59.75	24	-	65	4	
88TP6030	1802	1982	59.75	30	-	58	4.5	
88TP6036	2079	2285	59.75	36	-	68	5.25	

**ORDERING PROCEDURE**

To order, please specify the following:  
 1) Krug product model number  
 2) Wood species and finish

**CODE DESCRIPTION**

3 - 3/4 height  
 15- open, lateral file

**STANDARD FINISHES**

For a complete list of standard wood finishes, please see page 9.



# ADESSO | MODULAR TOPS & SUPPORTS

Description	Model	Oak Cherry Maple	Anigre Walnut	W	D	H	Shipping Weight	Cubic Feet
Work Surfaces, Continued  	88TP6620	1246	1372	66	20	-	45	3.5
	88TP6624	1526	1676	66	24	-	52	4
	88TP6630	1940	2133	66	20	-	63	4.75
	88TP6636	2355	2590	66	24	-	73	5.5
	88TP7220	1162	1276	71.5	20	-	67	4.25
	88TP7224	1192	1310	71.5	24	-	78	4.75
	88TP7230	2079	2285	71.5	20	-	68	5.25
	88TP7236	2493	2743	71.5	24	-	79	6
	88TP7820	1497	1645	78	20	-	32	5.25
	88TP7824	1880	2065	78	24	-	36	5.75
	88TP7830	2348	2585	78	30	-	43	6.25
	88TP7836	2819	3101	78	36	-	50	6.75
	88TP8420	1251	1376	83.5	20	-	82	5
	88TP8424	1282	1409	83.5	24	-	89	5.5
	88TP8430	2493	2743	83.5	20	-	85	6
	88TP8436	2910	3202	83.5	24	-	99	7
	88TP9024	1356	1491	89.5	24	-	97	6
	88TP9030	2632	2894	89.5	24	-	90	6.5
	88TP9036	3186	3507	89.5	24	-	105	7.5
	88TP9624	1431	1573	95.5	24	-	102	6.25
88TP9630	2770	3047	95.5	24	-	95	6.75	
88TP9636	3323	3656	95.5	24	-	111	8	
88TP10824	1536	1690	107.5	24	-	113	7	

Full Height Gable  	88GB2029L	542	597	20	1.5	28	24	1.5
	88GB2029R	542	597	20	1.5	28	24	1.5
	88GB2429L*	589	647	24	1.5	28	28	1.75
	88GB2429R	589	647	24	1.5	28	28	1.75

Full Height Modesty Panels for Modular Tops with 2-16" Pedestals  	88MP6041	739	811	28	0.75	28	20	1.5
	88MP6641	812	895	34	0.75	28	24	2
	88MP7241	889	979	40	0.75	28	26	2.25
	88MP7841	994	1093	46	0.75	28	30	2.5
	88MP8441	1098	1210	52	0.75	28	36	2.75
	88MP9041	1282	1409	58	0.75	28	39	3.25
	88MP9641*	1461	1609	64	0.75	28	44	3.5
88MP10841	1732	1907	76	0.75	28	50	4	

4/4 Modesty Panels for Modular Tops with 1-16" Pedestal & 1 Gable  	88MP6042	739	811	43	0.75	28	28	2.25
	88MP6642	812	895	49	0.75	28	31	2.5
	88MP7242	889	979	55	0.75	28	34	2.75
	88MP7842	994	1093	61	0.75	28	37	3.25
	88MP8442	1098	1210	67	0.75	28	42	3.5
	88MP9042	1282	1409	73	0.75	28	47	4
	88MP9642*	1461	1609	79	0.75	28	52	4.25
88MP10842	1732	1907	91	0.75	28	58	5	

**DIMENSION KEY**

W - width  
D - depth  
H - height

**STANDARD FINISHES**

For a complete list of standard wood finishes, please see page 9.

# ADESSO | MODULAR TOPS & SUPPORTS

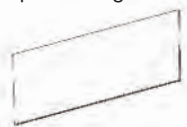
Description	Model	Oak		W	D	H	Shipping Weight	Cubic Feet
		Cherry Maple	Anigre Walnut					
 Full height modesty panels for modular tops with 2 gables	88MP6043	739	811	57	0.75	28	35	3
	88MP6643	812	895	63	0.75	28	38	3.5
	88MP7243	889	979	69	0.75	28	42	3.75
	88MP7843	994	1093	75	0.75	28	48	4
	88MP8443	1098	1210	81	0.75	28	51	4.5
	88MP9043	1282	1409	87	0.75	28	54	4.75
	88MP9643*	1461	1609	93	0.75	28	59	5
88MP10843	1732	1907	105	0.75	28	65	5.5	

 Full Height Work Surface Support - Half Gable, Use with Modesty Panel	88HG0729	391	431	7	1.5	28	8	1
	88HG1129*	497	547	11	1.5	28	14	1.25

 Full Height Work Surface Support - Half Gable, Use with no Modesty Panel	88HG1029NMP	651	715	10	1.5	28	14	1.25
---	-------------	-----	-----	----	-----	----	----	------

**ORDERING NOTES:**

Work surface support - Half Gable is used only when a modesty panel is not specified for an unsupported span greater than 60".

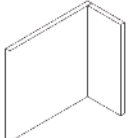
 Full Height Work Surface Support - L Base	88LB2029L	694	763	16	20	28	55	2.25
	88LB2029R	694	763	16	20	28	55	2.25
	88LB2429L	753	829	16	24	28	60	3
	88LB2429R*	753	829	16	24	28	60	3

**ORDERING NOTES:**

Work surface support - L Base is used only when a modesty panel is not specified for an unsupported span greater than 60".

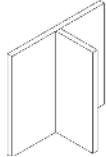
 Full Height Work Surface Support - T Base	88TB120729*	934	1029	12	7	28	37	1.25
	88TB121129	1011	1110	12	11	28	45	1.5

**ORDERING PROCEDURE**

To order, please specify the following:  
 1) Krug product model number  
 2) Wood species and finish

**CODE DESCRIPTION**

**STANDARD FINISHES**

For a complete list of standard wood finishes, please see page 9.

# ADESSO | MODULAR TOPS & SUPPORTS

Description	Model	Oak Cherry Maple	Anigre Walnut	W	D	H	Shipping Weight	Cubic Feet
 3/4 Height Gable	88GB2023L	513	564	20	1.5	23	24	1.5
	88GB2023R	513	564	20	1.5	23	24	1.5
	88GB2423L*	559	615	24	1.5	23	28	1.75
	88GB2423R	559	615	24	1.5	23	28	1.75

3/4 Height Modesty Panels for Modular Tops with 2- 16" Pedestals	88MP6031	648	714	28	0.75	23	20	1.5
	88MP6631	723	795	34	0.75	23	24	2
	88MP7231	799	879	40	0.75	23	26	2.25
	88MP7831	905	994	46	0.75	23	30	2.5
	88MP8431	1011	1110	52	0.75	23	36	2.75
	88MP9031	1192	1310	58	0.75	23	39	3.25
	88MP9631*	1372	1509	64	0.75	23	44	3.5
	88MP10831	1642	1806	76	0.75	23	50	4

3/4 Height Modesty Panels for Modular Tops with 1- 16" Pedestal & 1 Gable	88MP6032	648	714	43	0.75	23	21	1.75
	88MP6632	723	795	49	0.75	23	24	2
	88MP7232	799	879	55	0.75	23	27	2.25
	88MP7832	905	994	61	0.75	23	30	2.75
	88MP8432	1011	1110	67	0.75	23	35	3
	88MP9032	1192	1310	73	0.75	23	40	3.5
	88MP9632*	1372	1509	79	0.75	23	45	3.75
	88MP10832	1642	1806	91	0.75	23	51	4.5

3/4 Height Modesty Panels for Modular Tops with 2 Gables	88MP6033	648	714	57	0.75	23	26	2
	88MP6633	723	795	63	0.75	23	29	2.5
	88MP7233	799	879	69	0.75	23	33	2.75
	88MP7833	905	994	75	0.75	23	39	3
	88MP8433	1011	1110	81	0.75	23	42	3.5
	88MP9033	1192	1310	87	0.75	23	45	3.75
	88MP9633*	1372	1509	93	0.75	23	50	4
	88MP10833	1642	1806	105	0.75	23	56	4.5

3/4 Height Work Surface Support - Half Gable	88HG0723	333	365	7	1.5	23	8	1
	88HG1123*	437	481	11	1.5	23	14	1.25

**ORDERING NOTES:**

Work surface support - Half Gable is used only when a modesty panel is not specified for an unsupported span greater than 60".

**DIMENSION KEY**

W - width  
D - depth  
H - height

**CODE DESCRIPTION**

4 - desk height  
D - 2 file drawer  
F - 2 box, 1 file drawer  
01 - 2 lateral file  
15 - open, lateral file  
16 - box, lateral file

**STANDARD FINISHES**

For a complete list of standard wood finishes, please see page 9.

# ADESSO | MODULAR SUPPORTS & POWER/DATA

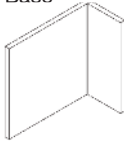
Description	Model	Oak	Anigre	W	D	H	Shipping Weight	Cubic Feet
		Cherry Maple	Walnut					
3/4 Height Work Surface Support - L Base 	88LB2023L	633	696	16	20	23	43	2.25
	88LB2023R	633	696	16	20	23	43	2.25
	88LB2423L	694	763	16	24	23	48	3
	88LB2423R*	694	763	16	24	23	48	3

**NOTE:** Work surface support - L Base is used only when a modesty panel is not specified for an unsupported span greater than 60".

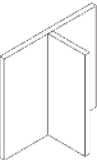
3/4 Height Work Surface Support - T Base 	88TB120723	873	960	12	7	23	28	1.25
	88TB121123*	952	1044	12	11	23	34	1.5

**NOTE:** Work surface support - T-Base is used only when a modesty panel is not specified for an unsupported span greater than 60".

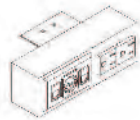
Under Mount Power/Data Module 	88PDM01	633		-	-	-	-	-
--	---------	-----	--	---	---	---	---	---

Under Mount Power Data includes: 2 Simplex receptacles, 1 RJ11, 1 RJ45 & 1 USB Type A/B

**ORDERING NOTES:**

Under mount power data unit can be used for charging with a USB patch cord connected to a transformer.

Silver Metallic Trough 	88CT36	59		30	2	-	0.25	-
	88CT42	74		36	2	-	0.25	-
	88CT48	91		36	2	-	0.25	-
	88CT54	105		48	2	-	0.5	-
	88CT60	121		48	2	-	0.5	-
	88CT66	137		52	2	-	0.5	-
	88CT72	152		60	2	-	0.75	-
	88CT84	168		60	2	-	0.75	-

**ORDERING NOTES:** Used to manage cables to credenzas or floor monuments in desk runoffs, please see page 13 for more information.

Height Adjustable Work Surface Cable Manager 	88HACM1	89		4	3	21.5	5	0.25
---	---------	----	--	---	---	------	---	------

**ORDERING PROCEDURE**

To order, please specify the following:

- 1) Krug product model number
- 2) Wood species and finish

**STANDARD FINISHES**

For a complete list of standard wood finishes, please see page 9.

PowerPort is Satin Aluminum in color.

# POWERPORTS

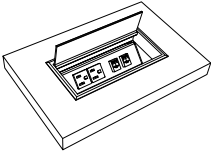
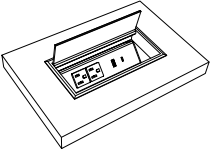
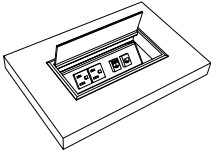
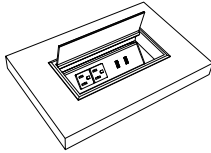
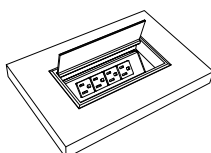
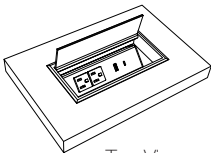
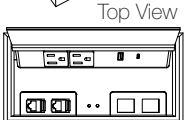
Description	Model	Price	W	D	H	Shipping Weight	Cubic Feet
PowerPort 1 - 2 RJ45s (Category 5/6)	PORT1	278	8	4	-	-	-
	<p><b>Port Includes:</b> 2 accessible power outlets &amp; 1 side utility outlet powered by a 10' plug-in cord; 2 RJ45 (category 5/6) each with hard wired 10' data cords; 2 velcro wire managers and metal PowerPort shroud. PortPort lid is Silver Metallic.</p> <p><b>NOTE:</b> RJ45 jacks with hard wired data cords included here must be within 10' of building utilities source to be functional.</p>						
PowerPort 2 - USB-A & USB-C	PORT2	280	8	4	-	-	-
	<p><b>Port Includes:</b> 2 accessible power outlets &amp; 1 side utility outlet; 1 USB-A &amp; 1 USB-C charging ports all powered by a 10' plug-in cord; 2 velcro wire managers and metal PowerPort shroud. PortPort lid is Silver Metallic.</p>						
PowerPort 3 - RJ11 & RJ45	PORT3	270	8	4	-	-	-
	<p><b>Port Includes:</b> 2 accessible power outlets &amp; 1 side utility outlet; 1 RJ11 &amp; 1 RJ45 (Category 5/6); 2 Velcro wire managers &amp; PowerPort Shroud; 1 x 10 Foot Data Cords (T568A) &amp; 1 x 14 Foot RJ11 (Telecomm); powered by a 10' plug-in cord. PortPort lid is Silver Metallic.</p> <p><b>NOTE:</b> RJ45 &amp; RJ11 jacks with hard wired data cords included here must be within 10' of building utilities source to be functional.</p>						
PowerPort 4 - 2 USB-A	PORT4	287	8	4	-	-	-
	<p><b>Port Includes:</b> 2 accessible power outlets &amp; 1 side utility outlet; 2- USB-A charging ports all powered by a 10' plug-in cord; 2 velcro wire managers and metal PortPort shroud. PortPort lid is Silver Metallic.</p>						
PowerPort 5 - 4 Receptacles	PORT5	280	8	4	-	-	-
	<p><b>Port Includes:</b> 4 accessible power outlets &amp; 1 side utility outlet powered by a 10' plug-in cord; 2 velcro wire managers and metal power port shroud. PortPort lid is Silver Metallic.</p>						
PowerPort 6 - USB-A, USB-C & RJ45	PORT6	406	8	4	-	-	-
 	<p><b>Port Includes:</b> 2 accessible power outlets &amp; 1 side utility outlet 1 USB-A, 1 USB-C charging ports all powered by a 10' plug-in power cord. Includes 2 velcro wire managers and metal PortPort shroud with 2 data plate knock outs, 1 #M02 plate insert &amp; 2 #S01W RJ45 female input, punch down terminal output snap in jacks. 2nd data plate knock out is blank for future use. PortPort lid is Silver Metallic.</p>						

# POWERPORTS

Description	Model	Price	W	D	H	Shipping Weight	Cubic Feet
Port - no Powerbar	Port0	137	8	4	-	-	-

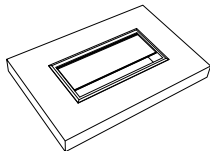

**Port Includes:** Port lid & Shroud only.

**ORDERING NOTE:** Velcro wire managers not included, see below for pricing. Port lid is Silver Metallic.

PowerPort Shroud with 2 Data Plate Knock-outs	SHROUD2KO	Must be requested - no upcharge	-	-	-	-	-
---	-----------	------------------------------------	---	---	---	---	---

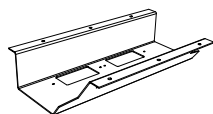

Angled PowerPort Shroud Includes: shroud with 2 data plate knock-outs in the bottom.

**ORDERING NOTE:** Please refer to data plate, data and AV integration options on page XX.

Velcro Wire Manager (qty 1)	WM-4	26	2	4.5	0.5	-	-
-----------------------------	------	----	---	-----	-----	---	---

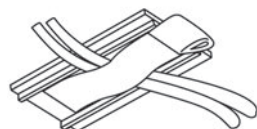

2 velcro wire managers are included with Ports 1-5.

Wire Management Trough	WM-72	182	72	3	1	-	-
------------------------	-------	-----	----	---	---	---	---



Wire Management Trough is standard in a 72" length & can be cut to specific length; double-sided tape installation.

4-Channel Wire Management	CM-72	231	72	3	1	-	-
---------------------------	-------	-----	----	---	---	---	---

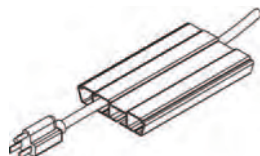



4-Channel Wire Management is standard in a 72" length & can be cut to specific length; double-sided tape installation.

Round Grommet	Round Grommet - Silver Metallic	152	-	-	-	-	-
	Round Grommet - Black	152	-	-	-	-	-

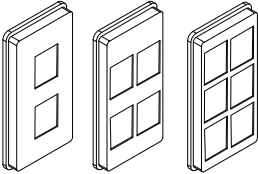

One 60mm Grommet in a standard position is available at no charge per table.

# POWER/DATA

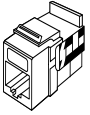
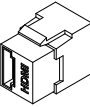
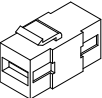
SNAP IN PORTS	Reference Code	Description	List Price
<b>ADAPTOR PLATES</b>			
	<b>M02</b>	<b>Adaptor Plate (2)</b> - accepts two snap in data ports	38
	<b>M04</b>	<b>Adaptor Plate (4)</b> - accepts four snap in data ports	38
	<b>M06</b>	<b>Adaptor Plate (6)</b> - accepts six snap in data ports	38
<b>ORDERING NOTES:</b> Blank covers are required when port is not in use, please see page 55.			
		<b>RJ-45</b> - Category 6 data connection. This connector is also downwards compatible with Category 5 cabling. Connector is a female input with a #110 punch-down terminal block output (back side of Console interface) for on-site hard wire connection.	47
	<b>S01W</b>	RJ45-CAT6 (White)	
	<b>S01B</b>	RJ45-CAT6 (Blue)	
	<b>S01R</b>	RJ45-CAT6 (Red)	
		<b>RJ11</b> - Telephone type connection. Connector is a female input with a #110 punch-down terminal block output (back side of Console interface) for on-site hard wire connection.	32
	<b>S02W</b>	RJ11 (White)	
	<b>S02B</b>	RJ11-B (Black)	
	<b>S02G</b>	RJ11-G (Green)	
	<b>S02R</b>	RJ11-R (Red)	
	<b>S02Y</b>	RJ11-Y (Yellow)	
	<b>S04</b>	<b>HDMI</b> - High Definition Multimedia Interface connection. Connector carries both HD audio and video data. Connector is a female-to-female pass through.	173
	<b>S08</b>	<b>USB-A</b> - Full size USB "A" style connection. Connector is a female-to-female pass through.	61

**VESTRADA | TABLE OF CONTENTS**

110	Environmental Summary
111	Finishes
112	Edge Detail Profile
113	Drawer Pulls & Locks
114	Power Management & Grommets
115	Features
118	Custom Sizing
119	Filing Instructions
120	V-Ped
121	Sample Configuration
122	Pedestal Desks
127	Shaped Desks
132	Table Desks
133	Table Desk Pedestals
134	Height Adjustable Worksurfaces
139	Link Units
141	Returns
150	Shaped Returns
157	TracDesks
159	Credenzas
182	Modular Component Guidelines
186	Modular Tops
187	Modular Pedestals
193	Modesty Panels
195	Work Tables
199	PowerPorts & Grommets
202	Accessories
204	Wall Hung Overheads
206	Storage
225	WorkWall Components   Guidelines
231	WorkWall Components   Hutches
234	WorkWall Components   Overheads
242	WorkWall Components   Piers



## LEED CERTIFICATION



### MATERIAL CONTENT:

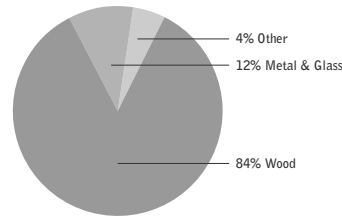

PRE-CONSUMER RECYCLED CONTENT - 76%

POST-CONSUMER RECYCLED CONTENT - 2.5%

		CONTRIBUTES TO
Credit 2.1 - 2.2	Construction Waste Management	1-2 point(s)
Credit 3.3	Resource Reuse	1 point
Credit 4.1	Recycled Content	1 point
Credit 4.2	Recycled Content	1 point
Credit 4.5	Low Emitting Materials, (MUST BE REQUESTED ) Composite Wood & Laminate Adhesives	1 point
Credit 5.1	Regional Materials*	1 point
Credit 6	Rapidly Renewable Materials (MUST BE REQUESTED )	1 point
Credit 7	Certified Wood (MUST BE REQUESTED )	1 point

\*This credit is only applicable if in total 20% of the combined value of the procurement of construction materials and in the furniture are manufactured within a radius of 500 miles. This credit will apply if the installation of the finished product occurs within 500 miles of Kitchener, Ontario.

### level® CERTIFICATION



BIFMA's e3 Furniture Sustainability Standard is a voluntary, multi-attribute standard that measures the degree of sustainability of furniture. This standard evaluates product and company environmental attributes and compliance systems in a wide range of elements which include Materials, Energy & Atmosphere, Human & Ecosystem Health and Social Responsibility. Vestrada products have earned level®, BIFMA's sustainability certification program for furniture, certification through third-party verification against the e3 standard. All Vestrada products can be supplied with level® certification. In order to accomplish this, the product must also be ordered with the air-emissions-certification option. Contact customer service for information and upcharges.

### AIR-EMISSIONS

All Vestrada products can be supplied with air-emissions-certified materials. Contact customer service for information and upcharges.



FSC®  
www.fsc.org  
FSC® C021699

the mark of responsible forest

### FSC®

FSC® In 2005, Krug received Forest Stewardship Council® (FSC®) Chain-of-Custody certification for our manufacturing facilities. The FSC® Chain-of-Custody tracks certified wood from seedling to final sale. It verifies that the material for our FSC® certified products only come from well-managed, FSC®-certified forests and other controlled sources. FSC® is dedicated to the promotion of responsible forest management worldwide helping to take care of forests for future generations. Vestrada and other Krug products can be specified with FSC® Certification. Contact customer service for further information, pricing and lead times.



In addition, architects, designers, and building professionals can specify FSC®-certified products in order to achieve a point from the U.S. Green Building Council's Leadership in Energy and Environmental Design (LEED) Rating System.

## VESTRADA | FINISHES

### WOOD FINISHES

Standard wood finishes are:

#### SPECIES FINISH

Cherry	Light Cherry Natural Cherry American Cherry Medium Cherry Standard Cherry Imperial Cherry Appalachian Cherry Sable Cherry
Maple	Clear Maple Honey Maple Wheat Maple
Oak*	Light Oak Harvest Oak Mahogany Oak Medium Cherry on Oak Mellow Oak Walnut on Oak Espresso on Oak
Walnut	Natural Walnut Regular Walnut Mahogany on Walnut Dark Walnut Cordovan Walnut
Anigre	Clear Anigre Medium Anigre

\*VESTRADA Oak veneers are rift cut.

### PALETTE FINISHES

Standard solid color finishes are:

Black  
White  
Sand  
Soft green  
Steel blue  
Slate  
Please refer to VESTRADA brochure for color reference.

### V-Beam

Standard finishes are:

Satin Aluminum  
Matte Black

### WOOD FINISHES TO MATCH STANDARD LAMINATES

Willow on Rift Oak  
Dune on Rift Oak  
Portobello on Rift Oak  
Ash on Rift Oak  
Copper on Cherry  
Shiraz Cherry  
Park Avenue Walnut  
Chocolate on Walnut  
Nutmeg on Walnut  
Dark Walnut  
Hardrock Maple

Wood is a natural product with inherent color variations that will never be fully mitigated by the finishing process. Please anticipate variation in colors within a single unit, from piece to piece, and from Krug wood finish samples. If a very close match is required, a sample must be provided with the order and an upcharge will apply. Exact color matches are not possible.

### Custom Wood Finishes

Add 10% list per item for special finishes; minimum upcharge is **\$551 list** per finish per order. (For example, on all orders up to \$5512 list, an upcharge of **\$551 will apply**, on orders \$5512 and up add 10% list to your order.) For orders with special finishes a sample that is a minimum 3" by 3" must be received with the order. Special finishes may add additional lead time to production schedules.

Since wood is a natural product, some variations in grain, color and stain acceptance will occur. In our finishing processes, we try to minimize variations, but some variation between samples and finished goods should be anticipated

### Birdseye Maple

Bookmatched Birdseye Maple veneer is available on VESTRADA at an upcharge of \$76 list per square foot. Specify clearly on order. Birdseye Maple is recommended in clear finish only. Birdseye Maple only applies to tops.

### Dual Finishes

Add 10% list per item if specifying dual finish

### Custom Palette Finishes

Custom palette finishes are available at an upcharge of 10% list and an additional 2 weeks lead time after final color approval.

**WORKSURFACE EDGE PROFILE**

All work surfaces are 1 1/8" thick, veneered Medium Density Fiberboard. Worksurface height tops have a chemically impregnated backer for additional strength. Profiled edges of worksurfaces have a .12" (3mm wood banding with an under cut detail leaving a visible edge of 3/4". Vestrada comes standard with a tapered edge.



Desk work surfaces have an edge profile on front and rear sides. Ends are flat with no profile shape.

Run-off work surfaces such as Bullet and "P" shapes have an edge profile that extends around the curved section.

The remaining blunt end is flush with no profile shape.

Credenza, Returns and Linking tops have profile on the front side while all remaining edges, are flush with no profile.

**KEY:**

-  Profile Edge
-  Flush Edge
-  Grain Direction

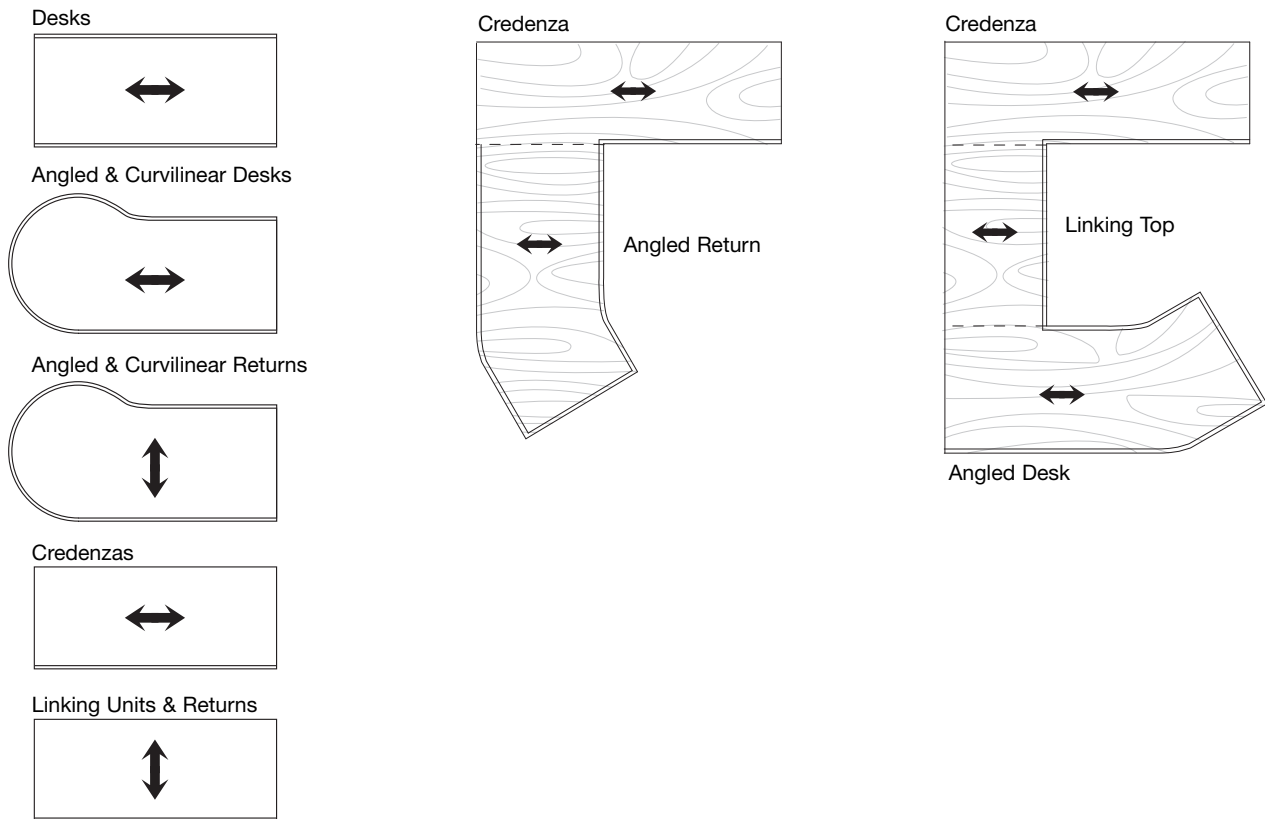

**GRAIN DIRECTION**

Vestrada grain direction runs left to right on all cases.

Providing a consistent wood grain direction is important in maintaining consistent color on adjacent work surfaces.

Such is the case with "L" or "U" configurations

The above illustrations explain the grain direction on typical worksurfaces that run at right angles to one another.

**V-BEAMS**

Raised worksurfaces are supported by 2" high accent V-Beams. Each V-Beam is available in either Silver or Black finish and is fixed to the underside of the worksurface. The V-Beam is undersized to the worksurface and is inset by 4" on all sides.

# VESTRADA | DRAWER PULLS & LOCKS

## DRAWER PULLS

Two drawer pull options are available, each metal pull is available in a Satin Aluminum finish. The Fimosa is also available in Matte Black. Both style and finish must be specified on order. The Mazara pull is located asymmetrically on each face. Combinations of long and short pulls and their bias mounting locations add to the visual dynamic of Vestrada. Mazara pulls are designed to be placed to the right of the center line regardless of the drawer width. Therefore, pulls on a 16" pedestal will extend to the outer edge while on a 24" pedestal, the pulls fall short of the edge. Mazara pulls when specified on factory assembled desks are located toward the kneespace rather than the typical right bias position as described above. Factory assembled desks include double pedestal desks with 16" or 24" wide pedestals.

### Mazara

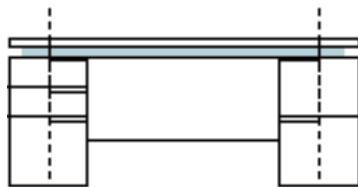
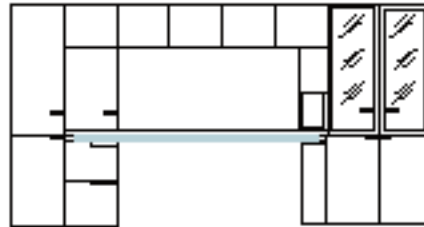
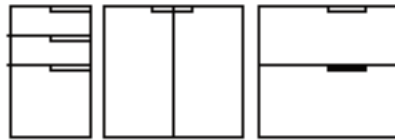

Factory assembled and Modularly shipped Desk  
Mazara pull locations.

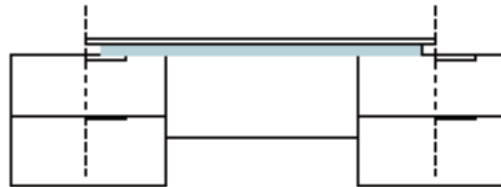

Modularly shipped Mazara pull locations.

An alternative to the asymmetrically located pull, is the Fimosa pull, with a centered mounting location.

### Fimosa

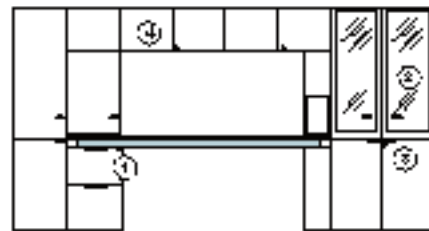
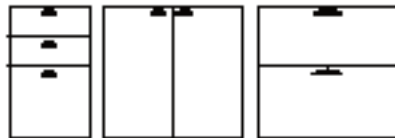

# VESTRADA | POWER MANAGEMENT & GROMMETS



## WORKSURFACE ELLIPTICAL BASE SUPPORTS

The Vestrada Elliptical base is a refreshing change from the standard supports offered in most casegood lines. End caps are made from aluminum and the body of the base is covered in either wood veneer or grade 3 palette panel fabric, and has Satin Aluminum end caps. Its design allows for not only a stylish look but provides for unseen wire management. By removing the veneer panels, access is gained to the interior where wiring can be routed from the worksurface to floor or wall receptacles. Small cut-outs at the top and bottom of the base along the inside center allow wires to be channeled down through the length of the base and into floor mounted power/data monuments



## POWERPORT

A PowerPort is a unique worksurface mounted module that can be specified to a location that best serves the user's needs. PowerPort is constructed of anodized aluminum and it includes a UL approved electrical, voice and data power bar, containing two 115 - volt electrical simplex outlets which are accessible from the work surface, plus a utility outlet at the end for daisy chaining purposes. 3 data versions are available, please see page 202 for options. A Port, a service module having no power bar will serve as a large grommet. A hinged lid easily enables the passage of several cables and devices.



## GROMMET

A plastic rectangular grommet in black or grey is also available. It has no optional electrical service, but serves to provide cable passage for areas not requiring a large opening. One rectangular grommet in a standard location accompanies any worksurface. For additional grommets see page 202 for pricing. Grommets can be field installed with a power drill, 2 1/4" hole saw and rasp or saber saw. Template for drilling is available.



## WIRE MANAGEMENT TROUGH

Beneath the worksurface is a series of wire management troughs that can be field installed. Every trough is divided into four separate channels, each with a flexible cover that permits easy insertion of wire cables. The supporting worksurface frame will be encountered at intersections of interconnecting tops. It will be necessary to "loop" any cabling below the frame and return it to the next series of wire management troughs. A velcro wire management strip is provided to assist in containing the cables as near the area where the cables are looped around the frame. (Only comes with PowerPorts).

Double pedestal desks feature a wire management passage in the back of the pedestal for use when PowerPorts or rectangular grommets are located above pedestals.

Connecting to wall located outlets, requires passage through modesty panels. Hinged modesty panels feature a crescent shape cut-out. The wire management cut-out is also available on fixed modesty panels



## V-BEAM

The underside of VESTRADA tops feature a concealed wire management cavity created by the V-Beam. The V-Beam also gives VESTRADA its unique floating top appearance. The V-Beam is available in Satin Aluminum or Matte Black.

### Rectangular grommet and PowerPort positions

Worksurfaces

Locations apply to both Rectangular and Bow Top Desks.

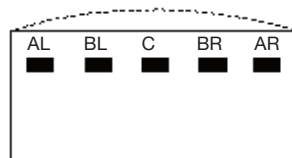

Only Rectangular grommets are available on Elliptical Tops



This key applies to all Run-off Desk shapes.

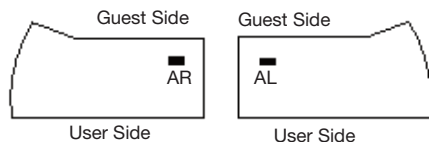

Position code:

AR - Right Corner on left hand Return / Desks

AL - Left Corner on right hand Return / Desks

### Position code:

AL – left corner

BL – left end beside pedestal gable

C – center

BR – right end beside pedestal gable

AR – right corner

Please note pedestals have access wiring cut-outs for wire management. Applicable to factory assembled cases only.

# VESTRADA | FEATURES



## LAMINATE WORKSURFACES

Laminate worksurfaces are available for the VESTRADA product line at an upcharge of 10% (a higher upcharge may apply to specially priced plastic laminates. See page 6 for a list of Krug standard laminates. Where there are wood profile edges on worksurface tops, they will remain as wood profiles on laminate tops. Where there are flush edges, as in the backs of credenzas or link units, they will be self edged with laminate.

Krug will order and procure laminates. Purchase orders with a plastic laminate option must include:  
 Manufacturer's Name  
 Laminate Name  
 Laminate Number

Laminate sheen level should not exceed 60° for maximum durability of work surfaces. Please contact Krug Customer Service if ordering wood grain patterned laminate for VESTRADA product to ensure proper ordering procedure for grain direction. Krug reserves the right to decline a laminate that may not be suitable for the application. Krug assumes no responsibility for the durability, consistent coloration or any other performance characteristic of a customer specified laminate. Laminates will extend the normal lead-time, check with Customer Service for current scheduling information.



## MODESTY PANELS

VESTRADA modesty panels are available in a variety of styles and sizes with many unique features. Floating modesty panels are available on all free standing and transitional Run-Off Desks and Table Desks. Tempered glass face-mounted modesty panels are available on all double pedestal desks. Wood face-mounted modesty panels are available on rectangular and bow-top double pedestal desks only. Recessed modesty panels, available on desks, returns and credenzas are available in both 3/4 and full eight versions. Recessed modesty panels are inset by 4.75" inches. Hinged modesty panels are optional on all credenzas, returns and link units and feature a wire management cut-out in a top centered position to allow access to wall mounted power and data outlets. The wire management cut-out option is available on returns and link units, and is standard on hinged modesty panels and credenzas with fixed modesty panels.



Glass Face Mounted Modesty Panel



## PEDESTAL OFFSETTING

VESTRADA offers the unique and functional feature of offsetting pedestals when ordering modular product. This feature is available on VESTRADA desks, returns and credenzas. (please see modular pricing section for options. Pedestal offsetting provides the flexibility for more or less kneespace depending on the space constraints involved. Using either anti-skid tape (comes standard with all modular VESTRADA product to provide infinite off setting amount or VESTRADA's unique metal-to-metal fitments (provided for preset positions only. 2 per case regardless of width, tops can be placed over pedestals in a variety of locations at any time.

This feature not only provides solutions where space and comfort is required, but also gives each VESTRADA setting the unique style and design. Whether it is a dramatic 32" offset left and right pedestal credenza, or a classic 16" inset left and right pedestal credenza, VESTRADA gives every user the option to change as the workplace evolves. Because tops must be under supported by at least 12" of pedestal, offsetting is only available when used in conjunction with 24, 32 and 36" wide pedestals (please see modular pricing section for options.



## GLASS SCREENS

Glass screen dividers can be mounted to credenzas, returns or linking units to form a stylish visual barrier. The material selection for the screen is a 14" high, 6mm thick etched glass. As a means of securing each panel to the work surface, metal screen holders are attached to the worksurface. Quantity varies by length, 2-4 brackets.





### DESKS

Single and double pedestal desks are available with rectangular, bow or elliptical top shapes. Vestrada desk compositions have numerous features that allow each user the ability to customize their workspace. 8 different top shapes, a huge selection of pedestal styles and sizes, and a unique modesty panel offering combine to make the Vestrada desk incredibly functional and stylish. Additional features include a bow top option on rectangular desks as well as leather inserts, which are available on Rectangular or Bow-top desks. Please see Desk section for more information.

VESTRADA run-off desks are available in 8 unique shapes as shown below.

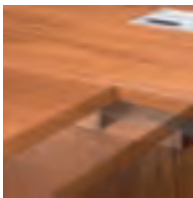
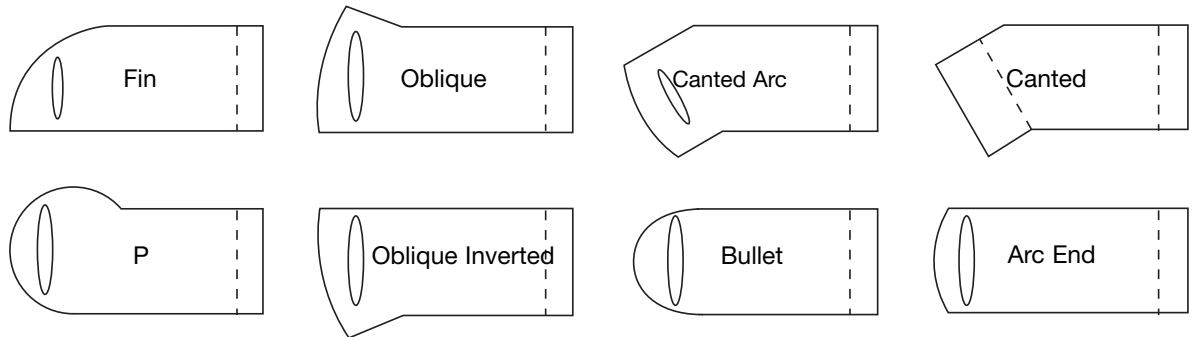

### RETURNS & RUN OFFS

In terms of options and versatility, the Vestrada Return offering is second to none. Basic pedestal returns, curvilinear returns with elliptical bases and sliding returns allow the user to move the return to various positions. Please see pages 152-167 for options and pricing. The TracDesk is a unique worksurface that moves along a track facilitated by a mobile elliptical base. Please see pages 168-169 for pricing and options.



### TABLE DESKS

Table desks are available in rectangular and elliptical tops, which can accommodate pedestals on either side of its bases for storage. Turn to page 136 for compatible pedestals. Floating modesty panels are available on both size options. A bow top option is also available for the rectangular top.



### CREDENZAS

VESTRADA credenzas offer a broad selection of storage solutions for any office. Credenzas are available as full-face units, and units with fixed pedestals that are offset from the worksurface. Additionally, a select number of credenzas offer an added feature, pedestals that are movable. These pedestals can be moved laterally in relation to the worksurface. Moving a pedestal outward provides for more knee-space, while moving the pedestal inward will allow for more space around the unit. Credenzas in this line are available with inset pedestals, with inset and offset pedestal combinations, or as full face units. Credenzas can be specified using modular components (see pages 197-207 or as a factory assembled cases. Modular versions offer the option to move pedestals in toward the kneespace or away from the kneespace depending on space constraints.



### ACCESSORIES

All upper storage configurations having a tackboard will provide an area for the support of convenience accessories. An optional extruded aluminum rail is attached to the tackboard in a manner that leaves no visible screws. With the rail attached, suspension of each accessory is a simple matter of hooking onto the rail's edge. Each accessory can be removed or repositioned along the entire length of the rail at any time. Accessories include a binder bin, flip sorter, paper tray and file hanger. Each item is construction of eighteen-gauge sheet metal and finished in a powder coated Silver Metallic, to compliment all other metal finishes.



### WORK / MOBILE WORK TABLES

Mobile tables are available in two heights in wood or paint. The lower height tables are designed to fit beneath standard worksurface heights. All mobile tables feature 3" locking casters to facilitate easy movement on any floor surface. Alternatively, stationary work tables are available with adjustable glides. Glass tops are available for the Delta shape only. The 10mm thick tempered glass top is supported on three legs connected to a triangular metal frame. Each leg is powder coated Silver Metallic to complement all other metal components.

## VESTRADA | FEATURES



### HUTCHES

VESTRADA hutches provide a traditional solution to overhead storage. See pages 243-245 for more information.



### WORKWALL COMPONENTS

Workwall components provide custom overhead storage solutions. See pages 237-242 for Workwall component guidelines.



### MODULE

An intrinsic design theme establishes the use of an 8" module throughout the product range. This horizontal dimensional grid establishes a harmonious alignment of cabinet faces when cabinets are combined as a group. Horizontal alignment of drawer and door faces is maintained between cabinets. These properties ensure that the overall appearance of cabinets will be aligned with one another when combined into different settings. To further reinforce a consistent appearance of this module, an 8" wide end support is used for supporting worksurfaces.



### MODULARITY

VESTRADA has been designed for change with an enormous standard product offering and the ability to reconfigure and change-out components effortlessly. Pedestals are designed to be offset when space becomes constrained or increased. Metal-to-metal fitments and precise tolerances allow changes to be made quickly and easily without the need for an installer or confusing instructions. With features like TracDesk, mobile pedestals, and mobile work tables, the office can now adjust to the user rather than the user adjusting to the office. VESTRADA is flexible and ready for the changes and demands associated with the workplace – the way it should be.



### LATCHES

Hinged door overheads and 8" piers feature touch latches. All other hinged doors are self-closing with pulls.



### GLIDES

Adjustable glides are installed at factory and are 1 1/4" long and allow for a range of adjustment of 3/4".



### HINGES

Hinged doors are European style with a 95 degree opening angle. Hinges on 8" pier cabinets providing end support have 83 degree hinges to prevent contact with adjacent cabinets or walls. All hinges are fully adjustable.



**VESTRADA CUSTOM SIZING**

As you can see, the standard range of sizes and options in VESTRADA is huge. But it doesn't end there. Using the instructions below, you can customize the sizing of most components and price yourself. Custom-sized products may require an extended lead time if they have not been previously engineered.

Products that can be custom sized:

Desks (excluding elliptical top desks and face-mounted modesty panels)  
 Table Desks (excluding elliptical top desks)  
 Run-Off Desks (excluding curvilinear shaped units with a non-standard radius)  
 Link Units  
 Returns  
 Run-Off Worksurfaces  
 Kneehole Credenzas  
 Shells  
 Modular Tops  
 Modesty Panels  
 Run-Off Worksurfaces (excluding curvilinear shaped units with a non-standard radius)  
 Kneehole Credenzas  
 Shells  
 Modular Tops  
 Modesty Panels (excluding face-mounted glass modesty panel)  
 Wood Door Overheads  
 Wood Door WorkWalls  
 Bookcases  
 Wood Door Storage Units

**Custom widths:** Apply the price of the same unit in the price list that is one standard size larger than the desired case size (same depth). For example: The required custom dimension is 74"x24". The first standard size above this is 80"x24", so in this case, you would apply the price of the 80"x24" unit.

**Custom depths:** Apply the price of the same unit one size deeper. For example: The required custom dimension is 72"x26". The first standard size above this is 72"x30", so in this case, you would apply the price of the 72"x30" unit.

**Custom width & depth:** Apply the price of the same unit both one size wider and one size deeper. For example: The required custom dimension is 74"x26". The first standard size above this is 80"x30", so in this case you would apply the price of the 80"x30" unit.

**TESTING INFORMATION**

VESTRADA meets or exceeds the testing requirements of ANSI/BIFMA X5.5-2014 and/or X5.9 - 2012.

# VESTRADA | FILING INSTRUCTIONS

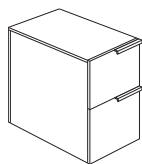

## FILING INSTRUCTIONS

All file drawers will accept both letter and legal size filing  
 All units are equipped with file bars to accommodate filing in either direction

### Desk filing capacity

- 16" wide file drawer
  - 21" of letter filing front to back
  - 12" of letter filing side to side and 8" of letter filing front to back
  - 12" of legal filing side to side and 5" of letter filing front to back
- Weight capacity of the pedestal file drawers is 100 pounds

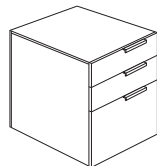

### Credenza and Return Pedestal File Drawers

- 16" wide file drawer
- 15" of letter filing front to back
- 12" of legal filing side to side
- 24" wide file drawer
- 20" of letter filing side to side
- 20" of legal filing side to side

Weight capacity of the pedestal file drawers is 100 pound

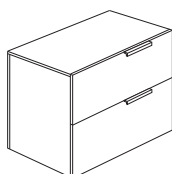

### Lateral File : 32" wide drawers:

- 2 rows 15" of letter filing front to back
  - 28" of legal filing side to side
  - 15" of legal filing front to back and 12" of legal filing side to side
  - 15" of letter filing front to back and 14" of legal filing side to side
- Weight capacity of the pedestal file drawers is 150 pound

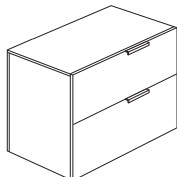

### Lateral File : 36" wide drawers:

- 2 rows 15" of legal filing front to back
- 2 rows 15" of letter filing front to back
- 1 row 15" of legal filing front to back and 1 row of 15" letter filing front to back
- 1 row of 15" legal filing front to back and 1 row 17" of letter filing side to side
- 2 rows of 15" letter filing side to side

Weight capacity of lateral file drawers is 150 lbs

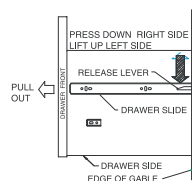

## DRAWER REMOVAL

To remove pedestal drawers, open to the extended position, press down on the right side nylon release lever and pull the drawers up on left side lever at the same time. Continue pulling the drawer out of the case.

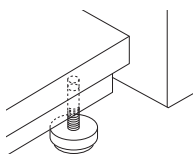

## GLIDE ADJUSTMENT

Raise one corner of the unit at a time and adjust the glide to the desired height by turning the glide. Make sure unit is level after adjusting the glides. Please note that the maximum adjustment range of the glides is 3/4". When moving units after glides have been inserted, dial the glides to the lowest position to prevent damage to the case.

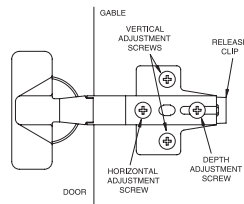

## BOOKCASE OR HUTCH DOOR ADJUSTMENT

Hinges on all hutch and bookcase doors are designed to be adjusted for depth, horizontal and vertical adjustment by means of screws into the hinge mounting plates. To remove a door, squeeze the release clip and pull out the door, disconnecting the hinges.



The VESTRADA V-Ped is a unique storage drawer consisting of components not normally found in case-goods pedestals. The unique vertical storage drawer is 8" wide and is available in conjunction with 16", 24", 32" pedestals. The interior is accessed by pulling the full vertical drawer face away from the pedestal body. The V-Ped cannot be used as a stand-alone pedestal, or ordered to be installed in the field. Please see below for a full breakdown of all components that come standard in V-Peds:

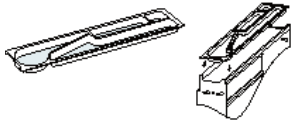

The top of the interior consists of a tray, into which a Silver plastic pencil tray is fitted. This pencil tray is partitioned into four separate storage areas suitable for a variety of stationery needs.

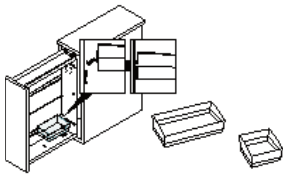

The V-Ped comes equipped with 2 different sized translucent boxes, which can clip onto one of the 3 bars on the interior of the pedestal. The brackets clip onto the bars on the interior panel of the pedestal. The organizer boxes are an easy way to reduce clutter for stationery.

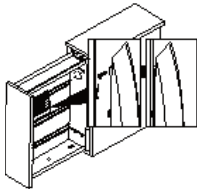

A translucent CD box holds several CD's and clips onto the interior bars.

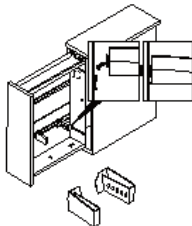

Translucent universal brackets are provided for holding any size of hanging files. Simply snap the brackets in place anywhere on the horizontal hanging bars inside the pedestal.

# VESTRADA | SAMPLE CONFIGURATIONS

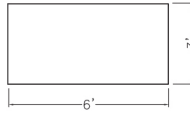
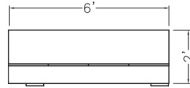
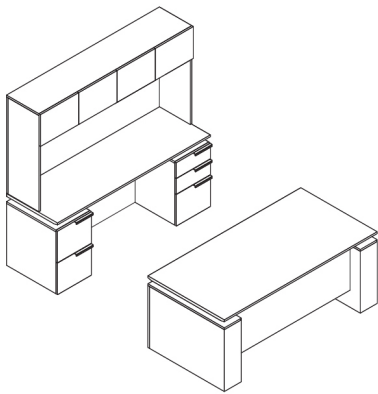

	Model	Walnut Cherry Rift Oak Maple	Anigre
Desk	81D7236L0R0X31	3035	3491
Hutch	81HT721640	4759	5474
Credenza	81CY72244L16DR16FX41	5916	6802
<b>TOTAL</b>		<b>13710</b>	<b>15767</b>

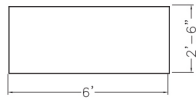
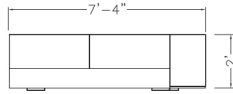
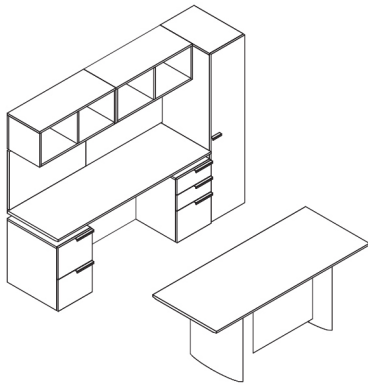

	Model	Walnut Cherry Rift Oak Maple	Anigre
Desk	81DTV7230E2X31	2928	3367
Overhead	81OOW361614HL	1572	1809
Overhead	81OOW361614HL	1572	1809
Tackboard	81TBOHW3624U	312	312
Tackboard	81TBOHW3624U	312	312
Credenza	81CY72244L16DR16FX41	5916	6802
Storage	81ST16247011R	2896	3329
<b>TOTAL</b>		<b>15,508</b>	<b>17,740</b>

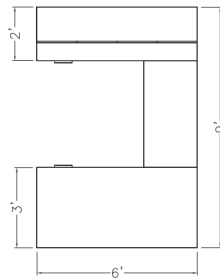
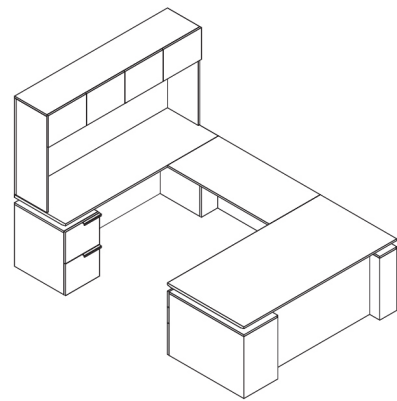

	Model	Walnut Cherry Rift Oak Maple	Anigre
Desk	81D7236L0R16FX41	4709	5415
Link Unit	81LU4824HX41	1846	2125
Hutch	81HT721640	4759	5474
Credenza	81CY72244L16DR0X41	5145	5917
<b>TOTAL</b>		<b>16,459</b>	<b>18,931</b>

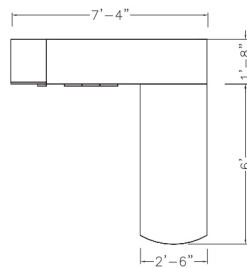
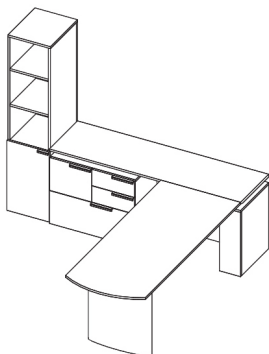

	Model	Walnut Cherry Rift Oak Maple	Anigre
Return	81RHA7230RE2	1997	2295
Credenza	81CY72204L3202R0X41	6850	7879
Storage	81ST16207013L	2972	3417
<b>TOTAL</b>		<b>11,819</b>	<b>13,591</b>

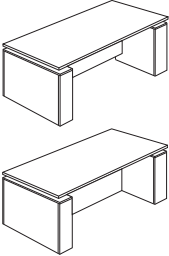
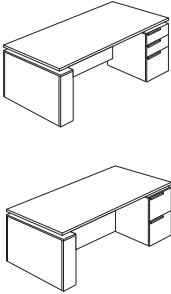
Description	Model	Cherry		W	D	H	KW	Shipping Weight	Cubic Feet	
		Maple	Walnut							
		Rift Oak	Anigre							
	Desk Shell, 3/4	81D6430L0R0X31	2973	3423	64	30	29.25	48	230	39
	Height Recessed	81D7230L0R0X31*	3127	3595	72	30	29.25	56	245	44
	Modesty Panel	81D7236L0R0X31	3278	3770	72	36	29.25	56	288	52
		81D8036L0R0X31	3433	3950	80	36	29.25	64	313	58
		81D8836L0R0X31	3670	4221	88	36	29.25	72	336	64
		81D9636L0R0X31	4068	4679	96	36	29.25	80	356	69
	Single Pedestal Desk, 3/4 Recessed Modesty Panel	81D6430L16DR0X31	4959	5704	64	30	29.25	40	272	39
	81D6430L16FR0X31	4959	5704	64	30	29.25	40	272	39	
	81D6430L0R16DX31	4959	5704	64	30	29.25	40	272	39	
	81D6430L0R16FX31	4959	5704	64	30	29.25	40	272	39	
	81D7230L16DR0X31	5010	5762	72	30	29.25	48	287	44	
	81D7230L16FR0X31	5010	5762	72	30	29.25	48	287	44	
	81D7230L0R16DX31	5010	5762	72	30	29.25	48	287	44	
	81D7230L0R16FX31*	5010	5762	72	30	29.25	48	287	44	
	81D7236L16DR0X31	5085	5849	72	36	29.25	48	330	52	
	81D7236L16FR0X31	5085	5849	72	36	29.25	48	330	52	
	81D7236L0R16DX31	5085	5849	72	36	29.25	48	330	52	
	81D7236L0R16FX31	5085	5849	72	36	29.25	48	330	52	
	81D8036L16DR0X31	5178	5955	80	36	29.25	56	355	58	
	81D8036L16FR0X31	5178	5955	80	36	29.25	56	355	58	
	81D8036L0R16DX31	5178	5955	80	36	29.25	56	355	58	
	81D8036L0R16FX31	5178	5955	80	36	29.25	56	355	58	
	81D8836L16DR0X31	5235	6020	88	36	29.25	64	378	64	
	81D8836L16FR0X31	5235	6020	88	36	29.25	64	378	64	
	81D8836L0R16DX31	5235	6020	88	36	29.25	64	378	64	
	81D8836L0R16FX31	5235	6020	88	36	29.25	64	378	64	
	81D9636L16DR0X31	5318	6114	96	36	29.25	72	398	69	
	81D9636L16FR0X31	5318	6114	96	36	29.25	72	398	69	
81D9636L0R16DX31	5318	6114	96	36	29.25	72	398	69		
81D9636L0R16FX31	5318	6114	96	36	29.25	72	398	69		

**ORDERING NOTES:** Replace the 3 after the 'X' in the model number with 4 for a full height modesty panel. i.e. 81D9636L0R16FX41.

<p><b>DIMENSION KEY</b>  W - width  D - depth  H - height  KW - kneehole width  Dimensions are in inches and approximate.  Contact customer service if dimensions are critical.  * Indicates model illustrated by the drawing.</p>	<p><b>CODE DESCRIPTION</b>  L - left hand pedestal position  R - right hand pedestal position  0 - no pedestal  D - 2 file drawer  F - 2 box, 1 file drawer  X31 - 3/4 height recessed modesty panel  X41 - full height recessed modesty panel</p>	<p><b>STANDARD FINISHES</b>  For a complete list of standard wood finishes please see page 114.</p> <p><b>GROMMETS</b>  One wiring grommet in standard position is optional at no charge. See page 202 for more wiring grommet information.</p>
--	--	---

# VESTRADA | DESKS

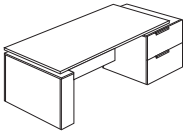
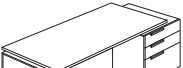
Description	Model	Cherry		W	D	H	KW	Shipping Weight	Cubic Feet
		Maple	Walnut						
		Rift Oak	Anigre						
Single Pedestal	81D6430L24DWR0X31	5111	5876	64	30	29.25	40	314	39
Desk, 3/4 Height	81D6430L24FWR0X31	5111	5876	64	30	29.25	40	314	39
Recessed Modesty Panel with 24"	81D6430L0R24FWX31	5111	5876	64	30	29.25	40	314	39
Extended Single Pedestal	81D7236L24DWR0X31	5240	6024	72	36	29.25	48	372	52
	81D7236L24FWR0X31	5240	6024	72	36	29.25	48	372	52
	81D7236L0R24FWX31**	5240	6024	72	36	29.25	48	372	52
	81D7236L0R24DWX31*	5240	6024	72	36	29.25	48	372	52
	81D8036L24DWR0X31	5332	6134	80	36	29.25	56	387	58
	81D8036L24FWR0X31	5332	6134	80	36	29.25	56	387	58
	81D8036L0R24FWX31	5332	6134	80	36	29.25	56	387	58
	81D8036L0R24DWX31	5332	6134	80	36	29.25	56	387	58
	81D8836L24DWR0X31	5391	6199	88	36	29.25	64	420	64
	81D8836L24FWR0X31	5391	6199	88	36	29.25	64	420	64
	81D8836L0R24FWX31	5391	6199	88	36	29.25	64	420	64
	81D8836L0R24DWX31	5391	6199	88	36	29.25	64	420	64

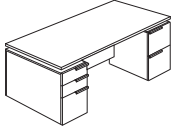
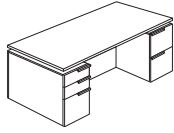
Double Pedestal	81D6430L16DR16DX31	6290	7234	64	30	29.25	32	314	39
Desk, 3/4 Height	81D6430L16DR16FX31	6290	7234	64	30	29.25	32	314	39
Recessed Modesty Panel, 16" Pedestals	81D6430L16FR16DX31	6290	7234	64	30	29.25	32	314	39
	81D6430L16FR16FX31	6290	7234	64	30	29.25	32	314	39
	81D7230L16DR16DX31	6325	7273	72	30	29.25	40	329	44
	81D7230L16DR16FX31	6325	7273	72	30	29.25	40	329	44
	81D7230L16FR16DX31*	6325	7273	72	30	29.25	40	329	44
	81D7230L16FR16FX31	6325	7273	72	30	29.25	40	329	44
	81D7236L16DR16DX31	6409	7371	72	36	29.25	40	372	52
	81D7236L16DR16FX31	6409	7371	72	36	29.25	40	372	52
	81D7236L16FR16DX31	6409	7371	72	36	29.25	40	372	52
	81D7236L16FR16FX31	6409	7371	72	36	29.25	40	372	52
	81D8036L16DR16DX31	6493	7465	80	36	29.25	48	387	58
	81D8036L16DR16FX31	6493	7465	80	36	29.25	48	387	58
	81D8036L16FR16DX31	6493	7465	80	36	29.25	48	387	58
	81D8036L16FR16FX31	6493	7465	80	36	29.25	48	387	58
	81D8836L16DR16DX31	6516	7492	88	36	29.25	56	420	64
	81D8836L16DR16FX31	6516	7492	88	36	29.25	56	420	64
	81D8836L16FR16DX31	6516	7492	88	36	29.25	56	420	64
	81D8836L16FR16FX31	6516	7492	88	36	29.25	56	420	64
	81D9636L16DR16DX31	6585	7573	96	36	29.25	64	440	69
	81D9636L16DR16FX31	6585	7573	96	36	29.25	64	440	69
	81D9636L16FR16DX31	6585	7573	96	36	29.25	64	440	69
	81D9636L16FR16FX31	6585	7573	96	36	29.25	64	440	69

**ORDERING NOTES:** Replace the 3 after the 'X' in the model number with 4 for a full height modesty panel. i.e. 81D6430L0R0X41.

**ORDERING PROCEDURE**

To order, please specify the following:

- 1) Krug product model number
- 2) Wood species and finish
- 3) Pull style and finish, see page 116
- 4) V-beam color, see page 115
- 5) Grommet location and style

\* Indicates model illustrated by the drawing.

**CODE DESCRIPTION**

- L - left hand pedestal position
- R - right hand pedestal position
- 0 - no pedestal
- D - 2 file drawer
- F - 2 box, 1 file drawer
- W - extended pedestal
- X31 - 3/4 height recessed modesty panel
- X41 - full height recessed modesty panel

**STANDARD FINISHES**

For a complete list of standard wood finishes please see page 114.

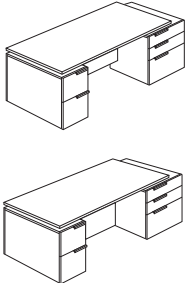
Description	Model	Cherry Maple Walnut		W	D	H	KW	Shipping Weight	Cubic Feet
		Rift Oak	Anigre						
	81D6430L24FWR16FX31	6475	7446	64	30	29.25	32	330	39
	81D6430L24FWR16DX31	6475	7446	64	30	29.25	32	330	39
	81D6430L16FR24FWX31	6475	7446	64	30	29.25	32	330	39
	81D6430L16DR24FWX31	6475	7446	64	30	29.25	32	330	39
	81D7236L24FWR16FX31	6599	7587	72	36	29.25	40	387	52
	81D7236L24FWR16DX31	6599	7587	72	36	29.25	40	387	52
	81D7236L16FR24FWX31	6599	7587	72	36	29.25	40	387	52
	81D7236L16DR24FWX31*	6599	7587	72	36	29.25	40	387	52
	81D8036L24FWR16FX31	6688	7689	80	36	29.25	48	402	58
	81D8036L24FWR16DX31	6688	7689	80	36	29.25	48	402	58
	81D8036L16FR24FWX31	6688	7689	80	36	29.25	48	402	58
	81D8036L16DR24FWX31	6688	7689	80	36	29.25	48	402	58
	81D8836L24FWR16FX31	6713	7718	88	36	29.25	56	435	64
	81D8836L24FWR16DX31	6713	7718	88	36	29.25	56	435	64
	81D8836L16FR24FWX31	6713	7718	88	36	29.25	56	435	64
81D8836L16DR24FWX31	6713	7718	88	36	29.25	56	435	64	

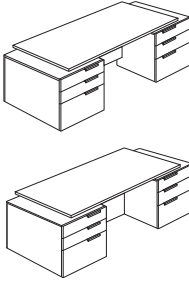
	81D6430L24FWR24FWX31*	6671	7673	64	30	29.25	32	371	32
	81D6430L24FWR24DWX31	6671	7673	64	30	29.25	64	371	32
	81D7236L24FWR24FWX31	6795	7816	72	36	29.25	40	429	40
	81D7236L24FWR24DWX31	6795	7816	72	36	29.25	72	429	40
	81D8036L24FWR24FWX31	6889	7921	80	36	29.25	48	444	48
	81D8036L24FWR24DWX31	6889	7921	80	36	29.25	80	444	48

**ORDERING NOTES:**

Replace the 3 after the 'X' in the model number with 4 for a full height modesty panel. i.e. 81D6430L0R0X41.

	BT81D6430	547	626	64	30	-	-	-	-
	BT81D7236	626	722	72	36	-	-	-	-
	BT81D8036	670	766	80	36	-	-	-	-
	BT81D8836*	749	865	88	36	-	-	-	-
	BT81D9636	838	959	96	36	-	-	-	-

**ORDERING NOTES:**

Bow tops add 15lbs. to the shipping weight of the desk. Add 'BT' before any standard desk model number and apply upcharge.

**DIMENSION KEY**

W - width  
 D - depth  
 H - height  
 KW - kneehole width  
 Dimensions are in inches and approximate.  
 Contact customer service if dimensions are critical.  
 \* Indicates model illustrated by the drawing.

**CODE DESCRIPTION**

L - left hand pedestal position  
 R - right hand pedestal position  
 D - 2 file drawer  
 F - 2 box, 1 file drawer  
 W - extended pedestal  
 X31 - 3/4 height recessed modesty panel

**STANDARD FINISHES**

For a complete list of standard wood finishes please see page 114.

**GROMMETS**

One wiring grommet in standard position is optional at no charge. See page 202 for more wiring grommet information.

# VESTRADA | DESKS

Description	Model	Cherry Maple Walnut		W	D	H	KW	Shipping Weight	Cubic Feet
		Rift Oak	Anigre						
Double Pedestal	81DZ7236L16FR16FX3*	7369	8474	72	36	29.25	40	387	52
Desk, Face Mounted	81DZ7236L16DR16FX3	7369	8474	72	36	29.25	40	387	52
Modesty Panel, 16"	81DZ7236L16FR16DX3	7369	8474	72	36	29.25	40	387	52
Pedestals	81DZ8036L16FR16FX3	7465	8584	80	36	29.25	48	414	58
	81DZ8036L16FR16DX3	7465	8584	80	36	29.25	48	414	58
	81DZ8036L16DR16FX3	7465	8584	80	36	29.25	48	414	58

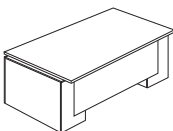
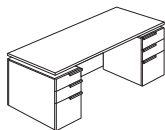

Double Pedestal	81DZ7236L24FWR16FX3*	7591	8728	72	36	29.25	40	410	52
Desk, Face Mounted	81DZ7236L24FWR16DX3	7591	8728	72	36	29.25	40	410	52
Modesty Panel, 24"	81DZ7236L16FR24FWX3	7591	8728	72	36	29.25	40	410	52
& 16" Pedestals	81DZ7236L16DR24FWX3	7591	8728	72	36	29.25	40	410	52
	81DZ8036L24FWR16FX3	7689	8843	80	36	29.25	48	440	58
	81DZ8036L24FWR16DX3	7689	8843	80	36	29.25	48	440	58
	81DZ8036L16FR24FWX3	7689	8843	80	36	29.25	48	440	58
	81DZ8036L16DR24FWX3	7689	8843	80	36	29.25	48	440	58
	81DZ8836L24FWR16FX3	7718	8875	88	36	29.25	56	463	64
	81DZ8836L24FWR16DX3	7718	8875	88	36	29.25	56	463	64
	81DZ8836L16FR24FWX3	7718	8875	88	36	29.25	56	463	64
	81DZ8836L16DR24FWX3	7718	8875	88	36	29.25	56	463	64

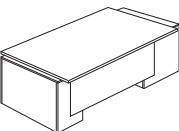
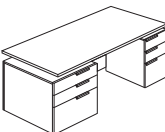

Double Pedestal	81DZ7236L24FWR24FWX3*	7670	8820	72	36	29.25	40	421	52
Desk, Face Mounted	81DZ8036L24FWR24FWX3	7817	8990	80	36	29.25	48	446	58
Modesty Panel, 24"	81DZ8836L24FWR24FWX3	7923	9110	88	36	29.25	56	469	64
Pedestals									

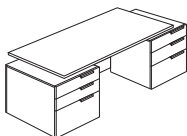

Glass Modesty Panel Upcharges  
72" Desks= **\$317 list** | 80" Desks= **\$507 list**.

**ORDERING NOTES:**

Face mounted modesty panel desk pedestals are 6" shallower than top depth. Add (1) after model number for a wood modesty panel. Add (7) after model number for glass modesty panel. Listed pricing applies to wood modesty panel desks only. Add corresponding size upcharge for glass modesty panel. Desks with glass modesty panels are NOT available on KrugExpress.

**ORDERING PROCEDURE**

- To order, please specify the following:
- 1) Krug product model number
  - 2) Wood species and finish
  - 3) Pull style and finish, see page 116
  - 4) V-beam color, see page 115
- Grommet location and style

\* Indicates model illustrated by the drawing.

**CODE DESCRIPTION**

- L - left hand pedestal position
- R - right hand pedestal position
- D - 2 file drawer
- F - 2 box, 1 file drawer
- W - extended pedestal
- X3 - 3/4 height fixed modesty panel
- Z - face mounted modesty panel

**STANDARD FINISHES**

For a complete list of standard wood finishes please see page 114.



Description	Model	Cherry Maple Walnut		W	D	H	KW	Shipping Weight	Cubic Feet
		Rift Oak	Anigre						
Double Pedestal	81DEZ7236L16FR16DX37	8696	9997	72	36	29.25	40	387	52
Elliptical Desk, Face	81DEZ7236L16DR16FX37	8696	9997	72	36	29.25	40	387	52
Mounted Glass	81DEZ7236L16FR16FX37	8696	9997	72	36	29.25	40	387	52
Modesty Panel,	81DEZ8036L16FR16DX37	8891	10222	80	36	29.25	48	402	58
16" Pedestals	81DEZ8036L16DR16FX37	8891	10222	80	36	29.25	48	402	58
	81DEZ8036L16FR16FX37	8891	10222	80	36	29.25	48	402	58

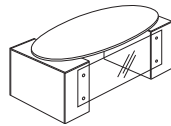
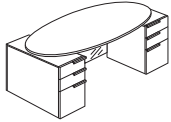

Double Pedestal	81DEZ7236L24FWR16FX37*	8947	10291	72	36	29.25	40	410	52
Elliptical Desk, Face	81DEZ7236L24FWR16DX37	8947	10291	72	36	29.25	40	410	52
Mounted Glass	81DEZ7236L16FR24FWX37	8947	10291	72	36	29.25	40	410	52
Modesty Panel,	81DEZ7236L16DR24FWX37	8947	10291	72	36	29.25	40	410	52
24" & 16" Pedestals	81DEZ8036L24FWR16FX37	9195	10574	80	36	29.25	48	440	58
	81DEZ8036L24FWR16DX37	9195	10574	80	36	29.25	48	440	58
	81DEZ8036L16FR24FWX37	9195	10574	80	36	29.25	48	440	58
	81DEZ8036L16DR24FWX37	9195	10574	80	36	29.25	48	440	58

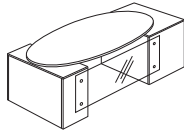
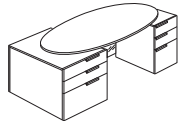

Double Pedestal	81DEZ7236L24FWR24FWX37*	9038	10392	72	36	29.25	40	428	52
Elliptical Desk,	81DEZ8036L24FWR24FWX37	9339	10742	80	36	29.25	48	443	58
Face Mounted Glass Modesty Panel, 24" Pedestals									

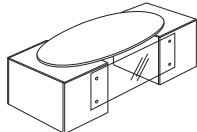
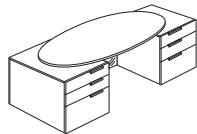

**ORDERING NOTES:**

Only glass face mounted modesty panels are available on elliptical desks. Power ports are not available on elliptical tops. Elliptical desks are NOT available on KrugExpress.

**DIMENSION KEY**

W - width  
D - depth  
H - height  
KW - kneehole width  
Dimensions are in inches and approximate.  
Contact customer service if dimensions are critical.

\* Indicates model illustrated by the drawing.

**CODE DESCRIPTION**

L - left hand pedestal position  
R - right hand pedestal position  
D - 2 file drawer  
F - 2 box, 1 file drawer  
W - extended pedestal  
X37 - 3/4 height fixed glass modesty panel  
Z - face mounted modesty panel

**STANDARD FINISHES**

For a complete list of standard wood finishes please see page 114.

**GROMMETS**

One wiring grommet in standard position is optional at no charge. See page 202 for more wiring grommet information.

# VESTRADA | ANGLED SHAPED DESKS

Description	Model	Cherry		W	D	H	KW	Shipping Weight	Cubic Feet
		Maple	Walnut						
		Rift Oak	Anigre						
Canted Inverted Desk with Pedestal and no Modesty Panel	81DCI6430-38L16F	5477	6297	64	30	29.25	24	246	39
	81DCI6430-38L16D	5477	6297	64	30	29.25	24	246	39
	81DCI6430-38R16F	5477	6297	65	30	29.25	24	246	39
	81DCI6430-38R16D	5477	6297	66	30	29.25	24	246	39
	81DCI7230-38L16F	5623	6468	72	30	29.25	32	261	44
	81DCI7230-38L16D	5623	6468	72	30	29.25	32	261	44
	81DCI7230-38R16F	5771	6639	72	30	29.25	32	261	44
	81DCI7230-38R16D	5771	6639	72	30	29.25	32	261	44
	81DCI7236-44L16F*	5623	6468	72	36	29.25	32	304	52
	81DCI7236-44L16D	5623	6468	72	36	29.25	32	304	52
	81DCI7236-44R16F	5771	6639	72	36	29.25	32	304	52
	81DCI7236-44R16D	5771	6639	72	36	29.25	32	304	52
	81DCI8036-44L16F	6075	6985	80	36	29.25	40	329	58
	81DCI8036-44L16D	6075	6985	80	36	29.25	40	329	58
	81DCI8036-44R16F	6075	6985	80	36	29.25	40	329	58
	81DCI8036-44R16D	6075	6985	80	36	29.25	40	329	58

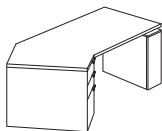

Canted Inverted Desk with Pedestal and 3/4 Floating Wood Modesty Panel	81DCIV6430-38L16FX31	6104	7018	64	30	29.25	24	272	39
	81DCIV6430-38L16DX31	6104	7018	64	30	29.25	24	272	39
	81DCIV6430-38R16FX31	6104	7018	65	30	29.25	24	272	39
	81DCIV6430-38R16DX31	6104	7018	66	30	29.25	24	272	39
	81DCIV7230-38L16FX31	6267	7207	72	30	29.25	32	287	44
	81DCIV7230-38L16DX31	6267	7207	72	30	29.25	32	287	44
	81DCIV7230-38R16FX31	6432	7397	72	30	29.25	32	287	44
	81DCIV7230-38R16DX31	6432	7397	72	30	29.25	32	287	44
	81DCIV7236-44L16FX31*	6267	7207	72	36	29.25	32	330	52
	81DCIV7236-44L16DX31	6267	7207	72	36	29.25	32	330	52
	81DCIV7236-44R16FX31	6432	7397	72	36	29.25	32	330	52
	81DCIV7236-44R16DX31	6432	7397	72	36	29.25	32	330	52
	81DCIV8036-44L16FX31	6769	7787	80	36	29.25	40	355	58
	81DCIV8036-44L16DX31	6769	7787	80	36	29.25	40	355	58
	81DCIV8036-44R16FX31	6769	7787	80	36	29.25	40	355	58
	81DCIV8036-44R16DX31	6769	7787	80	36	29.25	40	355	58

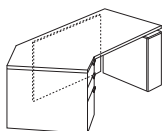

**ORDERING NOTES:**

Canted inverted desks are to be used as stand alone desks. They are not to be used in 'U' configurations due to kneespace limitations. Laminate worksurfaces are available at a 10% upcharge, see page 118 for more information.

**ORDERING PROCEDURE**

To order, please specify the following:

- 1) Krug product model number
- 2) Wood species and finish
- 3) Pull style and finish, see page 116
- 4) V-beam color, see page 115
- 5) Grommet location and style

\* Indicates model illustrated by the drawing.

**CODE DESCRIPTION**

- L - left hand pedestal position
- R - right hand pedestal position
- D - 2 file drawer
- F - 2 box, 1 file drawer
- V - floating modesty panel
- X31 - 3/4 height recessed modesty panel

**STANDARD FINISHES**

For a complete list of standard wood finishes please see page 114. End caps on elliptical bases are sating aluminum.

**LOCKS**

Locks are standard on all pedestals and all lateral file drawers, with the exception on bookcases.

# VESTRADA | ANGLED SHAPED DESKS

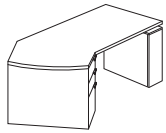
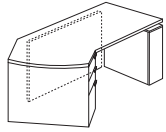
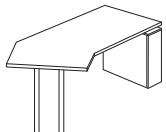
Description	Model	Cherry Maple Walnut		W	D	H	KW	Shipping Weight	Cubic Feet
		Rift Oak	Anigre						
 Canted Arc Inverted Desk with Pedestal and no Modesty Panel	81DCAI6430-38L16F	5477	6297	64	30	29.25	24	246	39
	81DCAI6430-38L16D	5477	6297	64	30	29.25	24	246	39
	81DCAI6430-38R16F	5477	6297	65	30	29.25	24	246	39
	81DCAI6430-38R16D	5477	6297	66	30	29.25	24	246	39
	81DCAI7230-38L16F	5623	6468	72	30	29.25	32	261	44
	81DCAI7230-38L16D	5623	6468	72	30	29.25	32	261	44
	81DCAI7230-38R16F*	5771	6639	72	30	29.25	32	261	44
	81DCAI7230-38R16D	5771	6639	72	30	29.25	32	261	44
	81DCAI7236-44L16F	5623	6468	72	36	29.25	32	304	52
	81DCAI7236-44L16D	5623	6468	72	36	29.25	32	304	52
	81DCAI7236-44R16F	5771	6639	72	36	29.25	32	304	52
	81DCAI7236-44R16D	5771	6639	72	36	29.25	32	304	52
	81DCAI8036-44L16F	6075	6985	80	36	29.25	40	329	58
	81DCAI8036-44L16D	6075	6985	80	36	29.25	40	329	58
	81DCAI8036-44R16F	6075	6985	80	36	29.25	40	329	58
81DCAI8036-44R16D	6075	6985	80	36	29.25	40	329	58	
 Canted Arc Inverted Desk with Pedestal and 3/4 Floating Wood Modesty Panel	81DCAIV6430-38L16FX31	6104	7018	64	30	29.25	24	272	39
	81DCAIV6430-38L16DX31	6104	7018	64	30	29.25	24	272	39
	81DCAIV6430-38R16FX31	6104	7018	65	30	29.25	24	272	39
	81DCAIV6430-38R16DX31	6104	7018	66	30	29.25	24	272	39
	81DCAIV7230-38L16FX31	6267	7207	72	30	29.25	32	287	44
	81DCAIV7230-38L16DX31	6267	7207	72	30	29.25	32	287	44
	81DCAIV7230-38R16FX31	6432	7397	72	30	29.25	32	287	44
	81DCAIV7230-38R16DX31	6432	7397	72	30	29.25	32	287	44
	81DCAIV7236-44L16FX31*	6267	7207	72	36	29.25	32	330	52
	81DCAIV7236-44L16DX31	6267	7207	72	36	29.25	32	330	52
	81DCAIV7236-44R16FX31	6432	7397	72	36	29.25	32	330	52
	81DCAIV7236-44R16DX31	6432	7397	72	36	29.25	32	330	52
	81DCAIV8036-44L16FX31	6769	7787	80	36	29.25	40	355	58
	81DCAIV8036-44L16DX31	6769	7787	80	36	29.25	40	355	58
	81DCAIV8036-44R16FX31	6769	7787	80	36	29.25	40	355	58
81DCAIV8036-44R16DX31	6769	7787	80	36	29.25	40	355	58	
 Canted Arc Inverted Desk with Elliptical Base and no Modesty Panel	81DCAI6430-38LE2	4363	5017	64	30	29.25	34	209	39
	81DCAI6430-38RE2	4363	5017	64	36	29.25	34	209	39
	81DCAI7230-38LE2	4427	5091	72	30	29.25	42	224	44
	81DCAI7230-38RE2	4490	5164	72	30	29.25	42	224	44
	81DCAI7236-44LE2*	4427	5091	72	36	29.25	42	267	52
	81DCAI7236-44RE2	4490	5164	72	36	29.25	42	267	52
	81DCAI8036-44LE2	4555	5238	80	30	29.25	50	282	58
	81DCAI8036-44RE2	4555	5238	80	36	29.25	50	282	58

**ORDERING NOTES:**

Canted Arc Inverted desks are to be used as stand alone desks. They are not to be used in 'U' configurations due to kneespace limitations. Laminate worksurfaces are available at a 10% upcharge, see page 118 for more information.

**DIMENSION KEY**

W - width  
 D - depth  
 H - height  
 KW - kneehole width  
 Dimensions are in inches and approximate.  
 Contact customer service if dimensions are critical.  
 \* Indicates model illustrated by the drawing.

**CODE DESCRIPTION**

L - left hand pedestal position  
 R - right hand pedestal position  
 D - 2 file drawer  
 F - 2 box, 1 file drawer  
 V - floating modesty panel  
 W - extended pedestal  
 E2 - wood elliptical base  
 X31 - 3/4 height recessed modesty panel  
 X41 - full height recessed modesty panel

**STANDARD FINISHES**

For a complete list of standard wood finishes please see page 114.

**GROMMETS**

One wiring grommet in standard position is optional at no charge. See page 202 for more wiring grommet information.

**LOCKS**

Locks are standard on all pedestals and all lateral file drawers, with the exception on bookcases.

# VESTRADA | ANGLED SHAPED DESKS

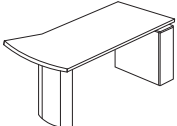
Description	Model	Cherry Maple Walnut		W	D	H	KW	Shipping Weight	Cubic Feet
		Rift Oak	Anigre						
	81DO6430-36LE2	4363	5017	64	30	29.25	40	209	39
	81DO6430-36RE2	4363	5017	64	30	29.25	40	209	39
	81DO7230-36LE2	4427	5091	72	30	29.25	48	224	44
	81DO7230-36RE2	4427	5091	72	30	29.25	48	224	44
	81DO7236-42LE2*	4490	5164	72	36	29.25	48	267	52
	81DO7236-42RE2	4490	5164	72	36	29.25	48	267	52
	81DO8036-42LE2	4555	5238	80	36	29.25	56	282	58
	81DO8036-42RE2	4555	5238	80	36	29.25	56	282	58

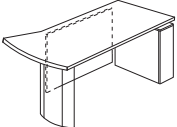
	81DOV6430-36LE2X31	5108	5871	64	30	29.25	40	235	39
	81DOV6430-36RE2X31	5108	5871	64	30	29.25	40	235	39
	81DOV7230-36LE2X31	5179	5957	72	30	29.25	48	224	44
	81DOV7230-36RE2X31	5179	5957	72	30	29.25	48	224	44
	81DOV7236-42LE2X31*	5256	6044	72	36	29.25	48	267	52
	81DOV7236-42RE2X31	5256	6044	72	36	29.25	48	267	52
	81DOV8036-42LE2X31	5328	6127	80	36	29.25	56	282	58
	81DOV8036-42RE2X31	5328	6127	80	36	29.25	56	282	58

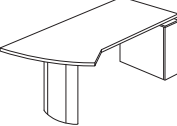
	81DOI6430-36LE2	4363	5017	64	30	29.25	40	235	39
	81DOI6430-36RE2	4363	5017	64	30	29.25	40	235	39
	81DOI7230-36LE2	4427	5091	72	30	29.25	48	224	44
	81DOI7230-36RE2	4427	5091	72	30	29.25	48	224	44
	81DOI7236-42LE2*	4490	5164	72	36	29.25	48	267	52
	81DOI7236-42RE2	4490	5164	72	36	29.25	48	267	52
	81DOI8036-42LE2	4555	5238	80	36	29.25	56	282	58
	81DOI8036-42RE2	4555	5238	80	36	29.25	56	282	58

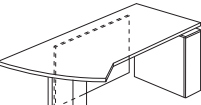
	81DOIV6430-36LE2X31	5108	5871	64	30	29.25	40	235	39
	81DOIV6430-36RE2X31	5108	5871	64	30	29.25	40	235	39
	81DOIV7230-36LE2X31*	5179	5957	72	30	29.25	48	224	44
	81DOIV7230-36RE2X31	5179	5957	72	30	29.25	48	224	44
	81DOIV7236-42LE2X31	5256	6044	72	36	29.25	48	267	52
	81DOIV7236-42RE2X31	5256	6044	72	36	29.25	48	267	52
	81DOIV8036-42LE2X31	5328	6127	80	36	29.25	56	282	58
	81DOIV8036-42RE2X31	5328	6127	80	36	29.25	56	282	58

**ORDERING PROCEDURE**  
 To order, please specify the following:  
 1) Krug product model number  
 2) Wood species and finish  
 3) Pull style and finish, see page 116  
 4) V-beam color, see page 117  
 5) Grommet location and style  
 \* Indicates model illustrated by the drawing.

**CODE DESCRIPTION**  
 L - left hand pedestal position  
 R - right hand pedestal position  
 V - floating modesty panel  
 E2 - wood elliptical base  
 X31 - 3/4 height modesty panel

**STANDARD FINISHES**  
 For a complete list of standard wood finishes please see page 114.

# VESTRADA | CURVILINEAR SHAPED DESKS

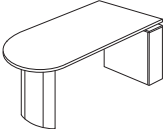
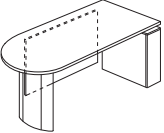
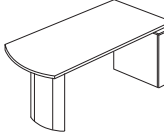
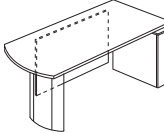
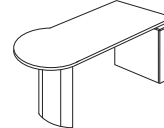
Description	Model	Cherry		W	D	H	KW	Shipping Weight	Cubic Feet
		Maple	Walnut						
		Rift Oak	Anigre						
	81DB6430LE2	3546	4080	64	30	29.25	40	184	52
	81DB6430RE2	3546	4080	64	30	29.25	40	184	52
	81DB7230LE2	3609	4153	72	30	29.25	48	199	44
	81DB7230RE2	3609	4153	72	30	29.25	48	199	44
	81DB7236LE2*	3673	4224	72	36	29.25	48	242	58
	81DB7236RE2	3673	4224	72	36	29.25	48	242	58
	81DB8036LE2	3752	4315	80	36	29.25	56	257	57
	81DB8036RE2	3752	4315	80	36	29.25	56	257	57
	81DBV6430LE2X31	3952	4544	64	30	29.25	40	235	40
	81DBV6430RE2X31	3952	4544	64	30	29.25	40	235	40
	81DBV7230LE2X31	4024	4630	72	30	29.25	48	250	48
	81DBV7230RE2X31	4024	4630	72	30	29.25	48	250	48
	81DBV7236LE2X31*	4095	4709	72	36	29.25	48	293	48
	81DBV7236RE2X31	4095	4709	72	36	29.25	48	293	48
	81DBV8036LE2X31	4180	4809	80	36	29.25	56	308	56
	81DBV8036RE2X31	4180	4809	80	36	29.25	56	308	56
	81DA6430LE2	3378	3882	64	30	29.25	40	184	52
	81DA6430RE2	3378	3882	64	30	29.25	40	184	52
	81DA7230LE2	3437	3955	72	30	29.25	48	199	44
	81DA7230RE2	3437	3955	72	30	29.25	48	199	44
	81DA7236LE2*	3499	4024	72	36	29.25	48	242	58
	81DA7236RE2	3499	4024	72	36	29.25	48	242	58
	81DA8036LE2	3573	4108	80	36	29.25	56	257	57
	81DA8036RE2	3573	4108	80	36	29.25	56	257	57
	81DAV6430LE2X31	3950	4540	64	30	29.25	40	235	52
	81DAV6430RE2X31	3950	4540	64	30	29.25	40	235	52
	81DAV7230LE2X31	4024	4630	72	30	29.25	48	250	44
	81DAV7230RE2X31	4024	4630	72	30	29.25	48	250	44
	81DAV7236LE2X31*	4095	4709	72	36	29.25	48	293	58
	81DAV7236RE2X31	4095	4709	72	36	29.25	48	293	58
	81DAV8036LE2X31	4180	4809	80	36	29.25	56	308	57
	81DAV8036RE2X31	4180	4809	80	36	29.25	56	308	57
	81DP6430-36LE2	4155	4780	64	30	29.25	40	209	39
	81DP6430-36RE2	4155	4780	64	30	29.25	40	209	39
	81DP7230-36LE2	4216	4847	72	30	29.25	48	250	44
	81DP7230-36RE2	4216	4847	72	30	29.25	48	250	44
	81DP7236-42LE2*	4278	4919	72	36	29.25	48	299	52
	81DP7236-42RE2	4278	4919	72	36	29.25	48	299	52
	81DP8036-42LE2	4337	4988	80	36	29.25	56	308	58
	81DP8036-42RE2	4337	4988	80	36	29.25	56	308	58

**DIMENSION KEY**

W - width  
 D - depth  
 H - height  
 KW - kneehole width  
 Dimensions are in inches and approximate.  
 Contact customer service if dimensions are critical.  
 \* Indicates model illustrated by the drawing.

**CODE DESCRIPTION**

L - left hand pedestal position  
 R - right hand pedestal position  
 V - floating modesty panel  
 E2 - wood elliptical base  
 X31 - 3/4 height modesty panel

**STANDARD FINISHES**

For a complete list of standard wood finishes please see page 114. End caps on elliptical bases are satin aluminum.

**GROMMETS**

One wiring grommet in standard position is optional at no charge. See page 117 for more wiring grommet information.

# VESTRADA | CURVILINEAR SHAPED DESKS

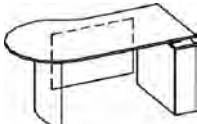
Description	Model	Cherry		W	D	H	KW	Shipping Weight	Cubic Feet	
		Maple	Walnut							
		Rift Oak	Anigre							
	P Desk with Elliptical Base and 3/4 Floating Modesty Panel	81DPV6430-36LE2X31	4863	5590	64	30	29.25	40	235	39
		81DPV6430-36RE2X31	4863	5590	64	30	29.25	40	235	39
		81DPV7230-36LE2X31	4931	5673	72	30	29.25	48	250	44
		81DPV7230-36RE2X31	4931	5673	72	30	29.25	48	250	44
		81DPV7236-42LE2X31*	5005	5756	72	36	29.25	48	299	52
		81DPV7236-42RE2X31	5005	5756	72	36	29.25	48	299	52
		81DPV8036-42LE2X31	5075	5835	80	36	29.25	56	308	58
		81DPV8036-42RE2X31	5075	5835	80	36	29.25	56	308	58

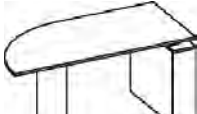
	Fin Desk with Elliptical Base and no Modesty Panel	81DF6430LE2	3546	4080	64	30	29.25	36	209	39
		81DF6430RE2	3546	4080	64	30	29.25	36	209	39
		81DF7230LE2*	3609	4153	72	30	29.25	44	224	44
		81DF7230RE2	3609	4153	72	30	29.25	44	224	44
		81DF7236LE2	3673	4224	72	36	29.25	44	267	52
		81DF7236RE2	3673	4224	72	36	29.25	44	267	52
		81DF8036LE2	3752	4315	80	36	29.25	52	282	58
		81DF8036RE2	3752	4315	80	36	29.25	52	282	58

	Fin Desk with Elliptical Base and 3/4 Floating Modesty Panel	81DFV6430LE2X31	3952	4544	64	30	29.25	36	235	39
		81DFV6430RE2X31	3952	4544	64	30	29.25	36	235	39
		81DFV7230LE2X31*	4024	4630	72	30	29.25	44	250	44
		81DFV7230RE2X31	4024	4630	72	30	29.25	44	250	44
		81DFV7236LE2X31	4095	4709	72	36	29.25	44	299	52
		81DFV7236RE2X31	4095	4709	72	36	29.25	44	299	52
		81DFV8036LE2X31	4180	4809	80	36	29.25	52	308	58
		81DFV8036RE2X31	4180	4809	80	36	29.25	52	308	58

**ORDERING PROCEDURE**

To order, please specify the following:

- 1) Krug product model number
- 2) Wood species and finish
- 3) Pull style and finish, see page 116
- 4) V-beam color, see page 117
- 5) Grommet location and style

\* Indicates model illustrated by the drawing.

**CODE DESCRIPTION**

- L - left hand pedestal position
- R - right hand pedestal position
- D - 2 file drawer
- F - 2 box, 1 file drawer
- V - floating modesty panel
- W - extended pedestal
- E2 - wood elliptical base
- X31 - 3/4 height recessed modesty panel
- X41 - full height recessed modesty panel



**STANDARD FINISHES**

For a complete list of standard wood finishes please see page 114. End caps on elliptical bases are satin aluminum.

**LOCKS**

Locks are standard on all pedestals and all lateral file drawers, with the exception of bookcases.

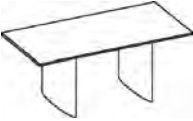
**VESTRADA | TABLE DESKS**

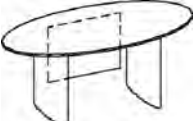
Description	Model	Cherry Maple Walnut		W	D	H	KW	Shipping Weight	Cubic Feet
		Rift Oak	Anigre						
Rectangular Table	81DT7230E2	2701	3105	72	30	29.25	32	219	44
Desk with Elliptical	81DT7236E2	2980	3427	72	36	29.25	32	262	52
Base and no	81DT8030E2*	3121	3591	80	30	29.25	40	240	49
Modesty Panel	81DT8036E2	3433	3950	80	36	29.25	40	277	58
	81DT8830E2	3495	4020	88	30	29.25	48	259	54
	81DT8836E2	3876	4457	88	36	29.25	48	310	64
Rectangular Table	81DTV7230E2X31	3162	3636	72	30	29.25	32	245	44
Desk with Elliptical	81DTV7236E2X31	3484	4005	72	36	29.25	32	288	52
Base and 3/4	81DTV8030E2X31*	3652	4200	80	30	29.25	40	266	49
Floating Modesty	81DTV8036E2X31	3827	4399	80	36	29.25	40	303	58
Panel	81DTV8830E2X31	4089	4704	88	30	29.25	48	236	54
	81DTV8836E2X31	4533	5215	88	36	29.25	48	336	64
Elliptical Table Desk	81DTE7230E2	3263	3752	72	30	29.25	32	219	44
with no Modesty	81DTE7236E2	3594	4132	72	36	29.25	32	262	52
Panel	81DTE8030E2*	3770	4336	80	30	29.25	40	240	49
	81DTE8036E2	3950	4540	80	36	29.25	40	270	58
	81DTE8830E2	4219	4853	88	30	29.25	48	236	54
	81DTE8836E2	4679	5381	88	36	29.25	48	310	64
Elliptical Table Desk	81DTEV7230E2X31	3817	4391	72	30	29.25	32	219	44
with 3/4 Floating	81DTEV7236E2X31	4207	4838	72	36	29.25	32	262	52
Modesty Panel	81DTEV8030E2X31*	4407	5069	80	30	29.25	40	240	49
	81DTEV8036E2X31	4618	5314	80	36	29.25	40	270	58
	81DTEV8830E2X31	4939	5679	88	30	29.25	48	236	54
	81DTEV8836E2X31	5474	6296	88	36	29.25	48	310	64

**ORDERING NOTES:**

Table desks come standard with 2 elliptical bases.

**DIMENSION KEY**

W - width  
D - depth  
H - height

**CODE DESCRIPTION**

L - left hand pedestal position  
R - right hand pedestal position  
D - 2 file drawer  
F - 2 box, 1 file drawer  
V - floating modesty panel  
W - extended pedestal  
E2 - wood elliptical base  
X31 - 3/4 height recessed modesty panel  
X41 - full height recessed modesty panel

# VESTRADA | TABLE DESK PEDESTALS

Description	Model	Cherry Maple Walnut			W	D	H	KW	Shipping Weight	Cubic Feet
		Rift Oak	Anigre	Palette						
Modular Pedestal, File/File-16"	81P16D30*	2615	3010	2355	16	30	26		116	10
	81P16D36	2719	3131	2448	16	36	26		120	10

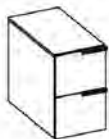

Modular Pedestal, Box/Box/File-16"	81P16F30*	2817	3238	2535	16	30	26		118	10
	81P16F36	2929	3369	2636	16	36	26		122	12



Modular Pedestal, Box/Box/File-24"	81P24F30	2899	3333	2609	24	30	26		120	17
	81P24F36*	2986	3432	2686	24	36	26		124	12



## ORDERING PROCEDURE

To order, please specify the following:

- 1) Krug product model number
- 2) Wood species and finish

## CODE DESCRIPTION

- L - left hand pedestal position
- R - right hand pedestal position
- D - 2 file drawer
- F - 2 box, 1 file drawer
- V - floating modesty panel
- W - extended pedestal
- E2 - wood elliptical base
- X31 - 3/4 height recessed modesty panel
- X41 - full height recessed modesty panel

## STANDARD FINISHES

For a complete list of standard wood finishes please see page 114. End caps on elliptical bases are satin aluminum.

## GROMMETS

One wiring grommet in standard position is optional at no charge. See page 117 for more wiring grommet information.

## LOCKS

Locks are standard on all pedestals and all lateral file drawers, with the exception on bookcases.



# VESTRADA | HEIGHT ADJUSTABLE DESK WORKSURFACES

Description	Model	Cherry		W	D	H	KW	Shipping Weight	Cubic Feet
		Maple	Walnut						
		Rift Oak	Anigre						
Electronic Height Adjustable Desk	81HA4824ETS	3638	3818	47.75	24	-	35	109.5	19
 Worksurfaces T-Base	81HA5424ETS	3685	3870	53.5	24	-	41	110	21.5
	81HA6024ETS	3786	3975	59.75	24	-	47	111	24
	81HA6624ETS	4053	4258	65.75	24	-	53	114	26.5
	81HA7224ETS	4245	4458	71.75	24	-	59	119.5	29
	81HA7824ETS	4387	4606	77.75	24	-	65	122.5	31.5
	81HA8424ETS	4470	4696	83.75	24	-	71	127	34
	81HA4830ETS	3788	3978	47.75	30	-	35	122.5	20.5
	81HA5430ETS	3861	4055	53.5	30	-	41	123	23.5
	81HA6030ETS*	3948	4145	59.75	30	-	47	124	26.5
	81HA6630ETS	4142	4352	65.75	30	-	53	131	29.75
	81HA7230ETS	4329	4545	71.75	30	-	59	132.5	32.75
	81HA7830ETS	4481	4705	77.75	30	-	65	142.5	35.75
	81HA8430ETS	4567	4797	83.75	30	-	71	143.5	38.75
	81HA4836ETS	4005	4205	47.75	36	-	35	122.5	20.75
	81HA5436ETS	4086	4291	53.5	36	-	41	123	24.5
81HA6036ETS	4164	4372	59.75	36	-	47	124	28.25	
81HA6636ETS	4327	4543	65.75	36	-	53	134	32	
81HA7236ETS	4469	4693	71.75	36	-	59	151.5	35.5	
81HA7836ETS	4822	5063	77.75	36	-	65	158.5	39.25	
81HA8436ETS	4927	5172	83.75	36	-	71	159.5	43	

**ORDERING NOTES:**

To order a height adjustable return worksurface to use in place of a return or linking unit insert RH into the model number before the ETS.

To order a height adjustable worksurface with a top overhang of 16" at one end insert O16 into the model number after ETS. Please note that this option is not available on height adjustable work surfaces that have base enclosures and are 48" or less in length. This option is not available on dual stage electronic height adjustable worksurfaces.

To order a dual stage height adjustable base add \$674 to the list price and replace ETS with ETD. Lifts come standard with an up/down button. Standard colors are Silver Metallic & Black, please contact customer service for other available colors. A 4 position programmable display is available, please see page 202 for price and model number.

Modesty panels are available in low pressure laminate, please replace V21 with V26 for this option. Modesty panels are also available in palette, please replace V21 with V22 for this option.

Single stage height adjustable range: 26" - 45.5"

Dual stage height adjustable range: 21" - 47"

Power cord is 10 feet long.

**DIMENSION KEY**

- W — width
- D — depth
- H — height of worksurface
- KW— kneehole width

Dimensions are in inches and approximate. Contact Customer Service if dimensions are critical.

**CODE DESCRIPTION**

- E - electric
- T - T-base
- S - single stage
- O16 - 16" overhang
- C - C-base
- D - dual stage

**STANDARD FINISHES**

For a complete list of standard wood finishes please see page 114.

# VESTRADA | HEIGHT ADJUSTABLE DESK WORKSURFACES

Description	Model	Cherry		W	D	H	KW	Shipping Weight	Cubic Feet
		Maple	Walnut						
		Rift Oak	Anigre						
Electronic Height Adjustable Desk	81HA4824ETSG	5993	6292	47.75	24	-	30	154.5	19
	81HA5424ETSG	6045	6347	53.5	24	-	36	155	21.5
	81HA6024ETSG	6144	6452	59.75	24	-	42	156	24
	81HA6624ETSG	6422	6745	65.75	24	-	48	159	26.5
	81HA7224ETSG	6620	6951	71.75	24	-	54	164.5	29
	81HA7824ETSG	6764	7104	77.75	24	-	60	167.5	31.5
	81HA8424ETSG	6854	7197	83.75	24	-	66	172	34
	81HA4830ETSG	6419	6739	47.75	30	-	30	177.5	20.5
	81HA5430ETSG	6490	6816	53.5	30	-	36	178	23.5
	81HA6030ETSG	6579	6909	59.75	30	-	42	179	26.5
	81HA6630ETSG	6783	7123	65.75	30	-	48	186	29.75
	81HA7230ETSG	6973	7320	71.75	30	-	54	187.5	32.75
	81HA7830ETSG	7127	7483	77.75	30	-	60	197.5	35.75
	81HA8430ETSG	7480	7854	83.75	30	-	66	198.5	38.75
	81HA4836ETSG	6897	7242	47.75	36	-	30	187.5	20.75
	81HA5436ETSG	6982	7331	53.5	36	-	36	188	24.5
	81HA6036ETSG	7063	7416	59.75	36	-	42	189	28.25
	81HA6636ETSG	7230	7592	65.75	36	-	48	199	32
	81HA7236ETSG	7117	7476	71.75	36	-	54	216.5	35.5
81HA7836ETSG	7740	8125	77.75	36	-	60	223.5	39.25	
81HA8436ETSG	7846	8238	83.75	36	-	66	224.5	43	

**ORDERING NOTES:**

To order a height adjustable return worksurface to use in place of a return or linking unit insert RH into the model number before the ETS.

To order a height adjustable worksurface with a top overhang of 16" at one end insert O16 into the model number after ETS. Please note that this option is not available on height adjustable work surfaces that have base enclosures and are 48" or less in length. This option is not available on dual stage electronic height adjustable worksurfaces.

To order a dual stage height adjustable base add **\$674 to the list price** and replace ETS with ETD. Lifts come standard with an up/down button. Standard colors are Silver Metallic & Black, please contact customer service for other available colors. A 4 position programmable display is available, please see page 202 for price and model number.

Modesty panels are available in low pressure laminate, please replace V21 with V26 for this option. Modesty panels are also available in palette, please replace V21 with V22 for this option.

Single stage height adjustable range: 26" - 45.5"  
 Dual stage height adjustable range: 21" - 47"  
 Power cord is 10 feet long.

**ORDERING PROCEDURE**

- To order, please specify the following:
- 1) Krug product model number
  - 2) Wood species and finish
  - 3) Grommet location and style if applicable.
  - 4) Base option if applicable.
  - 5) Modesty Panel option if applicable.

\* Indicates model illustrated by the drawing.

**CODE DESCRIPTION**

- E - electric
- T - T-base
- S - single stage
- G - base enclosure
- O16 - 16" overhang
- C - C-base
- D - dual stage

**STANDARD FINISHES**

For a complete list of standard wood finishes, please see page 114.

# VESTRADA | HEIGHT ADJUSTABLE RETURN WORKSURFACES

Description	Model	Cherry Maple Walnut		W	D	H	KW	Shipping Weight	Cubic Feet
		Rift Oak	Anigre						
Electronic Height	81HA4824RHETS	3638	3818	47.75	24	-	35	109.5	19
Adjustable Return	81HA5424RHETS	3685	3870	53.5	24	-	41	110	21.5
Worksurfaces T-Base	81HA6024RHETS	3786	3975	59.75	24	-	47	111	24
	81HA6624RHETS	4053	4258	65.75	24	-	53	114	26.5
	81HA7224RHETS	4245	4458	71.75	24	-	59	119.5	29
	81HA7824RHETS	4387	4606	77.75	24	-	65	122.5	31.5
	81HA8424RHETS	4470	4696	83.75	24	-	71	127	34
	81HA4830RHETS	3788	3978	47.75	30	-	35	122.5	20.5
	81HA5430RHETS	3861	4055	53.5	30	-	41	123	23.5
	81HA6030RHETS*	3948	4145	59.75	30	-	47	124	26.5
	81HA6630RHETS	4142	4352	65.75	30	-	53	131	29.75
	81HA7230RHETS	4329	4545	71.75	30	-	59	132.5	32.75
	81HA7830RHETS	4481	4705	77.75	30	-	65	142.5	35.75
	81HA8430RHETS	4567	4797	83.75	30	-	71	143.5	38.75
81HA4836RHETS	4005	4205	47.75	36	-	35	122.5	20.75	
81HA5436RHETS	4086	4291	53.5	36	-	41	123	24.5	
81HA6036RHETS	4164	4372	59.75	36	-	47	124	28.25	
81HA6636RHETS	4327	4543	65.75	36	-	53	134	32	
81HA7236RHETS	4469	4693	71.75	36	-	59	151.5	35.5	
81HA7836RHETS	4822	5063	77.75	36	-	65	158.5	39.25	
81HA8436RHETS	4927	5172	83.75	36	-	71	159.5	43	

**ORDERING NOTES:**

To order a height adjustable return work surface to use in place of a return or linking unit insert RH into the model number before the ETS.

To order a height adjustable work surface with a top overhang of 16" at one end insert O16 into the model number after ETS. Please note that this option is not available on height adjustable work surfaces that have base enclosures and are 48" or less in length. This option is not available on dual stage electronic height adjustable work surfaces.

To order a dual stage height adjustable base add **\$674 to the list price** and replace ETS with ETD. Lifts come standard with an up/down button. Standard colors are Silver Metallic & Black, please contact customer service for other available colors. A 4 position programmable display is available, please see page 202 for price and model number.

Modesty panels are available in low pressure laminate, please replace V21 with V26 for this option. Modesty panels are also available in palette, please replace V21 with V22 for this option.

Single stage height adjustable range: 26" - 45.5"

Dual stage height adjustable range: 21" - 47"

Power cord is 10 feet long.

**DIMENSION KEY**

W — width  
D — depth  
H — height of work surface  
KW— kneehole width

Dimensions are in inches and approximate.  
Contact Customer Service if dimensions are critical.

**CODE DESCRIPTION**

RH - return (cross grain)  
E - electric  
T- T-base  
S- single stage  
O16 - 16" overhang  
C - C-base  
D - dual stage

**STANDARD FINISHES**

For a complete list of standard wood finishes, please see page 114.

# VESTRADA | HEIGHT ADJUSTABLE RETURN WORKSURFACES

Description	Model	Wood Species			W	D	H	KW	Shipping Weight	Cubic Feet
		Cherry	Maple	Walnut						
Electronic Height Adjustable Return	81HA4824RHETSG	5993	6292		47.75	24	-	30	154.5	19
	81HA5424RHETSG	6045	6347		53.5	24	-	36	155	21.5
	81HA6024RHETSG	6144	6452		59.75	24	-	42	156	24
	81HA6624RHETSG	6422	6745		65.75	24	-	48	159	26.5
	81HA7224RHETSG	6620	6951		71.75	24	-	54	164.5	29
	81HA7824RHETSG	6764	7104		77.75	24	-	60	167.5	31.5
	81HA8424RHETSG	6854	7197		83.75	24	-	66	172	34
	81HA4830RHETSG	6419	6739		47.75	30	-	30	177.5	20.5
	81HA5430RHETSG	6490	6816		53.5	30	-	36	178	23.5
	81HA6030RHETSG	6579	6909		59.75	30	-	42	179	26.5
	81HA6630RHETSG	6783	7123		65.75	30	-	48	186	29.75
	81HA7230RHETSG	6973	7320		71.75	30	-	54	187.5	32.75
	81HA7830RHETSG	7127	7483		77.75	30	-	60	197.5	35.75
	81HA8430RHETSG	7480	7854		83.75	30	-	66	198.5	38.75
	81HA4836RHETSG	6897	7242		47.75	36	-	30	187.5	20.75
	81HA5436RHETSG	6982	7331		53.5	36	-	36	188	24.5
	81HA6036RHETSG	7063	7416		59.75	36	-	42	189	28.25
	81HA6636RHETSG	7230	7592		65.75	36	-	48	199	32
	81HA7236RHETSG	7117	7476		71.75	36	-	54	216.5	35.5
81HA7836RHETSG	7740	8125		77.75	36	-	60	223.5	39.25	
81HA8436RHETSG	7846	8238		83.75	36	-	66	224.5	43	

**ORDERING NOTES:**

To order a height adjustable return work surface to use in place of a return or linking unit insert RH into the model number before the ETS.

To order a height adjustable work surface with a top overhang of 16" at one end insert O16 into the model number after ETS. Please note that this option is not available on height adjustable work surfaces that have base enclosures and are 48" or less in length. This option is not available on dual stage electronic height adjustable work surfaces.

To order a dual stage height adjustable base add **\$674 to the list price** and replace ETS with ETD. Lifts come standard with an up/down button. Standard colors are Silver Metallic & Black, please contact customer service for other available colors. A 4 position programmable display is available, please see page 202 for price and model number.

Modesty panels are available in low pressure laminate, please replace V21 with V26 for this option. Modesty panels are also available in palette, please replace V21 with V22 for this option.

Single stage height adjustable range: 26" - 45.5"

Dual stage height adjustable range: 21" - 47"

Power cord is 10 feet long.

**ORDERING PROCEDURE**

- To order, please specify the following:
- 1) Krug product model number
  - 2) Wood species and finish
  - 3) Grommet location and style if applicable.
  - 4) Base option if applicable.
  - 5) Modesty Panel option if applicable.

\* Indicates model illustrated by the drawing.





**CODE DESCRIPTION**

- HA - height adjustable
- RH - return (cross grain)
- E - electric
- T - T- base
- C - C- base
- S - single stage
- D - dual stage

**STANDARD FINISHES**

For a complete list of standard wood finishes, please see page 114.

## VESTRADA | MODESTY PANELS FOR HEIGHT ADJUSTABLE WORKSURFACES WITH BASE ENCLOSURES

Description	Model	Cherry		W	D	H	Shipping Weight
		Maple Walnut Rift Oak	Anigre				
 1/2 Height Floating Wood Modesty	V21-48	338	358	47.75	0.75	12	9
	V21-54	350	366	53.75	0.75	12	10
	V21-60	361	378	59.75	0.75	12	11
	V21-66	371	390	65.75	0.75	12	12
	V21-72	383	403	71.75	0.75	12	14
	V21-78	405	426	77.75	0.75	12	15
	V21-84	452	473	83.75	0.75	12	16
 1/2 Height Floating Palette Modesty	V22-48	338		47.75	0.75	12	9
	V22-54	350		53.75	0.75	12	10
	V22-60	361		59.75	0.75	12	11
	V22-66	371		65.75	0.75	12	12
	V22-72	383		71.75	0.75	12	14
	V22-78	405		77.75	0.75	12	15
	V22-84	452		83.75	0.75	12	16
 1/2 Height Floating Back-painted Glass Modesty	V24-48	1082		47.75	0.75	12	13
	V24-54	1116		53.75	0.75	12	14
	V24-60	1149		59.75	0.75	12	15
	V24-66	1185		65.75	0.75	12	16
	V24-72	1222		71.75	0.75	12	18
	V24-78	1273		77.75	0.75	12	19
	V24-84	1328		83.75	0.75	12	20
 1/2 Height Floating Acrylic Modesty	V29-48	640		47.75	0.75	12	7
	V29-54	659		53.75	0.75	12	8
	V29-60	680		59.75	0.75	12	9
	V29-66	702		65.75	0.75	12	10
	V29-72	721		71.75	0.75	12	12
	V29-78	759		77.75	0.75	12	13
	V29-84	793		83.75	0.75	12	14
 Full Height Fixed Wood Modesty	X41-48	677	711	47.75	0.75	12	15
	X41-54	697	733	53.75	0.75	12	18
	X41-60	719	756	59.75	0.75	29	20
	X41-66	741	780	65.75	0.75	29	24
	X41-72	765	804	71.75	0.75	29	26
	X41-78	809	849	77.75	0.75	29	30
	X41-84	905	952	83.75	0.75	29	36

**DIMENSION KEY**

W – width  
 D – depth  
 H – height of worksurface  
 KW – kneehole width

Dimensions are in inches and approximate.  
 Contact Customer Service if dimensions are critical.

**CODE DESCRIPTION**

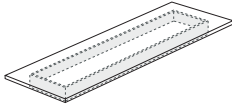
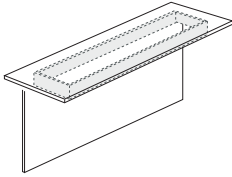
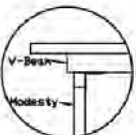

V21 - 1/2 height floating wood modesty  
 V22 - 1/2 height floating palette modesty  
 V24 - 1/2 height floating back-painted glass modesty  
 V29 - 1/2 height floating acrylic modesty  
 X41 - full height fixed wood modesty

# VESTRADA | LINKING UNITS

Description	Model	Cherry		W	D	H	KW	Shipping Weight	Cubic Feet
		Maple	Walnut						
		Rift Oak	Anigre						
	81LU3620H	882	1014	36	20	29.25		34	14
	81LU3624H	890	1026	36	24	29.25		48	17
	81LU4020H	915	1054	40	20	29.25		42	17
	81LU4024H	942	1086	40	24	29.25		60	21
	81LU4820H	962	1109	48	20	29.25		58	21
	81LU4824H	985	1135	48	24	29.25		77	24
	81LU5620H	990	1140	56	20	29.25		70	24
	81LU5624H	1003	1153	56	24	29.25		85	28
	81LU6420H	1054	1210	64	20	29.25		93	27
	81LU6424H*	1084	1245	64	24	29.25		118	32
	81LU7220H	1087	1247	72	20	29.25		128	30
	81LU7224H	1102	1268	72	24	29.25		140	36
 	81LU3620HX41	1777	2043	36	20	29.25		54	14
	81LU3624HX41	1834	2108	36	24	29.25		68	17
	81LU4020HX41	1871	2149	40	20	29.25		60	17
	81LU4024HX41	1921	2210	40	24	29.25		80	21
	81LU4820HX41	1959	2253	48	20	29.25		78	21
	81LU4824HX41	1995	2295	48	24	29.25		97	24
	81LU5620HX41	2020	2323	56	20	29.25		95	24
	81LU5624HX41*	2045	2353	56	24	29.25		116	28
	81LU6420HX41	2132	2451	64	20	29.25		105	27
	81LU6424HX41	2238	2571	64	24	29.25		128	32
	81LU7220HX41	2287	2632	72	20	29.25		140	30
	81LU7224HX41	2376	2734	72	24	29.25		148	36

**ORDERING NOTES:**

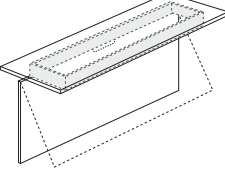
For cut-out option on modesty panel, note clearly on Purchase Order and **add \$194 list**. Modesty panels are inset from the underside of the V-Beam, as illustrated.

 	81LUY3620HX41	1956	2250	36	20	29.25		54	14
	81LUY3624HX41	2017	2319	36	24	29.25		68	17
	81LUY4020HX41	2060	2368	40	20	29.25		60	17
	81LUY4024HX41	2112	2429	40	24	29.25		80	21
	81LUY4820HX41	2157	2480	48	20	29.25		78	21
	81LUY4824HX41	2194	2524	48	24	29.25		97	24
	81LUY5620HX41	2221	2555	56	20	29.25		95	24
	81LUY5624HX41*	2250	2587	56	24	29.25		116	28
	81LUY6420HX41	2343	2695	64	20	29.25		105	27
	81LUY6424HX41	2461	2829	64	24	29.25		128	32
	81LUY7220HX41	2517	2894	72	20	29.25		140	30
	81LUY7224HX41	2612	3004	72	24	29.25		148	36

**ORDERING NOTES:**

Wire management cut out is standard on hinged modesty panels. Modesty panels are inset from the underside of the V-Beam, as illustrated.

**DIMENSION KEY**

W - width  
D - depth  
H - height

**CODE DESCRIPTION**

L - left hand pedestal position  
R - right hand pedestal position  
D - 2 file drawer  
F - 2 box, 1 file drawer  
V - floating modesty panel  
W - extended pedestal  
E2 - wood elliptical base  
X31 - 3/4 height recessed modesty panel  
X41 - full height recessed modesty panel

**STANDARD FINISHES**

For a complete list of standard wood finishes please see page 114.

**LINKING UNITS**

Linking units are to be used in open plans. They are to be installed against a wall.

**LAMINATE WORKSURFACES**

Laminate worksurfaces are available at a 10% upcharge, see page 118 for more information.

# VESTRADA | LINKING UNITS

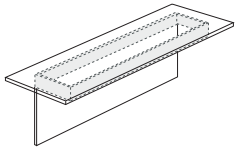
Description	Model	Cherry Maple Walnut		W	D	H	Shipping Weight	Cubic Feet
		Rift Oak	Anigre					
Linking Top, 3/4	81LUV3620HX31	1956	2250	36	20	29.25	54	14
Floating Wood	81LUV3624HX31	2017	2319	36	24	29.25	68	17
Modesty Panel 	81LUV4020HX31	2060	2368	40	20	29.25	66	17
	81LUV4024HX31	2112	2429	40	24	29.25	82	21
	81LUV4820HX31	2157	2480	48	20	29.25	78	21
	81LUV4824HX31	2194	2524	48	24	29.25	97	24
	81LUV5620HX31	2221	2555	56	20	29.25	92	24
	81LUV5624HX31	2250	2587	56	24	29.25	113	28
	81LUV6420HX31	2343	2695	64	20	29.25	100	27
	81LUV6424HX31	2461	2829	64	24	29.25	123	32
	81LUV7220HX31*	2517	2894	72	20	29.25	137	30
	81LUV7224HX31	2612	3004	72	24	29.25	148	36

**ORDERING NOTES:**

Modesty panels are inset from the underside of the V-Beam, as illustrated.

**ORDERING PROCEDURE**

To order, please specify the following:  
 1) Krug product model number  
 2) Wood species and finish

**CODE DESCRIPTION**

L - left hand pedestal position  
 R - right hand pedestal position  
 D - 2 file drawer  
 F - 2 box, 1 file drawer  
 H - desk height worksurface  
 V - floating modesty panel  
 Y - hinged modesty panel  
 X31 - 3/4 height recessed modesty panel  
 X41 - full height recessed modesty panel

**STANDARD FINISHES**

For a complete list of standard wood finishes please see page 114.

**LINKING UNITS**

Linking units are to be used in open plans. They are to be installed against a wall.

**LAMINATE WORKSURFACES**

Laminate worksurfaces are available at a 10% upcharge, see page 118 for more information.

# VESTRADA | RETURNS

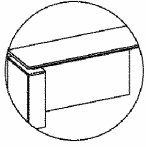
Description	Model	Cherry		W	D	H	KW	Shipping Weight	Cubic Feet
		Maple	Walnut						
		Rift Oak	Anigre						
Open Return	81RH3620L	1964	2257	36	20	29.25	28	88	16
	81RH3620R	1964	2257	36	20	29.25	28	88	16
	81RH3624L	2003	2304	36	24	29.25	28	103	19
	81RH3624R	2003	2304	36	24	29.25	28	103	19
	81RH4020L	2065	2377	40	20	29.25	32	101	17
	81RH4020R	2065	2377	40	20	29.25	32	101	17
	81RH4024L	2117	2434	40	24	29.25	32	118	21
	81RH4024R	2117	2434	40	24	29.25	32	118	21
	81RH4820L	2167	2492	48	20	29.25	40	113	21
	81RH4820R	2167	2492	48	20	29.25	40	113	21
	81RH4824L	2215	2549	48	24	29.25	40	133	24
	81RH4824R	2215	2549	48	24	29.25	40	133	24
	81RH5620L	2243	2581	56	20	29.25	48	127	24
	81RH5620R	2243	2581	56	20	29.25	48	127	24
	81RH5624L	2282	2625	56	24	29.25	48	147	28
	81RH5624R	2282	2625	56	24	29.25	48	147	28
	81RH6020L	2310	2658	60	20	29.25	52	138	25
	81RH6020R	2310	2658	60	20	29.25	52	138	25
	81RH6024L	2342	2694	60	24	29.25	52	163	30
	81RH6024R	2342	2694	60	24	29.25	52	163	30
	81RH6420L	2401	2761	64	20	29.25	56	143	27
	81RH6420R	2401	2761	64	20	29.25	56	143	27
	81RH6424L	2445	2812	64	24	29.25	56	168	32
	81RH6424R	2445	2812	64	24	29.25	56	168	32
	81RH6430L	2465	2837	64	20	29.25	56	206	39
	81RH6430R	2465	2837	64	20	29.25	56	206	39
	81RH6436L*	2527	2907	64	24	29.25	56	210	47
	81RH6436R	2527	2907	64	24	29.25	56	210	47
	81RH7220L	2491	2863	72	20	29.25	64	158	30
	81RH7220R	2491	2863	72	20	29.25	64	158	30
	81RH7224L	2535	2917	72	24	29.25	64	187	36
	81RH7224R	2535	2917	72	24	29.25	64	187	36
	81RH7230L	2554	2936	72	20	29.25	64	230	44
	81RH7230R	2554	2936	72	20	29.25	64	230	44
	81RH7236L	2601	2989	72	24	29.25	64	273	52
	81RH7236R	2601	2989	72	24	29.25	64	273	52
	81RH8020L	2580	2966	80	20	29.25	72	156	34
	81RH8020R	2580	2966	80	20	29.25	72	156	34
	81RH8024L	2607	2996	80	24	29.25	72	204	40
	81RH8024R	2607	2996	80	24	29.25	72	204	40
	81RH8030L	2631	3025	80	20	29.25	72	251	49
	81RH8030R	2631	3025	80	20	29.25	72	251	49
	81RH8036L	2650	3047	80	24	29.25	72	288	58
	81RH8036R	2650	3047	80	24	29.25	72	288	58
	81RH8820L	2634	3028	88	20	29.25	80	185	37
	81RH8820R	2634	3028	88	20	29.25	80	185	37
	81RH8824L	2654	3052	88	24	29.25	80	219	43
	81RH8824R	2654	3052	88	24	29.25	80	219	43
	81RH8830L	2697	3102	88	20	29.25	80	270	54
	81RH8830R	2697	3102	88	20	29.25	80	270	54
	81RH8836L	2739	3147	88	24	29.25	80	321	64
	81RH8836R	2739	3147	88	24	29.25	80	321	64

**DIMENSION KEY**

W - width  
D - depth  
H - height

**CODE DESCRIPTION**

L - left hand pedestal position  
R - right hand pedestal position  
D - 2 file drawer  
F - 2 box, 1 file drawer  
H - desk height worksurface  
01 - lateral file drawer  
05 - 4 box/ 1 lateral file  
X31 - 3/4 height recessed modesty panel  
X41 - full height recessed modesty panel

**WIRING GROMMETS**



One rectangular grommet in a standard position is optional at no charge. Additional rectangular grommets are available at an up-charge of **\$152 list**. See page 117 for PowerPort options.

**SUPPORT**

Any top with a V-Beam and a kneespace greater than 64" requires a half gable. Please see page 189.

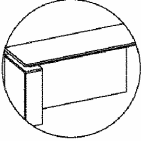

# VESTRADA | RETURNS

Description	Model	Cherry Maple Walnut		W	D	H	KW	Shipping Weight	Cubic Feet
		Rift Oak	Anigre						
Desk Height Return, 16" Pedestal	81RH3620L16D	3454	3970	36	20	29.25	20	105	16
	81RH3620L16F	3454	3970	36	20	29.25	20	105	16
	81RH3620R16D	3454	3970	36	20	29.25	20	105	16
	81RH3620R16F	3454	3970	36	20	29.25	20	105	16
	81RH3624L16D	3469	3988	36	24	29.25	20	120	19
	81RH3624L16F	3469	3988	36	24	29.25	20	120	19
	81RH3624R16D	3469	3988	36	24	29.25	20	120	19
	81RH3624R16F	3469	3988	36	24	29.25	20	120	19
	81RH4020L16D	3501	4027	40	20	29.25	24	118	17
	81RH4020L16F	3501	4027	40	20	29.25	24	118	17
	81RH4020R16D	3501	4027	40	20	29.25	24	118	17
	81RH4020R16F	3501	4027	40	20	29.25	24	118	17
	81RH4024L16D	3554	4086	40	24	29.25	24	135	21
	81RH4024L16F	3554	4086	40	24	29.25	24	135	21
	81RH4024R16D	3554	4086	40	24	29.25	24	135	21
	81RH4024R16F	3554	4086	40	24	29.25	24	135	21
	81RH4820L16D	3582	4119	48	20	29.25	32	130	21
	81RH4820L16F	3582	4119	48	20	29.25	32	130	21
	81RH4820R16D	3582	4119	48	20	29.25	32	130	21
	81RH4820R16F	3582	4119	48	20	29.25	32	130	21
	81RH4824L16D*	3599	4139	48	24	29.25	32	150	24
	81RH4824L16F**	3599	4139	48	24	29.25	32	150	24
	81RH4824R16D	3599	4139	48	24	29.25	32	150	24
	81RH4824R16F	3599	4139	48	24	29.25	32	150	24
	81RH5620L16D	3631	4176	56	20	29.25	40	155	24
	81RH5620L16F	3631	4176	56	20	29.25	40	155	24
	81RH5620R16D	3631	4176	56	20	29.25	40	155	24
	81RH5620R16F	3631	4176	56	20	29.25	40	155	24

**ORDERING NOTES:**

Listed pricing does not include a modesty panel. To add a full height wood modesty panel add (X41) to the end of the model number, e.g. 81RH7220LX41. To add 3/4 wood modesty panel add (X31) to the end of the model number. Add 7% list for a full 3/4 or full height modesty panel. **Add \$194 list upcharge** for wire management cut-out option and state clearly on Purchase Order. For details on pull locations please see page 116.

**ORDERING PROCEDURE**

To order, please specify the following:  
 1) Krug product model number  
 2) Wood species and finish

**CODE DESCRIPTION**

L - left hand pedestal position  
 R - right hand pedestal position  
 D - 2 file drawer  
 F - 2 box, 1 file drawer  
 H - desk height worksurface  
 01 - lateral file drawer  
 05 - 4 box/ 1 lateral file  
 X31 - 3/4 height recessed modesty panel  
 X41 - full height recessed modesty panel



**STANDARD FINISHES**

For a complete list of standard wood finishes please see page 114.

**SUPPORT**

Any top with a V-Beam and a kneespace greater than 64" requires a half gable. Please see page 189.

**VESTRADA | RETURNS**

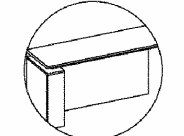
Description	Model	Cherry		Anigre	W	D	H	KW	Shipping Weight	Cubic Feet
		Maple	Walnut							
Desk Height Return, 16" Pedestal, Continued	81RH5624L16D	3671	4222		56	24	29.25	40	180	28
	81RH5624L16F	3671	4222		56	24	29.25	40	180	28
	81RH5624R16D	3671	4222		56	24	29.25	40	180	28
	81RH5624R16F	3671	4222		56	24	29.25	40	180	28
	81RH6420L16D	3698	4251		64	20	29.25	48	162	27
	81RH6420L16F	3698	4251		64	20	29.25	48	162	27
	81RH6420R16D	3698	4251		64	20	29.25	48	162	27
	81RH6420R16F	3698	4251		64	20	29.25	48	162	27
	81RH6424L16D*	3804	4375		64	24	29.25	48	182	32
	81RH6424L16F**	3804	4375		64	24	29.25	48	182	32
	81RH6424R16D	3804	4375		64	24	29.25	48	182	32
	81RH6424R16F	3804	4375		64	24	29.25	48	182	32
	81RH6430L16D	3929	4515		64	30	29.25	48	243	39
	81RH6430L16F	3929	4515		64	30	29.25	48	243	39
	81RH6430R16D	3929	4515		64	30	29.25	48	243	39
	81RH6430R16F	3929	4515		64	30	29.25	48	243	39
	81RH6436L16D	4060	4667		64	36	29.25	48	257	47
	81RH6436L16F	4060	4667		64	36	29.25	48	257	47
	81RH6436R16D	4060	4667		64	36	29.25	48	257	47
	81RH6436R16F	4060	4667		64	36	29.25	48	257	47
	81RH7220L16D	4011	4614		72	20	29.25	56	176	30
	81RH7220L16F	4011	4614		72	20	29.25	56	176	30
	81RH7220R16D	4011	4614		72	20	29.25	56	176	30
	81RH7220R16F	4011	4614		72	20	29.25	56	176	30
	81RH7224L16D	4134	4756		72	24	29.25	56	205	36
	81RH7224L16F	4134	4756		72	24	29.25	56	205	36
	81RH7224R16D	4134	4756		72	24	29.25	56	205	36
	81RH7224R16F	4134	4756		72	24	29.25	56	205	36
	81RH7224R16D	4134	4756		72	24	29.25	56	205	36
	81RH7224R16F	4134	4756		72	24	29.25	56	205	36
	81RH7230L16D	4219	4853		72	30	29.25	56	273	44
	81RH7230L16F	4219	4853		72	30	29.25	56	273	44
	81RH7230R16D	4219	4853		72	30	29.25	56	273	44
	81RH7230R16F	4219	4853		72	30	29.25	56	273	44
	81RH7236L16D	4279	4920		72	36	29.25	56	316	52
	81RH7236L16F	4279	4920		72	36	29.25	56	316	52
	81RH7236R16D	4279	4920		72	36	29.25	56	316	52
	81RH7236R16F	4279	4920		72	36	29.25	56	316	52

**ORDERING NOTES:**

Listed pricing does not include a modesty panel. To add a full height wood modesty panel add (X41 to the end of the model number, e.g. 81RH7220LX41. To add 3/4 wood modesty panel add (X31) to the end of the model number. Add 7% list for a full 3/4 or full height modesty panel. **Add \$194 list upcharge** for wire management cut-out option and state clearly on Purchase Order. For details on pull locations please see page 116.

**DIMENSION KEY**

W - width  
D - depth  
H - height

**CODE DESCRIPTION**

L - left hand pedestal position  
R - right hand pedestal position  
D - 2 file drawer  
F - 2 box, 1 file drawer  
H - desk height worksurface  
01 - lateral file drawer  
05 - 4 box/ 1 lateral file  
X31 - 3/4 height recessed modesty panel  
X41 - full height recessed modesty panel



**WIRING GROMMETS**

One rectangular grommet in a standard position is optional at no charge. Additional rectangular grommets are available at an upcharge of **\$152 list**. See page 117 for PowerPort options.

**SUPPORT**

Any top with a V-Beam and a kneespace greater than 64" requires a half gable. Please see page 189.

# VESTRADA | RETURNS

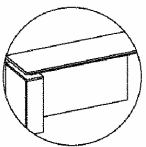
Description	Model	Cherry Maple Walnut		W	D	H	KW	Shipping Weight	Cubic Feet
		Rift Oak	Anigre						
Desk Height Return, 16" Pedestal, Continued	81RH8020L16D	4243	4879	80	20	29.25	64	175	34
	81RH8020L16F	4243	4879	80	20	29.25	64	175	34
	81RH8020R16D	4243	4879	80	20	29.25	64	175	34
	81RH8020R16F	4243	4879	80	20	29.25	64	175	34
	81RH8024L16D*	4311	4956	80	24	29.25	64	223	40
	81RH8024L16F**	4311	4956	80	24	29.25	64	223	40
	81RH8024R16D	4311	4956	80	24	29.25	64	223	40
	81RH8024R16F	4311	4956	80	24	29.25	64	223	40
	81RH8030L16D	4352	5006	80	30	29.25	64	295	49
	81RH8030L16F	4352	5006	80	30	29.25	64	295	49
	81RH8030R16D	4352	5006	80	30	29.25	64	295	49
	81RH8030R16F	4352	5006	80	30	29.25	64	295	49
	81RH8036L16D	4421	5083	80	30	29.25	64	342	58
	81RH8036L16F	4421	5083	80	36	29.25	64	342	58
	81RH8036R16D	4421	5083	80	36	29.25	64	342	58
	81RH8036R16F	4421	5083	80	36	29.25	64	342	58
	81RH8820L16D	4368	5023	88	20	29.25	72	200	37
	81RH8820L16F	4368	5023	88	20	29.25	72	200	37
	81RH8820R16D	4368	5023	88	20	29.25	72	200	37
	81RH8820R16F	4368	5023	88	20	29.25	72	200	37
	81RH8824L16D	4439	5106	88	24	29.25	72	234	43
	81RH8824L16F	4439	5106	88	24	29.25	72	234	43
	81RH8824R16D	4439	5106	88	24	29.25	72	234	43
	81RH8824R16F	4439	5106	88	24	29.25	72	234	43
	81RH8830L16D	4480	5150	88	30	29.25	72	310	54
	81RH8830L16F	4480	5150	88	30	29.25	72	310	54
	81RH8830R16D	4480	5150	88	30	29.25	72	310	54
	81RH8830R16F	4480	5150	88	30	29.25	72	310	54
	81RH8836L16D	4542	5223	88	36	29.25	72	361	64
	81RH8836L16F	4542	5223	88	36	29.25	72	361	64
	81RH8836R16D	4542	5223	88	36	29.25	72	361	64
	81RH8836R16F	4542	5223	88	36	29.25	72	361	64

**ORDERING NOTES:**

Listed pricing does not include a modesty panel. To add a full height wood modesty panel add (X41 to the end of the model number, e.g. 81RH7220LX41. To add 3/4 wood modesty panel add (X31) to the end of the model number. Add 7% list for a full 3/4 or full height modesty panel. Add **\$194 list** upcharge for wire management cut-out option and state clearly on Purchase Order. For details on pull locations please see page 116.

**ORDERING PROCEDURE**

To order, please specify the following:  
 1) Krug product model number  
 2) Wood species and finish

**CODE DESCRIPTION**

L - left hand pedestal position  
 R - right hand pedestal position  
 D - 2 file drawer  
 F - 2 box, 1 file drawer  
 H - desk height worksurface  
 01 - lateral file drawer  
 05 - 4 box/ 1 lateral file  
 X31 - 3/4 height recessed modesty panel  
 X41 - full height recessed modesty panel

**STANDARD FINISHES**

For a complete list of standard wood finishes please see page 114.

**WIRING GROMMETS**

One rectangular grommet in a standard position is optional at no charge. Additional rectangular grommets are available at an upcharge of **\$152 list**. See page 117 for PowerPort options.

**SUPPORT**

Any top with a V-Beam and a kneespace greater than 64" requires a half gable. Please see page 189.

**VESTRADA | RETURNS**

Description	Model	Cherry Maple Walnut		W	D	H	KW	Shipping Weight	Cubic Feet
		Rift Oak	Anigre						
	81RH4820L24D	3691	4245	48	20	29.25	24	155	21
	81RH4820L24F	3691	4245	48	20	29.25	24	155	21
	81RH4820R24D	3691	4245	48	20	29.25	24	155	21
	81RH4820R24F	3691	4245	48	20	29.25	24	155	21
	81RH4824L24D	3707	4260	48	24	29.25	24	175	24
	81RH4824L24F	3707	4260	48	24	29.25	24	175	24
	81RH4824R24D	3707	4260	48	24	29.25	24	175	24
	81RH4824R24F	3707	4260	48	24	29.25	24	175	24
	81RH5620L24D	3738	4295	56	20	29.25	32	165	24
	81RH5620L24F	3738	4295	56	20	29.25	32	165	24
	81RH5620R24D	3738	4295	56	20	29.25	32	165	24
	81RH5620R24F*	3738	4295	56	20	29.25	32	165	24
	81RH5624L24D	3784	4350	56	24	29.25	32	185	28
	81RH5624L24F	3784	4350	56	24	29.25	32	185	28
	81RH5624R24D	3784	4350	56	24	29.25	32	185	28
	81RH5624R24F	3784	4350	56	24	29.25	32	185	28
	81RH6420L24D	3811	4381	64	20	29.25	40	186	27
	81RH6420L24F	3811	4381	64	20	29.25	40	186	27
	81RH6420R24D	3811	4381	64	20	29.25	40	186	27
	81RH6420R24F	3811	4381	64	20	29.25	40	186	27
	81RH6424L24D	3918	4505	64	24	29.25	40	211	32
	81RH6424L24F	3918	4505	64	24	29.25	40	211	32
	81RH6424R24D	3918	4505	64	24	29.25	40	211	32
	81RH6424R24F	3918	4505	64	24	29.25	40	211	32
	81RH6430L24D	4042	4649	64	30	29.25	40	274	39
	81RH6430L24F	4042	4649	64	30	29.25	40	274	39
	81RH6430R24D	4042	4649	64	30	29.25	40	274	39
	81RH6430R24F	4042	4649	64	30	29.25	40	274	39
	81RH6436L24D	4180	4809	64	36	29.25	40	280	47
	81RH6436L24F	4180	4809	64	36	29.25	40	280	47
81RH6436R24D	4180	4809	64	36	29.25	40	280	47	
81RH6436R24F	4180	4809	64	36	29.25	40	280	47	
81RH7220L24D	4131	4752	72	20	29.25	48	201	30	
81RH7220L24F	4131	4752	72	20	29.25	48	201	30	
81RH7220R24D	4131	4752	72	20	29.25	48	201	30	
81RH7220R24F	4131	4752	72	20	29.25	48	201	30	

**ORDERING NOTES:**

Listed pricing does not include a modesty panel. To add a full height wood modesty panel add (X41 to the end of the model number, e.g. 81RH7220LX41. To add 3/4 wood modesty panel add (X31) to the end of the model number. Add 7% list for a full 3/4 or full height modesty panel. Add **\$194 list** upcharge for wire management cut-out option and state clearly on Purchase Order. For details on pull locations please see page 116.

**DIMENSION KEY**

W - width  
D - depth  
H - height

**CODE DESCRIPTION**

L - left hand pedestal position  
R - right hand pedestal position  
D - 2 file drawer  
F - 2 box, 1 file drawer  
H - desk height worksurface  
01 - lateral file drawer  
05 - 4 box/ 1 lateral file  
X31 - 3/4 height recessed modesty panel  
X41 - full height recessed modesty panel

**WIRING GROMMETS**

One rectangular grommet in a standard position is optional at no charge. Additional rectangular grommets are available at an upcharge of **\$152 list**. See page 117 for PowerPort options.

**SUPPORT**

Any top with a V-Beam and a kneespace greater than 64" requires a half gable. Please see page 189.

# VESTRADA | RETURNS

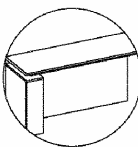
Description	Model	Cherry Maple Walnut		W	D	H	KW	Shipping Weight	Cubic Feet
		Rift Oak	Anigre						
Desk Height Return, 24"	81RH7224L24D	4227	4861	72	24	29.25	48	230	36
	81RH7224L24F	4227	4861	72	24	29.25	48	230	36
Pedestal, Continued	81RH7224R24D	4227	4861	72	24	29.25	48	230	36
	81RH7224R24F	4227	4861	72	24	29.25	48	230	36
	81RH7230L24D	4348	5000	72	30	29.25	48	298	44
	81RH7230L24F*	4348	5000	72	30	29.25	48	298	44
	81RH7230R24D	4348	5000	72	30	29.25	48	298	44
	81RH7230R24F	4348	5000	72	30	29.25	48	298	44
	81RH7236L24D	4406	5068	72	36	29.25	48	341	52
	81RH7236L24F	4406	5068	72	36	29.25	48	341	52
	81RH7236R24D	4406	5068	72	36	29.25	48	341	52
	81RH7236R24F	4406	5068	72	36	29.25	56	341	52
	81RH8020L24D	4370	5027	80	20	29.25	56	200	34
	81RH8020L24F	4370	5027	80	20	29.25	56	200	34
	81RH8020R24D	4370	5027	80	20	29.25	56	200	34
	81RH8020R24F	4370	5027	80	20	29.25	56	200	34
	81RH8024L24D	4439	5106	80	24	29.25	56	248	40
	81RH8024L24F	4439	5106	80	24	29.25	56	248	40
	81RH8024R24D	4439	5106	80	24	29.25	56	248	40
	81RH8024R24F	4439	5106	80	24	29.25	56	248	40
	81RH8030L24D	4481	5152	80	30	29.25	56	320	49
	81RH8030L24F	4481	5152	80	30	29.25	56	320	49
	81RH8030R24D	4481	5152	80	30	29.25	56	320	49
	81RH8030R24F	4481	5152	80	30	29.25	56	320	49
	81RH8036L24D	4553	5236	80	36	29.25	56	367	58
	81RH8036L24F	4553	5236	80	36	29.25	56	367	58
	81RH8036R24D	4553	5236	80	36	29.25	56	367	58
	81RH8036R24F	4553	5236	80	36	29.25	48	367	58
	81RH8820L24D	4498	5170	88	20	29.25	64	367	37
	81RH8820L24F	4498	5170	88	20	29.25	64	367	37
	81RH8820R24D	4498	5170	88	20	29.25	64	367	37
	81RH8820R24F	4498	5170	88	20	29.25	64	367	37
	81RH8824L24D	4573	5260	88	24	29.25	64	251	43
	81RH8824L24F	4573	5260	88	24	29.25	64	251	43
	81RH8824R24D	4573	5260	88	24	29.25	64	251	43
	81RH8824R24F	4573	5260	88	24	29.25	64	251	43

**ORDERING NOTES:**

Listed pricing does not include a modesty panel. To add a full height wood modesty panel add (X41 to the end of the model number, e.g. 81RH7220LX41. To add 3/4 wood modesty panel add (X31) to the end of the model number. Add 7% list for a full 3/4 or full height modesty panel. Add **\$194 list** upcharge for wire management cut-out option and state clearly on Purchase Order. For details on pull locations please see page 116.

**ORDERING PROCEDURE**

To order, please specify the following:  
 1) Krug product model number  
 2) Wood species and finish

**CODE DESCRIPTION**

L - left hand pedestal position  
 R - right hand pedestal position  
 D - 2 file drawer  
 F - 2 box, 1 file drawer  
 H - desk height worksurface  
 01 - lateral file drawer  
 05 - 4 box/ 1 lateral file  
 X31 - 3/4 height recessed modesty panel  
 X41 - full height recessed modesty panel

**STANDARD FINISHES**

For a complete list of standard wood finishes please see page 114.

**WIRING GROMMETS**

One rectangular grommet in a standard position is optional at no charge. Additional rectangular grommets are available at an upcharge of **\$152 list**. See page 117 for PowerPort options.

**SUPPORT**

Any top with a V-Beam and a kneespace greater than 64" requires a half gable. Please see page 189.

# VESTRADA | RETURNS

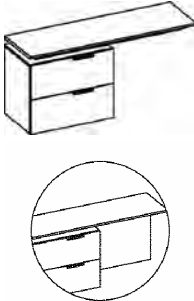
Description	Model	Cherry		W	D	H	KW	Shipping Weight	Cubic Feet
		Maple Walnut Rift Oak	Anigre						
	81RH5620L3201	4457	5124	56	20	29.25	24	172	24
	81RH5620R3201	4457	5124	56	20	29.25	24	172	24
	81RH5624L3201	4478	5149	56	24	29.25	24	192	28
	81RH5624R3201	4478	5149	56	24	29.25	24	192	28
	81RH6420L3201	4483	5154	64	20	29.25	32	193	27
	81RH6420R3201	4483	5154	64	20	29.25	32	193	27
	81RH6424L3201*	4509	5185	64	24	29.25	32	218	32
	81RH6424R3201	4509	5185	64	24	29.25	32	218	32
	81RH6430L3201	4530	5210	64	30	29.25	32	306	39
	81RH6430R3201	4530	5210	64	30	29.25	32	306	39
	81RH6436L3201	4570	5256	64	36	29.25	32	312	47
	81RH6436R3201	4570	5256	64	36	29.25	32	312	47
	81RH7220L3201	4537	5218	72	20	29.25	40	208	30
	81RH7220R3201	4537	5218	72	20	29.25	40	208	30
	81RH7224L3201	4574	5261	72	24	29.25	40	237	36
	81RH7224R3201	4574	5261	72	24	29.25	40	237	36
	81RH7230L3201	4609	5299	72	30	29.25	40	330	44
	81RH7230R3201	4609	5299	72	30	29.25	40	330	44
	81RH7236L3201	4649	5346	72	36	29.25	40	373	52
	81RH7236R3201	4649	5346	72	36	29.25	40	373	52
	81RH8020L3201	4611	5302	80	20	29.25	48	207	34
	81RH8020R3201	4611	5302	80	20	29.25	48	207	34
	81RH8024L3201	4641	5337	80	24	29.25	48	255	40
	81RH8024R3201	4641	5337	80	24	29.25	48	255	40
	81RH8030L3201	4686	5390	80	30	29.25	48	352	49
	81RH8030R3201	4686	5390	80	30	29.25	48	352	49
	81RH8036L3201	4732	5441	80	36	29.25	48	389	58
	81RH8036R3201	4732	5441	80	36	29.25	48	389	58
	81RH8820L3201	4649	5346	88	20	29.25	56	227	37
	81RH8820R3201	4649	5346	88	20	29.25	56	227	37
81RH8824L3201	4697	5399	88	24	29.25	56	258	43	
81RH8824R3201	4697	5399	88	24	29.25	56	258	43	
81RH8830L3201	4752	5465	88	30	29.25	56	356	54	
81RH8830R3201	4752	5465	88	30	29.25	56	356	54	
81RH8836L3201	4813	5532	88	36	29.25	56	403	64	
81RH8836R3201	4813	5532	88	36	29.25	56	403	64	

**ORDERING NOTES:**

Listed pricing does not include a modesty panel. To add a full height wood modesty panel add (X41 to the end of the model number, e.g. 81RH7220LX41. To add 3/4 wood modesty panel add (X31) to the end of the model number. Add 7% list for a full 3/4 or full height modesty panel. Add **\$194 list** upcharge for wire management cut-out option and state clearly on Purchase Order. For details on pull locations please see page 116.

**DIMENSION KEY**

W - width  
D - depth  
H - height

**CODE DESCRIPTION**

L - left hand pedestal position  
R - right hand pedestal position  
D - 2 file drawer  
F - 2 box, 1 file drawer  
H - desk height worksurface  
01 - lateral file drawer  
05 - 4 box/ 1 lateral file  
X31 - 3/4 height recessed modesty panel  
X41 - full height recessed modesty panel

**WIRING GROMMETS**

One rectangular grommet in a standard position is optional at no charge. Additional rectangular grommets are available at an upcharge of **\$152 list**. See page 117 for PowerPort options.

**SUPPORT**

Any top with a V-Beam and a kneespace greater than 64" requires a half gable. Please see page 189.

Description	Model	Cherry		W	D	H	KW	Shipping Weight	Cubic Feet
		Maple Walnut Rift Oak	Anigre						
Desk Height Return, 32" 4 Box/1 Lateral File Pedestal	81RH5620L3205	5082	5841	56	20	29.25	24	172	24
	81RH5620R3205	5082	5841	56	20	29.25	24	172	24
	81RH5624L3205	5108	5871	56	24	29.25	24	192	28
	81RH5624R3205	5108	5871	56	24	29.25	24	192	28
	81RH6420L3205	5111	5876	64	20	29.25	32	193	27
	81RH6420R3205	5111	5876	64	20	29.25	32	193	27
	81RH6424L3205	5139	5911	64	24	29.25	32	218	32
	81RH6424R3205	5139	5911	64	24	29.25	32	218	32
	81RH6430L3205	5161	5936	64	30	29.25	32	306	39
	81RH6430R3205	5161	5936	64	30	29.25	32	306	39
	81RH6436L3205	5210	5991	64	36	29.25	32	312	47
	81RH6436R3205	5210	5991	64	36	29.25	32	312	47
	81RH7220L3205	5173	5947	72	20	29.25	40	208	30
81RH7220R3205	5173	5947	72	20	29.25	40	208	30	
81RH7224L3205*	5215	5998	72	24	29.25	40	237	36	
81RH7224R3205	5215	5998	72	24	29.25	40	237	36	
81RH7230L3205	5254	6039	72	30	29.25	40	330	44	
81RH7230R3205	5254	6039	72	30	29.25	40	330	44	
81RH7236L3205	5300	6096	72	36	29.25	40	373	52	
81RH7236R3205	5300	6096	72	36	29.25	40	373	52	
81RH8020L3205	5258	6046	80	20	29.25	48	207	34	
81RH8020R3205	5258	6046	80	20	29.25	48	207	34	
81RH8024L3205	5292	6083	80	24	29.25	48	255	40	
81RH8024R3205	5292	6083	80	24	29.25	48	255	40	
81RH8030L3205	5340	6141	80	30	29.25	48	352	49	
81RH8030R3205	5340	6141	80	30	29.25	48	352	49	
81RH8036L3205	5393	6203	80	36	29.25	48	389	58	
81RH8036R3205	5393	6203	80	36	29.25	48	389	58	
81RH8820L3205	5300	6096	88	20	29.25	56	227	37	
81RH8820R3205	5300	6096	88	20	29.25	56	227	37	
81RH8824L3205	5359	6161	88	24	29.25	56	258	43	
81RH8824R3205	5359	6161	88	24	29.25	56	258	43	
81RH8830L3205	5418	6229	88	30	29.25	56	356	54	
81RH8830R3205	5418	6229	88	30	29.25	56	356	54	
81RH8836L3205	5482	6304	88	36	29.25	56	403	64	
81RH8836R3205	5482	6304	88	36	29.25	56	403	64	

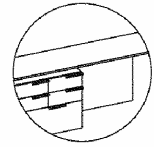

**ORDERING NOTES:**

Listed pricing does not include a modesty panel. To add a full height wood modesty panel add (X41 to the end of the model number, e.g. 81RH7220LX41. To add 3/4 wood modesty panel add (X31) to the end of the model number. Add 7% list for a full 3/4 or full height modesty panel. Add **\$194 list** upcharge for wire management cut-out option and state clearly on Purchase Order. For details on pull locations please see page 116.

**DIMENSION KEY**

W - width  
D - depth  
H - height

**CODE DESCRIPTION**

L - left hand pedestal position  
R - right hand pedestal position  
D - 2 file drawer  
F - 2 box, 1 file drawer  
H - desk height worksurface  
01 - lateral file drawer  
05 - 4 box/ 1 lateral file  
X31 - 3/4 height recessed modesty panel  
X41 - full height recessed modesty panel

**WIRING GROMMETS**

One rectangular grommet in a standard position is optional at no charge. Additional rectangular grommets are available at an upcharge of **\$152 list**. See page 117 for PowerPort options.

**SUPPORT**

Any top with a V-Beam and a kneespace greater than 64" requires a half gable. Please see page 189.

# VESTRADA | RETURNS

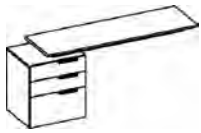
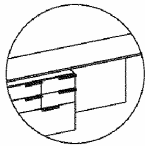
Description	Model	Cherry		W	D	H	KW	Shipping Weight	Cubic Feet
		Maple	Walnut						
		Rift Oak	Anigre						
Desk Height Return, 24" Extended Pedestal	81RH3620L24FW	4462	5134	36	20	29.25	20	135	16
	81RH3620R24FW	4462	5134	36	20	29.25	20	135	16
	81RH3624L24FW	4496	5169	36	24	29.25	20	145	19
	81RH3624R24FW	4496	5169	36	24	29.25	20	145	19
	81RH4820L24FW	4540	5220	48	20	29.25	32	155	21
	81RH4820R24FW	4540	5220	48	20	29.25	32	155	21
	81RH4824L24FW	4559	5242	48	24	29.25	32	175	25
	81RH4824R24FW	4559	5242	48	24	29.25	32	175	25
	81RH5620L24FW	4599	5287	56	20	29.25	40	165	24
	81RH5620R24FW	4599	5287	56	20	29.25	40	165	24
	81RH5624L24FW	4654	5352	56	24	29.25	40	185	28
	81RH5624R24FW	4654	5352	56	24	29.25	40	185	28
	81RH6420L24FW	4689	5391	64	20	29.25	48	211	27
	81RH6420R24FW	4689	5391	64	20	29.25	48	211	27
	81RH6424L24FW	4819	5544	64	24	29.25	48	274	32
	81RH6424R24FW	4819	5544	64	24	29.25	48	274	32
	81RH6430L24FW	4914	5647	64	30	29.25	48	280	40
	81RH6430R24FW	4914	5647	64	30	29.25	48	280	40
	81RH6436L24FW*	5122	5891	64	36	29.25	48	201	47
	81RH6436R24FW	5122	5891	64	36	29.25	48	201	47
	81RH7220L24FW	5083	5844	72	20	29.25	56	230	31
	81RH7220R24FW	5083	5844	72	20	29.25	56	230	31
	81RH7224L24FW	5257	6045	72	24	29.25	56	298	36
	81RH7224R24FW	5257	6045	72	24	29.25	56	298	36
	81RH7230L24FW	5327	6126	72	30	29.25	56	308	47
	81RH7230R24FW	5327	6126	72	30	29.25	56	308	47
	81RH7236L24FW	5419	6230	72	36	29.25	56	341	52
	81RH7236R24FW	5419	6230	72	36	29.25	56	341	52
	81RH8020L24FW	5380	6185	80	20	29.25	64	200	34
	81RH8020R24FW	5380	6185	80	20	29.25	64	200	34
	81RH8024L24FW	5463	6281	80	24	29.25	64	248	40
	81RH8024R24FW	5463	6281	80	24	29.25	64	248	40
	81RH8030L24FW	5510	6336	80	30	29.25	64	320	49
	81RH8030R24FW	5510	6336	80	30	29.25	64	320	49
	81RH8036L24FW	5587	6427	80	36	29.25	64	367	58
	81RH8036R24FW	5587	6427	80	36	29.25	64	367	58
	81RH8820L24FW	5534	6364	88	20	29.25	72	367	37
	81RH8820R24FW	5534	6364	88	20	29.25	72	367	37
	81RH8824L24FW	5629	6471	88	24	29.25	72	251	44
	81RH8824R24FW	5629	6471	88	24	29.25	72	251	44
	81RH8830L24FW	5691	6543	88	30	29.25	72	324	54
	81RH8830R24FW	5691	6543	88	30	29.25	72	324	54
	81RH8836L24FW	5742	6604	88	36	29.25	72	371	64
	81RH8836R24FW	5742	6604	88	36	29.25	72	371	64

**ORDERING PROCEDURE**

- To order, please specify the following:
- 1) Krug product model number
  - 2) Wood species and finish, see page 114
  - 3) Pull style and finish, see page 116
  - 4) V-Beam color, see page 117
  - 5) Grommet location and style if applicable

\* Indicates model illustrated by line drawing

**CODE DESCRIPTION**

- L - left hand pedestal position
- R - right hand pedestal position
- D - 2 file drawer
- F - 2 box, 1 file drawer
- H - desk height worksurface
- 01 - lateral file drawer
- 05 - 4 box/ 1 lateral file
- X31 - 3/4 height recessed modesty panel
- X41 - full height recessed modesty panel

**STANDARD FINISHES**

For a complete list of standard wood finishes please see page 114.

**SUPPORT**

Any top with a V-Beam and a kneespace greater than 64" requires a half gable. Please see page 189.

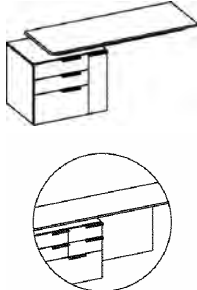

# VESTRADA | ANGLED SHAPED RETURNS

Description	Model	Cherry		W	D	H	KW	Shipping Weight	Cubic Feet
		Maple	Walnut						
		Rift Oak	Anigre						
	81RH3624L32FQW	5708	6565	36	24	29.25	12	136	19
	81RH3624R32FQW	5708	6565	36	24	29.25	12	136	19
	81RH4824L32FQW	5769	6638	48	24	29.25	24	166	24
	81RH4824R32FQW	5769	6638	48	24	29.25	24	166	24
	81RH5624L32FQW	5863	6742	56	24	29.25	32	182	28
	81RH5624R32FQW	5863	6742	56	24	29.25	32	182	28
	81RH6424L32FQW	5985	6882	64	24	29.25	40	203	32
	81RH6424R32FQW	5985	6882	64	24	29.25	40	203	32
	81RH7224L32FQW*	6185	7111	72	24	29.25	48	222	36
	81RH7224R32FQW	6185	7111	72	24	29.25	48	222	36
	81RH8024L32FQW	6318	7267	80	24	29.25	56	241	40
	81RH8024R32FQW	6318	7267	80	24	29.25	56	241	40
	81RH8824L32FQW	6474	7445	88	24	29.25	64	250	43
	81RH8824R32FQW	6474	7445	88	24	29.25	64	250	43

**ORDERING NOTES:**

Listed pricing does not include a modesty panel. To add a full height wood modesty panel add (X41 to the end of the model number, e.g. 81RH7220LX41. To add 3/4 wood modesty panel add (X31) to the end of the model number. Add 7% list for a full 3/4 or full height modesty panel. **Add \$194 list upcharge** for wire management cut-out option and state clearly on Purchase Order. The 32" BBF and V-Ped is one component. The V-Ped is always located towards the kneespace and is not available for field installation. A 32" pedestal under an extended return is inset by 24". A 24" pedestal under an extended return is inset by 16"

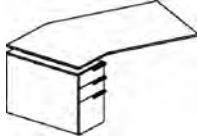
	81RHCI7230-38L16F	4889	5620	72	30	29.25	46	189	44
	81RHCI7230-38R16F	4889	5620	72	30	29.25	46	189	44
	81RHCI7230-38L16D	4889	5620	72	30	29.25	46	189	44
	81RHCI7230-38R16D	4889	5620	72	30	29.25	46	189	44
	81RHCI7236-44R16F	5022	5773	72	36	29.25	43	232	52
	81RHCI7236-44L16F*	5022	5773	72	36	29.25	43	232	52
	81RHCI7236-44R16D	5022	5773	72	36	29.25	43	232	52
	81RHCI7236-44L16D	5022	5773	72	36	29.25	43	232	52
	81RHCI8030-38L16F	5135	5905	80	30	29.25	52	210	49
	81RHCI8030-38R16F	5135	5905	80	30	29.25	52	210	49
	81RHCI8030-38L16D	5135	5905	80	30	29.25	52	210	49
	81RHCI8030-38R16D	5135	5905	80	30	29.25	52	210	49
	81RHCI8036-44L16F	5233	6017	80	36	29.25	48	247	58
	81RHCI8036-44R16F	5233	6017	80	36	29.25	48	247	58
	81RHCI8036-44L16D	5233	6017	80	36	29.25	48	247	58
81RHCI8036-44R16D	5233	6017	80	36	29.25	48	247	58	

**DIMENSION KEY**

W - width  
D - depth  
H - height

**CODE DESCRIPTION**

L - left hand pedestal position  
R - right hand pedestal position  
D - 2 file drawer  
F - 2 box, 1 file drawer  
H - desk height worksurface  
01 - lateral file drawer  
05 - 4 box/ 1 lateral file  
X31 - 3/4 height recessed modesty panel  
X41 - full height recessed modesty panel

**WIRING GROMMETS**

One rectangular grommet in a standard position is optional at no charge. Additional rectangular grommets are available at an upcharge of **\$152 list**. See page 117 for PowerPort options.

**SUPPORT**

Any top with a V-Beam and a kneespace greater than 64" requires a half gable. Please see page 189.

# VESTRADA | ANGLED SHAPED RETURNS

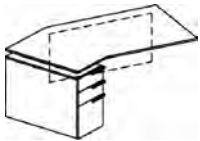
Description	Model	Cherry Maple Walnut		W	D	H	KW	Shipping Weight	Cubic Feet
		Rift Oak	Anigre						
Canted Inverted	81RHCIV7230-38L16FX31	5755	6616	72	30	29.25	44	215	44
Desk Height Return,	81RHCIV7230-38R16FX31	5755	6616	72	30	29.25	44	215	44
3/4 Height	81RHCIV7230-38L16DX31	5755	6616	72	30	29.25	44	215	44
Floating Modesty	81RHCIV7230-38R16DX31	5755	6616	72	30	29.25	44	215	44
Panel, 16" Pedestal	81RHCIV7236-44L16FX31*	5911	6795	72	36	29.25	40	258	52
	81RHCIV7236-44R16FX31	5911	6795	72	36	29.25	40	258	52
	81RHCIV7236-44L16DX31	5911	6795	72	36	29.25	40	258	52
	81RHCIV7236-44R16DX31	5911	6795	72	36	29.25	40	258	52
	81RHCIV8030-38L16FX31	6043	6946	80	30	29.25	52	236	49
	81RHCIV8030-38R16FX31	6043	6946	80	30	29.25	52	236	49
	81RHCIV8030-38L16DX31	6043	6946	80	30	29.25	52	236	49
	81RHCIV8030-38R16DX31	6043	6946	80	30	29.25	52	236	49
	81RHCIV8036-44L16FX31	6159	7084	80	36	29.25	48	273	58
	81RHCIV8036-44R16FX31	6159	7084	80	36	29.25	48	273	58
	81RHCIV8036-44L16DX31	6159	7084	80	36	29.25	48	273	58
	81RHCIV8036-44R16DX31	6159	7084	80	36	29.25	48	273	58

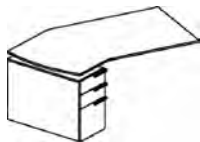
Canted Arc Inverted	81RHCAI7230-38L16F	4889	5620	72	30	29.25	44	189	44
Desk Height Return,	81RHCAI7230-38R16F	4889	5620	72	30	29.25	44	189	44
no Modesty Panel,	81RHCAI7230-38L16D	4889	5620	72	30	29.25	44	189	44
16" Pedestal	81RHCAI7230-38R16D	4889	5620	72	30	29.25	44	189	44
	81RHCAI7236-44L16F*	5022	5773	72	36	29.25	40	232	52
	81RHCAI7236-44R16F	5022	5773	72	36	29.25	40	232	52
	81RHCAI7236-44L16D	5022	5773	72	36	29.25	40	232	52
	81RHCAI7236-44R16D	5022	5773	72	36	29.25	40	232	52
	81RHCAI8030-38L16F	5135	5905	80	30	29.25	52	210	49
	81RHCAI8030-38R16F	5135	5905	80	30	29.25	52	210	49
	81RHCAI8030-38L16D	5135	5905	80	30	29.25	52	210	49
	81RHCAI8030-38R16D	5135	5905	80	30	29.25	52	210	49
	81RHCAI8036-44L16F	5233	6017	80	36	29.25	48	249	58
	81RHCAI8036-44R16F	5233	6017	80	36	29.25	48	249	58
	81RHCAI8036-44L16D	5233	6017	80	36	29.25	48	249	58
	81RHCAI8036-44R16D	5233	6017	80	36	29.25	48	249	58

**ORDERING PROCEDURE**

- To order, please specify the following:
- 1) Krug product model number
  - 2) Wood species and finish, see page 114
  - 3) Pull style and finish, see page 116
  - 4) V-Beam color, see page 117
  - 5) Grommet location and style if applicable

\* Indicates model illustrated by line drawing

**CODE DESCRIPTION**

- L - left hand pedestal position
- R - right hand pedestal position
- D - 2 file drawer
- F - 2 box, 1 file drawer
- H - desk height worksurface
- 01 - lateral file drawer
- 05 - 4 box/ 1 lateral file
- X31 - 3/4 height recessed modesty panel

**STANDARD FINISHES**

For a complete list of standard wood finishes please see page 114.

**SUPPORT**

Any top with a V-Beam and a kneespace greater than 64" requires a half gable. Please see page 189.

# VESTRADA | ANGLED SHAPED RETURNS

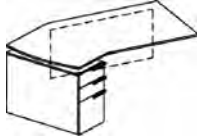
Description	Model	Wood		Anigre	W	D	H	KW	Shipping Weight	Cubic Feet
		Cherry Maple Walnut Rift Oak								
 Canted Arc Inverted Desk Height Return, 3/4 Height Floating Modesty Panel, 16" Pedestal	81RHCAIV7230-38L16FX31	5755	6616	6616	72	30	29.25	44	215	44
	81RHCAIV7320-38L16DX31	5755	6616	6616	72	30	29.25	44	215	44
	81RHCAIV7230-38R16FX31	5755	6616	6616	72	30	29.25	44	215	44
	81RHCAIV7230-38R16DX31	5755	6616	6616	72	30	29.25	44	215	44
	81RHCAIV7236-44L16FX31	5911	6795	6795	72	30	29.25	40	258	52
	81RHCAIV7236-44L16DX31	5911	6795	6795	72	36	29.25	40	258	52
	81RHCAIV7236-44R16FX31	5911	6795	6795	72	36	29.25	40	258	52
	81RHCAIV7236-44R16DX31	5911	6795	6795	72	36	29.25	40	258	52
	81RHCAIV8030-38L16FX31*	6043	6946	6946	80	30	29.25	52	236	49
	81RHCAIV8030-38L16DX31	6043	6946	6946	80	30	29.25	52	236	49
	81RHCAIV8030-38R16FX31	6043	6946	6946	80	30	29.25	52	236	49
	81RHCAIV8030-38R16DX31	6043	6946	6946	80	30	29.25	52	236	49
	81RHCAIV8036-44L16FX31	6159	7084	7084	80	36	29.25	48	273	58
	81RHCAIV8036-44L16DX31	6159	7084	7084	80	36	29.25	48	273	58
81RHCAIV8036-44R16FX31	6159	7084	7084	80	36	29.25	48	273	58	
81RHCAIV8036-44R16DX31	6159	7084	7084	80	36	29.25	48	273	58	

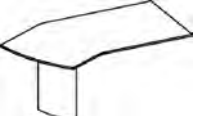
 Canted Arc Inverted Desk Height Return, Elliptical Base	81RHCAI7230-38LE2	3390	3899	3899	72	30	29.25	44	163	44
	81RHCAI7230-38RE2	3390	3899	3899	72	30	29.25	44	163	44
	81RHCAI7236-44LE2	3538	4068	4068	72	36	29.25	40	206	52
	81RHCAI7236-44RE2	3538	4068	4068	72	36	29.25	40	206	52
	81RHCAI8030-38LE2*	3648	4197	4197	80	30	29.25	52	184	49
	81RHCAI8030-38RE2	3648	4197	4197	80	30	29.25	52	184	49
	81RHCAI8036-44LE2	3814	4385	4385	80	36	29.25	48	221	58
	81RHCAI8036-44RE2	3814	4385	4385	80	36	29.25	48	221	58

**DIMENSION KEY**

W - width  
D - depth  
H - height

**CODE DESCRIPTION**

L - left hand pedestal position  
R - right hand pedestal position  
D - 2 file drawer  
F - 2 box, 1 file drawer  
H - desk height worksurface  
01 - lateral file drawer  
05 - 4 box/ 1 lateral file  
X31 - 3/4 height recessed modesty panel  
X41 - full height recessed modesty panel

**WIRING GROMMETS**

One rectangular grommet in a standard position is optional at no charge. Additional rectangular grommets are available at an upcharge of **\$152 list**. See page 117 for PowerPort options.

**SUPPORT**

Any top with a V-Beam and a kneespace greater than 64" requires a half gable. Please see page 189.

# VESTRADA | CURVILINEAR RETURNS

Description	Model	Cherry Maple Walnut		W	D	H	KW	Shipping Weight	Cubic Feet
		Rift Oak	Anigre						
 Oblique Desk Height Return, Elliptical Base	81RHO7230-36LE2	3390	3899	72	30	29.25	56	163	11
	81RHO7230-36RE2	3390	3899	72	30	29.25	56	163	11
	81RHO7236-42LE2	3538	4068	72	36	29.25	56	206	12
	81RHO7236-42RE2	3538	4068	72	36	29.25	56	206	12
	81RHO8030-36LE2*	3648	4197	80	30	29.25	64	184	13
	81RHO8030-36RE2	3648	4197	80	30	29.25	64	184	13
	81RHO8036-42LE2	3814	4385	80	36	29.25	64	221	14
	81RHO8036-42RE2	3814	4385	80	36	29.25	64	221	14

 Oblique Desk Height Return, Elliptical Base, Fixed Modesty Panel	81RHO7230-36LE2X41	4555	5238	72	30	29.25	56	189	12
	81RHO7230-36RE2X41	4555	5238	72	30	29.25	56	189	12
	81RHO7236-42LE2X41	4593	5284	72	36	29.25	56	232	13
	81RHO7236-42RE2X41	4593	5284	72	36	29.25	56	232	13
	81RHO8030-36LE2X41*	4691	5393	80	30	29.25	64	210	14
	81RHO8030-36RE2X41	4691	5393	80	30	29.25	64	210	14
	81RHO8036-42LE2X41	4810	5529	80	36	29.25	64	247	15
	81RHO8036-42RE2X41	4810	5529	80	36	29.25	64	247	15

 Oblique Desk Height Return, Elliptical Base, Floating Modesty Panel	81RHOV7230-36LE2X31	5009	5761	72	30	29.25	56	189	12
	81RHOV7230-36RE2X31	5009	5761	72	30	29.25	56	189	12
	81RHOV7236-42LE2X31	5053	5810	72	36	29.25	56	232	13
	81RHOV7236-42RE2X31	5053	5810	72	36	29.25	56	232	13
	81RHOV8030-36LE2X31*	5159	5933	80	30	29.25	64	210	14
	81RHOV8030-36RE2X31	5159	5933	80	30	29.25	64	210	14
	81RHOV8036-42LE2X31	5288	6081	80	36	29.25	64	247	15
	81RHOV8036-42RE2X31	5288	6081	80	36	29.25	64	247	15

 Oblique Inverted Desk Height Return, Elliptical Base	81RHOI7230-36LE2	3390	3899	72	30	29.25	56	163	11
	81RHOI7230-36RE2	3390	3899	72	30	29.25	56	163	11
	81RHOI7236-42LE2	3538	4068	72	36	29.25	56	206	12
	81RHOI7236-42RE2	3538	4068	72	36	29.25	56	206	12
	81RHOI8030-36LE2*	3648	4197	80	30	29.25	64	184	13
	81RHOI8030-36RE2	3648	4197	80	30	29.25	64	184	13
	81RHOI8036-42LE2	3814	4385	80	36	29.25	64	221	14
	81RHOI8036-42RE2	3814	4385	80	36	29.25	64	221	14

**ORDERING PROCEDURE**

- To order, please specify the following:
- 1) Krug product model number
  - 2) Wood species and finish, see page 114
  - 3) Pull style and finish, see page 116
  - 4) V-Beam color, see page 117
  - 5) Grommet location and style if applicable

\* Indicates model illustrated by line drawing

**CODE DESCRIPTION**

- L - left hand pedestal position
- R - right hand pedestal position
- D - 2 file drawer
- F - 2 box, 1 file drawer
- H - desk height worksurface
- M - machine height
- V - floating modesty panel
- E2 - wood elliptical base
- X31 - 3/4 height recessed modesty panel
- X41 - full height recessed modesty panel

**STANDARD FINISHES**

For a complete list of standard wood finishes please see page 114.

**SUPPORT**

Any top with a V-Beam and a kneespace greater than 64" requires a half gable. Please see page 189.

# VESTRADA | CURVILINEAR RETURNS

Description	Model	Cherry		W	D	H	KW	Shipping Weight	Cubic Feet	
		Maple	Walnut							
		Rift Oak	Anigre							
	Oblique Inverted	81RHOI7230-36LE2X41	4555	5238	72	30	29.25	56	163	11
	Desk Height Return,	81RHOI7230-36RE2X41	4555	5238	72	30	29.25	56	163	11
	Elliptical Base, Fixed	81RHOI7236-42LE2X41	4593	5284	72	36	29.25	56	189	12
	Modesty Panel	81RHOI7236-42RE2X41	4593	5284	72	36	29.25	56	189	12
		81RHOI8030-36LE2X41*	4691	5393	80	30	29.25	64	184	13
		81RHOI8030-36RE2X41	4691	5393	80	30	29.25	64	184	13
		81RHOI8036-42LE2X41	4810	5529	80	36	29.25	64	210	14
	81RHOI8036-42RE2X41	4810	5529	80	36	29.25	64	210	14	

	Oblique Inverted	81RHOIV7230-36LE2X31	5009	5761	72	30	29.25	56	189	12
	Desk Height Return,	81RHOIV7230-36RE2X31	5009	5761	72	30	29.25	56	189	12
	Elliptical Base,	81RHOIV7236-42LE2X31	5053	5810	72	36	29.25	56	232	13
	Floating Modesty	81RHOIV7236-42RE2X31	5053	5810	72	36	29.25	56	232	13
	Panel	81RHOIV8030-36LE2X31*	5159	5933	80	30	29.25	64	210	14
		81RHOIV8030-36RE2X31	5159	5933	80	30	29.25	64	210	14
		81RHOIV8036-42LE2X31	5288	6081	80	36	29.25	64	247	15
	81RHOIV8036-42RE2X31	5288	6081	80	36	29.25	64	247	15	

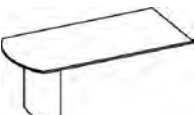
	Arc End Desk Height	81RHA7230LE2	2155	2478	72	30	29.25	56	164	12
	Return, Elliptical	81RHA7230RE2	2155	2478	72	30	29.25	56	164	12
	Base	81RHA7236LE2	2219	2553	72	36	29.25	56	207	13
		81RHA7236RE2	2219	2553	72	36	29.25	56	207	13
		81RHA8030LE2*	2250	2587	80	30	29.25	64	185	14
		81RHA8030RE2	2250	2587	80	30	29.25	64	185	14
		81RHA8036LE2	2334	2684	80	36	29.25	64	222	15
	81RHA8036RE2	2334	2684	80	36	29.25	64	222	15	

	Arc End Desk	81RHA7230LE2X41	2681	3081	72	30	29.25	56	190	12
	Height Return,	81RHA7230RE2X41	2681	3081	72	30	29.25	56	190	12
	Elliptical Base,	81RHA7236LE2X41	2924	3363	72	36	29.25	56	233	13
	Fixed Modesty	81RHA7236RE2X41	2924	3363	72	36	29.25	56	233	13
	Panel	81RHA8030LE2X41*	2955	3397	80	30	29.25	64	211	14
		81RHA8030RE2X41	2955	3397	80	30	29.25	64	211	14
		81RHA8036LE2X41	3215	3697	80	36	29.25	64	248	15
	81RHA8036RE2X41	3215	3697	80	36	29.25	64	248	15	

**DIMENSION KEY**

W - width  
 D - depth  
 H - height

**CODE DESCRIPTION**

L - left hand pedestal position  
 R - right hand pedestal position  
 D - 2 file drawer  
 F - 2 box, 1 file drawer  
 H - desk height worksurface  
 M - machine height  
 V - floating modesty panel  
 E2 - wood elliptical base  
 X31 - 3/4 height recessed modesty panel  
 X41 - full height recessed modesty panel

**WIRING GROMMETS**

One rectangular grommet in a standard position is optional at no charge. Additional rectangular grommets are available at an upcharge of **\$152 list**. See page 117 for PowerPort options.

**SUPPORT**

Any top with a V-Beam and a kneespace greater than 64" requires a half gable. Please see page 189.

# VESTRADA | CURVILINEAR RETURNS

Description	Model	Cherry		W	D	H	KW	Shipping Weight	Cubic Feet
		Maple	Walnut						
Arc End Desk Height	81RHAV7230LE2X31	2948	3390	72	30	29.25	56	190	12
Return, Elliptical	81RHAV7230RE2X31	2948	3390	72	30	29.25	56	190	12
Base, Floating	81RHAV7236LE2X31*	3216	3698	72	36	29.25	56	233	13
Modesty Panel	81RHAV7236RE2X31	3216	3698	72	36	29.25	56	233	13
	81RHAV8030LE2X31	3249	3739	80	30	29.25	64	211	14
	81RHAV8030RE2X31	3249	3739	80	30	29.25	64	211	14
	81RHAV8036LE2X31	3536	4066	80	36	29.25	64	248	15
	81RHAV8036RE2X31	3536	4066	80	36	29.25	64	248	15



Bullet Desk Height	81RHB7230LE2	2218	2552	72	30	29.25	56	164	10
Return, Elliptical	81RHB7230RE2	2218	2552	72	30	29.25	56	164	10
Base	81RHB7236LE2	2285	2630	72	36	29.25	56	207	11
	81RHB7236RE2	2285	2630	72	36	29.25	56	207	11
	81RHB8030LE2*	2316	2664	80	30	29.25	64	185	12
	81RHB8030RE2	2316	2664	80	30	29.25	64	185	12
	81RHB8036LE2	2405	2764	80	36	29.25	64	222	13
	81RHB8036RE2	2405	2764	80	36	29.25	64	222	13

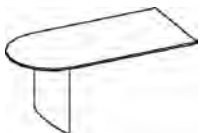

**ORDERING NOTES:**

Replace 'H' in the model number prefix with 'M' to specify machine height at no upcharge.

Bullet Desk Height	81RHB7230LE2X41	2487	2859	72	30	29.25	56	190	11
Return, Elliptical	81RHB7230RE2X41	2487	2859	72	30	29.25	56	190	11
Base, Fixed	81RHB7236LE2X41	2564	2948	72	36	29.25	56	233	12
Modesty Panel	81RHB7236RE2X41	2564	2948	72	36	29.25	56	233	12
	81RHB8030LE2X41*	2597	2988	80	30	29.25	64	211	13
	81RHB8030RE2X41	2597	2988	80	30	29.25	64	211	13
	81RHB8036LE2X41	2697	3102	80	36	29.25	64	248	14
	81RHB8036RE2X41	2697	3102	80	36	29.25	64	248	14



Bullet Desk Height	81RHBV7230LE2X31	2739	3147	72	30	29.25	56	190	11
Return, Elliptical	81RHBV7230RE2X31	2739	3147	80	30	29.25	56	190	11
Base, Floating	81RHBV7236LE2X31	2822	3245	72	30	29.25	56	233	12
Modesty Panel	81RHBV7236RE2X31	2822	3245	80	30	29.25	56	233	12
	81RHBV8030LE2X31*	2858	3287	72	36	29.25	64	211	13
	81RHBV8030RE2X31	2858	3287	80	36	29.25	64	211	13
	81RHBV8036LE2X31	2966	3412	72	36	29.25	64	248	14
	81RHBV8036RE2X31	2966	3412	80	36	29.25	64	248	14



**ORDERING PROCEDURE**

- To order, please specify the following:
- 1) Krug product model number
  - 2) Wood species and finish, see page 114
  - 3) Pull style and finish, see page 116
  - 4) V-Beam color, see page 117
  - 5) Grommet location and style if applicable

\* Indicates model illustrated by line drawing

**CODE DESCRIPTION**

- L - left hand pedestal position
- R - right hand pedestal position
- D - 2 file drawer
- F - 2 box, 1 file drawer
- H - desk height worksurface
- M - machine height
- V - floating modesty panel
- E2 - wood elliptical base
- X31 - 3/4 height recessed modesty panel
- X41 - full height recessed modesty panel

**STANDARD FINISHES**

For a complete list of standard wood finishes please see page 114.

**SUPPORT**

Any top with a V-Beam and a kneespace greater than 64" requires a half gable. Please see page 189.

# VESTRADA | CURVILINEAR RETURNS

Description	Model	Cherry		Anigre	W	D	H	KW	Shipping Weight	Cubic Feet
		Maple	Walnut							
 P- Desk Height Return, Elliptical Base	81RHP7230-36LE2	3390	3899	3899	72	30	29.25	56	163	10
	81RHP7230-36RE2	3390	3899	3899	80	30	29.25	56	163	10
	81RHP7236-42LE2	3538	4068	4068	72	36	29.25	56	206	11
	81RHP7236-42RE2	3538	4068	4068	80	36	29.25	56	206	11
	81RHP8030-36LE2*	3648	4197	4197	72	30	29.25	64	184	12
	81RHP8030-36RE2	3648	4197	4197	80	30	29.25	64	184	12
	81RHP8036-42LE2	3814	4385	4385	72	36	29.25	64	221	13
	81RHP8036-42RE2	3814	4385	4385	80	36	29.25	64	221	13

 P- Desk Height Return, Elliptical Base, Fixed Modesty Panel	81RHP7230-36LE2X41	4555	5238	5238	72	30	29.25	56	189	12
	81RHP7230-36RE2X41	4555	5238	5238	80	30	29.25	56	189	12
	81RHP7236-42LE2X41	4593	5284	5284	72	36	29.25	56	232	13
	81RHP7236-42RE2X41	4593	5284	5284	80	36	29.25	56	232	13
	81RHP8030-36LE2X41	4691	5393	5393	72	30	29.25	64	210	14
	81RHP8030-36RE2X41	4691	5393	5393	80	30	29.25	64	210	14
	81RHP8036-42LE2X41*	4810	5529	5529	72	36	29.25	64	247	15
	81RHP8036-42RE2X41	4810	5529	5529	80	36	29.25	64	247	15

**ORDERING NOTES:**

Replace 'H' in the model number prefix with 'M' to specify machine height at no upcharge.

 P- Desk Height Return, Elliptical Base, Floating Modesty Panel	81RHPV7230-36LE2X31	5009	5761	5761	72	30	29.25	56	188	12
	81RHPV7230-36RE2X31	5009	5761	5761	80	30	29.25	56	188	12
	81RHPV7236-42LE2X31	5053	5810	5810	72	36	29.25	56	231	13
	81RHPV7236-42RE2X31	5053	5810	5810	80	36	29.25	56	231	13
	81RHPV8030-36LE2X31	5159	5933	5933	72	30	29.25	64	209	14
	81RHPV8030-36RE2X31	5159	5933	5933	80	30	29.25	64	209	14
	81RHPV8036-42LE2X31*	5288	6081	6081	72	36	29.25	64	249	15
	81RHPV8036-42RE2X31	5288	6081	6081	80	36	29.25	64	249	15

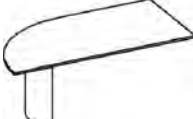
 Fin Desk Height Return, Elliptical Base	81RHF7230LE2	2218	2552	2552	72	30	29.25	56	163	10
	81RHF7230RE2	2218	2552	2552	80	30	29.25	56	163	10
	81RHF7236LE2	2285	2630	2630	72	30	29.25	56	206	11
	81RHF7236RE2	2285	2630	2630	80	30	29.25	56	206	11
	81RHF8030LE2*	2316	2664	2664	72	36	29.25	60	184	12
	81RHF8030RE2	2316	2664	2664	80	36	29.25	60	184	12
	81RHF8036LE2	2405	2764	2764	72	36	29.25	60	221	13
	81RHF8036RE2	2405	2764	2764	80	36	29.25	60	221	13

**DIMENSION KEY**

W - width  
D - depth  
H - height

**CODE DESCRIPTION**

L - left hand pedestal position  
R - right hand pedestal position  
D - 2 file drawer  
F - 2 box, 1 file drawer  
H - desk height worksurface  
M - machine height  
V - floating modesty panel  
E2 - wood elliptical base  
X31 - 3/4 height recessed modesty panel  
X41 - full height recessed modesty panel

**WIRING GROMMETS**

One rectangular grommet in a standard position is optional at no charge. Additional rectangular grommets are available at an upcharge of **\$152 list**. See page 117 for PowerPort options.

**SUPPORT**

Any top with a V-Beam and a kneespace greater than 64" requires a half gable. Please see page 189.

# VESTRADA | TRACDESKS

Description	Model	Cherry Maple Walnut		W	D	H	KW	Shipping Weight	Cubic Feet
		Rift Oak	Anigre						
Fin Desk Height	81RHFV7230LE2X31	2487	2859	72	30	29.25	56	189	11
Return, Elliptical	81RHFV7230RE2X31	2487	2859	80	30	29.25	56	189	11
Base, Floating	81RHFV7236LE2X31	2564	2948	72	30	29.25	56	232	12
Modesty Panel	81RHFV7236RE2X31	2564	2948	80	30	29.25	56	232	12
	81RHFV8030LE2X31*	2597	2988	72	36	29.25	60	210	13
	81RHFV8030RE2X31	2597	2988	80	36	29.25	60	210	13
	81RHFV8036LE2X31	2698	3103	72	36	29.25	60	247	14
	81RHFV8036RE2X31	2698	3103	80	36	29.25	60	247	14

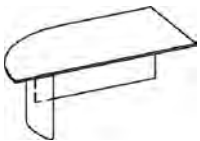

**ORDERING NOTES:**

Replace 'H' in the model number prefix with 'M' to specify machine height at no upcharge.

Desk Height, Oblique TracDesk	81RHJO6436LE2	3740	4299	72	36	29.25	48	139	14.5
	81RHJO6436RE2	3740	4299	72	36	29.25	48	139	14.5
	81RHJO7236LE2	3873	4455	72	36	29.25	56	164	15.5
	81RHJO7236RE2	3873	4455	72	36	29.25	56	164	15.5
	81RHJO7242LE2*	3940	4533	80	42	29.25	56	207	17
	81RHJO7242RE2	3940	4533	80	42	29.25	56	207	17
	81RHJO8042LE2	4019	4618	80	42	29.25	64	222	18.5
	81RHJO8042RE2	4019	4618	80	42	29.25	64	222	18.5

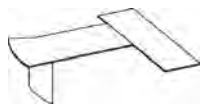

Desk Height, Oblique Inverted TracDesk	81RHJOI6436LE2	3740	4299	72	36	29.25	48	139	14.5
	81RHJOI6436RE2	3740	4299	72	36	29.25	48	139	14.5
	81RHJOI7236LE2	3873	4455	72	36	29.25	56	164	15.5
	81RHJOI7236RE2	3873	4455	72	36	29.25	56	164	15.5
	81RHJOI7242LE2*	3940	4533	80	42	29.25	56	207	17
	81RHJOI7242RE2	3940	4533	80	42	29.25	56	207	17
	81RHJOI8042LE2	4019	4618	80	42	29.25	64	222	18.5
	81RHJOI8042RE2	4019	4618	80	42	29.25	64	222	18.5

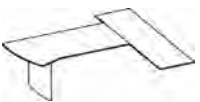

Desk Height, Arc End TracDesk	81RHJA6430LE2	2589	2978	64	30	29.25	48	139	12.5
	81RHJA6430RE2	2589	2978	64	30	29.25	48	139	12.5
	81RHJA7230LE2	2676	3077	72	30	29.25	56	164	14.5
	81RHJA7230RE2	2676	3077	72	30	29.25	56	164	14.5
	81RHJA7236LE2*	2721	3133	72	36	29.25	56	207	15.5
	81RHJA7236RE2	2721	3133	72	36	29.25	56	207	15.5
	81RHJA8030LE2	2712	3117	80	30	29.25	56	215	17
	81RHJA8030RE2	2712	3117	80	30	29.25	56	215	17
	81RHJA8036LE2	2772	3187	80	36	29.25	64	222	18.5
	81RHJA8036RE2	2772	3187	80	36	29.25	64	222	18.5

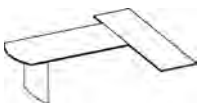

**ORDERING PROCEDURE**

- To order, please specify the following:
- 1) Krug product model number
  - 2) Wood species and finish, see page 114
  - 3) Pull style and finish, see page 116
  - 4) V-Beam color, see page 117
  - 5) Grommet location and style if applicable

\* Indicates model illustrated by line drawing

**CODE DESCRIPTION**

- L - left hand pedestal position
- R - right hand pedestal position
- D - 2 file drawer
- F - 2 box, 1 file drawer
- H - desk height worksurface
- M - machine height
- V - floating modesty panel
- E2 - wood elliptical base
- X31 - 3/4 height recessed modesty panel
- X41 - full height recessed modesty panel



**STANDARD FINISHES**

For a complete list of standard wood finishes please see page 114.

**SUPPORT**

Any top with a V-Beam and a kneespace greater than 64" requires a half gable. Please see page 189.

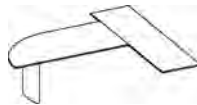

Description	Model	Cherry		W	D	H	KW	Shipping Weight	Cubic Feet
		Maple	Walnut						
		Rift Oak	Anigre						
 Desk Height, Bullet TracDesk	81RHJB6430LE2	2637	3032	64	30	29.25	48	134	12.5
	81RHJB6430RE2	2637	3032	64	30	29.25	48	134	12.5
	81RHJB7230LE2	2728	3138	72	30	29.25	56	159	14.5
	81RHJB7230RE2	2728	3138	72	30	29.25	56	159	14.5
	81RHJB7236LE2*	2778	3194	72	36	29.25	56	202	15.5
	81RHJB7236RE2	2778	3194	72	36	29.25	56	202	15.5
	81RHJB8030LE2	2793	3211	80	30	29.25	64	208	17
	81RHJB8030RE2	2793	3211	80	30	29.25	64	208	17
	81RHJB8036LE2	2831	3257	80	36	29.25	64	217	18.5
	81RHJB8036RE2	2831	3257	80	36	29.25	64	217	18.5
 Desk Height, P- TracDesk	81RHJP6436LE2	3740	4299	64	36	29.25	48	139	14.5
	81RHJP6436RE2	3740	4299	64	36	29.25	48	139	14.5
	81RHJP7236LE2	3871	4454	72	36	29.25	56	164	15.5
	81RHJP7236RE2	3871	4454	72	36	29.25	56	164	15.5
	81RHJP7242LE2*	3939	4532	72	42	29.25	56	207	17
	81RHJP7242RE2	3939	4532	72	42	29.25	56	207	17
	81RHJP8042LE2	4019	4618	80	42	29.25	64	222	18.5
	81RHJP8042RE2	4019	4618	80	42	29.25	64	222	18.5
 Desk Height, Fin TracDesk	81RHJF6430LE2	2637	3032	64	30	29.25	44	139	12.5
	81RHJF6430RE2	2637	3032	64	30	29.25	44	139	12.5
	81RHJF7230LE2	2732	3140	72	30	29.25	52	164	14
	81RHJF7230RE2	2732	3140	72	30	29.25	52	164	14
	81RHJF7236LE2*	2776	3193	72	36	29.25	52	207	15
	81RHJF7236RE2	2776	3193	72	36	29.25	52	207	15
	81RHJF8030LE2	2793	3211	80	30	29.25	60	215	15.5
	81RHJF8030RE2	2793	3211	80	30	29.25	60	215	15.5
	81RHJF8036LE2	2833	3259	80	36	29.25	60	222	16.5
	81RHJF8036RE2	2833	3259	80	36	29.25	60	222	16.5

**ORDERING NOTES:**

Find compatible credenzas on pages 170-183. TracDesks are not available on KrugExpress.

**DIMENSION KEY**

W - width  
D - depth  
H - height

**CODE DESCRIPTION**

L - left hand pedestal position  
R - right hand pedestal position  
D - 2 file drawer  
F - 2 box, 1 file drawer  
H - desk height worksurface  
M - machine height  
V - floating modesty panel  
E2 - wood elliptical base  
X31 - 3/4 height recessed modesty panel  
X41 - full height recessed modesty panel

**WIRING GROMMETS**

One rectangular grommet in a standard position is optional at no charge. Additional rectangular grommets are available at an upcharge of **\$152 list**. See page 202 for PowerPort options.

**SUPPORT**

Any top with a V-Beam and a kneespace greater than 64" requires a half gable. Please see page 189.

# VESTRADA | CREDENZAS

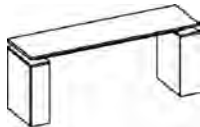
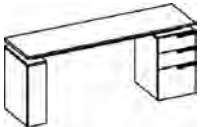
Description	Model	Cherry Maple Walnut		W	D	H	KW	Shipping Weight	Cubic Feet
		Rift Oak	Anigre						
 Credenza Shell, no Modesty Panel	81C64204L0R0	2656	3053	64	20	29.25	48	120	27
	81C64244L0R0	2719	3131	64	24	29.25	48	145	32
	81C72204L0R0	2761	3175	72	20	29.25	56	135	30
	81C72244L0R0	2867	3297	72	24	29.25	56	164	36
	81C80204L0R0	2943	3384	80	20	29.25	64	133	34
	81C80244L0R0	3055	3512	80	24	29.25	64	181	40
	81C88204L0R0	3136	3606	88	20	29.25	72	162	37
	81C88244L0R0	3239	3724	88	24	29.25	72	196	43
	81C96204L0R0	3539	4071	96	20	29.25	80	173	40
	81C96244L0R0*	3652	4200	96	24	29.25	80	209	47
 Single Pedestal Credenza, no Modesty Panel, 16" Pedestal	81C64204L16FR0	4646	5344	64	20	29.25	40	128	27
	81C64204L0R16F	4646	5344	64	20	29.25	40	128	27
	81C64204L16DR0	4646	5344	64	20	29.25	40	128	27
	81C64204L0R16D	4646	5344	64	20	29.25	40	128	27
	81C64244L16FR0	4684	5388	64	24	29.25	40	153	32
	81C64244L0R16F	4684	5388	64	24	29.25	40	153	32
	81C64244L16DR0	4684	5388	64	24	29.25	40	153	32
	81C64244L0R16D	4684	5388	64	24	29.25	40	153	32
	81C72204L16FR0	4690	5392	72	20	29.25	48	143	30
	81C72204L0R16F	4690	5392	72	20	29.25	48	143	30
	81C72204L16DR0	4690	5392	72	20	29.25	48	143	30
	81C72204L0R16D	4690	5392	72	20	29.25	48	143	30
	81C72244L16RF0	4719	5427	72	24	29.25	48	172	36
	81C72244L0R16F	4719	5427	72	24	29.25	48	172	36
	81C72244L16DR0	4719	5427	72	24	29.25	48	172	36
	81C72244L0R16D	4719	5427	72	24	29.25	48	172	36
	81C80204L16FR0	4730	5440	80	20	29.25	56	160	34
	81C80204L0R16F	4730	5440	80	20	29.25	56	160	34
	81C80204L16DR0	4730	5440	80	20	29.25	56	160	34
	81C80204L0R16D	4730	5440	80	20	29.25	56	160	34
	81C80244L16FR0	4750	5464	80	24	29.25	56	189	40
	81C80244L0R16F	4750	5464	80	24	29.25	56	189	40
	81C80244L16DR0	4750	5464	80	24	29.25	56	189	40
	81C80244L0R16D	4750	5464	80	24	29.25	56	189	40
	81C88204L16FR0	4759	5473	88	20	29.25	64	170	37
	81C88204L0R16F*	4759	5473	88	20	29.25	64	170	37
	81C88204L16DR0	4759	5473	88	20	29.25	64	170	37
81C88204L0R16D	4759	5473	88	20	29.25	64	170	37	
81C88244L16FR0	4781	5497	88	24	29.25	64	204	43	
81C88244L0R16F	4781	5497	88	24	29.25	64	204	43	
81C88244L16DR0	4781	5497	88	24	29.25	64	204	43	
81C88244L0R16D	4781	5497	88	24	29.25	64	204	43	

**ORDERING NOTES:**

Pricing does not include a modesty panel. To add a full height wood modesty panel add (X41 to the end of the model number, e.g. 81C88244L0R0X41. Add 7% to list price. Credenzas above 80", 88" and 96" lengths are compatible with TracDesk (see page 160). For TracDesk option please **add \$303 list** to your order and add a 'J' at the end of the model number, e.g. 81C88244L0R0J.

**ORDERING PROCEDURE**

- To order, please specify the following:
- 1) Krug product model number
  - 2) Wood species and finish, see page 114
  - 3) Pull style and finish, see page 116
  - 4) V-Beam color, see page 117
  - 5) Grommet location and style if applicable

\* Indicates model illustrated by line drawing

**CODE DESCRIPTION**

- L - left hand pedestal position
- R - right hand pedestal position
- D - 2 file drawer
- F - 2 box, 1 file drawer
- H - desk height worksurface
- M - machine height
- V - floating modesty panel
- E2 - wood elliptical base
- X31 - 3/4 height recessed modesty panel
- X41 - full height recessed modesty panel

**STANDARD FINISHES**

For a complete list of standard wood finishes please see page 114.

**GROMMETS**

One wiring grommet in standard position is optional at no charge. See page 202 for more wiring grommet information.

**GLASS PRIVACY SCREEN**

Please see page 204 for glass privacy screen options.

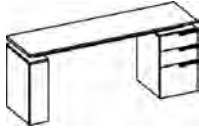
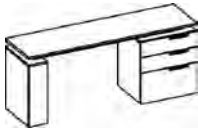
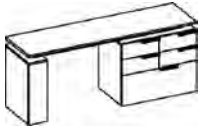
Description	Model	Cherry		W	D	H	KW	Shipping Weight	Cubic Feet
		Maple Walnut Rift Oak	Anigre						
Single Pedestal	81C96204L16FR0	4793	5512	96	20	29.25	72	181	40
Credenza, no	81C96204L0R16F	4793	5512	96	20	29.25	72	181	40
Modesty Panel, 16"	81C96204L16DR0	4793	5512	96	20	29.25	72	181	40
Pedestal, Continued	81C96204L0R16D	4793	5512	96	20	29.25	72	181	40
	81C96244L16FR0	4802	5524	96	24	29.25	72	217	47
	81C96244L0R16F	4802	5524	96	24	29.25	72	217	47
	81C96244L16DR0	4802	5524	96	24	29.25	72	217	47
	81C96244L0R16D	4802	5524	96	24	29.25	72	217	47
Single Pedestal	81C64204L24FR0	4792	5509	64	20	29.25	32	176	27
Credenza, no	81C64204L0R24F	4792	5509	64	20	29.25	32	176	27
Modesty Panel, 24"	81C64244L24FR0	4828	5552	64	24	29.25	32	201	32
Pedestal	81C64244L0R24F	4828	5552	64	24	29.25	32	201	32
	81C72204L24FR0	4835	5560	72	20	29.25	40	191	30
	81C72204L0R24F*	4835	5560	72	20	29.25	40	191	30
	81C72244L24FR0	4866	5596	72	24	29.25	40	220	36
	81C72244L0R24F	4866	5596	72	24	29.25	40	220	36
	81C80204L24FR0	4877	5608	80	20	29.25	48	189	34
	81C80204L0R24F	4877	5608	80	20	29.25	48	189	34
	81C80244L24FR0	4897	5632	80	24	29.25	48	237	40
	81C80244L0R24F	4897	5632	80	24	29.25	48	237	40
	81C88204L24FR0	4908	5644	88	20	29.25	56	218	37
	81C88204L0R24F	4908	5644	88	20	29.25	56	218	37
	81C88244L24FR0	4929	5668	88	24	29.25	56	252	43
	81C88244L0R24F	4929	5668	88	24	29.25	56	252	43
	81C96204L24FR0	4942	5682	96	20	29.25	64	229	40
	81C96204L0R24F	4942	5682	96	20	29.25	64	229	40
81C96244L24FR0	4951	5693	96	24	29.25	64	265	47	
81C96244L0R24F	4951	5693	96	24	29.25	64	265	47	
Single Pedestal	81C72204L3205R0	6346	7296	72	20	29.25	32	207	30
Credenza, no	81C72204L0R3205	6346	7296	72	20	29.25	32	207	30
Modesty Panel, 32"	81C72244L3205R0	6374	7331	72	24	29.25	32	236	36
4 Box/ 1 Lateral	81C72244L0R3205	6374	7331	72	24	29.25	32	236	36
File Pedestal	81C80204L3205R0	6388	7344	80	20	29.25	40	215	34
	81C80204L0R3205*	6388	7344	80	20	29.25	40	215	34
	81C80244L3205R0	6406	7367	80	24	29.25	40	253	40
	81C80244L0R3205	6406	7367	80	24	29.25	40	253	40
	81C88204L3205R0	6418	7379	88	20	29.25	48	234	37
	81C88204L0R3205	6418	7379	88	20	29.25	48	234	37
	81C88244L3205R0	6438	7402	88	24	29.25	48	268	43
	81C88244L0R3205	6438	7402	88	24	29.25	48	268	43
	81C96204L3205R0	6449	7418	96	20	29.25	56	245	40
	81C96204L0R3205	6449	7418	96	20	29.25	56	245	40
	81C96244L3205R0	6462	7430	96	24	29.25	56	281	47
81C96244L0R3205	6462	7430	96	24	29.25	56	281	47	

**ORDERING NOTES:**

Pricing does not include a modesty panel. To add a full height wood modesty panel add (X41 to the end of the model number, e.g. 81C88244L0R0X41. Add 7% to list price. Credenzas above 80", 88" and 96" lengths are compatible with TracDesk (see page 160). For TracDesk option please add \$303 list to your order and add a 'J' at the end of the model number, e.g. 81C88244L0R0J.

**DIMENSION KEY**

W - width  
D - depth  
H - height

**CODE DESCRIPTION**

L - left hand pedestal position  
R - right hand pedestal position  
D - 2 file drawer  
F - 2 box, 1 file drawer  
H - desk height worksurface  
M - machine height  
V - floating modesty panel  
E2 - wood elliptical base  
X31 - 3/4 height recessed modesty panel  
X41 - full height recessed modesty panel

**STANDARD FINISHES**

For a complete list of standard wood finishes please see page 114.

**GROMMETS**

One wiring grommet in standard position is optional at no charge. See page 117 for more wiring grommet information.

**PULL LOCATIONS**

For details please see page 116..

# VESTRADA | CREDENZAS

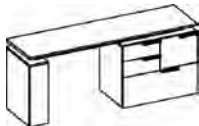
Description	Model	Cherry Maple Walnut		W	D	H	KW	Shipping Weight	Cubic Feet
		Rift Oak	Anigre						
Single Pedestal	81C72204L3202R0	6288	7229	72	20	29.25	32	207	30
Credenza, no	81C72204L0R3204	6288	7229	72	20	29.25	32	207	30
Modesty Panel, 32"	81C72244L3202R0	6315	7260	72	24	29.25	32	236	36
Combination	81C72244L0R3204	6315	7260	72	24	29.25	32	236	36
Pedestal	81C80204L3202R0	6328	7274	80	20	29.25	40	215	34
	81C80204L0R3204	6328	7274	80	20	29.25	40	215	34
	81C80244L3202R0	6347	7298	80	24	29.25	40	253	40
	81C80244L0R3204*	6347	7298	80	24	29.25	40	253	40
	81C88204L3202R0	6358	7311	88	20	29.25	48	234	37
	81C88204L0R3204	6358	7311	88	20	29.25	48	234	37
	81C88244L3202R0	6377	7333	88	24	29.25	48	268	43
	81C88244L0R3204	6377	7333	88	24	29.25	48	268	43
	81C96204L3202R0	6390	7348	96	20	29.25	56	245	40
	81C96204L0R3204	6390	7348	88	24	29.25	56	245	40
	81C96244L3202R0	6399	7359	96	24	29.25	56	281	47
	81C96244L0R3204	6399	7359	96	24	29.25	56	281	47

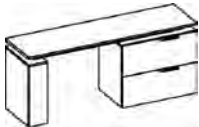
Single Pedestal	81C72204L3201R0	6032	6937	72	20	29.25	32	207	30
Credenza, no	81C7220RL0R3201	6032	6937	72	20	29.25	32	207	30
Modesty	81C72244L3201R0	6064	6973	72	24	29.25	32	236	36
Panel, 32" Lateral	81C72244L0R3201	6064	6973	72	24	29.25	32	236	36
File Pedestal	81C80204L3201R0	6075	6985	80	20	29.25	40	215	34
	81C80204L0R3201*	6075	6985	80	20	29.25	40	215	34
	81C80244L3201R0	6093	7006	80	24	29.25	40	253	40
	81C80244L0R3201	6093	7006	80	24	29.25	40	253	40
	81C88204L3201R0	6108	7022	88	20	29.25	48	234	37
	81C88204L0R3201	6108	7022	88	20	29.25	48	234	37
	81C88244L3201R0	6127	7045	88	24	29.25	48	268	43
	81C88244L0R3201	6127	7045	88	24	29.25	48	268	43
	81C96204L3201R0	6139	7061	96	20	29.25	56	245	40
	81C96204L0R3201	6139	7061	96	20	29.25	56	245	40
	81C96244L3201R0	6149	7072	96	24	29.25	56	281	47
	81C96244L0R3201	6149	7072	96	24	29.25	56	281	47

**ORDERING NOTES:**

Pricing does not include a modesty panel. To add a full height wood modesty panel add (X41 to the end of the model number, e.g. 81C88244L0R0X41. Add 7% to list price. Credenzas above 80", 88" and 96" lengths are compatible with TracDesk (see page 160). For TracDesk option please **add \$325 list** to your order and add a 'J' at the end of the model number, e.g. 81C88244L0R0J.

**ORDERING PROCEDURE**

- To order, please specify the following:
- 1) Krug product model number
  - 2) Wood species and finish, see page 114
  - 3) Pull style and finish, see page 115
  - 4) V-Beam color, see page 117
  - 5) Grommet location and style if applicable

\* Indicates model illustrated by line drawing

**CODE DESCRIPTION**

- L - left hand pedestal position
- R - right hand pedestal position
- D - 2 file drawer
- F - 2 box, 1 file drawer
- 0 - no pedestal
- J - TracDesk option
- W - extended pedestal option
- X31 - 3/4 height recessed modesty panel
- X41 - full height recessed modesty panel

**STANDARD FINISHES**

For a complete list of standard wood finishes please see page 114.

**GROMMETS**

One wiring grommet in standard position is optional at no charge. See page 117 for more wiring grommet information.

**GLASS PRIVACY SCREEN**

Please see page 204 for glass privacy screen options.

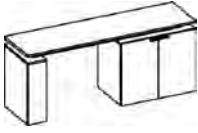
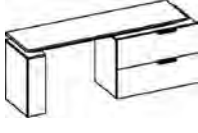
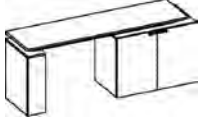
Description	Model	Cherry		Anigre	W	D	H	KW	Shipping Weight	Cubic Feet
		Maple	Walnut							
	Single Pedestal Credenza, no Modesty Panel, 32" Bookcase Pedestal	81C72204L32BCR0	5170	5945	72	20	29.25	32	202	30
	81C72204L0R32BC	5170	5945	72	20	29.25	32	202	30	
	81C72244L32BCR0	5201	5979	72	24	29.25	32	231	36	
	81C72244L0R32BC	5201	5979	72	24	29.25	32	231	36	
	81C80204L32BCR0	5213	5993	80	20	29.25	40	210	34	
	81C80204L0R32BC	5213	5993	80	20	29.25	40	210	34	
	81C80244L32BCR0	5232	6016	80	24	29.25	40	248	40	
	81C80244L0R32BC*	5232	6016	80	24	29.25	40	248	40	
	81C88204L32BCR0	5244	6032	88	20	29.25	48	229	37	
	81C88204L0R32BC	5244	6032	88	20	29.25	48	229	37	
	81C88244L32BCR0	5262	6052	88	24	29.25	48	263	43	
	81C88244L0R32BC	5262	6052	88	24	29.25	48	263	43	
	81C96204L32BCR0	5275	6067	96	20	29.25	56	240	40	
	81C96204L0R32BC	5275	6067	96	20	29.25	56	240	40	
	81C96244L32BCR0	5287	6080	96	24	29.25	56	276	47	
	81C96244L0R32BC	5287	6080	96	24	29.25	56	276	47	
	Single Pedestal Credenza, no Modesty Panel, 36" Lateral File Pedestal	81C72204L3601R0	6107	7020	72	20	29.25	28	223	30
	81C72204L0R3601	6107	7020	72	20	29.25	28	223	30	
	81C72244L3601R0	6136	7056	72	24	29.25	28	252	36	
	81C72244L0R3601	6136	7056	72	24	29.25	28	252	36	
	81C80204L3601R0	6144	7067	80	20	29.25	36	231	34	
	81C80204L0R3601	6144	7067	80	20	29.25	36	231	34	
	81C80244L3601R0*	6166	7091	80	24	29.25	36	269	40	
	81C80244L0R3601	6166	7091	80	24	29.25	36	269	40	
	81C88204L3601R0	6180	7106	88	20	29.25	44	218	37	
	81C88204L0R3601	6180	7106	88	20	29.25	44	218	37	
	81C88244L3601R0	6198	7129	88	24	29.25	44	284	43	
	81C88244L0R3601	6198	7129	88	24	29.25	44	284	43	
	81C96204L3601R0	6210	7144	96	20	29.25	52	261	40	
	81C96204L0R3601	6210	7144	96	20	29.25	52	261	40	
	81C96244L3601R0	6221	7154	96	24	29.25	52	297	47	
	81C96244L0R3601	6221	7154	96	24	29.25	52	297	47	
	Single Pedestal Credenza, no Modesty Panel, 36" Bookcase Pedestal	81C72204L36BCR0	5220	6004	72	20	29.25	28	207	30
	81C72204L0R36BC	5220	6004	72	20	29.25	28	207	30	
	81C72244L36BCR0	5256	6044	72	24	29.25	28	236	36	
	81C72244L0R36BC	5256	6044	72	24	29.25	28	236	36	
	81C80204L36BCR0	5264	6055	80	20	29.25	36	215	34	
	81C80204L0R36BC*	5264	6055	80	20	29.25	36	215	34	
	81C80244L36BCR0	5286	6079	80	24	29.25	36	253	40	
	81C80244L0R36BC	5286	6079	80	24	29.25	36	253	40	
	81C88204L36BCR0	5296	6090	88	20	29.25	44	234	37	
	81C88204L0R36BC	5296	6090	88	20	29.25	44	234	37	
	81C88244L36BCR0	5317	6113	88	24	29.25	44	268	43	
	81C88244L0R36BC	5317	6113	88	24	29.25	44	268	43	
	81C96204L36BCR0	5331	6133	96	20	29.25	52	245	40	
	81C96204L0R36BC	5331	6133	96	20	29.25	52	245	40	
	81C96244L36BCR0	5338	6139	96	24	29.25	52	281	47	
	81C96244L0R36BC	5338	6139	96	24	29.25	52	281	47	

**ORDERING NOTES:** Pricing does not include a modesty panel. To add a full height wood modesty panel add (X41 to the end of the model number. e.g. 81C88244L0R0X41. Add 7% to list price. Credenzas above 80", 88" and 96" lengths are compatible with TracDesk (see page 160). For TracDesk option please add **\$325 list** to your order and add a 'J' at the end of the model number, e.g. 81C88244L0R0J.

**DIMENSION KEY**

W - width  
D - depth  
H - height

**CODE DESCRIPTION**

L - left hand pedestal position  
R - right hand pedestal position  
D - 2 file drawer  
F - 2 box, 1 file drawer  
0 - no pedestal  
J - TracDesk option  
W - extended pedestal option  
X31 - 3/4 height recessed modesty panel  
X41 - full height recessed modesty panel

**STANDARD FINISHES**

For a complete list of standard wood finishes please see page 114.

**GROMMETS**

One wiring grommet in standard position is optional at no charge. See page 117 for more wiring grommet information.

**PULL LOCATIONS**

For details please see page 116.

# VESTRADA | CREDENZAS

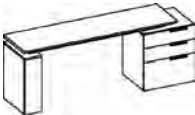
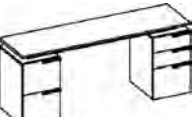
Description	Model	Cherry Maple Walnut			W	D	H	KW	Shipping Weight	Cubic Feet
		Rift Oak	Anigre							
Single Pedestal	81C64204L24FWRO	5210	5991	64	20	29.25	40	176	27	
Credenza, no	81C64204L0R24FW	5210	5991	64	20	29.25	40	176	27	
Modesty Panel, 24"	81C64244L24FWRO	5247	6034	64	24	29.25	40	201	32	
2 Box/ 1 File	81C64244L0R24FW	5247	6034	64	24	29.25	40	201	32	
Pedestal	81C72204L24FWRO	5256	6044	72	20	29.25	48	191	30	
	81C72204L0R24FW	5256	6044	72	20	29.25	48	191	30	
	81C72244L24FWRO	5288	6081	72	24	29.25	48	220	36	
	81C72244L0R24FW*	5288	6081	72	24	29.25	48	220	36	
	81C80204L24FWRO	5299	6093	80	20	29.25	56	189	34	
	81C80204L0R24FW	5299	6093	80	20	29.25	56	189	34	
	81C80244L24FWRO	5320	6117	80	24	29.25	56	237	40	
	81C80244L0R24FW	5320	6117	80	24	29.25	56	237	40	
	81C88204L24FWRO	5336	6137	88	20	29.25	64	218	37	
	81C88204L0R24FW	5336	6137	88	20	29.25	64	218	37	
	81C88244L24FWRO	5359	6161	88	24	29.25	64	252	43	
	81C88244L0R24FW	5359	6161	88	24	29.25	64	252	43	
	81C96204L24FWRO	5369	6179	96	20	29.25	72	229	40	
	81C96204L0R24FW	5369	6179	96	20	29.25	72	229	40	
	81C96244L24FWRO	5382	6187	96	24	29.25	72	265	47	
	81C96244L0R24FW	5382	6187	96	24	29.25	72	265	47	
	Double Pedestal	81C64204L16FR16F	6230	7164	64	20	29.25	32	192	27
	Credenza, no	81C64204L16FR16D	6230	7164	64	20	29.25	32	192	27
	Modesty Panel, 16"	81C64204L16DR16F	6230	7164	64	20	29.25	32	192	27
Pedestals	81C64204L16DR16D	6230	7164	64	20	29.25	32	192	27	
	81C64244L16FR16F	6269	7211	64	24	29.25	32	217	32	
	81C64244L16FR16D	6269	7211	64	24	29.25	32	217	32	
	81C64244L16DR16F*	6269	7211	64	24	29.25	32	217	32	
	81C64244L16DR16D	6269	7211	64	24	29.25	32	217	32	
	81C72204L16FR16F	6300	7245	72	20	29.25	40	207	30	
	81C72204L16FR16D	6300	7245	72	20	29.25	40	207	30	
	81C72204L16DR16F	6300	7245	72	20	29.25	40	207	30	
	81C72204L16DR16D	6300	7245	72	20	29.25	40	207	30	
	81C72244L16FR16F	6360	7315	72	24	29.25	40	236	36	
	81C72244L16FR16D	6360	7315	72	24	29.25	40	236	36	
	81C72244L16DR16F	6360	7315	72	24	29.25	40	236	36	
	81C72233L16DR16D	6360	7315	72	24	29.25	40	236	36	
	81C80204L16FR16F	6391	7350	80	20	29.25	48	215	34	
	81C80204L16FR16D	6391	7350	80	20	29.25	48	215	34	
	81C80204L16DR16F	6391	7350	80	20	29.25	48	215	34	
	81C80204L16DR16D	6391	7350	80	20	29.25	48	215	34	
	81C80244L16FR16F	6440	7406	80	24	29.25	48	253	40	
	81C80244L16FR16D	6440	7406	80	24	29.25	48	253	40	
81C80244L16DR16F	6440	7406	80	24	29.25	48	253	40		
81C80244L16DR16D	6440	7406	80	24	29.25	48	253	40		

**ORDERING NOTES:** Pricing does not include a modesty panel. To add a full height wood modesty panel add (X41 to the end of the model number, e.g. 81C88244L0R0X41. Add 7% to list price. Credenzas above 80", 88" and 96" lengths are compatible with TracDesk (see pages 168-169). For TracDesk option please **add \$325 list** to your order and add a 'J' at the end of the model number, e.g. 81C88244L0R0J.

**ORDERING PROCEDURE**

- To order, please specify the following:
- 1) Krug product model number
  - 2) Wood species and finish, see page 114
  - 3) Pull style and finish, see page 116
  - 4) V-Beam color, see page 117
  - 5) Grommet location and style if applicable

\* Indicates model illustrated by line drawing

**CODE DESCRIPTION**

- L - left hand pedestal position
- R - right hand pedestal position
- D - 2 file drawer
- F - 2 box, 1 file drawer
- 0 - no pedestal
- J - TracDesk option
- W - extended pedestal option
- X31 - 3/4 height recessed modesty panel
- X41 - full height recessed modesty panel

**STANDARD FINISHES**

For a complete list of standard wood finishes please see page 114.

**GROMMETS**

One wiring grommet in standard position is optional at no charge. See page 117 for more wiring grommet information.

**GLASS PRIVACY SCREEN**

Please see page 204 for glass privacy screen options.

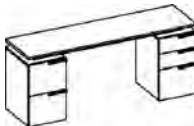
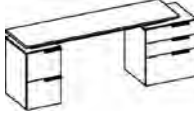
Description	Model	Cherry		W	D	H	KW	Shipping Weight	Cubic Feet		
		Maple	Walnut								
		Rift Oak	Anigre								
Double Pedestal	81C88204L16FR16F	6466	7436	88	20	29.25	56	234	37		
Credenza, no	81C88204L16FR16D	6466	7436	88	20	29.25	56	234	37		
Modesty Panel, 16"	81C88204L16DR16F	6466	7436	88	20	29.25	56	234	37		
Pedestals continued	81C88204L16DR16D	6466	7436	88	20	29.25	56	234	37		
	81C88244L16FR16F	6537	7516	88	24	29.25	56	268	43		
	81C88244L16FR16D	6537	7516	88	24	29.25	56	268	43		
	81C88244L16DR16F	6537	7516	88	24	29.25	56	268	43		
	81C88244L16DR16D	6537	7516	88	24	29.25	56	268	43		
	81C96204L16FR16F	6558	7544	96	20	29.25	64	245	40		
	81C96204L16FR16D	6558	7544	96	20	29.25	64	245	40		
	81C96204L16DR16F	6558	7544	96	20	29.25	64	245	40		
	81C96204L16DR16D	6558	7544	96	20	29.25	64	245	40		
	81C96244L16FR16F	6607	7596	96	24	29.25	64	281	47		
	81C96244L16FR16D	6607	7596	96	24	29.25	64	281	47		
	81C96244L16DR16F	6607	7596	96	24	29.25	64	281	47		
	81C96244L16DR16D	6607	7596	96	24	29.25	64	281	47		
	<hr/>										
	Double Pedestal	81C64204L16FR24FW	6418	7379	64	20	29.25	32	208	27	
	Credenza, no	81C64204L16DR24FW	6418	7379	64	20	29.25	32	208	27	
Modesty Panel, 16"	81C64204L24FWR16F	6418	7379	64	20	29.25	32	208	27		
& 24" Pedestals	81C64204L24FWR16D	6418	7379	64	20	29.25	32	208	27		
	81C64244L16FR24FW	6461	7428	64	24	29.25	32	233	32		
	81C64244L16DR24FW	6461	7428	64	24	29.25	32	233	32		
	81C64244L24FWR16F	6461	7428	64	24	29.25	32	233	32		
	81C64244L24FWR16D	6461	7428	64	24	29.25	32	233	32		
	81C72204L16FR24FW	6492	7464	72	20	29.25	40	223	30		
	81C72204L16DR24FW	6492	7464	72	20	29.25	40	223	30		
	81C72204L24FWR16F	6492	7464	72	20	29.25	40	223	30		
	81C72204L24FWR16D	6492	7464	72	20	29.25	40	223	30		
	81C72244L16FR24FW	6553	7536	72	24	29.25	40	252	36		
	81C72244L16DR24FW	6553	7536	72	24	29.25	40	252	36		
	81C72244L24FWR16F	6553	7536	72	24	29.25	40	252	36		
	81C72244L24FWR16D	6553	7536	72	24	29.25	40	252	36		
	81C80204L16FR24FW	6584	7572	80	20	29.25	48	231	34		
	81C80204L16DR24FW*	6584	7572	80	20	29.25	48	231	34		
	81C80204L24FWR16F	6584	7572	80	20	29.25	48	231	34		
	81C80204L24FWR16D	6584	7572	80	20	29.25	48	231	34		
	81C80244L16FR24FW	6633	7629	80	24	29.25	48	269	40		
	81C80244L16DR24FW	6633	7629	80	24	29.25	48	269	40		
81C80244L24FWR16F	6633	7629	80	24	29.25	48	269	40			
81C80244L24FWR16D	6633	7629	80	24	29.25	48	269	40			

**ORDERING NOTES:** Pricing does not include a modesty panel. To add a full height wood modesty panel add (X41 to the end of the model number, e.g. 81C88244L0R0X41. Add 7% to list price. Credenzas above 80", 88" and 96" lengths are compatible with TracDesk (see page 160). For TracDesk option please add **\$325 list** to your order and add a 'J' at the end of the model number, e.g. 81C88244L0R0J.

**DIMENSION KEY**

W - width  
D - depth  
H - height

**CODE DESCRIPTION**

L - left hand pedestal position  
R - right hand pedestal position  
D - 2 file drawer  
F - 2 box, 1 file drawer  
0 - no pedestal  
J - TracDesk option  
W - extended pedestal option  
X31 - 3/4 height recessed modesty panel  
X41 - full height recessed modesty panel

**STANDARD FINISHES**

For a complete list of standard wood finishes please see page 114.

**GROMMETS**

One wiring grommet in standard position is optional at no charge. See page 117 for more wiring grommet information.

**PULL LOCATIONS**

For details please see page 116.

# VESTRADA | CREDENZAS

Description	Model	Cherry Maple Walnut Rift Oak	Anigre	W	D	H	KW	Shipping Weight	Cubic Feet
Double Pedestal Credenza, no Modesty Panel, 24" Pedestals	81C64204L24FWR24FW 81C64244L24FWR24FW 81C72204L24FWR24FW 81C72244L24FWR24FW* 81C80204L24FWR24FW 81C80244L24FWR24FW	6610 6653 6686 6749 6780 6833	7603 7651 7687 7761 7796 7860	64 64 72 72 80 80	20 24 20 24 20 24	29.25 29.25 29.25 29.25 29.25 29.25	32 32 40 40 48 48	198 223 213 233 221 259	27 32 30 36 34 40

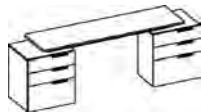

Credenza Shell, Hinged Modesty Panel	81CY64204LOR0X41 81CY64244LOR0X41 81CY62204LOR0X41 81CY72244LOR0X41 81CY80204LOR0X41 81CY80244LOR0X41* 81CY88204LOR0X41 81CY88244LOR0X41 81CY96204LOR0X41 81CY96244LOR0X41	3137 3217 3265 3393 3483 3614 3711 3829 4186 4318	3608 3701 3753 3902 4004 4156 4267 4404 4815 4967	64 64 72 72 80 80 88 88 96 96	20 24 20 24 20 24 20 24 20 24	29.25 29.25 29.25 29.25 29.25 29.25 29.25 29.25 29.25 29.25	48 48 56 56 64 64 72 72 80 80	150 176 165 194 181 211 191 226 203 239	27 32 30 36 34 40 37 43 40 47
--	---	--	--	--	--	--	--	--	--

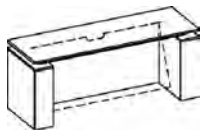

Single Pedestal Credenza, Hinged Modesty Panel, 16" Pedestal	81CY64204L16FR0X41 81CY64204LOR16FX41 81CY64204L16DR0X41 81CY64204LOR16DX41 81CY64244L16FR0X41 81CY64244LOR16FX41 81CY64244L16DR0X41 81CY64244LOR16DX41 81CY72204L16FR0X41 81CY72204LOR16FX41 81CY72204L16DR0X41 81CY72204LOR16DX41 81CY72204LOR16FX41 81CY72244L16FR0X41 81CY72244LOR16FX41*	5470 5470 5470 5470 5512 5512 5512 5512 5517 5517 5517 5517 5517 5556 5556	6290 6290 6290 6290 6337 6337 6337 6337 6346 6346 6346 6346 6346 6390 6390	64 64 64 64 64 64 64 64 72 72 72 72 72 72 72	20 20 20 20 24 24 24 24 20 20 20 20 20 24 24	29.25 29.25 29.25 29.25 29.25 29.25 29.25 29.25 29.25 29.25 29.25 29.25 29.25 29.25 29.25	40 40 40 40 40 40 40 40 48 48 48 48 48 48 48	154 154 154 154 179 179 179 179 169 169 169 169 169 198 198	27 27 27 27 32 32 32 32 30 30 30 30 30 36 36
---	---	--	--	--	--	---	--	---	--

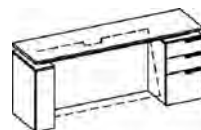

**ORDERING NOTES:**

Wire management cut-out is standard on all credenza hinged modesty panels.  
 Credenzas above in 80", 88" and 96" lengths are compatible with TracDesk (see page 160). For TracDesk option please add \$325 list to your order and add a 'J' at the end of the model number, e.g. 81C88244LOR0J.

**ORDERING PROCEDURE**

- To order, please specify the following:
- 1) Krug product model number
  - 2) Wood species and finish, see page 114
  - 3) Pull style and finish, see page 116
  - 4) V-Beam color, see page 117
  - 5) Grommet location and style if applicable

\* Indicates model illustrated by line drawing

**CODE DESCRIPTION**

- L - left hand pedestal position
- R - right hand pedestal position
- D - 2 file drawer
- F - 2 box, 1 file drawer
- 0 - no pedestal
- J - TracDesk option
- W - extended pedestal option
- X31 - 3/4 height recessed modesty panel
- X41 - full height recessed modesty panel

**STANDARD FINISHES**

For a complete list of standard wood finishes please see page 114.

**GROMMETS**

One wiring grommet in standard position is optional at no charge. See page 117 for more wiring grommet information.

**GLASS PRIVACY SCREEN**

Please see page 204 for glass privacy screen options. CASEGOODS | GSA | 165

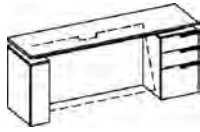

Description	Model	Cherry Maple		W	D	H	KW	Shipping Weight	Cubic Feet
		Walnut Rift Oak	Anigre						
Single Pedestal	81CY72244L16DR0X41	5556	6390	72	24	29.25	48	198	36
Credenza, Hinged	81CY72244LOR16DX41	5556	6390	72	24	29.25	48	198	36
Modesty Panel, 16"	81CY80204L16FR0X41	5568	6403	80	20	29.25	56	167	34
Pedestal Continued	81CY80204LOR16FX41	5568	6403	80	20	29.25	56	167	34
	81CY80204L16DR0X41	5568	6403	80	20	29.25	56	167	34
	81CY80204LOR16DX41	5568	6403	80	20	29.25	56	167	34
	81CY80244L16FR0X41	5590	6431	80	24	29.25	56	215	40
	81CY80244LOR16FX41	5590	6431	80	24	29.25	56	215	40
	81CY80244L16DR0X41	5590	6431	80	24	29.25	56	215	40
	81CY80244LOR16DX41	5590	6431	80	24	29.25	56	215	40
	81CY88204L16FR0X41	5603	6441	88	20	29.25	64	196	37
	81CY88204LOR16FX41	5603	6441	88	20	29.25	64	196	37
	81CY88204L16DR0X41	5603	6441	88	20	29.25	64	196	37
	81CY88204LOR16DX41	5603	6441	88	20	29.25	64	196	37
	81CY88244L16FR0X41	5629	6471	88	24	29.25	64	230	43
	81CY88244LOR16FX41	5629	6471	88	24	29.25	64	230	43
	81CY88244L16DR0X41	5629	6471	88	24	29.25	64	230	43
	81CY88244LOR16DX41	5629	6471	88	24	29.25	64	230	43
	81CY96204L16FR0X41	5640	6486	96	20	29.25	72	207	40
	81CY96204LOR16FX41	5640	6486	96	20	29.25	72	207	40
	81CY96204L16DR0X41	5640	6486	96	20	29.25	72	207	40
	81CY96204LOR16DX41	5640	6486	96	20	29.25	72	207	40
	81CY96244L16FR0X41	5656	6501	96	24	29.25	72	243	47
	81CY96244LOR16FX41	5656	6501	96	24	29.25	72	243	47
81CY96244L16DR0X41	5656	6501	96	24	29.25	72	243	47	
81CY96244LOR16DX41	5656	6501	96	24	29.25	72	243	47	

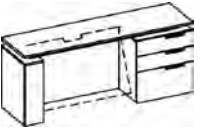
Single Pedestal	81CY64204L24FR0X41	5637	6483	64	20	29.25	32	202	27
Credenza, Hinged	81CY64204LOR24FX41	5637	6483	64	20	29.25	32	202	27
Modesty Panel, 24"	81CY64244L24FR0X41	5682	6534	64	24	29.25	32	227	32
Pedestal	81CY64244LOR24FX41	5682	6534	64	24	29.25	32	227	32
	81CY72204L24FR0X41	5689	6542	72	20	29.25	40	217	30
	81CY72204LOR24FX41	5689	6542	72	20	29.25	40	217	30
	81CY72244L24FR0X41	5726	6585	72	24	29.25	40	246	36
	81CY72244LOR24FX41*	5726	6585	72	24	29.25	40	246	36
	81CY80204L24FR0X41	5740	6602	80	20	29.25	48	215	34
	81CY80204LOR24FX41	5740	6602	80	20	29.25	48	215	34
	81CY80244L24FR0X41	5764	6628	80	24	29.25	48	263	40
	81CY80244LOR24FX41	5764	6628	80	24	29.25	48	263	40
	81CY88204L24FR0X41	5779	6644	88	20	29.25	56	244	37
	81CY88204LOR24FX41	5779	6644	88	20	29.25	56	244	37
	81CY88244L24FR0X41	5802	6673	88	24	29.25	56	278	43
	81CY88244LOR24FX41	5802	6673	88	24	29.25	56	278	43
	81CY96204L24FR0X41	5813	6686	96	20	29.25	64	255	40
	81CY96204LOR24FX41	5813	6686	96	20	29.25	64	255	40
	81CY96244L24FR0X41	5830	6706	96	24	29.25	64	291	47
	81CY96244LOR24FX41	5830	6706	96	24	29.25	64	291	47

**ORDERING NOTES:**

Wire management cut-out is standard on all credenza hinged modesty panels.  
 Credenzas above in 80", 88" and 96" lengths are compatible with TracDesk (see page 160). For TracDesk option please add \$325 list to your order and add a 'J' at the end of the model number, e.g. 81C88244LOR0J.

**DIMENSION KEY**

W - width  
 D - depth  
 H - height

**CODE DESCRIPTION**

L - left hand pedestal position  
 R - right hand pedestal position  
 D - 2 file drawer  
 F - 2 box, 1 file drawer  
 0 - no pedestal  
 J - TracDesk option  
 W - extended pedestal option  
 X31 - 3/4 height recessed modesty panel  
 X41 - full height recessed modesty panel

**STANDARD FINISHES**

For a complete list of standard wood finishes please see page 114.

**GROMMETS**

One wiring grommet in standard position is optional at no charge. See page 117 for more wiring grommet information.

**PULL LOCATIONS**

For details please see page 116.

# VESTRADA | CREDENZAS

Description	Model	Cherry		W	D	H	KW	Shipping Weight	Cubic Feet
		Maple	Walnut						
		Rift Oak	Anigre						
Single Pedestal Credenza, Hinged Modesty Panel, 32" 4 Box/1 Lateral File Pedestal	81CY72204L3205R0X41	7467	8589	72	20	29.25	32	233	30
	81CY72204L0R3205X41	7467	8589	72	20	29.25	32	233	30
	81CY72244L3205R0X41	7501	8623	72	24	29.25	32	260	36
	81CY72244L0R3205X41	7501	8623	72	24	29.25	32	260	36
	81CY80204L3205R0X41	7516	8644	80	20	29.25	40	241	34
	81CY80204L0R3205X41	7516	8644	80	20	29.25	40	241	34
	81CY80244L3205R0X41	7539	8669	80	24	29.25	40	279	40
	81CY80244L0R3205X41*	7539	8669	80	24	29.25	40	279	40
	81CY88204L3205R0X41	7553	8688	88	20	29.25	48	260	37
	81CY88204L0R3205X41	7553	8688	88	20	29.25	48	260	37
	81CY88244L3205R0X41	7577	8715	88	24	29.25	48	294	43
	81CY88244L0R3205X41	7577	8715	88	24	29.25	48	294	43
	81CY96204L3205R0X41	7591	8728	96	20	29.25	56	271	40
	81CY96204L0R3205X41	7591	8728	96	20	29.25	56	271	40
	81CY96244L3205R0X41	7607	8747	96	24	29.25	56	307	47
	81CY96244L0R3205X41	7607	8747	96	24	29.25	56	307	47
Single Pedestal Credenza, Hinged Modesty Panel, 32" Combination Pedestal	81CY72204L3202R0X41	7398	8508	72	20	29.25	32	233	30
	81CY72204L0R3204X41	7398	8508	72	20	29.25	32	233	30
	81CY72244L3202R0X41	7434	8548	72	24	29.25	32	262	36
	81CY72244L0R3204X41	7434	8548	72	24	29.25	32	260	36
	81CY80204L3202R0X41	7447	8564	80	20	29.25	40	241	34
	81CY80204L0R3204X41	7447	8564	80	20	29.25	40	241	34
	81CY80244L3202R0X41	7468	8590	80	24	29.25	40	279	40
	81CY80244L0R3204X41*	7468	8590	80	24	29.25	40	279	40
	81CY88204L3202R0X41	7484	8607	88	20	29.25	48	260	37
	81CY88204L0R3204X41	7484	8607	88	20	29.25	48	260	37
	81CY88244L3202R0X41	7508	8634	88	24	29.25	48	294	43
	81CY88244L0R3204X41	7508	8634	88	24	29.25	48	294	43
	81CY96204L3202R0X41	7520	8647	96	20	29.25	56	271	40
	81CY96204L0R3204X41	7520	8647	96	20	29.25	56	271	40
	81CY96244L3202R0X41	7532	8661	96	24	29.25	56	307	47
	81CY96244L0R3204X41	7532	8661	96	24	29.25	56	307	47
Single Pedestal Credenza, Hinged Modesty Panel, 32" Lateral File Pedestal	81CY72204L3201R0X41	7104	8167	72	20	29.25	32	233	30
	81CY72204L0R3201X41	7104	8167	72	20	29.25	32	233	30
	81CY72244L3201R0X41	7136	8207	72	24	29.25	32	262	36
	81CY72244L0R3201X41	7136	8207	72	24	29.25	32	262	36
	81CY80204L3201R0X41	7152	8224	80	20	29.25	40	241	34
	81CY80204L0R3201X41*	7152	8224	80	20	29.25	40	241	34
	81CY80244L3201R0X41	7173	8249	80	24	29.25	40	279	40
	81CY80244L0R3201X41	7173	8249	80	24	29.25	40	279	40
	81CY88204L3201R0X41	7189	8265	88	20	29.25	48	260	37
	81CY88204L0R3201X41	7189	8265	88	20	29.25	48	260	37
	81CY88244L3201R0X41	7212	8292	88	34	29.25	48	294	43
	81CY88244L0R3201X41	7212	8292	88	24	29.25	48	294	43
	81CY96204L3201R0X41	7227	8309	96	20	29.25	56	271	40
	81CY96204L0R3201X41	7227	8309	96	20	29.25	56	271	40
	81CY96244L3201R0X41	7236	8321	96	24	29.25	56	307	47
	81CY96244L0R3201X41	7236	8321	96	24	29.25	56	307	47

**ORDERING NOTES:** Credenzas above in 80", 88" and 96" lengths are compatible with TracDesk (see page 160). For TracDesk option please add \$325 list to your order and add a 'J' at the end of the model number, e.g. 81C88244L0R0J.

### ORDERING PROCEDURE

- To order, please specify the following:
- 1) Krug product model number
  - 2) Wood species and finish, see page 114
  - 3) Pull style and finish, see page 115
  - 4) V-Beam color, see page 117
  - 5) Grommet location and style if applicable

\* Indicates model illustrated by line drawing

### CODE DESCRIPTION

- L - left hand pedestal position
- R - right hand pedestal position
- D - 2 file drawer
- F - 2 box, 1 file drawer
- 0 - no pedestal
- J - TracDesk option
- W - extended pedestal option
- X31 - 3/4 height recessed modesty panel
- X41 - full height recessed modesty panel

### STANDARD FINISHES

For a complete list of standard wood finishes please see page 114.

### GROMMETS

One wiring grommet in standard position is optional at no charge. See page 117 for more wiring grommet information.

### GLASS PRIVACY SCREEN

Please see page 204 for glass privacy screen options.

Description	Model	Cherry		W	D	H	KW	Shipping Weight	Cubic Feet
		Maple Walnut Rift Oak	Anigre						
Single Pedestal Credenza, Hinged Modesty Panel, 32" Bookcase Pedestal	81CY72204L32BCR0X41	6085	6998	72	20	29.25	32	228	30
	81CY72204LOR32BCX41	6085	6998	72	20	29.25	32	228	30
	81CY72244L32BCR0X41	6119	7038	72	24	29.25	32	262	36
	81CY72244LOR32BCX41	6119	7038	72	24	29.25	32	262	36
	81CY80204L32BCR0X41	6136	7056	80	20	29.25	40	241	34
	81CY80204LOR32BCX41	6136	7056	80	20	29.25	40	241	34
	81CY80244L32BCR0X41	6158	7082	80	24	29.25	40	279	40
	81CY80244LOR32BCX41	6158	7082	80	24	29.25	40	279	40
	81CY88204L32BCR0X41	6171	7100	88	20	29.25	48	260	37
	81CY88204LOR32BCX41*	6171	7100	88	20	29.25	48	260	37
	81CY88244L32BCR0X41	6193	7124	88	24	29.25	48	294	43
	81CY88244LOR32BCX41	6193	7124	88	24	29.25	48	294	43
	81CY96204L32BCR0X41	6210	7144	96	20	29.25	56	271	40
	81CY96204LOR32BCX41	6210	7144	96	20	29.25	56	271	40
	81CY96244L32BCR0X41	6221	7154	96	24	29.25	56	307	47
	81CY96244LOR32BCX41	6221	7154	96	24	29.25	56	307	47
Single Pedestal Credenza, Hinged Modesty Panel, 36" Lateral File Pedestal	81CY72204L3601R0X41	7808	8979	72	20	29.25	28	249	30
	81CY72204LOR3601X41	7808	8979	72	20	29.25	28	249	30
	81CY72244L3601R0X41	7846	9024	72	24	29.25	28	278	36
	81CY72244LOR3601X41	7846	9024	72	24	29.25	28	278	36
	81CY80204L3601R0X41	7864	9044	80	20	29.25	36	257	34
	81CY80204LOR3601X41	7864	9044	80	20	29.25	36	257	34
	81CY80244L3601R0X41	7888	9069	80	24	29.25	36	295	40
	81CY80244LOR3601X41	7888	9069	80	24	29.25	36	295	40
	81CY88204L3601R0X41	7906	9090	88	20	29.25	44	244	37
	81CY88204LOR3601X41*	7906	9090	88	20	29.25	44	244	37
	81CY88244L3601R0X41	7928	9118	88	24	29.25	44	310	43
	81CY88244LOR3601X41	7928	9118	88	24	29.25	44	310	43
	81CY96204L3601R0X41	7945	9139	96	20	29.25	52	287	40
	81CY96204LOR3601X41	7945	9139	96	20	29.25	52	287	40
	81CY96244L3601R0X41	7956	9150	96	24	29.25	52	323	47
	81CY96244LOR3601X41	7956	9150	96	24	29.25	52	323	47
Single Pedestal Credenza, Hinged Modesty Panel, 36" Bookcase Pedestal	81CY72204L36BCR0X41	6683	7683	72	20	29.25	28	244	30
	81CY72204LOR36BCX41	6683	7683	72	20	29.25	28	244	30
	81CY72244L36BCR0X41	6718	7730	72	24	29.25	28	273	36
	81CY72244LOR36BCX41	6718	7730	72	24	29.25	28	273	36
	81CY80204L36BCR0X41	6736	7749	80	20	29.25	36	252	34
	81CY80204LOR36BCX41	6736	7749	80	20	29.25	36	252	34
	81CY80244L36BCR0X41	6760	7774	80	24	29.25	36	290	40
	81CY80244LOR36BCX41	6760	7774	80	24	29.25	36	290	40
	81CY88204L36BCR0X41	6778	7793	88	20	29.25	44	239	37
	81CY88204LOR36BCX41	6778	7793	88	20	29.25	44	239	37
	81CY88244L36BCR0X41	6804	7822	88	24	29.25	44	305	43
	81CY88244LOR36BCX41*	6804	7822	88	24	29.25	44	305	43
	81CY96204L36BCR0X41	6818	7839	96	20	29.25	52	282	40
	81CY96204LOR36BCX41	6818	7839	96	20	29.25	52	282	40
	81CY96244L36BCR0X41	6832	7858	96	24	29.25	52	318	47
	81CY96244LOR36BCX41	6832	7858	96	24	29.25	52	318	47

**ORDERING NOTES:** Wire management cut-out is standard on all credenza hinged modesty panels. Credenzas above in 80", 88" and 96" lengths are compatible with TracDesk (see page 160). For TracDesk option please add \$325 list to your order and add a 'J' at the end of the model number, e.g. 81C88244LOR0J.

**DIMENSION KEY**

W - width  
D - depth  
H - height

**CODE DESCRIPTION**

L - left hand pedestal position  
R - right hand pedestal position  
D - 2 file drawer  
F - 2 box, 1 file drawer  
0 - no pedestal  
J - TracDesk option  
W - extended pedestal option  
X31 - 3/4 height recessed modesty panel  
X41 - full height recessed modesty panel

**STANDARD FINISHES**

For a complete list of standard wood finishes please see page 114.

**GROMMETS**

One wiring grommet in standard position is optional at no charge. See page 117 for more wiring grommet information.

**PULL LOCATIONS**

For details please see page 116.

# VESTRADA | CREDENZAS

Description	Model	Cherry		W	D	H	KW	Shipping Weight	Cubic Feet
		Maple Walnut Rift Oak	Anigre						
Double Pedestal Credenza, Hinged Modesty Panel, 16" Pedestals	81CY64204L16DR16DX41	5995	6895	64	20	29.25	32	192	27
	81CY64204L16DR16FX41	5995	6895	64	20	29.25	32	192	27
	81CY64204L16FR16DX41	5995	6895	64	20	29.25	32	192	27
	81CY64204L16FR16FX41	5995	6895	64	20	29.25	32	192	27
	81CY64244L16DR16DX41	6115	7033	64	24	29.25	48	217	32
	81CY64244L16DR16FX41	6115	7033	64	24	29.25	48	217	32
	81CY64244L16FR16DX41	6115	7033	64	24	29.25	48	217	32
	81CY64244L16FR16FX41	6115	7033	64	24	29.25	48	217	32
	81CY72204L16DR16DX41	6232	7166	72	20	29.25	32	207	30
	81CY72204L16DR16FX41	6232	7166	72	20	29.25	32	207	30
	81CY72204L16FR16DX41	6232	7166	72	20	29.25	32	207	30
	81CY72204L16FR16FX41	6232	7166	72	20	29.25	32	207	30
	81CY72244L16DR16DX41	6389	7346	72	24	29.25	56	236	36
	81CY72244L16DR16FX41*	6389	7346	72	24	29.25	56	236	36
	81CY72244L16FR16DX41	6389	7346	72	24	29.25	56	236	36
	81CY72244L16FR16FX41	6389	7346	72	24	29.25	56	236	36
	81CY80204L16DR16DX41	6534	7513	80	20	29.25	40	215	34
	81CY80204L16DR16FX41	6534	7513	80	20	29.25	40	215	34
	81CY80204L16FR16DX41	6534	7513	80	20	29.25	40	215	34
	81CY80204L16FR16FX41	6534	7513	80	20	29.25	40	215	34
	81CY80244L16DR16DX41	6594	7581	80	24	29.25	56	253	40
	81CY80244L16DR16FX41	6594	7581	80	24	29.25	56	253	40
	81CY80244L16FR16DX41	6594	7581	80	24	29.25	56	253	40
	81CY80244L16FR16FX41	6594	7581	80	24	29.25	56	253	40
	81CY88204L16DR16DX41	6662	7660	88	20	29.25	40	234	37
	81CY88204L16DR16FX41	6662	7660	88	20	29.25	40	234	37
	81CY88204L16FR16DX41	6662	7660	88	20	29.25	40	234	37
	81CY88204L16FR16FX41	6662	7660	88	20	29.25	40	234	37
	81CY88244L16DR16DX41	6693	7699	88	24	29.25	64	268	43
	81CY88244L16DR16FX41	6693	7699	88	24	29.25	64	268	43
	81CY88244L16FR16DX41	6693	7699	88	24	29.25	64	268	43
	81CY88244L16FR16FX41	6693	7699	88	24	29.25	64	268	43
	81CY96204L16DR16DX41	6723	7733	96	20	29.25	48	245	40
	81CY96204L16DR16FX41	6723	7733	96	20	29.25	48	245	40
	81CY96204L16FR16DX41	6723	7733	96	20	29.25	48	245	40
	81CY96204L16FR16FX41	6723	7733	96	20	29.25	48	245	40
	81CY96244L16DR16DX41	6772	7789	96	24	29.25	64	281	47
	81CY96244L16DR16FX41	6772	7789	96	24	29.25	64	281	47
	81CY96244L16FR16DX41	6772	7789	96	24	29.25	64	281	47
	81CY96244L16FR16FX41	6772	7789	96	24	29.25	64	281	47
Double Pedestal Credenza, Hinged Modesty Panel, 24" Pedestals	81CY64204L24FWR24FWX41	7755	8916	64	20	29.25	32	198	27
	81CY64244L24FWR24FWX41	7793	8964	64	24	29.25	48	223	32
	81CY72204L24FWR24FWX41	7799	8969	72	20	29.25	32	213	30
	81CY72244L24FWR24FWX41	7836	9011	72	24	29.25	48	233	36
	81CY80204L24FWR24FWX41	7845	9023	80	20	29.25	40	221	34
	81CY80244L24FWR24FWX41*	7866	9046	80	24	29.25	56	259	40
	81CY88204L24FWR24FWX41	7883	9066	88	20	29.25	40	240	37
	81CY88244L24FWR24FWX41	7906	9090	88	24	29.25	56	274	43

**ORDERING NOTES:** Wire management cut-out is standard on all credenza hinged modesty panels. Credenzas above in 80", 88" and 96" lengths are compatible with TracDesk (see page 106). For TracDesk option please add **\$325 list** to your order and add a 'J' at the end of the model number, e.g. 81C88244L0R0J.

**ORDERING PROCEDURE**

- To order, please specify the following:
- 1) Krug product model number
  - 2) Wood species and finish, see page 114
  - 3) Pull style and finish, see page 116
  - 4) V-Beam color, see page 117
  - 5) Grommet location and style if applicable

\* Indicates model illustrated by line drawing

**CODE DESCRIPTION**

- L - left hand pedestal position
- R - right hand pedestal position
- D - 2 file drawer
- F - 2 box, 1 file drawer
- 0 - no pedestal
- J - TracDesk option
- W - extended pedestal option
- X31 - 3/4 height recessed modesty panel
- X41 - full height recessed modesty panel

**STANDARD FINISHES**

For a complete list of standard wood finishes please see page 114.



**GROMMETS**

One wiring grommet in standard position is optional at no charge. See page 117 for more wiring grommet information.

**GLASS PRIVACY SCREEN**

Please see page 204 for glass privacy screen options.

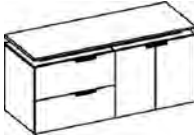
# VESTRADA | FULL FACE CREDENZAS

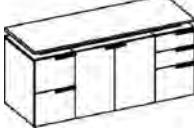
Description	Model	Cherry Maple		W	D	H	Shipping Weight	Cubic Feet
		Walnut Rift Oak	Anigre					
 2 Segment Full Face Credenza, Lateral File & Bookcase Pedestals	81C642040101	6821	7844	64	20	29.25	238	27
	81C6420401BC	6228	7162	64	20	29.25	218	27
	81C64204BCBC	5272	6060	64	20	29.25	198	27
	81C64204BC01	6228	7162	64	20	29.25	218	27
	81C642440101	7131	8203	64	24	29.25	246	32
	81C6424401BC	6496	7468	64	24	29.25	226	32
	81C64244BCBC	5482	6304	64	24	29.25	214	32
	81C64244BC01	6496	7468	64	24	29.25	226	32
	81C722040101	7234	8318	72	20	29.25	248	30
	81C7220401BC*	6598	7586	72	20	29.25	228	30
	81C72204BCBC	5616	6462	72	20	29.25	208	30
	81C72204BC01	6598	7586	72	20	29.25	228	30
	81C722440101	7327	8425	72	24	29.25	256	36
	81C7224401BC	6722	7732	72	24	29.25	236	36
	81C72244BCBC	5696	6553	72	24	29.25	224	36
81C72244BC01	6722	7732	72	24	29.25	236	36	
 3 Segment Full Face Credenza, 2 Box/ 1 File, Lateral File, 2 File Pedestals	81C64204F01D	6676	7677	64	20	29.25	264	27
	81C64204F01F	6676	7677	64	20	29.25	264	27
	81C64204D01D	6676	7677	64	20	29.25	264	27
	81C64204D01F	6676	7677	64	20	29.25	264	27
	81C64204D01F	6676	7677	64	20	29.25	264	27
	81C64244F01D	6805	7824	64	24	29.25	291	32
	81C64244F01F*	6805	7824	64	24	29.25	291	32
	81C64244D01D	6805	7824	64	24	29.25	291	32
	81C64244D01F	6805	7824	64	24	29.25	291	32
 3 Segment Full Face Credenza, 2 Box/ 1 File, Bookcase, 2 File Pedestals	81C64204FBCD	6181	7107	64	20	29.25	264	27
	81C64204FBCF	6181	7107	64	20	29.25	264	27
	81C64204DBC	6181	7107	64	20	29.25	264	27
	81C64204DBCD	6181	7107	64	20	29.25	264	27
	81C64244FBCD	6298	7243	64	24	29.25	291	32
	81C64244FBCF	6298	7243	64	24	29.25	291	32
	81C64244DBC*	6298	7243	64	24	29.25	291	32
	81C64244DBCD	6298	7243	64	24	29.25	291	32
	81C72204FBCD	6347	7298	72	20	29.25	271	30
	81C72204FBCF	6347	7298	72	20	29.25	271	30
	81C72204DBC	6347	7298	72	20	29.25	271	30
	81C72204DBCD	6347	7298	72	20	29.25	271	30
	81C72244FBCD	6528	7506	72	24	29.25	303	36
	81C72244FBCF	6528	7506	72	24	29.25	303	36
	81C72244DBC	6528	7506	72	24	29.25	303	36
81C72244DBCD	6528	7506	72	24	29.25	303	36	

**DIMENSION KEY**

W - width  
 D - depth  
 H - height

**CODE DESCRIPTION**

L - left hand pedestal position  
 R - right hand pedestal position  
 D - 2 file drawer  
 F - 2 box, 1 file drawer  
 01 - lateral file drawer  
 05 - 4 box, 1 lateral file  
 BC - bookcase pedestal

**STANDARD FINISHES**

For a complete list of standard wood finishes please see page 114.

**GROMMETS**

One wiring grommet in standard position is optional at no charge. See page 117 for more wiring grommet information.

**PULL LOCATIONS**

For details please see page 116.

# VESTRADA | FULL FACE CREDENZAS

Description	Model	Cherry		W	D	H	Shipping Weight	Cubic Feet
		Maple	Walnut					
		Rift Oak	Anigre					
2 Segment Full Face Credenza, Lateral	81C642040501	7225	8308	64	20	29.25	204	27
File & 4 Box/ 1 Lateral File	81C642040505	7225	8308	64	20	29.25	204	27
Pedestals	81C642440105	7536	8667	64	24	29.25	271	32
	81C642440105	7536	8667	64	24	29.25	271	32
	81C642440505	7536	8667	64	24	29.25	214	32

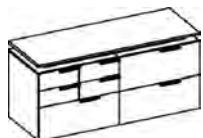

3 Segment Full Face Credenza, Lateral	81C8020401BCBC	7988	9187	80	20	29.25	278	34
File & Bookcase	81C80204BCBC01*	7988	9187	80	20	29.25	278	34
Pedestals	81C8024401BCBC	8360	9614	80	24	29.25	315	40
	81C80244BCBC01	8360	9614	80	24	29.25	315	40

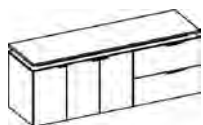

3 Segment Full Face Credenza, Bookcase Pedestal	81C80204BCBCBC	7031	8085	80	20	29.25	208	30
	81C80244BCBCBC*	7245	8334	80	24	29.25	208	30



3 Segment Full Face Credenza, Lateral	81C96204010101	10219	11750	96	20	29.25	357	40
File & Bookcase	81C96204BC01BC	8894	10228	96	20	29.25	357	40
Pedestals	81C96244010101	9462	10882	96	20	29.25	357	40
	81C96244010101	10554	12139	96	24	29.25	369	47
	81C96244BC01BC	9186	10564	96	24	29.25	369	47
	81C9624401BC01	9772	11239	96	24	29.25	369	47



## ORDERING PROCEDURE

To order, please specify the following:

- 1) Krug product model number
- 2) Wood species and finish, see page 114
- 3) Pull style and finish, see page 116
- 4) V-Beam color, see page 117
- 5) Grommet location and style if applicable

\* Indicates model illustrated by line drawing

## CODE DESCRIPTION

L - left hand pedestal position  
 R - right hand pedestal position  
 D - 2 file drawer  
 F - 2 box, 1 file drawer  
 O - no pedestal  
 J - TracDesk option  
 W - extended pedestal option  
 X31 - 3/4 height recessed modesty panel  
 X41 - full height recessed modesty panel

## STANDARD FINISHES

For a complete list of standard wood finishes please see page 114.

## GROMMETS

One wiring grommet in standard position is optional at no charge. See page 117 for more wiring grommet information.

## GLASS PRIVACY SCREEN

Please see page 204 for glass privacy screen options.

CASEGOODS | GSA | 171

# VESTRADA | CORNER CREDENZAS

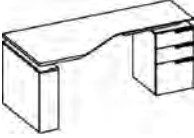
Description	Model	Cherry		W	D	H	KW	Shipping Weight	Cubic Feet
		Maple Walnut Rift Oak	Anigre						
Corner Credenza Shell, no Modesty Panel 	81CC6432-20-R20L0	2963	3408	64	32	29.25	48	128	42
	81CC6432-20-L20R0	2963	3408	64	32	29.25	48	128	42
	81CC6432-20-R24L0	2963	3408	64	32	29.25	48	128	42
	81CC6432-20-L24R0	2963	3408	64	32	29.25	48	128	42
	81CC6436-24-R20L0	3001	3453	64	36	29.25	48	153	47
	81CC6436-24-L20R0	3001	3453	64	36	29.25	32	153	47
	81CC6436-24-R24L0	3001	3453	64	36	29.25	48	153	47
	81CC6436-24-L24R0	3001	3453	64	36	29.25	48	153	47
	81CC7232-20-R20L0	3013	3463	64	32	29.25	56	143	48
	81CC7232-20-L20R0*	3013	3463	72	32	29.25	56	143	48
	81CC7232-20-R24L0	3013	3463	72	32	29.25	56	143	48
	81CC7232-20-L24R0	3013	3463	72	32	29.25	56	143	48
	81CC7236-24-R20L0	3037	3493	72	36	29.25	56	172	52
	81CC7236-24-L20R0	3037	3493	72	36	29.25	56	172	52
	81CC7236-24-R24L0	3037	3493	72	36	29.25	56	172	52
	81CC7236-24-L24R0	3037	3493	72	36	29.25	56	172	52
	81CC8032-20-R20L0	3045	3501	80	32	29.25	64	141	52
	81CC8032-20-L20R0	3045	3501	80	32	29.25	64	141	52
	81CC8032-20-R24L0	3045	3501	80	32	29.25	64	141	52
	81CC8032-20-L24R0	3045	3501	80	32	29.25	64	141	52
81CC8036-24-R20L0	3106	3575	80	36	29.25	64	189	58	
81CC8036-24-L20R0	3106	3575	80	36	29.25	64	189	58	
81CC8036-24-R24L0	3106	3575	80	36	29.25	64	189	58	
81CC8036-24-L24R0	3106	3575	80	36	29.25	64	189	58	
Corner Credenza, no Modesty Panel, 16" Pedestal 	81CC6432-20-R20L16F*	3865	4443	64	32	29.25	40	160	27
	81CC6432-20-L20R16F	3865	4443	64	32	29.25	40	160	27
	81CC6432-20-R20L16D	3865	4443	64	32	29.25	40	160	27
	81CC6432-20-L20R16D	3865	4443	64	32	29.25	40	160	27
	81CC6432-20-R24L16F	3865	4443	64	32	29.25	40	160	27
	81CC6432-20-L24R16F	3865	4443	64	32	29.25	40	160	27
	81CC6432-20-R24L16D	3865	4443	64	32	29.25	40	160	27
	81CC6432-20-L24R16D	3865	4443	64	32	29.25	40	160	27
	81CC6436-24-R20L16F	3921	4510	64	36	29.25	40	185	32
	81CC6436-24-L20R16F	3921	4510	64	36	29.25	40	185	32
	81CC6436-24-R20L16D	3921	4510	64	36	29.25	40	185	32
	81CC6436-24-L20R16D	3921	4510	64	36	29.25	40	185	32
	81CC6436-24-R24L16F	3921	4510	64	36	29.25	40	185	32
	81CC6436-24-L24R16F	3921	4510	64	36	29.25	40	185	32
	81CC6436-24-R24L16D	3921	4510	64	36	29.25	40	185	32
	81CC6436-24-L24R16D	3921	4510	64	36	29.25	40	185	32
	81CC7232-20-R20L16F	3932	4524	72	32	29.25	48	175	30
	81CC7232-20-L20R16F	3932	4524	72	32	29.25	48	175	30
	81CC7232-20-R20L16D	3932	4524	72	32	29.25	48	175	30
	81CC7232-20-L20R16D	3932	4524	72	32	29.25	48	175	30
81CC7232-20-R24L16F	3932	4524	72	32	29.25	48	175	30	
81CC7232-20-L24R16F	3932	4524	72	32	29.25	48	175	30	
81CC7232-20-R24L16D	3932	4524	72	32	29.25	48	175	30	
81CC7232-20-L24R16D	3932	4524	72	32	29.25	48	175	30	

**ORDERING NOTES:**

The first dimension after the second "-" indicates connecting side dimensions, e.g. 81CC8036-24-L20R0 has a 20" connecting side

**DIMENSION KEY**

W - width  
D - depth  
H - height

**CODE DESCRIPTION**

L - left hand pedestal position  
R - right hand pedestal position  
D - 2 file drawer  
F - 2 box, 1 file drawer  
0 - no pedestal  
J - TracDesk option  
W - extended pedestal option  
X31 - 3/4 height recessed modesty panel  
X41 - full height recessed modesty panel

**STANDARD FINISHES**

For a complete list of standard wood finishes please see page 114.

**GROMMETS**

One wiring grommet in standard position is optional at no charge. See page 117 for more wiring grommet information.

**PULL LOCATIONS**

For details please see page 116.

# VESTRADA | CORNER CREDENZAS

Description	Model	Cherry Maple		W	D	H	KW	Shipping Weight	Cubic Feet
		Walnut Rift Oak	Anigre						
Corner Credenza, no Modesty Panel, 16" Pedestal Continued 	81CC7236-24-R20L16F	4021	4622	72	36	29.25	48	204	36
	81CC7236-24-L20R16F	4021	4622	72	36	29.25	48	204	36
	81CC7236-24-R20L16D	4021	4622	72	36	29.25	48	204	36
	81CC7236-24-L20R16D	4021	4622	72	36	29.25	48	204	36
	81CC7236-24-R24L16F	4021	4622	72	36	29.25	48	204	36
	81CC7236-24-L24R16F	4021	4622	72	36	29.25	48	204	36
	81CC7236-24-R24L16D	4021	4622	72	36	29.25	48	204	36
	81CC7236-24-L24R16D	4021	4622	72	36	29.25	48	204	36
	81CC8032-20-R20L16F	4223	4859	80	32	29.25	56	173	34
	81CC8032-20-L20R16F	4223	4859	80	32	29.25	56	173	34
	81CC8032-20-R20L16D	4223	4859	80	32	29.25	56	173	34
	81CC8032-20-L20R16D	4223	4859	80	32	29.25	56	173	34
	81CC8032-20-R24L16F	4223	4859	80	32	29.25	56	173	34
	81CC8032-20-L24R16F	4223	4859	80	32	29.25	56	173	34
	81CC8032-20-R24L16D	4223	4859	80	32	29.25	56	173	34
	81CC8032-20-L24R16D	4223	4859	80	32	29.25	56	173	34
	81CC8036-24-R20L16F	4259	4897	80	36	29.25	56	221	40
	81CC8036-24-L20R16F	4259	4897	80	36	29.25	56	221	40
	81CC8036-24-R20L16D	4259	4897	80	36	29.25	56	221	40
	81CC8036-24-L20R16D	4259	4897	80	36	29.25	56	221	40
81CC8036-24-R24L16F	4259	4897	80	36	29.25	56	221	40	
81CC8036-24-L24R16F	4259	4897	80	36	29.25	56	221	40	
81CC8036-24-R24L16D	4259	4897	80	36	29.25	56	221	40	
81CC8036-24-L24R16D	4259	4897	80	36	29.25	56	221	40	

**ORDERING NOTES:**

The first dimension after the second "-" indicates connecting side dimensions, e.g. 81CC8036-24-L20R0 has a 20" connecting side

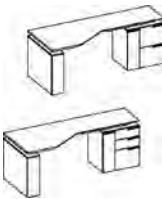
Corner Credenza, no Modesty Panel, 24" 2 Box/1 File or 2 File with V-Ped Pedestal 	81CC8032-20-R20L24FQ	5863	6742	80	32	29.25	48	189	34
	81CC8032-20-R20L24DQ	5863	6742	80	32	29.25	48	189	34
	81CC8032-20-L20R24FQ*	5863	6742	80	32	29.25	48	189	34
	81CC8032-20-L20R24DQ	5863	6742	80	32	29.25	48	189	34
	81CC8032-20-R24L24FQ	5863	6742	80	32	29.25	48	189	34
	81CC8032-20-R24L24DQ	5863	6742	80	32	29.25	48	189	34
	81CC8032-20-L24R24FQ	5863	6742	80	32	29.25	48	189	34
	81CC8032-20-L24R24DQ	5863	6742	80	32	29.25	48	189	34
	81CC8036-24-R20L24FQ	5897	6784	80	36	29.25	48	237	40
	81CC8036-24-R20L24DQ	5897	6784	80	36	29.25	48	237	40
	81CC8036-24-L20R24FQ	5897	6784	80	36	29.25	48	237	40
	81CC8036-24-L20R24DQ	5897	6784	80	36	29.25	48	237	40
	81CC8036-24-R24L24FQ	5897	6784	80	36	29.25	48	237	40
	81CC8036-24-R24L24DQ	5897	6784	80	36	29.25	48	237	40
	81CC8036-24-L24R24FQ	5897	6784	80	36	29.25	48	237	40
	81CC8036-24-L24R24DQ	5897	6784	80	36	29.25	48	237	40

**ORDERING NOTES:**

Wire management cut-outs are standard on all corner credenza modesty panels. The first dimension listed after the second "-" indicates connecting side dimensions, e.g. 81CC8036-24-L20R0 has a 20" connecting side.

Please note 24" BBF or FF/V-Ped is one component. V-Ped is always towards kneespace and is not available for field installation. Corner Credenzas with V-Peds are NOT available on KrugExpress.

**ORDERING PROCEDURE**

To order, please specify the following:

- 1) Krug product model number
- 2) Wood species and finish, see page 114
- 3) Pull style and finish, see page 115
- 4) V-Beam color, see page 117
- 5) Grommet location and style if applicable

\* Indicates model illustrated by line drawing

**CODE DESCRIPTION**

- L - left hand pedestal position
- R - right hand pedestal position
- D - 2 file drawer
- F - 2 box, 1 file drawer
- 0 - no pedestal
- J - TracDesk option
- W - extended pedestal option

**STANDARD FINISHES**

For a complete list of standard wood finishes please see page 114.

**GROMMETS**



One wiring grommet in standard position is optional at no charge. See page 117 for more wiring grommet information.

**GLASS PRIVACY SCREEN**

Please see page 204 for glass privacy screen options.

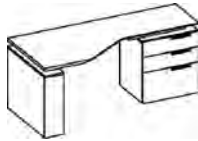

# VESTRADA | CORNER CREDENZAS

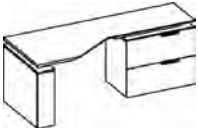
Description	Model	Cherry Maple Walnut		W	D	H	KW	Shipping Weight	Cubic Feet	
		Rift Oak	Anigre							
	Corner Credenza, no Modesty Panel, 24"	81CC7232-20-R20L24F	4244	4882	72	32	29.25	40	191	30
	81CC7232-20-L20R24F*	4244	4882	72	32	29.25	40	191	30	
	2 Box/1 File	81CC7232-20-R24L24F	4244	4882	72	32	29.25	40	191	30
	Pedestal	81CC7232-20-L24R24F	4244	4882	72	32	29.25	40	191	30
	81CC7236-24-R20L24F	4341	4994	72	36	29.25	40	220	36	
	81CC7236-24-L20R24F	4341	4994	72	36	29.25	40	220	36	
	81CC7236-24-R24L24F	4341	4994	72	36	29.25	40	220	36	
	81CC7236-24-L24R24F	4341	4994	72	36	29.25	40	220	36	
	81CC8032-20-R20L24F	4353	5007	80	32	29.25	48	189	34	
	81CC8032-20-L20R24F	4353	5007	80	32	29.25	48	189	34	
	81CC8032-20-R24L24F	4353	5007	80	32	29.25	48	189	34	
	81CC8032-20-L24R24F	4353	5007	80	32	29.25	48	189	34	
	81CC8036-24-R20L24F	4389	5045	80	36	29.25	48	237	40	
	81CC8036-24-L20R24F	4389	5045	80	36	29.25	48	237	40	
	81CC8036-24-R24L24F	4389	5045	80	36	29.25	48	237	40	
81CC8036-24-L24R24F	4389	5045	80	36	29.25	48	237	40		
 	Corner Credenza, no Modesty Panel, 32" 2 Box/1 File, V-Ped Pedestal	81CC8032-20-R20L32FQ	5992	6891	80	32	29.25	40	215	34
	81CC8032-20-L20R32FQ*	5992	6891	80	32	29.25	40	215	34	
	81CC8032-20-R24L32FQ	5992	6891	80	32	29.25	40	215	34	
	81CC8032-20-L24R32FQ	5992	6891	80	32	29.25	40	215	34	
	81CC8036-24-R20L32FQ	6028	6930	80	36	29.25	40	253	40	
	81CC8036-24-L20R32FQ	6028	6930	80	36	29.25	40	253	40	
	81CC8036-24-R24L32FQ	6028	6930	80	36	29.25	40	253	40	
	81CC8036-24-L24R32FQ	6028	6930	80	36	29.25	40	253	40	
	Corner Credenza, no Modesty Panel, 32" Lateral File Pedestal	81CC8032-20-R20L3201	5756	6619	80	32	29.25	40	210	34
	81CC8032-20-L20R3201*	5756	6619	80	32	29.25	40	210	34	
	81CC8032-20-R24L3201	5756	6619	80	32	29.25	40	210	34	
	81CC8032-20-L24R3201	5756	6619	80	32	29.25	40	210	34	
	81CC8036-24-R20L3201	5838	6714	80	36	29.25	40	248	40	
	81CC8036-24-L20R3201	5838	6714	80	36	29.25	40	248	40	
	81CC8036-24-R24L3201	5838	6714	80	36	29.25	40	248	40	
81CC8036-24-L24R3201	5838	6714	80	36	29.25	40	248	40		

**ORDERING NOTES:** Wire management cut-outs are standard on all corner credenza modesty panels. The first dimension listed after the second "-" indicates connecting side dimensions, e.g. 81CC8036-24-L20R0 has a 20" connecting side. Please note 24" BBF or FF/V-Ped is one component. V-Ped is always towards kneespace and is not available for field installation. Corner Credenzas with V-Peds are NOT available on KrugExpress.

<p><b>DIMENSION KEY</b></p> <p>W - width D - depth H - height</p>	<p><b>CODE DESCRIPTION</b></p> <p>L - left hand pedestal position R - right hand pedestal position D - 2 file drawer F - 2 box, 1 file drawer 0 - no pedestal J - TracDesk option W - extended pedestal option X31 - 3/4 height recessed modesty panel X41 - full height recessed modesty panel</p>	<p><b>STANDARD FINISHES</b></p> <p>For a complete list of standard wood finishes please see page 114.</p> <p><b>GROMMETS</b></p> <p>One wiring grommet in standard position is optional at no charge. See page 117 for more wiring grommet information.</p> <p><b>PULL LOCATIONS</b></p> <p>For details please see page 116.</p>
---	---	--

# VESTRADA | CREDENZAS

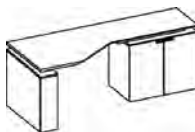
Description	Model	Cherry		W	D	H	KW	Shipping Weight	Cubic Feet
		Maple	Walnut						
		Rift Oak	Anigre						
Corner Credenza, no Modesty Panel, 32" Bookcase Pedestal 	81CC8032-20-R20L32BC	5241	6028	80	32	29.25	40	210	34
	81CC8032-20-L20R32BC*	5241	6028	80	32	29.25	40	210	34
	81CC8032-20-R24L32BC	5241	6028	80	32	29.25	40	210	34
	81CC8032-20-L24R32BC	5241	6028	80	32	29.25	40	210	34
	81CC8036-24-R20L32BC	5241	6028	80	36	29.25	40	248	40
	81CC8036-24-L20R32BC	5241	6028	80	36	29.25	40	248	40
	81CC8036-24-R24L32BC	5241	6028	80	36	29.25	40	248	40
	81CC8036-24-L24R32BC	5241	6028	80	36	29.25	40	248	40

Corner Credenza, no Modesty Panel, 32" 2 File, V-Ped Pedestal 	81CC8032-20-R20L32DQ	5992	6891	80	32	29.25	40	215	34
	81CC8032-20-L20R32DQ*	5992	6891	80	32	29.25	40	215	34
	81CC8032-20-R24L32DQ	5992	6891	80	32	29.25	40	215	34
	81CC8032-20-L24R32DQ	5992	6891	80	32	29.25	40	215	34
	81CC8036-24-R20L32DQ	6028	6930	80	36	29.25	40	253	40
	81CC8036-24-L20R32DQ	6028	6930	80	36	29.25	40	253	40
	81CC8036-24-R24L32DQ	6028	6930	80	36	29.25	40	253	40
	81CC8036-24-L24R32DQ	6028	6930	80	36	29.25	40	253	40

**ORDERING NOTES:**

Wire management cut-outs are standard on all corner credenza modesty panels. The first dimension listed after the second "-" indicates connecting side dimensions, e.g. 81CC8036-24-L20R0 has a 20" connecting side. Please note 24" BBF or FF/V-Ped is one component. V-Ped is always towards kneespace and is not available for field installation. Corner Credenzas with V-Peds are NOT available on KrugExpress.

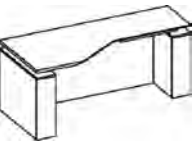
Corner Credenza Shell, Fixed Modesty Panel 	81CC6432-20-R20L0X41	3188	3668	64	32	29.25	48	154	27
	81CC6432-20-L20R0X41	3188	3668	64	32	29.25	48	154	27
	81CC6432-20-R24L0X41	3188	3668	64	32	29.25	48	154	27
	81CC6432-20-L24R0X41	3188	3668	64	32	29.25	48	154	27
	81CC6436-24-R20L0X41	3223	3709	64	36	29.25	48	179	32
	81CC6436-24-L20R0X41	3223	3709	64	36	29.25	48	179	32
	81CC6436-24-R24L0X41	3223	3709	64	36	29.25	48	179	32
	81CC6436-24-L24R0X41	3223	3709	64	36	29.25	48	179	32
	81CC7232-20-R20L0X41	3241	3727	72	32	29.25	56	169	30
	81CC7232-20-L20R0X41*	3241	3727	72	32	29.25	56	169	30
	81CC7232-20-R24L0X41	3241	3727	72	32	29.25	56	169	30
	81CC7232-20-L24R0X41	3241	3727	72	32	29.25	56	169	30
	81CC7236-24-L20R0X41	3265	3753	72	36	29.25	56	198	36
	81CC7236-24-R20L0X41	3265	3753	72	36	29.25	56	198	36
	81CC7236-24-R24L0X41	3265	3753	72	36	29.25	56	198	36
	81CC7236-24-L24R0X41	3265	3753	72	36	29.25	56	198	36
	81CC8032-20-R20L0X41	3277	3767	80	32	29.25	64	167	34
	81CC8032-20-L20R0X41	3277	3767	80	32	29.25	64	167	34
	81CC8032-20-R24L0X41	3277	3767	80	32	29.25	64	167	34
	81CC8032-20-L24R0X41	3277	3767	80	32	29.25	64	167	34
	81CC8036-24-R20L0X41	3342	3844	80	36	29.25	64	215	40
	81CC8036-24-L20R0X41	3342	3844	80	36	29.25	64	215	40
	81CC8036-24-R24L0X41	3342	3844	80	36	29.25	64	215	40
	81CC8036-24-L24R0X41	3342	3844	80	36	29.25	64	215	40

**ORDERING PROCEDURE**

- To order, please specify the following:
- 1) Krug product model number
  - 2) Wood species and finish, see page 114
  - 3) Pull style and finish, see page 116
  - 4) V-Beam color, see page 117
  - 5) Grommet location and style if applicable

\* Indicates model illustrated by line drawing

**CODE DESCRIPTION**

- L - left hand pedestal position
- R - right hand pedestal position
- D - 2 file drawer
- F - 2 box, 1 file drawer
- 0 - no pedestal
- J - TracDesk option
- W - extended pedestal option
- X31 - 3/4 height recessed modesty panel
- X41 - full height recessed modesty panel

**STANDARD FINISHES**

For a complete list of standard wood finishes please see page 114.

**GROMMETS**

One wiring grommet in standard position is optional at no charge. See page 117 for more wiring grommet information.

**GLASS PRIVACY SCREEN**

Please see page 204 for glass privacy screen options. CASEGOODS | GSA | 175

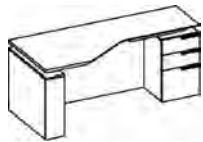
Description	Model	Cherry		W	D	H	KW	Shipping Weight	Cubic Feet
		Maple Walnut Rift Oak	Anigre						
Corner Credenza,	81CC6432-20-R20L16FX41	4155	4780	64	32	29.25	40	186	27
Fixed Modesty	81CC6432-20-R20L16DX41	4155	4780	64	32	29.25	40	186	27
Panel, 16"	81CC6432-20-L20R16FX41*	4155	4780	64	32	29.25	40	186	27
Pedestal	81CC6432-20-L20R16DX41	4155	4780	64	32	29.25	40	186	27
	81CC6432-20-R24L16FX41	4155	4780	64	32	29.25	40	186	27
	81CC6432-20-R24L16DX41	4155	4780	64	32	29.25	40	186	27
	81CC6432-20-L24R16FX41	4155	4780	64	32	29.25	40	186	27
	81CC6432-20-L24R16DX41	4155	4780	64	32	29.25	40	186	27
	81CC6436-24-R20L16FX41	4216	4847	64	36	29.25	40	201	32
	81CC6436-20-R20L16DX41	4216	4847	64	36	29.25	40	201	32
	81CC6436-24-L20R16FX41	4216	4847	64	36	29.25	40	201	32
	81CC6436-20-L20R16DX41	4216	4847	64	36	29.25	40	201	32
	81CC6436-24-R24L16FX41	4216	4847	64	36	29.25	40	201	32
	81CC6436-24-R24L16DX41	4216	4847	64	36	29.25	40	201	32
	81CC6436-24-L24R16FX41	4216	4847	64	36	29.25	40	201	32
	81CC6436-24-L24R16DX41	4216	4847	64	36	29.25	40	201	32
	81CC7232-20-R20L16FX41	4227	4861	72	32	29.25	48	191	30
	81CC7232-20-R20L16DX41	4227	4861	72	32	29.25	48	191	30
	81CC7232-20-L20R16FX41	4227	4861	72	32	29.25	48	191	30
	81CC7232-20-L20R16DX41	4227	4861	72	32	29.25	48	191	30
	81CC7232-20-R24L16FX41	4227	4861	72	32	29.25	48	191	30
	81CC7232-20-L24R16FX41	4227	4861	72	32	29.25	48	191	30
	81CC7232-20-R24L16DX41	4227	4861	72	32	29.25	48	191	30
	81CC7232-20-L24R16DX41	4227	4861	72	32	29.25	48	191	30
	81CC7236-24-R24L16FX41	4322	4972	72	36	29.25	48	220	36
	81CC7236-24-R20L16FX41	4322	4972	72	36	29.25	48	220	36
	81CC7236-24-R20L16DX41	4322	4972	72	36	29.25	48	220	36
	81CC7236-24-L20R16DX41	4322	4972	72	36	29.25	48	220	36
	81CC7236-24-L20R16FX41	4322	4972	72	36	29.25	48	220	36
	81CC7236-24-L24R16FX41	4322	4972	72	36	29.25	48	220	36
	81CC7236-24-R24L16DX41	4322	4972	72	36	29.25	48	220	36
	81CC7236-24-L24R16DX41	4322	4972	72	36	29.25	48	220	36
81CC8032-20-R20L16FX41	4542	5223	80	32	29.25	56	189	34	
81CC8032-20-R20L16DX41	4542	5223	80	32	29.25	56	189	34	
81CC8032-20-L20R16FX41	4542	5223	80	32	29.25	56	189	34	
81CC8032-20-L20R16DX41	4542	5223	80	32	29.25	56	189	34	
81CC8032-20-R24L16FX41	4542	5223	80	32	29.25	56	189	34	
81CC8032-20-R24L16DX41	4542	5223	80	32	29.25	56	189	34	
81CC8032-20-L24R16FX41	4542	5223	80	32	29.25	56	189	34	
81CC8032-20-L24R16DX41	4542	5223	80	32	29.25	56	189	34	
81CC8036-24-R20L16FX41	4580	5264	80	36	29.25	56	237	40	
81CC8036-24-R20L16DX41	4580	5264	80	36	29.25	56	237	40	
81CC8036-24-L20R16FX41	4580	5264	80	36	29.25	56	237	40	
81CC8036-24-L20R16DX41	4580	5264	80	36	29.25	56	237	40	
81CC8036-24-R24L16FX41	4580	5264	80	36	29.25	56	237	40	
81CC8036-24-L24R16FX41	4580	5264	80	36	29.25	56	237	40	
81CC8036-24-R24L16DX41	4580	5264	80	36	29.25	56	237	40	
81CC8036-24-L24R16DX41	4580	5264	80	36	29.25	56	237	40	

**ORDERING NOTES:**

The first dimension after the second "-" indicates connecting side dimensions, e.g. 81CC8036-24-L20R0 has a 20" connecting side

**DIMENSION KEY**

W - width  
D - depth  
H - height

**CODE DESCRIPTION**

L - left hand pedestal position  
R - right hand pedestal position  
D - 2 file drawers  
F - 2 box, 1 file drawer  
0 - no pedestal  
Q - V-Ped  
X41 - full height modesty panel

**STANDARD FINISHES**

For a complete list of standard wood finishes please see page 114.

**GROMMETS**

One wiring grommet in standard position is optional at no charge. See page 117 for more wiring grommet information.

**PULL LOCATIONS**

For details please see page 116.

# VESTRADA | CORNER CREDENZAS

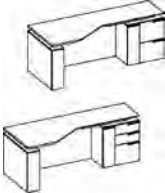
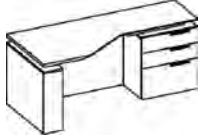
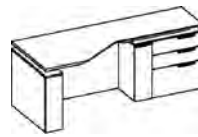
Description	Model	Cherry Maple Walnut			W	D	H	KW	Shipping Weight	Cubic Feet
		Rift Oak	Anigre							
Corner Credenza, Fixed Modesty Panel, 24" 2 Box/ 1 File or 2 File with V-Ped Pedestal 	81CC8032-20-R20L24FQX41	6182	7108		80	32	29.25	48	205	34
	81CC8032-20-R24L24FQX41	6182	7108		80	32	29.25	48	205	34
	81CC8032-20-R20L24DQX41	6182	7108		80	32	29.25	48	205	34
	81CC8032-20-R24L24DQX41*	6182	7108		80	32	29.25	48	205	34
	81CC8032-20-L20R24FQX41	6182	7108		80	32	29.25	48	205	34
	81CC8032-20-L24R24FQX41	6182	7108		80	32	29.25	48	205	34
	81CC8032-20-L20R24DQX41	6182	7108		80	32	29.25	48	205	34
	81CC8032-20-L24R24DQX41	6182	7108		80	32	29.25	48	205	34
	81CC8036-24-R20L24FQX41	6219	7153		80	36	29.25	48	253	40
	81CC8036-24-R24L24FQX41	6219	7153		80	36	29.25	48	253	40
	81CC8036-24-R20L24DQX41	6219	7153		80	36	29.25	48	253	40
	81CC8036-24-R24L24DQX41	6219	7153		80	36	29.25	48	253	40
	81CC8036-24-L20R24FQX41	6219	7153		80	36	29.25	48	253	40
	81CC8036-24-L24R24FQX41	6219	7153		80	36	29.25	48	253	40
	81CC8036-24-L20R24DQX41	6219	7153		80	36	29.25	48	253	40
	81CC8036-24-L24R24DQX41	6219	7153		80	36	29.25	48	253	40
Corner Credenza, Fixed Modesty Panel, 24" 2 Box/ 1 File 	81CC7232-20-R20L24FX41	4564	5248		72	32	29.25	40	207	30
	81CC7232-20-R24L24FX41	4564	5248		72	32	29.25	40	207	30
	81CC7232-20-L20R24FX41*	4564	5248		72	32	29.25	40	207	30
	81CC7232-20-L24R24FX41	4564	5248		72	32	29.25	40	207	30
	81CC7236-24-R20L24FX41	4669	5368		72	36	29.25	40	236	36
	81CC7236-24-R24L24FX41	4669	5368		72	36	29.25	40	236	36
	81CC7236-24-L20R24FX41	4669	5368		72	36	29.25	40	236	36
	81CC7236-24-L24R24FX41	4669	5368		72	36	29.25	40	236	36
	81CC8032-20-R20L24FX41	4679	5381		80	32	29.25	48	205	34
	81CC8032-20-R24L24FX41	4679	5381		80	32	29.25	48	205	34
	81CC8032-20-L20R24FX41	4679	5381		80	32	29.25	48	205	34
	81CC8032-20-L24R24FX41	4679	5381		80	32	29.25	48	205	34
	81CC8036-24-R20L24FX41	4718	5425		80	36	29.25	48	253	40
	81CC8036-24-R24L24FX41	4718	5425		80	36	29.25	48	253	40
	81CC8036-24-L20R24FX41	4718	5425		80	36	29.25	48	253	40
	81CC8036-24-L24R24FX41	4718	5425		80	36	29.25	48	253	40
Corner Credenza, Fixed Modesty Panel, 32" 2 Box/ 1 File or 2 File with V-Ped Pedestal 	81CC8032-20-R20L32FQX41	6318	7267		80	32	29.25	40	231	34
	81CC8032-20-R20L32DQX41	6318	7267		80	32	29.25	40	231	34
	81CC8032-20-R24L32FQX41	6318	7267		80	32	29.25	40	231	34
	81CC8032-20-R24L32DQX41	6318	7267		80	32	29.25	40	231	34
	81CC8032-20-L20R32FQX41*	6318	7267		80	32	29.25	40	231	34
	81CC8032-20-L24R32FQX41	6318	7267		80	32	29.25	40	231	34
	81CC8032-20-L20R32DQX41	6318	7267		80	32	29.25	40	231	34
	81CC8032-20-L24R32DQX41	6318	7267		80	32	29.25	40	231	34
	81CC8036-24-R20L32FQX41	6357	7310		80	36	29.25	40	269	40
	81CC8036-24-R24L32FQX41	6357	7310		80	36	29.25	40	269	40
	81CC8036-24-R20L32DQX41	6357	7310		80	36	29.25	40	269	40
	81CC8036-24-R24L32DQX41	6357	7310		80	36	29.25	40	269	40
	81CC8036-24-L20R32FQX41	6357	7310		80	36	29.25	40	269	40
	81CC8036-24-L24R32FQX41	6357	7310		80	36	29.25	40	269	40
	81CC8036-24-L20R32DQX41	6357	7310		80	36	29.25	40	269	40
	81CC8036-24-L24R32DQX41	6357	7310		80	36	29.25	40	269	40

**ORDERING NOTES:** Wire management cut-outs are standard on all corner credenza modesty panels. The first dimension listed after the second "-" indicates connecting side dimensions, e.g. 81CC8036-24-L20R0 has a 20" connecting side. Please note 24" BBF or FF/V-Ped is one component. V-Ped is always towards kneespace and is not available for field installation. Corner Credenzas with V-Peds are NOT available on KrugExpress.

**ORDERING PROCEDURE**

- To order, please specify the following:
- 1) Krug product model number
- 2) Wood species and finish, see page 114
- 3) Pull style and finish, see page 116
- 4) V-Beam color, see page 117
- 5) Grommet location and style if applicable

\* Indicates model illustrated by line drawing

**CODE DESCRIPTION**

- L - left hand pedestal position
- R - right hand pedestal position
- D - 2 file drawers
- F - 2 box, 1 file drawer
- 0 - no pedestal
- Q - V-Ped
- X41 - full height modesty panel

**STANDARD FINISHES**

For a complete list of standard wood finishes please see page 114.

**GROMMETS**

One wiring grommet in standard position is optional at no charge. See page 117 for more wiring grommet information.

**GLASS PRIVACY SCREEN**

Please see page 204 for glass privacy screen options.

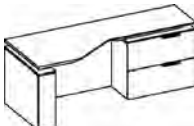
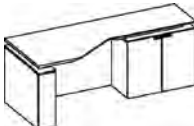
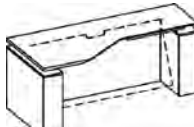
Description	Model	Cherry		W	D	H	KW	Shipping Weight	Cubic Feet
		Maple Walnut Rift Oak	Anigre						
	81CC8032-20-R20L3201X41*	6188	7119	80	32	29.25	40	231	34
	81CC8032-20-R24L3201X41	6188	7119	80	32	29.25	40	231	34
	81CC8032-20-L20R3201X41	6188	7119	80	32	29.25	40	231	34
	81CC8032-20-L24R3201X41	6188	7119	80	32	29.25	40	231	34
	81CC8036-24-R20L3201X41	6280	7219	80	36	29.25	40	269	40
	81CC8036-24-R24L3201X41	6280	7219	80	36	29.25	40	269	40
	81CC8036-24-L20R3201X41	6280	7219	80	36	29.25	40	269	40
	81CC8036-24-L24R3201X41	6280	7219	80	36	29.25	40	269	40
	81CC8032-20-R20L32BCX41	5636	6482	80	32	29.25	40	226	34
	81CC8032-20-R24L32BCX41	5636	6482	80	32	29.25	40	226	34
	81CC8032-20-L20R32BCX41*	5636	6482	80	32	29.25	40	226	34
	81CC8032-20-L24R32BCX41	5636	6482	80	32	29.25	40	226	34
	81CC8036-24-R20L32BCX41	5719	6578	80	36	29.25	40	259	40
	81CC8036-24-R24L32BCX41	5719	6578	80	36	29.25	40	259	40
	81CC8036-24-L20R32BCX41	5719	6578	80	36	29.25	40	259	40
	81CC8036-24-L24R32BCX41	5719	6578	80	36	29.25	40	259	40
	81CCY6432-20-R20L0X41	3505	4029	64	32	29.25	48	154	27
	81CCY6432-20-L20R0X41	3505	4029	64	32	29.25	48	154	27
	81CCY6432-20-R24L0X41	3505	4029	64	32	29.25	48	154	27
	81CCY6432-20-L24R0X41	3505	4029	64	32	29.25	48	154	27
	81CCY6436-24-R20L0X41	3547	4083	64	36	29.25	48	179	32
	81CCY6436-24-L20R0X41	3547	4083	64	36	29.25	48	179	32
	81CCY6436-24-R24L0X41	3547	4083	64	36	29.25	48	179	32
	81CCY6436-24-L24R0X41	3547	4083	64	36	29.25	48	179	32
	81CCY7232-20-R20L0X41	3563	4098	72	32	29.25	56	169	30
	81CCY7232-20-L20R0X41*	3563	4098	72	32	29.25	56	169	30
	81CCY7232-20-R24L0X41	3563	4098	72	32	29.25	56	169	30
	81CCY7232-20-L24R0X41	3563	4098	72	32	29.25	56	169	30
	81CCY7236-24-R20L0X41	3591	4130	72	36	29.25	56	198	36
	81CCY7236-24-L20R0X41	3591	4130	72	36	29.25	56	198	36
	81CCY7236-24-R24L0X41	3591	4130	72	36	29.25	56	198	36
	81CCY7236-24-L24R0X41	3591	4130	72	36	29.25	56	198	36
	81CCY8032-20-R20L0X41	3604	4143	80	32	29.25	64	167	34
	81CCY8032-20-L20R0X41	3604	4143	80	32	29.25	64	167	34
	81CCY8032-20-R24L0X41	3604	4143	80	32	29.25	64	167	34
	81CCY8032-20-L24R0X41	3604	4143	80	32	29.25	64	167	34
81CCY8036-24-R20L0X41	3673	4224	80	36	29.25	64	215	40	
81CCY8036-24-R24L0X41	3673	4224	80	36	29.25	64	215	40	
81CCY8036-24-L20R0X41	3673	4224	80	36	29.25	64	215	40	
81CCY8036-24-L24R0X41	3673	4224	80	36	29.25	64	215	40	

**ORDERING NOTES:**

The first dimension after the second "-" indicates connecting side dimensions, e.g. 81CC8036-24-L20R0 has a 20" connecting side

**DIMENSION KEY**

W - width  
D - depth  
H - height

**CODE DESCRIPTION**

L - left hand pedestal position  
R - right hand pedestal position  
D - 2 file drawer  
F - 2 box, 1 file drawer  
0 - no pedestal  
J - TracDesk option  
W - extended pedestal option  
X31 - 3/4 height recessed modesty panel  
X41 - full height recessed modesty panel

**STANDARD FINISHES**

For a complete list of standard wood finishes please see page 114.

**GROMMETS**

One wiring grommet in standard position is optional at no charge. See page 117 for more wiring grommet information.

**PULL LOCATIONS**

For details please see page 116.

# VESTRADA | CORNER CREDENZAS

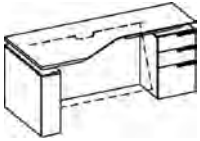
Description	Model	Wood Species			W	D	H	KW	Shipping Weight	Cubic Feet
		Cherry	Maple	Walnut						
Corner Credenza,	81CCY6432-20-R20L16FX41	4572	5259		64	32	29.25	40	186	27
Hinged Modesty	81CCY6432-20-R20L16DX41	4572	5259		64	32	29.25	40	186	27
Panel, 16"	81CCY6432-20-L20R16FX41*	4572	5259		64	32	29.25	40	186	27
Pedestal	81CCY6432-20-L20R16DX41	4572	5259		64	32	29.25	40	186	27
	81CCY6432-20-R24L16FX41	4572	5259		64	32	29.25	40	186	27
	81CCY6432-20-R24L16DX41	4572	5259		64	32	29.25	40	186	27
	81CCY6432-20-L24R16FX41	4572	5259		64	32	29.25	40	186	27
	81CCY6432-20-L24R16DX41	4572	5259		64	32	29.25	40	186	27
	81CCY6436-24-R20L16FX41	4639	5336		64	36	29.25	40	201	32
	81CCY6436-24-R20L16DX41	4639	5336		64	36	29.25	40	201	32
	81CCY6436-24-L20R16FX41	4639	5336		64	36	29.25	40	201	32
	81CCY6436-24-L20R16DX41	4639	5336		64	36	29.25	40	201	32
	81CCY6436-24-R24L16FX41	4639	5336		64	36	29.25	40	201	32
	81CCY6436-24-R24L16DX41	4639	5336		64	36	29.25	40	201	32
	81CCY6436-24-L24R16FX41	4639	5336		64	36	29.25	40	201	32
	81CCY6436-24-L24R16DX41	4639	5336		64	36	29.25	40	201	32
	81CCY7232-20-R20L16FX41	4648	5345		72	32	29.25	48	191	30
	81CCY7232-20-R24L16FX41	4648	5345		72	32	29.25	48	191	30
	81CCY7232-20-L20R16FX41	4648	5345		72	32	29.25	48	191	30
	81CCY7232-20-L24R16FX41	4648	5345		72	32	29.25	48	191	30
	81CCY7232-20-R20L16DX41	4648	5345		72	32	29.25	48	191	30
	81CCY7232-20-R24L16DX41	4648	5345		72	32	29.25	48	191	30
	81CCY7232-20-L20R16DX41	4648	5345		72	32	29.25	48	191	30
	81CCY7232-20-L24R16DX41	4648	5345		72	32	29.25	48	191	30
81CCY7236-24-R20L16FX41	4756	5470		72	36	29.25	48	220	36	
81CCY7236-24-R24L16FX41	4756	5470		72	36	29.25	48	220	36	
81CCY7236-24-L20R16FX41	4756	5470		72	36	29.25	48	220	36	
81CCY7236-24-L24R16FX41	4756	5470		72	36	29.25	48	220	36	
81CCY7236-24-R20L16DX41	4756	5470		72	36	29.25	48	220	36	
81CCY7236-24-R24L16DX41	4756	5470		72	36	29.25	48	220	36	
81CCY7236-24-L20R16DX41	4756	5470		72	36	29.25	48	220	36	
81CCY7236-24-L24R16DX41	4756	5470		72	36	29.25	48	220	36	
81CCY8032-20-R20L16FX41	4996	5746		80	32	29.25	56	189	34	
81CCY8032-20-R24L16FX41	4996	5746		80	32	29.25	56	189	34	
81CCY8032-20-L20R16FX41	4996	5746		80	32	29.25	56	189	34	
81CCY8032-20-L24R16FX41	4996	5746		80	32	29.25	56	189	34	
81CCY8032-20-R20L16DX41	4996	5746		80	32	29.25	56	189	34	
81CCY8032-20-R24L16DX41	4996	5746		80	32	29.25	56	189	34	
81CCY8032-20-L20R16DX41	4996	5746		80	32	29.25	56	189	34	
81CCY8032-20-L24R16DX41	4996	5746		80	32	29.25	56	189	34	
81CCY8036-24-R20L16FX41	5037	5793		80	36	29.25	56	237	40	
81CCY8036-24-R24L16FX41	5037	5793		80	36	29.25	56	237	40	
81CCY8036-24-L20R16FX41	5037	5793		80	36	29.25	56	237	40	
81CCY8036-24-L24R16FX41	5037	5793		80	36	29.25	56	237	40	
81CCY8036-24-R20L16DX41	5037	5793		80	36	29.25	56	237	40	
81CCY8036-24-R24L16DX41	5037	5793		80	36	29.25	56	237	40	
81CCY8036-24-L20R16DX41	5037	5793		80	36	29.25	56	237	40	
81CCY8036-24-L24R16DX41	5037	5793		80	36	29.25	56	237	40	

**ORDERING NOTES:** Wire management cut-outs are standard on all corner credenza modesty panels. The first dimension listed after the second "-" indicates connecting side dimensions, e.g. 81CC8036-24-L20R0 has a 20" connecting side. Please note 24" BBF or FF/V-Ped is one component. V-Ped is always towards kneespace and is not available for field installation. Corner Credenzas with V-Peds are NOT available on KrugExpress.

**ORDERING PROCEDURE**

- To order, please specify the following:
- 1) Krug product model number
  - 2) Wood species and finish, see page 115
  - 3) Pull style and finish, see page 116
  - 4) V-Beam color, see page 117
  - 5) Grommet location and style if applicable

\* Indicates model illustrated by line drawing

**CODE DESCRIPTION**

- L - left hand pedestal position
- R - right hand pedestal position
- D - 2 file drawers
- F - 2 box, 1 file drawer
- 0 - no pedestal
- Q - V-Ped
- X41 - full height modesty panel

**STANDARD FINISHES**

For a complete list of standard wood finishes please see page 114.

**GROMMETS**

One wiring grommet in standard position is optional at no charge. See page 117 for more wiring grommet information.

**GLASS PRIVACY SCREEN**

Please see page 204 for glass privacy screen options. CASEGOODS | GSA | 179

# VESTRADA | CORNER CREDENZAS

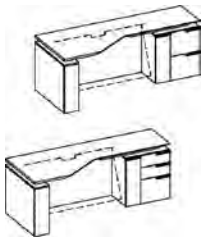
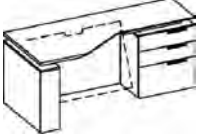
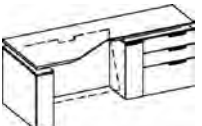
Description	Model	Finish				W	D	H	KW	Shipping Weight	Cubic Feet
		Cherry	Maple	Walnut	Rift Oak						
Corner Credenza, Hinged Modesty Panel, 24" 2 Box/ 1 File or 2 File with V-Ped Pedestal 	81CCY8032-20-R20L24FQX41	6798	7820		80	32	29.25	48	205	34	
	81CCY8032-20-L20R24FQX41	6798	7820		80	32	29.25	48	205	34	
	81CCY8032-20-R20L24DQX41	6798	7820		80	32	29.25	48	205	34	
	81CCY8032-20-L20R24DQX41*	6798	7820		80	32	29.25	48	205	34	
	81CCY8032-20-R24L24FQX41	6798	7820		80	32	29.25	48	205	34	
	81CCY8032-20-L24R24FQX41	6798	7820		80	32	29.25	48	205	34	
	81CCY8032-20-L24R24DQX41	6798	7820		80	32	29.25	48	205	34	
	81CCY8032-20-L24R24DQX41	6798	7820		80	32	29.25	48	205	34	
	81CCY8036-24-R20L24FQX41	6842	7868		80	36	29.25	48	237	40	
	81CCY8036-24-R20L24DQX41	6842	7868		80	36	29.25	48	205	34	
	81CCY8036-24-L20R24FQX41	6842	7868		80	36	29.25	48	205	34	
	81CCY8036-24-L20R24DQX41	6842	7868		80	36	29.25	48	205	34	
	81CCY8036-24-R24L24FQX41	6842	7868		80	36	29.25	48	237	40	
	81CCY8036-24-R24L24DQX41	6842	7868		80	36	29.25	48	205	34	
	81CCY8036-24-L24R24FQX41	6842	7868		80	36	29.25	48	205	34	
81CCY8036-24-L24R24DQX41	6842	7868		80	36	29.25	48	205	34		
Corner Credenza, Hinged Modesty Panel, 24" 2 Box/ 1 File Pedestal 	81CCY7232-20-R20L24FX41	5021	5771		72	32	29.25	40	207	30	
	81CCY7232-20-R24L24FX41	5021	5771		72	32	29.25	40	207	30	
	81CCY7232-20-L20R24FX41*	5021	5771		72	32	29.25	40	207	30	
	81CCY7232-20-L24R24FX41	5021	5771		72	32	29.25	40	207	30	
	81CCY7236-24-R20L24FX41	5137	5906		72	36	29.25	40	236	36	
	81CCY7236-24-R24L24FX41	5137	5906		72	36	29.25	40	236	36	
	81CCY7236-24-L20R24FX41	5137	5906		72	36	29.25	40	236	36	
	81CCY7236-24-L24R24FX41	5137	5906		72	36	29.25	40	236	36	
	81CCY8032-20-R20L24FX41	5145	5918		80	32	29.25	48	205	34	
	81CCY8032-20-R24L24FX41	5145	5918		80	32	29.25	48	205	34	
	81CCY8032-20-L20R24FX41	5145	5918		80	32	29.25	48	205	34	
	81CCY8032-20-L24R24FX41	5145	5918		80	32	29.25	48	205	34	
	81CCY8036-24-R20L24FX41	5190	5969		80	36	29.25	48	253	40	
	81CCY8036-24-R24L24FX41	5190	5969		80	36	29.25	48	253	40	
	81CCY8036-24-L20R24FX41	5190	5969		80	36	29.25	48	253	40	
81CCY8036-24-L24R24FX41	5190	5969		80	36	29.25	48	253	40		
Corner Credenza, Hinged Modesty Panel, 32" 2 Box/ 1 File with V-Ped 	81CCY8032-20-R20L32FQX41	6948	7990		80	32	29.25	40	231	34	
	81CCY8032-20-R24L32FQX41	6948	7990		80	32	29.25	40	231	34	
	81CCY8032-20-L20R32FQX41*	6948	7990		80	32	29.25	40	231	34	
	81CCY8032-20-L24R32FQX41	6948	7990		80	32	29.25	40	231	34	
	81CCY8036-24-R20L32FQX41	6991	8040		80	36	29.25	40	269	40	
	81CCY8036-24-R24L32FQX41	6991	8040		80	36	29.25	40	269	40	
	81CCY8036-24-L20R32FQX41	6991	8040		80	36	29.25	40	269	40	
	81CCY8036-24-L24R32FQX41	6991	8040		80	36	29.25	40	269	40	

**ORDERING NOTES:** Wire management cut-outs are standard on all corner credenza modesty panels. The first dimension listed after the second "-" indicates connecting side dimensions, e.g. 81CC8036-24-L20R0 has a 20" connecting side. Please note 24" BBF or FF/V-Ped is one component. V-Ped is always towards kneespace and is not available for field installation. Corner Credenzas with V-Peds are NOT available on KrugExpress.

**DIMENSION KEY**

W - width  
 D - depth  
 H - height

**CODE DESCRIPTION**

L - left hand pedestal position  
 R - right hand pedestal position  
 D - 2 file drawer  
 F - 2 box, 1 file drawer  
 0 - no pedestal  
 J - TracDesk option  
 W - extended pedestal option  
 X31 - 3/4 height recessed modesty panel  
 X41 - full height recessed modesty panel

**STANDARD FINISHES**

For a complete list of standard wood finishes please see page 114.

**GROMMETS**

One wiring grommet in standard position is optional at no charge. See page 117 for more wiring grommet information.

**PULL LOCATIONS**

For details please see page 116.

# VESTRADA | CORNER CREDENZAS

Description	Model	Cherry Maple Walnut Rift Oak	Anigre	W	D	H	KW	Shipping Weight	Cubic Feet
Corner Credenza, Hinged Modesty Panel, 32" Lateral File Pedestal	81CCY8032-20-R20L3201X41	6807	7829	80	32	29.25	40	231	34
	81CCY8032-20-R24L3201X41	6807	7829	80	32	29.25	40	231	34
	81CCY8032-20-L20R3201X41*	6807	7829	80	32	29.25	40	231	34
	81CCY8032-20-L24R3201X41	6807	7829	80	32	29.25	40	231	34
	81CCY8036-24-R20L3201X41	6905	7940	80	36	29.25	40	269	40
	81CCY8036-24-R24L3201X41	6905	7940	80	36	29.25	40	269	40
	81CCY8036-24-L20R3201X41	6905	7940	80	36	29.25	40	269	40
	81CCY8036-24-L24R3201X41	6905	7940	80	36	29.25	40	269	40

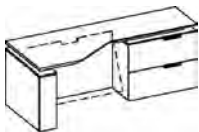

Corner Credenza, Hinged Modesty Panel, 32" Bookcase Pedestal	81CCY8032-20-R20L32BCX41	6198	7129	80	32	29.25	40	226	34
	81CCY8032-20-R24L32BCX41	6198	7129	80	32	29.25	40	226	34
	81CCY8032-20-L20R32BCX41*	6198	7129	80	32	29.25	40	226	34
	81CCY8032-20-L24R32BCX41	6198	7129	80	32	29.25	40	226	34
	81CCY8036-24-L20R32BCX41	6292	7236	80	36	29.25	40	259	40
	81CCY8036-24-R20L32BCX41	6292	7236	80	36	29.25	40	259	40
	81CCY8036-24-R24L32BCX41	6292	7236	80	36	29.25	40	259	40
	81CCY8036-24-L24R32BCX41	6292	7236	80	36	29.25	40	259	40

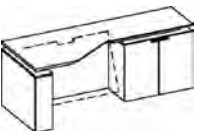

**ORDERING NOTES:** Wire management cut-outs are standard on all corner credenza modesty panels. The first dimension listed after the second "-" indicates connecting side dimensions, e.g. 81CC8036-24-L20R0 has a 20" connecting side. Please note 24" BBF or FF/V-Ped is one component. V-Ped is always towards kneespace and is not available for field installation. Corner Credenzas with V-Peds are NOT available on KrugExpress.

**ORDERING PROCEDURE**

- To order, please specify the following:
- 1) Krug product model number
  - 2) Wood species and finish, see page 114
  - 3) Pull style and finish, see page 115
  - 4) V-Beam color, see page 117
  - 5) Grommet location and style if applicable

\* Indicates model illustrated by line drawing

**CODE DESCRIPTION**

- L - left hand pedestal position
- R - right hand pedestal position
- D - 2 file drawers
- F - 2 box, 1 file drawer
- 0 - no pedestal
- Q - V-Ped
- X41 - full height modesty panel

**STANDARD FINISHES**

For a complete list of standard wood finishes please see page 114.

**GROMMETS**

One wiring grommet in standard position is optional at no charge. See page 117 for more wiring grommet information.

**GLASS PRIVACY SCREEN**

Please see page 204 for glass privacy screen options.



ORDERING VESTRADA MODULAR COMPONENTS

STEP 1

TOPS

Determine the size and shape of worksurface you require and find the corresponding model number (see page 188).  
 Example: A 72" x 36" rectangular desk top is listed as 81TPD-7236.

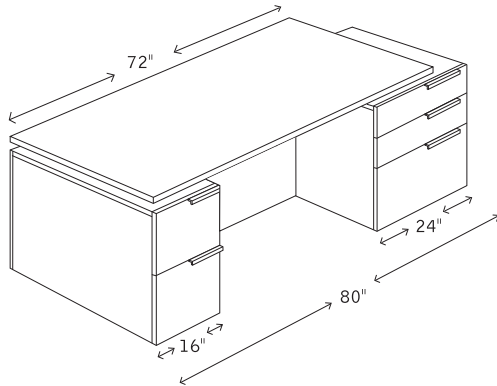

Installation Note

Case tops feature factory installed inserts while pedestals have blind holes which can be drilled out, and the top bolted in place as per the installation instructions. This provides 16" of pedestal under the top unless the pedestal features a V-Ped, in which case 24" of pedestal lies beneath the top. For situations where tops are not bolted into place, anti-skid tape is provided to be applied to the under side of the V-Beam. In this scenario a minimum of 12" of pedestal must support the top on both sides.

NOTE:

If you plan to order pedestals that extend out from the top, please take into consideration the overall floor space you have to work with when ordering your top size.

STEP 2

PEDESTALS

Determine the pedestal type, width and depth required, and find the corresponding model number (see pages 201-208). The pedestal(s) selected should be the same depth as the top that is ordered. If ordering a face mounted glass modesty panel, the pedestal(s) selected should be 6" less in depth than the top depth.

Pedestals may be positioned entirely under the worksurface or can extend out left or right from beneath the worksurface. A minimum of 16" of pedestal width must be located directly under the worksurface if the top is to be bolted in place. If the need to fill floor space exists, a minimum of 12" of pedestal must support the worksurface. However, in this situation, the top cannot be bolted into place, but rather placed on top of the pedestals with anti-skid tape to hold the top in place. These rules must be taken into consideration when determining what top, pedestal(s) and modesty panels to order.

Example: An 88" top with a 24" left pedestal and a 32" right pedestal can be extended to give an overall unit width of 112".

NOTE: An 18" deep pedestal is required if positioning a pedestal in front of a modesty panel due to the inset of the V-Beam. Only the pedestals listed in 18" depths are available.

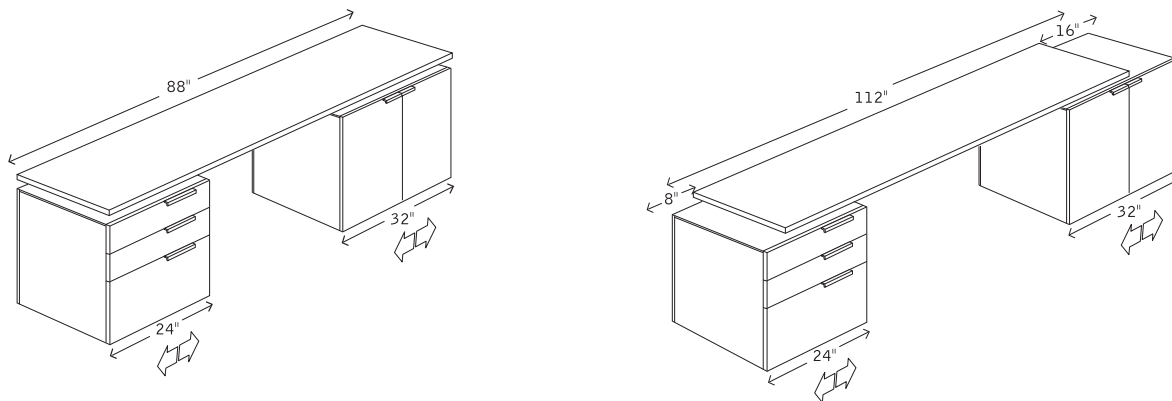

# VESTRADA | MODULAR GUIDELINES

## STEP 3

### MODESTY PANELS

Modesty panels are available in a variety of sizes and materials. Please refer to the following chart to find applicable modesty panel for specific tops

Top Type	Modesty Type Available	Top Size
Rectangular Top Desk	3/4 & Full Height Wood	64" - 96"
	Face mounted Wood/Glass	72" - 88"
Elliptical Top Desk	Face mounted Glass	72" - 88"
Credenza	Full Height Wood*	64" - 96"
	Hinged Wood**	64" - 96"
Return	Full Height Wood***	36" - 88"
	Hinged Wood**	36" - 88"

- \* Wire management cut-out option available at **\$194 list**
- \*\* Features wire management cut-out as standard
- \*\*\* Wire management cut-out option available on wood modesty panel at **\$194 list**

### Recessed Modesty Panels

Determine the modesty panel style and size, and find the corresponding model number (see pages 209-210). Modesty panel sizes are determined by subtracting the widths of the pedestals or supports that are located directly underneath the work-surface from your top width.

Example: A 72" top with a 24" pedestal on the right and an 8" support on the left would require a 40" wide modesty panel (72 minus 24 minus 8 = 40).

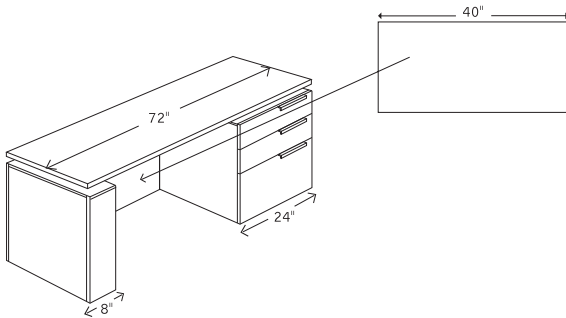

If specifying extended pedestals, at least 16" of each extended pedestal must be located underneath the worksurface if the top is to be bolted in place. Likewise, 12" of pedestal must support the top if only using the anti-skid tape method of installing. To determine the size of modesty panel required when using extended pedestals, subtract only the amount of each pedestal that is located directly underneath the worksurface from the overall worksurface width to determine the modesty panel width required.

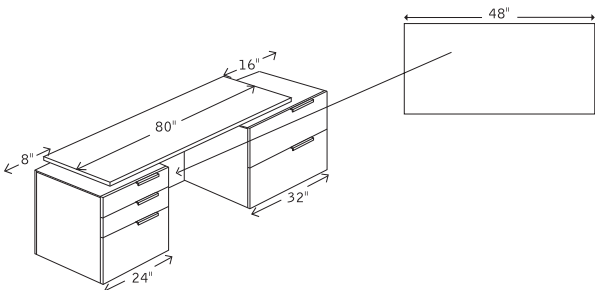

### Face Mounted Modesty Panels

Face mounted glass or wood modesty panel widths are determined by subtracting 16" of width from the top size you are ordering. The reasoning behind this formula is simple. Face mounted modesty panels must attach to 8" of pedestal left and right. For this to work, the pedestals must be 16" wide minimum and must always be 6" shallower than the top depth. Please note that 8" modular support pedestals will not support a face mounted modesty panel. Example: If ordering an 80" top, the face mounted glass modesty panel required is 64" wide, regardless of pedestal widths (starting with 16" pedestals).

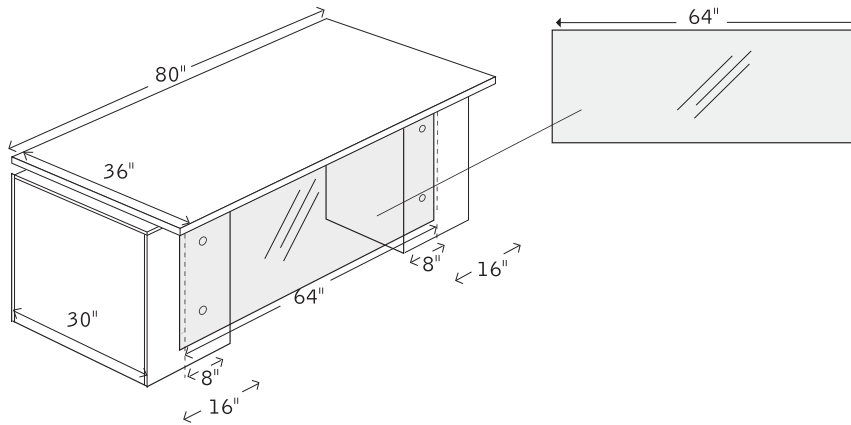

Modesty panels are available in a limited number of widths. This must be taken into consideration when planning out exactly how pedestals are to be situated. For example, you cannot have 51" of space between the pedestals because there is not a 67" modesty panel available. If a 51" kneespace is required, simply do not order a modesty panel. All available modesty panel widths are listed in the modular components section on pages 209-210.

If planning on extending or retracting your pedestal(s) into different positions in the future, a modesty panel should not be specified, as this will limit future space planning.

VESTRADA modular components are shipped with very durable anti-skid tape. The tape is designed to facilitate the need to move pedestals inward and outward as required, but prevents the top from moving when placed over the pedestals. Remember, a minimum of 12" of pedestal must be below the top for VESTRADA casegoods to be structurally supportive with the anti-skid tape method of installing, and 16" of pedestal below the worksurface to bolt the top in place.

# VESTRADA | MODULAR TOPS

Description	Model	Cherry		W	D	H	KW	Shipping Weight	Cubic Feet
		Maple	Walnut						
		Rift Oak	Anigre						
Desk Top, Rectangular 	81TPD6430	1282	1474	64	30	3.13		82	4
	81TPD7236	1403	1613	72	36	3.13		118	6
	81TPD8036*	1494	1717	80	36	3.13		132	7
	81TPD8836	1543	1776	88	36	3.13		132	7
	81TPD9636	1613	1856	96	36	3.13		153	8

**ORDERING NOTES:** Model numbers above represent tops to be used in conjunction with recessed modesty panels. Tops ship with V-Beam attached. For tops to be used in conjunction with face mounted modesty panels, add 'Z' to model number prefix, e.g., 81TPDZ

Description	Model	Cherry	Maple	W	D	H	KW	Shipping Weight	Cubic Feet
		Rift Oak	Anigre						
Desk Top, Elliptical 	81TPDEZ7236	2345	2697	72	36	3.13		78	6
	81TPDEZ8036*	2486	2858	80	36	3.13		108	7

**ORDERING NOTES:** Elliptical tops are only used in conjunction with face mounted glass modesty panels. Tops ship with V-Beam attached. Pedestals for elliptical tops require a designation of PEZ. This item is not available on KrugExpress.

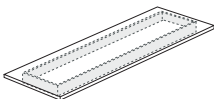
Description	Model	Cherry		W	D	H	KW	Shipping Weight	Cubic Feet
		Maple	Walnut						
		Rift Oak	Anigre						
Credenza Top 	81TPC6420	1252	1440	64	20	3.13		53	4
	81TPC6424	1292	1485	64	24	3.13		61	3
	81TPC7220	1298	1492	72	20	3.13		63	4
	81TPC7224	1334	1535	72	24	3.13		65	4
	81TPC8020	1347	1551	80	20	3.13		71	5
	81TPC8024	1369	1570	80	24	3.13		73	4
	81TPC8820	1383	1590	88	20	3.13		82	5
	81TPC8824*	1405	1617	88	24	3.13		84	4
	81TPC9620	1420	1633	96	20	3.13		87	5
	81TPC9624	1433	1646	96	24	3.13		89	5

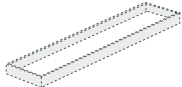
Description	Model	Cherry		W	D	H	KW	Shipping Weight	Cubic Feet
		Maple	Walnut						
		Rift Oak	Anigre						
Credenza Top for TracDesks 	81TPC8020J	1875	2157	80	20	3.13		71	5
	81TPC8024J	1941	2232	80	24	3.13		73	4
	81TPC8820J	1938	2229	88	20	3.13		82	5
	81TPC8824J*	1989	2286	88	24	3.13		84	5
	81TPC9620J	1962	2255	96	20	3.13		87	5
	81TPC9624J	2023	2324	96	24	3.13		89	5

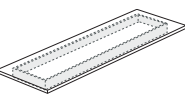
Description	Model	Cherry		W	D	H	KW	Shipping Weight	Cubic Feet
		Maple	Walnut						
		Rift Oak	Anigre						
Credenza Top for TracDesks 	81TPR3620L	924	1063	36	20	3.13		34	15
	81TPR3620R	924	1063	36	20	3.13		34	15
	81TPR3624L	934	1073	36	24	3.13		48	17
	81TPR3624R	934	1073	36	24	3.13		48	17
	81TPR4020L	959	1106	40	20	3.13		40	19
	81TPR4020R	959	1106	40	20	3.13		40	19
	81TPR4020L	988	1137	40	24	3.13		62	21
	81TPR4024R	988	1137	40	24	3.13		62	21
	81TPR4820L	1012	1164	48	20	3.13		58	29
	81TPR4820R	1012	1164	48	20	3.13		58	29
	81TPR4824L	1033	1190	48	24	3.13		77	36
	81TPR4824R	1033	1190	48	24	3.13		77	36

**ORDERING PROCEDURE**

- To order, please specify the following:
- 1) Krug product model number
  - 2) Wood species and finish, see page 114
  - 3) Pull style and finish, see page 115
  - 4) V-Beam color, see page 117
  - 5) Grommet location and style if applicable

\* Indicates model illustrated by line drawing

**CODE DESCRIPTION**

- L - left hand pedestal position
- R - right hand pedestal position
- D - 2 file drawer
- F - 2 box, 1 file drawer
- 0 - no pedestal
- J - TracDesk option
- W - extended pedestal option
- X31 - 3/4 height recessed modesty panel
- X41 - full height recessed modesty panel

**STANDARD FINISHES**

For a complete list of standard wood finishes please see page 114.

**GROMMETS**

One wiring grommet in standard position is optional at no charge. See page 117 for more wiring grommet information.

**GLASS PRIVACY SCREEN**

Please see page 204 for glass privacy screen options.

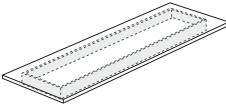
Description	Model	Cherry		W	D	H	Shipping Weight	Cubic Feet
		Maple Walnut Rift Oak	Anigre					
Return Top continued 	81TPR5620L	1039	1197	56	20	3.13	70	39
	81TPR5620R	1039	1197	56	20	3.13	70	39
	81TPR5624L*	1054	1210	56	24	3.13	91	41
	81TPR5624R	1054	1210	56	24	3.13	91	41
	81TPR6020L	1103	1270	60	20	3.13	80	45
	81TPR6020R	1103	1270	60	20	3.13	80	45
	81TPR6024L	1137	1307	60	24	3.13	93	52
	81TPR6024R	1137	1307	60	24	3.13	93	52
	81TPR6420L	1252	1440	64	20	3.13	82	53
	81TPR6420R	1252	1440	64	20	3.13	82	53
	81TPR6424L	1292	1485	64	34	3.13	107	61
	81TPR6424R	1292	1485	64	24	3.13	107	61
	81TPR6430L	1342	1545	64	30	3.13	118	58
	81TPR6430R	1342	1545	64	30	3.13	118	58
	81TPR6436L	1405	1617	64	36	3.13	130	60
	81TPR6436R	1405	1617	64	36	3.13	130	60
	81TPR7220L	1298	1492	72	20	3.13	107	63
	81TPR7220R	1298	1492	72	20	3.13	107	63
	81TPR7224L	1334	1535	72	24	3.13	118	65
	81TPR7224R	1334	1535	72	24	3.13	118	65
	81TPR7230L	1408	1618	72	30	3.13	130	68
	81TPR7230R	1408	1618	72	30	3.13	130	68
	81TPR7236L	1473	1692	72	36	3.13	142	70
	81TPR7236R	1473	1692	72	36	3.13	142	70
	81TPR8020L	1347	1551	80	20	3.13	118	74
	81TPR8020R	1347	1551	80	20	3.13	118	74
	81TPR8024L	1369	1570	80	24	3.13	130	76
	81TPR8024R	1369	1570	80	24	3.13	130	76
	81TPR8030L	1478	1697	80	30	3.13	142	79
	81TPR8030R	1478	1697	80	30	3.13	142	79
	81TPR8036L	1563	1798	80	36	3.13	159	81
	81TPR8036R	1563	1798	80	36	3.13	159	81
	81TPR8820L	1383	1590	88	20	3.13	130	84
	81TPR8820R	1383	1590	88	20	3.13	130	84
81TPR8824L	1405	1617	88	24	3.13	142	86	
81TPR8824R	1405	1617	88	24	3.13	142	86	
81TPR8830L	1526	1753	88	30	3.13	159	89	
81TPR8830R	1526	1753	88	30	3.13	159	89	
81TPR8836L	1620	1862	88	36	3.13	174	91	
81TPR8836R	1620	1862	88	36	3.13	174	91	

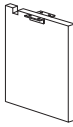
Half Gable 	81HG2909	374	429	1.25	27	27	11	1
	81HG2912	443	510	1.25	27	27	18	1

**DIMENSION KEY**

W - width  
D - depth  
H - height

**CODE DESCRIPTION**

L - left hand pedestal position  
R - right hand pedestal position  
D - 2 file drawer  
F - 2 box, 1 file drawer  
0 - no pedestal  
J - TracDesk option  
W - extended pedestal option  
X31 - 3/4 height recessed modesty panel  
X41 - full height recessed modesty panel

**STANDARD FINISHES**

For a complete list of standard wood finishes please see page 114.

**GROMMETS**

One wiring grommet in standard position is optional at no charge. See page 117 for more wiring grommet information.

**PULL LOCATIONS**

For details please see page 116.

# VESTRADA | MODULAR PEDESTALS

Description	Model	Cherry Rift Oak Walnut			W	D	H	Shipping Weight	Cubic Feet
		Maple	Anigre	Palette					
8" Modular Pedestal for Hinged or no Modesty Panel	81P0820	1654	1902	1487	8	20	26	16	4
	81P0824*	1717	1977	1547	8	24	26	20	5
	81P0830	1786	2055	1607	8	30	26	24	6
	81P0836	1857	2135	1671	8	36	26	28	7

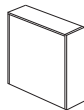

16" Modular Pedestal, File/File	81P16D18	2710	3115	2437	16	18	26	104	6
	81P16D20	2412	2773	2170	16	20	26	108	7
	81P16D24	2505	2881	2255	16	24	26	112	8
	81P16D30*	2615	3010	2355	16	30	26	116	10
	81P16D36	2719	3131	2448	16	36	26	120	10

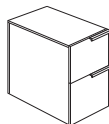

**ORDERING NOTES:** \*\*For use when adding to 24" cases where modesty panels exist. For elliptical top please specify 'EZ' after P in the model number.

16" Modular Desk Pedestal, File/File	81PD16D30L	2615	3010	2355	16	30	26	116	10
	81PD16D30R	2615	3010	2355	16	30	26	116	10
	81PD16D36L	2719	3131	2448	16	36	26	120	10
	81PD16D36R	2719	3131	2448	16	36	26	120	10

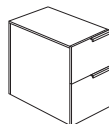

**ORDERING NOTES:** Please specify 'Z' after PD in the model number for use with a face mounted modesty panel.

16" Modular Pedestal, Box/Box/File	81P16F18	2710	3115	2437	16	18	26	108	6
	81P16F20	2605	2992	2342	16	20	26	110	7
	81P16F24	2710	3115	2437	16	24	26	114	8
	81P16F30*	2817	3238	2535	16	30	26	118	10
	81P16F36	2929	3369	2636	16	36	26	122	12



**ORDERING NOTES:** \*\*For use when adding to 24" cases where modesty panels exist. For elliptical top please specify 'EZ' after P in the model number.

16" Modular Desk Pedestal, Box/Box/File	81PD16F30L	2817	3238	2535	16	30	26	118	10
	81PD16F30R	2817	3238	2535	16	30	26	118	10
	81PD16F36L	2929	3369	2636	16	36	26	122	12
	81PD16F36R	2929	3369	2636	16	36	26	122	12

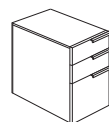

**ORDERING NOTES:** Please specify 'Z' after PD in the model number for use with a face mounted modesty panel.

## ORDERING PROCEDURE

To order, please specify the following:

- 1) Krug product model number
- 2) Wood species and finish, see page 114
- 3) Pull style and finish, see page 116
- 4) V-Beam color, see page 117
- 5) Grommet location and style if applicable

\* Indicates model illustrated by line drawing

## CODE DESCRIPTION

- L - left hand pedestal position
- R - right hand pedestal position
- D - 2 file drawer
- F - 2 box, 1 file drawer
- 0 - no pedestal
- J - TracDesk option
- W - extended pedestal option
- X31 - 3/4 height recessed modesty panel
- X41 - full height recessed modesty panel

## STANDARD FINISHES

For a complete list of standard wood finishes please see page 114.

## LOCKS/PULLS

Locks are standard on all pedestals and all lateral file drawers. For details on pull locations please see page 116.

## V-PED

Please see page 117 for details on V-Ped.

# VESTRADA | MODULAR PEDESTALS

Description	Model	Cherry Rift Oak Walnut			W	D	H	KW	Shipping Weight	Cubic Feet
		Maple	Anigre	Palette						
 16" Bookcase Pedestal	81P16BC18L	2144	2465	1929	16	18	26	95	7	
	81P16BC18R	2144	2465	1929	16	18	26	95	7	
	81P16BC20L	2063	2374	1857	16	20	26	99	8	
	81P16BC20R	2063	2374	1857	16	20	26	99	8	
	81P16BC24L*	2165	2489	1947	16	24	26	93	6	
	81P16BC24R	2165	2489	1947	16	24	26	93	6	

**ORDERING NOTES:** \*\*For use when adding to 24" cases where modesty panels exist. For elliptical top please specify 'EZ' after P in the model number.

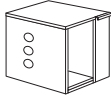
 CPU with Side Storage	81P24CPUQL24*	2955	3397	2659	24	24	26	75	14
	81P24CPUQR24	2955	3397	2659	24	24	26	75	14

**ORDERING NOTES:** This pedestal cannot be used with a case that has a modesty panel. The interior of the CPU is 22-1/4" deep, 14.3" wide and 21-3/4" high. The V-Ped is to be placed towards the kneespace for appropriate access. This item is NOT available on KrugExpress. Please note that the vented side is to be facing the knee space.

 24" Modular Pedestal, Box/Box/File	81P24F18	2791	3210	2515	24	18	26	108	10
	81P24F20*	2682	3082	2413	24	20	26	112	12
	81P24F24	2790	3209	2513	24	24	26	116	14
	81P24F30	2899	3333	2609	24	30	26	120	17
	81P24F36	2986	3432	2686	24	36	26	124	12

**ORDERING NOTES:** \*\*For use when adding to 24" cases where modesty panels exist. For elliptical top please specify 'EZ' after P in the model number.

 24" Modular Desk Pedestal, Box/Box/File	81PD24F30L	2898	3333	2609	24	30	26	120	17
	81PD24F30R	2898	3333	2609	24	30	26	120	17
	81PD24F36L	2986	3432	2686	24	36	26	124	12
	81PD24F36R	2986	3432	2686	24	36	26	124	12

**ORDERING NOTES:** Please specify 'Z' after PD in the model number for use with a face mounted modesty panel.

 24" Modular Pedestal, File/File	81P24D18	2791	3210	2515	24	18	26	108	10
	81P24D20	2682	3082	2413	24	20	26	112	12
	81P24D24*	2790	3209	2513	24	24	26	116	14
	81P24D30	2899	3333	2609	24	30	26	120	17
	81P24D36	2986	3432	2686	24	36	26	124	12

**ORDERING NOTES:** \*\*For use when adding to 24" cases where modesty panels exist. For elliptical top please specify 'EZ' after P in the model number.

**DIMENSION KEY**

W - width  
D - depth  
H - height

**CODE DESCRIPTION**

L - left hand pedestal position  
R - right hand pedestal position  
D - 2 file drawer  
F - 2 box, 1 file drawer  
0 - no pedestal  
J - TracDesk option  
W - extended pedestal option  
X31 - 3/4 height recessed modesty panel  
X41 - full height recessed modesty panel

**STANDARD FINISHES**

For a complete list of standard wood finishes please see page 114.

**GROMMETS**

One wiring grommet in standard position is optional at no charge. See page 117 for more wiring grommet information.

**PULL LOCATIONS**

For details please see page 116.

# VESTRADA | MODULAR PEDESTALS

Description	Model	Cherry Rift			W	D	H	Shipping Weight	Cubic Feet
		Oak Walnut Maple	Anigre	Palette					
24" Modular Desk Pedestal, File/File	81PD24D30L	2899	3333	2609	24	30	26	120	17
	81PD24D30R	2899	3333	2609	24	30	26	120	17
	81PD24D36L	2986	3432	2686	24	36	26	124	12
	81PD24D36R	2986	3432	2686	24	36	26	124	12

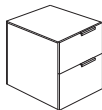

**ORDERING NOTES:** Please specify 'Z' after PD in the model number for use with a face mounted modesty panel.

24" Modular Pedestal, Box/Box/File with V-Ped	81P24FQL24*	4666	5365	4198	24	24	26	112	12
	81P24FQR24	4666	5365	4198	24	24	26	112	12

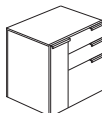

**ORDERING NOTES:** V-Ped is to be placed towards kneespace for appropriate access. This item is NOT available on KrugExpress.

24" Modular Pedestal, File/File with V-Ped	81P24DQL24*	4461	5132	4016	24	24	26	112	13
	81P24DQR24	4461	5132	4016	24	24	26	112	13

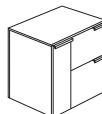

**ORDERING NOTES:** V-Ped is to be placed towards kneespace for appropriate access. This item is NOT available on KrugExpress.

32" Modular Pedestal, Lateral File	81P320120	3319	3817	2987	32	20	26	114	15
	81P320124	3453	3969	3106	32	24	26	118	18
	81P320130*	3589	4129	3232	32	30	26	122	22
	81P320136	3733	4292	3358	32	36	26	126	13

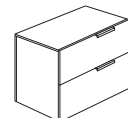

**ORDERING NOTES:** For elliptical top please specify 'EZ' after P in the model number.

32" Modular Pedestal, Box/Box/File, Lateral File	81P320420*	3931	4521	3537	32	20	26	114	13
	81P320424	4085	4697	3678	32	24	26	118	15

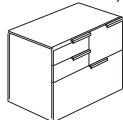

**ORDERING NOTES:** For elliptical top please specify 'EZ' after P in the model number.

## ORDERING PROCEDURE

To order, please specify the following:

- 1) Krug product model number
- 2) Wood species and finish, see page 114
- 3) Pull style and finish, see page 116
- 4) V-Beam color, see page 117
- 5) Grommet location and style if applicable

\* Indicates model illustrated by line drawing

## CODE DESCRIPTION

- L - left hand pedestal position
- R - right hand pedestal position
- D - 2 file drawer
- F - 2 box, 1 file drawer
- 0 - no pedestal
- J - TracDesk option
- W - extended pedestal option
- X31 - 3/4 height recessed modesty panel
- X41 - full height recessed modesty panel

## STANDARD FINISHES

For a complete list of standard wood finishes please see page 114.

## LOCKS/PULLS

Locks are standard on all pedestals and all lateral file drawers. For details on pull locations please see page 116.

## V-PED

Please see page 117 for details on V-Ped.



# VESTRADA | MODULAR PEDESTALS

Description	Model	Cherry Rift			W	D	H	KW	Shipping Weight	Cubic Feet
		Oak Walnut	Maple	Anigre						
32" Modular Pedestal, Box/Box/File, Lateral File	81P320220*	3931	4521	3537	32	20	26		114	13
	81P320224	4085	4697	3678	32	24	26		118	15

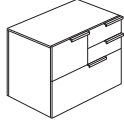

**ORDERING NOTES:** For elliptical top please specify 'EZ' after P in the model number.

32" Modular Pedestal, 4 Box/Lateral File	81P320518	4658	5359	4193	32	18	26		110	11
	81P320520	4007	4609	3607	32	20	26		114	13
	81P320524	4171	4796	3754	32	24	26		118	15
	81P320530*	4337	4988	3904	32	30	26		122	18
	81P320536	4510	5187	4060	32	36	26		126	22

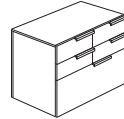

**ORDERING NOTES:** \*\*For use when adding to 24" deep cases where modesty panels exist.

32" Modular Pedestal, Bookcase	81P32BC18	3205	3684	2882	32	18	26		110	11
	81P32BC20*	2774	3189	2497	32	20	26		114	13
	81P32BC24	2891	3323	2602	32	24	26		118	15

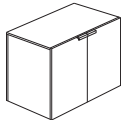

**ORDERING NOTES:** \*\*For use when adding to 24" deep cases where modesty panels exist.

32" Modular Pedestal, V-Ped with Box/Box/File	81P32FQL24*	4637	5332	4173	32	24	26		114	15
	81P32FQR24	4637	5332	4173	32	24	26		114	15



**ORDERING NOTES:** \*\*For use when adding to 24" deep cases where modesty panels exist.

36" Modular Pedestal, Lateral File	81P360120	3503	4028	3153	36	20	26		116	14
	81P360124*	3643	4189	3279	36	24	26		120	17
	81P360130	3790	4361	3411	36	30	26		124	21
	81P360136	3940	4533	3546	36	36	26		128	24

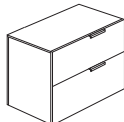

**ORDERING NOTES:** For elliptical top please specify 'EZ' after P in the model number.

36" Modular Pedestal, Box/Box/File, Lateral File	81P360418	4841	5566	4355	36	18	26		112	11
	81P360420*	4047	4654	3643	36	20	26		116	14
	81P360424	4209	4841	3788	36	24	26		120	17

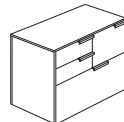

**ORDERING NOTES:** \*\*For use when adding to 24" deep cases where modesty panels exist.

## DIMENSION KEY

W - width  
D - depth  
H - height

## CODE DESCRIPTION

L - left hand pedestal position  
R - right hand pedestal position  
D - 2 file drawer  
F - 2 box, 1 file drawer  
0 - no pedestal  
J - TracDesk option  
W - extended pedestal option  
X31 - 3/4 height recessed modesty panel  
X41 - full height recessed modesty panel

## STANDARD FINISHES

For a complete list of standard wood finishes please see page 114.

## LOCKS/PULLS

Locks are standard on all pedestals and all lateral file drawers. For details on pull locations please see page 116.

## V-PED

Please see page 117 for details on V-Ped.

# VESTRADA | MODULAR PEDESTALS

Description	Model	Cherry Rift			W	D	H	Shipping Weight	Cubic Feet
		Oak Walnut Maple	Anigre	Palette					
36" Modular Pedestal,	81P360218	4841	5566	4355	36	18	26	112	11
File/Box/Box,	81P360220*	4047	4654	3643	36	20	26	116	14
Lateral File	81P360224	4209	4841	3788	36	24	26	120	17

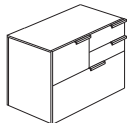

36" Modular Pedestal,	81P360520	4129	4748	3714	36	20	26	116	14
4 Box/Lateral File	81P360524	4293	4939	3866	36	24	26	120	17
	81P360530*	4462	5134	4019	36	30	26	124	21
	81P360536	4646	5344	4183	36	36	26	128	24

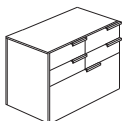

**ORDERING NOTES:** \*\*For use when adding to 24" deep cases where modesty panels exist.

36" Modular Pedestal,	81P36BC18	3271	3762	2946	36	18	26	112	11
Bookcase	81P36BC20	2959	3404	2663	36	20	26	116	14
	81P36BC24*	3077	3538	2770	36	24	26	120	17

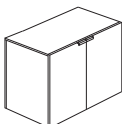

**ORDERING NOTES:** For elliptical top please specify 'EZ' after P in the model number.

40" Modular Pedestal,	81P4001QL24*	5273	6061	4744	40	24	26	118	18
V-Ped, Lateral File	81P4001QR24	5273	6061	4744	40	24	26	118	18

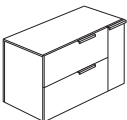

**ORDERING NOTES:** \*\*For use when adding to 24" deep cases where modesty panels exist.

40" Modular Pedestal,	81P4004QR24	6002	6902	5399	40	24	26	118	18
VPed, 2 Box/ 1 File, Lateral File									

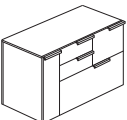

**ORDERING NOTES:** V-Ped is to be placed towards kneespace for appropriate access. This item is NOT available on KrugExpress.

40" Modular Pedestal,	81P4002QL24	6002	6902	5399	40	24	26	118	18
V-Ped, 1 File/2 Box, Lateral File									

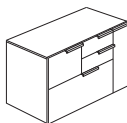

### ORDERING PROCEDURE

- To order, please specify the following:
- 1) Krug product model number
  - 2) Wood species and finish, see page 114
  - 3) Pull style and finish, see page 116
  - 4) V-Beam color, see page 117
  - 5) Grommet location and style if applicable

\* Indicates model illustrated by line drawing

### CODE DESCRIPTION

- L - left hand pedestal position
- R - right hand pedestal position
- D - 2 file drawer
- F - 2 box, 1 file drawer
- 0 - no pedestal
- J - TracDesk option
- W - extended pedestal option
- X31 - 3/4 height recessed modesty panel
- X41 - full height recessed modesty panel

### STANDARD FINISHES

For a complete list of standard wood finishes please see page 114.

### LOCKS/PULLS

Locks are standard on all pedestals and all lateral file drawers. For details on pull locations please see page 116.

### V-PED

Please see page 117 for details on V-Ped.

# VESTRADA | MODULAR PEDESTALS

Description	Model	Cherry Rift Oak Walnut			W	D	H	Shipping Weight	Cubic Feet
		Maple	Anigre	Palette					
40" Modular Pedestal, V-Ped, 4 Box/Lateral File	81P4005QL24	6081	6995	5473	40	24	26	118	18
	81P4005QR24*	6081	6995	5473	40	24	26	118	18

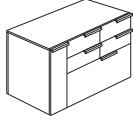

**ORDERING NOTES:**

V-Ped is to be placed towards kneespace for appropriate access. This item is NOT available on KrugExpress.

40" Modular Pedestal, Bookcase, V-Ped	81P40BCQL24*	4734	5443	4260	40	24	26	118	18
	81P40BCQR24	4734	5443	4260	40	24	26	118	18

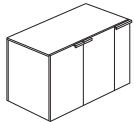

**ORDERING NOTES:**

V-Ped is to be placed towards kneespace for appropriate access. This item is NOT available on KrugExpress.

16" Support Pedestal	81PDZ16024L	2112	2429	1902	16	24	26	-	-
	81PDZ16024R*	2112	2429	1902	16	24	26	-	-
	81PDZ16030L	2185	2513	1966	16	30	26	-	-
	81PDZ16030R	2185	2513	1966	16	30	26	-	-
	81PD16030L	2112	2429	1902	16	30	26	-	-
	81PD16030R	2112	2429	1902	16	30	26	-	-
	81PD16036L	2185	2513	1966	16	36	26	-	-
	81PD16036R	2185	2513	1966	16	36	26	-	-

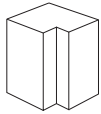

Mobile Pedestal, no Cushion	81MPS16F	2194	2524	1976	16	30	26	-	-
-----------------------------	----------	------	------	------	----	----	----	---	---

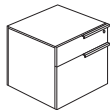

**ORDERING NOTES:**

This item is NOT available on KrugExpress.

Mobile Pedestal, Cushion	81MPSU16F	2618	3011	2356	16	30	26	-	-
--------------------------	-----------	------	------	------	----	----	----	---	---



**DIMENSION KEY**

W - width  
D - depth  
H - height

**CODE DESCRIPTION**

L - left hand pedestal position  
R - right hand pedestal position  
D - 2 file drawer  
F - 2 box, 1 file drawer  
0 - no pedestal  
J - TracDesk option  
W - extended pedestal option  
X31 - 3/4 height recessed modesty panel  
X41 - full height recessed modesty panel

**STANDARD FINISHES**

For a complete list of standard wood finishes please see page 114.

**GROMMETS**

One wiring grommet in standard position is optional at no charge. See page 117 for more wiring grommet information.

**PULL LOCATIONS**

For details please see page 116.

# VESTRADA | MODESTY PANELS

Description	Model	Cherry Rift Oak Walnut		W	D	H	Shipping Weight	Cubic Feet
		Maple	Anigre					
 3/4 Height Recessed Wood Modesty Panel for Desks	81MPD32X31*	908	1042	32	0.75	21.5	35	3
	81MPD40X31	958	1102	40	0.75	21.5	42	3
	81MPD48X31	995	1143	48	0.75	21.5	50	3
	81MPD56X31	1031	1185	56	0.75	21.5	60	3
	81MPD64X31	1082	1243	64	0.75	21.5	70	3
	81MPD72X31	1202	1383	72	0.75	21.5	80	3
	81MPD80X31	1305	1499	80	0.75	21.5	85	3

**ORDERING NOTES:** For wire management cut-out option on modesty panel, note clearly on purchase order and add \$194 list.

 Full Height Recessed Wood Modesty Panel for Desks	81MPD32X41	908	1042	32	0.75	28.5	35	3
	81MPD40X41	958	1102	40	0.75	28.5	42	3
	81MPD48X41	995	1143	48	0.75	28.5	50	3
	81MPD56X41	1031	1185	56	0.75	28.5	60	3
	81MPD64X41*	1082	1243	64	0.75	28.5	70	3
	81MPD72X41	1202	1383	72	0.75	28.5	80	3
	81MPD80X41	1305	1499	80	0.75	28.5	85	3

 Wood Face Mounted Modesty Panel for Desks	81MPZ48X31*	824	949	48	0.5	19	50	3
	81MPZ56X31	957	1098	56	0.5	21.5	60	3
	81MPZ64X31	1012	1164	64	0.5	21.5	70	3
	81MPZ72X31	1715	1974	72	0.5	21.5	80	3

 Glass Face Mounted Modesty Panel for Desks	81MPZ48X37*	1071		48	0.5	19	50	3
	81MPZ56X37	1187		56	0.75	21.5	60	3
	81MPZ64X37	1380		64	0.75	21.5	70	3
	81MPZ72X37	2316		72	0.75	21.5	80	3

**ORDERING NOTES:** Glass modesty panels are NOT available on KrugExpress.

 3/4 Height Modesty Panel for Credenzas	81MPC32X31*	908	1042	32	0.75	21.5	35	3
	81MPC40X31	958	1102	40	0.75	21.5	42	3
	81MPC48X31	995	1143	48	0.75	21.5	50	3
	81MPC56X31	1031	1185	56	0.75	21.5	60	3
	81MPC64X31	1082	1243	64	0.75	21.5	70	3
	81MPC72X31	1202	1383	72	0.75	21.5	80	3

**ORDERING NOTES:** For wire management cut-out option on modesty panel, note clearly on purchase order and add \$194 list.

## ORDERING PROCEDURE

- To order, please specify the following:
- 1) Krug product model number
  - 2) Wood species and finish, see page 114
  - 3) Pull style and finish, see page 116
  - 4) V-Beam color, see page 117
  - 5) Grommet location and style if applicable

\* Indicates model illustrated by line drawing

## CODE DESCRIPTION

- X31 - 3/4 height recessed modesty panel
- X41 - full height recessed modesty panel

## STANDARD FINISHES

For a complete list of standard wood finishes please see page 114.

# VESTRADA | MODESTY PANELS

Description	Model	Cherry Rift Oak Walnut		W	D	H	Shipping Weight	Cubic Feet
		Maple	Anigre					
 Full Height Modesty Panel for Credenzas	81MPC32X41*	908	1042	32	0.75	28.5	35	3
	81MPC40X41	958	1102	40	0.75	28.5	42	3
	81MPC48X41	995	1143	48	0.75	28.5	50	3
	81MPC56X41	1031	1185	56	0.75	28.5	60	3
	81MPC64X41	1082	1243	64	0.75	28.5	70	3
	81MPC72X41	1202	1383	72	0.75	28.5	80	3

**ORDERING NOTES:** For wire management cut-out option on modesty panel, note clearly on purchase order and add **\$194 list**.

Description	Model	Cherry Rift Oak Walnut		W	D	H	Shipping Weight	Cubic Feet
		Maple	Anigre					
 Hinged Modesty Panel for Credenzas	81MPY32X41*	955	1096	32	0.75	28.5	35	3
	81MPY40X41	1006	1157	40	0.75	28.5	42	3
	81MPY48X41	1044	1201	48	0.75	28.5	50	3
	81MPY56X41	1082	1243	56	0.75	28.5	60	3
	81MPY64X41	1136	1306	64	0.75	28.5	70	3
	81MPY72X41	1262	1451	72	0.75	28.5	80	3

**ORDERING NOTES:** Hinged modesty panels come standard with a wire management cut-out.

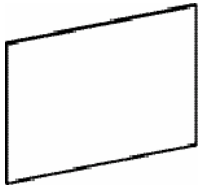
Description	Model	Cherry Rift Oak Walnut		W	D	H	Shipping Weight	Cubic Feet
		Maple	Anigre					
 Full Height Modesty Panel for Returns	81MPR24X41	854	983	24	0.75	29.5	28	3
	81MPR32X41	908	1042	32	0.75	28.5	35	3
	81MPR36X41*	934	1073	36	0.75	28.5	40	3
	81MPR40X41	958	1102	40	0.75	28.5	42	3
	81MPR44X41	978	1122	44	0.75	28.5	52	3
	81MPR48X41	995	1143	48	0.75	28.5	55	3
	81MPR52X41	1015	1166	52	0.75	28.5	58	3
	81MPR56X41	1031	1185	56	0.75	28.5	60	3
	81MPR64X41	1082	1243	64	0.75	28.5	70	3
	81MPR72X41	1202	1383	72	0.75	28.5	80	3
	81MPR80X41	1305	1499	80	0.75	28.5	90	3

**ORDERING NOTES:** For hinged modesty panel option, replace 'R' with 'Y' (81MPY40X41) and add a 10% upcharge. For wire management cut-out option on modesty panel, note clearly on purchase order and add **\$194 list**.

**DIMENSION KEY**

W - width  
D - depth  
H - height

**CODE DESCRIPTION**

L - left hand pedestal position  
R - right hand pedestal position  
D - 2 file drawer  
F - 2 box, 1 file drawer  
0 - no pedestal  
J - TracDesk option  
W - extended pedestal option  
X31 - 3/4 height recessed modesty panel  
X41 - full height recessed modesty panel

**STANDARD FINISHES**

For a complete list of standard wood finishes please see page 114.

# VESTRADA | WORK TABLES

Description	Model	Cherry Rift		W	D	H	Shipping Weight	Cubic Feet
		Oak Walnut Maple	Anigre					
Delta Table, no Casters, Desk Height	81TH0336	2017	2319	36	36	29.25	57	27
	81TH0342*	2043	2352	42	42	29.25	71	36

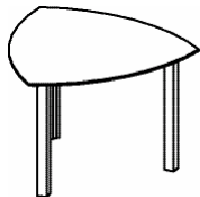

Delta Table, with Casters, Desk Height	81TH0336M	2058	2364	36	36	29.25	57	27
	81TH0342M*	2085	2396	42	42	29.25	71	36

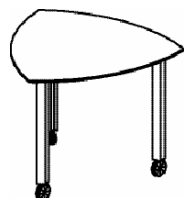

Delta Table, no Casters, Machine Height	81TM0336	2017	2319	36	36	28.25	58	27
	81TM0342*	2043	2352	42	42	28.25	72	36

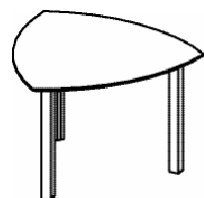

Delta Table, with Casters, Machine Height	81TM0336M	2058	2364	36	36	28.25	58	27
	81TM0342M*	2085	2396	42	42	28.25	72	36



### ORDERING PROCEDURE

- To order, please specify the following:
- 1) Krug product model number
  - 2) Wood species and finish, see page 114
  - 3) Pull style and finish, see page 116
  - 4) V-Beam color, see page 117
  - 5) Grommet location and style if applicable

\* Indicates model illustrated by line drawing

### CODE DESCRIPTION

- M - with casters
- TH - desk height table
- TM - machine height table
- 01 - arc square
- 03 - delta
- 05 - round

### STANDARD FINISHES

For a complete list of standard wood finishes please see page 114.

### CASTERS

All casters on mobile tables are locking.

### KRUG EXPRESS

Mobile & work tables are NOT available on KrugExpress

# VESTRADA | WORK TABLES

Description	Model	Price	W	D	H	Shipping Weight	Cubic Feet
Glass Delta Table, no Casters, Machine Height	81TMG0336	3847	36	36	28.25	91	36

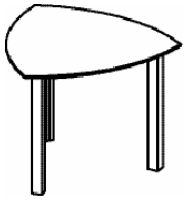

Glass Delta Table, with Casters, Machine Height	81TMG0336M	3921	36	36	28.25	91	36
---	------------	------	----	----	-------	----	----

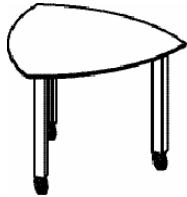

Cherry Rift  
Oak Walnut  
Maple Anigre

Arc Square Table, no Casters, Desk Height	81TH013636	1982	2279	36	36	29.25	75	27
	81TH014242*	2007	2308	42	42	29.25	90	36

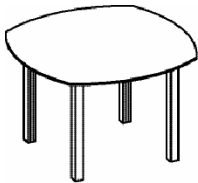

Arc Square Table, with Casters, Desk Height	81TH013636M	2023	2324	36	36	29.25	75	27
	81TH014242M*	2051	2356	42	42	29.25	90	36



**DIMENSION KEY**

W - width  
D - depth  
H - height

**CODE DESCRIPTION**

M - with casters  
TH - desk height table  
TM - machine height table  
01 - arc square  
03 - delta  
05 - round

**STANDARD FINISHES**

For a complete list of standard wood finishes please see page 114.

**CASTERS**

All casters on mobile tables are locking.

**KRUG EXPRESS**

Mobile & work tables are NOT available on KrugExpress

# VESTRADA | WORK TABLES

Description	Model	Cherry Rift		W	D	H	Shipping Weight	Cubic Feet
		Oak Walnut Maple	Anigre					
Arc Square Table, no Casters, Machine Height	81TM013636M	2023	2324	36	36	28.25	75	27
	81TM014242M*	2051	2356	42	42	28.25	91	36

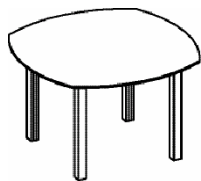

Arc Square Table, with Casters, Machine Height	81TM013636	1982	2279	36	36	28.25	75	27
	81TM014242*	2007	2308	42	42	28.25	91	36



Round Table, no Casters, Desk Height	81TH0536	1911	2196	36	36	29.25	69	27
	81TH0542*	1956	2250	42	42	29.25	75	36

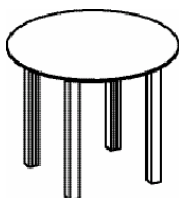

Round Table, with Casters, Desk Height	81TH0536M	1951	2242	36	36	29.25	69	27
	81TH0542M*	1995	2295	42	42	29.25	75	36



### ORDERING PROCEDURE

To order, please specify the following:

- 1) Krug product model number
- 2) Wood species and finish, see page 114
- 3) Pull style and finish, see page 116
- 4) V-Beam color, see page 117
- 5) Grommet location and style if applicable

\* Indicates model illustrated by line drawing

### CODE DESCRIPTION

- M - with casters
- TH - desk height table
- TM - machine height table 01 - arc square
- 03 - delta
- 05 - round

### STANDARD FINISHES

For a complete list of standard wood finishes please see page 114.

### LOCKS/PULLS

Locks are standard on all pedestals and all lateral file drawers. For details on pull locations please see page 116.

### V-PED

Please see page 117 for details on V-Ped.



# VESTRADA | WORK TABLES

Description	Model	Cherry Rift Oak Walnut		W	D	H	Shipping Weight	Cubic Feet
		Maple	Anigre					
Round Table, no Casters, Machine Height	81TM0536	1911	2196	36	36	28.25	69	27
	81TM0542*	1956	2250	42	42	28.25	75	36

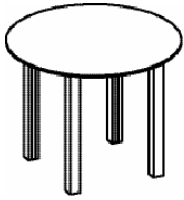

Round Table, with Casters, Machine Height	81TM0536M	1951	2242	36	36	28.25	69	27
	81TM0542M*	1995	2295	42	42	28.25	75	36



Rectangular Mobile Table with Casters, Floating Wood Modesty Panel, Desk Height	81CTHV4224MX31	2201	2531	42	24	28.25	98	14
	81CTHV4824MX31*	2254	2593	48	24	28.25	112	16



Rectangular Mobile Table with Casters, Floating Wood Mod- esty Panel, Machine Height	81CTMV4224MX31	2201	2531	42	24	28.25	96	14
	81CTMV4824MX31*	2254	2593	48	24	28.25	110	16



**DIMENSION KEY**

W - width  
D - depth  
H - height

**CODE DESCRIPTION**

M - with casters  
TH - desk height table  
TM - machine height table  
01 - arc square  
03 - delta  
05 - round

**STANDARD FINISHES**

For a complete list of standard wood finishes please see page 114.

**GROMMETS**

One wiring grommet in standard position is optional at no charge. See page 117 for more wiring grommet information.

**PULL LOCATIONS**

For details please see page 116.

# POWERPORTS

Description	Model	Price	W	D	H	Shipping Weight	Cubic Feet
PowerPort 1 - 2 RJ45s (Category 5/6)	PORT1	278	8	4	-	-	-

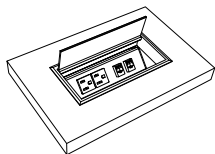

**Port Includes:** 2 accessible power outlets & 1 side utility outlet powered by a 10' plug-in cord; 2 RJ45 (category 5/6) each with hard wired 10' data cords; 2 velcro wire managers and metal PowerPort shroud. PortPort lid is Silver Metallic.  
**NOTE:** RJ45 jacks with hard wired data cords included here must be within 10' of building utilities source to be functional.

PowerPort 2 - USB-A & USB-C	PORT2	280	8	4	-	-	-
--------------------------------	-------	-----	---	---	---	---	---

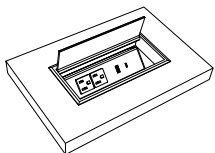

**Port Includes:** 2 accessible power outlets & 1 side utility outlet; 1 USB-A & 1 USB-C charging ports all powered by a 10' plug-in cord; 2 velcro wire managers and metal PowerPort shroud. PortPort lid is Silver Metallic.

PowerPort 3 - RJ11 & RJ45	PORT3	269	8	4	-	-	-
------------------------------	-------	-----	---	---	---	---	---

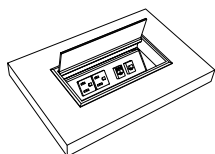

**Port Includes:** 2 accessible power outlets & 1 side utility outlet; 1 RJ11 & 1 RJ45 (Category 5/6); 2 Velcro wire managers & PowerPort Shroud; 1 x 10 Foot Data Cords (T568A) & 1 x 14 Foot RJ11 (Telecomm); powered by a 10' plug-in cord. PortPort lid is Silver Metallic.  
**NOTE:** RJ45 & RJ11 jacks with hard wired data cords included here must be within 10' of building utilities source to be functional.

PowerPort 4 - 2 USB-A	PORT4	286	8	4	-	-	-
--------------------------	-------	-----	---	---	---	---	---

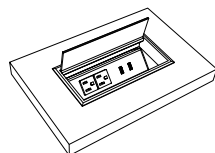

**Port Includes:** 2 accessible power outlets & 1 side utility outlet; 2- USB-A charging ports all powered by a 10' plug-in cord; 2 velcro wire managers and metal PortPort shroud. PortPort lid is Silver Metallic.

PowerPort 5 - 4 Receptacles	PORT5	280	8	4	-	-	-
--------------------------------	-------	-----	---	---	---	---	---

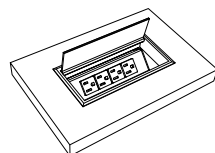

**Port Includes:** 4 accessible power outlets & 1 side utility outlet powered by a 10' plug-in cord; 2 velcro wire managers and metal power port shroud. PortPort lid is Silver Metallic.

PowerPort 6 - USB-A, USB-C & RJ45	PORT6	406	8	4	-	-	-
--------------------------------------	-------	-----	---	---	---	---	---

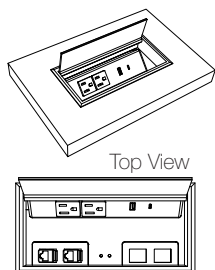

**Port Includes:** 2 accessible power outlets & 1 side utility outlet 1 USB-A, 1 USB-C charging ports all powered by a 10' plug-in power cord. Includes 2 velcro wire managers and metal PortPort shroud with 2 data plate knock outs, 1 #M02 plate insert & 2 #S01W RJ45 female input, punch down terminal output snap in jacks. 2nd data plate knock out is blank for future use. PortPort lid is Silver Metallic.

Description	Model	Price	W	D	H	Shipping Weight	Cubic Feet
Port - no Powerbar	Port0	137	8	4	-	-	-

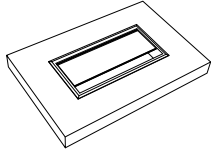

**Port Includes:** Port lid & Shroud only.

**ORDERING NOTE:** Velcro wire managers not included, see below for pricing. Port lid is Silver Metallic.

PowerPort Shroud with 2 Data Plate Knock-outs	SHROUD2KO	Must be requested - no upcharge	-	-	-	-	-
---	-----------	------------------------------------	---	---	---	---	---

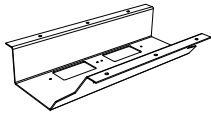

Angled PowerPort Shroud Includes: shroud with 2 data plate knock-outs in the bottom

**ORDERING NOTE:** Please refer to data plate, data and AV integration options on page 199.

Velcro Wire Manager (qty 1)	WM-4	26	2	4.5	0.5	-	-
-----------------------------	------	----	---	-----	-----	---	---

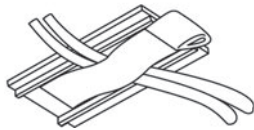

2 velcro wire managers are included with Ports 1-5.

Wire Management Trough	WM-72	182	72	3	1	-	-
------------------------	-------	-----	----	---	---	---	---



Wire Management Trough is standard in a 72" length & can be cut to specific length; double-sided tape installation.

4-Channel Wire Management	CM-72	231	72	3	1	-	-
---------------------------	-------	-----	----	---	---	---	---

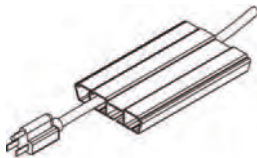

4-Channel Wire Management is standard in a 72" length & can be cut to specific length; double-sided tape installation.

Round Grommet	Round Grommet - Silver Metallic	152	-	-	-	-	-
	Round Grommet - Black	152	-	-	-	-	-



One 60mm Grommet in a standard position is available at no charge per table.

# POWER/DATA

SNAP IN PORTS      Reference Code      Description      List Price

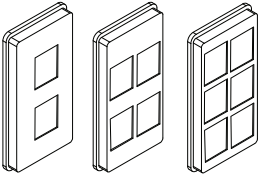
<b>ADAPTOR PLATES</b>			
	<b>M02</b>	<b>Adaptor Plate (2)</b> - accepts two snap in data ports	38
	<b>M04</b>	<b>Adaptor Plate (4)</b> - accepts four snap in data ports	38
	<b>M06</b>	<b>Adaptor Plate (6)</b> - accepts six snap in data ports	38

**ORDERING NOTES:** Blank covers are required when port is not in use, please see page 55.

		<b>RJ-45</b> - Category 6 data connection. This connector is also downwards compatible with Category 5 cabling. Connector is a female input with a #110 punch-down terminal block output (back side of Console interface) for on-site hard wire connection.	47
	<b>S01W</b>	RJ45-CAT6 (White)	
	<b>S01B</b>	RJ45-CAT6 (Blue)	
	<b>S01R</b>	RJ45-CAT6 (Red)	

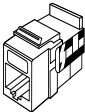
		<b>RJ11</b> - Telephone type connection. Connector is a female input with a #110 punch-down terminal block output (back side of Console interface) for on-site hard wire connection.	32
	<b>S02W</b>	RJ11 (White)	
	<b>S02B</b>	RJ11-B (Black)	
	<b>S02G</b>	RJ11-G (Green)	
	<b>S02R</b>	RJ11-R (Red)	
	<b>S02Y</b>	RJ11-Y (Yellow)	

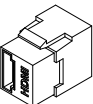
	<b>S04</b>	<b>HDMI</b> - High Definition Multimedia Interface connection. Connector carries both HD audio and video data. Connector is a female-to-female pass through.	173
--	------------	--	-----

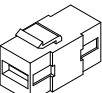
	<b>S08</b>	<b>USB-A</b> - Full size USB "A" style connection. Connector is a female-to-female pass through.	61
--	------------	--	----



Description	Model	Price	W	D	H	Shipping Weight	Cubic Feet
Rectangular Grommet	GROMMET	152	4.13	2.69	-	-	-

 **ORDERING NOTES:** Please see page 117 for information on rectangular grommet and it's locations. One rectangular grommet in standard position is optional at no upcharge. Please specify color.

Height Adjustable Table Programmable Display- 4 Position Memory	88HAPD	377	-	-	-	-	-
---	--------	-----	---	---	---	---	---

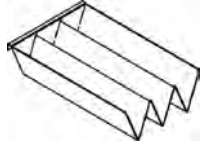
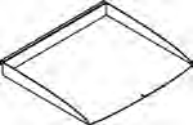

# VESTRADA | ACCESSORIES

Description	Model	Price	W	D	H	Shipping Weight	Cubic Feet
File Organizer	81AFO	114	6	9.75	2.5	1.75	2
							
Paper Tray	81APT	100	12	10.75	2	1.75	4
							
Organizer Rails	81AOB64	114	64	-	2.5	-	-
	81AOB72	122	72	-	2.5	-	-
	81AOB80	128	80	-	2.5	-	-
	81AOB88	128	88	-	2.5	-	-
	81AOB96	140	96	-	2.5	-	-
							
Privacy Screens	81SC3614G	381	32	0.25	14	30	8
	81SC4014G	433	38	0.25	14	40	10
	81SC4814G	487	46	0.25	14	50	12
	81SC5614G	556	54	0.25	14	60	14
	81SC6414G	614	62	0.25	14	70	16
	81SC7214G	670	70	0.25	14	80	18
	81SC8014G	703	78	0.25	14	80	18
	81SC8814G	739	86	0.25	14	85	20
81SC9614G	827	94	0.25	14	90	22	
							

**ORDERING NOTES:**

The model number sizing reflects appropriate worksurface size. Glass screens are inset on appropriate top size. Glass screens are NOT available on KrugExpress.

Articulating Keyboard Tray	81KBAMT1912	694	-	-	-	20	2
----------------------------	-------------	-----	---	---	---	----	---



Binder Bin	81ABB	140	4	10	10	3	1
------------	-------	-----	---	----	----	---	---

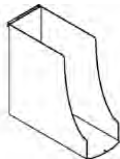

Hanging File Bars	81AFB	114	1.75	9.75	2.5	0.5	1
-------------------	-------	-----	------	------	-----	-----	---



# VESTRADA | WALL HUNG OVERHEADS

Description	Model	Cherry Rift		W	D	H	Doors	Shipping Weight	Cubic Feet
		Oak Walnut	Maple						
Single Height Wall Hung Overhead with Wood Doors	81OHW321614HL	2554	2936	32	16	13.5	2	118	6
	81OHW361614HL	2665	3067	36	16	13.5	2	122	7
	81OHW441614HL	2937	3381	44	16	13.5	2	129	8
	81OHW481614HL	3029	3484	48	16	13.5	3	140	9
	81OHW641614HL*	3573	4108	64	16	13.5	4	158	11

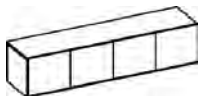

**ORDERING NOTES:** Locks are optional on all wood doors for an upcharge of **\$152 list per set** of 2 doors. Locks are standard on all lateral files and file drawer

Single Height Wall Hung Overhead with Glass Doors	81OHW321614HLG	2860	3290	32	16	13.5	2	128	6
	81OHW361614HLG	2986	3432	36	16	13.5	2	132	7
	81OHW441614HLG	3290	3784	44	16	13.5	2	139	8
	81OHW481614HLG	3390	3899	48	16	13.5	3	150	9
	81OHW641614HLG*	4001	4602	64	16	13.5	4	168	11



Single Height Wall Hung Overhead, Open	81OOW321614HL	1620	1862	32	16	13.5	2	108	6
	81OOW361614HL	1698	1953	36	16	13.5	2	112	7
	81OOW441614HL	1798	2066	44	16	13.5	2	119	8
	81OOW481614HL	1879	2160	48	16	13.5	3	130	9
	81OOW641614HL*	2352	2703	64	16	13.5	4	148	11



Double Height Wall Hung Overhead with Wood Doors	81OHW321628HL	3049	3507	32	16	27	2	230	11
	81OHW361628HL	3184	3662	36	16	27	2	240	12
	81OHW441628HL	3489	4011	44	16	27	2	250	14
	81OHW481628HL*	3602	4141	48	16	27	3	275	16

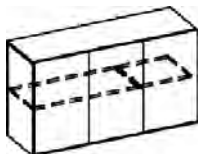

**ORDERING NOTES:** Locks are optional on all wood doors for an upcharge of **\$152 list per set** of 2 doors. Locks are standard on all lateral files and file drawer

Double Height Wall Hung Overhead with Glass Doors	81OHW321628HLG	3414	3927	32	16	27	2	240	11
	81OHW361628HLG	3564	4099	36	16	27	2	250	12
	81OHW441628HLG	3907	4491	44	16	27	2	260	14
	81OHW481628HLG*	4033	4637	48	16	27	3	285	16



### DIMENSION KEY

W - width  
D - depth  
H - height

### CODE DESCRIPTION

L - door hinged left  
R - door hinged right  
G - matte Silver framed glass doors  
ST - storage unit  
OHW - overhead with wood doors  
OOW - open overhead

### STANDARD FINISHES

For a complete list of standard wood finishes please see page 114. If specifying a palette finish, change model number prefix to 83, e.g. 83OH0814LURE.

### STORAGE DOORS

Narrow doors hinge off the edge of the case, whereas wider doors hinge off center partition.

# VESTRADA |

Hutches include a tackboard, priced at Gr 1/COM. Use this chart to get the upcharges for tackboard fabrics graded 2-9, and add it to the list price of the hutch

Fabric Grades

	1	2	3	4	5	6	7	8	9	W	H	COM	WT
81TBOHW3224U	336	372	410	470	613	747	886	1030	1151	31.75	24	1	8
81TBOHW3624U	337	374	411	471	614	749	654	1210	1152	35.75	24	1.5	10
81TBOHW4424U	382	514	543	674	811	935	1073	1237	1389	41.75	24	1.5	11
81TBOHW4824U	416	516	541	679	815	935	1081	1240	1421	47.75	24	1.75	12
81TBOHW6424U	516	703	691	917	1102	1309	1488	1699	1927	64	24	2	15

**ORDERING NOTES:**

Krug panel fabrics are available at grade 1 pricing. See page 4 for more information. Only Krug panel fabrics are available on KrugExpress. Please contact Customer Service for information on yardage required when ordering two or more tackboards.

**ORDERING PROCEDURE**

To order, please specify the following:

- 1) Krug product model number
- 2) Wood species and finish, see page 114
- 3) Pull style and finish, see page 116
- 4) V-Beam color, see page 117
- 5) Grommet location and style if applicable

\* Indicates model illustrated by line drawing

**VESTRADA | STORAGE**

Description	Model	Cherry Rift		W	D	H	Shipping Weight	Cubic Feet
		Oak Walnut	Maple					
2 Hi, Lateral File	81ST32202901	3668	4216	32	20	29.3	129	14
	81ST32242901*	3718	4277	32	24	29.3	155	17
	81ST36202901	3781	4347	36	20	29.3	151	16
	81ST36242901	3834	4407	36	24	29.3	181	19



**ORDERING NOTES:**

This unit features a V-Beam and therefore cannot accommodate 2 rows of binders.

2 Hi, Closed Bookcase	81ST32202911	2790	3209	32	20	29.3	94	14
	81ST32242911*	2838	3265	32	24	29.3	120	17
	81ST36202911	2878	3307	36	20	29.3	116	16
	81ST36242911	2928	3368	36	24	29.3	146	19



**ORDERING NOTES:**

This unit features a V-Beam and therefore cannot accommodate 2 rows of binders.

3 Hi, Lateral File	81ST32204201	4616	5309	32	20	41.8	164	20
	81ST32244201*	4712	5421	32	24	41.8	183	23
	81ST36204201	4758	5472	36	20	41.8	196	22
	81ST36244201	4859	5586	36	24	41.8	218	26



4 Hi, Single Width, Closed Shelves with Wood Door	81ST16205611L	2958	3403	16	20	55.5	125	14
	81ST16205611R	2958	3403	16	20	55.5	125	14
	81ST16245611L*	2991	3439	16	24	55.5	148	17
	81ST16245611R	2991	3439	16	24	55.5	148	17



**ORDERING NOTES:**

Locks are optional on all wood doors for an upcharge of **\$152 list** per set of 2 doors. Locks are standard on all lateral files and file drawer

**DIMENSION KEY**

W - width  
D - depth  
H - height

**CODE DESCRIPTION**

L - door hinged left  
R - door hinged right  
G - matte Silver framed glass doors  
ST - storage unit  
BC - bookcase  
WR - wardrobe

**STANDARD FINISHES**

For a complete list of standard wood finishes please see page 114.

**GROMMETS**

One wiring grommet in standard position is optional at no charge. See page 117 for more wiring grommet information.

**PULL LOCATIONS**

For details please see page 116.



# VESTRADA | STORAGE

Description	Model	Cherry Rift		W	D	H	Shipping Weight	Cubic Feet
		Oak Walnut	Maple					
 4 Hi, Lateral File	81ST32205601	5360	6162	32	20	55.5	220	26
	81ST32245601*	5473	6293	32	24	55.5	245	31
	81ST36205601	5523	6350	36	20	55.5	245	29
	81ST36245601	5640	6486	36	24	55.5	270	34

 4 Hi, Open Shelves	81ST32205617	3920	4507	32	20	55.5	175	26
	81ST32245617*	4070	4681	32	24	55.5	195	28
	81ST36205617	4035	4638	36	20	55.5	195	29
	81ST36245617	4193	4822	36	24	55.5	205	35

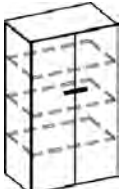
 4 Hi, Closed Shelves with Wood Doors	81ST32205611*	4392	5049	32	20	55.5	185	26
	81ST32245611	4580	5264	32	24	55.5	205	31
	81ST36205611	4521	5196	36	20	55.5	205	29
	81ST36245611	4718	5425	36	24	55.5	235	34

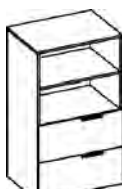
 4 Hi, 2 Lateral Files, 2 Open Shelves	81ST32205603	4432	5097	32	20	55.5	195	26
	81ST32245603*	4507	5183	32	24	55.5	220	31
	81ST36205603	4574	5261	36	20	55.5	220	29
	81ST36245603	4648	5345	36	24	55.5	245	34

**ORDERING NOTES:**

Locks are optional on all wood doors for an upcharge of **\$152 list per set** of 2 doors. Locks are standard on all lateral files and file drawer

**ORDERING PROCEDURE**

To order, please specify the following:

- 1) Krug product model number
- 2) Wood species and finish, see page 114
- 3) Pull style and finish, see page 116
- 4) V-Beam color, see page 117
- 5) Grommet location and style if applicable

\* Indicates model illustrated by line drawing

**CODE DESCRIPTION**

- L - door hinged left
- R - door hinged right
- G - matte Silver framed glass doors
- ST - storage unit
- BC - bookcase
- WR - wardrobe

**STANDARD FINISHES**

For a complete list of standard wood finishes please see page 114. If specifying a palette finish, change model number prefix to 83, e.g. 83OH0814LURE

**ADJUSTABLE SHELVING**

Storage units feature adjustable shelves that are adjustable in increments of approximately 1-1/4".

**VESTRADA | STORAGE**

Description	Model	Cherry Rift		W	D	H	Shipping Weight	Cubic Feet
		Oak Walnut	Maple					
4 Hi, 2 Lateral Files, 2 Closed Shelves with Wood Doors	81ST32205604	4469	5139	32	20	55.5	210	26
	81ST32245604*	4555	5238	32	24	55.5	235	31
	81ST36205604	4609	5299	36	20	55.5	235	29
	81ST36245604	4693	5397	36	24	55.5	260	34

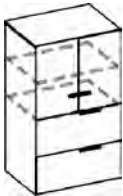

4 Hi, 2 Closed Shelves, 2 Open Shelves	81ST32205613	4312	4959	32	20	55.5	165	26
	81ST32245613*	4500	5173	32	24	55.5	190	31
	81ST36205613	4437	5105	36	20	55.5	190	29
	81ST36245613	4637	5332	36	24	55.5	245	34

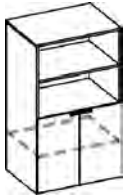

5 Hi, Single Width, Closed Shelves with Wood Door	81ST16207011L	3071	3533	16	20	69	143	17
	81ST16207011R	3071	3533	16	20	69	143	17
	81ST16247011L*	3127	3595	16	24	69	172	20
	81ST16247011R	3127	3595	16	24	69	172	20



5 Hi, Single Width, 2 Closed Shelves, 3 Open Shelves	81ST16207013L	3209	3690	16	20	69	111	17
	81ST16207013R	3209	3690	16	20	69	111	17
	81ST16247013L*	3257	3743	16	24	69	115	20
	81ST16247013R	3257	3743	16	24	69	115	20



**ORDERING NOTES:**

Locks are optional on all wood doors for an upcharge of **\$152 list per set** of 2 doors. Locks are standard on all lateral files and file drawer

**DIMENSION KEY**

W - width  
D - depth  
H - height

**CODE DESCRIPTION**

L - door hinged left  
R - door hinged right  
G - matte Silver framed glass doors  
ST - storage unit  
BC - bookcase  
WR - wardrobe

**STANDARD FINISHES**

For a complete list of standard wood finishes please see page 114. If specifying a palette finish, change model number prefix to 83, e.g. 83OH0814LURE.

**ADJUSTABLE SHELVING**

Storage units feature adjustable shelves that are adjustable in increments of approximately 1-1/4".

# VESTRADA | STORAGE

Description	Model	Cherry Rift		W	D	H	Shipping Weight	Cubic Feet
		Oak Walnut Maple	Anigre					
5 Hi, Single Width, 2 Closed Shelves, 3 Closed Shelves with Matte Silver Framed Glass Door	81ST16207014LG	3589	4129	16	20	69	150	17
	81ST16207014RG	3589	4129	16	20	69	150	17
	81ST16247014LG*	3672	4223	16	24	69	180	20
	81ST16247014RG	3672	4223	16	24	69	180	20



5 Hi, Open Shelves	81ST32207017*	4134	4756	32	20	69	200	32
	81ST32247017	4459	5128	32	24	69	210	38
	81ST36207017	4259	4897	36	20	69	210	34
	81ST36247017	4599	5287	36	24	69	220	42

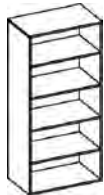

5 Hi, Closed Shelves with Wood Doors	81ST32207011	4564	5248	32	20	69	220	32
	81ST32247011*	4659	5360	32	24	69	230	38
	81ST36207011	4704	5406	36	20	69	230	36
	81ST36247011	4796	5517	36	24	69	240	42

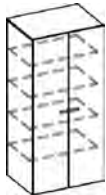

5 Hi, 2 Closed Shelves, 3 Open Shelves	81ST32207013*	4515	5192	32	20	69	210	32
	81ST32247013	4611	5302	32	24	69	220	38
	81ST36207013	4653	5351	36	20	69	220	36
	81ST36247013	4752	5465	36	24	69	230	42



**ORDERING NOTES:**

Locks are optional on all wood doors for an upcharge of **\$152 list per set** of 2 doors. Locks are standard on all lateral files and file drawer

**ORDERING PROCEDURE**

To order, please specify the following:

- 1) Krug product model number
- 2) Wood species and finish, see page 114
- 3) Pull style and finish, see page 116
- 4) V-Beam color, see page 117
- 5) Grommet location and style if applicable

\* Indicates model illustrated by line drawing

**CODE DESCRIPTION**

- G - glass
- OB - organizer bar
- ABB - binder bin
- AFB - file bar
- AFO - file organizer
- APT - paper tray

**STANDARD FINISHES**

For a complete list of standard wood finishes please see page 114. If specifying a palette finish, change model number prefix to 83, e.g. 83OH0814LURE

**ADJUSTABLE SHELVING**

Storage units feature adjustable shelves that are adjustable in increments of approximately 1-1/4".

**VESTRADA | STORAGE**

Description	Model	Cherry Rift		W	D	H	Shipping Weight	Cubic Feet
		Oak Walnut	Maple					
5 Hi, 2 Closed Shelves, 3 Closed Shelves with Matte Silver Framed Glass Doors	81ST32207014G	5293	6085	32	20	69	171	32
	81ST32247014G*	5437	6253	32	24	69	178	38
	81ST36207014G	5452	6268	36	20	69	192	36
	81ST36247014G	5600	6439	36	24	69	200	42



5 Hi, 2 Lateral Files, 3 Open Shelves	81ST32207003	5493	6315	32	20	69	160	32
	81ST32247003*	5560	6394	32	24	69	167	38
	81ST36207003	5660	6510	36	20	69	180	36
	81ST36247003	5733	6594	36	24	69	188	42



5 Hi, 2 Lateral Files, 3 Closed Shelves with Wood Doors	81ST32207004	6135	7053	32	20	69	171	32
	81ST32247004*	6206	7134	32	24	69	178	38
	81ST36207004	6323	7271	36	20	69	192	36
	81ST36247004	6394	7355	36	24	69	200	42



**ORDERING NOTES:**

Locks are optional on all wood doors for an upcharge of **\$152 list per set** of 2 doors. Locks are standard on all lateral files and file drawer

**DIMENSION KEY**

W - width  
D - depth  
H - height

**CODE DESCRIPTION**

L - door hinged left  
R - door hinged right  
G - matte Silver framed glass doors  
ST - storage unit  
BC - bookcase  
WR - wardrobe

**STANDARD FINISHES**

For a complete list of standard wood finishes please see page 114. If specifying a palette finish, change model number prefix to 83, e.g. 83OH0814LURE.

**ADJUSTABLE SHELVING**

Storage units feature adjustable shelves that are adjustable in increments of approximately 1-1/4".

# VESTRADA | STORAGE

Description	Model	Cherry Rift Oak Walnut		W	D	H	Shipping Weight	Cubic Feet
		Maple	Anigre					
5 Hi, 2 Lateral Files, 3 Closed Shelves with Matte Silver Framed Glass Doors	81ST32207004G	6609	7599	32	20	69	191	32
	81ST32247004G*	6679	7680	32	24	69	198	38
	81ST36207004G	6797	7818	36	20	69	212	36
	81ST36247004G	6870	7900	36	24	69	220	42

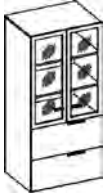

**ORDERING NOTES:**

Locks are not available on glass doors.

5 Hi, 4 Larteral Files, 1 Open Shelf	81ST32207005	6742	7755	32	20	69	240	32
	81ST32247005*	6829	7854	32	24	69	290	38
	81ST36207005	6951	7994	36	20	69	290	36
	81ST36247005	7041	8094	36	24	69	350	42



5 Hi, 2 Files/3 Wood Closed Shelves, 5 Open Shelves	81ST24207080	4415	5077	24	20	69	220	25
	81ST24207081	4415	5077	24	20	69	220	25
	81ST24247080*	4504	5179	24	24	69	260	29
	81ST24247081	4504	5179	24	24	69	260	29

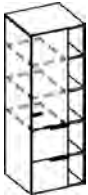

**ORDERING NOTES:**

(80) Indicates left 3 closed wood doors and 2 file drawers, right 5 open

(81) Indicates left open, right 3 closed wood doors and 2 file drawers.

**ORDERING PROCEDURE**

To order, please specify the following:

- 1) Krug product model number
- 2) Wood species and finish, see page 114
- 3) Pull style and finish, see page 116
- 4) V-Beam color, see page 117
- 5) Grommet location and style if applicable

\* Indicates model illustrated by line drawing

**CODE DESCRIPTION**

- L - door hinged left
- R - door hinged right
- G - matte Silver framed glass doors
- ST - storage unit
- BC - bookcase
- WR - wardrobe

**STANDARD FINISHES**

For a complete list of standard wood finishes please see page 114. If specifying a palette finish, change model number prefix to 83, e.g. 83OH0814LURE.

**24" WIDE COMBINATION**

Narrow doors hinge off the edge of the case, whereas wider doors hinge off center partition.

# VESTRADA | STORAGE

Description	Model	Cherry Rift Oak Walnut		W	D	H	Shipping Weight	Cubic Feet
		Maple	Anigre					
5 Hi, 2 Files/3 Closed Shelves with Matte	81ST24207080G	4809	5528	24	20	69	220	25
Silver Framed Glass Door, 5 Open	81ST24247081G	4809	5528	24	20	69	220	25
	81ST24247080G*	4902	5636	24	24	69	260	29
	81ST24247081G	4902	5636	24	24	69	260	29



**ORDERING NOTES:**

(80G) Indicates left 3 closed glass doors and 2 file drawers, right 5 open  
 (81G) Indicates left open, right 3 glass wood doors and 2 file drawers  
 Locks are not available on glass doors.

5 Hi, 2 Files/3 Wood Closed Shelves,	81ST24207082	4690	5392	24	20	69	225	25
5 Closed Shelves with Wood Doors	81ST24207083	4690	5392	24	20	69	225	25
	81ST24247082*	4786	5504	24	24	69	265	29
	81ST24247083	4786	5504	24	24	69	265	29



5 Hi, 2 Files/3 Closed Shelves with Matte	81ST24207082G	5097	5861	24	20	69	225	25
Silver Framed Glass Door, 5 Closed	81ST24207083G	5097	5861	24	20	69	225	25
	81ST24247082G*	5201	5979	24	24	69	265	29
	81ST24247083G	5201	5979	24	24	69	265	29



**ORDERING NOTES:**

(82G) Indicates left 3 closed glass doors and 2 file drawers, right 5 closed with wood doors  
 (83G) Indicates left closed with wood doors, right 3 closed glass doors and 2 file drawers  
 Locks are not available on glass doors.

DIMENSION KEY	CODE DESCRIPTION	STANDARD FINISHES
W - width	G - glass	For a complete list of standard wood finishes please see page 114. If specifying a palette finish, change model number prefix to 83, e.g. 83OH0814LURE.
D - depth	OB - organizer bar	
H - height	ABB - binder bin	<b>ADJUSTABLE SHELVING</b> Storage units feature adjustable shelves that are adjustable in increments of approximately 1-1/4".
	AFB - file bar	
	AFO - file organizer	
	APT - paper tray	

# VESTRADA | STORAGE

Description	Model	Cherry Rift		W	D	H	Shipping Weight	Cubic Feet
		Oak Walnut	Maple					
5 Hi, 2 Closed	81ST24207084	4296	4943	24	20	69	200	25
Shelves, 3 Closed	81ST24207085	4296	4943	24	20	69	200	25
Shelves with Wood	81ST24247084*	4389	5045	24	24	69	240	29
Doors, 5 Open	81ST24247085	4389	5045	24	24	69	240	29

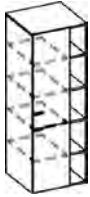

**ORDERING NOTES:**

(84) Indicates left 3 closed wood doors and 2 closed doors, right 5 open.  
 (85) Indicates left 5 open, right 3 closed wood doors and 2 closed doors.

5 Hi, 2 Closed	81ST24207084G	4708	5412	24	20	69	190	25
Shelves, 3 Closed	81ST24207085G	4708	5412	24	20	69	190	25
Shelves with Matte	81ST24247084G*	4802	5524	24	24	69	230	29
Silver Framed Glass	81ST24247085G	4802	5524	24	24	69	230	29
Door, 5 Open								



**ORDERING NOTES:**

(84G) Indicates left 3 closed glass and 2 closed doors, right 5 open.  
 (85G) Indicates left 5 open, right 3 closed glass doors and 2 closed doors.  
 Locks are not available on glass doors.

**ORDERING PROCEDURE**

- To order, please specify the following:
- 1) Krug product model number
  - 2) Wood species and finish, see page 114
  - 3) Pull style and finish, see page 116
  - 4) V-Beam color, see page 117
  - 5) Grommet location and style if applicable

\* Indicates model illustrated by line drawing

**CODE DESCRIPTION**

- L - door hinged left
- R - door hinged right
- G - matte Silver framed glass doors
- ST - storage unit
- BC - bookcase
- WR - wardrobe

**STANDARD FINISHES**

For a complete list of standard wood finishes please see page 114. If specifying a palette finish, change model number prefix to 83, e.g. 83OH0814LURE.

**24" WIDE COMBINATION**

Narrow doors hinge off the edge of the case, whereas wider doors hinge off center parti-tion.

# VESTRADA | STORAGE

Description	Model	Cherry Rift		W	D	H	Shipping Weight	Cubic Feet
		Oak Walnut	Maple					
5 Hi, 2 Closed Shelves, 3 Closed Shelves with Wood Doors, 5 Closed	81ST24207086	4480	5150	24	20	69	205	25
	81ST24207087	4480	5150	24	24	69	205	25
	81ST24247086*	4571	5257	24	20	69	245	29
	81ST24247087	4571	5257	24	24	69	245	29



**ORDERING NOTES:**

(84) Indicates left 3 closed wood doors and 2 closed doors, right 5 closed.  
 (85) Indicates left 5 closed, right 3 closed wood doors and 2 closed doors.

5 Hi, 2 Closed Shelves, 3 Closed Shelves with Matte Silver Framed Glass Door, 5 Closed	81ST24207086G	4868	5600	24	20	69	195	25
	81ST24207087G	4868	5600	24	20	69	195	25
	81ST24247086G*	5337	6138	24	24	69	235	29
	81ST24247087G	5337	6138	24	24	69	235	29

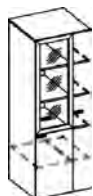

**ORDERING NOTES:**

(86G) Indicates left 3 closed glass and 2 closed doors, right 5 closed.  
 (87G) Indicates left 5 closed, right 3 closed glass doors and 2 closed doors.  
 Locks are not available on glass doors.

6 Hi, Single Width, Closed Shelves with Wood Door	81ST16208311L	3291	3785	16	20	83	165	21
	81ST16208311R	3291	3785	16	20	83	165	21
	81ST16248311L*	3345	3847	16	24	83	195	24
	81ST16248311R	3345	3847	16	24	83	195	24



**ORDERING NOTES:**

Locks are optional on all wood doors for an upcharge of **\$152 list per set** of 2 doors. Locks are standard on all lateral files and file drawer

**DIMENSION KEY**

W - width  
 D - depth  
 H - height

**CODE DESCRIPTION**

L - door hinged left  
 R - door hinged right  
 G - matte Silver framed glass doors  
 ST - storage unit  
 BC - bookcase  
 WR - wardrobe

**STANDARD FINISHES**

For a complete list of standard wood finishes please see page 114. If specifying a palette finish, change model number prefix to 83, e.g. 83OH0814LURE.

**ADJUSTABLE SHELVING**

Storage units feature adjustable shelves that are adjustable in increments of approximately 1-1/4".



# VESTRADA | STORAGE

Description	Model	Cherry Rift		W	D	H	Shipping Weight	Cubic Feet
		Oak Walnut	Maple					
6 Hi, Single Width, 2 Closed Shelves,	81ST16208313L	3357	3862	16	20	83	155	21
4 Open Shelves	81ST16208313R	3357	3862	16	20	83	155	21
	81ST16248313L*	3415	3929	16	24	83	185	24
	81ST16248313R	3415	3929	16	24	83	185	24

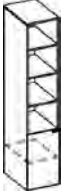

6 Hi, Single Width, 2 Closed Shelves, 4 Closed Shelves with Matte Silver Glass Door	81ST16208314LG	3739	4296	16	20	83	170	21
	81ST16208314RG	3739	4296	16	20	83	170	21
	81ST16248314LG*	3855	4433	16	24	83	200	24
	81ST16248314RG	3855	4433	16	24	83	200	24



**ORDERING NOTES:**

This item is NOT available on KrugExpress.  
Locks are not available on glass doors.

6 Hi, Open Shelves	81ST32208317*	4587	5275	32	20	83	220	38
	81ST32248317	4878	5609	32	24	83	230	44
	81ST36208317	4725	5436	36	20	83	230	42
	81ST36248317	4917	5652	36	24	83	240	50

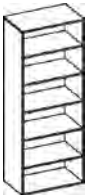

6 Hi, Closed Shelves	81ST32208311	5017	5769	32	20	83	235	38
	81ST32248311*	5137	5906	32	24	83	245	45
	81ST36208311	5170	5945	36	20	83	245	42
	81ST36248311	5288	6081	36	24	83	245	50



**ORDERING NOTES:**

Locks are optional on all wood doors for an upcharge of **\$152 list per set** of 2 doors. Locks are standard on all lateral files and file drawer

**ORDERING PROCEDURE**

To order, please specify the following:

- 1) Krug product model number
- 2) Wood species and finish, see page 114
- 3) Pull style and finish, see page 116
- 4) V-Beam color, see page 117
- 5) Grommet location and style if applicable

\* Indicates model illustrated by line drawing

**CODE DESCRIPTION**

- L - door hinged left
- R - door hinged right
- G - matte Silver framed glass doors
- ST - storage unit
- BC - bookcase
- WR - wardrobe

**STANDARD FINISHES**

For a complete list of standard wood finishes please see page 114. If specifying a palette finish, change model number prefix to 83, e.g. 83OH0814LURE.

**ADJUSTABLE SHELVING**

Storage units feature adjustable shelves that are adjustable in increments of approximately 1-1/4".

# VESTRADA | STORAGE

Description	Model	Cherry Rift Oak Walnut		W	D	H	Shipping Weight	Cubic Feet
		Maple	Anigre					
6 Hi, 2 Closed Shelves with Wood Doors, 4 Open Shelves	81ST32208313	4951	5693	32	20	83	240	38
	81ST32248313*	5068	5828	32	24	83	250	45
	81ST36208313	5098	5863	36	20	83	250	42
	81ST36248313	5218	6002	36	24	83	270	50



6 Hi, 2 Closed Shelves with Wood Doors, 4 Closed Shelves with Matte Silver Framed Glass Doors	81ST32208314G	5717	6574	32	20	83	240	38
	81ST32248314G*	5914	6798	32	24	83	250	45
	81ST36208314G	5905	6791	36	20	83	250	42
	81ST36248314G	6091	7005	36	24	83	260	50



**ORDERING NOTES:**

This item is NOT available on KrugExpress.  
Locks are not available on glass doors.

6 Hi, 2 Lateral Files, 4 Open Shelves	81ST32208303	6191	7122	32	20	83	240	38
	81ST32248303*	6288	7229	32	24	83	250	45
	81ST36208303	6382	7339	36	20	83	250	42
	81ST36248303	6478	7449	36	24	83	260	50



**DIMENSION KEY**

W - width  
D - depth  
H - height

**CODE DESCRIPTION**

L - door hinged left  
R - door hinged right  
G - matte Silver framed glass doors  
ST - storage unit  
BC - bookcase  
WR - wardrobe

**STANDARD FINISHES**

For a complete list of standard wood finishes please see page 114. If specifying a palette finish, change model number prefix to 83, e.g. 83OH0814LURE.

**ADJUSTABLE SHELVING**

Storage units feature adjustable shelves that are adjustable in increments of approximately 1-1/4".

# VESTRADA | STORAGE

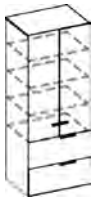
Description	Model	Cherry Rift		W	D	H	Shipping Weight	Cubic Feet
		Oak Walnut	Maple					
 6 Hi, 2 Lateral Files, 4 Closed Shelves	81ST32208304	6420	7383	32	20	83	250	38
	81ST32248304*	6521	7501	32	24	83	260	45
	81ST36208304	6620	7613	36	20	83	260	42
	81ST36248304	6723	7733	36	24	83	270	50

 6 Hi, 2 Lateral Files, 4 Closed Shelves with Matte Silver Framed Glass Doors	81ST32208304G	6977	8022	32	20	83	250	38
	81ST32248304G*	7078	8138	32	24	83	260	45
	81ST36208304G	7175	8253	36	20	83	260	42
	81ST36248304G	7281	8369	36	24	83	270	50

**ORDERING NOTES:**

Locks are not available on glass doors.

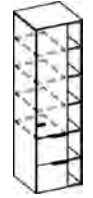
 6 Hi, 2 Files/4 Closed Wood Doors, 6 Open Shelves	81ST24208380	4635	5329	24	20	83	240	29
	81ST24208381	4635	5329	24	20	83	240	29
	81ST24248380*	4729	5439	24	24	83	280	35
	81ST24248381	4729	5439	24	24	83	280	35

**ORDERING NOTES:**

(80) Indicates left 4 closed wood doors and 2 file drawers, right 6 open

(81) Indicates left 6 open, right 4 closed wood doors and 2 file drawers.

Locks are optional on all wood doors for an upcharge of **\$152 list per set** of 2 doors. Locks are standard on all lateral files and file drawer

**ORDERING PROCEDURE**

To order, please specify the following:

- 1) Krug product model number
- 2) Wood species and finish, see page 114
- 3) Pull style and finish, see page 116
- 4) V-Beam color, see page 117
- 5) Grommet location and style if applicable

\* Indicates model illustrated by line drawing

**CODE DESCRIPTION**

- L - door hinged left
- R - door hinged right
- G - matte Silver framed glass doors
- ST - storage unit
- BC - bookcase
- WR - wardrobe

**STANDARD FINISHES**

For a complete list of standard wood finishes please see page 114. If specifying a palette finish, change model number prefix to 83, e.g. 83OH0814LURE.

**ADJUSTABLE SHELVING**

Storage units feature adjustable shelves that are adjustable in increments of approximately 1-1/4".

# VESTRADA | STORAGE

Description	Model	Cherry Rift		W	D	H	Shipping Weight	Cubic Feet
		Oak Walnut	Maple					
6 Hi, 2 Files/4 Closed Shelves with Matte	81ST24208380G	5043	5799	24	20	83	240	29
Silver Framed Glass Doors, 6 Open Shelves	81ST24208381G	5043	5799	24	20	83	240	29
	81ST24248380G*	5149	5920	24	24	83	280	35
	81ST24248381G	5149	5920	24	24	83	280	35

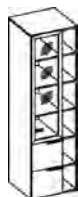

**ORDERING NOTES:**

(80G) Indicates left 4 closed glass doors and 2 file drawers, right 6 open  
 (81G) Indicates left 6 open, right 4 closed glass doors and 2 file drawers  
 Locks are not available on glass doors.

6 Hi, 2 Files/4 Closed Wood Doors, 6 Closed Shelves	81ST24208382	4923	5660	24	20	83	245	29
	81ST24208383	4923	5660	24	20	83	245	29
	81ST24248382*	5028	5782	24	24	83	285	35
	81ST24248383	5028	5782	24	24	83	285	35

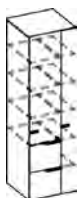

**ORDERING NOTES:**

(82) Indicates left 4 closed wood doors and 2 file drawers, right 6 closed with wood doors  
 (83) Indicates left 6 closed with wood doors, right 4 closed wood doors and 2 file drawers

6 Hi, 2 Files/4 Closed Shelves with Matte	81ST24208382G	5352	6156	24	20	83	245	29
Silver Framed Glass Doors, 6 Closed	81ST24208383G	5352	6156	24	20	83	245	29
	81ST24248382G*	5460	6280	24	24	83	285	35
	81ST24248383G	5460	6280	24	24	83	285	35

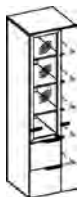

**ORDERING NOTES:**

(82G) Indicates left 4 closed glass doors and 2 file drawers, right 6 closed with wood doors  
 (83G) Indicates left 6 closed with wood doors, right 4 closed glass doors and 2 file drawers  
 Locks are not available on glass doors.

**DIMENSION KEY**

W - width  
 D - depth  
 H - height

**CODE DESCRIPTION**

L - door hinged left  
 R - door hinged right  
 G - matte Silver framed glass doors  
 ST - storage unit  
 BC - bookcase  
 WR - wardrobe

**STANDARD FINISHES**

For a complete list of standard wood finishes please see page 114. If specifying a palette finish, change model number prefix to 83, e.g. 83OH0814LURE.

**24" WIDE COMBINATION**

Narrow doors hinge off the edge of the case, whereas wider doors hinge off center partition.

# VESTRADA | STORAGE

Description	Model	Cherry Rift		W	D	H	Shipping Weight	Cubic Feet
		Oak Walnut	Maple					
6 Hi, 2 Closed Shelves with Wood Doors, 4 Closed	81ST24208384	4511	5189	24	20	83	220	29
Shelves with Wood Doors, 4 Closed	81ST24208385	4511	5189	24	20	83	220	29
Shelves with Wood Doors, 6 Open	81ST24248384*	4608	5298	24	24	83	260	35
	81ST24248385	4608	5298	24	24	83	260	35

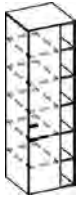

**ORDERING NOTES:**

(84) Indicates left 4 closed wood doors and 2 closed doors, right 6 open.  
 (85) Indicates left 6 open, right 4 closed wood doors and 2 closed doors.

6 Hi, 2 Closed Shelves with Wood Doors, 4 Closed Shelves with Matte Silver Framed Glass Doors, 6 Open	81ST24208384G	4942	5682	24	20	83	210	29
	81ST24208385G	4942	5682	24	20	83	210	29
	81ST24248384G*	5040	5796	24	24	83	250	35
	81ST24248385G	5040	5796	24	24	83	250	35

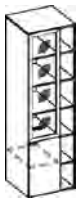

**ORDERING NOTES:**

(84G) Indicates left 4 closed glass doors and 2 closed doors, right 6 open.  
 (85G) Indicates left 6 open, right 4 closed glass doors and 2 closed doors.  
 Locks are not available on glass doors.

**ORDERING PROCEDURE**

- To order, please specify the following:
- 1) Krug product model number
  - 2) Wood species and finish, see page 114
  - 3) Pull style and finish, see page 116
  - 4) V-Beam color, see page 117
  - 5) Grommet location and style if applicable

\* Indicates model illustrated by line drawing

**CODE DESCRIPTION**

- L - door hinged left
- R - door hinged right
- G - matte Silver framed glass doors
- ST - storage unit
- BC - bookcase
- WR - wardrobe

**STANDARD FINISHES**

For a complete list of standard wood finishes please see page 114. If specifying a palette finish, change model number prefix to 83, e.g. 83OH0814LURE.

**ADJUSTABLE SHELVING**

Storage units feature adjustable shelves that are adjustable in increments of approximately 1-1/4".

**VESTRADA | STORAGE**

Description	Model	Cherry Rift Oak Walnut		W	D	H	Shipping Weight	Cubic Feet
		Maple	Anigre					
6 Hi, 2 Closed	81ST24208386	4704	5406	24	20	83	225	29
Shelves with Wood	81ST24208387	4704	5406	24	20	83	225	29
Doors, 4 Closed	81ST24248386*	4796	5517	24	24	83	265	35
Shelves with Wood	81ST24248387	4796	5517	24	24	83	265	35
Doors, 6 Closed								



**ORDERING NOTES:**

(84) Indicates left 4 closed wood doors and 2 closed doors, right 6 closed.  
 (85) Indicates left 6 closed, right 4 closed wood doors and 2 closed doors.

6 Hi, 2 Closed	81ST24208386G	5112	5878	24	20	83	215	29
Shelves with Wood	81ST24208387G	5112	5878	24	24	83	215	29
Doors, 4 Closed	81ST24248386G*	5217	6000	24	20	83	255	35
Shelves with Matte	81ST24248387G	5217	6000	24	24	83	255	35
Silver Framed Glass								
Doors, 6 Closed								

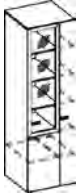

**ORDERING NOTES:**

(86G) Indicates left 4 closed glass and 2 closed doors, right 6 closed.  
 (87G) Indicates left 6 closed, right 4 closed glass doors and 2 closed doors.  
 Locks are not available on glass doors.

Worksurface	81BCV32162917*	2478	2848	32	16	29	85	10
Bookcase	81BCV36162917	2763	3177	36	16	29	105	11



**ORDERING NOTES:**

This unit features a V-Beam and therefore cannot accommodate 2 rows of binders.

**DIMENSION KEY**

W - width  
 D - depth  
 H - height

**CODE DESCRIPTION**

L - door hinged left  
 R - door hinged right  
 G - matte Silver framed glass doors  
 ST - storage unit  
 BC - bookcase  
 WR - wardrobe

**STANDARD FINISHES**

For a complete list of standard wood finishes please see page 114. If specifying a palette finish, change model number prefix to 83, e.g. 83OH0814LURE.

**24" WIDE COMBINATION**

Narrow doors hinge off the edge of the case, whereas wider doors hinge off center partition.

# VESTRADA | STORAGE

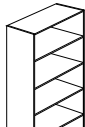
Description	Model	Cherry Rift		W	D	H	Shipping Weight	Cubic Feet
		Oak Walnut	Maple					
	81BC32162917	2131	2451	32	16	29	75	10
	81BC36162917	2172	2465	36	16	29	95	11
	81BC32165617	2577	2964	32	16	55.5	180	21
	81BC36165617	2631	3025	36	16	55.5	180	24
	81BC32167017*	2932	3371	32	16	69	190	26
	81BC36167017	2991	3439	36	16	69	200	29

	6 Hi, Bookcase	81BC32168317*	3074	3535	36	16	83	220	36
		81BC36168317	3136	3606	32	16	83	210	31

**ORDERING NOTES:**

Bookcases are intended to be secured to a wall for safety, they also feature unfinished backs. These units accommodate standard binder storage, therefore they do not align with other case heights.

	5 Hi, Single Width Wardrobe	81WR16247002L*	3040	3497	16	24	69	170	20
		81WR16247002R	3040	3497	16	24	69	170	20

	5 Hi, Wardrobe, Closed Shelves	81WR32247001*	4055	4663	32	24	69	217	38
		81WR36247001	4177	4802	36	24	69	230	42

**ORDERING PROCEDURE**

To order, please specify the following:

- 1) Krug product model number
- 2) Wood species and finish, see page 114
- 3) Pull style and finish, see page 116
- 4) V-Beam color, see page 117
- 5) Grommet location and style if applicable

\* Indicates model illustrated by line drawing

**CODE DESCRIPTION**

- L - door hinged left
- R - door hinged right
- G - matte Silver framed glass doors
- ST - storage unit
- BC - bookcase
- WR - wardrobe

**STANDARD FINISHES**

For a complete list of standard wood finishes please see page 114. If specifying a palette finish, change model number prefix to 83, e.g. 83OH0814LURE.

**ADJUSTABLE SHELVING**

Storage units feature adjustable shelves that are adjustable in increments of approximately 1-1/4".

**LOCK OPTION**

Locks are available on wood doors for an upcharge of **\$152 list** per lock. 24", 30" & 36" wardrobes require 2 locks.

# VESTRADA | STORAGE

Description	Model	Cherry Rift		W	D	H	Shipping Weight	Cubic Feet
		Oak Walnut Maple	Anigre					
5 Hi, 2 Files/3 Closed Shelves with Wood Door, Wardrobe	81WR24247014*	4641	5337	24	24	69	260	29
	81WR24247015	4641	5337	24	24	69	260	29

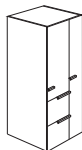

**ORDERING NOTES:**

(14) Indicates left 3 closed wood door shelves centre-hinged and 2 file drawers, right 5 closed wood door wardrobe.  
 (15) Indicates right 3 closed wood door shelves centre-hinged and 2 file drawers, left 5 closed wood door wardrobe.

5 Hi, 2 Files/3 Closed Shelves with Matte Silver Framed Glass Door, Wardrobe	81WR24247014G*	5043	5799	24	24	69	260	29
	81WR24247015G	5043	5799	24	24	69	260	29

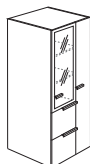

**ORDERING NOTES:**

(14G) Indicates left 3 closed glass door shelves centre-hinged and 2 file drawers, right 5 closed wood door wardrobe.  
 (15G) Indicated right 3 closed glass door shelves centre-hinged and 2 file drawers, left 5 closed wood door wardrobe. Locks are not available on glass doors. This item is not available on KrugExpress.

5 Hi, 2 Closed Shelves with Wood Doors/3 Closed Shelves with Wood Door, Wardrobe	81WR24247016*	4433	5098	24	24	69	240	29
	81WR24247017	4433	5098	24	24	69	240	29

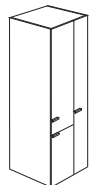

**ORDERING NOTES:**

(16) Indicates left 3 closed wood door shelves and 2 closed wood door shelves centre-hinged, right 5 closed wood door wardrobe.  
 (17) Indicated right 3 closed wood door shelves and 2 closed wood door shelves centre-hinged, left 5 closed wood door wardrobe.

**DIMENSION KEY**

W - width  
 D - depth  
 H - height

**CODE DESCRIPTION**

L - door hinged left  
 R - door hinged right  
 G - matte Silver framed glass doors  
 ST - storage unit  
 BC - bookcase  
 WR - wardrobe

**STANDARD FINISHES**

For a complete list of standard wood finishes please see page 114. If specifying a palette finish, change model number prefix to 83, e.g. 83OH0814LURE.

**24" WIDE COMBINATION**

Narrow doors hinge off the edge of the case, whereas wider doors hinge off center partition.

**LOCK OPTION**

Locks are available on wood doors for an upcharge of **\$152 list** per lock 24, 30 and 36" wardrobes require 2 locks



# VESTRADA | STORAGE

Description	Model	Cherry Rift		W	D	H	Shipping Weight	Cubic Feet
		Oak Walnut	Maple					
5 Hi, 2 Closed Shelves with Wood Doors/3 Closed Shelves with Matte Silver Framed Glass Door, Wardrobe	81WR24247016G*	4818	5541	24	24	69	230	29
	81WR24247017G	4818	5541	24	24	69	230	29



**ORDERING NOTES:**

(16G) Indicates left 3 closed glass door shelves and 2 closed wood door shelves centre-hinged, right 5 closed wood door wardrobe.

(17G) Indicated right 3 closed glass door shelves and 2 closed wood door shelves centre-hinged, left 5 closed wood door wardrobe.

Locks are not available on glass doors. This item is not available on KrugExpress.

6 Hi, Wardrobe, Closed Shelves	81WR32248301*	4466	5137	32	24	83	232	45
	81WR36248301	4602	5289	36	24	83	245	50

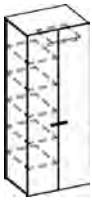

6 Hi, Single Width Wardrobe	81WR16248302L*	3242	3728	16	24	69	190	24
	81WR16248302R	3242	3728	16	24	83	190	24



**ORDERING PROCEDURE**

To order, please specify the following:

- 1) Krug product model number
- 2) Wood species and finish, see page 114
- 3) Pull style and finish, see page 116
- 4) V-Beam color, see page 117
- 5) Grommet location and style if applicable

\* Indicates model illustrated by line drawing

**CODE DESCRIPTION**

- L - door hinged left
- R - door hinged right
- G - matte Silver framed glass doors
- ST - storage unit
- BC - bookcase
- WR - wardrobe

**STANDARD FINISHES**

For a complete list of standard wood finishes please see page 114. If specifying a palette finish, change model number prefix to 83, e.g. 83OH0814LURE.

**ADJUSTABLE SHELVING**

Storage units feature adjustable shelves that are adjustable in increments of approximately 1-1/4".

**LOCK OPTION**

Locks are available on wood doors for an upcharge of **\$152 list** per lock. 24", 30" & 36" wardrobes require 2 locks.

# VESTRADA | STORAGE

Description	Model	Cherry Rift		W	D	H	Shipping Weight	Cubic Feet
		Oak Walnut Maple	Anigre					
6 Hi, 2 Files/4 Closed Shelves with Wood Door, Wardrobe	81WR24248314*	4874	5607	24	24	83	280	35
	81WR24248315	4874	5607	24	24	83	280	35

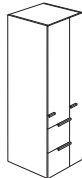

**ORDERING NOTES:**

(14) Indicates left 4 closed wood door shelves centre-hinged and 2 file drawers, right 6 closed wood door wardrobe.(15) Indicated right 4 closed wood door shelves centre-hinged and 2 file drawers, left 6 closed wood door wardrobe. Locks are not available on glass doors. This item is not available on KrugExpress.

6 Hi, 2 Files/4 Closed Shelves with Matte Silver Framed Glass Door, Wardrobe	81WR24248314G*	5296	6090	24	24	83	280	35
	81WR24248315G	5296	6090	24	24	83	280	35

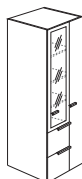

**ORDERING NOTES:**

(14G) Indicates left 4 closed glass door shelves centre-hinged and 2 file drawers, right 6 closed wood door wardrobe.(15G) Indicated right 4 closed glass door shelves centre-hinged and 2 file drawers, left 6 closed wood door wardrobe. Locks are not available on glass doors. This item is not available on KrugExpress.

6 Hi, 2 Closed Wood Door/ 4 Closed Wood Doors, Wardrobe	81WR24248316*	4655	5353	24	24	83	260	35
	81WR24248317	4655	5353	24	24	83	260	35



**ORDERING NOTES:**

(16) Indicates left 4 closed wood door shelves and 2 closed wood door shelves centre-hinged, right 6 closed wood door wardrobe.  
(17) Indicated right 4 closed wood door shelves and 2 closed wood door shelves centre-hinged, left 6 closed wood door wardrobe.

6 Hi, 2 Closed Wood Door/ 4 Closed Matte Silver Framed Glass Door, Wardrobe	81WR24248316G*	5061	5061	24	24	83	250	35
	81WR24248317G	5061	5061	24	24	83	250	35

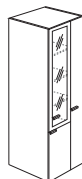

**ORDERING NOTES:**

(16G) Indicates left 4 closed glass door shelves and 2 closed wood door shelves centre-hinged, right 6 closed wood door wardrobe.  
(17G) Indicated right 4 closed glass door shelves and 2 closed wood door shelves centre-hinged, left 6 closed wood door wardrobe.  
Locks are not available on glass doors. This item is not available on KrugExpress.

**DIMENSION KEY**

W - width  
D - depth  
H - height

**CODE DESCRIPTION**

L - door hinged left  
R - door hinged right  
G - matte Silver framed glass doors  
ST - storage unit  
BC - bookcase  
WR - wardrobe

**STANDARD FINISHES**

For a complete list of standard wood finishes please see page 114. If specifying a palette finish, change model number prefix to 83, e.g. 83OH0814LURE.

**24" WIDE COMBINATION**

Narrow doors hinge off the edge of the case, whereas wider doors hinge off center partition.

**LOCK OPTION**

Locks are available on wood doors for an upcharge of **\$152 list** per lock. 24", 30" & 36" wardrobes require 2 locks.

# VESTRADA | WORKWALL COMPONENTS | GUIDELINES

## VESTRADA HUTCHES

Hutches include L.E.D. Lights that are factory installed and require no field adjustment  
L.E.D. Lights are mounted beneath the cabinet and hidden from view.

A tackboard in Grade 1 fabric is included with all Hutches.

Upcharges for higher graded fabrics are listed on page 234.

Tackboard fabric selections should be supplied with the order information. Palette options are listed on page 114.

Tackboards for Hutches are installed at the factory and require no additional set up on site.

Hutches over 84" in length are made in two pieces and require special installation.

Hutches are available with a finished inside back panel at standard list price, but must be clearly specified on order.  
This option is available on Hutches up to 84" in length only. This option does not include a tackboard.

Locks are optional on wood hutch doors and can be specified at time of order for an upcharge of **\$152 list per set** of (2) doors.

## WORKWALL COMPONENTS | GUIDELINES

Unlike other Krug product lines, VESTRADA features the WorkWall as well as the traditional hutch.

WorkWalls are comprised of combination of overheads, worksurface piers and/or full height piers.

VESTRADA WorkWalls are available with an exceptional number of options and accommodate all standard credenza lengths.

### THE BASICS

A WorkWall consists of 3 components: One Overhead and two storage Piers.

The Piers can either sit on the worksurface or extend to the floor.

There are 3 types of WorkWalls. These types are determined by the way the Overhead Unit is supported.

NOTE: Shaded horizontal tops in the drawings above represent Credenza tops.

1. End supported WorkWalls\*: Overhead is supported on both ends.

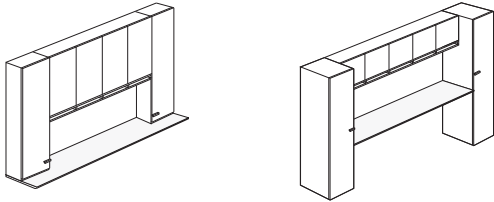

\* WorkWalls that are End-Supported (as shown above) accommodate Paper Management Shelving.

2. Under supported WorkWalls: Overhead is supported from underneath on both ends.

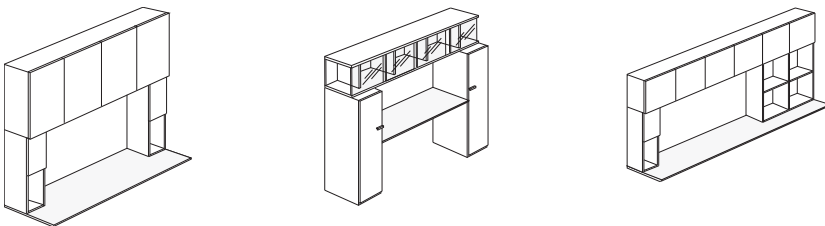

3. Under and end supported WorkWalls: Overhead is under-supported on one side and end-supported on the other side.

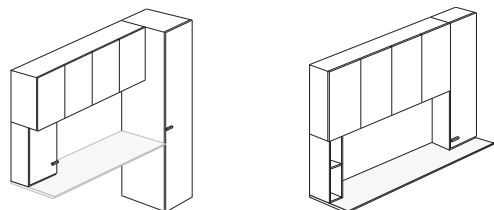

# VESTRADA | WORKWALL COMPONENTS | GUIDELINES

The following are guidelines to bear in mind when building a WorkWall from components.

## PIERS

When supporting an Overhead in a WorkWall, there are some basic guidelines to follow:

- Unless the Overhead is a Sliding Glass Door Overhead with open ends, any Overhead can be under-supported by 8” wide Piers as shown below/left.
- If the Overhead has open ends as shown below/center, it must be under-supported by a minimum of 16” wide Piers in order to sufficient support the Overhead. Overheads with open ends can not be end-supported.
- 5 hi and 6 hi Storage Units can only be used as end-supporting Piers. 4 hi Storage Units can only be under-supporting.

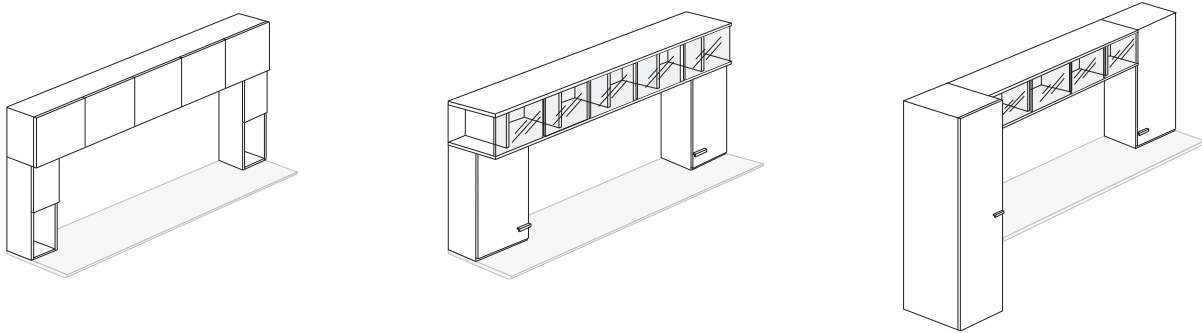

As mentioned in THE BASICS section, the Pier can either end or under-support the Overhead in a WorkWall.

On page 243, you will have a selection of Piers to choose from. Once you have selected the style and options for your Piers, you will need to specify the designation for each Pier in order to indicate how you would like to support your WorkWall. For example, in the diagram shown below, we are showing a WorkWall that is both under and end-supported.

The codes for these designations are:

### SUFFIXES FOR PIERS

- LU – Left Pier / Under support
- RU – Right Pier / Under support
- LE – Left Pier / End support
- RE – Right Pier / End support

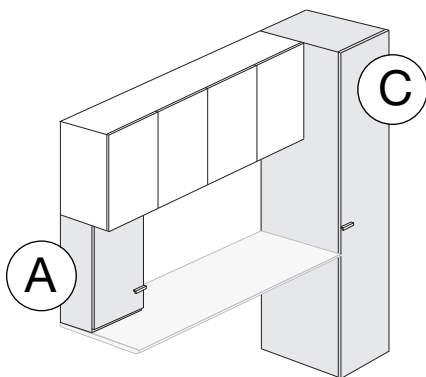

In the example shown left the suffixes would be as follows

A : (Worksurface Pier) - LU Left Pier under support

C : (Storage Unit) - RE Right Pier end support

# VESTRADA | WORKWALL COMPONENTS | GUIDELINES

## OVERHEADS

Overheads in this section are only to be used in WorkWalls with supporting Piers. For Wall Hung Overheads see page 235.

There are two different heights of Overheads in VESTRADA, single and double height.

Single height Overheads are available with the following options in wood or paint as shown on page 235:

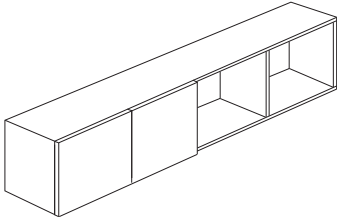

- Hinged Doors
- Open
- Combination Open / Closed Hinged Doors
- Sliding Glass Door / Closed Ends
- Sliding Glass Door / Open Ends
- Aluminum Framed Glass Doors
- Combination Wood / Aluminum Framed Glass Doors

\* Combination Sliding Glass / Open not available.

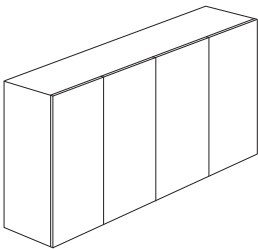

- Hinged Doors
- Aluminum Framed Glass Doors
- Combination Wood / Aluminum Framed Glass Doors

Therefore, Sliding Glass Doors are only available on single height Overheads, whereas Aluminum Framed Glass is available on single and double height Overheads.

As illustrated in the PIERS section, the user must indicate a suffix when ordering an Overhead for a WorkWall configuration. There is one exception to this: open ended Sliding Glass Door Overheads can only be under-supported by 16" or larger Piers.

For example, in the diagram shown below, we are showing a WorkWall with an Overhead that is both under and end-supported. The codes for all Overhead designations are:

### SUFFIXES FOR OVERHEADS

LURU – Left Under and Right Under supported

LERE – Left End and Right End supported

LURE – Left Under and Right End supported

LERU – Left End and Right Under supported

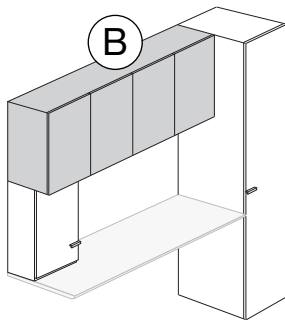

In the example shown left the suffixes would be as follows:

ⓑ : (Overhead) - LURE Left Under supported / Right End supported

# VESTRADA | WORKWALL COMPONENTS | GUIDELINES

## Piers and Overheads Summary

In conclusion, the suffixes for each component of the WorkWall line drawing are as follows:

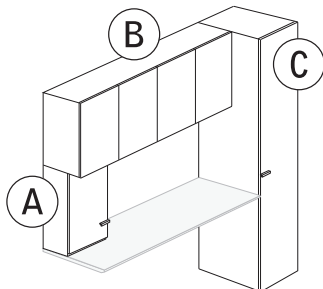

- A - Desk Top Pier - LU Left Under Support
- B - Overhead - LURE Left Under supported/Right End supported
- C - Full Height Pier - RE Right End support  
Storage Unit

## OVERHEAD PAPER MANAGEMENT



Paper management in VESTRADA can be specified in 1 or 2 tier versions. The general guideline for paper management is that the overhead, for which the paper management is being specified, must be end-supported on both ends. To specify paper management for your WorkWall, the overhead for which the paper management is to be added must be designated. A “PM” in the model number denotes that the overhead will be machined to accept paper management.

For example, if the model number for the overhead being specified is 81OH-641628 and the user requires paper management (either 1 or 2 tier), the model number would change to: 81OH-641628PMLERE

It is not necessary to designate on the overhead model number whether a 1 or 2 tier paper management unit is required. The type of paper management used is to be specified in the tackboard, L.E.D. light model number. Depending on the size of WorkWall and location of piers and overheads, the paper management price will vary. For pricing on paper management options, please refer to the paper management upcharge/sizing chart on page 242.

\*\*The machining for paper management cannot be done in the field.

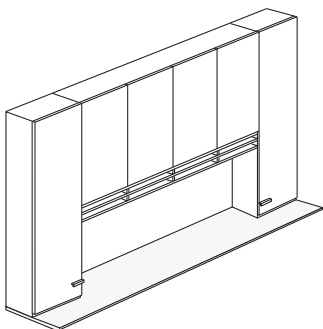

# VESTRADA | WORKWALL COMPONENTS | GUIDELINES

## TACKBOARDS, L.E.D. LIGHTS AND PAPER MANAGEMENT SHELVING



Tackboards and L.E.D. lights need to be specified as a separate line item and are acknowledged separately on an order for WorkWall. A TBHL must be ordered to complete a WorkWall. The model number prefix for the tackboard, L.E.D. light is TBHL.

When paper management is to be added, it must also appear in the tackboard, L.E.D. light model number as they are all built as one part. The model number prefix for tackboard, L.E.D. light and paper management tiers are:

- (a) 81TBHLP1—(for one tier paper management)
- (b) 81TBHLP2—(for two tier paper management)

Depending on the size of WorkWall and location of piers and overheads, the 81TBHL price will vary. For pricing and model numbers, please refer to the TBHL pricing chart .



## LINKWALLS

LinkWalls are WorkWall components that meet at a corner. LinkWalls are comprised of two overheads that are end supported by a corner pier creating a corner solution.

Please follow these steps to specify your LinkWall from WorkWall components:

### STEP 1: Choose your left pier.

- Designate under or end-supporting.

### STEP 2: Choose your left overhead\*

- Designate left end or under-supported.
- The right designation can only be end-supported.
- If specifying paper management add PM to overhead model number.

With paper management both sides must be end-supported.

\*Sliding glass door overheads with open ends are not available in LinkWall configurations

### STEP 3: Specify corner pier - model number 81PRC-161640

- If paper management\*\* is required specify 1 or 2 tier by adding PM1 or PM2 to the end of the pier model number.

\*\*The 1 or 2 tier paper management can only be ordered if used on both sides of the LinkWall.

### STEP 4: Choose your right overhead\*

- Designate end or under-supported.
- The left designation can only be end-supported.
- If specifying paper management add PM to overhead model number.

With paper management both sides must be end-supported.

\*Sliding glass door overheads with open ends are not available in LinkWall configurations

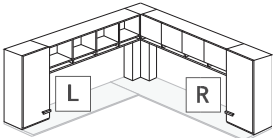

### STEP 5: Choose your right pier

- Designate under or end-supporting.

### STEP 6: Specify tackboard - TBHL for both overheads

- Determine TBHL size.

If the overhead and piers are both end-supporting simply use the size of the overhead.

If a pier is under-supporting subtract the amount of the pier which sits underneath the overhead from the size of the overhead.

- If specifying paper management add PM1 or PM2 to TBHL model number and apply applicable upcharge to the price of the TBHL.

# VESTRADA | WORKWALL COMPONENTS | GUIDELINES

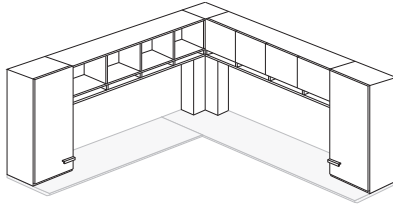

Model	Cherry	
	Oak	Anigre
	Maple	Walnut
81PR-161640-11LE	2108	2424
81OO-641640PMLERE	2814	3172
81TBHLP1-642415U	1373	1373
81PRC-161640PM1	2013	2316
81OH-641614PMLERE	3080	3481
81TBHLP1-642415U	1373	1373
81PR-161640-11RE	2108	2424
	14,869	16,563

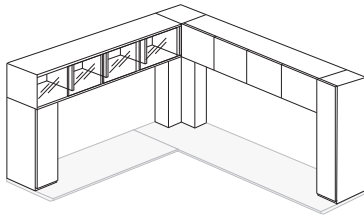
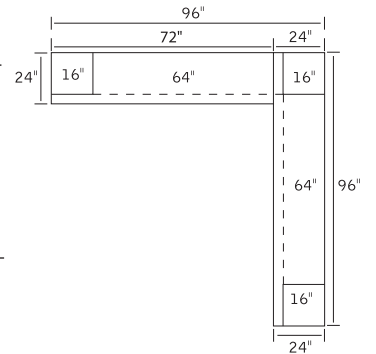

Model	Cherry	
	Oak	Anigre
	Maple	Walnut
81PR-081426-11LU	1827	1796
81OS-641614LURE	3349	3292
81TBHL-562415U	942	942
81PRC-161640	2013	2316
81OH-641614LERE	2679	3082
81TBHL-642415U	973	973
81PR-081640-11RE	2046	2354
	13,829	14,755

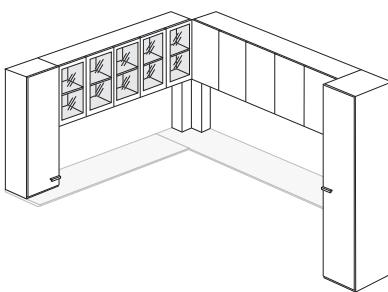
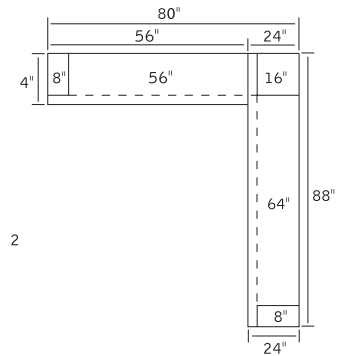

Model	Cherry	
	Oak	Anigre
	Maple	Walnut
81PR-161653-11LE	2491	2868
81OH-801628LEREG	3671	4221
81TBHL-802415U	1018	1018
81PRC-161640	2013	2316
81OH-801628LERE	3340	3839
81TBHL-802415U	1018	1018
81ST162483-11RE	3187	3664
	16,738	18,944

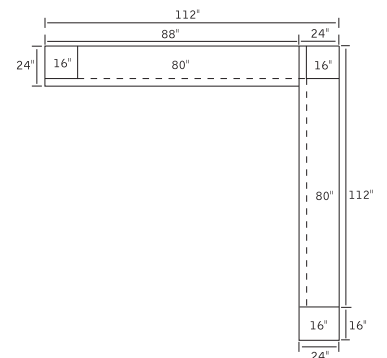

NOTE: If specifying palette finish change model number prefix to 83  
 NOTE: All Tackboard pricing reflect a Grade 1 palette fabric

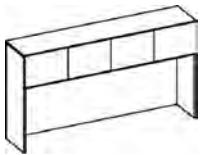

# VESTRADA | HUTCHES

Description	Model	Cherry Rift		W	D	H	Shipping Weight	Cubic Feet	
		Oak Walnut Maple	Anigre						
5 Hi, Wood Door Hutches 	81HT641640	4377	5033	64	16	40	25.5	192	27
	81HT721640*	5140	5912	72	16	40	25.5	201	30
	81HT801640	5751	6612	80	16	40	25.5	215	35
	81HT881640	7405	8516	88	16	40	25.5	274	44
	81HT961640	8343	9595	96	16	40	25.5	293	47

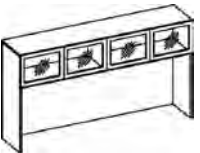
5 Hi, Matte Silver Framed Glass Door Hutches 	81HT641640G	5166	5939	64	16	40	25.5	192	27
	81HT721640G*	6064	6973	72	16	40	25.5	201	30
	81HT801640G	6787	7805	80	16	40	25.5	215	35
	81HT881640G	8738	10049	88	16	40	25.5	274	44
	81HT961640G	9846	11322	96	16	40	25.5	293	47

5 Hi, Open Hutches 	81HTO641640	3927	4513	64	16	40	25.5	190	27
	81HTO721640*	4353	5007	72	16	40	25.5	199	30
	81HTO801640	4691	5393	80	16	40	25.5	213	35
	81HTO881640	6119	7038	88	16	40	25.5	272	44
	81HTO961640	6913	7949	96	16	40	25.5	291	47

5 Hi, 64" & 72" Combination Hutches 	81HTHO64164002	4152	4774	64	16	40	25.5	192	27
	81HTHO72164002*	4746	5457	72	16	40	25.5	201	30

**ORDERING NOTES:**

Paper management shelving is not available on 88" and 96" wide hutches. 88" and 96" hutches come in two pieces. For paper management, please add PM1 or PM2 after the model number, e.g., 81HT801640PM1. Please see page 234. for upcharges. Specify a Voice/Power/Data module with any hutch by adding 'W' at the end of the model number and a **\$252 list upcharge**. Hutches come standard with a Krug panel grade 1 fabric tackboard and L.E.D. lights. See page 234 for fabric upcharges. Locks are optional at an upcharge of **\$152 list per set** of 2 doors. Locks are standard on all file and lateral file drawers. Glass door hutches are NOT available on KrugExpress. Locks are not available on glass door hutches.

**ORDERING PROCEDURE**

- To order, please specify the following:
- 1) Krug product model number
  - 2) Wood species and finish, see page 114
  - 3) Pull style and finish, see page 116
  - 4) V-Beam color, see page 117
  - 5) Grommet location and style if applicable

\* Indicates model illustrated by line drawing

**CODE DESCRIPTION**

- G - matte Silver framed frosted glass doors
- W - voice/power/data module
- 02 - two closed left, remainder open
- 04 - three closed left, remainder open
- 06 - four closed left, remainder open
- PM - paper management (optional)
- HT - closed hinged door hutch
- HT0 - open hutch
- HTH0- combination open and closed hinged hutch
- HUTCH- double height hinged closed/open hutch

**STANDARD FINISHES**

For a complete list of standard wood finishes please see page 114.

**PAPER MANAGEMENT**

For paper management, add PM1 or PM2 after hutch model number. Apply appropriate upcharge from page 234 to hutch.

**TACKBOARDS**

Hutches come standard with a Krug panel grade 1 fabric tackboard and L.E.D. lights. See page 234 for fabric upcharges.

**VESTRADA | HUTCHES**

Description	Model	Cherry Rift		W	D	H		Shipping Weight	Cubic Feet
		Oak	Walnut						
5 Hi, 80" Combination Hutches	81HTHO80164004	Maple 5218	Anigre 6002	80	16	40	25.5	215	35

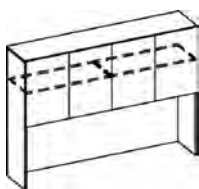
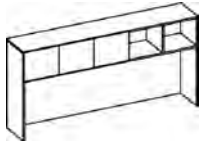

81HT641653	5407	6218	64	16	53	25.5	273	27
81HT721653*	6188	7119	72	16	53	25.5	281	30
81HT801653	7177	8254	80	16	53	25.5	299	35
81HT881653	9201	10584	88	16	53	25.5	358	44
81HT961653	10392	11955	96	16	53	25.5	377	47

6 Hi, Matte Silver Framed Glass Door Hutches

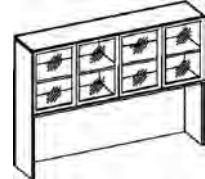

81HT641653G	6378	7337	64	16	53	25.5	273	27
81HT721653G*	7298	8393	72	16	53	25.5	281	30
81HT801653G	8416	9682	80	16	53	25.5	299	35
81HT881653G	10855	12484	88	16	53	25.5	358	44
81HT961653G	12267	14105	96	16	53	25.5	377	47

6 Hi, Wood Door/Open Combination Hutches



81HTCH641653	5138	5910	64	16	53	25.5	273	27
81HTCH721653*	5878	6760	72	16	53	25.5	281	30
81HTCH801653	6773	7791	80	16	53	25.5	299	35

**ORDERING NOTES:**

Paper management shelving is not available on 88" and 96" wide hutches. 88" and 96" hutches come in two pieces. For paper management, please add PM1 or PM2 after the model number, e.g., 81HT801640PM1. Please see page 248 for upcharges. Specify a Voice/Power/Data module with any hutch by adding 'W' at the end of the model number and a **\$252 list upcharge**.

Hutches come standard with a Krug panel grade 1 fabric tackboard and L.E.D. lights. See page 248 for fabric upcharges. Locks are optional at an upcharge of **\$152 list per set** of 2 doors. Locks are standard on all file and lateral file drawers. Glass door hutches are NOT available on KrugExpress. Locks are not available on glass door hutches.

**DIMENSION KEY**

W - width  
D - depth  
H - height

**CODE DESCRIPTION**

G - matte Silver framed frosted glass doors  
W - voice/power/data module  
02 - two closed left, remainder open  
04 - three closed left, remainder open  
06 - four closed left, remainder open  
PM - paper management (optional)  
HT - closed hinged door hutch  
HT0 - open hutch  
HTH0- combination open and closed hinged hutch  
HUTCH- double height hinged closed/open hutch

**STANDARD FINISHES**

For a complete list of standard wood finishes please see page 114.

**PAPER MANAGEMENT**

For paper management, add PM1 or PM2 after hutch model number. Apply appropriate upcharge from page 248 to hutch.

# VESTRADA | HUTCH, TACKBOARDS, PAPER MANAGEMENT PRICING

Tackboard upcharges for hutches.

Use this chart to find the upcharge for tackboard fabrics graded 2-9 and add it to the cost of the hutch. FABRIC GRADES

	2	3	4	5	6	7	8	9	com
64" hutch tackboard	176	378	378	740	917	1093	1270	1578	2
72" hutch tackboard	210	451	451	887	1096	1310	1522	1828	2.25
80" hutch tackboard	294	614	614	1202	1497	1790	2084	2463	2.5
88" hutch tackboard	333	688	688	1348	1680	2010	2339	2714	2.75
96" hutch tackboard	364	757	757	1482	1846	2212	2569	2983	3.00

On single piece hutches, the yardage requirement for two tackboards is the same as for one tackboard. Please keep this in mind when ordering more than one tackboard. For example, if the number of tackboards required is 7 and the COM requirement for 1 tackboard is 1.5 yards, the calculation for COM yardage is as follows: 4.5 yards are required for 6 tackboards + 1.5 yards for the 7th tackboard for a total of 6 yards. In the case of an even number of tackboards, divide the number of tackboards required by 2 and multiply that number by COM requirement on the chart.

The fabric must be at least 54" wide in order to qualify for this procedure. If the fabric is less than 54" wide, the COM yardage listed on the chart is the amount required for each tackboard.

\* Palette Panel fabrics are Grade 3 fabrics.

A tackboard in grade 1 fabric is included in the price of the hutch.





Paper Management upcharges to be added to the price of the hutch.

	TACKBOARD SIZE		
	64"	72"	80"
1 Tier	385	424	447
2 Tier	775	840	914

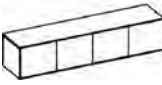

# VESTRADA | WORKWALL COMPONENTS/OVERHEADS

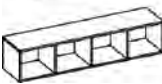
Description	Model	Cherry Rift		W	D	H	Shipping Weight	Cubic Feet
		Oak	Walnut					
Wood Door	81OH481614LERE	2520	2898	48	16	13.75	120	9
Overheads	81OH481614LERU	2520	2898	48	16	13.75	120	9
	81OH481614LURU	2520	2898	48	16	13.75	120	9
	81OH481614LURE	2520	2898	48	16	13.75	120	9
	81OH641614LERE*	2812	3235	64	16	13.75	150	11
	81OH641614LERU	2812	3235	64	16	13.75	150	11
	81OH641614LURU**	2812	3235	64	16	13.75	150	11
	81OH641614LURE	2812	3235	64	16	13.75	150	11
	81OH801614LERE	3236	3718	80	16	13.75	180	14
	81OH801614LERU	3236	3718	80	16	13.75	180	14
	81OH801614LURU	3236	3718	80	16	13.75	180	14
	81OH801614LURE	3236	3718	80	16	13.75	180	14
	81OH961614LERE	3721	4282	96	16	13.75	210	17
	81OH961614LERU	3721	4282	96	16	13.75	210	17
	81OH961614LURU	3721	4282	96	16	13.75	210	17
	81OH961614LURE	3721	4282	96	16	13.75	210	17
<hr/>								
Open Overheads	81OO481614LERE*	2394	2753	48	16	13.75	110	9
	81OO481614LERU	2394	2753	48	16	13.75	110	9
	81OO481614LURU*	2394	2753	48	16	13.75	110	9
	81OO481614LURE	2394	2753	48	16	13.75	110	9
	81OO641614LERE**	2532	2912	64	16	13.75	140	11
	81OO641614LERU**	2532	2912	64	16	13.75	140	11
	81OO641614LURU**	2532	2912	64	16	13.75	140	11
	81OO641614LURE**	2532	2912	64	16	13.75	140	11
	81OO801614LERE	3073	3534	80	16	13.75	170	14
	81OO801614LERU	3073	3534	80	16	13.75	170	14
	81OO801614LURU	3073	3534	80	16	13.75	170	14
	81OO801614LURE	3073	3534	80	16	13.75	170	14
	81OO961614LERE	3535	4065	96	16	13.75	200	17
	81OO961614LERU	3535	4065	96	16	13.75	200	17
	81OO961614LURU	3535	4065	96	16	13.75	200	17
	81OO961614LURE	3535	4065	96	16	13.75	200	17

**ORDERING NOTES:**

Please see page 226 for instructions on overhead suffix designations. For example, LURE means that the overhead is Left Under-supported/Right End supported.

For paper management, please add PM before the 'L' in the model number, see page 228 for ordering instructions and pricing. Paper management cases can only be end supported.

Tackboard and L.E.D. lights are an integral part of each WorkWall and MUST BE ordered to complete a WorkWall.

Locks are optional at an upcharge of **\$152 list per set** of 2 doors. Locks are standard on all file and lateral file drawers.

Double height overheads feature adjustable shelving.

Glass door overheads are NOT available on KrugExpress. Locks are not available on glass doors.

**DIMENSION KEY**

W - width  
 D - depth  
 H - height

**CODE DESCRIPTION**

G - matte Silver framed frosted glass doors  
 W - voice/power/data module  
 02 - two closed left, remainder open  
 04 - three closed left, remainder open  
 06 - four closed left, remainder open  
 PM - paper management (optional)  
 HT - closed hinged door hutch  
 HT0 - open hutch  
 HTH0 - combination open and closed hinged hutch  
 HUTCH - double height hinged closed/open hutch

**STANDARD FINISHES**

For a complete list of standard wood finishes please see page 114. If specifying a palette finish, change model number prefix to 83, e.g. 83OH0814LURE.

**COMBINATION OVERHEADS** Combination styles are designated by a numerical reference as listed in the code description. Combinations are only available as listed.

# VESTRADA | WORKWALL COMPONENTS/OVERHEADS

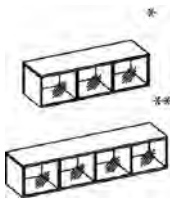
Description	Model	Cherry Rift		W	D	H	Shipping Weight	Cubic Feet	
		Oak	Walnut						
Sliding Glass Door	81OS481614LERE*	3147	3622	48	16	13.75	115	9	
Overheads, Closed	81OS481614LERU	3147	3622	48	16	13.75	115	9	
Ends	81OS481614LURU	3147	3622	48	16	13.75	115	9	
	81OS481614LURE	3147	3622	48	16	13.75	115	9	
	81OS641614LERE**	3516	4042	64	16	13.75	145	11	
	81OS641614LERU	3516	4042	64	16	13.75	145	11	
	81OS641614LURU	3516	4042	64	16	13.75	145	11	
	81OS641614LURE	3516	4042	64	16	13.75	145	11	
	81OS801614LERE	4042	4649	80	16	13.75	175	14	
	81OS801614LERU	4042	4649	80	16	13.75	175	14	
	81OS801614LURU	4042	4649	80	16	13.75	175	14	
	81OS801614LURE	4042	4649	80	16	13.75	175	14	
	81OS961614LERE	4649	5346	96	16	13.75	205	17	
	81OS961614LERU	4649	5346	96	16	13.75	205	17	
	81OS961614LURU	4649	5346	96	16	13.75	205	17	
	81OS961614LURE	4649	5346	96	16	13.75	205	17	
	Sliding Glass Door	81OIS481614LURU*	3147	3622	48	16	13.75	120	9
	Overheads, Open	81OIS641614LURU**	3516	4042	64	16	13.75	150	11
	Ends	81OIS801614LURU	4042	4649	80	16	13.75	180	14
	81OIS961614LURU	4649	5346	96	16	13.75	210	17	

**ORDERING NOTES:**

Please see page 226 for instructions on overhead suffix designations. For example, LURE means that the overhead is Left Under-supported/Right End supported.

For paper management, please add PM before the 'L' in the model number, see page 228 for ordering instructions and pricing. Paper management cases can only be end supported.

Tackboard and L.E.D. lights are an integral part of each WorkWall and MUST BE ordered to complete a WorkWall.

Locks are optional at an upcharge of **\$152 list per set** of 2 doors. Locks are standard on all file and lateral file drawers.

Double height overheads feature adjustable shelving.

Glass door overheads are NOT available on KrugExpress. Locks are not available on glass doors.

**ORDERING PROCEDURE**

To order, please specify the following:

- 1) Krug product model number
- 2) Wood species and finish, see page 114
- 3) Pull style and finish, see page 116
- 4) V-Beam color, see page 117
- 5) Grommet location and style if applicable

\* Indicates model illustrated by line drawing

**CODE DESCRIPTION**

- L - left hand position
- R - right hand position
- E - end-supported
- U - under-supported
- OH - hinged door overheads
- OO - open overheads
- OS - sliding glass overhead, closed ends
- PM - paper management



**STANDARD FINISHES**

For a complete list of standard wood finishes please see page 114. If specifying a palette finish, change model number prefix to 83, e.g. 83OH0814LURE.

**SLIDING GLASS DOOR OVERHEADS**

Sliding glass door overheads with OPEN ENDS can only be specified if under-supported by two 16" wide piers and are NOT available with paper management.

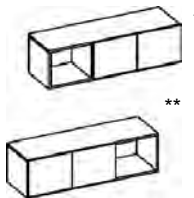
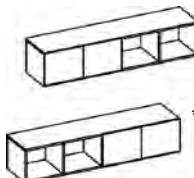
# VESTRADA | WORKWALL COMPONENTS/OVERHEADS

Description	Model	Cherry Rift		W	D	H	Shipping Weight	Cubic Feet	
		Oak	Walnut						
48" Wood Door/Open Combination Over- heads 	81OHO48161401LERE*	2459	2827	48	16	14	120	9	
	81OHO48161402LERE**	2459	2827	48	16	14	120	9	
	81OHO48161401LERU	2459	2827	48	16	14	120	9	
	81OHO48161402LERU	2459	2827	48	16	14	120	9	
	81OHO48161401LURE	2459	2827	48	16	14	120	9	
	81OHO48161402LURE	2459	2827	48	16	14	120	9	
	81OHO48161401LURU	2459	2827	48	16	14	120	9	
	81OHO48161402LURU	2459	2827	48	16	14	120	9	
	<hr/>								
	64" Wood Door/Open Combination Over- heads 	81OHO64161402LERE*	2671	3071	64	16	14	150	11
81OHO64161403LERE**		2671	3071	64	16	14	150	11	
81OHO64161402LERU		2671	3071	64	16	14	150	11	
81OHO64161403LERU		2671	3071	64	16	14	150	11	
81OHO64161402LURE		2671	3071	64	16	14	150	11	
81OHO64161403LURE		2671	3071	64	16	14	150	11	
81OHO64161402LURU		2671	3071	64	16	14	150	11	
81OHO64161403LURU		2671	3071	64	16	14	150	11	
<hr/>									
80" Wood Door/Open Combination Over- heads 	81OHO80161402LERE	3156	3628	80	16	14	180	14	
	81OHO80161403LERE*	3156	3628	80	16	14	180	14	
	81OHO80161404LERE	3156	3628	80	16	14	180	14	
	81OHO80161402LERU	3156	3628	80	16	14	180	14	
	81OHO80161403LERU	3156	3628	80	16	14	180	14	
	81OHO80161404LERU	3156	3628	80	16	14	180	14	
	81OHO80161402LURE	3156	3628	80	16	14	180	14	
	81OHO80161403LURE	3156	3628	80	16	14	180	14	
	81OHO80161404LURE	3156	3628	80	16	14	180	14	
	81OHO80161402LURU	3156	3628	80	16	14	180	14	
	81OHO80161403LURU	3156	3628	80	16	14	180	14	
	81OHO80161404LURU	3156	3628	80	16	14	180	14	

**ORDERING NOTES:**

Please see page 226 for instructions on overhead suffix designations. For example, LURE means that the overhead is Left Under-supported/Right End supported.

For paper management, please add PM before the 'L' in the model number, see page 228 for ordering instructions and pricing. Paper management cases can only be end supported.

Tackboard and L.E.D. lights are an integral part of each WorkWall and MUST BE ordered to complete a WorkWall.

Locks are optional at an upcharge of **\$152 list per set** of 2 doors. Locks are standard on all file and lateral file drawers.

Double height overheads feature adjustable shelving.

Glass door overheads are NOT available on KrugExpress. Locks are not available on glass doors.

**DIMENSION KEY**

W - width  
 D - depth  
 H - height

**CODE DESCRIPTION**

L - left hand position  
 R - right hand position  
 E - end-supported  
 U - under-supported  
 03 - two glass left, remainder wood  
 04 - two wood left, remainder glass  
 07 - four glass left, remainder glass  
 08 - four wood left, remainder glass  
 09 - one glass, wood, one glass

**STANDARD FINISHES**

For a complete list of standard wood finishes please see page 114. If specifying a palette finish, change model number prefix to 83, e.g. 83OH0814LURE.

**COMBINATION OVERHEADS**

Combination styles are designated by a numerical reference as listed in the code description. Combinations are only available as listed.

# VESTRADA | WORKWALL COMPONENTS/OVERHEADS

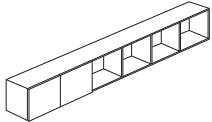
Description	Model	Cherry Rift		W	D	H	Shipping Weight	Cubic Feet
		Oak Walnut	Maple					
	81OHO96161402LERE*	3682	4234	96	16	14	210	17
	81OHO96161407LERE	3682	4234	96	16	14	210	17
	81OHO96161402LERU	3682	4234	96	16	14	210	17
	81OHO96161407LERU	3682	4234	96	16	14	210	17
	81OHO96161402LURE	3682	4234	96	16	14	210	17
	81OHO96161407LURE	3682	4234	96	16	14	210	17
	81OHO96161402LURU	3682	4234	96	16	14	210	17
	81OHO96161407LURU	3682	4234	96	16	14	210	17

**ORDERING NOTES:**

Please see page 226 for instructions on overhead suffix designations. For example, LURE means that the overhead is Left Under-supported/Right End supported.

For paper management, please add PM before the 'L' in the model number, see page 228 for ordering instructions and pricing. Paper man-agement cases can only be end supported.

Tackboard and L.E.D. lights are an integral part of each WorkWall and MUST BE ordered to complete a WorkWall.

Locks are optional at an upcharge of **\$152 list per set** of 2 doors. Locks are standard on all file and lateral file drawers. Double height overheads feature adjustable shelving.

Glass door overheads are NOT available on KrugExpress.Lockers are not available on glass doors.

Combination styles are designated by a numerical reference as listed in the code description. Combinations are only available as listed.

**ORDERING PROCEDURE**

To order, please specify the following:

- 1) Krug product model number
- 2) Wood species and finish, see page 114
- 3) Pull style and finish, see page 116
- 4) V-Beam color, see page 117
- 5) Grommet location and style if applicable

\* Indicates model illustrated by line drawing

**CODE DESCRIPTION**

- L - left hand position
- R - right hand position
- E - end-supported
- U - under-supported
- 03 - two glass left, remainder wood
- 04 - two wood left, remainder glass
- 07 - four glass left, remainder glass
- 08 - four wood left, remainder glass
- 09 - one glass, wood, one glass

**STANDARD FINISHES**

For a complete list of standard wood finishes please see page 114. If specifying a palette finish, change model number prefix to 83, e.g. 83OH0814LURE.

**COMBINATION OVERHEADS** Combination styles are designated by a numerical reference as listed in the code description. Combinations are only available

# VESTRADA | WORKWALL COMPONENTS/OVERHEADS

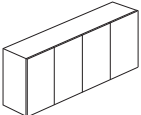
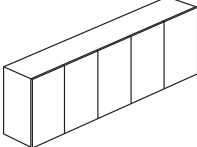
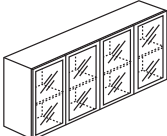
Description	Model	Cherry Rift		W	D	H	Shipping Weight	Cubic Feet
		Oak	Walnut					
Double Height Wood Door Overheads  *  **	81OH481628LERE*	2978	3425	48	16	28	150	15
	81OH641628LERE	3303	3796	64	16	28	200	21
	81OH801628LERE	3505	4029	80	16	28	250	26
	81OH961628LERE	3866	4444	96	16	28	300	30
	81OH481628LERU	2978	3425	48	16	28	150	15
	81OH641628LERU	3303	3796	64	16	28	200	21
	81OH801628LERU	3505	4029	80	16	28	250	26
	81OH961628LERU	3866	4444	96	16	28	300	30
	81OH481628LURE	2978	3425	48	16	28	150	15
	81OH641628LURE**	3342	3796	64	16	28	200	21
	81OH801628LURE	3505	4029	80	16	28	250	26
	81OH961628LURE	3866	4444	96	16	28	300	30
	81OH481628LURU	2978	3425	48	16	28	150	15
	81OH641628LURU	3303	3796	64	16	28	200	21
	81OH801628LURU	3505	4029	80	16	28	250	26
81OH961628LURU	3866	4444	96	16	28	300	30	
Double Height Matte Silver Framed Glass Door Overheads  *	81OH481628LEREG	3273	3763	48	16	28	150	15
	81OH641628LEREG	3634	4179	64	16	28	200	21
	81OH801628LEREG	3854	4432	80	16	28	250	26
	81OH961628LEREG	4252	4890	96	16	28	300	30
	81OH481628LERUG	3273	3763	48	16	28	150	15
	81OH641628LERUG	3634	4179	64	16	28	200	21
	81OH801628LERUG	3854	4432	80	16	28	250	26
	81OH961628LERUG	4252	4890	96	16	28	300	30
	81OH481628LUREG	3273	3763	48	16	28	150	15
	81OH641628LUREG*	3634	4179	64	16	28	200	21
	81OH801628LUREG	3854	4432	80	16	28	250	26
	81OH961628LUREG	4252	4890	96	16	28	300	30
	81OH481628LURUG	3273	3763	48	16	28	150	15
	81OH641628LURUG	3634	4179	64	16	28	200	21
	81OH801628LURUG	3854	4432	80	16	28	250	26
81OH961628LURUG	4252	4890	96	16	28	300	30	

**DIMENSION KEY**

W - width  
 D - depth  
 H - height

**CODE DESCRIPTION**

L - left hand position  
 R - right hand position  
 E - end-supported  
 U - under-supported  
 OH - hinged door overheads  
 OO - open overheads  
 OS - sliding glass overhead, closed ends  
 PM - paper management

**STANDARD FINISHES**

For a complete list of standard wood finishes please see page 114. If specifying a palette finish, change model number prefix to 83, e.g. 83OH0814LURE.

**SLIDING GLASS DOOR OVERHEADS**

Sliding glass door overheads with OPEN ENDS can only be specified if under-supported by two 16" wide piers and are NOT available with paper management.

**COMBINATION OVERHEADS**

Combination styles are designated by a numerical reference as listed in the code description. Combinations are only available as listed.

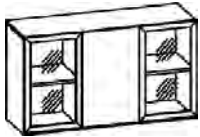

# VESTRADA | WORKWALL COMPONENTS/OVERHEADS

Description	Model	Cherry Rift		W	D	H	Shipping Weight	Cubic Feet
		Oak	Walnut					
48" Double Height	81OH48162802LERE	3173	3648	48	16	28	150	11
Matte Silver Framed	81OH48162803LERE	3173	3648	48	16	28	150	11
Glass/Wood Door	81OH48162802LERU	3173	3648	48	16	28	150	11
Combination	81OH48162803LERU	3173	3648	48	16	28	150	11
Overheads	81OH48162802LURU	3173	3648	48	16	28	150	11
	81OH48162803LURU	3173	3648	48	16	28	150	11
	81OH48162802LURE	3173	3648	48	16	28	150	11
	81OH48162803LURE	3173	3648	48	16	28	150	11
	81OH48162809LERE*	3173	3648	48	16	28	150	11
	81OH48162810LERE	3074	3535	48	16	28	150	11
	81OH48162809LERU	3173	3648	48	16	28	150	11
	81OH48162810LERU	3074	3535	48	16	28	150	11
	81OH48162809LURU	3173	3648	48	16	28	150	11
	81OH48162810LURU	3074	3535	48	16	28	150	11
	81OH48162809LURE	3173	3648	48	16	28	150	11
	81OH48162810LURE	3074	3535	48	16	28	150	11

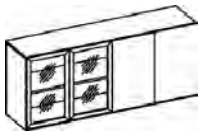
64" Double Height,	81OH64162803LERE*	3468	3985	64	16	28	200	21
Matte Silver Framed	81OH64162806LERE	3358	3865	64	16	28	200	21
Glass/ Wood Door	81OH64162803LERU	3468	3985	64	16	28	200	21
Combination	81OH64162806LERU	3358	3865	64	16	28	200	21
Overheads	81OH64162803LURE	3468	3985	64	16	28	200	21
	81OH64162806LURE	3358	3865	64	16	28	200	21
	81OH64162803LURU	3468	3985	64	16	28	200	21
	81OH64162806LURU	3358	3865	64	16	28	200	21
	81OH64162809LERE	3468	3985	64	16	28	200	21
	81OH64162810LERE	3468	3985	64	16	28	200	21
	81OH64162809LERU	3468	3985	64	16	28	200	21
	81OH64162810LERU	3468	3985	64	16	28	200	21
	81OH64162809LURE	3468	3985	64	16	28	200	21
	81OH64162810LURE	3468	3985	64	16	28	200	21
	81OH64162809LURU	3468	3985	64	16	28	200	21
	81OH64162810LURU	3468	3985	64	16	28	200	21

**ORDERING NOTES:**

Please see page 226 for instructions on overhead suffix designations. For example, LURE means that the overhead is Left Under-supported/Right End supported.

For paper management, please add PM before the 'L' in the model number, see page 228 for ordering instructions and pricing.

Paper management cases can only be end supported.

Tackboard and L.E.D. lights are an integral part of each WorkWall and MUST BE ordered to complete a WorkWall.

Locks are optional at an upcharge of **\$152 list per set** of 2 doors. Locks are standard on all file and lateral file drawers.

Double height overheads feature adjustable shelving.

Glass door overheads are NOT available on KrugExpress. Locks are not available on glass doors.

**ORDERING PROCEDURE**

To order, please specify the following:

- 1) Krug product model number
- 2) Wood species and finish, see page 114
- 3) Pull style and finish, see page 116
- 4) V-Beam color, see page 117
- 5) Grommet location and style if applicable

\* Indicates model illustrated by line drawing



**CODE DESCRIPTION**

- L - left hand position
- R - right hand position
- E - end-supported
- U - under-supported

**STANDARD FINISHES**

For a complete list of standard wood finishes please see page 114. If specifying a palette finish, change model number prefix to 83, e.g. 83OH0814LURE.

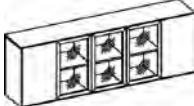
# VESTRADA | WORKWALL COMPONENTS/OVERHEADS

Description	Model	Cherry Rift		W	D	H	Shipping Weight	Cubic Feet	
		Maple	Anigre						
80" Double Height, Matte Silver Framed Glass/ Wood Door Combination Overheads 	81OH80162803LERE	3620	4164	80	16	28	250	26	
	81OH80162806LERE	3620	4164	80	16	28	250	26	
	81OH80162803LERU	3620	4164	80	16	28	250	26	
	81OH80162806LERU	3620	4164	80	16	28	250	26	
	81OH80162803LURE	3620	4164	80	16	28	250	26	
	81OH80162806LURE	3620	4164	80	16	28	250	26	
	81OH80162803LURU	3620	4164	80	16	28	250	26	
	81OH80162806LURU	3620	4164	80	16	28	250	26	
	81OH80162809LERE	3620	4164	80	16	28	250	26	
	81OH80162810LERE*	3739	4296	80	16	28	250	26	
	81OH80162809LERU	3620	4164	80	16	28	250	26	
	81OH80162810LERU	3739	4296	80	16	28	250	26	
	81OH80162809LURE	3620	4164	80	16	28	250	26	
	81OH80162810LURE	3739	4296	80	16	28	250	26	
	81OH80162809LURU	3620	4164	80	16	28	250	26	
	81OH80162810LURU	3739	4296	80	16	28	250	26	
	96" Double Height, Matte Silver Framed Glass/ Wood Door Combination Overheads 	81OH96162803LERE	3962	4559	96	16	28	300	30
		81OH96162804LERE	4155	4780	96	16	28	300	30
81OH96162807LERE		4155	4780	96	16	28	300	30	
81OH96162808LERE		3962	4559	96	16	28	300	30	
81OH96162803LERU		3962	4559	96	16	28	300	30	
81OH96162804LERU		4155	4780	96	16	28	300	30	
81OH96162807LERU		4155	4780	96	16	28	300	30	
81OH96162808LERU		3962	4559	96	16	28	300	30	
81OH96162803LURU		3962	4559	96	16	28	300	30	
81OH96162807LURU		4155	4780	96	16	28	300	30	
81OH96162804LURU		4155	4780	96	16	28	300	30	
81OH96162808LURU		3962	4559	96	16	28	300	30	
81OH96162804LURE		4155	4780	96	16	28	300	30	
81OH96162803LURE		3962	4559	96	16	28	300	30	
81OH96162807LURE		4155	4780	96	16	28	300	30	
81OH96162808LURE		3962	4559	96	16	28	300	30	
81OH96162809LERE		3962	4559	96	16	28	300	30	
81OH96162810LERE		4155	4780	96	16	28	300	30	
81OH96162811LERE		4155	4780	96	16	28	300	30	
81OH96162812LERE		3962	4559	96	16	28	300	30	
81OH96162809LERU		3962	4559	96	16	28	300	30	
81OH96162810LERU		3962	4780	96	16	28	300	30	
81OH96162812LERU		4155	4559	96	16	28	300	30	
81OH96162811LERU		4155	4780	96	16	28	300	30	
81OH96162809LURU	3962	4559	96	16	28	300	30		
81OH96162810LURU	4155	4780	96	16	28	300	30		
81OH96162811LURU	4155	4780	96	16	28	300	30		
81OH96162812LURU	3962	4559	96	16	28	300	30		
81OH96162809LURE	3962	4559	96	16	28	300	30		
81OH96162810LURE	4155	4780	96	16	28	300	30		
81OH96162811LURE	4155	4780	96	16	28	300	30		
81OH96162812LURE	3962	4559	96	16	28	300	30		

**ORDERING NOTES:**

Please see page 228 for instructions on overhead suffix designations. For example, LURE means that the overhead is Left Under-supported/Right End supported. For paper management, please add PM before the 'L' in the model number, see page 228 for ordering instructions and pricing. Paper management cases can only be end supported. Tackboard and L.E.D. lights are an integral part of each WorkWall and MUST BE ordered to complete a WorkWall. Locks are optional at an upcharge of **\$152 list per set** of 2 doors. Locks are standard on all file and lateral file drawers. Double height overheads feature adjustable shelving. Glass door overheads are NOT available on KrugExpress. Locks are not available on glass doors.

**DIMENSION KEY**

W - width  
 D - depth  
 H - height

**CODE DESCRIPTION**

L - left hand position  
 R - right hand position  
 E - end-supported  
 U - under-supported  
 03 - two glass left, remainder wood  
 04 - two wood left, remainder glass  
 06 - three wood left, remainder glass  
 07 - four glass left, remainder glass  
 08 - four wood left, remainder glass  
 09 - one glass, wood, one glass  
 10 - one wood, glass, one wood  
 11 - two glass, wood, two glass  
 12 - two wood, glass, two wood

**STANDARD FINISHES**

For a complete list of standard wood finishes please see page 114.

**COMBINATION OVERHEADS**

Combination styles are designated by a numerical reference as listed in the code description. Combinations are only available as listed.

# VESTRADA | WORKWALL COMPONENTS/OVERHEADS

TBHL - TACKBOARD L.E.D. LIGHT PRICING CHART A TBHL must be ordered in order to complete a WorkWall.

Model	FABRIC GRADES									W	H	COM
	1	2	3	4	5	6	7	8	9			
81TBHL8 402415U	854	870	905	1015	1215	1405	1596	1795	2058	40	23.5	1.25
81TBHL8 482415U	927	946	982	1108	1331	1545	1760	1981	2274	48	23.5	1.50
81TBHL8 562415U	990	1009	1044	1173	1405	1624	1844	2076	2376	56	23.5	1.74
81TBHL8 642415U	1021	1039	1067	1212	1453	1680	1911	2147	2461	64	23.5	2.00
81TBHL8 722415U	1044	1063	1089	1244	1487	1720	1955	2198	2496	72	23.5	2.25
81TBHL8 802415U	1071	1092	1114	1276	1527	1769	2010	2263	2581	80	23.5	2.50
81TBHL8 882415U	1090	1109	1134	1295	1554	1798	2042	2299	2634	88	23.5	2.75
81TBHL8 962415U	1108	1128	1153	1316	1581	1828	2077	2339	2676	96	23.5	3.0





Krug Momentum Panel Fabrics are available at grade 1 pricing. See page 9 for more information.  
 Only Krug Momentum Panel fabrics are available on *KrugExpress*.

### PAPER MANAGEMENT

The following paper management upcharges are to be added to the price of the TBHL. Specify 1 tier or 2 tier paper management with a PM1 or PM2 before size in TBHL model number, e.g., 81TBHLPM1-482415U.

TACKBOARD SIZE	48"	64"	80"	96"
1 Tier	367	372	403	443
2 Tier	738	740	805	879

# VESTRADA | WORKWALL COMPONENTS / WORKSURFACE STORAGE PIERS

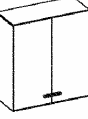
Description	Model	Cherry Rift Oak Walnut			W	D	H	Shipping Weight	Cubic Feet	
		Maple	Anigre	Palette						
	8" Piers, 26" High	81PR08142617LU*	1746	2007	1569	8	14	26	16	3
		81PR08142617RU	1746	2007	1569	8	14	26	16	3
		81PR08142611LU	1918	2206	1728	8	14	26	20	3
		81PR08142611RU	1918	2206	1728	8	14	26	20	3
		81PR08142661LU	1833	2106	1646	8	14	26	18	3
		81PR08142661RU	1833	2106	1646	8	14	26	18	3
	16" Piers, 26" High	81PR16142617LU	1823	2098	1642	16	14	26	20	5
		81PR16142617RU	1823	2098	1642	16	14	26	20	5
		81PR16142611LU*	1982	2279	1781	16	14	26	28	5
		81PR16142611RU	1982	2279	1781	16	14	26	28	5
		81PR16142661LU	1902	2186	1713	16	14	26	23	5
		81PR16142661RU	1902	2186	1713	16	14	26	23	5
	32" Piers, 26" High	81PR32142617LU	2136	2459	1923	32	14	26	36	9
		81PR32142617RU	2136	2459	1923	32	14	26	36	9
		81PR32142611LU*	2323	2671	2090	32	14	26	46	9
		81PR32142611RU	2323	2671	2090	32	14	26	46	9
		81PR32142661LU	2228	2562	2004	32	14	26	43	9
		81PR32142661RU	2228	2562	2004	32	14	26	43	9
	8" Piers, 40" High	81PR08164017LE*	2061	2369	1855	8	16	40	40	5
		81PR08164017RE	2061	2369	1855	8	16	40	40	5
		81PR08164011LE	2148	2472	1935	8	16	40	46	5
		81PR08164011RE	2148	2472	1935	8	16	40	46	5
		81PR08164061LE	2119	2437	1908	8	16	40	44	5
		81PR08164061RE	2119	2437	1908	8	16	40	44	5
	16" Piers, 40" High	81PR16164017LE	2126	2445	1913	16	16	40	55	8
		81PR16164017RE	2126	2445	1913	16	16	40	55	8
		81PR16164011LE*	2214	2545	1993	16	16	40	70	8
		81PR16164011RE	2214	2545	1993	16	16	40	70	8
		81PR16164011LEG	2489	2861	2241	16	16	40	73	8
		81PR16164011REG	2489	2861	2241	16	16	40	73	8
		81PR16164061LE	2194	2524	1976	16	16	40	64	8
		81PR16164061RE	2194	2524	1976	16	16	40	64	8
	32" Piers, 40" High	81PR32164017LE	2287	2632	2060	32	16	40	95	13
		81PR32164017RE	2287	2632	2060	32	16	40	95	13
		81PR32164011LE*	2541	2922	2286	32	16	40	110	13
		81PR32164011RE	2541	2922	2286	32	16	40	110	13
		81PR32164011LEG	2859	3289	2571	32	16	40	120	13
		81PR32164011REG	2859	3289	2571	32	16	40	120	13
		81PR32164061LE	2386	2744	2147	32	16	40	115	13
		81PR32164061RE	2386	2744	2147	32	16	40	115	13

**DIMENSION KEY**

W - width  
D - depth  
H - height

**CODE DESCRIPTION**

L - door, hinged left  
R - door, hinged right  
E - end support  
U - under support  
G - glass doors  
17 - open  
11 - closed  
61 - one open/closed wood  
PRC- linkwall corner pier





**STANDARD FINISHES**

For a complete list of standard wood finishes please see page 114.

**LOCKS**

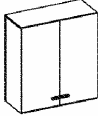
Locks are optional at an upcharge of **\$152 list per set** of 2 doors. Locks are standard on all file and lateral file drawers

# VESTRADA | WORKWALL COMPONENTS/WORKSURFACE STORAGE PIERS

Description	Model	Cherry Rift			W	D	H	Shipping Weight	Cubic Feet
		Oak	Walnut	Maple					
	81PR36164017LE	2405	2764	2164	36	16	40	100	15
	81PR36164017RE	2405	2764	2164	36	16	40	100	15
	81PR36164011LE*	2595	2986	2337	36	16	40	120	15
	81PR36164011RE	2595	2986	2337	36	16	40	120	15
	81PR36164011LEG	2921	3358	2630	36	16	40	130	15
	81PR36164011REG	2921	3358	2630	36	16	40	130	15
	81PR36164061LE	2507	2883	2256	36	16	40	120	15
	81PR36164061RE	2507	2883	2256	36	16	40	120	15
	81PR08165317LE*	2212	2542	1990	8	16	53	45	6
	81PR08165317RE	2212	2542	1990	8	16	53	45	6
	81PR08165311LE	2459	2827	2238	8	16	53	45	6
	81PR08165311RE	2459	2827	2238	8	16	53	45	6
	81PR16165317LE	2407	2768	2166	16	16	53	70	11
	81PR16165317RE	2407	2768	2166	16	16	53	70	11
	81PR16165311LE*	2615	3010	2355	16	16	53	86	11
	81PR16165311RE	2615	3010	2355	16	16	53	86	11
	81PR16165311LEG	2984	3430	2684	16	16	53	90	11
	81PR16165311REG	2984	3430	2684	16	16	53	90	11
	81PR16165361LE	2511	2886	2261	16	16	53	82	11
	81PR16165361RE	2511	2886	2261	16	16	53	82	11
	81PR32165317LE	2823	3246	2541	32	16	53	125	18
	81PR32165317RE	2823	3246	2541	32	16	53	125	18
	81PR32165311LE	3095	3559	2785	32	16	53	140	18
	81PR32165311RE	3095	3559	2785	32	16	53	140	18
	81PR32165311LEG	3481	4003	3133	32	16	53	150	18
	81PR32165311REG	3481	4003	3133	32	16	53	150	18
	81PR32165361LE*	2946	3386	2650	32	16	53	150	18
	81PR32165361RE	2946	3386	2650	32	16	53	150	18
	81PR36165317LE	2883	3315	2594	36	16	53	135	20
	81PR36165317RE	2883	3315	2594	36	16	53	135	20
	81PR36165311LE	3160	3634	2845	36	16	53	155	20
	81PR36165311RE	3160	3634	2845	36	16	53	155	20
	81PR36165311LEG*	3555	4088	3200	36	16	53	165	20
	81PR36165311REG	3555	4088	3200	36	16	53	165	20
	81PR36165361LE	3009	3459	2709	36	16	53	165	20
	81PR36165361RE	3009	3459	2709	36	16	53	165	20
16" Corner Pier- for use in Link Wall	81PRC161640	2113	2432	1905	16	16	40	70	8

**ORDERING NOTES:**

If used on overheads with 1 tier paper manager add suffix PM1 to the end of the model number. If used on overheads with 2 tier paper manager add suffix PM2 to the end of the model number. This pier can only be end supporting. Please see page 226 for ordering information.

**ORDERING PROCEDURE**

- To order, please specify the following:
- 1) Krug product model number
  - 2) Wood species and finish, see page 114
  - 3) Pull style and finish, see page 116
  - 4) V-Beam color, see page 117
  - 5) Grommet location and style if applicable

\* Indicates model illustrated by line drawing

**CODE DESCRIPTION**

- L - left hand position
- R - right hand position
- E - end-supported
- U - under-supported
- 02 - one wood, remainder glass

**STANDARD FINISHES**

For a complete list of standard wood finishes please see page 114. If specifying a palette finish, change model number prefix to 83, e.g. 83OH0814LURE.

**LOCKS**

Locks are optional at an upcharge of **\$152 list per set** of 2 doors. Locks are standard on all file and lateral file drawers.

**MILLENNIUM | TABLE OF CONTENTS**

245	Environmental Summary
246	Finishes
247	Custom Sizing & Pricing Methods
248	General Product Specification
249	Edge Detail Profile
249	Drawer Pulls & Locks
250	Grommets, PowerPorts & Wire Mgmt
251	Laminate Worksurfaces   Desks   Overheads   Hutches
252	Filing Instructions & Installation
253	Height Adjustable Worksurface with Base Enclosure
254	Sample Configuration
255	Product Enhancements
257	Desks
267	Height Adjustable Worksurfaces
275	Returns
280	Linking & Corner Units
282	Credenzas
290	Overheads
291	Hutches
297	Shells
300	Mobile Tables
301	Accessories
303	PowerPorts
306	Bookcases
309	Storage
314	Wardrobes
315	Modular Tops
317	Pedestals
319	Reception

# MILLENNIUM CASEGOODS | ENVIRONMENTAL SUMMARY

## LEED CERTIFICATION



MATERIAL CONTENT:

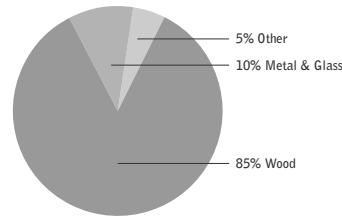

PRE-CONSUMER RECYCLED CONTENT - 81%  
POST-CONSUMER RECYCLED CONTENT - 3%

		CONTRIBUTES TO
Credit 2.1 - 2.2	Construction Waste Management	1-2 point(s)
Credit 3.3	Resource Reuse	1 point
Credit 4.1	Recycled Content	1 point
Credit 4.2	Recycled Content	1 point
Credit 4.5	Low Emitting Materials, (MUST BE REQUESTED ) Composite Wood & Laminate Adhesives	1 point
Credit 5.1	Regional Materials*	1 point
Credit 6	Rapidly Renewable Materials (MUST BE REQUESTED )	1 point
Credit 7	Certified Wood (MUST BE REQUESTED )	1 point

\*This credit is only applicable if in total 20% of the combined value of the procurement of construction materials and in the furniture are manufactured within a radius of 500 miles. This credit will apply if the installation of the finished product occurs within 500 miles of Kitchener, Ontario.

### level® CERTIFICATION



BIFMA's e3 Furniture Sustainability Standard is a voluntary, multi-attribute standard that measures the degree of sustainability of furniture. This standard evaluates product and company environmental attributes and compliance systems in a wide range of elements which include Materials, Energy & Atmosphere, Human & Ecosystem Health and Social Responsibility. Millennium products have earned level®, BIFMA's sustainability certification program for furniture, certification through third-party verification against the e3 standard. All Millennium products can be supplied with level® certification. In order to accomplish this, the product must also be ordered with the air-emissions-certification option. Contact customer service for information and upcharges.

### AIR-EMISSIONS

All Millennium products can be supplied with air-emissions-certified materials. Contact customer service for information and upcharges.



the mark of responsible forest

### FSC®

FSC® In 2005, Krug received Forest Stewardship Council® (FSC®) Chain-of-Custody certification for our manufacturing facilities. The FSC® Chain-of-Custody tracks certified wood from seedling to final sale. It verifies that the material for our FSC® certified products only come from well-managed, FSC®-certified forests and other controlled sources. FSC® is dedicated to the promotion of responsible forest management worldwide helping to take care of forests for future generations. Millennium and other Krug products can be specified with FSC® Certification. Contact customer service for further information, pricing and lead times.



In addition, architects, designers, and building professionals can specify FSC®-certified products in order to achieve a point from the U.S. Green Building Council's Leadership in Energy and Environmental Design (LEED) Rating System.

# MILLENNIUM | WOOD FINISHES

## WOOD FINISHES

Standard wood finishes are:

### SPECIES FINISH

- Cherry
  - Light Cherry
  - Natural Cherry
  - American Cherry
  - Medium Cherry
  - Standard Cherry
  - Imperial Cherry
  - Appalachian Cherry
  - Sable Cherry
  
- Maple
  - Clear Maple
  - Honey Maple
  - Wheat Maple
  
- Walnut
  - Natural Walnut
  - Regular Walnut
  - Mahogany on Walnut
  - Dark Walnut
  - Cordovan Walnut

## NATURAL CHARACTERISTICS OF WOOD

Wood is a natural product with inherent color variations that will never be fully mitigated by the finishing process. Please anticipate variation in colors within a single unit, from piece to piece, and from Krug wood finish samples. If a very close match is required, a sample must be provided with the order and an upcharge will apply. Exact color matches are not possible.

## CUSTOM WOOD FINISHES

Add 10% net to your order for special finishes, minimum charge is **\$551 list per finish** per order. (For example, on all orders up to \$5250 list, an upcharge of **\$551 will apply**, on orders \$5250 and up add 10% net to your order.)

For orders with special finishes, a sample that is a minimum 3" by 3" must be received with the order. Special finishes may add additional lead time to production schedules. Since wood is a natural product, some variations in grain, color, and stain acceptance will occur. In our finishing processes, we try to minimize variations, but some variation between samples and finished goods should be anticipated.

## BIRDSEYE MAPLE

Bookmatched Birdseye Maple veneer is available on Millennium at an upcharge of **\$76 list per square foot**. Specify clearly on order. Birdseye Maple is recommended in clear finish only. Birdseye Maple only applies to tops.

## DUAL FINISH

Add 10% net per item if specifying dual finish

## VENEER

Millennium veneer is flat cut

## WOOD FINISHES TO MATCH STANDARD

### LAMINATES

- Copper on Cherry
- Shiraz Cherry
- Park Avenue Walnut
- Chocolate on Walnut
- Nutmeg on Walnut
- Dark Walnut
- Hardrock Maple



# MILLENNIUM | CUSTOM SIZING & PRICING METHODS

## CUSTOM SIZING

Now you can customize the sizing of most components and obtain prices immediately using a few simple guidelines. Customized products may require an extended lead time if they have not been previously engineered. Please see following page for instructions.

Products that can be custom sized:

Desks, Table Desks, Curvilinear Desks (excluding curvilinear shaped units with a non-standard radius)

Linking Units

Returns, Curvilinear Returns (excluding curvilinear shaped units with a non-standard radius), Knee-hole Credenzas, Full Face Credenzas Shells

Modular Tops

Modesty Panels (excluding perforated modesty panels)

Hutches, Wall Units, Wood Door Overheads, Wood Door Work Walls

Bookcases, Wood Door Storage Units

Gallery Desks, Gallery Knee-hole Credenzas, Gallery Linking Units, Gallery Returns

Paper Managers 6800, 6900, & 9800 (excluding those with drawers)

## PRICING METHOD

Custom widths: Apply the price of the same unit in the price list that is one standard size larger than the desired case size (but same depth). For example: The required custom dimension is 74" x 24". The first standard size above this is 78" x 24", so in this case, you would apply the price of the 78" x 24" unit.

Custom depths: Apply the price for the same unit one size deeper (but same width). For example: The required custom dimension is 72" x 26". The first standard size above this is 72" x 30", so in this case, you would apply the price of the 72" x 30" unit.

Custom width & depths: Apply the price for the same unit both one size wider and one size deeper.

For example: The required custom dimension is 74" x 26". The first standard size above this is 84" x 30", so in this case, you would apply the price of the 84" x 30" unit.

Custom height of desk height cases: Add 18%. (31-32" HI)

## OTHER PRICING METHODS

cases where tops are flush left/right or both, add	\$120 list
Grommets in non-standard positions, add:	\$152 list
To remove hutch or overhead doors, deduct:	4% list
convert 5-hi hutch to 6-hi hutch, add:	20% list
Bookcases with optional pull out printer shelf at standard shelf height, add:	\$238 list
Bookcases with optional vent in back (includes 2 vents and 1 grommet), add:	\$302 list
2 lateral file and 3 or 4 closed shelves - convert to half open, half closed shelves, add	15% list
2 lateral file and 3 or 4 closed shelves - convert to half open, half wa drobe, add:	15% list
To remove storage doors for open shelves, deduct:	4% list
glass transition tops, add:	\$1095 list (30" & under)
- glass transition tops are affixed via brushe	\$1266 list (Over 30" up to 60")
metal stanchions, and finished with brushed metal caps	\$1423 list (over 60" up to 84")
	\$1584 list (over 84" up to 96")
glass tops on buffets, add:	\$2374 list (for 60, 72, & 84" cases)
Angire, add:	20% list on Maple pricing

## EXCEPTIONS TO THE PRICING METHODS ABOVE

Sizes larger than the largest shown Price List.

Non-standard extension on drawer slides.

Non-standard drawer depths in standard depth pedestals.

Glass door - any style.

Glass - face mounted modesty panels.

Perforated modesty panels.

Cases with curvilinear tops where the radius becomes non-standard.

A/V cabinets.

Any case with flipper doors

Please contact Specials Coordinator or Krug Customer Service at 1.888.578.KRUG if you require assistance.

PLEASE NOTE: Cases with non-standard features do not apply to the rules above.

Contact Krug Customer Service if you require assistance.

# MILLENNIUM | GENERAL PRODUCT SPECIFICATIONS

## WORKSURFACES

Tops are made of 1 1/2" - 45 lbs. per cubic foot density particle board core with face and back veneer. All edges have 1 1/2" wide 3/4" thick Walnut, Cherry or Maple headers.

## GABLES

Gables are 1 1/8" thick - 45 lbs. per cubic foot density particle board core, 3 ply. Edges are banded with veneer.

## VENEER

External face veneers are #1 grade flat sliced Black Walnut, Cherry or Maple book-matched and of uniform color and grain pattern.

## SOLIDS

All solids used shall be American Black Walnut, Cherry or Maple kiln-dried by the manufacturer to a 6% moisture content.

## FINISH

All finished surfaces are well sanded before applying finishing materials. The procedure begins by applying a base color via an N.G.R. stain. A wash coat follows to further enhance the color. A filter coat is applied to fill open pores and wipe clean. A sealer coat is applied and scuff-sanded to prepare for the top coat (finish). The final procedure is to apply catalyzed varnish that when dry has a sheen value of 32°.

## LOCKS

Locks are standard on all pedestals and storage unit lateral file drawers

Locks are optional on door fronts and must be specified at time of order.

For Master Key, note clearly on p.o. and **add \$40 list.**

## DRAWERS

Desk box drawers have fully progressive full extension slides and are load rated at 100 lbs. per drawer.

Desk files drawers have a load bearing capacity of 130 lbs. and box drawers have a load bearing capacity of 100 lbs

Other pedestal file drawers have fully progressive, full extension slides and are load rated at 100 lbs. per drawer.

All drawer interiors are clear finished Birch on particle board constructed with dowels.

All file drawers are equipped for letter and legal filing

All box/box/file pedestals in desks only are supplied with one matching pencil tray.

## GLIDES

Adjustable glides are installed at factory and allow for 3/4" adjustment.

## HINGES

Doors have a European style hinges with a 95° opening.

## PULLS

Pulls are available in Satin Nickel, Matte Black, Polished Chrome, Black Chrome and Brushed Brass.

Please specify on your order.







## TESTING INFORMATION

Millennium meets or exceeds the testing requirements of ANSI/BIFMA X5.5-2014 and/or X5.9 - 2012.



# MILLENNIUM | EDGE DETAIL PROFILES, DRAWER PULLS & LOCKS

An edge detail profile must be selected for every Millennium product. Millennium product is available in the following profile options

-  **Seville** - contrasting crisp and rounded sculpted edge
-  **Valen** - transitional beveled edge
-  **Torrens** - softened square edge
-  **Madrid** - ribbon fluted edge
-  **Barcelona** - half round edge
-  **Zamora** - bull nose edge
-  **Williamsburg** - traditional edge

## PROFILE LOCATIONS

**Desk, Credenzas and Shells:** profile is located on all side

**Curvilinear Shaped Tops:** profile is located on all four side

**Bookcase and Storage Units:** profile is located on all four side

**Hutches:** profile is located on all three sides

**Link Units, Curvilinear Returns and Returns:** when units are connected to create a larger worksurface area, some profile options have covered edges to create a smooth transition from one surface to another.

The following profiles have covered edges on connecting ends of return and linking units: Seville, Valen, Barcelona, Williamsburg, Zamora All other profile options will appear on all sides of the case, meeting each other face to face at worksurface connection points

## DRAWER PULLS

**Luna, Eclipse and Crescent** Pulls are available in Satin Nickel, Matte Black, Polished Chrome, Black Chrome, and Brushed Brass. Pull color and style must be stated clearly on the purchase order. Pulls are located on all drawer fronts, storage wood doors, and bookcase wood doors. Glass door bookcases feature the Luna knob in the same finish as pulls on the order. Glass door hutches and wood door hutches do not have pulls.



Luna



Eclipse



Crescent



**Oyster** pulls are available in Matte Black, Polished Chrome, and Brushed Brass.



### WILLIAMSBURG

A Williamsburg pull in Polished Brass is standard on all products specified with the Williamsburg edge detail.

## LOCKS

Locks are provided as a standard features on all pedestals, including those in desks, credenzas and lateral file storage units. Lock plugs on desks are located in the kneespace on the pedestal side panel. Locks are not available on all glass doors. Locks are available on bookcase doors at an upcharge of **\$152 list** per set of (2 doors, please specify at time of order. If a hutch or overhead has an uneven amount of doors the single lock required is also **\$152**. Lock plugs for bookcase doors are generally located on the top inside corner of the door front. Lock plugs for hutch and overhead doors are generally located on the lower inside corners. Suites can be keyed alike at no upcharge, please specify on your purchase order

# MILLENNIUM | GROMMETS & POWERPORTS

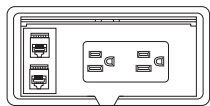

### POWER / DATA / VOICE MODULE (SUPPLIED WITH WIRED HUTCHES)

Black, rectangular with flip down cove . Includes two power outlets, one voice port, and one data port.

**POWER DETAILS:**  
two Simplex outlets  
15 Amp, 10 ft. cord

**COMMUNICATION DETAILS:**  
one 6-pin and one 8-pin connector

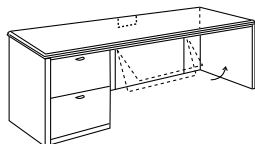

### WIRE MANAGEMENT CUT-OUT AND HINGED MODESTY PANELS

Returns, link units and credenzas with fixed modesty panels can be specified with an 8" x 1 1/2" wire management cut-out. All hinged modesty panels feature a cut-out as a standard. The discreet cut-out allows for clean and easy access to power, data and communication sources.

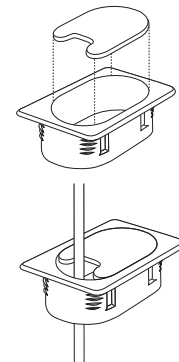

### GROMMETS

All cases may be specified with one grommet in a standard position at no upcharge. A **\$152 list upcharge** will apply to additional grommets in standard positions and for grommets requested in non-standard positions a **\$152 list upcharge** will apply. The grommet position must be indicated for each case on the purchase order.

**Standard Grommet**  
Black or Grey, rectangular, 4 1/8" x 2 11/16". Please note grommet color on purchase order.

Please specify grommet color when ordering, Grommets can also be field installed with power drill 2 1/4 hole saw and rasp or saber saw. Template for drilling is available.

Please keep in mind the location of grommets when specifying paper managers for use with worksurfaces. For example, a paper manager on the left hand side may be used with a "C", "BR" or "AR" grommet.

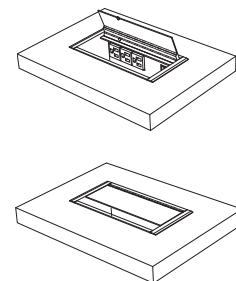

### POWERPORT

A PowerPort is a unique worksurface mounted module that can be specified to a location that best serves the user's needs. It includes a UL approved electrical, voice and data power bar, containing two 115 - volt electrical simplex outlets which are accessible from the work surface, plus a utility outlet at the end for daisy chaining purposes. 3 data versions are available.

### PORT

A service module having no power bar will serve as a large grommet. A hinged lid easily enables the passage of several cables and devices

### STANDARD GROMMET POSITIONS

#### Desks, Credenzas, Link Units & Returns

30" Deep Desks:

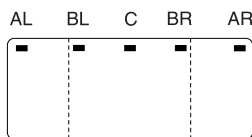

**Position Code:**  
AL – left corner  
BL – left end beside pedestal gable  
C – center  
BR – right end beside pedestal gable  
AR – right corner

36" Deep Desks:

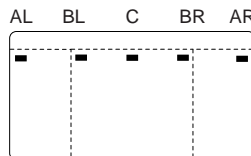

**Position Code:**  
AL – left corner  
BL – left end beside pedestal gable  
C – center  
BR – right end beside pedestal gable  
AR – right corner

### NOTE

Please do not specify grommets in the "C" position for 60-71" ganged pedestal returns and credenzas. In these cases, the "C" position is over the top of a pedestal.

"BL" and "BR" are only available on tops 42" or longer.

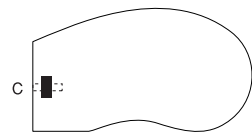

### CURVILINEAR TOPS

**Position Code:**  
C – center  
This key applies to all B, P, Q, and K shaped tops. The support panel is notched out to accommodate wire management.

# MILLENNIUM | LAMINATE, DESKS, OVERHEADS & HUTCHES

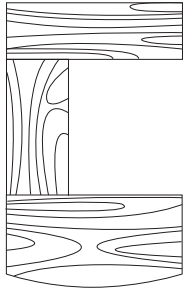

## LAMINATE WORKSURFACES

Laminate worksurfaces are available at an upcharge of 10% (a higher upcharge may apply to specially priced plastic laminates). Where there are wood profile edges on worksurface tops, they will remain as wood profile on laminate tops. Krug will order and procure laminates. Purchase orders with a plastic laminate option must include Laminate name.

When specifying laminate worksurfaces, the grain direction is such that the grain pattern runs the length of each surface, as shown in the diagram on the left.

Please contact Krug Customer Service for questions pertaining to laminate grain direction.

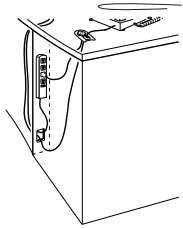

## DESKS WIRE MANAGEMENT CAVITY

Millennium desks can also be specified with a hidden wire management cavity. This finished cavity is accessed from the front of the desk by a hinged door and is completely concealed in the closed position. The wire management cavity includes a four receptacle power bar mounted on the inside pedestal gable. This feature allows the use of several powered items on the desk surface and greatly reduces the number of cables routed to the primary power source. The hinged cavity also effectively conceals all excess cables from view.

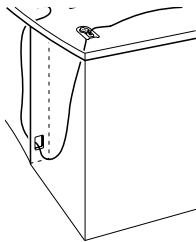

## PEDESTAL ACCESS WIRING GROMMET

All Millennium desks allow for wire management behind the pedestal drawers. Pedestal gables feature a standard cable management opening allowing access to the rear of the pedestal cavity. By specifying a wiring grommet in a standard AL or AR position (see grommet locations on page 251, cable can be conveniently threaded behind the pedestal drawers and through the wire management access grommet.

Combined with our standard wire management cover, all cables are neatly tucked out of view.

## BIRDSEYE MAPLE

Birdseye Maple Veneer is available on 6800 Millennium worksurfaces at an upcharge of **\$76 list per square foot**. Birdseye Maple is recommended in a clear finish only. This option could extend regular lead times.

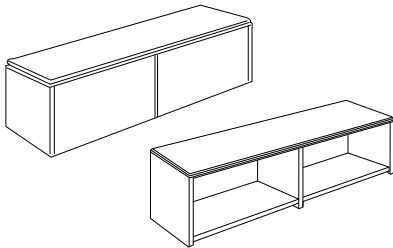

## OVERHEADS

Overheads include tasklights that are factory installed and require no field adjustment. Tasklights are mounted beneath the cabinet and hidden from view. Cords run down the right hand side of the tasklight to the worksurface where they can be routed behind the worksurface top. The use of a wall mounted tackboard conceals the cord from view. Tackboards must be ordered separately and can be specified in any fabric grade (1-9. Wall mounted tackboards for overheads are supplied with all necessary hardware for installation. Locks are optional on overheads and can be specified at time of order for an upcharge of **\$152 list per set** of (2) doors.

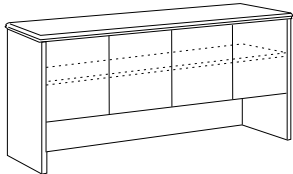

## HUTCHES

Hutches include tasklights that are factory installed and require no field adjustment. Tasklights are mounted beneath the cabinet and hidden from view. Glass doors on hutches are wood framed clear glass. A tackboard in Krug Momentum Panel grade 1 fabric is included with every hutch. Upcharges for higher graded fabrics are listed on page 297. Tackboard fabric selections should be supplied with the order information, fabric options are listed on page 4 of this price guide. Tackboards for hutches are installed at the factory and require no additional set up on site.

Hutches over 84" in length are made in two pieces and require special installation.

Hutches are available with a finished inside back panel at standard list price, but must be clearly specified on order. This option is available on hutches up to 84" in length only. This option does not include a tackboard. Locks are optional on overheads and can be specified at time of order for an upcharge of **\$152 list per set** of (2) doors.

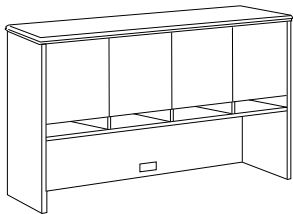

## HUTCH POWER DATA OPTION

Access to power and data is made simple by using a hutch with a power data module built right into the tackboard. The module is fully installed at the factory but can be removed to connect data links on site. It features a flip door that retracts into the case of the unit when open. See page 251 in the grommets section for complete power specifications

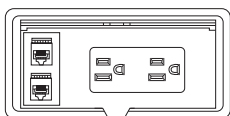

## INSTALLATION

Hutch and overhead installation instructions are included with every case, basic installation instructions can be found in this guide on page 253. All required mounting hardware is included with all hutches.

# MILLENNIUM | FILING INSTRUCTIONS & INSTALLATION

## FILING INSTRUCTIONS

All file drawers will accept both letter and legal size filling. All units are equipped with file bars to accommodate either direction. File bars are shipped taped to the inside of the drawer for safety.



### DESK PEDESTAL FILE DRAWERS

Filing Capacity:

25.5" of letter filing from front to back, or  
12" of legal filing side to side

Pedestal drawer depths allow only one row of side to side files

Legal files can be positioned in the side to side direction only.

Weight capacity of pedestal file drawers is 130 lbs

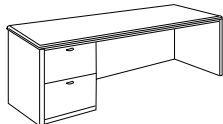

### CREDENZA AND RETURN PEDESTAL FILE DRAWERS

Filing Capacity:

15" of letter filing from front to back, or  
12" of legal filing side to side

Pedestal drawer depths can be positioned in the side to side direction only.

Weight capacity of pedestal file drawers is 100 lbs

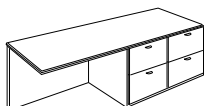

### CREDENZA, RETURN OR STORAGE LATERAL FILE DRAWERS

Filing Capacity for 30" wide drawers:

30" of letter filing front to back, or  
25" of legal filing side to side, or  
15" of legal filing front to back

When filing front to back, 30" lateral file drawer widths allow two rows of letter filing, but only one row of legal file width

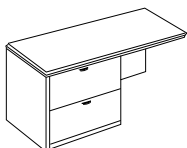

Filing Capacity for 36" wide drawers:

30" of letter filing front to back, or  
36" of legal filing side to side, or  
30" of legal filing front to back

Weight capacity of lateral file drawers is 150 lbs

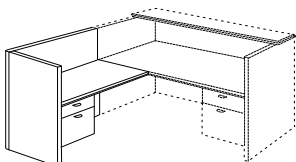

## CONNECTING WORKSURFACES

It is important that the product is in its final position and the primary work surface is leveled before connecting other joining pieces.

Detailed installation instructions are included with each unit, or available from Krug Customer Service.

Units are connected with mending plates under work surfaces, and linking brackets on modesty and end panels. Locate connections and attach the mending plates under the work surface. Level pieces if necessary by adjusting the glides to achieve flush and firm joints before completing installation of all hardware.

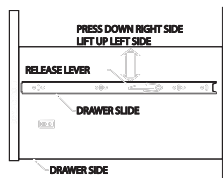

## DRAWER REMOVAL

To remove pedestal drawers, open to the extended position, press down on the right side nylon release lever and pull the drawers up on the left side lever at the same time. Continue pulling the drawers out of the case.

## GLIDE ADJUSTMENT

Raise one corner of the unit at a time and adjust the glide to the desired height by turning the glide in the hole. Make sure unit is level after adjusting the glides. Please note that the maximum adjustment range of the glides is 1 1/2". When moving units after glides have been inserted, dial the glides to the lowest position to prevent damage to the case.

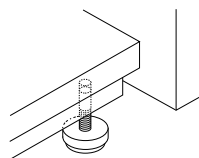

## BOOKCASE OR HUTCH DOOR ADJUSTMENT

Hinges on all hutch and bookcase doors are designed to be adjusted for depth, horizontal and vertical adjustment by means of screws into the hinge mounting plates.

To remove a door, squeeze the release clip and pull out the door, disconnecting the hinges.

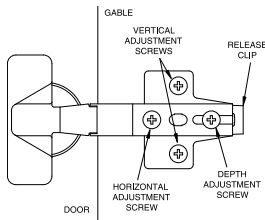

## OVERHEAD INSTALLATION

The wall mount overhead storage units must be installed on wall studs. The first step for installation is to locate the studs in the wall where the overhead is to be mounted. Measure the stud center line location and use this measurement to mark the hole locations on the mounting rail and the overhead back. Drill clearance holes at the hole locations. Hole requirements will depend on the fasteners chosen by the installer. 2 1/2" x #10 wood screws are adequate if going into wood studs. If studs cannot be accessed, then appropriate drywall plugs or butterfly bolts should be used. We recommend 2 fasteners per stud.

Fasten the mounting rail to the wall ensuring that it is level. Hang the overhead on the mounting rail and then fasten it to the wall. This prevents accidental removal and also allows for some leveling adjustment.

# MILLENNIUM | HEIGHT ADJUSTABLE WORKSURFACE WITH BASE ENCLOSURE

## Single Stage Mechanism With Base Enclosure

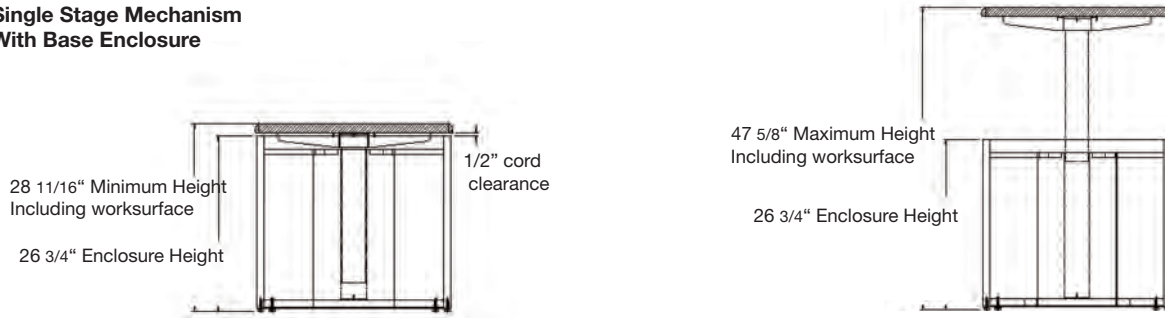

The Single Stage mechanism with Base Enclosure has an adjustable height range of 28 11/16 - 47 5/8 inches. When the worksurface is at the lowest stage - desk height, the space between underside of the worksurface and the top of the Base Enclosure is 1/2 inch.

## Dual Stage Mechanism With Base Enclosure

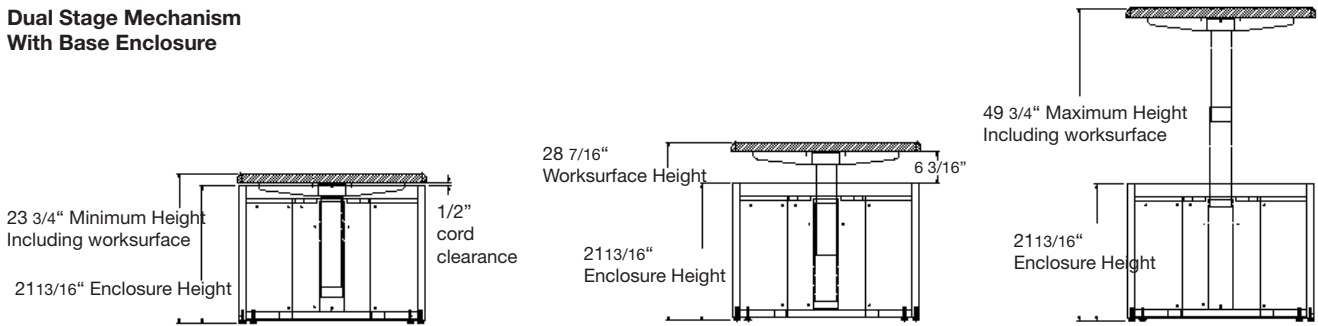

The Dual Stage mechanism with Base Enclosure has an adjustable height range of 23 3/4 - 49 3/4 inches. When the worksurface is at the standard desk height setting of 28 7/16", the space between underside of the worksurface and the top of the Base Enclosure is 6 inches. This allows for the full range of height adjustments.

Custom Base Enclosures for the Dual Stage are available decreasing the gap below the worksurface to 1/2 inch.

Caution: this eliminates the ability to use the lower stage settings.

Custom Base Enclosures to further lower the minimum worksurface height are also available, removing the inside enclosure floor completely and allowing a minimum desk height of 22 7/16". Contact customer service for a quote.

# MILLENNIUM | SAMPLE CONFIGURATIONS

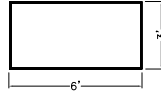
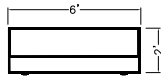
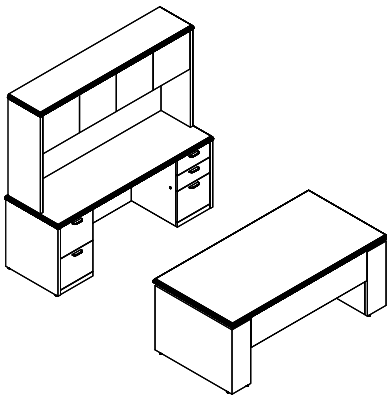

	Model	Cherry Maple Walnut
Height Adj. Desk	68HA7136ETSGV21	6945
Hutch	68HT7115	5036
Credenza	68CY71244LDRF	5912
<b>TOTAL</b>		<b>17,893</b>

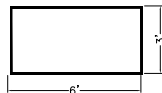
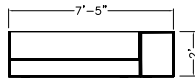
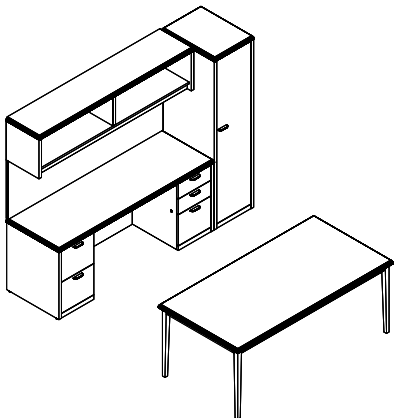

	Model	Cherry Maple Walnut
Desk	68TDE7136	4822
Overhead	68OO711517	2485
Tackboard	68TBOH71	568
Credenza	68CY71244LDRF	5912
Flush Right	option	120
Storage	68ST18246811R	3635
<b>TOTAL</b>		<b>17,542</b>

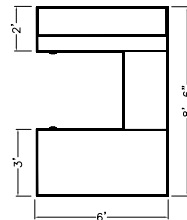
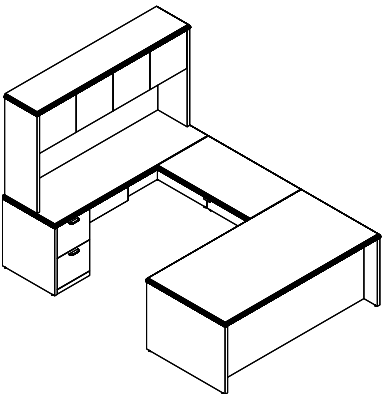

	Model	Cherry Maple Walnut
Desk	68D71364LORF	5087
Link Unit	68LU4224H	1920
Hutch	68HT7115	5036
Credenza	68CY71244LDR0	5498
<b>TOTAL</b>		<b>17,541</b>

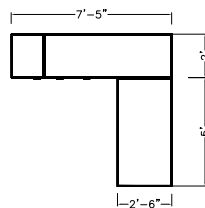
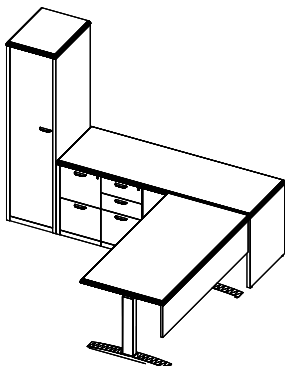

	Model	Cherry Maple Walnut
Height Adj. Desk	68HA6030ETSV21	4377
Credenza	68C71204LDFR0	5835
Flush Left	option	120
Storage	68ST18246811L	3636
<b>TOTAL</b>		<b>13,968</b>



# MILLENNIUM PRODUCT ENHANCEMENTS

Please follow the instructions below to enhance Millennium with optional product features.

## INSTRUCTIONS

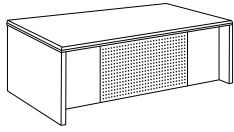

**DESK WITH PERFORATED METAL MODESTY PANEL**  
 Not available on 3/4 Height Pedestal Desks  
 Available on Desks 66" and up  
 Add 'P' to model number prefix  
 Example: 68-DP-6030-LDRD  
**10% list upcharge**

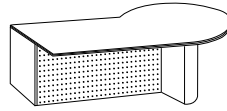

**CURVILINEAR RETURNS WITH PERFORATED METAL MODESTY PANEL**  
 Only available on 71" & 84" units and only available in conjunction with Half Drum Base  
 Add 'P' to model number prefix  
 Example: 68PPRL-7130-DB  
**20% list upcharge**

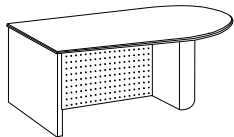

**CURVILINEAR DESKS WITH PERFORATED METAL MODESTY PANEL**  
 Only available on 71" & 84" units and only available in conjunction with Half Drum Base  
 Add 'P' to model number prefix  
 Example: 68BDP-7130-DB  
**20% list upcharge**

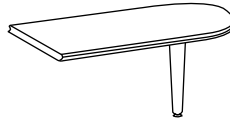

**CURVILINEAR RETURNS WITH TAPERED BRUSHED ALUMINUM POST LEG**  
 Only available on Returns without Modesty Panels  
 Add 'T' to model number suffix  
 Example: 68BR-6630-T  
**No upcharge**

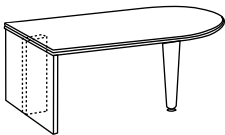

**CURVILINEAR DESKS WITH TAPERED BRUSHED ALUMINUM POST LEG**  
 Only available on Desks without Modesty Panels  
 Add 'T' to model number suffi  
 Example: 68BD-6630-T  
**No upcharge**

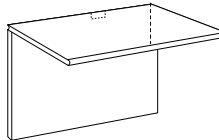

**LINK UNIT WITH WIRE MANAGEMENT CUT-OUT ON MODESTY PANEL**  
 Available in standard center position  
 Note clearly on purchase order  
**\$194 list upcharge**

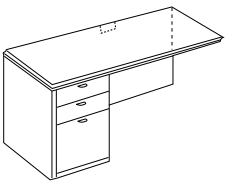

**RETURNS WITH WIRE MANAGEMENT CUT-OUT ON MODESTY PANEL**  
 Not available on Desk Depth Returns  
 Available in standard center position on modesty panel  
 Note clearly on purchase order  
**\$194 list upcharge**

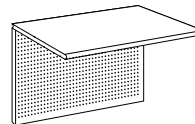

**LINK UNITS WITH PERFORATED METAL MODESTY PANEL**  
 Add 'P' to model number prefix  
 Example: 68-LUP-3024-H  
**40% list upcharge**

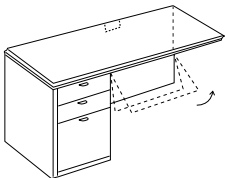

**RETURNS WITH HINGED WOOD MODESTY PANEL OPTION**  
 Add 'Y' to model number prefix  
 Example: 68RHY-4220-L4D  
**10% list upcharge**

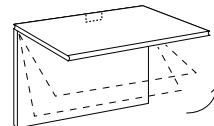

**LINK UNITS WITH HINGED WOOD MODESTY PANEL**  
 Add 'Y' to model number prefix  
 Example: 68-LUY-3024-H  
**10% list upcharge**

## ORDERING PROCEDURE

To order, please specify the following:

- 1) Krug product model number
- 2) Wood species and finish
- 3) Wood edge detail - S, V, T, M, B, Z or W, see page 250

\*Indicates model illustrated by line drawing.

## CODE DESCRIPTION

- P — perforated metal modesty panel
- T — tapered brushed aluminum panel
- Y — hinged wood modesty panel

The metal finish on perforated metal modesty panels, tapered brushed aluminum post legs, tackboard organizer rail, and accessories all match the Millennium satin nickel pull finish.

## STANDARD FINISHES

For a complete list of standard wood finishes please see page 247

## PERFORATED METAL MODESTY PANEL

Perforated metal modesty panels are 16 gage thick steel panels with a brushed metal finish

# MILLENNIUM | PRODUCT ENHANCEMENTS

Please follow the instructions below to enhance Millennium with optional product features.

## INSTRUCTIONS

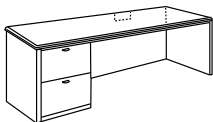

**CREDENZAS WITH CUT-OUT GROMMET OPTION ON MODESTY PANEL**  
 Note clearly on purchase order  
**\$194 list upcharge**

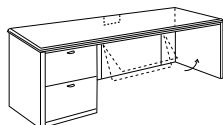

**CREDENZAS WITH HINGED WOOD MODESTY PANEL**  
 Not available on Ganged Pedestal, or Lateral File/Bookcase Credenzas  
 Add 'Y' to model number pref  
 Example: 68CY-6020-4-LDR0  
**10% list upcharge**

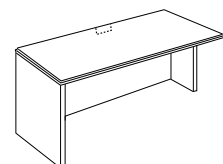

**OPEN RETURNS WITH WIRE MANAGEMENT CUT-OUT ON MODESTY PANEL**  
 Available in standard center position  
 Note clearly on purchase order  
**\$194 list upcharge**

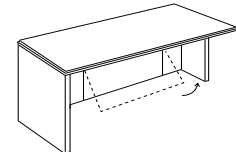

**OPEN RETURNS WITH HINGED WOOD MODESTY PANEL**  
 Add 'Y' to model number pref  
 Example: 68RHY-4224  
**10% list upcharge**



**SHELLS WITH WIRE MANAGEMENT CUT-OUT ON MODESTY PANEL**  
 Wire Management Cut-Out: 7 7/28" x 4 9/16"  
 Available in standard center position and also available on Corner Credenza Shell Model  
 Note clearly on purchase order  
**\$194 list upcharge**

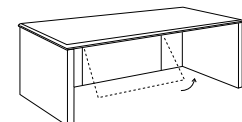

**SHELLS WITH HINGED WOOD MODESTY PANEL**  
 Width of hinged modesty panel allows for installation of 16" pedestals  
 Also available on Corner Credenza Shell Model  
 Add 'Y' to model number pref  
 Example: 68SY-3020  
**10% list upcharge**

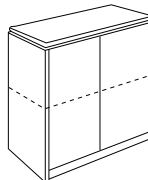

**DOUBLE HEIGHT OVERHEADS**  
 Only available on 36", 42" and 48" hinged door and open models Add '33' to model number suffix  
 Example: 680H-3633  
**25% list upcharge**

**DOUBLE HEIGHT PAPER MANAGEMENT OVERHEADS**  
 Only available on 36", 42" and 48" hinged door and open models Add 'PM' to model number suffix  
 Example: 680HPM-3629  
**35% list upcharge**

**PAPER MANAGEMENT OVERHEADS**  
 Not available on Flipper Door Models Add 'PM' to model number prefix  
 Example: 680HPM-36  
**10% list upcharge**



**MOBILE PEDESTAL WITH UPHOLSTERED SEAT**  
 Reference model #: 68MPSU-4F  
 Available in a shallow version only

FABRIC GRADES MODEL	1	2	3	4	5	6	7	8	9
Cherry/Maple/Walnut	2618	2664	2713	2757	2805	2850	2898	3036	3172

MODEL	W	D	H	SHIP WT.	CU.FT.	COM
MPSU-4F	16	18.5	25.25	76	6	1

### DIMENSION KEY

W - width  
 D - depth  
 H - height

### CODE DESCRIPTION





P — perforated metal modesty panel  
 Y — hinged wood modesty panel  
 X — hinged glass doors  
 29 — double height overheads  
 PM — paper manager  
 The metal finish on perforated metal modesty panels, tapered brushed aluminum post legs, tackboard organizer rail, and accessories match the Millennium satin nickel pull finish

### STANDARD FINISHES

For a complete list of standard wood finishes please see page 247.

**HINGED WOOD MODESTY PANEL** Hinged wood modesty panels come standard with a center positioned wire management cut-out.

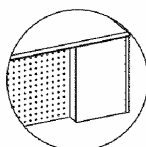
# MILLENNIUM | DESKS

Description	Model	Cherry Walnut Maple	W	D	H	KW	Shipping	
							Weight	Cubic Feet
Double Pedestal Desk with Full Height Pedestals      	68D60304LDRD	6267	60	30.25	28.5	27.5	296	36
	68D60304LDRF	6267	60	30.25	28.5	27.5	296	36
	68D60304LFRD	6267	60	30.25	28.5	27.5	296	36
	68D60304LFRF	6267	60	30.25	28.5	27.5	296	36
	68D66304LDRD	6289	65.75	30.25	28.5	33.25	314	39
	68D66304LDRF	6289	65.75	30.25	28.5	33.25	314	39
	68D66304LFRD*	6289	65.75	30.25	28.5	33.25	314	39
	68D66304LFRF	6289	65.75	30.25	28.5	33.25	314	39
	68D66364LDRD	6322	65.75	36.25	28.5	33.25	354	46
	68D66364LDRF	6322	65.75	36.25	28.5	33.25	354	46
	68D66364LFRD	6322	65.75	36.25	28.5	33.25	354	46
	68D66364LFRF	6322	65.75	36.25	28.5	33.25	354	46
	68D71304LDRD	6330	71	30.25	28.5	38.25	329	42
	68D71304LDRF	6330	71	30.25	28.5	38.25	329	42
	68D71304LFRD	6330	71	30.25	28.5	38.25	329	42
	68D71304LFRF	6330	71	30.25	28.5	38.25	329	42
	68D71364LDRD	6432	71	36.25	28.5	38.35	372	50
	68D71364LDRF	6432	71	36.25	28.5	38.35	372	50
	68D71364LFRD	6432	71	36.25	28.5	38.35	372	50
	68D71364LFRF	6432	71	36.25	28.5	38.35	372	50
	68D78304LDRD	6442	78	30.25	28.5	45.5	350	46
	68D78304LDRF	6442	78	30.25	28.5	45.5	350	46
	68D78304LFRD	6442	78	30.25	28.5	45.5	350	46
	68D78304LFRF	6442	78	30.25	28.5	45.5	350	46
	68D78364LDRD	6514	78	36.25	28.5	45.5	397	36
	68D78364LDRF	6514	78	36.25	28.5	45.5	397	36
	68D78364LFRD	6514	78	36.25	28.5	45.5	397	36
	68D78364LFRF	6514	78	36.25	28.5	45.5	397	36
68D84364LDRD	6543	84	36.25	28.5	51.5	399	39	
68D84364LDRF	6543	84	36.25	28.5	51.5	399	39	
68D84364LFRD	6543	84	36.25	28.5	51.5	399	39	
68D84364LFRF	6543	84	36.25	28.5	51.5	399	39	
Double Pedestal Desk with Full Height Pedestals & Breakfront Modesty Panel    	68DBF66364LDRD	7007	65.75	36.25	28.5	33.25	354	46
	68DBF66364LDRF	7007	65.75	36.25	28.5	33.25	354	46
	68DBF66364LFRD*	7007	65.75	36.25	28.5	33.25	354	46
	68DBF66364LFRF	7007	65.75	36.25	28.5	33.25	354	46
	68DBF71364LDRD	7104	71	36.25	28.5	38.25	372	50
	68DBF71364LDRF	7104	71	36.25	28.5	38.25	372	50
	68DBF71364LFRD	7104	71	36.25	28.5	38.25	372	50
	68DBF71364LFRF	7104	71	36.25	28.5	38.25	372	50
	68DBF78364LDRD	7212	78	36.25	28.5	45.5	397	36
	68DBF78364LDRF	7212	78	36.25	28.5	45.5	397	36
	68DBF78364LFRD	7212	78	36.25	28.5	45.5	397	36
	68DBF78364LFRF	7212	78	36.25	28.5	45.5	397	36
	68DBF84364LDRD	7210	84	36.25	28.5	51.5	399	39
	68DBF84364LDRF	7210	84	36.25	28.5	51.5	399	39
68DBF84364LFRD	7210	84	36.25	28.5	51.5	399	39	
68DBF84364LFRF	7210	84	36.25	28.5	51.5	399	39	

**ORDERING NOTES:**

30" deep desks have flush modesty panels, 36" deep desks have recessed modesty panels. Please see page 256 for perforated metal modesty panel option. Laminate worksurfaces are available at a 10% upcharge.

**ORDERING PROCEDURE**

To order, please specify the following:

- 1) Krug product model number
- 2) Wood species and finish, see page 247
- 3) Wood edge detail- I,H, L or P, see page 250
- 4) Pull style, see page 250
- 5) Grommet location if applicable

\*Indicates model illustrated by line drawing.

**CODE DESCRIPTION**

- 4 - full height pedestal
- L - left handed pedestal position
- R - right handed pedestal position
- D - 2 file drawer
- F - 2 box, 1 file drawer
- BF- break front modesty panel

**STANDARD FINISHES**

For a complete list of standard wood finishes please see page 247.

**GROMMETS**

One wiring grommet in standard position is optional at no charge. See page 251 for more power management information.

MILLENNIUM | DESKS

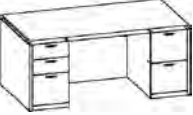
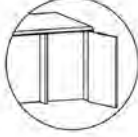
Description	Model	Cherry			W	D	H	KW	Shipping Weight	Cubic Feet
		Walnut	Maple							
Double Pedestal Desk with Full Height Pedestals & Breakfront	68DBF66364LDWRD	8447			65.75	36.25	28.5	33.25	354	46
	68DBF66364LDRDW	8447			65.75	36.25	28.5	33.25	354	46
Modesty Panel with Wire Management Cavity	68DBF66364LFRD*	8447			65.75	36.25	28.5	33.25	354	46
	68DBF66364LFRDW	8447			65.75	36.25	28.5	33.25	354	46
	68DBF66364LDWRF	8447			65.75	36.25	28.5	33.25	354	46
	68DBF66364LDRFW	8447			65.75	36.25	28.5	33.25	354	46
	68DBF66364LFRWF	8447			65.75	36.25	28.5	33.25	354	46
	68DBF66364LFRFW	8447			65.75	36.25	28.5	33.25	354	46
	68DBF71364LDWRD	8572			71	36.25	28.5	38.25	372	50
	68DBF71364LDRDW	8572			71	36.25	28.5	38.25	372	50
	68DBF71364LDWRF	8572			71	36.25	28.5	38.25	372	50
	68DBF71364LDRFW	8572			71	36.25	28.5	38.25	372	50
	68DBF71364LFRD*	8572			71	36.25	28.5	38.25	372	50
	68DBF71364LFRDW	8572			71	36.25	28.5	38.25	372	50
	68DBF71364LFRWF	8572			71	36.25	28.5	38.25	372	50
	68DBF71364LFRFW	8572			71	36.25	28.5	38.25	372	50
	68DBF78364LDWRD	8654			78	36.25	28.5	45.5	397	36
	68DBF78364LDRDW	8654			78	36.25	28.5	45.5	397	36
	68DBF78364LDWRF	8654			78	36.25	28.5	45.5	397	36
	68DBF78364LDRFW	8654			78	36.25	28.5	45.5	397	36
	68DBF78364LFRD*	8654			78	36.25	28.5	45.5	397	36
	68DBF78364LFRDW	8654			78	36.25	28.5	45.5	397	36
	68DBF78364LFRWF	8654			78	36.25	28.5	45.5	397	36
	68DBF78364LFRFW	8654			78	36.25	28.5	45.5	397	36
	68DBF84364LDWRD	8687			84	36.25	28.5	51.5	399	39
	68DBF84364LDRDW	8687			84	36.25	28.5	51.5	399	39
	68DBF84364LDWRF	8687			84	36.25	28.5	51.5	399	39
	68DBF84364LDRFW	8687			84	36.25	28.5	51.5	399	39
	68DBF84364LFRD*	8687			84	36.25	28.5	51.5	399	39
	68DBF84364LFRDW	8687			84	36.25	28.5	51.5	399	39
	68DBF84364LFRWF	8687			84	36.25	28.5	51.5	399	39
	68DBF84364LFRFW	8687			84	36.25	28.5	51.5	399	39

**DIMENSION KEY**

W - width  
D - depth  
H - height

**CODE DESCRIPTION**

4 - full height pedestal  
L - left handed pedestal position  
R - right handed pedestal position  
D - 2 file drawer  
F - 2 box, 1 file drawer  
BF- break front modesty panel  
W - Wire Management Cavity

**STANDARD FINISHES**

For a complete list of standard wood finishes please see page 247.

**GLASS DOORS**

All storage glass doors come standard with a vertical Massa pull. Other pull options are not available on glass doors.

# MILLENNIUM | DESKS

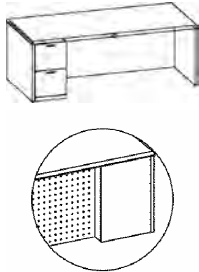
Description	Model	Cherry Walnut Maple	W	D	H	KW	Shipping Weight	Cubic Feet
Single Pedestal Desk with Full Height Pedestal	68D60304LDR0	4919	60	30.25	28.5	27.5	239	36
	68D60304LFR0	4919	60	30.25	28.5	27.5	239	36
	68D60304LORD	4919	60	30.25	28.5	27.5	239	36
	68D60304LORF	4919	60	30.25	28.5	27.5	239	36
	68D66304LDR0	4959	65.75	30.25	28.5	33.25	257	39
	68D66304LFR0	4959	65.75	30.25	28.5	33.25	257	39
	68D66304LORD	4959	65.75	30.25	28.5	33.25	257	39
	68D66304LORF	4959	65.75	30.25	28.5	33.25	257	39
	68D66364LDR0	5003	65.75	36.25	28.5	33.25	297	46
	68D66364LFR0*	5003	65.75	36.25	28.5	33.25	297	46
	68D66364LORD	5003	65.75	36.25	28.5	33.25	297	46
	68D66364LORF	5003	65.75	36.25	28.5	33.25	297	46
	68D71304LDR0	5010	71	30.25	28.5	38.25	272	42
	68D71304LFR0	5010	71	30.25	28.5	38.25	272	42
	68D71304LORD	5010	71	30.25	28.5	38.25	272	42
	68D71304LORF	5010	71	30.25	28.5	38.25	272	42
	68D71364LDR0	5087	71	36.25	28.5	38.35	315	50
	68D71364LFR0	5087	71	36.25	28.5	38.35	315	50
	68D71364LORD	5087	71	36.25	28.5	38.35	315	50
	68D71364LORF	5087	71	36.25	28.5	38.35	315	50
	68D78304LDR0	5147	78	30.25	28.5	45.5	293	46
	68D78304LFR0	5147	78	30.25	28.5	45.5	293	46
	68D78304LORD	5147	78	30.25	28.5	45.5	293	46
	68D78304LORF	5147	78	30.25	28.5	45.5	293	46
	68D78364LDR0	5178	78	36.25	28.5	45.5	340	36
	68D78364LORF	5178	78	36.25	28.5	45.5	340	36
	68D78364LDR0	5178	78	36.25	28.5	45.5	340	36
	68D78364LFR0	5178	78	36.25	28.5	45.5	340	36
	68D84364LDR0	5238	84	36.25	28.5	51.5	342	39
	68D84364LFR0	5238	84	36.25	28.5	51.5	342	39
68D84364LORD	5238	84	36.25	28.5	51.5	342	39	
68D84364LORF	5238	84	36.25	28.5	51.5	342	39	

**ORDERING NOTES:**

30" deep desks have flush modesty panels, 36" deep desks have recessed modesty panels. Please see page 256 for perforated metal modesty panel option. Laminate worksurfaces are available at a 10% upcharge.

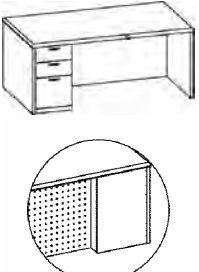
	Single Pedestal Desk with Full Height Pedestal & Breakfront Modesty Panel	68DBF66364LDR0	5667	65.75	36.25	28.5	33.25	297	46
		68DBF66364LFR0*	5667	65.75	36.25	28.5	33.25	297	46
		68DBF66364LORD	5667	65.75	36.25	28.5	33.25	297	46
		68DBF66364LORF	5667	65.75	36.25	28.5	33.25	297	46
		68DBF71364LDR0	5780	71	36.25	28.5	38.25	315	50
		68DBF71364LFR0	5780	71	36.25	28.5	38.25	315	50
		68DBF71364LORD	5780	71	36.25	28.5	38.25	315	50
		68DBF71364LORF	5780	71	36.25	28.5	38.25	315	50
		68DBF78364LDR0	5854	78	36.25	28.5	45.5	340	36
		68DBF78364LFR0	5854	78	36.25	28.5	45.5	340	36
		68DBF78364LORD	5854	78	36.25	28.5	45.5	340	36
		68DBF78364LORF	5854	78	36.25	28.5	45.5	340	36
		68DBF84364LDR0	5931	84	36.25	28.5	51.5	342	39
		68DBF84364LFR0	5931	84	36.25	28.5	51.5	342	39
		68DBF84364LORD	5931	84	36.25	28.5	51.5	342	39
		68DBF84364LORF	5931	84	36.25	28.5	51.5	342	39

**ORDERING PROCEDURE**

To order, please specify the following:

- 1) Krug product model number
- 2) Wood species and finish, see page 247
- 3) Wood edge detail- I, H, L or P, see page 250
- 4) Pull style, see page 250
- 5) Grommet location if applicable

\*Indicates model illustrated by line drawing.

**CODE DESCRIPTION**

- 4 - full height pedestal
- L - left handed pedestal position
- R - right handed pedestal position
- 0 - no pedestal
- D - 2 file drawer
- F - 2 box, 1 file drawer
- BF- break front modesty panel

**STANDARD FINISHES**

For a complete list of standard wood finishes please see page 247.

**GROMMETS**

One wiring grommet in standard position is optional at no charge. See page 251 for more power management information.

MILLENNIUM | DESKS

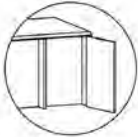
Description	Model	Cherry		W	D	H	KW	Shipping Weight	Cubic Feet
		Walnut	Maple						
Single Pedestal Desk with Full Height Pedestal	68DBF66364LDWR0	7166		65.75	36.25	28.5	33.25	307	46
	68DBF66364LFWR0*	7166		65.75	36.25	28.5	33.25	307	46
Breakfront Modesty Panel with Wire Management Cavity	68DBF66364LORDW	7166		65.75	36.25	28.5	33.25	307	46
	68DBF66364LORFW	7166		65.75	36.25	28.5	33.25	307	46
	68DBF66364LDR0W	7166		65.75	36.25	28.5	33.25	307	46
	68DBF66364LFR0W	7166		65.75	36.25	28.5	33.25	307	46
	68DBF66364L0WRD	7166		65.75	36.25	28.5	33.25	307	46
	68DBF66364L0WRF	7166		65.75	36.25	28.5	33.25	307	46
	68DBF71364LDWR0	7234		71	36.25	28.5	38.25	325	50
	68DBF71364LFWR0	7234		71	36.25	28.5	38.25	325	50
	68DBF71364LORDW	7234		71	36.25	28.5	38.25	325	50
	68DBF71364LORFW	7234		71	36.25	28.5	38.25	325	50
	68DBF71364LDR0W	7234		71	36.25	28.5	38.25	325	50
	68DBF71364LFR0W	7234		71	36.25	28.5	38.25	325	50
	68DBF71364L0WRD	7234		71	36.25	28.5	38.25	325	50
	68DBF71364L0WRF	7234		71	36.25	28.5	38.25	325	50
	68DBF78364LDWR0	7343		78	36.25	28.5	45.5	350	36
	68DBF78364LFWR0	7343		78	36.25	28.5	45.5	350	36
	68DBF78364LORDW	7343		78	36.25	28.5	45.5	350	36
	68DBF78364LORFW	7343		78	36.25	28.5	45.5	350	36
	68DBF78364LDR0W	7343		78	36.25	28.5	45.5	350	36
	68DBF78364LFR0W	7343		78	36.25	28.5	45.5	350	36
	68DBF78364L0WRD	7343		78	36.25	28.5	45.5	350	36
	68DBF78364L0WRF	7343		78	36.25	28.5	45.5	350	36
	68DBF84364LDWR0	7390		78	36.25	28.5	51.5	352	39
	68DBF84364LFWR0	7390		78	36.25	28.5	51.5	352	39
	68DBF84364LORDW	7390		78	36.25	28.5	51.5	352	39
	68DBF84364LORFW	7390		78	36.25	28.5	51.5	352	39
	68DBF84364LDR0W	7390		78	36.25	28.5	51.5	352	39
	68DBF84364LFR0W	7390		78	36.25	28.5	51.5	352	39
	68DBF84364L0WRD	7390		78	36.25	28.5	51.5	352	39
	68DBF84364L0WRF	7390		78	36.25	28.5	51.5	352	39

**ORDERING NOTES:**

30" deep desks have flush modesty panels, 36" deep desks have recessed modesty panels. Please see page 256 for perforated metal modesty panel option. Laminate worksurfaces are available at a 10% upcharge.

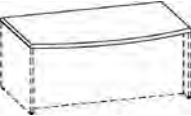
	Bow Top Option	BT68D6030	606	-	-	-	-	-	-
		BT68D6630	634	-	-	-	-	-	-
		BT68D6636	666	-	-	-	-	-	-
		BT68D7130	693	-	-	-	-	-	-
		BT68D7136*	714	-	-	-	-	-	-
		BT68D7830	731	-	-	-	-	-	-
		BT68D7836	740	-	-	-	-	-	-
		BT68D8436	752	-	-	-	-	-	-

**ORDERING NOTES:**

Add BT before any standard desk model number and apply upcharge. Add 15lbs to standard desk weight for bow top option.

**DIMENSION KEY**

W - width  
D - depth  
H - height

**CODE DESCRIPTION**

4 - full height pedestal  
L - left handed pedestal position  
R - right handed pedestal position  
0 - no pedestal  
D - 2 file drawer  
F - 2 box, 1 file drawer  
BF- break front modesty panel  
W - Wire Management Cavity

**STANDARD FINISHES**

For a complete list of standard wood finishes please see page 247.

# MILLENNIUM | TABLE DESKS & CURVILINEAR DESKS

Description	Model	Cherry	W	D	H	KW	Shipping Weight	Cubic Feet
		Walnut Maple						
	68TD6030	3224	60	30.25	28.5	57	280	38
	68TB6630	3263	65.75	30.25	28.5	63.25	290	41
	68TD7130	3327	71	30.25	28.5	68.25	300	45
	68TD7136*	3333	71	36.25	28.5	68.25	310	54
	68TD8436	3366	84	36.25	28.5	81.25	320	63

**ORDERING NOTES:**

This item includes a 68PD2116 pencil drawer.

	Table Desk Executive Style	68TDE6630	4715	65.75	36.25	29.5	180	41
		68TDE7136*	4822	71	36.25	29.5	238	54
		68TDE8436	4905	84	36.25	29.5	265	63

**ORDERING NOTES:**

This item includes a 68PD2116 pencil drawer. Table desk has a clearance height of 25.25". Does not fit a pedestal underneath.

	Bullet Desk with Wood Post Leg	68BD6030	3339	60	30.25	28.5	41.5	156	36
		68BD6630	3403	65.75	30.25	28.5	47.5	174	39
		68BD6636*	3431	65.75	36.25	28.5	44.5	214	46
		68BD7130	3470	71	30.25	28.5	52.5	159	42
		68BD7136	3539	71	36.25	28.5	49.5	232	50



**ORDERING NOTES:**

Please see page 256 for brushed aluminum tapered post leg option.

	Bullet Desk with 3/4 Modesty Panel & Wood Post Leg	68BD60303LGM	3666	60	30.25	28.5	14.75	189	36
		68BD66303LGM	3706	65.75	30.25	28.5	14.75	159	39
		68BD66364LGM	3736	65.75	36.25	28.5	17.75	229	46
		68BD71303LGM	3761	71	30.25	28.5	14.75	204	42
		68BD71363LGM*	3784	71	36.25	28.5	17.75	247	50
		68BD84303LGM	3804	84	30.25	28.5	14.75	331	49
		68BD84363LGM	3847	84	36.25	28.5	17.75	274	59

**ORDERING PROCEDURE**

To order, please specify the following:

- 1) Krug product model number
- 2) Wood species and finish, see page 247
- 3) Wood edge detail- I,H, L or P, see page 250
- 4) Pull style, see page 250
- 5) Grommet location if applicable

\*Indicates model illustrated by line drawing.

**CODE DESCRIPTION**

LGM - wood leg and modesty panel

**STANDARD FINISHES**

For a complete list of standard wood finishes please see page 247

**GROMMETS**

One wiring grommet in standard position is optional at no charge. Additional wiring grommets are available at an **upcharge of \$152.**

# MILLENNIUM | CURVILINEAR DESKS

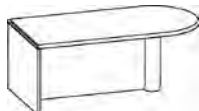
Description	Model	Cherry			W	D	H	KW	Shipping Weight	Cubic Feet
		Walnut	Maple							
	68BD60304LGM	3783		60	30.25	28.5	14.75	176	36	
	68BD66304LGM	3820		65.75	30.25	28.5	14.75	194	39	
	68BD66364LGM	3818		65.75	36.25	28.5	14.75	234	46	
	68BD71304LGM	3859		71	30.25	28.5	14.75	209	42	
	68BD71364LGM*	3890		71	36.25	28.5	17.75	252	50	
	68BD84304LGM	3929		84	30.25	28.5	14.75	232	49	
	68BD84364LGM	3965		84	36.25	28.5	17.75	279	59	

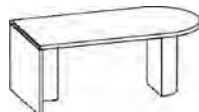
	68BD6630DB	3736		65.75	30.25	28.5	37.25	194	39
	68BD6636DB	3761		65.75	36.25	28.5	34.25	234	46
	68DB7130DB	3795		71	30.25	28.5	42.5	209	42
	68BD7136DB*	3859		71	36.25	28.5	39.5	252	50
	68BD8430DB	3924		84	30.25	28.5	55.5	232	49
	68BD8436DB	4065		84	36.25	28.5	52.5	279	59
	68BD9636DB	4200		96	36.25	28.5	64.25	320	67

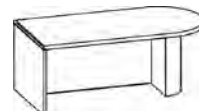
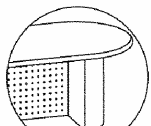

**ORDERING NOTES:**

All curvilinear post legs are 6" in diameter. Laminate worksurfaces are available at a 10% upcharge.

 	68BD6630DBML	4196		65.75	30.25	28.5	23.25	209	39
	68BD6630DBMR	4196		65.75	30.25	28.5	23.25	209	39
	68BD6636DBML	4221		65.75	36.25	28.5	26.25	249	46
	68BD6636DBMR	4221		65.75	36.25	28.5	26.25	249	46
	68BD7130DBML	4256		71	30.25	28.5	23.25	224	42
	68BD7130DBMR	4256		71	30.25	28.5	23.25	224	42
	68BD7136DBML	4290		71	36.25	28.5	26.25	267	50
	68BD7136DBMR*	4290		71	36.25	28.5	26.25	267	50
	68BD8430DBML	4322		84	30.25	28.5	23.25	247	49
	68BD8430DBMR	4322		84	30.25	28.5	23.25	247	49
	68BD8436DBML	4426		84	36.25	28.5	26.25	294	59
	68BD8436DBMR	4426		84	36.25	28.5	26.25	294	59
	68BD9636DBML	4562		96	36.25	28.5	26.25	335	67
	68BD9636DBMR	4562		96	36.25	28.5	26.25	335	67

**ORDERING NOTES:**

Please see page 256 for perforated metal modesty panel option.

 	68CCB7130L	4576		71	36.25	28.5	51.25	232	45
	68CCB7130R	4576		71	36.25	28.5	51.25	232	45
	68CCB7830L	4670		78	36.25	28.5	58.25	257	50
	68CCB7830R*	4670		78	36.25	28.5	58.25	257	50
	68CCB8430L	4758		84	36.25	28.5	64.25	268	55
	68CCB8430R	4758		84	36.25	28.5	64.25	268	55

**ORDERING NOTES:**

Please see page 256 for brushed aluminum tapered post leg option.

**DIMENSION KEY**

W - width  
D - depth  
H - height

**CODE DESCRIPTION**

4 - full height modesty panel  
L - half drum base in left-hand position  
R - right drum base in right-hand position  
DB - half drum base  
LGM - wood base and modesty panel  
DBM - half drum base and modesty panel

**STANDARD FINISHES**

For a complete list of standard wood finishes please see page 247.

**RETURN OPTIONS**

Curved corner bullet desks, "Q" desks, and "K" desks, accept 24" deep run-off units, returns and linking units.

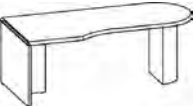

# MILLENNIUM | DESKS

Description	Model	Cherry		W	D	H	KW	Shipping Weight	Cubic Feet
		Walnut	Maple						
	68CCB7130LDB	4891		71	36.25	28.5	51.25	232	45
	68CCB7130RDB	4891		71	36.25	28.5	51.25	232	45
	68CCB7830LDB	4980		78	36.25	28.5	58.25	257	50
	68CCB7830RDB*	4980		78	36.25	28.5	58.25	257	50
	68CCB8430LDB	5077		84	36.25	28.5	64.25	268	55
	68CCB8430RDB	5077		84	36.25	28.5	64.25	268	55

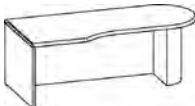
	68CCB7130LDBM	5174		71	36.25	28.5	51.25	232	45
	68CCB7130RDBM	5174		71	36.25	28.5	51.25	232	45
	68CCB7830LDBM	5263		78	36.25	28.5	58.25	257	50
	68CCB7830RDBM*	5263		78	36.25	28.5	58.25	257	50
	68CCB8430LDBM	5368		84	36.25	28.5	64.25	268	55
	68CCB8430RDBM	5368		84	36.25	28.5	64.25	268	55

**ORDERING NOTES:**

Please see page 256 for perforated metal modesty panel option.

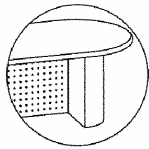

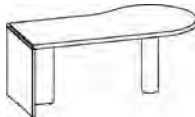
	68PDL7130	4362		71	30	28.5	50	189	50
	68PDR7130*	4362		71	30	28.5	50	189	50
	68PDL7136	4426		71	36	28.5	47.25	232	58
	68PDR7136	4426		71	36	28.5	47.25	232	58



**ORDERING NOTES:**

Please see page 256 for brushed aluminum tapered post leg option.

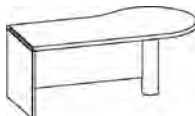
	68PDL71303LGM	4635		71	30	28.5		204	50
	68PDR71303LGM*	4635		71	30	28.5		204	50
	68PDL71363LGM	4752		71	36	28.5		247	58
	68PDR71363LGM	4752		71	36	28.5		247	58
	68PDL84303LGM	4863		84	30	28.5		227	59
	68PDR84303LGM	4863		84	30	28.5		227	59
	68PDL84363LGM	4904		84	36	28.5		274	68
	68PDR84363LGM	4904		84	36	28.5		274	68

**ORDERING PROCEDURE**

To order, please specify the following:

- 1) Krug product model number
- 2) Wood species and finish, see page 247
- 3) Wood edge detail- I,H, L or P, see page 250
- 4) Pull style, see page 250
- 5) Grommet location if applicable

\*Indicates model illustrated by line drawing.

**CODE DESCRIPTION**

- 4 - full height modesty panel
- L - half drum base in left-hand position
- R - right drum base in right-hand position
- DB - half drum base
- LGM - wood base and modesty panel
- DBM - half drum base and modesty panel

**STANDARD FINISHES**

For a complete list of standard wood finishes please see page 247.

**GROMMETS**

One wiring grommet in standard position is optional at no charge. Additional wiring grommets are available at an **upcharge of \$152.**

**MILLENNIUM | DESKS**

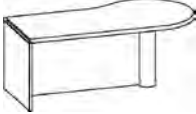
Description	Model	Cherry		W	D	H	KW	Shipping Weight	Cubic Feet
		Walnut	Maple						
'P' Desk with Full Height Modesty Panel & Wood Post Leg 	68PDL71304LGM	4740		71	30	28.5		209	50
	68PDR71304LGM*	4740		71	30	28.5		209	50
	68PDL71364LGM	4826		71	36	28.5		252	58
	68PDR71364LGM	4826		71	36	28.5		252	58
	68PDL84304LGM	4990		84	30	28.5		232	59
	68PDR84304LGM	4990		84	30	28.5		232	59
	68PDL84364LGM	5027		84	36	28.5		279	68
	68PDR84364LGM	5027		84	36	28.5		279	68
	68PDL96364LGM	5203		96	30	28.5		320	77
	68PDR96364LGM	5203		96	30	28.5		320	77

'P' Desk with Half Drum Base 	68PDL8430DB	4977		84	36	28.5		232	59
	68PDR8430DB*	4977		84	30	28.5		247	59
	68PDL8436DB	5010		84	30	28.5		279	68
	68PDR8436DB	5010		84	36	28.5		294	68
	68PDL9636DB	5382		96	36	28.5		320	77
	68PDR9636DB	5382		96	36	28.5		335	77

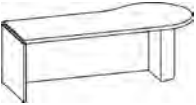
'P' Desk with Half Drum Base & Full Height Modesty Panel 	68PDL8430DBM	5105		84	36	28.5		247	59
	68PDR8430DBM*	5105		84	30	28.5		247	59
	68PDL8436DBM	5436		84	36	28.5		294	68
	68PDR8436DBM	5436		84	36	28.5		294	68
	68PDL9636DBM	5846		96	36	28.5		335	77
	68PDR9636DBM	5846		96	36	28.5		335	77

**ORDERING NOTES:**  
Please see page 256 for perforated metal modesty panel option.

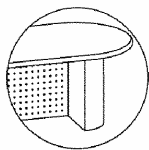

'Q' Desk with Wood Post Leg 	68QDL7130	4362		71	30	28.5	49.5	189	50
	68QDR7130*	4362		71	30	28.5	49.5	189	50
	68QDL8436	4643		84	36	28.5	59.75	232	68
	68QDR8436	4643		84	36	28.5	59.75	232	68

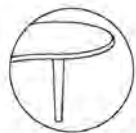

**ORDERING NOTES:**  
Please see page 256 for brushed aluminum tapered post leg option.

**DIMENSION KEY**

W - width  
D - depth  
H - height

**CODE DESCRIPTION**

4 - full height modesty panel  
DB - half drum base  
LGM - wood base and modesty panel  
DBM - half drum base and modesty panel

**STANDARD FINISHES**

For a complete list of standard wood finishes please see page 247.

**RETURN OPTIONS**

Curved corner bullet desks, "Q" desks, and "K" desks, accept 24" deep run-off units, returns and linking units.

# MILLENNIUM | CURVILINEAR DESKS

Description	Model	Cherry		W	D	H	KW	Shipping Weight	Cubic Feet
		Walnut	Maple						
'Q' Desk with 3/4 Modesty Panel & Wood Post Leg	68QDL71303LGM	4752		71	30	28.5		204	50
	68QDR71303LGM*	4752		71	30	28.5		204	50
	68QDL84363LGM	4904		84	36	28.5		274	68
	68QDR84363LGM	4904		84	36	28.5		274	68

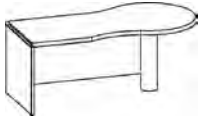

**ORDERING NOTES:**

All curvilinear posts are 6" in diameter. Laminate worksurfaces are available at a 10% upcharge.

'Q' Desk with Full Height Modesty Panel & Wood Post Leg	68QDL71304LGM	4826		71	30	28.5		269	50
	68QDR71304LGM*	4826		71	30	28.5		269	50
	68QDL84364LGM	5027		84	36	28.5		279	68
	68QDR84364LGM	5027		84	36	28.5		279	68

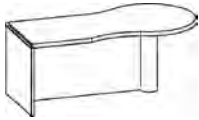

**ORDERING NOTES:**

All curvilinear posts are 6" in diameter. Laminate worksurfaces are available at a 10% upcharge.

'Q' Desk with Half Drum Base	68QDL8436DB	5010		84	36	28.5	49.5	279	68
	68QDR8436DB*	5010		84	36	28.5	49.5	279	68
	68QDL9636DB	5389		96	36	28.5	59.75	320	68
	68QDR9636DB	5389		96	36	28.5	59.75	320	68

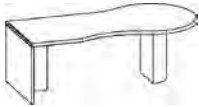

**ORDERING NOTES:**

Laminate worksurfaces are available at a 10% upcharge.

'Q' Desk with Half Drum Base & Full Height Modesty Panel	68QDL8436DBM	5436		84	36	28.5	46.5	294	68
	68QDR8436DBM*	5436		84	36	28.5	46.5	294	68
	68QDL9636DBM	5846		96	36	28.5	68	335	68
	68QDR9636DBM	5846		96	36	28.5	68	335	68

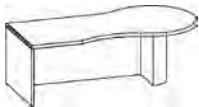

**ORDERING NOTES:**

Please see page 256 for perforated metal modesty panel option.



'K' Desk with Wood Post Leg	68KDL7130	4362		71	30	28.5	49.5	189	50
	68KDR7130*	4362		71	30	28.5	49.5	189	50
	68KDL8436	4643		84	36	28.5	59.75	232	68
	68KDR8436	4643		84	36	28.5	59.75	232	68

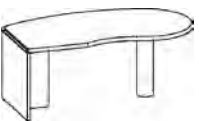

**ORDERING NOTES:**

Please see page 256 for brushed aluminum tapered post leg option.

**ORDERING PROCEDURE**

To order, please specify the following:

- 1) Krug product model number
- 2) Wood species and finish, see page 247
- 3) Wood edge detail- I,H, L or P, see page 250
- 4) Pull style, see page 250
- 5) Grommet location if applicable

\*Indicates model illustrated by line drawing.

**CODE DESCRIPTION**

- 3 - 3/4 height modesty panel
- 4 - full height modesty panel
- D - 2 file drawers, 1 file draw
- F - 2 box, 1 file drawer
- DB - half drum base
- LGM - wood base and modesty panel
- DBM - half drum base and modesty panel

**STANDARD FINISHES**

For a complete list of standard wood finishes please see page 247.

**GROMMETS**

One wiring grommet in standard position is optional at no charge. Additional wiring grommets are available at an **upcharge of \$152**. See page 251 for more power management information.

# MILLENNIUM | CURVILINEAR DESKS

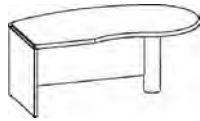
Description	Model	Cherry		W	D	H	KW	Shipping Weight	Cubic Feet
		Walnut	Maple						
 'K' Desk with 3/4 Modesty Panel & Wood Post Leg	68KDL71303LGM	4734		71	30	28.5	49.5	204	50
	68KDR71303LGM*	4734		71	30	28.5	49.5	204	50
	68KDL84363LGM	4904		84	36	28.5	59.75	274	68
	68KDR84363LGM	4904		84	36	28.5	59.75	274	68

 'K' Desk with Full Height Modesty Panel & Wood Post Leg	68KDL71304LGM	4838		71	30	28.5	49.5	209	50
	68KDR71304LGM*	4838		71	30	28.5	49.5	209	50
	68KDL84364LGM	5027		84	36	28.5	59.75	274	68
	68KDR84364LGM	5027		84	36	28.5	59.75	224	68

**ORDERING NOTES:**

Please see page 256 for perforated metal modesty panel option. Laminate worksurfaces are available at a 10% upcharge. Overhang on the 'K' desk is 23" from the modesty panel.

 'K' Desk with Half Drum Base	68KDL8436DB	5010		84	36	28.5	61.75	279	68
	68KDR8436DB*	5010		84	36	28.5	61.75	279	68
	68KDL9636DB	5389		96	36	28.5	68	320	68
	68KDR9636DB	5389		96	36	28.5	68	320	68

**ORDERING NOTES:**

Laminate worksurfaces are available at a 10% upcharge. Overhang on the 'K' desk is 23" from the modesty panel.

 'K' Desk with Half Drum Base & Full Height Modesty Panel	68KDL8436DBM	5427		84	36	28.5	61.75	294	68
	68KDR8436DBM*	5427		84	36	28.5	61.75	294	68
	68KDL9636DBM	5846		96	36	28.5	68	335	68
	68KDR9636DBM	5846		96	36	28.5	68	335	68

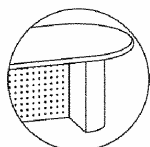

**ORDERING NOTES:**

Please see page 256 for perforated metal modesty panel option. Laminate worksurfaces are available at a 10% upcharge. Overhang on the 'K' desk is 23" from the modesty panel.

**DIMENSION KEY**

W - width  
D - depth  
H - height

**CODE DESCRIPTION**

3 - 3/4 height modesty panel  
4 - full height modesty panel  
DB - half drum base  
LGM - wood base and modesty panel  
DBM - half drum base and modesty panel

**STANDARD FINISHES**

For a complete list of standard wood finishes please see page 247.

**RETURN OPTIONS**

Curved corner bullet desks, "Q" desks, and "K" desks, except 24" deep run-off units, returns and linking units.

# MILLENNIUM | HEIGHT ADJUSTABLE DESK WORKSURFACES

Description	Model	Cherry	W	D	H	KW	Shipping Weight	Cubic Feet
		Walnut Maple						
Electronic Height Adjustable Worksurface	68HA3024ETS	3074	29.75	24	-	17	108.5	11.5
	68HA3624ETS	3103	35.75	24	-	23	109	14
	68HA4224ETS	3188	41.75	24	-	29	109	16.5
	68HA4824ETS	3271	47.75	24	-	35	109.5	19
	68HA5424ETS	3330	53.5	24	-	41	110	21.5
	68HA6024ETS	3408	59.75	24	-	47	111	24
	68HA6624ETS	3746	2719	24	-	53	114	26.5
	68HA7124ETS	3941	71.75	24	-	59	119.5	29
	68HA7824ETS	3962	77.75	24	-	65	122.5	31.5
	68HA8424ETS	4268	83.75	24	-	71	127	34
	68HA3030ETS	3972	29.75	30	-	17	121.5	36.75
	68HA3630ETS	3383	35.75	30	-	23	122	14.25
	68HA4230ETS	3448	41.75	30	-	29	122	17.5
	68HA4830ETS	3528	47.75	30	-	35	122.5	20.5
	68HA5430ETS	3627	53.5	30	-	41	123	23.5
	68HA6030ETS	3688	59.75	30	-	47	124	26.5
	68HA6630ETS	3896	65.75	30	-	53	131	29.75
	68HA7130ETS*	4095	71.75	30	-	59	132.5	32.75
	68HA7830ETS	4114	77.75	30	-	65	142.5	35.75
	68HA8430ETS	4347	83.75	30	-	71	143.5	38.75
	68HA3036ETS	4040	29.75	36	-	17	121.5	42
	68HA3636ETS	3454	35.75	36	-	23	122	45.5
	68HA4236ETS	3684	41.75	36	-	29	122	17.25
	68HA4836ETS	3754	47.75	36	-	35	122.5	20.75
	68HA5436ETS	3841	53.5	36	-	41	123	24.5
	68HA6036ETS	3924	59.75	36	-	47	124	28.25
	68HA6636ETS	4227	65.75	36	-	53	134	32
	68HA7136ETS	4245	71.75	36	-	59	151.5	35.5
	68HA7836ETS	4286	77.75	36	-	65	158.5	39.25
	68HA8436ETS	4732	83.75	36	-	71	159.5	43

**ORDERING NOTES:**

To order a height adjustable work surface with a top overhang of 16" at one end add O16 to the end of the model number. eg. 68HA6024ETSO16. Please note that this option is not available on height adjustable work surfaces that are 42" or less in length. This option is not available on dual stage electronic height adjustable worksurfaces. To order a dual stage height adjustable base **add \$674 to the list price** and replace ETS with ETD. eg. 68HA6030ETD.

Lifts come standard with an up/down button. Standard colors are Silver Metallic & Black, please contact customer service for other available colors. A 4 position programmable display is available, please see page 303 for price and model number. Standard base is a T-base. A C base can be specified at the same price. To order a C-base on worksurfaces, up to 30" deep only, replace "T" with "C" e.g. 68HA8430ECS

Single stage height adjustable range: 26" - 45.5"  
 Dual stage height adjustable range: 21" - 47"  
 Power cord is 10 feet long.

**ORDERING PROCEDURE**

To order, please specify the following:

- 1) Krug product model number
- 2) Wood species and finish, see page 26
- 3) Wood edge detail- I, H, L or P, see page 264
- 4) Pull style, see page 265
- 5) Grommet location if applicable

\*Indicates model illustrated by line drawing.

**CODE DESCRIPTION**

- HA - height adjustable
- E - electric
- T - T- base
- C - C- base
- S - single stage
- D - dual stage
- RH - return top with cross grain
- V21- half height floating wood modesty panel
- V26- half height floating laminate modesty panel

**STANDARD FINISHES**

For a complete list of standard wood finishes please see page 247.

**STORAGE SHELVES**

Storage units feature shelves that are adjustable in increments of approximately 1 1/4".

# MILLENNIUM | HEIGHT ADJUSTABLE DESK WORKSURFACES

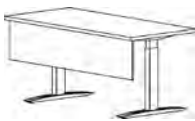
Description	Model	Cherry	W	D	H	KW	Shipping Weight	Cubic Feet
		Walnut Maple						
	68HA3024ETSV21	3399	29.75	24	-	17	114.5	11.5
	68HA3624ETSV21	3493	35.75	24	-	23	117	14
	68HA4224ETSV21	3643	41.75	24	-	29	118	16.5
	68HA4824ETSV21	3792	47.75	24	-	35	119.5	19
	68HA5424ETSV21	3917	53.5	24	-	41	122	21.5
	68HA6024ETSV21	4093	59.75	24	-	47	124	24
	68HA6624ETSV21	4437	65.75	24	-	53	128	26.5
	68HA7124ETSV21	4648	71.75	24	-	59	134.5	29
	68HA7824ETSV21	4681	77.75	24	-	65	139.5	31.5
	68HA8424ETSV21	5000	83.75	24	-	71	145	34
	68HA3030ETSV21	4295	29.75	30	-	17	127.5	36.75
	68HA3630ETSV21	3772	35.75	30	-	23	130	14.25
	68HA4230ETSV21	3902	41.75	30	-	29	131	17.5
	68HA4830ETSV21	4045	47.75	30	-	35	132.5	20.5
	68HA5430ETSV21	4184	53.5	30	-	41	135	23.5
	68HA6030ETSV21	4377	59.75	30	-	47	137	26.5
	68HA6630ETSV21	4587	65.75	30	-	53	145	29.75
	68HA7130ETSV21*	4799	71.75	30	-	59	147.5	32.75
	68HA7830ETSV21	4114	77.75	30	-	65	159.5	35.75
	68HA8430ETSV21	5064	83.75	30	-	71	161.5	38.75
	68HA3036ETSV21	4772	29.75	36	-	17	127.5	42
	68HA3636ETSV21	3780	35.75	36	-	23	130	45.5
	68HA4236ETSV21	4072	41.75	36	-	29	131	17.25
	68HA4836ETSV21	4222	47.75	36	-	35	132.5	20.75
	68HA5436ETSV21	4361	53.5	36	-	41	135	24.5
	68HA6036ETSV21	4611	59.75	36	-	47	137	28.25
	68HA6636ETSV21	4918	65.75	36	-	53	148	32
	68HA7136ETSV21	4951	71.75	36	-	59	166.5	35.5
68HA7836ETSV21	5013	77.75	36	-	65	175.5	39.25	
68HA8436ETSV21	5517	83.75	36	-	71	177.5	43	

**ORDERING NOTES:**

To order a height adjustable work surface with a top overhang of 16" at one end insert O16 into the model number after ETS. e.g. 68HA6024ETSO16V21. Please note that this option is not available on height adjustable work surfaces that are 42" or less in length. This option is not available on dual stage electronic height adjustable work surfaces.

To order a dual stage height adjustable base add **\$674 to the list price** and replace ETS with ETD. eg. 68HA6030ETDV21.

Lifts come standard with an up/down button. Standard colors are Silver Metallic & Black, please contact customer service for other available colors. A 4 position programmable display is available, please see page 303 for price and model number. Standard base is a T-base. A C base can be specified at the same price. To order a C-base on work surfaces, up to 30" deep only, replace "T" with "C" e.g. 68HA6630ECSV21

Modesty panels are available in low pressure laminate, please replace V21 with V26 for this option. Modesty panels are also available in palette, please replace V21 with V22 for this option.

Single stage height adjustable range: 26" - 45.5"

Dual stage height adjustable range: 21" - 47"

Power cord is 10 feet long.

**DIMENSION KEY**

W - width  
D - depth  
H - height

**CODE DESCRIPTION**

HA - height adjustable  
E - electric  
T - T- base  
C - C- base  
S - single stage  
D - dual stage  
RH - return top with cross grain  
V21- half height floating wood modesty panel  
V26- half height floating laminate modesty panel

**STANDARD FINISHES**

For a complete list of standard wood finishes please see page 247.

**GLASS DOORS**

All storage glass doors come standard with a vertical Massa pull. Other pull options are not available on glass doors.

# MILLENNIUM | HEIGHT ADJUSTABLE DESK WORKSURFACES

Description	Model	Cherry			W	D	H	KW	Shipping Weight	Cubic Feet
		Walnut	Maple							
Electronic Height Adjustable Work Surface with Base Enclosure	68HA4224ETSG	5103			41.75	24	-	24	154	16.5
	68HA4824ETSG	5185			47.75	24	-	30	154.5	19
	68HA5424ETSG	5243			53.5	24	-	36	155	21.5
	68HA6024ETSG	5319			59.75	24	-	42	156	24
	68HA6624ETSG	5660			65.75	24	-	48	159	26.5
	68HA7124ETSG	5856			71.75	24	-	54	164.5	29
	68HA7824ETSG	5874			77.75	24	-	60	167.5	31.5
	68HA8424ETSG	6182			83.75	24	-	66	172	34
	68HA4230ETSG	5586			41.75	30	-	24	177	17.5
	68HA4830ETSG	5664			47.75	30	-	30	177.5	20.5
	68HA5430ETSG	5739			53.5	30	-	36	178	23.5
	68HA6030ETSG	5828			59.75	30	-	42	179	26.5
	68HA6630ETSG	6035			65.75	30	-	42	186	29.75
	68HA7130ETSG*	6233			71.75	30	-	54	187.5	32.75
	68HA7830ETSG	6254			77.75	30	-	60	197.5	35.75
	68HA8430ETSG	6484			83.75	30	-	66	198.5	38.75
	68HA4236ETSG	6044			41.75	36	-	24	187	17.25
	68HA4836ETSG	6113			47.75	36	-	30	187.5	20.75
	68HA5436ETSG	6199			53.5	36	-	36	188	24.5
	68HA6036ETSG	6285			59.75	36	-	42	189	28.25
	68HA6636ETSG	6585			65.75	36	-	48	199	32
	68HA7136ETSG	6605			71.75	36	-	54	216.5	35.5
	68HA7836ETSG	6644			77.75	36	-	60	223.5	39.25
	68HA8436ETSG	7091			83.75	36	-	66	224.5	43



**ORDERING NOTES:**

To order a height adjustable work surface with a top overhang of 16" at one end insert O16 into the model number after ETS. eg. 68HA6024ETSO16G. Please note that this option is not available on height adjustable work surfaces that have base enclosures and are 54" or less in length. This option is not available on dual stage electronic height adjustable worksurfaces.

To order a dual stage height adjustable base **add \$674 to the list price** and replace ESTA with ETD. eg. 68HA6030ETDG.

Lifts come standard with an up/down button. Standard colors are Silver Metallic & Black, please contact customer service for other available colors. A 4 position programmable display is available, please see page 303 for price and model number.

Single stage height adjustable range: 26" - 45.5"  
 Dual stage height adjustable range: 21" - 47"  
 Power cord is 10 feet long.

**ORDERING PROCEDURE**

To order, please specify the following:

- 1) Krug product model number
- 2) Wood species and finish, see page 26
- 3) Wood edge detail- I,H, L or P, see page 264
- 4) Pull style, see page 265
- 5) Grommet location if applicable

\*Indicates model illustrated by line drawing.

**CODE DESCRIPTION**

- HA - height adjustable
- E - electric
- T - T- base
- C - C- base
- S - single stage
- D - dual stage
- RH - return top with cross grain
- V21- half height floating wood modesty panel
- V26- half height floating laminate modest panel

**STANDARD FINISHES**

For a complete list of standard wood finishes please see page 238.

# MILLENNIUM | HEIGHT ADJUSTABLE DESK WORKSURFACES

Description	Model	Cherry		W	D	H	KW	Shipping Weight	Cubic Feet
		Walnut	Maple						
Electronic Height Adjustable Work Surface with Base Enclosure and Floating Modesty Panel	68HA4224ETSGV21	5384		41.75	24	-	24	163	16.5
	68HA4824ETSGV21	5479		47.75	24	-	30	164.5	19
	68HA5424ETSGV21	5553		53.5	24	-	36	167	21.5
	68HA6024ETSGV21	5644		59.75	24	-	42	169	24
	68HA6624ETSGV21	6002		65.75	24	-	48	173	26.5
	68HA7124ETSGV21	6213		71.75	24	-	54	179.5	29
	68HA7824ETSGV21	6253		77.75	24	-	60	184.5	31.5
	68HA8424ETSGV21	6578		83.75	24	-	66	190	34
	68HA4230ETSGV21	5867		41.75	30	-	24	186	17.5
	68HA4830ETSGV21	5961		47.75	30	-	30	187.5	20.5
	68HA5430ETSGV21	6048		53.5	30	-	36	190	23.5
	68HA6030ETSGV21	6155		59.75	30	-	42	192	26.5
	68HA6630ETSGV21	6377		65.75	30	-	48	200	29.75
	68HA7130ETSGV21*	6594		71.75	30	-	54	202.5	32.75
	68HA7830ETSGV21	6630		77.75	30	-	60	214.5	35.75
	68HA8430ETSGV21	6862		83.75	30	-	66	216.5	38.75
	68HA4236ETSGV21	6323		41.75	36	-	24	196	17.25
	68HA4836ETSGV21	6394		47.75	36	-	30	197.5	20.75
	68HA5436ETSGV21	6495		53.5	36	-	36	200	24.5
	68HA6036ETSGV21	6595		59.75	36	-	42	202	28.25
	68HA6636ETSGV21	6912		65.75	36	-	48	213	32
	68HA7136ETSGV21	6945		71.75	36	-	54	231.5	35.5
	68HA7836ETSGV21	7020		77.75	36	-	60	240.5	39.25
	68HA8436ETSGV21	7294		83.75	36	-	66	242.5	43



**ORDERING NOTES:**

To order a height adjustable work surface with a top overhang of 16" at one end insert O16 into the model number after ETS. eg. 68HA6024ETSO16GV21. Please note that this option is not available on height adjustable work surfaces that have base enclosures and are 54" or less in length. This option is not available on dual stage electronic height adjustable worksurfaces.

To order a dual stage height adjustable base **add \$674 to the list price** and replace ETS with ETD. eg. 68HA6030ETDGV21. Lifts come standard with an up/down button. Standard colors are Silver Metallic & Black, please contact customer service for other available colors. A 4 position programmable display is available, please see page 303 for price and model number.

Modesty panels are available in low pressure laminate, please replace V21 with V26 for this option. Modesty panels are also available in palette, please replace V21 with V22 for this option.

Single stage height adjustable range: 26" - 45.5"

Dual stage height adjustable range: 21" - 47"

Power cord is 10 feet long.

**DIMENSION KEY**

W - width  
D - depth  
H - height

**CODE DESCRIPTION**

HA - height adjustable  
E - electric  
T - T- base  
C - C- base  
S - single stage  
D - dual stage  
RH - return top with cross grain  
V21- half height floating wood modesty panel  
V26- half height floating laminate modest panel

**STANDARD FINISHES**

For a complete list of standard wood finishes please see page 238.



# MILLENNIUM | HEIGHT ADJUSTABLE RETURN WORKSURFACES

Description	Model	Cherry Walnut Maple	W	D	H	KW	Shipping Weight	Cubic Feet	
	Electronic Height Adjustable Return Worksurface	68HA4824RHETS	3271	47.75	24	-	35	109.5	19
		68HA5424RHETS	3330	53.5	24	-	41	110	21.5
		68HA6024RHETS	3408	59.75	24	-	47	111	24
		68HA6624RHETS	3746	2719	24	-	53	114	26.5
		68HA7124RHETS	3941	71.75	24	-	59	119.5	29
		68HA7824RHETS	3962	77.75	24	-	65	122.5	31.5
		68HA8424RHETS	4268	83.75	24	-	71	127	34
		68HA4830RHETS	3528	47.75	30	-	35	122.5	20.5
		68HA5430RHETS	3627	53.5	30	-	41	123	23.5
		68HA6030RHETS	3688	59.75	30	-	47	124	26.5
	68HA6630RHETS	3896	65.75	30	-	53	131	29.75	
	68HA7130RHETS*	4095	71.75	30	-	59	132.5	32.75	
	68HA7830RHETS	4114	77.75	30	-	65	142.5	35.75	
	68HA8430RHETS	4347	83.75	30	-	71	143.5	38.75	
	68HA4836RHETS	3754	47.75	36	-	35	122.5	20.75	
	68HA5436RHETS	3841	53.5	36	-	41	123	24.5	
	68HA6036RHETS	3924	59.75	36	-	47	124	28.25	
	68HA6636RHETS	4227	65.75	36	-	53	134	32	
	68HA7136RHETS	4245	71.75	36	-	59	151.5	35.5	
	68HA7836RHETS	4286	77.75	36	-	65	158.5	39.25	
	68HA8436RHETS	4732	83.75	36	-	71	159.5	43	

**ORDERING NOTES:**

To order a height adjustable work surface with a top overhang of 16" at one end add O16 to the end of the model number. eg. 68HA6024ETSO16. Please note that this option is not available on height adjustable work surfaces that are 42" or less in length. This option is not available on dual stage electronic height adjustable worksurfaces. To order a dual stage height adjustable base **add \$674 to the list price** and replace ETS with ETD. eg. 68HA6030ETD.

Lifts come standard with an up/down button. Standard colors are Silver Metallic & Black, please contact customer service for other available colors. A 4 position programmable display is available, please see page 303 for price and model number. . Standard base is a T-base. A C base can be specified at the same price. To order a C-base on worksurfaces, up to 30" deep only, replace "T" with "C" e.g. 68HA8430ECS

Single stage height adjustable range: 26" - 45.5"  
 Dual stage height adjustable range: 21" - 47"  
 Power cord is 10 feet long.

**ORDERING PROCEDURE**

To order, please specify the following:

- 1) Krug product model number
- 2) Wood species and finish, see page 247
- 3) Wood edge detail- I,H, L or P, see page 250
- 4) Pull style, see page 250
- 5) Grommet location if applicable

\*Indicates model illustrated by line drawing.

**CODE DESCRIPTION**

- HA - height adjustable
- RH - return (cross grain)
- E - electric
- T - T- base
- C - C- base
- S - single stage
- D - dual stage

**STANDARD FINISHES**

For a complete list of standard wood finishes please see page 247.

**STORAGE SHELVES**

Storage units feature shelves that are adjustable in increments of approximately 1 1/4".

# MILLENNIUM | HEIGHT ADJUSTABLE RETURN WORKSURFACES

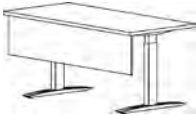
Description	Model	Cherry	W	D	H	KW	Shipping Weight	Cubic Feet	
		Walnut Maple							
	Electronic Height Adjustable Return	68HA4824RHETSV21	3792	47.75	24	-	35	119.5	19
	Worksurface with Wood Modesty Panel	68HA5424RHETSV21	3917	53.5	24	-	41	122	21.5
		68HA6024RHETSV21	4093	59.75	24	-	47	124	24
		68HA6624RHETSV21	4437	65.75	24	-	53	128	26.5
		68HA7124RHETSV21	4648	71.75	24	-	59	134.5	29
		68HA7824RHETSV21	4681	77.75	24	-	65	139.5	31.5
		68HA8424RHETSV21	5000	83.75	24	-	71	145	34
		68HA4830RHETSV21	4045	47.75	30	-	35	132.5	20.5
		68HA5430RHETSV21	4184	53.5	30	-	41	135	23.5
		68HA6030RHETSV21	4377	59.75	30	-	47	137	26.5
	68HA6630RHETSV21	4587	65.75	30	-	53	145	29.75	
	68HA7130RHETSV21*	4799	71.75	30	-	59	147.5	32.75	
	68HA7830RHETSV21	4114	77.75	30	-	65	159.5	35.75	
	68HA8430RHETSV21	5064	83.75	30	-	71	161.5	38.75	
	68HA4836RHETSV21	4222	47.75	36	-	35	132.5	20.75	
	68HA5436RHETSV21	4361	53.5	36	-	41	135	24.5	
	68HA6036RHETSV21	4611	59.75	36	-	47	137	28.25	
	68HA6636RHETSV21	4918	65.75	36	-	53	148	32	
	68HA7136RHETSV21	4951	71.75	36	-	59	166.5	35.5	
	68HA7836RHETSV21	5013	77.75	36	-	65	175.5	39.25	
	68HA8436RHETSV21	5517	83.75	36	-	71	177.5	43	

**ORDERING NOTES:**

To order a height adjustable work surface with a top overhang of 16" at one end insert O16 into the model number after ETS. eg. 68HA6024ETSO16V21. Please note that this option is not available on height adjustable work surfaces that are 42" or less in length. This option is not available on dual stage electronic height adjustable worksurfaces.

To order a dual stage height adjustable base **add \$674 to the list price** and replace ETS with ETD. eg. 68HA6030ETDV21. .

Lifts come standard with an up/down button. Standard colors are Silver Metallic & Black, please contact customer service for other available colors. A 4 position programmable display is available, please see page 303 for price and model number. Standard base is a T-base. A C base can be specified at the same price. To order a C-base on worksurfaces, up to 30" deep only, replace "T" with "C" e.g. 68HA6630ECSV21

Modesty panels are available in low pressure laminate, please replace V21 with V26 for this option. e.g. 68HA6030ETSV26.

Please see page 373 for Low-Pressure Laminate options.

Single stage height adjustable range: 26" - 45.5"

Dual stage height adjustable range: 21" - 47"

Power cord is 10 feet long.

**DIMENSION KEY**

W - width  
D - depth  
H - height

**CODE DESCRIPTION**

HA - height adjustable  
RH - return (cross grain)  
E - electric  
T - T- base  
C - C- base  
S - single stage  
D - dual stage  
V21 - 1/2 height floating wood modesty panel

**STANDARD FINISHES**

For a complete list of standard wood finishes please see page 247.

**GLASS DOORS**

All storage glass doors come standard with a vertical Massa pull. Other pull options are not available on glass doors.

# MILLENNIUM | HEIGHT ADJUSTABLE RETURN WORKSURFACES

Description	Model	Cherry		W	D	H	KW	Shipping Weight	Cubic Feet
		Walnut	Maple						
	68HA4824RHETSG	5185		47.75	24	-	30	154.5	19
	68HA5424RHETSG	5243		53.5	24	-	36	155	21.5
	68HA6024RHETSG	5319		59.75	24	-	42	156	24
	68HA6624RHETSG	5660		65.75	24	-	48	159	26.5
	68HA7124RHETSG	5856		71.75	24	-	54	164.5	29
	68HA7824RHETSG	5874		77.75	24	-	60	167.5	31.5
	68HA8424RHETSG	6182		83.75	24	-	66	172	34
	68HA4830RHETSG	5664		47.75	30	-	30	177.5	20.5
	68HA5430RHETSG	5739		53.5	30	-	36	178	23.5
	68HA6030RHETSG	5828		59.75	30	-	42	179	26.5
	68HA6630RHETSG	6035		65.75	30	-	42	186	29.75
	68HA7130RHETSG*	6233		71.75	30	-	54	187.5	32.75
	68HA7830RHETSG	6254		77.75	30	-	60	197.5	35.75
	68HA8430RHETSG	6484		83.75	30	-	66	198.5	38.75
	68HA4836RHETSG	6113		47.75	36	-	30	187.5	20.75
	68HA5436RHETSG	6199		53.5	36	-	36	188	24.5
	68HA6036RHETSG	6285		59.75	36	-	42	189	28.25
	68HA6636RHETSG	6585		65.75	36	-	48	199	32
68HA7136RHETSG	6605		71.75	36	-	54	216.5	35.5	
68HA7836RHETSG	6644		77.75	36	-	60	223.5	39.25	
68HA8436RHETSG	7091		83.75	36	-	66	224.5	43	

**ORDERING NOTES:**

To order a height adjustable work surface with a top overhang of 16" at one end insert O16 into the model number after ETS. e.g. 68HA6024ETSO16G. Please note that this option is not available on height adjustable work surfaces that have base enclosures and are 54" or less in length. This option is not available on dual stage electronic height adjustable worksurfaces.

To order a dual stage height adjustable base **add \$674 to the list price** and replace ESTA with ETD. eg. 68HA6030ETDG. .

Lifts come standard with an up/down button. Standard colors are Silver Metallic & Black, please contact customer service for other available colors. A 4 position programmable display is available, please see page 303 for price and model number.

Single stage height adjustable range: 26" - 45.5"

Dual stage height adjustable range: 21" - 47"

Power cord is 10 feet long.

**ORDERING PROCEDURE**

To order, please specify the following:

- 1) Krug product model number
- 2) Wood species and finish, see page 247
- 3) Wood edge detail- I,H, L or P, see page 250
- 4) Pull style, see page 250
- 5) Grommet location if applicable

\*Indicates model illustrated by line drawing.

**CODE DESCRIPTION**

- HA - height adjustable
- RH - return (cross grain)
- E - electric
- T - T- base
- C - C- base
- S - single stage
- D - dual stage

**STANDARD FINISHES**

For a complete list of standard wood finishes please see page 247.

# MILLENNIUM | HEIGHT ADJUSTABLE RETURN WORKSURFACES

Description	Model	Cherry		W	D	H	KW	Shipping Weight	Cubic Feet
		Walnut	Maple						
Electronic Height Adjustable Return Worksurface with Base Enclosure and Floating Modesty Panel	68HA4824RHETSGV21	5479		47.75	24	-	30	164.5	19
	68HA5424RHETSGV21	5553		53.5	24	-	36	167	21.5
	68HA6024RHETSGV21	5644		59.75	24	-	42	169	24
	68HA6624RHETSGV21	6002		65.75	24	-	48	173	26.5
	68HA7124RHETSGV21	6213		71.75	24	-	54	179.5	29
	68HA7824RHETSGV21	6253		77.75	24	-	60	184.5	31.5
	68HA8424RHETSGV21	6578		83.75	24	-	66	190	34
	68HA4830RHETSGV21	5961		47.75	30	-	30	187.5	20.5
	68HA5430RHETSGV21	6048		53.5	30	-	36	190	23.5
	68HA6030RHETSGV21	6155		59.75	30	-	42	192	26.5
	68HA6630RHETSGV21	6377		65.75	30	-	48	200	29.75
	68HA7130RHETSGV21*	6594		71.75	30	-	54	202.5	32.75
	68HA7830RHETSGV21	6630		77.75	30	-	60	214.5	35.75
	68HA8430RHETSGV21	6862		83.75	30	-	66	216.5	38.75
	68HA4836RHETSGV21	6394		47.75	36	-	30	197.5	20.75
	68HA5436RHETSGV21	6495		53.5	36	-	36	200	24.5
	68HA6036RHETSGV21	6595		59.75	36	-	42	202	28.25
68HA6636RHETSGV21	6912		65.75	36	-	48	213	32	
68HA7136RHETSGV21	6945		71.75	36	-	54	231.5	35.5	
68HA7836RHETSGV21	7020		77.75	36	-	60	240.5	39.25	
68HA8436RHETSGV21	7294		83.75	36	-	66	242.5	43	

**ORDERING NOTES:**

To order a height adjustable work surface with a top overhang of 16" at one end insert O16 into the model number after ETS. eg. 68HA6024ETSO16GV21. Please note that this option is not available on height adjustable work surfaces that have base enclosures and are 54" or less in length. This option is not available on dual stage electronic height adjustable worksurfaces.

To order a dual stage height adjustable base **add \$674 to the list price** and replace ETS with ETD. eg. 68HA6030ETDGV21. Lifts come standard with an up/down button. Standard colors are Silver Metallic & Black, please contact customer service for other available colors. A 4 position programmable display is available, please see page 303 for price and model number.

Modesty panels are available in low pressure laminate, please replace V21 with V26 for this option. e.g. 68HA6030ETSGV26.

Please see page 373 for Low-Pressure Laminate options.

Modesty panels are also available in palette, please replace V21 with V22 for this option. e.g. 68HA6030ETSGV22..

Single stage height adjustable range: 26" - 45.5"

Dual stage height adjustable range: 21" - 47"

Power cord is 10 feet long.

**DIMENSION KEY**

W - width  
D - depth  
H - height

**CODE DESCRIPTION**

HA - height adjustable  
RH - return (cross grain)  
E - electric  
T - T- base  
C - C- base  
S - single stage  
D - dual stage  
V21 - 1/2 height floating wood modesty panel

**STANDARD FINISHES**

For a complete list of standard wood finishes please see page 247.

# MILLENNIUM | RETURNS

Description	Model	Cherry Walnut Maple	W	D	H	KW	Shipping Weight	Cubic Feet
Return, Desk Height with Full Height Pedestal	68RH3620L4D	3698	36	20.25	28.5	19.5	101	15
	68RH3620L4F	3698	36	20.25	28.5	19.5	101	15
	68RH3620R4D	3698	36	20.25	28.5	19.5	101	15
	68RH3620R4F	3698	36	20.25	28.5	19.5	101	15
	68RH3624L4D	3732	36	24.25	28.5	19.5	115	18
	68RH3624L4F	3732	36	24.25	28.5	19.5	115	18
	68RH3624R4D	3732	36	24.25	28.5	19.5	115	18
	68RH3624R4F	3732	36	24.25	28.5	19.5	115	18
	68RH3630L4D	3762	36	30.25	28.5	19.5	136	21
	68RH3630L4F	3762	36	30.25	28.5	19.5	136	21
	68RH3630R4D	3762	36	30.25	28.5	19.5	136	21
	68RH3630R4F	3762	36	30.25	28.5	19.5	136	21
	68RH4220L4D	3761	42	20.25	28.5	25.5	113	17
	68RH4220L4F	3761	42	20.25	28.5	25.5	113	17
	68RH4220R4D	3761	42	20.25	28.5	25.5	113	17
	68RH4220R4F	3761	42	20.25	28.5	25.5	113	17
	68RH4224L4D	3819	42	24.25	28.5	25.5	129	20
	68RH4224L4F*	3819	42	24.25	28.5	25.5	129	20
	68RH4224R4D	3819	42	24.25	28.5	25.5	129	20
	68RH4224R4F	3819	42	24.25	28.5	25.5	129	20
	68RH4230L4D	3840	42	30.25	28.5	25.5	154	25
	68RH4230L4F	3840	42	30.25	28.5	25.5	154	25
	68RH4230R4D	3840	42	30.25	28.5	25.5	154	25
	68RH4230R4F	3840	42	30.25	28.5	25.5	154	25
	68RH4820L4D	3866	48	20.25	28.5	31.5	125	20
	68RH4820L4F	3866	48	20.25	28.5	31.5	125	20
	68RH4820R4D	3866	48	20.25	28.5	31.5	125	20
	68RH4820R4F	3866	48	20.25	28.5	31.5	125	20
	68RH4824L4D	3867	48	24.25	28.5	31.5	144	23
	68RH4824L4F	3867	48	24.25	28.5	31.5	144	23
	68RH4824R4D	3867	48	24.25	28.5	31.5	144	23
	68RH4824R4F	3867	48	24.25	28.5	31.5	144	23
	68RH4830L4D	3888	48	30.25	28.5	31.5	172	29
	68RH4830L4F	3888	48	30.25	28.5	31.5	172	29
	68RH4830R4D	3888	48	30.25	28.5	31.5	172	29
	68RH4830R4F	3888	48	30.25	28.5	31.5	172	29
	68RH5420L4D	3898	54	20.25	28.5	37.5	137	22
	68RH5420L4F	3898	54	20.25	28.5	37.5	137	22
	68RH5420R4D	3898	54	20.25	28.5	37.5	137	22
	68RH5420R4F	3898	54	20.25	28.5	37.5	137	22
	68RH5424L4D	3931	54	24.25	28.5	37.5	158	15
	68RH5424L4F	3931	54	24.25	28.5	37.5	158	15
	68RH5424R4D	3931	54	24.25	28.5	37.5	158	15
	68RH5424R4F	3931	54	24.25	28.5	37.5	158	15
	68RH5430L4D	3985	54	30.25	28.5	37.5	190	18
	68RH5430L4F	3985	54	30.25	28.5	37.5	190	18
	68RH5430R4D	3985	54	30.25	28.5	37.5	190	18
	68RH5430R4F	3985	54	30.25	28.5	37.5	190	18

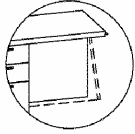

**ORDERING NOTES:**

Please see page 256 for wire management cut-out option and for hinged modesty panel option. Laminate worksurfaces are available at a 10% upcharge. For reverse grain direction on returns use list price and note Reverse Grain on p.o.

**ORDERING PROCEDURE**

To order, please specify the following:

- 1) Krug product model number
- 2) Wood species and finish, see page 247
- 3) Wood edge detail- I,H, L or P, see page 250
- 4) Pull style, see page 250
- 5) Grommet location if applicable

\*Indicates model illustrated by line drawing.

**CODE DESCRIPTION**

- 4 - full height pedestal
- L - left handed pedestal position
- R - right handed pedestal position
- D - 2 file drawer
- F - 2 box, 1 file drawer

**STANDARD FINISHES**

For a complete list of standard wood finishes please see page 247.

**GROMMETS**

One wiring grommet in standard position is optional at no charge. Additional wiring grommets are available at **an upcharge of \$152.**

MILLENNIUM | RETURNS

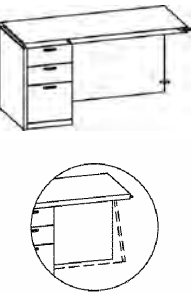
Description	Model	Cherry		W	D	H	KW	Shipping Weight	Cubic Feet
		Walnut	Maple						
Return, Desk Height with Full Height Pedestal 	68RH6020L4D	4044		60	20.25	28.5	43.5	147	17
	68RH6020L4F	4044		60	20.25	28.5	43.5	147	17
	68RH6020R4D	4044		60	20.25	28.5	43.5	147	17
	68RH6020R4F	4044		60	20.25	28.5	43.5	147	17
	68RH6024L4D	4107		60	24.25	28.5	43.5	170	20
	68RH6024L4F	4107		60	24.25	28.5	43.5	170	20
	68RH6024R4D	4107		60	24.25	28.5	43.5	170	20
	68RH6024R4F	4107		60	24.25	28.5	43.5	170	20
	68RH6030L4D	4217		60	30.25	28.5	43.5	205	20
	68RH6030L4F*	4217		60	30.25	28.5	43.5	205	20
	68RH6030R4D	4217		60	30.25	28.5	43.5	205	20
	68RH6030R4F	4217		60	30.25	28.5	43.5	205	20
	68RH6620L4D	4306		65.75	20.25	28.5	49.25	159	23
	68RH6620L4F	4306		65.75	20.25	28.5	49.25	159	23
	68RH6620R4D	4306		65.75	20.25	28.5	49.25	159	23
	68RH6620R4F	4306		65.75	20.25	28.5	49.25	159	23
	68RH6624L4D	4365		65.75	24.25	28.5	49.25	184	22
	68RH6624L4F	4365		65.75	24.25	28.5	49.25	184	22
	68RH6624R4D	4365		65.75	24.25	28.5	49.25	184	22
	68RH6624R4F	4365		65.75	24.25	28.5	49.25	184	22
	68RH6630L4D	4416		65.75	30.25	28.5	49.25	223	26
	68RH6630L4F	4416		65.75	30.25	28.5	49.25	223	26
	68RH6630R4D	4416		65.75	30.25	28.5	49.25	223	26
	68RH6630R4F	4416		65.75	30.25	28.5	49.25	223	26
	68RH7124L4D	4498		71	24.25	28.5	54.5	227	34
	68RH7124L4F	4498		71	24.25	28.5	54.5	227	34
	68RH7124R4D	4498		71	24.25	28.5	54.5	227	34
	68RH7124R4F	4498		71	24.25	28.5	54.5	227	34
	68RH7130L4D	4534		71	30.25	28.5	54.5	268	42
	68RH7130L4F	4534		71	30.25	28.5	54.5	268	42
68RH7130R4D	4534		71	30.25	28.5	54.5	268	42	
68RH7130R4F	4534		71	30.25	28.5	54.5	268	42	
68RH8424L4D	4611		83.75	24.25	28.5	67.5	227	34	
68RH8424L4F	4611		83.75	24.25	28.5	67.5	227	34	
68RH8424R4D	4611		83.75	24.25	28.5	67.5	227	34	
68RH8424R4F	4611		83.75	24.25	28.5	67.5	227	34	
68RH8430L4D	4655		83.75	30.25	28.5	67.5	260	50	
68RH8430L4F	4655		83.75	30.25	28.5	67.5	260	50	
68RH8430R4D	4655		83.75	30.25	28.5	67.5	260	50	
68RH8430R4F	4655		83.75	30.25	28.5	67.5	260	50	

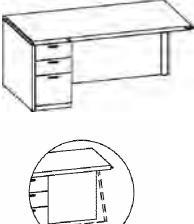
Return, Desk Height & Depth with Full Height Pedestal 	68RD6636L4D	4678		65.75	36.25	28.5	48.75	255	42
	68RD6636L4F*	4678		65.75	36.25	28.5	48.75	255	42
	68RD6636R4D	4678		65.75	36.25	28.5	48.75	255	42
	68RD6636R4F	4678		65.75	36.25	28.5	48.75	255	42
	68RD7136L4D	4778		71	36.25	28.5	54.5	252	50
	68RD7136L4F	4778		71	36.25	28.5	54.5	252	50
	68RD7136R4D	4778		71	36.25	28.5	54.5	252	50
	68RD7136R4F	4778		71	36.25	28.5	54.5	252	50
	68RD8436L4D	4970		83.75	36.25	28.5	67.5	270	60
	68RD8436L4F	4970		83.75	36.25	28.5	67.5	270	60
	68RD8436R4D	4970		83.75	36.25	28.5	67.5	270	60
	68RD8436R4F	4970		83.75	36.25	28.5	67.5	270	60

**ORDERING NOTES:** For reverse grain direction on returns use list price and note Reverse Grain on p.o.

**DIMENSION KEY**

W - width  
D - depth  
H - height

**CODE DESCRIPTION**

4 - full height pedestal  
L - left handed pedestal position  
R - right handed pedestal position  
D - 2 file drawer  
F - 2 box, 1 file drawer



**STANDARD FINISHES**

For a complete list of standard wood finishes please see page 247.

**OPEN/DESK RETURNS**

Open returns can be found in the shell section on page 298. Desk depth returns have a recessed modesty panel.

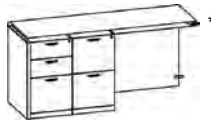
# MILLENNIUM | RETURNS

Description	Model	Cherry		W	D	H	KW	Shipping Weight	Cubic Feet
		Walnut	Maple						
Return, Full Height	68RH6020L4DD**	5187		60	20.25	28.5	28.5	179	25
Ganged Pedestals	68RH6020L4DF*	5187		60	20.25	28.5	28.5	179	25
	68RH6020L4FD	5187		60	20.25	28.5	28.5	179	25
	68RH6020L4FF	5187		60	20.25	28.5	28.5	179	25
	68RH6020R4DD	5187		60	20.25	28.5	28.5	179	25
	68RH6020R4DF	5187		60	20.25	28.5	28.5	179	25
	68RH6020R4FD	5187		60	20.25	28.5	28.5	179	25
	68RH6020R4FF	5187		60	20.25	28.5	28.5	179	25
	68RH6024L4DD	5219		60	24.25	28.5	28.5	202	29
	68RH6024L4DF	5219		60	24.25	28.5	28.5	202	29
	68RH6024L4FD	5219		60	24.25	28.5	28.5	202	29
	68RH6024L4FF	5219		60	24.25	28.5	28.5	202	29
	68RH6024R4DD	5219		60	24.25	28.5	28.5	202	29
	68RH6024R4DF	5219		60	24.25	28.5	28.5	202	29
	68RH6024R4FD	5219		60	24.25	28.5	28.5	202	29
	68RH6024R4FF	5219		60	24.25	28.5	28.5	202	29
	68RH6030L4DD	5240		60	30.25	28.5	28.5	237	36
	68RH6030L4DF	5240		60	30.25	28.5	28.5	237	36
	68RH6030L4FD	5240		60	30.25	28.5	28.5	237	36
	68RH6030L4FF	5240		60	30.25	28.5	28.5	237	36
	68RH6030R4DD	5240		60	30.25	28.5	28.5	237	36
	68RH6030R4DF	5240		60	30.25	28.5	28.5	237	36
	68RH6030R4FD	5240		60	30.25	28.5	28.5	237	36
	68RH6030R4FF	5240		60	30.25	28.5	28.5	237	36
	68RH6620L4DD	5260		65.75	20.25	28.5	34.25	191	27
	68RH6620L4DF	5260		65.75	20.25	28.5	34.25	191	27
	68RH6620L4FD*	5260		65.75	20.25	28.5	34.25	191	27
	68RH6620L4FF	5260		65.75	20.25	28.5	34.25	191	27
	68RH6620R4DD	5260		65.75	20.25	28.5	34.25	191	27
	68RH6620R4DF	5260		65.75	20.25	28.5	34.25	191	27
	68RH6620R4FD	5260		65.75	20.25	28.5	34.25	191	27
	68RH6620R4FF	5260		65.75	20.25	28.5	34.25	191	27
	68RH6624L4DD	5300		65.75	24.25	28.5	34.25	216	32
	68RH6624L4DF	5300		65.75	24.25	28.5	34.25	216	32
	68RH6624L4FD	5300		65.75	24.25	28.5	34.25	216	32
	68RH6624L4FF	5300		65.75	24.25	28.5	34.25	216	32
	68RH6624R4DD	5300		65.75	24.25	28.5	34.25	216	32
	68RH6624R4DF	5300		65.75	24.25	28.5	34.25	216	32
	68RH6624R4FD	5300		65.75	24.25	28.5	34.25	216	32
	68RH6624R4FF	5300		65.75	24.25	28.5	34.25	216	32
	68RH6630L4DD	5319		65.75	30.25	28.5	34.25	255	39
	68RH6630L4DF	5319		65.75	30.25	28.5	34.25	255	39
	68RH6630L4FD	5319		65.75	30.25	28.5	34.25	255	39
	68RH6630L4FF	5319		65.75	30.25	28.5	34.25	255	39
	68RH6630R4DD	5319		65.75	30.25	28.5	34.25	255	39
	68RH6630R4DF	5319		65.75	30.25	28.5	34.25	255	39
	68RH6630R4FD	5319		65.75	30.25	28.5	34.25	255	39
	68RH6630R4FF	5319		65.75	30.25	28.5	34.25	255	39
	68RH7124L4DD	5365		71	24.25	28.5	39.5	227	34
	68RH7124L4DF	5365		71	24.25	28.5	39.5	227	34

**ORDERING NOTES:**

Please see page 256 for wire management cut-out option and for hinged modesty panel option. Laminate work-surfaces are available at a 10% upcharge.

**ORDERING PROCEDURE**

To order, please specify the following:

- 1) Krug product model number
- 2) Wood species and finish, see page 247
- 3) Wood edge detail- I,H, L or P, see page 250
- 4) Pull style, see page 250
- 5) Grommet location if applicable

\*Indicates model illustrated by line drawing.

**CODE DESCRIPTION**

- 4 - full height pedestal
- L - left handed pedestal position
- R - right handed pedestal position
- D - 2 file drawer
- F - 2 box, 1 file drawer

**STANDARD FINISHES**

For a complete list of standard wood finishes please see page 247.

**GROMMETS**

One wiring grommet in standard position is optional at no charge. Additional wiring grommets are available at an **upcharge of \$152.**

MILLENNIUM | RETURNS

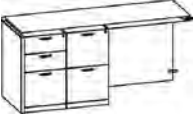
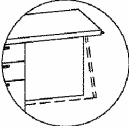
Description	Model	Cherry		W	D	H	KW	Shipping Weight	Cubic Feet
		Walnut	Maple						
Return, Full Height Ganged Pedestals Continued	68RH7124L4FD	5365		71	24.25	28.5	39.5	227	34
	68RH7124L4FF	5365		71	24.25	28.5	39.5	227	34
 	68RH7124R4DD	5365		71	24.25	28.5	39.5	227	34
	68RH7124R4DF	5365		71	24.25	28.5	39.5	227	34
	68RH7124R4FD	5365		71	24.25	28.5	39.5	227	34
	68RH7124R4FF	5365		71	24.25	28.5	39.5	227	34
	68RH7130L4DD	5430		71	30.25	28.5	39.5	268	42
	68RH7130L4DF	5430		71	30.25	28.5	39.5	268	42
	68RH7130L4FD	5430		71	30.25	28.5	39.5	268	42
	68RH7130L4FF	5430		71	30.25	28.5	39.5	268	42
	68RH7130R4DD	5430		71	30.25	28.5	39.5	268	42
	68RH7130R4DF	5430		71	30.25	28.5	39.5	268	42
	68RH7130R4FD*	5430		71	30.25	28.5	39.5	268	42
	68RH7130R4FF	5430		71	30.25	28.5	39.5	268	42
	68RH8424L4DD	5525		83.75	24.25	28.5	52.5	260	40
	68RH8424L4DF	5525		83.75	24.25	28.5	52.5	260	40
	68RH8424L4FD	5525		83.75	24.25	28.5	52.5	260	40
	68RH8424L4FF	5525		83.75	24.25	28.5	52.5	260	40
	68RH8424R4DD	5525		83.75	24.25	28.5	52.5	260	40
	68RH8424R4DF	5525		83.75	24.25	28.5	52.5	260	40
	68RH8424R4FD	5525		83.75	24.25	28.5	52.5	260	40
	68RH8424R4FF	5525		83.75	24.25	28.5	52.5	260	40
	68RH8430L4DD	5574		83.75	30.25	28.5	52.5	309	50
	68RH8430L4DF	5574		83.75	30.25	28.5	52.5	309	50
	68RH8430L4FD	5574		83.75	30.25	28.5	52.5	309	50
	68RH8430L4FF	5574		83.75	30.25	28.5	52.5	309	50
	68RH8430R4DD	5574		83.75	30.25	28.5	52.5	309	50
	68RH8430R4DF	5574		83.75	30.25	28.5	52.5	309	50
	68RH8430R4FD	5574		83.75	30.25	28.5	52.5	309	50
	68RH8430R4FF	5574		83.75	30.25	28.5	52.5	309	50

Return, Lateral File Pedestal	68RH6024LLF*	4966		60	24.25	28.5	24	218	29
	68RH6024RLF	4966		60	24.25	28.5	24	218	29
	68RH7124LLF	5010		71	24.25	28.5	35	243	34
	68RH7124RLF	5010		71	24.25	28.5	35	243	34
	68RH8424LLF	5075		84	24.25	28.5	48	279	36
	68RH8424RLF	5075		84	24.25	28.5	48	279	36

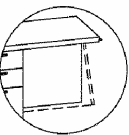
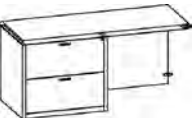

**ORDERING NOTES:**

Please see page 256 for wire management cut-out option and for hinged modesty panel option. Laminate work-surfaces are available at a 10% upcharge. For reverse grain direction on returns use list price and note Reverse Grain on p.o.

**DIMENSION KEY**

W - width  
D - depth  
H - height

**CODE DESCRIPTION**

4 - full height pedestal  
L - left handed pedestal position  
R - right handed pedestal position  
D - 2 file drawer  
F - 2 box, 1 file drawer

**STANDARD FINISHES**

For a complete list of standard wood finishes please see page 247.

**OPEN/DESK RETURNS**

Open returns can be found in the shell section on page 298. Desk depth returns have a recessed modesty panel.



# MILLENNIUM | RETURNS

Description	Model	Cherry		W	D	H	KW	Shipping Weight	Cubic Feet
		Walnut	Maple						
 Bullet Return with Post Leg	68BR6030*	2114		60	30.25	28.5		131	4
	68BR6630	2155		65.75	30.25	28.5		149	4
	68BR6636	2168		65.75	36.25	28.5		189	5
	68BR7130	2217		71	30.25	28.5		164	4
	68BR7136	2291		71	36.25	28.5		207	4

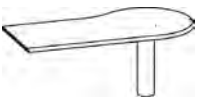
 P' Return with Post Leg	68PRL7130	3030		71	30	28.5	48.6	184	50
	68PRR7130*	3030		71	30	28.5	48.6	184	50
	68PRL7136	3175		71	36	28.5	48.6	227	58
	68PRR7136	3175		71	36	28.5	48.6	227	58
	68PRL8430	3472		84	30	28.5	65.25	207	59
	68PRR8430	3472		84	30	28.5	65.25	207	59
	68PRL8436	3587		84	36	28.5	62.5	254	68
68PRR8436	3587		84	36	28.5	62.5	254	68	

**ORDERING NOTES:**

Please see page 256 for brushed aluminum tapered post leg option.

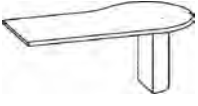
 P' Return with Half Drum Base	68PRL7130DB	3389		71	30	28.5	48.6	184	50
	68PRR7130DB*	3389		71	30	28.5	48.6	184	50
	68PRL7136DB	3538		71	36	28.5	48.6	227	58
	68PRR7136DB	3538		71	36	28.5	48.6	227	58
	68PRL8430DB	3839		84	30	28.5	65.25	207	59
	68PRR8430DB	3839		84	30	28.5	65.25	207	59
	68PRL8436DB	3950		84	36	28.5	62.5	254	68
	68PRR8436DB	3950		84	36	28.5	62.5	254	68
	68PRL9630DB	4119		96	30	28.5	70.75	241	74
	68PRR9630DB	4119		96	30	28.5	70.75	241	74
	68PRL9636DB	4469		96	36	28.5	68	295	77
	68PRR9636DB	4469		96	36	28.5	68	295	77

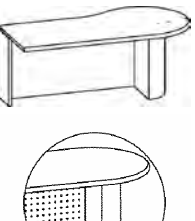
 'P' Return with Half Drum Base & Full Modesty Panel	68PRL7130DBM	4545		71	30	28.5	48.6	204	50
	68PRR7130DBM*	4545		71	30	28.5	48.6	204	50
	68PRL7136DBM	4579		71	36	28.5	48.6	247	58
	68PRR7136DBM	4579		71	36	28.5	48.6	247	58
	68PRL8430DBM	4914		84	30	28.5	65.25	232	59
	68PRR8430DBM	4914		84	30	28.5	65.25	232	59
	68PRL8436DBM	4656		84	36	28.5	62.5	274	68
	68PRR8436DBM	4656		84	36	28.5	62.5	274	68
	68PRL9630DBM	4962		96	30	28.5	70.75	261	74
	68PRR9630DBM	4962		96	30	28.5	70.75	261	74
	68PRL9636DBM	5338		96	36	28.5	68	310	77
	68PRR9636DBM	5338		96	36	28.5	68	310	77

**ORDERING NOTES:**

Please see page 256 for perforated metal modesty panel option. For reverse grain direction on returns use list price and note Reverse Grain on p.o.

**ORDERING PROCEDURE**

To order, please specify the following:

- 1) Krug product model number
- 2) Wood species and finish, see page 247
- 3) Wood edge detail- I,H, L or P, see page 250
- 4) Pull style, see page 250
- 5) Grommet location if applicable

\*Indicates model illustrated by line drawing.

**CODE DESCRIPTION**

- 4 - full height pedestal
- DB - Half Drum Base
- DBM - Half Drum Base & Full Modesty Panel

**STANDARD FINISHES**

For a complete list of standard wood finishes please see page 247.

**GROMMETS**

One wiring grommet in standard position is optional at no charge. Additional wiring grommets are available at an **upcharge of \$152.**

MILLENNIUM | LINKING TOPS

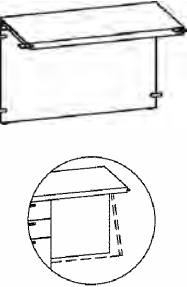
Description	Model	Cherry Walnut Maple	W	D	H	KW	Shipping Weight	Cubic Feet
	68LU3024H	1697	29.5	24.25	28.5		57	6
	68LU3620H	1776	35.5	20.25	28.5		54	6
	68LU3624H	1834	35.5	24.25	28.5		68	7
	68LU4220H	1857	41.5	20.25	28.5		66	7
	68LU4224H	1920	41.5	24.25	28.5		82	8
	68LU4820H*	1959	47.5	20.25	28.5		78	8
	68LU4824H	1993	47.5	24.25	28.5		97	9
	68LU5420H	2019	53.5	20.25	28.5		90	9
	68LU5424H	2045	53.5	24.25	28.5		111	10
	68LU6020H	2063	59.5	20.25	28.5		100	10
	68LU6024H	2096	59.5	24.25	28.5		123	11
	68LU6624H	2229	65.5	24.25	28.5		137	12
	68LU7124H	2378	70.5	24.25	28.5		148	13

**ORDERING NOTES:**  
Please see page 256 for wire management cut-out option. Please see page 256 for hinged modesty panel option and perforated metal modesty panel option.

	68LUC3624H	2158	35.5	24.25	28.5		68	7
	68LUC4224H	2197	41.5	24.25	28.5		82	8
	68LUC4824H*	2321	47.5	24.25	28.5		97	9

**ORDERING NOTES:**  
Please see page 256 for wire management cut-out option. Please see page 256 for hinged modesty panel option and for perforated metal modesty panel option. Linking unit is 21.25" deep at the center of the curve.

	68LT3620H	883	35.5	20.25	28.5		34	6
	68LT3624H	888	35.5	24.25	28.5		48	6
	68LT4220H	915	41.5	20.25	28.5		46	7
	68LT4224H	943	41.5	24.25	28.5		62	8
	68LT4820H*	968	47.5	20.25	28.5		58	8
	68LT4824H	984	47.5	24.25	28.5		77	9
	68LT5420H	997	53.5	20.25	28.5		70	9
	68LT5424H	1006	53.5	24.25	28.5		91	10
	68LT6020H	1018	59.5	20.25	28.5		80	10
	68LT6024H	1053	59.5	24.25	28.5		93	11
	68LT6620H	1066	65.5	20.25	28.5		82	11
	68LT6624H	1084	65.5	24.25	28.5		107	12
	68LT7124H	1107	70.5	24.25	28.5		118	13

**ORDERING NOTES:** For reverse grain direction on returns use list price and note Reverse Grain on p.o.

	68LTC3624H	1019	35.5	24.25	28.5		48	6
	68LTC4224H	1073	41.5	24.25	28.5		62	8
	68LTC4824H*	1136	47.5	24.25	28.5		77	9

**ORDERING NOTES:** Linking unit is 21.25" deep at the center of the curve. For reverse grain direction on returns use list price and note Reverse Grain on p.o.

**DIMENSION KEY**  
W - width  
D - depth  
H - height

**CODE DESCRIPTION**  
H - desk height

**STANDARD FINISHES**  
For a complete list of standard wood finishes please see page 256.

**GABLE SUPPORT**  
A half gable support is required on any open spans greater than 60" that don't have a modesty panel.

# MILLENNIUM | CORNER UNITS

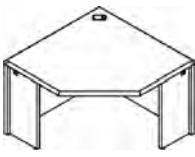
Description	Model	Cherry		W	D	H	KW	Shipping Weight	Cubic Feet
		Walnut	Maple						
	68CU363620	3476		36.25	36.25	28.5	22.5	132	26
	68CU363624	3476		36.25	36.25	28.5	17	132	26
	68CU424224*	3818		42.25	42.25	28.5	25.5	164	35
	68CU4242L24R30	3876		42.25	42.25	28.5	21.5	164	35
	68CU4242L30R24	3876		42.25	42.25	28.5	21.5	164	35

**ORDERING NOTES:** Includes a standard grommet in the "C" position. Laminate worksurfaces are available at a 10% upcharge. When ordering a keyboard for use with a corner unit, please specify a 68KBAC2110 with an extended mechanism.

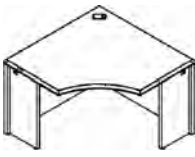
Description	Model	Cherry		W	D	H	KW	Shipping Weight	Cubic Feet
		Walnut	Maple						
	68CUC363620	3642		36.25	36.25	28.5	22.5	132	26
	68CUC363624	3642		36.25	36.25	28.5	17	132	26
	68CUC424224*	4011		42.25	42.25	28.5	25.5	164	35
	68CUC4242L24R30	4114		42.25	42.25	28.5	21.5	132	35
	68CUC4242L30R24	4114		42.25	42.25	28.5	21.5	132	35

**ORDERING NOTES:** Includes a standard grommet in the "C" position. Laminate worksurfaces are available at a 10% upcharge. When ordering a keyboard for use with a corner unit, please specify a 68KBAC2110 with an extended mechanism.

**ORDERING PROCEDURE**

To order, please specify the following:

- 1) Krug product model number
- 2) Wood species and finish, see page 247
- 3) Wood edge detail- I,H, L or P, see page 250
- 4) Pull style, see page 250
- 5) Grommet location if applicable

\*Indicates model illustrated by line drawing.

**STANDARD FINISHES**

For a complete list of standard wood finishes please see page 247.

**GROMMETS**

One wiring grommet in standard position is optional at no charge. Additional wiring grommets are available at an **upcharge of \$152.**

MILLENNIUM | CREDENZAS

Description	Model	Cherry		W	D	H	KW	Shipping	
		Walnut	Maple					Weight	Cubic Feet
Single Pedestal Credenza	68C60204LDRO	4841		60	20.25	28.5	42	154	24
	68C60204LFR0	4841		60	20.25	28.5	42	154	24
with Full Height Pedestals	68C60204LORD	4841		60	20.25	28.5	42	154	24
	68C60204LORF	4841		60	20.25	28.5	42	154	24
	68C60244LDRO	4877		60	24.25	28.5	42	178	29
	68C60244LFR0	4877		60	24.25	28.5	42	178	29
	68C60244LORD	4877		60	24.25	28.5	42	178	29
	68C60244LORF	4877		60	24.25	28.5	42	178	29
	68C66204LDRO	4911		65.75	20.25	28.5	48	165	27
	68C66204LFR0	4911		65.75	20.25	28.5	48	165	27
	68C66204LORD	4911		65.75	20.25	28.5	48	165	27
	68C66204LORF	4911		65.75	20.25	28.5	48	165	27
	68C66244LDRO	4923		65.75	24.25	28.5	48	192	32
	68C66244LFR0	4923		65.75	24.25	28.5	48	192	32
	68C66244LORD	4923		65.75	24.25	28.5	48	192	32
	68C66244LORF	4923		65.75	24.25	28.5	48	192	32
	68C71204LDRO*	4949		71	20.25	28.5	53.25	175	29
	68C71204LFR0	4949		71	20.25	28.5	53.25	175	29
	68C71204LORD	4949		71	20.25	28.5	53.25	175	29
	68C71204LORF	4949		71	20.25	28.5	53.25	175	29
	68C71244LDRO	4998		71	24.25	28.5	53.25	204	34
	68C71244LFR0	4998		71	24.25	28.5	53.25	204	34
	68C71244LORD	4998		71	24.25	28.5	53.25	204	34
	68C71244LORF	4998		71	24.25	28.5	53.25	204	34
	68C78204LDRO	5040		78	20.25	28.5	60.5	193	26
	68C78204LFR0	5040		78	20.25	28.5	60.5	193	26
	68C78204LORD	5040		78	20.25	28.5	60.5	193	26
	68C78204LORF	5040		78	20.25	28.5	60.5	193	26
	68C78244LDRO	5083		78	24.25	28.5	60.5	224	32
	68C78244LFR0	5083		78	24.25	28.5	60.5	224	32
	68C78244LORD	5083		78	24.25	28.5	60.5	224	32
	68C78244LORF	5083		78	24.25	28.5	60.5	224	32
	68C84204LDRO	5131		83.75	20.25	28.5	66.25	191	34
	68C84204LFR0	5131		83.75	20.25	28.5	66.25	191	34
	68C84204LORD	5131		83.75	20.25	28.5	66.25	191	34
	68C84204LORF	5131		83.75	20.25	28.5	66.25	191	34
	68C84244LDRO	5157		83.75	24.25	28.5	66.25	222	38
	68C84244LFR0	5157		83.75	24.25	28.5	66.25	222	38
	68C84244LORD	5157		83.75	24.25	28.5	66.25	222	38
	68C84244LORF	5157		83.75	24.25	28.5	66.25	222	38

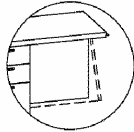
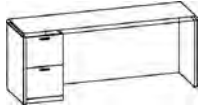

**ORDERING NOTES:**  
Please see page 256 for wire management cut-out and/or hinged modesty panel option.

<p><b>DIMENSION KEY</b> W - width D - depth H - height</p>	<p><b>CODE DESCRIPTION</b> 0 - no pedestal 4 - full height pedestal L - left handed pedestal position R - right handed pedestal position D - 2 file drawer F - 2 box, 1 file drawer</p>	<p><b>STANDARD FINISHES</b> For a complete list of standard wood finishes please see page 247.</p> <p><b>OPEN/DESK RETURNS</b> Open returns can be found in the shell section on page 298. Desk depth returns have a recessed modesty panel.</p>
--	---	--

# MILLENNIUM | CREDENZAS

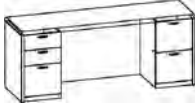
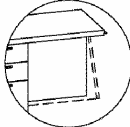
Description	Model	Cherry		W	D	H	KW	Shipping Weight	Cubic Feet
		Walnut	Maple						
Double Pedestal	68C60204LDRD	5229		60	20.25	28.5	27.25	186	24
Credenza with Full	68C60204LDRF	5229		60	20.25	28.5	27.25	186	24
Height Pedestals	68C60204LFRD	5229		60	20.25	28.5	27.25	186	24
	68C60204LFRF	5229		60	20.25	28.5	27.25	186	24
	68C60244LDRD	5243		60	24.25	28.5	27.25	210	29
	68C60244LDRF	5243		60	24.25	28.5	27.25	210	29
	68C60244LFRD	5243		60	24.25	28.5	27.25	210	29
	68C60244LFRF	5243		60	24.25	28.5	27.25	210	29
	68C66204LDRD	5284		65.75	20.25	28.5	33.25	197	27
	68C66204LDRF	5284		65.75	20.25	28.5	33.25	197	27
	68C66204LFRD	5284		65.75	20.25	28.5	33.25	197	27
	68C66204LFRF	5284		65.75	20.25	28.5	33.25	197	27
	68C66244LDRD	5289		65.75	24.25	28.5	33.25	210	32
	68C66244LDRF	5289		65.75	24.25	28.5	33.25	210	32
	68C66244LFRD	5289		65.75	24.25	28.5	33.25	210	32
	68C66244LFRF	5289		65.75	24.25	28.5	33.25	210	32
	68C71204LDRD	5316		71	20.25	28.5	38.5	207	29
	68C71204LDRF	5316		71	20.25	28.5	38.5	207	29
	68C71204LFRD*	5316		71	20.25	28.5	38.5	207	29
	68C71204LFRF	5316		71	20.25	28.5	38.5	207	29
	68C71244LDRD	5373		71	24.25	28.5	38.5	236	34
	68C71244LDRF	5373		71	24.25	28.5	38.5	236	34
	68C71244LFRD	5373		71	24.25	28.5	38.5	236	34
	68C71244LFRF	5373		71	24.25	28.5	38.5	236	34
	68C78204LDRD	5391		78	20.25	28.5	42.5	205	26
	68C78204LDRF	5391		78	20.25	28.5	42.5	205	26
	68C78204LFRD	5391		78	20.25	28.5	42.5	205	26
	68C78204LFRF	5391		78	20.25	28.5	42.5	205	26
	68C78244LDRD	5471		78	24.25	28.5	42.5	253	32
	68C78244LDRF	5471		78	24.25	28.5	42.5	253	32
	68C78244LFRD	5471		78	24.25	28.5	42.5	253	32
	68C78244LFRF	5471		78	24.25	28.5	42.5	253	32
	68C84204LDRD	5429		83.75	20.25	28.5	51.75	223	34
	68C84204LDRF	5429		83.75	20.25	28.5	51.75	223	34
	68C84204LFRD	5429		83.75	20.25	28.5	51.75	223	34
	68C84204LFRF	5429		83.75	20.25	28.5	51.75	223	34
	68C84244LFRD	5562		83.75	24.25	28.5	51.75	254	38
	68C84244LDRF	5562		83.75	24.25	28.5	51.75	254	38
	68C84244LDRD	5562		83.75	24.25	28.5	51.75	254	38
	68C84244LFRF	5562		83.75	24.25	28.5	51.75	254	38

**ORDERING NOTES:**

The pencil drawer can not be used in 20" deep knee hole credenzas and/or shells. Please see page 256 for wire management cut-out option and for hinged modesty panel option.

**ORDERING PROCEDURE**

To order, please specify the following:

- 1) Krug product model number
- 2) Wood species and finish, see page 247
- 3) Wood edge detail- I,H, L or P, see page 250
- 4) Pull style, see page 250
- 5) Grommet location if applicable

\*Indicates model illustrated by line drawing.

**CODE DESCRIPTION**

- 4 - full height pedestal
- L - left handed pedestal position
- R - right handed pedestal position
- D - 2 file drawer
- F - 2 box, 1 file drawer

**STANDARD FINISHES**

For a complete list of standard wood finishes please see page 247.

**GROMMETS**

One wiring grommet in standard position is optional at no charge. Additional wiring grommets are available at an **upcharge of \$152.**

# MILLENNIUM | CREDENZAS

Description	Model	Cherry	W	D	H	KW	Shipping Weight	Cubic Feet
		Walnut Maple						
Bow Top, Double Pedestal Credenza with Full Height Pedestals	68CX71204LDRD	5688	71	20.5	28.5	38.5	217	29
	68CX71204LDRF	5688	71	20.5	28.5	38.5	217	29
	68CX71204LFRD	5688	71	20.5	28.5	38.5	217	29
	68CX71204LFRF	5688	71	20.5	28.5	38.5	217	29
	68CX71244LDRD	5812	71	24.5	28.5	38.5	246	24
	68CX71244LDRF	5812	71	24.5	28.5	38.5	246	24
	68CX71244LFRD	5812	71	24.5	28.5	38.5	246	24
	68CX71244LFRF	5812	71	24.5	28.5	38.5	246	24
	68CX78204LDRD	5840	78	20.5	28.5	42.5	224	26
	68CX78204LDRF	5840	78	20.5	28.5	42.5	224	26
	68CX78204LFRD*	5840	78	20.5	28.5	42.5	224	26
	68CX78204LFRF	5840	78	20.5	28.5	42.5	224	26
	68CX78244LDRD	5849	78	24.5	28.5	42.5	257	38
	68CX78244LDRF	5849	78	24.5	28.5	42.5	257	38
	68CX78244LFRD	5849	78	24.5	28.5	42.5	257	38
	68CX78244LFRF	5849	78	24.5	28.5	42.5	257	38
	68CX84204LDRD	5940	83.75	20.5	28.5	51.75	233	34
	68CX84204LDRF	5940	83.75	20.5	28.5	51.75	233	34
	68CX84204LFRD	5940	83.75	20.5	28.5	51.75	233	34
	68CX84204LFRF	5940	83.75	20.5	28.5	51.75	233	34
	68CX84244LDRD	5947	83.75	24.5	28.5	51.75	264	38
	68CX84244LDRF	5947	83.75	24.5	28.5	51.75	264	38
	68CX84244LFRD	5947	83.75	24.5	28.5	51.75	264	38
	68CX84244LFRF	5947	83.75	24.5	28.5	51.75	264	38

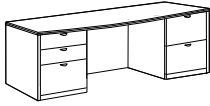

**ORDERING NOTES:**

The pencil drawer can not be used in 20" deep knee hole credenzas and/or shells. Please see page 256 for wire management cut-out option and for hinged modesty panel option.

Credenza, Ganged Pedestals	68C66204LDDR0	5771	65.75	20.25	28.5	33.25	197	27
	68C66204LDFR0	5771	65.75	20.25	28.5	33.25	197	27
	68C66204LFDR0	5771	65.75	20.25	28.5	33.25	197	27
	68C66204LFFR0**	5771	65.75	20.25	28.5	33.25	197	27
	68C66204LORDD	5771	65.75	20.25	28.5	33.25	197	27
	68C66204LORDF	5771	65.75	20.25	28.5	33.25	197	27
	68C66204LORFD*	5771	65.75	20.25	28.5	33.25	197	27
	68C66204LORFF	5771	65.75	20.25	28.5	33.25	197	27
	68C66244LDDR0	5807	65.75	24.5	28.5	33.25	224	32
	68C66244LDFR0	5807	65.75	24.5	28.5	33.25	224	32
	68C66244LFDR0	5807	65.75	24.5	28.5	33.25	224	32
	68C66244LFFR0	5807	65.75	24.5	28.5	33.25	224	32
	68C66244LORDD	5807	65.75	24.5	28.5	33.25	224	32
	68C66244LORDF	5807	65.75	24.5	28.5	33.25	224	32
	68C66244LORFD	5807	65.75	24.5	28.5	33.25	224	32
	68C66244LORFF	5807	65.75	24.5	28.5	33.25	224	32
	68C71204LDDR0	5835	71	20.25	28.5	38.5	207	29
	68C71204LDFR0	5835	71	20.25	28.5	38.5	207	29
	68C71204LFDR0	5835	71	20.25	28.5	38.5	207	29
	68C71204LFFR0	5835	71	20.25	28.5	38.5	207	29
	68C71204LORDD	5835	71	20.25	28.5	38.5	207	29

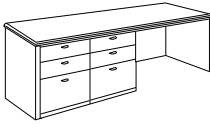
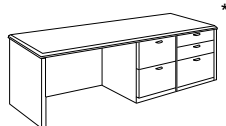

**ORDERING NOTES:**

"C" position grommets are not available on 60-71" Ganged Pedestal Credenzas. Ganged pedestals are specified in the product code beginning with the pedestal closest to the end panel.

**DIMENSION KEY**

W - width  
D - depth  
H - height

**CODE DESCRIPTION**

0 - no pedestal  
4 - full height pedestal  
L - left handed pedestal position  
R - right handed pedestal position  
D - 2 file drawer  
F - 2 box, 1 file drawer

**STANDARD FINISHES**

For a complete list of standard wood finishes please see page 247.

**GABLE SUPPORT**

A half gable support is required on any open spans greater than 60" that don't have a modesty panel.

# MILLENNIUM | CREDENZAS

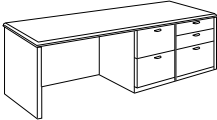
Description	Model	Cherry Walnut Maple	W	D	H	KW	Shipping Weight	Cubic Feet
Credenza, Ganged Pedestals	68C71204LORDF	5835	71	20.25	28.5	38.5	207	29
	68C71204LORFD*	5835	71	24.5	28.5	38.5	207	29
	68C71204LORFF	5835	71	24.5	28.5	38.5	207	29
	68C71244LDDRO	5869	71	24.5	28.5	38.5	236	34
	68C71244LDFRO	5869	71	24.5	28.5	38.5	236	34
	68C71244LFDR0	5869	71	24.5	28.5	38.5	236	34
	68C71244LFFR0	5869	71	24.5	28.5	38.5	236	34
	68C71244LORDD	5869	71	24.5	28.5	38.5	236	34
	68C71244LORDF	5869	71	24.5	28.5	38.5	236	34
	68C71244LORFD	5869	71	20.25	28.5	38.5	236	34
	68C71244LORFF	5869	71	20.25	28.5	38.5	236	34
	68C78204LDDRO	5873	78	20.5	28.5	42.5	217	26
	68C78204LDFRO	5873	78	20.5	28.5	42.5	217	26
	68C78204LFDR0	5873	78	20.5	28.5	42.5	217	26
	68C78204LFFR0	5873	78	20.5	28.5	42.5	217	26
	68C78204LORDD	5873	78	20.5	28.5	42.5	217	26
	68C78204LORDF	5873	78	20.5	28.5	42.5	217	26
	68C78204LORFD	5873	78	20.5	28.5	42.5	217	26
	68C78204LORFF	5873	78	20.5	28.5	42.5	217	26
	68C78244LDDRO	5881	78	24.5	28.5	42.5	253	32
	68C78244LDFRO	5881	78	24.5	28.5	42.5	253	32
	68C78244LFDR0	5881	78	24.5	28.5	42.5	253	32
	68C78244LFFR0	5881	78	24.5	28.5	42.5	253	32
	68C78244LORDD	5881	78	24.5	28.5	42.5	253	32
	68C78244LORDF	5881	78	24.5	28.5	42.5	253	32
	68C78244LORFD	5881	78	24.5	28.5	42.5	253	32
	68C78244LORFF	5881	78	24.5	28.5	42.5	253	32
	68C84204LDDRO	5947	83.75	20.5	28.5	51.5	223	34
	68C84204LDFRO	5947	83.75	20.5	28.5	51.5	223	34
	68C84204LFDR0	5947	83.75	20.5	28.5	51.5	223	34
	68C84204LFFR0	5947	83.75	20.5	28.5	51.5	223	34
	68C84204LORDD	5947	83.75	20.5	28.5	51.5	223	34
	68C84204LORDF	5947	83.75	20.5	28.5	51.5	223	34
	68C84204LORFD	5947	83.75	20.5	28.5	51.5	223	34
	68C84204LORFF	5947	83.75	20.5	28.5	51.5	223	34
	68C84244LDDRO	5978	83.75	24.5	28.5	51.5	223	34
68C84244LDFRO	5978	83.75	24.5	28.5	51.5	223	34	
68C84244LFDR0	5978	83.75	24.5	28.5	51.5	223	34	
68C84244LFFR0	5978	83.75	24.5	28.5	51.5	223	34	
68C84244LORDD	5978	83.75	24.5	28.5	51.5	223	34	
68C84244LORDF	5978	83.75	24.5	28.5	51.5	223	34	
68C84244LORFD	5978	83.75	24.5	28.5	51.5	223	34	
68C84244LORFF	5978	83.75	24.5	28.5	51.5	223	34	

**ORDERING NOTES:**

"C" position grommets are not available on 60-71" Ganged Pedestal Credenzas. Ganged pedestals are specified in the product code beginning with the pedestal closest to the end panel.

**ORDERING PROCEDURE**

To order, please specify the following:

- 1) Krug product model number
- 2) Wood species and finish, see page 247
- 3) Wood edge detail- I,H, L or P, see page 250
- 4) Pull style, see page 250
- 5) Grommet location if applicable

\*Indicates model illustrated by line drawing.

**CODE DESCRIPTION**

- 0 - no pedestal
- 4 - full height pedestal
- L - left handed pedestal position
- R - right handed pedestal position
- D - 2 file drawer
- F - 2 box, 1 file drawer

**STANDARD FINISHES**

For a complete list of standard wood finishes please see page 247.

**GROMMETS**

One wiring grommet in standard position is optional at no charge. Additional wiring grommets are available at an **upcharge of \$152.**

MILLENNIUM | CREDENZAS

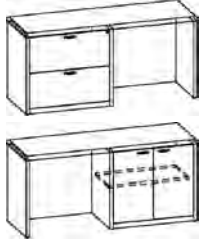
Description	Model	Cherry		W	D	H	KW	Shipping Weight	Cubic Feet
		Walnut	Maple						
Credenza, Lateral File or Bookcase Pedestals 	68C6020LBR0	4392		60	20.5	28.5	28	174	24
	68C6020LFR0	4866		60	20.5	28.5	28	205	24
	68C6020LORB	4392		60	20.5	28.5	28	172	24
	68C6020LORF	4866		60	20.5	28.5	28	205	24
	68C6024LBR0	4416		60	24.5	28.5	28	198	29
	68C6024LFR0	4891		60	24.5	28.5	28	229	29
	68C6024LORB	4416		60	24.5	28.5	28	198	29
	68C6024LORF	4891		60	24.5	28.5	28	229	29
	68C6620LBR0	4507		65.75	20.5	28.5	33.75	185	28
	68C6620LFR0	4990		65.75	20.5	28.5	33.75	216	28
	68C6620LORB	4507		65.75	20.5	28.5	33.75	185	28
	68C6620LORF	4990		65.75	20.5	28.5	33.75	216	28
	68C6624LBR0	4596		65.75	24.5	28.5	33.75	212	32
	68C6624LFR0	5093		65.75	24.5	28.5	33.75	243	32
	68C6624LORB	4596		65.75	24.5	28.5	33.75	212	32
	68C6624LORF	5093		65.75	24.5	28.5	33.75	243	32
	68C7120LBR0	4672		71	20.5	28.5	33.5	195	31
	68C7120LFR0	5218		71	20.5	28.5	33.5	226	31
	68C7120LORB	4672		71	20.5	28.5	33.5	195	31
	68C7120LORF	5218		71	20.5	28.5	33.5	226	31
	68C7124LBR0	4795		71	24.5	28.5	33.5	224	34
	68C7124LFR0	5302		71	24.5	28.5	33.5	257	34
	68C7124LORB	4795		71	24.5	28.5	33.5	224	34
	68C7124LORF	5302		71	24.5	28.5	33.5	257	34
	68C7820LBR0	4784		78	20.5	28.5	41.5	196	26
	68C7820LFR0	5314		78	20.5	28.5	41.5	227	26
	68C7820LORB	4784		78	20.5	28.5	41.5	196	26
	68C7820LORF	5314		78	20.5	28.5	41.5	227	26
	68C7824LBR0	4853		78	24.5	28.5	41.5	221	32
	68C7824LFR0	5427		78	24.5	28.5	41.5	252	32
	68C7824LORB	4853		78	24.5	28.5	41.5	221	32
	68C7824LORF	5427		78	24.5	28.5	41.5	252	32
	68C8420LBR0	4933		83.75	20.5	28.5	39.5	211	34
	68C8420LFR0	5452		83.75	20.5	28.5	39.5	242	34
	68C8420LORB	4933		83.75	20.5	28.5	39.5	211	34
	68C8420LORF	5452		83.75	20.5	28.5	39.5	242	34
	68C8424LBR0	5035		83.75	24.5	28.5	39.5	242	40
	68C8424LFR0	5562		83.75	24.5	28.5	39.5	273	40
	68C8424LORB	5035		83.75	24.5	28.5	39.5	242	40
	68C8424LORF	5562		83.75	24.5	28.5	39.5	273	40

**ORDERING NOTES:**

"C" position grommets are not available on 60-71" Lateral File/ Bookcase Pedestal Credenzas.

**DIMENSION KEY**

W - width  
 D - depth  
 H - height

**CODE DESCRIPTION**

0 - no pedestal  
 H - desk height  
 4 - full height pedestal  
 L - left handed pedestal position  
 R - right handed pedestal position  
 D - 2 file drawer  
 BC - bookcase  
 F - 2 box, 1 file drawer: when proceeded in the model number by -4.  
 F - 2 lateral file drawers: when it directly follows the size classified.

**STANDARD FINISHES**

For a complete list of standard wood finishes please see page 247.

**GABLE SUPPORT**

A half gable support is required on any open spans greater than 60" that don't have a modesty panel.



# MILLENNIUM | CREDENZAS

Description	Model	Cherry		W	D	H	Shipping Weight	Cubic Feet
		Walnut	Maple					
 Credenza, Full Face	68C66244DBCD	6144	6144	65.75	24.5	28.5	295	31
	68C66244DBCF	6144	6144	65.75	24.5	28.5	295	31
	68C66244FBCD	6144	6144	65.75	24.5	28.5	295	31
	68C66244FBCF*	6144	6144	65.75	24.5	28.5	295	31
	68C71204DBCD	6347	6347	71	20.5	28.5	295	30
	68C71204DBCF	6347	6347	71	20.5	28.5	295	30
	68C71204FBCD	6347	6347	71	20.5	28.5	295	30
	68C71204FBCF	6347	6347	71	20.5	28.5	295	30
	68C71244DBCD	6508	6508	71	24.5	28.5	305	34
	68C71244DBCF	6508	6508	71	24.5	28.5	305	34
	68C71244FBCD	6508	6508	71	24.5	28.5	305	34
	68C71244FBCF	6508	6508	71	24.5	28.5	305	34
	68C78204DBCD	6516	6516	78	20.5	28.5	305	30
	68C78204DBCF	6516	6516	78	20.5	28.5	305	30
	68C78204FBCD	6516	6516	78	20.5	28.5	305	30
	68C78204FBCF	6516	6516	78	20.5	28.5	305	30
	68C78244DBCD	6730	6730	78	24.5	28.5	315	34
	68C78244DBCF	6730	6730	78	24.5	28.5	315	34
	68C78244FBCD	6730	6730	78	24.5	28.5	315	34
	68C78244FBCF	6730	6730	78	24.5	28.5	315	34
	68C84204DBCD	6690	6690	83.75	20.5	28.5	315	36
	68C84204DBCF	6690	6690	83.75	20.5	28.5	315	36
	68C84204FBCD	6690	6690	83.75	20.5	28.5	315	36
	68C84204FBCF	6690	6690	83.75	20.5	28.5	315	36
	68C84244DBCD	6882	6882	83.75	24.5	28.5	325	40
	68C84244DBCF	6882	6882	83.75	24.5	28.5	325	40
	68C84244FBCD	6882	6882	83.75	24.5	28.5	325	40
	68C84244FBCF	6882	6882	83.75	24.5	28.5	325	40

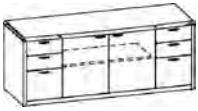
 Bow Top Full Face Credenza	68CX66204DBCD	6543	6543	65.75	20.5	28.5	264	27
	68CX66204FBCF*	6543	6543	65.75	20.5	28.5	264	27
	68CX66204FBCD	6543	6543	65.75	20.5	28.5	264	27
	68CX66204DBCF	6543	6543	65.75	20.5	28.5	264	27
	68CX66244DBCD	6663	6663	65.75	24.5	28.5	291	30
	68CX66244FBCF	6663	6663	65.75	24.5	28.5	291	30
	68CX66244FBCD	6663	6663	65.75	24.5	28.5	291	30
	68CX66244DBCF	6663	6663	65.75	24.5	28.5	291	30
	68CX71204DBCD	6875	6875	71	20.5	28.5	271	32
	68CX71204FBCF	6875	6875	71	20.5	28.5	271	32
	68CX71204FBCD	6875	6875	71	20.5	28.5	271	32
	68CX71204DBCF	6875	6875	71	20.5	28.5	271	32
	68CX71244DBCD	7042	7042	71	24.5	28.5	303	34
	68CX71244FBCF	7042	7042	71	24.5	28.5	303	34
	68CX71244FBCD	7042	7042	71	24.5	28.5	303	34
	68CX71244DBCF	7042	7042	71	24.5	28.5	303	34
	68CX78204DBCD	7148	7148	78	20.5	28.5	278	37
	68CX78204FBCF	7148	7148	78	20.5	28.5	278	37
	68CX78204FBCD	7148	7148	78	20.5	28.5	278	37
	68CX78204DBCF	7148	7148	78	20.5	28.5	278	37
	68CX78244DBCD	7478	7478	78	24.5	28.5	315	38
	68CX78244FBCF	7478	7478	78	24.5	28.5	315	38
	68CX78244FBCD	7478	7478	78	24.5	28.5	315	38
	68CX78244DBCF	7478	7478	78	24.5	28.5	315	38

### ORDERING PROCEDURE

To order, please specify the following:

- 1) Krug product model number
- 2) Wood species and finish, see page 247
- 3) Wood edge detail- I,H, L or P, see page 250
- 4) Pull style, see page 250
- 5) Grommet location if applicable

\*Indicates model illustrated by line drawing.

### CODE DESCRIPTION

- 0 - no pedestal
- 4 - full height pedestal
- L - left handed pedestal position
- R - right handed pedestal position
- D - 2 file drawer
- BC - bookcase
- F - 2 box, 1 file drawer

### STANDARD FINISHES

For a complete list of standard wood finishes please see page 247.

### GROMMETS

One wiring grommet in standard position is optional at no charge. Additional wiring grommets are available at an **upcharge of \$152.**

MILLENNIUM | CREDENZAS

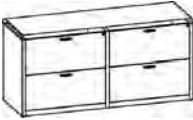
Description	Model	Cherry Walnut Maple	W	D	H	KW	Shipping Weight	Cubic Feet
Credenza, Lateral File and Bookcase Pedestal 	68C6020LBRB	5272	60	20.5	28.5		226	24
	68C6020LBRF	6167	60	20.5	28.5		257	24
	68C6020LFRB	6185	60	20.5	28.5		257	24
	68C6020LFRF	6796	60	20.5	28.5		288	24
	68C6024LBRB	5273	60	24.5	28.5		250	29
	68C6024LBRF	6229	60	24.5	28.5		281	29
	68C6024LFRB	6229	60	24.5	28.5		281	29
	68C6024LFRF	6822	60	24.5	28.5		312	29
	68C7120LBRB	5616	71	20.5	28.5		247	31
	68C7120LBRF	6599	71	20.5	28.5		278	31
	68C7120LFRB	6599	71	20.5	28.5		278	31
	68C7120LFRF	7233	71	20.5	28.5		309	31
	68C7124LBRB	5696	71	24.5	28.5		271	34
	68C7124LBRF	6720	71	24.5	28.5		307	34
	68C7124LFRB	6720	71	24.5	28.5		307	34
	68C7124LFRF	7324	71	24.5	28.5		338	34
	68C8420LBRB	5810	83.75	20.5	28.5		263	34
	68C8420LBRF	6884	83.75	20.5	28.5		294	34
	68C8420LFRB	6884	83.75	20.5	28.5		294	34
	68C8420LFRF	7452	83.75	20.5	28.5		325	34
68C8424LBRB	5889	83.75	24.5	28.5		294	40	
68C8424LBRF	7036	83.75	24.5	28.5		325	40	
68C8424LFRB	7036	83.75	24.5	28.5		325	40	
68C8424LFRF	7536	83.75	24.5	28.5		356	40	

Credenza with Height Adjustable Electric Lift (Single Stage) 	68C6024LBRHAES*	6875	59.75	24	29.5		176	28
	68C6024LHAESRB	6875	59.75	24	29.5		192	28
	68C6024LFRHAES	7152	59.75	24	29.5		192	28
	68C6024LHAESRF	7152	59.75	24	29.5		248	28
	68C7224LBRHAES	7566	71.75	24	29.5		192	33
	68C7224LHAESRB	7566	71.75	24	29.5		210	33
	68C7224LFRHAES	7725	71.75	24	29.5		210	33
	68C7224LHAESRF	7725	71.75	24	29.5		230	33

Bow Top Credenza, Front Lateral File and Bookcase Pedestal 	68CX6020LBRB	6060	60	20.5	28.5		241	24
	68CX6020LBRF	7135	60	20.5	28.5		272	24
	68CX6020LFRB	7135	60	20.5	28.5		272	24
	68CX6020LFRF	7824	60	20.5	28.5		303	24
	68CX6024LBRB	6126	60	24.5	28.5		265	29
	68CX6024LBRF	7282	60	24.5	28.5		296	29
	68CX6024LFRB	7282	60	24.5	28.5		296	29
	68CX6024LFRF	7918	60	24.5	28.5		327	29
	68CX7120LBRB	6270	71	20.5	28.5		262	31
	68CX7120LBRF	7418	71	20.5	28.5		293	31
	68CX7120LFRB	7418	71	20.5	28.5		293	31
	68CX7120LFRF	8074	71	20.5	28.5		324	31
	68CX7124LBRB	6391	71	24.5	28.5		291	34
	68CX7124LBRF	7577	71	24.5	28.5		322	34
	68CX7124LFRB	7577	71	24.5	28.5		322	34
	68CX7124LFRF	8123	71	24.5	28.5		353	34

**ORDERING NOTES:** Height range of electric lift is 29.5" to 46.5".

**DIMENSION KEY**

W - width  
D - depth  
H - height

**CODE DESCRIPTION**

4 - full height pedestal  
L - left handed pedestal position  
R - right handed pedestal position  
B - bookcase  
F - 2 lateral file drawers

**STANDARD FINISHES**

For a complete list of standard wood finishes please see page 247.

# MILLENNIUM | CREDENZAS

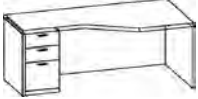
Description	Model	Cherry	W	D	H	Shipping Weight	Cubic Feet
		Walnut Maple					
	68CC6624L4D	4209	65.75	36.25	28.5	230	45
	68CC6624L4F	4209	65.75	36.25	28.5	230	45
	68CC6624R4D	4209	65.75	36.25	28.5	230	45
	68CC6624R4F	4209	65.75	36.25	28.5	230	45
	68CC7124L4D	4308	71	36.25	28.5	240	50
	68CC7124L4F	4308	71	36.25	28.5	240	50
	68CC7124R4D	4308	71	36.25	28.5	240	50
	68CC7124R4F	4308	71	36.25	28.5	240	50
	68CC7824L4D	4365	78	36.25	28.5	250	55
	68CC7824L4F	4365	78	36.25	28.5	250	55
	68CC7824R4D	4365	78	36.25	28.5	250	55
	68CC7824R4F	4365	78	36.25	28.5	250	55
	68CC8424L4D	4418	82.75	36.25	28.5	260	59
	68CC8424L4F	4418	82.75	36.25	28.5	260	59
	68CC8424R4D	4418	82.75	36.25	28.5	260	59
	68CC8424R4F	4418	82.75	36.25	28.5	260	59

**ORDERING NOTES:**

For a curved corner version of this credenza, please add 5% list to above list prices and add an extra C to the model number prefix. Example: 68CCC7124L4D\*\*

**ORDERING PROCEDURE**

To order, please specify the following:

- 1) Krug product model number
- 2) Wood species and finish, see page 247
- 3) Wood edge detail- I,H, L or P, see page 250
- 4) Pull style, see page 250
- 5) Grommet location if applicable

\*Indicates model illustrated by line drawing.

**CODE DESCRIPTION**

- 4 - full height pedestal
- L - left handed pedestal position
- R - right handed pedestal position
- D - 2 file drawer
- F - 2 box, 1 file drawer

**STANDARD FINISHES**

For a complete list of standard wood finishes please see page 247.



**GROMMETS**

One wiring grommet in standard position is optional at no charge. Additional wiring grommets are available at an **upcharge of \$152.**

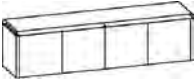
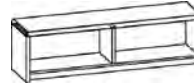
# MILLENNIUM | OVERHEADS

Description	Model	Cherry Walnut Maple	W	D	H	Doors	Shipping Weight	Cubic Feet
Overhead with Flipper Doors  	68OF3619*	2072	36	18	19.25		140	9
	68OF4219	2205	42	18	19.25		151	10
	68OF4819	2283	48	18	19.25		162	12
	68OF6019**	2672	58.5	18	19.25		173	15
	68OF6619	2810	64.25	18	19.25		184	16
	68OF7119	2962	70.5	18	19.25		195	17
	Single Height Overhead with Hinged Doors	68OH361517*	2073	36	15	16.75	2	127
	68OH421517	2205	42	15	16.75	2	136	10
	68OH481517	2286	48	15	16.75	3	145	12
	68OH601517**	2663	58.5	15	16.75	4	154	15
	68OH661517	2810	64.25	15	16.75	4	163	16
	68OH711517	2916	70.5	15	16.75	4	172	17
	Overhead, Open	68OO361517*	1704	36	15	16.75	2	117
	68OO421517	1798	42	15	16.75	2	126	10
	68OO481517	1867	48	15	16.75	3	135	12
	68OO601517**	2210	58.5	15	16.75	4	124	15
	68OO661517	2339	64.25	15	16.75	4	143	16
	68OO711517	2485	70.5	15	16.75	4	152	17

**ORDERING NOTES:** Please see page 257 for double height option and paper management option. All overheads include factory installed tasklights and mounting hardware. Locks are available on wood door overheads at **\$152 list per set** of (2) doors. Please specify at time of order.

Tackboards for Overheads with Flipper Doors		1	2	3	4	5	6	7	8	9	W	H	COM	WT
	68TBOF36	337	374	411	470	613	751	886	1031	1210	38	24	1.5	10
	68TBOF42	374	507	533	664	795	916	1053	1212	1429	44	24	1.5	12
	68TBOF48	416	516	541	677	815	937	1080	1240	1492	50	24	1.75	13
	68TBOF60	471	632	664	823	989	1172	1357	1543	1833	61	24	2	15
	68TBOF66	516	702	691	917	1102	1307	1487	1699	2024	67	24	2	16
	68TBOF71	568	871	908	1203	1480	1495	1717	1960	2285	74	24	2.25	18
Tackboards for Overheads with Hinged Doors		1	2	3	4	5	6	7	8	9	W	H	COM	WT
	68TBOH36	337	374	411	470	613	751	886	1031	1210	38	24	1.5	10
	68TBOH42	374	507	533	664	795	916	1053	1212	1429	44	24	1.5	12
	68TBOH48	416	516	541	677	815	937	1080	1240	1492	50	24	1.75	13
	68TBOH60	471	632	664	823	989	1172	1357	1543	1833	61	24	2	15
	68TBOH66	516	702	691	917	1102	1307	1487	1699	2024	67	24	2	16
	68TBOH71	568	871	908	1203	1480	1495	1717	1960	2285	74	24	2.25	18

**ORDERING NOTES:** Please contact Customer Service for information on yardage required when ordering two or more tackboards. Please note either tackboard code 68TBOF or 68TBOH can be used for an open overheads.

**DIMENSION KEY**  
W - width  
D - depth  
H - height

**STANDARD FINISHES**  
For a complete list of standard wood finishes please see page 247.

# MILLENNIUM | HUTCHES

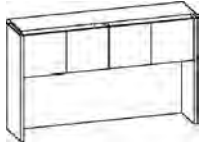
Description	Model	Cherry		W	D	H	TH	Shipping Weight	Cubic Feet
		Walnut	Maple						
	Hutches, Hinged Doors	68HT3615	2577	35.25	15	39.75	23	147	15
		68HT4215	2838	41	15	39.75	23	156	18
		68HT4815	3345	47	15	39.75	23	165	20
		68HT5415	3578	53	15	39.75	23	174	22
		68HT6015*	3924	58.75	15	39.75	23	183	25
		68HT6615	4292	64.75	15	39.75	23	192	27
		68HT7115	5036	70	15	39.75	23	201	30
		68HT7815	5339	77	15	39.75	23	210	32
		68HT8415	5637	83	15	39.75	23	215	35
		68HT9018-2	7259	89	18	39.75	23	274	44
		68HT9618-2	8181	95	18	39.75	23	293	47
		68HT10218-2	8698	101	18	39.75	23	311	50
		68HT11018-2	9322	109	18	39.75	23	336	54

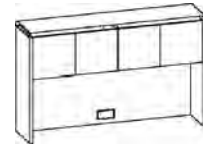
	Hutches, Hinged Doors & Power/Data/Voice Grommet	68HT3615W	2790	35.25	15	39.75	23	147	15
		68HT4215W	3040	41	15	39.75	23	156	18
		68HT4815W	3554	47	15	39.75	23	165	20
		68HT5415W	3763	53	15	39.75	23	174	22
		68HT6015W*	4129	58.75	15	39.75	23	183	25
		68HT6615W	4490	64.75	15	39.75	23	192	27
		68HT7115W	5242	70	15	39.75	23	201	30
		68HT7815W	5519	77	15	39.75	23	210	32
		68HT8415W	5844	83	15	39.75	23	215	35
		68HT9018-2W	7511	89	18	39.75	23	274	44
		68HT9618-2W	8421	95	18	39.75	23	293	47
		68HT10218-2W	8889	101	18	39.75	23	311	50
		68HT11018-2W	9589	109	18	39.75	23	336	54

**ORDERING NOTES:**

Hinged door hutches include factory installed tasklights and tackboard. "TH" column above represents the clearance height for the tackboard. Hutches over 84" in length will be made in two pieces. Hutches are inset 3/4" on each side when sitting on the worksurface. Locks are available on wood door hutches at **\$152 list per (2) doors**. Please specify at time of order.

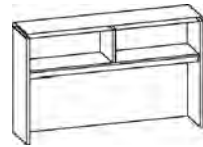
	Hutch, Open	68HTO3615	2437	35.25	15	39.75	23	137	15
		68HTO4215	2764	41	15	39.75	23	146	18
		68HTO4815	3087	47	15	39.75	23	155	20
		68HTO5415	3239	53	15	39.75	23	164	22
		68HTO6015	3479	58.75	15	39.75	23	173	25
		68HTO6615*	3847	64.75	15	39.75	23	192	28
		68HTO7115	4251	70	15	39.75	23	181	30
		68HTO7815	4435	77	15	39.75	23	190	32
		68HTO8415	4615	83	15	39.75	23	199	35
		68HTO9018-2	5980	89	18	39.75	23	254	44
		68HTO9618-2	6762	95	18	39.75	23	273	47
		68HTO10218-2	7386	101	18	39.75	23	291	50

**ORDERING PROCEDURE**

To order, please specify the following:

- 1) Krug product model number
- 2) Wood species and finish, see page 247
- 3) Wood edge detail- I, H, L or P, see page 250
- 4) Pull style, see page 250
- 5) Grommet location if applicable

\*Indicates model illustrated by line drawing.

**CODE DESCRIPTION**

W - includes power/data/voice grommet in tackboard  
 -2 - Hutches over 84" in length will be made in two pieces.

**STANDARD FINISHES**

For a complete list of standard wood finishes please see page 247.

**INSIDE FINISHED BACKS**

Optional inside finished backs are available up to a maximum of 84" hutches at the standard list price. This option does not include the tackboard.

MILLENNIUM | HUTCHES

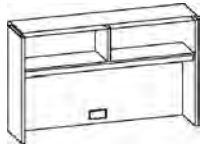
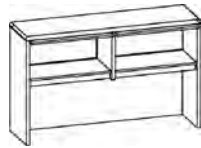
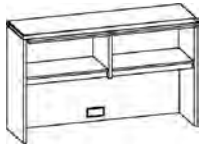
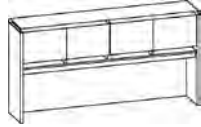
Description	Model	Cherry		W	D	H	TH	Shipping Weight	Cubic Feet
		Walnut	Maple						
 Hutch, Open & Power/ Data/Voice Grommet	68HTO3615W	2654		35.25	18	39.75	23	137	15
	68HTO4215W	2959		41	15	39.75	23	146	18
	68HTO4815W	3273		47	15	39.75	23	155	20
	68HTO5415W	3446		53	15	39.75	23	164	22
	68HTO6015W	3683		58.75	15	39.75	23	173	25
	68HTO6615W*	4047		64.75	15	39.75	23	192	28
	68HTO7115W	4478		70	15	39.75	23	181	30
	68HTO7815W	4622		77	15	39.75	23	190	32
	68HTO8415W	4799		83	15	39.75	23	199	35
	68HTO9018-2W	6246		89	18	39.75	23	254	44
	68HTO9618-2W	7022		95	18	39.75	23	254	47
	68HTO10218-2W	7655		101	18	39.75	23	291	50
 Hutch, Flipper Doors	68HTF3618	2555		35.25	18	39.75	22	158	15
	68HTF4218	2863		41	18	39.75	22	167	18
	68HTF4818	3299		47	18	39.75	22	176	20
	68HTF5418	3617		53	18	39.75	22	185	23
	68HTF6018	4237		58.75	18	39.75	22	194	25
	68HTF6618*	4555		64.75	18	39.75	22	203	27
	68HTF7118	5272		70	18	39.75	22	212	30
	68HTF7818	5644		77	18	39.75	22	221	33
	68HTF8418	6090		83	18	39.75	22	230	35
	68HTF9018	7754		89	18	39.75	22	239	44
 Hutch, Flipper Doors & Power/Data/Voice Grommet	68HTF3618W	2751		35.25	18	39.75	22	158	15
	68HTF4218W	3088		41	18	39.75	22	167	18
	68HTF4818W	3490		47	18	39.75	22	176	20
	68HTF5418W	3804		53	18	39.75	22	185	23
	68HTF6018W	4456		58.75	18	39.75	22	194	25
	68HTF6618W*	4777		64.75	18	39.75	22	203	27
	68HTF7118W	5471		70	18	39.75	22	212	30
	68HTF7818W	5814		77	18	39.75	22	221	33
	68HTF8418W	6258		83	18	39.75	22	230	35
	68HTF9018W	7949		89	18	39.75	22	239	44
 Hutch, Paper Management	68HTPM6015	5053		58.75	15	39.75	19.75	204	25
	68HTPM6615	5196		64.75	15	39.75	19.75	214	27
	68HTPM7115	5380		70	15	39.75	19.75	232	30
	68HTPM7815*	5771		77	15	39.75	19.75	241	33
	68HTPM8415	6184		83	15	39.75	19.75	250	35
	68HTPM9618-2	10222		95	18	39.75	19.75	300	35
	68HTPM10218-2	10872		101	18	39.75	19.75	320	35
68HTPM11018-2	11647		109	18	39.75	19.75	340	35	

**ORDERING NOTES:**

All hutches include factory installed tasklights and tackboard. "TH" column above represents the clearance height for the tackboard. Hutches over 84" in length will be made in two pieces. Hutches are inset 3/4" on each side when sitting on the worksurface.

**DIMENSION KEY**

W - width  
D - depth  
H - height

**CODE DESCRIPTION**

G - wood framed clear glass doors  
OF- flipper door  
OH- hinged door  
OO- open, no doors  
W - includes power/data/voice grommet in tackboard  
PM- paper manager  
PS- paper shelf

**STANDARD FINISHES**

For a complete list of standard wood finishes please see page 247.

**TACKBOARD FABRIC OPTIONS**

See page 297 for tackboard fabric options and grading information.

# MILLENNIUM | HUTCHES

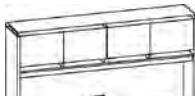
Description	Model	Cherry		W	D	H	TH	Shipping Weight	Cubic Feet
		Walnut	Maple						
 Hutch, Paper Management with Power/Data/Voice Grommet	68HTPM6015W	5219		58.75	15	39.75	19.75	204	25
	68HTPM6615W	5411		64.75	15	39.75	19.75	214	27
	68HTPM7115W	5563		70	15	39.75	19.75	232	30
	68HTPM7815W*	5982		77	15	39.75	19.75	241	33
	68HTPM8415W	6370		83	15	39.75	19.75	250	35
	68HTPM9618-2W	10410		95	18	39.75	19.75	300	35
	68HTPM10218-2W	11082		101	18	39.75	19.75	320	35
	68HTPM11018-2W	11857		109	18	39.75	19.75	340	35

**ORDERING NOTES:**

Hutches include factory installed tasklights and tackboard. "TH" column above represents the clearance height for the tackboard.

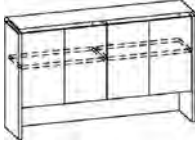
 Bookcase Hutch, Hinged Doors	68HTBC3615**	2763		35.25	15	39.75	11.5	167	15
	68HTBC4215	3126		41	15	39.75	11.5	176	18
	68HTBC4815	3491		47	15	39.75	11.5	185	22
	68HTBC5415	3662		53	15	39.75	11.5	194	25
	68HTBC6015	3859		58.75	15	39.75	11.5	203	25
	68HTBC6615*	4343		64.75	15	39.75	11.5	212	27
	68HTBC7115	4795		70	15	39.75	11.5	221	30
	68HTBC7815	5319		77	15	39.75	11.5	230	34
	68HTBC8415	5885		83	15	39.75	11.5	248	37

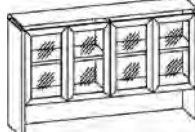
 Bookcase Hutch, Hinged Glass Doors	68HTBC3615G**	2899		35.25	15	39.75	11.5	117	15
	68HTBC4215G	3277		41	15	39.75	11.5	176	18
	68HTBC4815G	3668		47	15	39.75	11.5	185	22
	68HTBC5415G	3881		53	15	39.75	11.5	194	25
	68HTBC6015G	4093		58.75	15	39.75	11.5	203	25
	68HTBC6615G*	4567		64.75	15	39.75	11.5	212	27
	68HTBC7115G	5047		70	15	39.75	11.5	221	30
	68HTBC7815G	5604		77	15	39.75	11.5	230	34
	68HTBC8415G	6181		83	15	39.75	11.5	248	37

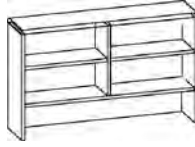
 Bookcase Hutch, Open	68HTBCO3615**	2304		35.25	15	39.75	11.5	157	15
	68HTBCO4215	2650		41	15	39.75	11.5	166	18
	68HTBCO4815	2989		47	15	39.75	11.5	175	20
	68HTBCO5415	3052		53	15	39.75	11.5	184	23
	68HTBCO6015	3117		58.75	15	39.75	11.5	183	25
	68HTBCO6615*	3568		64.75	15	39.75	11.5	192	27
	68HTBCO7115	4020		70	15	39.75	11.5	201	30
	68HTBCO7815	4477		77	15	39.75	11.5	210	33
	68HTBCO8415	4981		73	15	39.75	11.5	219	35

**ORDERING NOTES:**

Bookcase hutches include a finished back panel. Bookcase hutches cannot accept tackboards or tasklights. Hutches over 84" in length will be made in two pieces. Hutches are inset 3/4" on each side when sitting on the worksurface.

**ORDERING PROCEDURE**

To order, please specify the following:

- 1) Krug product model number
- 2) Wood species and finish, see page 247
- 3) Wood edge detail- I, H, L or P, see page 250
- 4) Pull style, see page 250
- 5) Grommet location if applicable

\*Indicates model illustrated by line drawing.

**CODE DESCRIPTION**

G - wood framed clear glass doors  
 W - includes power/data/voice grommet in tackboard  
 -2 - Hutches over 84" in length will be made in two pieces.

**STANDARD FINISHES**

For a complete list of standard wood finishes please see page 247.

**INSIDE FINISHED BACKS**

Optional inside finished backs are available up to a maximum of 84" hutches at the standard list price. This option does not include the tackboard.

MILLENNIUM | HUTCHES

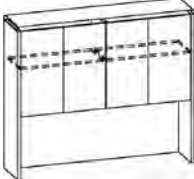
Description	Model	Cherry Walnut Maple	W	D	H	TH	Shipping Weight	Cubic Feet
	68HT601555	4771	58.75	15	55.5	23	260	25
	68HT661555*	5300	64.75	15	55.5	23	273	27
	68HT711555	6067	70	15	55.5	23	281	30
	68HT781555	6531	77	15	55.5	23	290	32
	68HT841555	6989	83	15	55.5	23	299	35

	68HT601555W	4957	58.75	15	55.5	23	260	25
	68HT661555W*	5483	64.75	15	55.5	23	273	27
	68HT711555W	6295	70	15	55.5	23	281	30
	68HT781555W	6760	77	15	55.5	23	290	32
	68HT841555W	7193	83	15	55.5	23	299	35

	68HT601555G	5056	58.75	15	55.5	23	176	25
	68HT661555G*	5617	64.75	15	55.5	23	188	27
	68HT711555G	6427	70	15	55.5	23	199	30
	68HT781555G	6915	77	15	55.5	23	212	32
	68HT841555G	7408	83	15	55.5	23	232	35

**ORDERING NOTES:**

Hinged door hutches include factory installed tasklights and tackboard. Hutches over 84" in length will be made in two pieces. Hutches are inset 3/4" on each side when sitting on the worksurface. Locks are available on wood door hutches at **\$152 list per (2) doors**. Please specify at time of order.

	68HTPD8418	6240	83	18	39.75	23	290	41
	68HTPD9018-2*	8130	89	18	39.75	23	305	44
	68HTPD9618-2	8704	95	18	39.75	23	320	47
	68HTPD11018-2	9957	109	18	39.75	23	350	51

**ORDERING NOTES:**

Pier door hutches include factory installed tasklights and a tackboard. "TH" column above represents the clearance height for the tackboard. Hutches over 84" in length will be made in two pieces. Hutches are inset 3/4" on each side when sitting on the worksurface.

**DIMENSION KEY**

W - width  
D - depth  
H - height

**CODE DESCRIPTION**

G - wood framed clear glass doors  
W - includes power/data/voice grommet in tackboard  
-2 - Hutches over 84" in length will be made in two pieces

**STANDARD FINISHES**

For a complete list of standard wood finishes please see page 247.

**TACKBOARD FABRIC OPTIONS**

See page 297 for hutch fabric grade upcharges.

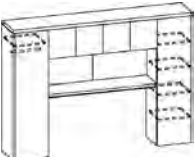

# MILLENNIUM | HUTCHES

Description	Model	Cherry Walnut Maple			W	D	H	Shipping Weight	Cubic Feet
	68WU9618LWRB*	10626			95.75	24.25	68	665	60
	68WU9618LBRW	10626			95.75	24.25	68	665	60
	68WU10818LWRB	11334			108	24.25	68	705	70
	68WU10818LBRW	11334			108	24.25	68	705	70

Paper Manager	68PM18132001	1695			17	12.5	19.75	50	3
---------------	--------------	------	--	--	----	------	-------	----	---



Paper Manager	68PM18122002	1373			17	12	19.75	50	3
---------------	--------------	------	--	--	----	----	-------	----	---



Paper Manager	68PM18122003	1373			17	12	19.75	50	3
---------------	--------------	------	--	--	----	----	-------	----	---



### ORDERING PROCEDURE

To order, please specify the following:

- 1) Krug product model number
- 2) Wood species and finish, see page 247
- 3) Wood edge detail- I,H, L or P, see page 250
- 4) Pull style, see page 250
- 5) Grommet location if applicable

\*Indicates model illustrated by line drawing.

### CODE DESCRIPTION

W - includes power/data/voice grommet in tackboard  
 L/RW - left or right wardrobe  
 L/RB - left or right bookcase storage

### STANDARD FINISHES

For a complete list of standard wood finishes please see page 247.

# MILLENNIUM | HUTCH TACKBOARDS

Tackboard upcharges for hutches and wall units. Use this chart to find the upcharge for tackboard fabrics graded 2–9 and add it to the cost of the hutch or wall unit.

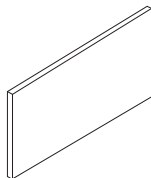

	FABRIC GRADES								
	2	3	4	5	6	7	8	9	com
36" hutch tackboard	164	352	513	686	848	1011	1173	1428	1.5
42" hutch tackboard	164	352	513	686	848	1011	1173	1428	1.5
48" hutch tackboard	164	352	513	686	848	1011	1173	1428	1.75
54" hutch tackboard	164	352	513	686	848	1011	1173	1428	1.75
60" hutch tackboard	164	352	513	686	848	1011	1173	1428	2
66" hutch tackboard	185	397	582	778	961	1146	1331	1654	2.25
71" hutch tackboard	223	471	693	929	1151	1373	1593	1920	2
78" hutch tackboard	265	555	821	1088	1356	1617	1880	2584	2
84" hutch tackboard	309	642	954	1262	1569	1875	2184	2584	2.5
90" hutch tackboard	348	722	1068	1415	1761	2107	2451	2846	2.75
96" hutch tackboard	382	793	1177	1556	1935	2322	2694	3129	3
102" hutch tackboard	420	871	1297	1714	2130	2549	2965	3399	3
110" hutch tackboard	458	960	1177	1884	2343	2802	3260	3732	3.25
84" pier door hutch tackboard	164	352	513	686	848	1011	1173	1428	2
90" pier door hutch tackboard	164	352	513	686	848	1011	1173	1428	2.25
96" pier door hutch tackboard	164	352	513	686	837	1011	1173	1428	2.5
110" pier door hutch tackboard	259	556	816	1083	1340	1603	1603	2191	2.75
96" wall unit tackboard	164	352	513	686	848	1011	1011	1428	2.5
108" wall unit tackboard	259	556	816	1083	1340	1603	1603	2191	2.5

On single piece hutches, the yardage requirement for two tackboards is the same as for one tackboard. Please keep this in mind when ordering more than one tackboard. For example, if the number of tackboards required is 7 and the COM requirement for 1 tackboard is 1.5 yards, the calculation for COM yardage is as follows: 4.5 yards are required for 6 tackboards + 1.5 yards for the 7th tackboard for a total of 6 yards. In the case of an even number of tackboards, divide the number of tackboards required by 2 and multiply that number by COM requirement on the chart. The fabric must be at least 54" wide in order to qualify for this procedure. If the fabric is less than 54" wide, the COM yardage listed on the chart is the amount required for each tackboard.

### COM Yardage Calculation Chart for Tackboards

Quantity of Tackboards Required (example: 60")	Number of Yards Required per Tackboard (example: 60")	Number of Yards Required in Total (example: 60")
one	2 yards	2
two	2 yards	2
three	2 yards	4
four	2 yards	4
fiv	2 yards	6
six	2 yards	6
seven	2 yards	8
eight	2 yards	8

#### DIMENSION KEY

W - width  
D - depth  
H - height

#### STANDARD FINISHES

For a complete list of standard wood finishes please see page 247.

# MILLENNIUM | SHELLS

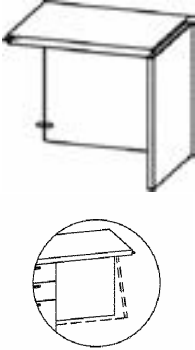
Description	Model	Cherry		W	D	H	KW	Shipping Weight	Cubic Feet
		Walnut	Maple						
Open Return, Desk Height	68RH2420L	1914		23.75	20.25	28.5	22	46	13
	68RH2420R	1914		23.75	20.25	28.5	22	46	13
	68RH2424L	1953		23.75	24.25	28.5	22	55	15
	68RH2424R	1953		23.75	24.25	28.5	22	55	15
	68RH3020L	2017		30	20.25	28.5	28.13	58	15
	68RH3020R	2017		30	20.25	28.5	28.13	58	15
	68RH3024L*	2053		30	24.25	28.5	28.13	70	17
	68RH3024R	2053		30	24.25	28.5	28.13	70	17
	68RH3620L	2122		36	20.25	28.5	34.13	69	17
	68RH3620R	2122		36	20.25	28.5	34.13	69	17
	68RH3624L	2157		36	24.25	28.5	34.13	83	20
	68RH3624R	2157		36	24.25	28.5	34.13	83	20
	68RH3630L	2184		36	30.25	28.5	34.13	104	22
	68RH3630R	2184		36	30.25	28.5	34.13	104	22
	68RH4220L	2219		42	20.25	28.5	40.13	81	20
	68RH4220R	2219		42	20.25	28.5	40.13	81	20
	68RH4224L	2274		42	24.25	28.5	40.13	97	22
	68RH4224R	2274		42	24.25	28.5	40.13	97	22
	68RH4230L	2302		42	30.25	28.5	40.13	122	24
	68RH4230R	2302		42	30.25	28.5	40.13	122	24
	68RH4820L	2326		48	20.25	28.5	46.13	93	22
	68RH4820R	2326		48	20.25	28.5	46.13	93	22
	68RH4824L	2383		48	24.25	28.5	46.13	112	24
	68RH4824R	2383		48	24.25	28.5	46.13	112	24
	68RH4830L	2390		48	30.25	28.5	46.13	140	26
	68RH4830R	2390		48	30.25	28.5	46.13	140	26
	68RH5420L	2420		54	20.25	28.5	52.13	105	24
	68RH5420R	2420		54	20.25	28.5	52.13	105	24
	68RH5424L	2457		54	24.25	28.5	52.13	126	26
	68RH5424R	2457		54	24.25	28.5	52.13	126	26
	68RH5430L	2459		54	30.25	28.5	52.13	158	30
	68RH5430R	2459		54	30.25	28.5	52.13	158	30
	68RH6020L	2473		60	20.25	28.5	58.38	115	26
	68RH6020R	2473		60	20.25	28.5	58.38	115	26
68RH6024L	2526		60	24.25	28.5	58.38	138	30	
68RH6024R	2526		60	24.25	28.5	58.38	138	30	
68RH6030L	2559		60	30.25	28.5	58.38	173	33	
68RH6030R	2559		60	30.25	28.5	58.38	173	33	
68RH6620L	2576		65.75	20.25	28.5	63.88	126	30	
68RH6620R	2576		65.75	20.25	28.5	63.88	126	30	
68RH6624L	2631		65.75	24.25	28.5	63.88	152	33	
68RH6624R	2631		65.75	24.25	28.5	63.88	152	33	
68RH6630L	2657		65.75	30.25	28.5	63.88	191	36	
68RH6630R	2657		65.75	30.25	28.5	63.88	191	36	
68RH7120L	2686		71	20.25	28.5	69.13	136	33	
68RH7120R	2686		71	20.25	28.5	69.13	136	33	
68RH7124L	2726		71	24.25	28.5	69.13	163	36	
68RH7124R	2726		71	24.25	28.5	69.13	163	36	
68RH7130L	2745		71	30.25	28.5	69.13	204	38	
68RH7130R	2745		71	30.25	28.5	69.13	204	38	

**ORDERING NOTES:**

Please see page 256 for wire management cut-out option. Please see page 256 for hinged modesty panel option. For Universal Return Shells replace RH with RHU. Grommets are not available on Universal Return shells.

**ORDERING PROCEDURE**

To order, please specify the following:

- 1) Krug product model number
- 2) Wood species and finish, see page 247
- 3) Wood edge detail- I,H, L or P, see page 250
- 4) Pull style, see page 250
- 5) Grommet location if applicable

**CODE DESCRIPTION**

L - left hand runoff  
R - right hand runoff

**STANDARD FINISHES**

For a complete list of standard wood finishes please see page 247.

**MODESTY PANELS**

Open returns are available with 9", 1/2" or 3/4" modesty panels at no upcharge. Please specify at time of order.

**PEDESTALS**

Pedestals for use with open shells can be found on page 316.

MILLENNIUM | SHELLS

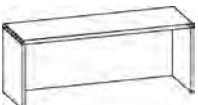
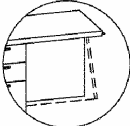
Description	Model	Cherry Walnut Maple	W	D	H	KW	Shipping Weight	Cubic Feet	
	Open Return, Desk Height continued	68RH8420L	2776	84	20.25	28.5	82.13	163	36
		68RH8420R	2776	84	20.25	28.5	82.13	163	36
		68RH8424L	2805	84	24.25	28.5	82.13	196	38
		68RH8424R	2805	84	24.25	28.5	82.13	196	38
		68RH8430L	2837	84	30.25	28.5	82.13	245	45
		68RH8430R	2837	84	30.25	28.5	82.13	245	45
		68RH9024L	2844	90	24.25	28.5	88.13	210	45
		68RH9024R	2844	90	24.25	28.5	88.13	210	45
		68RH9030L	2893	90	30.25	28.5	88.13	247	49
		68RH9030R	2893	90	30.25	28.5	88.13	247	49
		68RH9624L	2947	96	24.25	28.5	93.88	221	49
		68RH9624R	2947	96	24.25	28.5	93.88	221	49
		68RH9630L	2999	96	30.25	28.5	93.88	249	52
		68RH9630R	2999	96	30.25	28.5	93.88	249	52
		68RH10220L	3095	102	20.25	28.5	100.25	195	49
		68RH10220R	3095	102	20.25	28.5	100.25	195	49
	 	Open Shell, Accepts Shallow Pedestals	68S3020	2220	30	20.25	28.5	27	61
		68S3024	2252	30	24.25	28.5	27	73	15
		68S3620	2278	36.25	20.25	28.5	33.25	73	15
		68S3624	2297	36.25	24.25	28.5	33.25	88	18
		68S4220	2313	42	20.25	28.5	39	86	17
		68S4224	2343	42	24.25	28.5	39	103	21
		68S4820	2366	48	20.25	28.5	45	98	20
		68S4824	2394	48	24.25	28.5	45	118	23
		68S5020	2412	50	20.25	28.5	47	102	22
		68S5024	2440	50	24.25	28.5	47	122	24
		68S5420	2463	54	20.25	28.5	51	110	22
		68S5424	2479	54	24.25	28.5	51	132	26
		68S6020	2552	60	20.25	28.5	56.75	122	24
		68S6024	2614	60	24.25	28.5	56.75	146	29
		68S6320	2646	63.5	20.25	28.5	60.5	128	25
		68S6324	2684	63.5	24.25	28.5	60.5	153	30
		68S6620	2723	65.75	20.25	28.5	62.75	122	27
		68S6624	2816	65.75	24.25	28.5	62.75	146	32
		68S7120	2946	71	20.25	28.5	68	131	29
		68S7124*	3042	71	24.25	28.5	68	157	34
		68S7420	3113	74.25	20.25	28.5	71.25	134	30
		68S7424	3231	74.25	24.25	28.5	71.25	161	35
		68S7820	3308	78	20.25	28.5	75	141	32
		68S7824	3382	78	24.25	28.5	75	189	37
		68S8420	3405	82.75	20.25	28.5	81	159	34
		68S8424	3456	82.75	24.25	28.5	81	190	40
		68S9020	3607	90	20.25	28.5	87	170	36
		68S9024	3647	90	24.25	28.5	87	204	43
		68S9320	3683	93.5	20.25	28.5	90.75	176	39
		68S9324	3715	93.5	24.25	28.5	90.75	212	45
		68S9620	3752	95.75	20.25	28.5	93	181	43
		68S9624	3814	95.75	24.25	28.5	93	217	49
		68S10220	3890	102	20.25	28.5	99.25	184	51
	68S10224	3949	102	24.25	28.5	99.25	221	55	
	68S11020	4009	109.75	20.25	28.5	106.75	199	54	
	68S11024	4119	109.75	24.25	28.5	106.75	239	60	

**ORDERING NOTES:**

The pencil drawer can not be used in the 20" deep knee hole credenzas and/or shells. Please see page 256 for wire management cut-out option. Please see page 256 for hinged modesty panel option.

**DIMENSION KEY**

W - width  
D - depth  
H - height

**CODE DESCRIPTION**

L - left hand runoff  
R - right hand runoff

**STANDARD FINISHES**

For a complete list of standard wood finishes please see page 247.

**PEDESTALS**

Pedestals for use with open shells can be found on page 316.

**HALF GABLE**

Half gable at connecting end of open return is standard at sizes greater than 54" in length.

# MILLENNIUM | SHELLS

Description	Model	Cherry		W	D	H	KW	Shipping Weight	Cubic Feet
		Walnut	Maple						
Half Gable	68HG2710*	443		10	27	27		11	1
	68HG2716	507		16	27	27		16	1



**ORDERING NOTES:**

This unit should be ordered to center-support open spans greater than 60". Use 68HG2710 with 20" & 24" deep cases and 68HG2716 with 30" deep cases.

Open Shell, Accepts Deep Pedestals	Model			W	D	H	KW	Shipping Weight	Cubic Feet
		Cherry	Walnut						
	68S3630	2412		36.25	30.25	28.5	33.5	110	21
	68S4230	2533		42	30.25	28.5	39.25	129	25
	68S4830	2629		48	30.25	28.5	44.75	147	29
	68S6030	2734		63.5	30.25	28.5	56.75	182	36
	68S6630	2838		65.75	30.25	28.5	62.75	200	39
	68S6636	2970		65.75	36.25	28.5	62.75	240	46
	68S7130	3127		71	30.25	28.5	68	215	42
	68S7136*	3277		71	36.25	28.5	68	255	50
	68S8430	3441		82.75	30.25	28.5	81	342	50
	68S8436	3669		84	36.25	28.5	81	285	59
	68S9030	3829		90	30.25	28.5	87	255	53
	68S9630	4061		93.5	30.25	28.5	92.75	272	56
	68S10230	4291		102	30.25	28.5	99.25	276	60

**ORDERING NOTES:**

The pencil drawer can not be used in the 20" deep knee hole credenzas and/or shells. Please see page 256 for wire management cut-out option. Please see page 256 for hinged modesty panel option.

Corner Credenza Shell	Model			W	D	H	KW	Shipping Weight	Cubic Feet
		Cherry	Walnut						
	68CC6624L	3222		65.75	36.25	28.5		180	45
	68CC6624R	3222		65.75	36.25	28.5		180	45
	68CC7124L	3263		71	36.25	28.5		190	50
	68CC7124R	3263		71	36.25	28.5		190	50
	68CC7824L	3304		78	36.25	28.5		200	55
	68CC7824R*	3304		78	36.25	28.5		200	55
	68CC8424L	3339		82.75	36.25	28.5		210	59
	68CC8424R	3339		82.75	36.25	28.5		210	59

Corner Return Shell	Model			W	D	H	KW	Shipping Weight	Cubic Feet
		Cherry	Walnut						
	68CR7124L*	3211		71	24.25	28.5		190	55
	68CR7124R	3211		71	24.25	28.5		190	55
	68CR8424L	3263		84	24.25	28.5		210	59
	68CR8424R	3263		84	24.25	28.5		210	59

**ORDERING NOTES:**

Corner Returns are designated left or right by the location of it's connection to a primary work surface. For a curved corner version of this products, please add 5% to above list price and add an extra C to the model number prefix i.e. 68CCC7124L

**ORDERING PROCEDURE**

To order, please specify the following:

- 1) Krug product model number
- 2) Wood species and finish, see page 247
- 3) Wood edge detail- I,H, L or P, see page 250
- 4) Pull style, see page 250
- 5) Grommet location if applicable

\*Indicates model illustrated by line drawing.

**CODE DESCRIPTION**

- L - left hand runoff
- R - right hand runoff

**STANDARD FINISHES**

For a complete list of standard wood finishes please see page 247.

**PEDESTALS**

Pedestals for use with open shells can be found on pages 316.

# MILLENNIUM | MOBILE TABLES

Description	Model	Cherry		W	D	H	Shipping Weight	Cubic Feet
		Walnut	Maple					
	68THC3020	2385		30	20.25	28.5	61	12
	68THC3024	2406		30	24.25	28.5	73	15
	68THC3620	2417		36.25	20.25	28.5	73	15
	68THC3624	2440		36.25	24.25	28.5	88	18
	68THC4220	2461		42	20.25	28.5	86	18
	68THC4224	2453		42	24.25	28.5	103	21
	68THC4820	2480		48	20.25	28.5	98	21
	68THC4824*	2502		48	24.25	28.5	118	23

**ORDERING NOTES:**

Optional paper slot in "C" position at **\$172 list upcharge.**

	68PT3024	2613		30.25	24.25	28.5	76	15
	68PT3624*	2697		36.25	24.25	28.5	103	18
	68PT3630	2780		36.25	30.25	28.5	103	22

**ORDERING NOTES:**

Optional paper slot in "C" position at **\$172 list upcharge.**

	68MTH36D	1609		36.25	36.25	28.5	69	6
	68MTH42D*	1618		42.25	42.25	28.5	75	8

**ORDERING NOTES:**

Casters optional for **\$172 list upcharge.**

	68MDTH32	1704		31.25	32	28.5	50	5
	68MDTH36	1720		35	35.75	28.5	57	6
	68MDTH42*	1731		41	41.75	28.5	71	8

	68MATH3030	1594		30.25	30.25	28.5	60	4.5
	68MATH3636	1609		36.25	36.25	28.5	75	6
	68MATH4242*	1618		42.25	42.25	28.5	90	8

	68MTH3030	1594		30.25	30.25	28.5	65	4.5
	68MTH3636	1609		36.25	36.25	28.5	80	6
	68MTH4242*	1618		42.25	42.25	28.5	97	8

**DIMENSION KEY**

W - width  
D - depth  
H - height

**STANDARD FINISHES**

For a complete list of standard wood finishes please see page 247.

**HALF GABLE**

Half gable at connecting end of open return is standard at sizes greater than 54" in length.

# MILLENNIUM | ACCESSORIES

Description	Model	Price	W	D	H	Shipping Weight	Cubic Feet
 Tackboard Organizer Rail	68AOB36HT	100	31	-	2.5	-	-
	68AOB42HT	100	37	-	2.5	-	-
	68AOB48HT	100	43	-	2.5	-	-
	68AOB54HT	100	49	-	2.5	-	-
	68AOB60HT	100	55	-	2.5	-	-
	68AOB66HT	100	61	-	2.5	-	-
	68AOB71HT	100	66	-	2.5	-	-
	68AOB78HT	100	73	-	2.5	-	-
	68AOB84HT	100	79	-	2.5	-	-
	68AOB90HT	100	85	-	2.5	-	-
	68AOB96HT	100	91	-	2.5	-	-
	68AOB102HT	100	97	-	2.5	-	-
68AOB110HT	100	105	-	2.5	-	-	

Paper Tray	68APT	100	12	10.75	2	1.75	0.5
------------	-------	-----	----	-------	---	------	-----



Binder Bin	68ABB	140	10	4	10	3	0.5
------------	-------	-----	----	---	----	---	-----

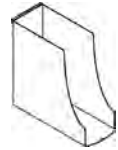

File Organizer	68AFO	114	6	9.75	2.5	1.75	0.5
----------------	-------	-----	---	------	-----	------	-----

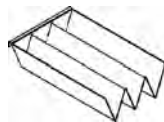

**ORDERING NOTES:**

This accessory can not be specified in combination with Paper Management Hutches due to space requirements.

Hanging File Bars	68AFB	114	1.75	7.5	0.75	0.5	0.25
-------------------	-------	-----	------	-----	------	-----	------



**ORDERING PROCEDURE**

To order, please specify the following:

- 1) Krug product model number
- 2) Wood species and finish, see page 247
- 3) Wood edge detail- I,H, L or P, see page 250
- 4) Pull style, see page 250
- 5) Grommet location if applicable

\*Indicates model illustrated by line drawing.

**CODE DESCRIPTION**

APT - paper tray  
 ABB - binder bin  
 AFO - file organizer  
 AFB - file bar  
 The metal finish on perforated metal modesty panels, tapered brushed aluminum post legs, metal accent option on hutches, tack-board organizer rail, accessories and hinge caps on frameless glass doors match the Millennium satin nickel pull finish.

**STANDARD FINISHES**

For a complete list of standard wood finishes please see page 247.

**ACCESSORIES**

Accessories feature a brushed aluminum finish.

**TACKBOARD ORGANIZER RAIL**

Please specify clearly on purchase order which products are to receive Organizer Rail and Accessory options.

# POWERPORTS

Description	Model	Price	W	D	H	Shipping Weight	Cubic Feet
PowerPort 1 - 2 RJ45s (Category 5/6)	PORT1	278	8	4	-	-	-

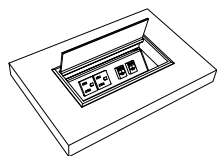

**Port Includes:** 2 accessible power outlets & 1 side utility outlet powered by a 10' plug-in cord; 2 RJ45 (category 5/6) each with hard wired 10' data cords; 2 velcro wire managers and metal PowerPort shroud. PortPort lid is Silver Metallic.  
**NOTE:** RJ45 jacks with hard wired data cords included here must be within 10' of building utilities source to be functional.

PowerPort 2 - USB-A & USB-C	PORT2	280	8	4	-	-	-
--------------------------------	-------	-----	---	---	---	---	---

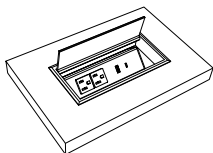

**Port Includes:** 2 accessible power outlets & 1 side utility outlet; 1 USB-A & 1 USB-C charging ports all powered by a 10' plug-in cord; 2 velcro wire managers and metal PowerPort shroud. PortPort lid is Silver Metallic.

PowerPort 3 - RJ11 & RJ45	PORT3	269	8	4	-	-	-
------------------------------	-------	-----	---	---	---	---	---

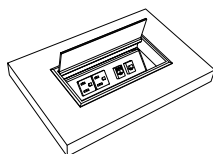

**Port Includes:** 2 accessible power outlets & 1 side utility outlet; 1 RJ11 & 1 RJ45 (Category 5/6); 2 Velcro wire managers & PowerPort Shroud; 1 x 10 Foot Data Cords (T568A) & 1 x 14 Foot RJ11 (Telecomm); powered by a 10' plug-in cord. PortPort lid is Silver Metallic.  
**NOTE:** RJ45 & RJ11 jacks with hard wired data cords included here must be within 10' of building utilities source to be functional.

PowerPort 4 - 2 USB-A	PORT4	286	8	4	-	-	-
--------------------------	-------	-----	---	---	---	---	---

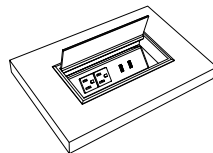

**Port Includes:** 2 accessible power outlets & 1 side utility outlet; 2- USB-A charging ports all powered by a 10' plug-in cord; 2 velcro wire managers and metal PortPort shroud. PortPort lid is Silver Metallic.

PowerPort 5 - 4 Receptacles	PORT5	280	8	4	-	-	-
--------------------------------	-------	-----	---	---	---	---	---

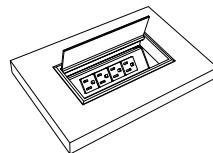

**Port Includes:** 4 accessible power outlets & 1 side utility outlet powered by a 10' plug-in cord; 2 velcro wire managers and metal power port shroud. PortPort lid is Silver Metallic.

PowerPort 6 - USB-A, USB-C & RJ45	PORT6	406	8	4	-	-	-
--------------------------------------	-------	-----	---	---	---	---	---

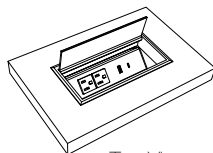

Top View

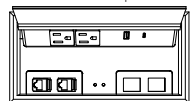

**Port Includes:** 2 accessible power outlets & 1 side utility outlet 1 USB-A, 1 USB-C charging ports all powered by a 10' plug-in power cord. Includes 2 velcro wire managers and metal PortPort shroud with 2 data plate knock outs, 1 #M02 plate insert & 2 #S01W RJ45 female input, punch down terminal output snap in jacks. 2nd data plate knock out is blank for future use. PortPort lid is Silver Metallic.



Description	Model	Price	W	D	H	Shipping Weight	Cubic Feet
Port - no Powerbar	Port0	137	8	4	-	-	-

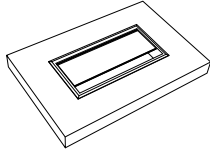

**Port Includes:** Port lid & Shroud only.

**ORDERING NOTE:** Velcro wire managers not included, see below for pricing. Port lid is Silver Metallic.

PowerPort Shroud with 2 Data Plate Knock-outs	SHROUD2KO	Must be requested - no upcharge	-	-	-	-	-
---	-----------	------------------------------------	---	---	---	---	---

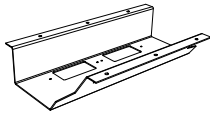

Angled PowerPort Shroud Includes: shroud with 2 data plate knock-outs in the bottom.

**ORDERING NOTE:** Please refer to data plate, data and AV integration options on page XX.

Velcro Wire Manager (qty 1)	WM-4	26	2	4.5	0.5	-	-
-----------------------------	------	----	---	-----	-----	---	---

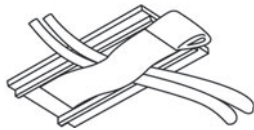

2 velcro wire managers are included with Ports 1-5.

Wire Management Trough	WM-72	182	72	3	1	-	-
------------------------	-------	-----	----	---	---	---	---



Wire Management Trough is standard in a 72" length & can be cut to specific length; double-sided tape installation.

4-Channel Wire Management	CM-72	231	72	3	1	-	-
---------------------------	-------	-----	----	---	---	---	---

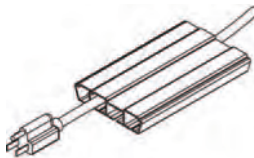



4-Channel Wire Management is standard in a 72" length & can be cut to specific length; double-sided tape installation.

Round Grommet	Round Grommet - Silver Metallic	152	-	-	-	-	-
	Round Grommet - Black	152	-	-	-	-	-

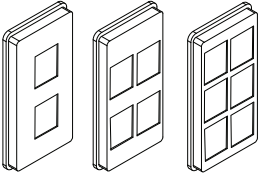

One 60mm Grommet in a standard position is available at no charge per table.

## POWER/DATA

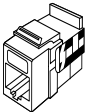
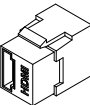
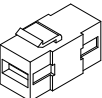
SNAP IN PORTS	Reference Code	Description	List Price
<b>ADAPTOR PLATES</b>			
	<b>M02</b>	<b>Adaptor Plate (2)</b> - accepts two snap in data ports	38
	<b>M04</b>	<b>Adaptor Plate (4)</b> - accepts four snap in data ports	38
	<b>M06</b>	<b>Adaptor Plate (6)</b> - accepts six snap in data ports	38
<b>ORDERING NOTES:</b> Blank covers are required when port is not in use, please see page 55.			
		<b>RJ-45</b> - Category 6 data connection. This connector is also downwards compatible with Category 5 cabling. Connector is a female input with a #110 punch-down terminal block output (back side of Console interface) for on-site hard wire connection.	47
	<b>S01W</b>	RJ45-CAT6 (White)	
	<b>S01B</b>	RJ45-CAT6 (Blue)	
	<b>S01R</b>	RJ45-CAT6 (Red)	
		<b>RJ11</b> - Telephone type connection. Connector is a female input with a #110 punch-down terminal block output (back side of Console interface) for on-site hard wire connection.	32
	<b>S02W</b>	RJ11 (White)	
	<b>S02B</b>	RJ11-B (Black)	
	<b>S02G</b>	RJ11-G (Green)	
	<b>S02R</b>	RJ11-R (Red)	
	<b>S02Y</b>	RJ11-Y (Yellow)	
	<b>S04</b>	<b>HDMI</b> - High Definition Multimedia Interface connection. Connector carries both HD audio and video data. Connector is a female-to-female pass through.	173
	<b>S08</b>	<b>USB-A</b> - Full size USB "A" style connection. Connector is a female-to-female pass through.	61

# MILLENNIUM | ACCESSORIES & ELECTRICAL

Description	Model	Cherry Walnut Maple			W	D	H	Shipping Weight	Cubic Feet
Wood Pencil Drawer	68PD2116	611	21.25	21.25	1	2	1		



**ORDERING NOTES:**

Millennium pencil drawer is available in Oak, Cherry, Maple or Walnut, please clearly mark P.O. with species and finish selection.

Articulating Keyboard	68KBA20	931	21	11	1	18	2
	68KBA30	1004	30	11	1	20	2

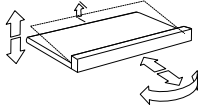

Articulating Keyboard w/ extended mechanism	68KBAC-2110	988	21	11	1	18	2
---	-------------	-----	----	----	---	----	---

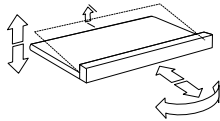

**ORDERING NOTES:**

This articulating keyboard is equipped with a deeper extension mechanism and should be used on corner units and corner credenzas.

Description	Model		W	D	H	Shipping Weight	Cubic Feet
Articulating Keyboard with Palm Rest & Mouse Tray	68KBMT1912	694	27	-	7	20	2



Height Adjustable Table Programmable Display- 4 Position Memory	88HAPD	376	-	-	-	-	-
---	--------	-----	---	---	---	---	---

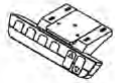

Silver Metallic Trough	68CT36	59	30	2	-	0.25	-
	68CT42	74	36	2	-	0.25	-
	68CT48	91	36	2	-	0.25	-
	68CT54	105	48	2	-	0.5	-
	68CT60	121	48	2	-	0.5	-
	68CT66	137	52	2	-	0.5	-
	68CT72	152	60	2	-	0.75	-
	68CT84	168	60	2	-	0.75	-

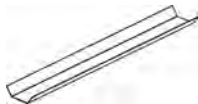



Height Adjustable Work Surface Cable Manager	68HACM1	89	4	3	21.5	5	0.25
--	---------	----	---	---	------	---	------



# MILLENNIUM | BOOKCASES

Description	Model	Cherry		W	D	H	Shipping Weight	Cubic Feet
		Walnut	Maple					
	68BC301529	2034		30	15	29.25	60	9
	68BC361529*	2086		35.25	15	29.25	70	11
	68BC481529	2295		48	15	29.25	90	14
	68BC601529	2504		60	15	29.25	110	17
	68BC711529	2744		71	15	29.25	130	20

	68BC301529-11G	2164		30	15	29.25	70	9
	68BC361529-11G*	2214		35.25	15	29.25	80	11

	68BC301543	2312		30	15	42.5	80	13
	68BC361543*	2356		35.25	15	42.5	90	15
	68BC481543	2596		48	15	42.5	110	17
	68BC601543	2851		60	15	42.5	130	21
	68BC711543	3135		71	15	42.5	150	25

	68BC301543-11G	2443		30	15	43	100	13
	68BC361543-11G*	2497		35.25	15	43	115	15

	68BCCE151543-17R	2720		15	15	43	55	7.5
	68BCCE151543-17L*	2720		15	15	43	55	7.5

**DIMENSION KEY**

W - width  
D - depth  
H - height

**CODE DESCRIPTION**

L - hinged left  
R - hinged right  
G - glass doors

**STANDARD FINISHES**

For a complete list of standard wood finishes please see page 247.





**SHELVES**

Shelves are adjustable in 1.25" increments.

**PULLS/LOCKS**

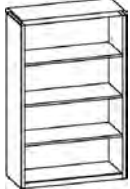
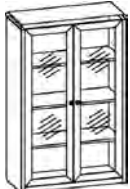
Wood door bookcases have pulls, glass door bookcases feature the Luna knob. Lateral file drawers include locks. Locks may be added to wood doors at an **upcharge of \$152 list.**

# MILLENNIUM | BOOKCASES

Description	Model	Cherry Walnut Maple	W	D	H	Shipping Weight	Cubic Feet
4-Hi Open Bookcase 	68BC301556	2595	30	15	56	100	13
	68BC361556*	2650	35.25	15	56	120	15
4-Hi Bookcase with Glass Doors 	68BC301556-11G	2740	30	15	56	125	13
	68BC361556-11G*	2807	35.25	15	56	148	15
5-Hi Open Bookcase 	68BC301569	2819	30	15	69	150	21
	68BC361569*	2874	35.25	15	69	180	24
5-Hi Bookcase with 3 Open & 2 Closed Shelves 	68BC301569-13	2959	30	15	69	160	21
	68BC361569-13*	3016	35.25	15	69	190	24
5-Hi Bookcase with 3 Library & 2 Closed Shelves 	68BC301569-43	3457	30	15	69	175	21
	68BC361569-43*	3473	35.25	15	69	205	24

## ORDERING PROCEDURE

To order, please specify the following:

- 1) Krug product model number
- 2) Wood species and finish, see page 247
- 3) Wood edge detail- I,H, L or P, see page 250
- 4) Pull style, see page 250
- 5) Grommet location if applicable

\*Indicates model illustrated by line drawing.

## STANDARD FINISHES

For a complete list of standard wood finishes please see page 247.

## PULLS/LOCKS

Wood door bookcases have pulls, glass door bookcases feature the Luna knob. Lateral file drawers include locks. Locks may be added to wood doors at an **upcharge of \$152 list.**

MILLENNIUM | BOOKCASES

Description	Model	Cherry Walnut Maple	W	D	H	Shipping	
						KW	Weight
6-Hi Open Bookcase	68BC301584	2954	30	15	84	180	26
	68BC361584*	3013	35.25	15	84	215	30



Description	Model	Cherry Walnut Maple	W	D	H	Shipping	
						KW	Weight
Curved Corner Storage	68STCE20202917L	2366	20.25	20.25	28.25	56	9
	68STCE20202917R	2366	20.25	20.25	28.25	56	9
	68STCE24242917L	2483	24.25	24.25	28.25	65	12.5
	68STCE24242917R*	2483	24.25	24.25	28.25	65	12.5
	68STCE20204217L	2694	20.25	20.25	40.5	64	13
	68STCE20204217R	2694	20.25	20.25	40.5	64	13
	68STCE24244217L	2812	24.25	24.25	40.5	75	17.5
	68STCE24244217R	2812	24.25	24.25	40.5	75	17.5
	68STCE20205417L	3070	20.25	20.25	54	117	17
	68STCE20205417R	3070	20.25	20.25	54	117	17
	68STCE24245417L	3209	24.25	24.25	54	126	23.5
	68STCE24245417R	3209	24.25	24.25	54	126	23.5
	68STCE20206817L	3509	20.25	20.25	68.25	130	21
	68STCE20206817R	3509	20.25	20.25	68.25	130	21
	68STCE24246817L	3663	24.25	24.25	68.25	138	29
	68STCE24246817R	3663	24.25	24.25	68.25	138	29
	68STCE20208417L	3948	20.25	20.25	82.25	150	25.5
	68STCE20208417R	3948	20.25	20.25	82.25	150	25.5
	68STCE24248417L	4130	24.25	24.25	82.25	159	35
	68STCE24248417R	4130	24.25	24.25	82.25	159	35

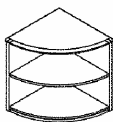

Description	Model	Cherry Walnut Maple	W	D	H	Shipping	
						KW	Weight
2 Lateral Files	68ST30202901	3642	30	20.25	28.5	129	13
	68ST30242901	3691	30	24.25	28.5	155	15
	68ST36202901	3780	36.25	20.25	28.5	151	15
	68ST36242901*	3831	36.25	24.25	28.5	181	18
	68ST42202901	3896	42	20.25	28.5	174	17
	68ST42242901	3952	42	24.25	28.5	205	21



Description	Model	Cherry Walnut Maple	W	D	H	Shipping	
						KW	Weight
2 Closed Shelves	68ST30202911	2785	30	20.25	28.5	94	13
	68ST30242911	2830	30	24.25	28.5	120	15
	68ST36202911	2877	36.25	20.25	28.5	116	15
	68ST36242911*	2929	36.25	24.25	28.5	146	18



**ORDERING NOTES:**

Shelf is adjustable in increments of approximately 1-1/4". Locks are available on all wood bookcase doors at \$152 list.

**DIMENSION KEY**

W - width  
D - depth  
H - height

**CODE DESCRIPTION**

L - hinged left  
R - hinged right

**STANDARD FINISHES**

For a complete list of standard wood finishes please see page 247.

**SHELVES**

Shelves are adjustable in 1.25" increments.

# MILLENNIUM | STORAGE

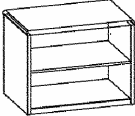
Description	Model	Cherry	W	D	H	Shipping Weight	Cubic Feet
		Walnut Maple					
	68ST30202917	1959	30	20.25	28.5	80	13
	68ST30242917	1997	30	24.25	28.5	100	15
	68ST36202917	2042	36.25	20.25	28.5	96	15
	68ST36242917*	2083	36.25	24.25	28.5	111	18

**ORDERING NOTES:**

Shelf is adjustable in increments of approximately 1-1/4".

Description	Model	Cherry	W	D	H	Shipping Weight	Cubic Feet
		Walnut Maple					
	68ST30204201	4512	30	20.25	41.75	164	18
	68ST30244201	4628	30	24.25	41.75	183	22
	68ST36204201	4759	36.25	20.25	41.75	196	21
	68ST36244201*	4860	36.25	24.25	41.75	218	25

Description	Model	Cherry	W	D	H	Shipping Weight	Cubic Feet
		Walnut Maple					
	68ST30204211	3122	30	20.25	41.75	134	15
	68ST30244211	3192	30	24.25	41.75	153	22
	68ST36204211	3279	36.25	20.25	41.75	166	21
	68ST36244211*	3290	36.25	24.25	41.75	188	25

**ORDERING NOTES:**

Both interior shelves are adjustable in increments of approximately 1-1/4". Locks are available on all wood bookcase doors at **\$152 list.**

Description	Model	Cherry	W	D	H	Shipping Weight	Cubic Feet
		Walnut Maple					
	68ST30204217	2800	30	20.25	41.75	114	18
	68ST30244217	2833	30	24.25	41.75	133	22
	68ST36204217	2896	36.25	20.25	41.75	146	21
	68ST36244217*	2944	36.25	24.25	41.75	168	25

**ORDERING NOTES:**

Shelf is adjustable in increments of approximately 1-1/4".

Description	Model	Cherry	W	D	H	Shipping Weight	Cubic Feet
		Walnut Maple					
	68ST30205401*	5189	30	20.25	54	220	23
	68ST30245401	5315	30	24.25	54	245	28
	68ST36205401	5525	36.25	20.25	54	245	26
	68ST36245401	5640	36.25	24.25	54	270	33

**ORDERING PROCEDURE**

To order, please specify the following:

- 1) Krug product model number
- 2) Wood species and finish, see page 247
- 3) Wood edge detail- I,H, L or P, see page 250
- 4) Pull style, see page 250
- 5) Grommet location if applicable

\*Indicates model illustrated by line drawing.

**CODE DESCRIPTION**

- L - hinged left
- R - hinged right

**STANDARD FINISHES**

For a complete list of standard wood finishes please see page 247.

MILLENNIUM | STORAGE

Description	Model	Cherry Walnut Maple	W	D	H	Shipping		Cubic Feet
						KW	Weight	
4-Hi 2 Lateral Files & 2 Closed Shelves	68ST30205404*	4352	30	20.25	54		210	23
	68ST30245404	4461	30	24.25	54		235	28
	68ST36205404	4608	36.25	20.25	54		235	26
	68ST36245404	4693	36.25	24.25	54		260	33



**ORDERING NOTES:**

Interior shelf is adjustable in increments of approximately 1-1/4". Locks are available on all wood bookcase doors at **\$152 list.**

4-Hi Closed Shelves	68ST30205411*	3682	30	20.25	54		185	23
	68ST30245411	3770	30	24.25	54		205	28
	68ST36205411	3849	36.25	20.25	54		205	26
	68ST36245411	3940	36.25	24.25	54		235	33



**ORDERING NOTES:**

Center shelf is fixed, upper and lower shelves are adjustable in increments of approximately 1-1/4". Locks are available on all wood bookcase doors at **\$152 list.**

4-Hi Open Shelves	68ST30205417*	3314	30	20.25	54		175	23
	68ST30245417	3403	30	24.25	54		195	28
	68ST36205417	3481	36.25	20.25	54		195	26
	68ST36245417	3560	36.25	24.25	54		205	33

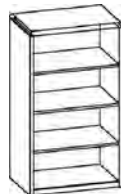

**ORDERING NOTES:**

Center shelf is fixed, upper and lower shelves are adjustable in increments of approximately 1-1/4".

5-Hi 4 Lateral Files & 1 Flip-Up Storage	68ST30206801*	6074	30	20.25	68		250	29
	68ST30246801	6478	30	24.25	68		300	35
	68ST36206801	6877	36.25	20.25	68		300	34
	68ST36246801	6962	36.25	24.25	68		360	40



5-Hi 2 Lateral Files, 2 Open Shelves & 1 Flip Up Door	68ST30206802*	5809	30	20.25	68		210	29
	68ST30246802	5844	30	24.25	68		220	35
	68ST36206802	5972	36.25	20.25	68		220	34
	68ST36246802	6045	36.25	24.25	68		230	40

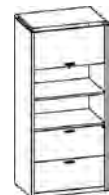

**ORDERING NOTES:**

Shelf is adjustable in increments of approximately 1-1/4".

**DIMENSION KEY**

W - width  
D - depth  
H - height

**CODE DESCRIPTION**

L - hinged left  
R - hinged right

**STANDARD FINISHES**

For a complete list of standard wood finishes please see page 247.



# MILLENNIUM | STORAGE

Description	Model	Cherry Walnut Maple			W	D	H	Shipping Weight	Cubic Feet
5-Hi 2 Lateral Files & 3 Open Shelves	68ST30206803*	5524	30	20.25	68.25	190	29		
	68ST30246803	5593	30	24.25	68.25	200	35		
	68ST36206803	5661	36.25	20.25	68.25	200	34		
	68ST36246803	5733	36.25	24.25	68.25	210	40		



5-Hi 2 Lateral Files & 3 Closed Shelves	68ST30206804*	6185	30	20.25	68.25	213	29
	68ST30246804	6246	30	24.25	68.25	255	35
	68ST36206804	6322	36.25	20.25	68.25	255	34
	68ST36246804	6394	36.25	24.25	68.25	306	40



**ORDERING NOTES:**

Open shelves are adjustable in increments of approximately 1-1/4".

5-Hi 4 Lateral Files & 1 Open Shelf	68ST30206805*	6793	30	20.25	68.25	240	29
	68ST30246805	6831	30	24.25	68.25	290	35
	68ST36206805	6945	36.25	20.25	68.25	290	34
	68ST36246805	7042	36.25	24.25	68.25	350	40



**ORDERING NOTES:**

Interior shelves are adjustable in increments of approximately 1-1/4". Locks are available on all wood bookcase doors at **\$152 list**.

5-Hi 3 Lateral Files & 2 Open Shelves	68ST30206806*	6720	30	20.25	68.25	188	29
	68ST30246806	6807	30	24.25	68.25	225	35
	68ST36206806	6881	36.25	20.25	68.25	225	34
	68ST36246806	6939	36.25	24.25	68.25	270	40



**ORDERING NOTES:**

Open shelf is adjustable in increments of approximately 1-1/4".

5-Hi 3 Lateral Files & 2 Closed Shelves	68ST30206808*	7041	30	20.25	68.25	220	29
	68ST30246808	7182	30	24.25	68.25	230	35
	68ST36206808	7331	36.25	20.25	68.25	230	34
	68ST36246808	7474	36.25	24.25	68.25	240	40



**ORDERING NOTES:**

Shelf is adjustable in increments of approximately 1-1/4". Locks are available on all wood bookcase doors at **\$152 list**.

**ORDERING PROCEDURE**

To order, please specify the following:

- 1) Krug product model number
- 2) Wood species and finish, see page 247
- 3) Wood edge detail- I,H, L or P, see page 250
- 4) Pull style, see page 250
- 5) Grommet location if applicable

\*Indicates model illustrated by line drawing.

**CODE DESCRIPTION**

- L - hinged left
- R - hinged right

**STANDARD FINISHES**

For a complete list of standard wood finishes please see page 247.

**PULLS/LOCKS**

Wood door bookcases have pulls, glass door bookcases feature the Luna knob. Lateral file drawers include locks. Locks may be added to wood doors at an upcharge of **\$152 list**.

MILLENNIUM | STORAGE

Description	Model	Cherry Walnut Maple			W	D	H	Shipping Cubic	
								Weight	Feet
 5 Closed Shelves	68ST30206811*	5091			30	20.25	68.25	220	29
	68ST30246811	5155			30	24.25	68.25	230	35
	68ST36206811	5231			36.25	20.25	68.25	230	34
	68ST36246811	5299			36.25	24.25	68.25	240	40

**ORDERING NOTES:**

Second lowest shelf is fixed, all others are adjustable in increments of approximately 1-1/4". Locks are available on all wood bookcase doors at **\$152 list.**

 5-Hi 2 Closed Shelves, 2 Open & 1 Flip Up Door	68ST30206812*	5398			30	20.25	68.25	215	29
	68ST30246812	5437			30	24.25	68.25	225	35
	68ST36206812	5483			36.25	20.25	68.25	225	34
	68ST36246812	5556			36.25	24.25	68.25	235	40

**ORDERING NOTES:**

Open and interior shelves are adjustable in increments of approximately 1-1/4". Locks are available on all wood bookcase doors at **\$152 list.**

 5-Hi 2 Closed, 3 Open Shelves	68ST30206813*	4634			30	20.25	68.25	210	29
	68ST30246813	4712			30	24.25	68.25	220	35
	68ST36206813	4795			36.25	20.25	68.25	220	34
	68ST36246813	4869			36.25	24.25	68.25	230	40

**ORDERING NOTES:**

Open and interior shelves are adjustable in increments of approximately 1-1/4". Locks are available on all wood bookcase doors at **\$152 list.**

 5 Open Shelves	68ST30206817*	4331			30	20.25	68.25	200	29
	68ST30246817	4415			30	24.25	68.25	210	35
	68ST36206817	4443			36.25	20.25	68.25	210	34
	68ST36246817	4544			36.25	24.25	68.25	220	40

**ORDERING NOTES:**

Second lowest shelf is fixed, all others are adjustable in increments of approximately 1-1/4".

 5-Hi 2 Lateral Files & 3 Closed Shelves with Pocket Doors	68ST30206827*	6703			30	20.25	68.25	241	29
	68ST30246827	6835			30	24.25	68.25	291	35
	68ST36206827	6978			36.25	20.25	68.25	291	34
	68ST36246827	7114			36.25	24.25	68.25	350	40

**ORDERING NOTES:**

Interior shelves are adjustable in increments of approximately 1-1/4". Locks are available on all wood doors at **\$152 list.**

**DIMENSION KEY**

W - width  
D - depth  
H - height

**CODE DESCRIPTION**

L - hinged left  
R - hinged right

**STANDARD FINISHES**

For a complete list of standard wood finishes please see page 247.

**PULLS/LOCKS**

Wood door bookcases have pulls, glass door bookcases feature the Luna knob. Lateral file drawers include locks. Locks may be added to wood doors at an upcharge of **\$152 list.**

# MILLENNIUM | STORAGE

Description	Model	Cherry	W	D	H	Shipping Weight	Cubic Feet
		Walnut Maple					
5-Hi 2 Closed Shelves	68ST30206828*	5590	30	20.25	68.25	230	29
& 3 Closed Shelves	68ST30246828	5748	30	24.25	68.25	280	35
with Pocket Doors	68ST36206828	5870	36.25	20.25	68.25	280	34
	68ST36246828	6012	36.25	24.25	68.25	340	40



**ORDERING NOTES:**

Interior shelves are adjustable in increments of approximately 1-1/4". Locks are available on all wood doors at **\$152 list.**

5-Hi 5 Single Width Closed Shelves	68ST18246811L*	3636	18	24.25	68.25	186	21
	68ST18246811R	3635	18	24.25	68.25	186	21



**ORDERING NOTES:**

Second lowest shelf is fixed, all others are adjustable in increments of approximately 1-1/4". Locks are available on all wood doors at **\$152 list.**

6 Hi Open Shelves	68ST30208417*	5810	30.5	20.25	84	173	34
	68ST30248417	5889	30.5	24.25	84	208	40
	68ST36208417	5850	36	20.25	84	208	40
	68ST36248417	5962	36	24.25	84	250	47



**ORDERING NOTES:**

Second lowest shelf is fixed, all others are adjustable in increments of approximately 1-1/4".

6-Hi 4 Lateral Files & 2 Open Shelves	68ST30208405*	6854	30.5	20.25	84	257	34
	68ST30248405	6940	30.5	24.25	84	308	40
	68ST36208405	6895	36	20.25	84	308	40
	68ST36248405	7021	36	24.25	84	370	47

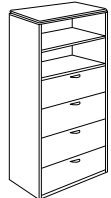

**ORDERING NOTES:**

Open shelves are adjustable in increments of approximately 1-1/4".

6-Hi 2 Lateral Files & 4 Open Shelves	68ST30208403*	6322	30.5	20.25	84	240	34
	68ST30248403	6412	30.5	24.25	84	250	40
	68ST36208403	6385	36	20.25	84	250	40
	68ST36248403	6480	36	24.25	84	270	47



**ORDERING NOTES:**

Open shelves are adjustable in increments of approximately 1-1/4".

**ORDERING PROCEDURE**

To order, please specify the following:

- 1) Krug product model number
- 2) Wood species and finish, see page 247
- 3) Wood edge detail- I,H, L or P, see page 250
- 4) Pull style, see page 250
- 5) Grommet location if applicable

\*Indicates model illustrated by line drawing.

**CODE DESCRIPTION**

L - hinged left  
R - hinged right

**STANDARD FINISHES**

For a complete list of standard wood finishes please see page 247.

**PULLS/LOCKS**

Wood door bookcases have pulls, glass door bookcases feature the Luna knob. Lateral file drawers include locks. Locks may be added to wood doors at an upcharge of **\$152 list.**

# MILLENNIUM | STORAGE & WARDROBES

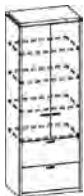
Description	Model	Cherry Walnut Maple			W	D	H	Shipping Weight	Cubic Feet
6-Hi 2 Lateral Files & 4 Closed Shelves 	68ST30208404*	6563			30.5	20.25	84	250	34
	68ST30248404	6648			30.5	24.25	84	260	40
	68ST36208404	6620			36	20.25	84	260	40
	68ST36248404	6725			36	24.25	84	280	47

6 Closed Shelves 	68ST18208411L*	4065			18	20.25	84	185	22
	68ST18208411R	4065			18	20.25	84	185	22
	68ST18248411L	4179			18	20.25	84	195	26
	68ST18248411R	4179			18	20.25	84	195	26

**ORDERING NOTES:**

Second lowest shelf is fixed, all others are adjustable in increments of approximately 1-1/4". Locks are available on all wood bookcase doors at **\$152 list**.

6 Open Shelves 	68ST18208417*	3516			18	20.25	84	168	22
	68ST18248417	4029			18	24.25	84	188	26

**ORDERING NOTES:**

Second lowest shelf is fixed, all others are adjustable in increments of approximately 1-1/4".

5 Hi Wardrobe 	68WR18246802L*	3134			18	24.25	68.25	150	21
	68WR18246802R	3134			18	24.25	68.25	150	21

**ORDERING NOTES:**

Locks are available on all wood doors at **\$152 list** per lock.

Wardrobe & Closed Shelves 	68WR30246801*	4796			30.5	24.25	68.25	237	35
	68WR36246801	4988			36	24.25	68.25	285	40

**ORDERING NOTES:**

Locks are available on all wood doors at **\$152 list** per lock. 24", 30" & 36" wardrobes require 2 locks.

**DIMENSION KEY**

W - width  
D - depth  
H - height

**CODE DESCRIPTION**

L - hinged left  
R - hinged right

**STANDARD FINISHES**

For a complete list of standard wood finishes please see page 247.

**PULLS/LOCKS**

Wood door bookcases have pulls, glass door bookcases feature the Luna knob. Lateral file drawers include locks. Locks may be added to wood doors at an upcharge of **\$152 list** per lock.

# MILLENNIUM | MODULAR TOPS

Description	Model	Cherry Walnut Maple			W	D	H	Shipping Weight	Cubic Feet
Full Width Wardrobe	68WR30246802*	4420	30.5	24.25	68.25	217	35		
	68WR36246802	4652	36	24.25	68.25	265	40		

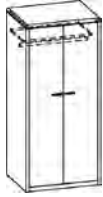

**ORDERING NOTES:**

Locks are available on all wood doors at **\$152 list** per lock. 24", 30" & 36" wardrobes require 2 locks.

Modular Tops	Model		Cherry Walnut Maple			W	D	H	Shipping Weight	Cubic Feet
	68TP3624	916	35.75	24	-	31.5	2.25			
	68TP3630	1032	35.75	30	-	37.5	2.75			
	68TP3636	1240	35.75	36	-	43.5	3.25			
	68TP4224	962	41.75	24	-	35.5	2.25			
	68TP4230	1081	41.75	30	-	42.5	2.75			
	68TP4236	1295	41.75	36	-	49.5	3.25			
	68TP4824	1012	47.75	24	-	39.5	3.75			
	68TP4830	1135	47.75	30	-	47.5	2.5			
	68TP4836	1360	47.75	36	-	55.5	3			
	68TP5424	1061	53.75	24	-	43.5	3.5			
	68TP5430	1201	53.75	30	-	52.5	4.25			
	68TP5436	1441	53.75	36	-	61.5	3.25			
	68TP6020	1088	59.75	20	-	41.5	4			
	68TP6024	1163	59.75	24	-	47.5	4.75			
	68TP6030	1480	59.75	30	-	57.5	3.25			
	68TP6036	1524	59.75	36	-	67.5	3.75			
	68TP6620	1381	65.75	20	-	44.5	4.5			
	68TP6624	1429	65.75	24	-	51.5	5.25			
	68TP6630	1480	65.75	30	-	62.5	3.5			
	68TP6636	1673	65.75	36	-	72.5	4			
	68TP7120	1579	71.75	20	-	47.5	4.75			
	68TP7124	1632	71.75	24	-	55.5	5.5			
	68TP7130	1676	71.75	30	-	67.5	3.75			
	68TP7136	1827	71.75	36	-	78.5	4.25			
	68TP7820	1724	77.75	20	-	59	5.25			
	68TP7824	1777	77.75	24	-	68	6			
	68TP7830	1832	77.75	30	-	80	4.25			
	68TP7836	2196	77.75	36	-	93	5			
	68TP8420	1811	83.75	20	-	63	6			
	68TP8424	1861	83.75	24	-	72	7			
68TP8430	1914	83.75	30	-	85	4				
68TP8436	2301	83.75	36	-	99	6.5				
68TP9024	1641	89.75	24	-	76	5				
68TP9030	2056	89.75	30	-	90	5.75				
68TP9036	2463	89.75	36	-	105	6.75				
68TP9620	2084	95.75	20	-	69	5				
68TP9624	2139	95.75	24	-	79	5				
68TP9630	2205	95.75	30	-	95	5.75				
68TP9636	2641	95.75	36	-	111	6.75				

**ORDERING PROCEDURE**

To order, please specify the following:

- 1) Krug product model number
- 2) Wood species and finish, see page 247
- 3) Wood edge detail- I,H, L or P, see page 250
- 4) Pull style, see page 250
- 5) Grommet location if applicable

\*Indicates model illustrated by line drawing.

**CODE DESCRIPTION**

- L - hinged left
- R - hinged right
- G - glass doors
- BC - bookcase
- ST - storage
- STCE- curved corner storage unit

**STANDARD FINISHES**

For a complete list of standard wood finishes please see page 247.

**PULLS/LOCKS**

Wood door bookcases have pulls, glass door bookcases feature the Luna knob. Lateral file drawers include locks. Locks may be added to wood doors at an upcharge of **\$152 list per lock**.

MILLENNIUM | MODULAR TOPS

Description	Model	Cherry	W	D	H	Shipping Weight	Cubic Feet
		Walnut Maple					
	68TPR3624L	916	35.75	24	-	31.5	2.25
	68TPR3624R	916	35.75	24	-	31.5	2.25
	68TPR3630L	1032	35.75	30	-	37.5	2.75
	68TPR3630R	1032	35.75	30	-	37.5	2.75
	68TPR3636L	1240	35.75	36	-	43.5	3.25
	68TPR3636R	1240	35.75	36	-	43.5	3.25
	68TPR4220L	843	41.75	20	-	31.5	2.25
	68TPR4220R	843	41.75	20	-	31.5	2.25
	68TPR4224L	962	41.75	24	-	35.5	2.75
	68TPR4224R	962	41.75	24	-	35.5	2.75
	68TPR4230L	1081	41.75	30	-	42.5	3.25
	68TPR4230R	1081	41.75	30	-	42.5	3.25
	68TPR4236L	1295	41.75	36	-	49.5	3.75
	68TPR4236R	1295	41.75	36	-	49.5	3.75
	68TPR4820L	871	47.75	20	-	34.5	2.5
	68TPR4820R	871	47.75	20	-	34.5	2.5
	68TPR4824L	915	47.75	24	-	39.5	3
	68TPR4824R	915	47.75	24	-	39.5	3
	68TPR4830L	1135	47.75	30	-	47.5	3.25
	68TPR4830R	1135	47.75	30	-	47.5	3.25
	68TPR4836R	1360	47.75	36	-	55.5	3.75
	68TPR4836L	1360	47.75	36	-	55.5	3.75
	68TPR5424L	1128	53.75	24	-	47.5	2.5
	68TPR5424R	1128	53.75	24	-	47.5	2.5
	68TPR5430L	1201	53.75	30	-	55.5	3
	68TPR5430R	1201	53.75	30	-	55.5	3
	68TPR5436L	1441	53.75	36	-	43.5	3.5
	68TPR5436R	1441	53.75	36	-	43.5	3.5
	68TPR6024R	1163	59.75	24	-	52.5	4.25
	68TPR6024L	1163	59.75	24	-	52.5	4.25
	68TPR6030L	1288	59.75	30	-	61.5	3.25
	68TPR6030R	1288	59.75	30	-	61.5	3.25
	68TPR6036L	1524	59.75	36	-	41.5	4
	68TPR6036R	1524	59.75	36	-	41.5	4
	68TPR6624L	1369	65.75	24	-	47.5	4.75
	68TPR6624R	1369	65.75	24	-	47.5	4.75
	68TPR6630L	1480	65.75	30	-	57.5	3.25
	68TPR6630R	1480	65.75	30	-	57.5	3.25
	68TPR6636L	1357	65.75	36	-	67.5	3.75
	68TPR6636R	1357	65.75	36	-	67.5	3.75
68TPR7124L	1560	71.75	24	-	44.5	4.5	
68TPR7124R	1560	71.75	24	-	44.5	4.5	
68TPR7130L	1676	71.75	30	-	51.5	5.25	
68TPR7130R	1676	71.75	30	-	51.5	5.25	
68TPR7136L	1827	71.75	36	-	62.5	3.5	
68TPR7136R	1827	71.75	36	-	62.5	3.5	
68TPR7824L	1573	77.75	24	-	44.5	4.5	
68TPR7824R	1573	77.75	24	-	44.5	4.5	
68TPR7830L	1691	77.75	30	-	51.5	5.25	
68TPR7830R	1691	77.75	30	-	51.5	5.25	
68TPR7836L	1860	77.75	36	-	62.5	3.5	
68TPR7836R	1860	77.75	36	-	62.5	3.5	
68TPR8424L	1875	83.75	24	-	72	4	
68TPR8424R	1875	83.75	24	-	72	4	
68TPR8430L	1914	83.75	30	-	85	4.75	
68TPR8430R	1914	83.75	30	-	85	4.75	
68TPR8436L	2301	83.75	36	-	99	5.5	
68TPR8436R	2301	83.75	36	-	99	5.5	

**DIMENSION KEY**

W - width  
D - depth  
H - height

**CODE DESCRIPTION**

L - left handed  
R - right handed

**STANDARD FINISHES**

For a complete list of standard wood finishes please see page 247.

# MILLENNIUM | PEDESTALS

Description	Model	Cherry	W	D	H	Shipping Weight	Cubic Feet
		Walnut Maple					
Deep Pedestal	68PD4D*	2096	15.75	28.75	26.75	108	9
	68PD4F	2234	15.75	28.75	26.75	110	9



**ORDERING NOTES:**

Deep pedestals have unfinished tops and backs. Backs may be finished at an upcharge of **\$173 per list**. Please specify at time of order.

Shallow Pedestal	68PS4D	1946	15.75	18.75	26.75	74	6
	68PS4F*	2085	15.75	18.75	26.75	76	6

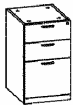

**ORDERING NOTES:**

Shallow pedestals have unfinished tops and backs. Backs may be finished at an upcharge of **\$173 per list**. Please specify at time of order.

Bookcase Pedestal	68PS4BC15L*	1588	15.75	18.75	26.75	70	6
	68PS4BC15R	1592	15.75	18.75	26.75	70	6



**ORDERING NOTES:**

Bookcase pedestals have unfinished tops and backs. Backs may be finished at an upcharge of **\$173 list**. Please specify at time of order. Locks on bookcase pedestal doors are available at **\$152 list**. Please specify at time of order.

Shallow Bookcase Pedestal	68PS4BC30	2220	30	18.75	27	90	11
	68PS4BC36*	2369	35.5	18.75	27	107	13
	68PS4BC42	2508	41.5	18.75	27	125	15

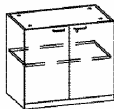

**ORDERING NOTES:**

Bookcase pedestals have unfinished tops and backs. Backs may be finished at an upcharge of **\$255 list**. Please specify at time of order. Locks on bookcase pedestal doors are available at **\$159 list**. Please specify at time of order.

Lateral File Pedestal - Shallow	68PS4LF30*	2654	30	18.75	27	114	11
	68PS4LF36	2804	35.5	18.75	27	135	13
	68PS4LF42	2954	41.5	18.75	27	158	15

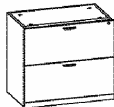

**ORDERING NOTES:**

Lateral file pedestals have unfinished tops and backs. Backs may be finished at an upcharge of **\$255 list**. Please specify at time of order.

**ORDERING PROCEDURE**

To order, please specify the following:

- 1) Krug product model number
- 2) Wood species and finish, see page 247
- 3) Wood edge detail- I,H, L or P, see page 250
- 4) Pull style, see page 250
- 5) Grommet location if applicable

\*Indicates model illustrated by line drawing.

**CODE DESCRIPTION**

- 4 - full height pedestal
- L - hinged left
- R - hinged right
- D - 2 file drawer box, 1 file drawer
- LF- lateral file
- BC - bookcase

**STANDARD FINISHES**

For a complete list of standard wood finishes please see page 247.

**PEDESTALS**

Pedestals are designed for use with open shells or open returns. Pedestals require field installation in shell units and are secured in place with the provided hardware.

# MILLENNIUM | PEDESTALS

Description	Model	Cherry		W	D	H	Shipping Weight	Cubic Feet
		Walnut	Maple					
Lateral File Storage Pedestal	68PLF36192901	3078		35.5	18.75	27	117	13

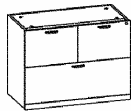

**ORDERING NOTES:**

Only lower lateral file drawer locks. Storage pedestals have unfinished tops and backs. Backs may be finished at an upcharge of **\$255 list**. Please specify at time of order.

Combination Storage Pedestal	68PLF36192902*	3142		35.5	18.75	27	117	13
	68PLF36192904	3142		35.5	18.75	27	117	-



**ORDERING NOTES:**

Only lower lateral file drawer locks. Storage pedestals have unfinished tops and backs. Backs may be finished at an upcharge of **\$255 list**. Please specify at time of order.

Ganged Pedestal	68PS4DD	3754		31.5	18.75	26.75	148	12
	68PS4DF	3929		31.5	18.75	26.75	152	12
	68PS4FD*	3919		31.5	18.75	26.75	150	12
	68PS4FF	4045		31.5	18.75	26.75	152	12

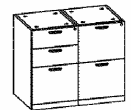

**ORDERING NOTES:**

Ganged pedestals have unfinished tops and backs. Backs may be finished at an upcharge of **\$255 list**. Please specify at time of order.

Mobile Pedestal	68MPD4D	2241		15.75	28.75	26.75	108	9
	68MPD4F**	2383		15.75	28.75	26.75	110	9
	68MPS4D*	2076		15.75	18.75	26.75	74	6
	68MPS4F	2215		15.75	18.75	26.75	76	6



**ORDERING NOTES:**

Mobile pedestals have finished tops and backs. Please see page 257 for upholstered seat option.

CPU Pedestal	68MPCPU22L	1158		15.75	22	26.75	75	6
	68MPCPU22R*	1158		15.75	22	26.75	75	6



**ORDERING NOTES:**

This unit will not fit under a 20" worksurface. Dimensions inside unit are 11.5" wide, 21" deep and 23.5" high.

**DIMENSION KEY**

W - width  
D - depth  
H - height

**CODE DESCRIPTION**

4 - full height pedestal  
L - hinged left  
R - hinged right  
D - 2 file drawer  
F - 2 box, 1 file drawer  
LF- lateral file  
BC- bookcase

**STANDARD FINISHES**

For a complete list of standard wood finishes please see page 247.

**PEDESTALS**

Pedestals are designed for use with open shells or open returns. Pedestals require field installation in shell units and are secured in place with the provided hardware..



# MILLENNIUM | RECEPTION

Description	Model	Cherry	W	D	H	KW	Shipping	Cubic
		Walnut Maple						
 Reception Desk, Full Height Pedestals	68GD60304LFRF	7175	60	30	28.5	27.5	270	44
	68GD60304LORF	6017	60	30	28.5	42.5	270	44
	68GD60304LFR0	6017	60	30	28.5	42.5	270	44
	68GD66304LFRF	7335	65.75	30	28.5	33.25	290	48
	68GD66304LORF	6224	65.75	30	28.5	48.25	290	48
	68GD66304LFR0	6200	65.75	30	28.5	48.25	290	48
	68GD72304LFRF	7448	72.75	30	28.5	40	310	51
	68GD72304LORF*	6271	72.25	30	28.5	54.75	310	51
	68GD72304LFR0	6271	72.75	30	28.5	54.75	310	51
	68GD84304LFRF	7586	84	30	28.5	51.5	330	61
	68GD84304LORF	6360	84	30	28.5	66.5	330	61
	68GD84304LFR0	6360	84	30	28.5	66.5	330	61
	68GD96304LFRF	7818	95.75	30	28.5	63.25	350	69
	68GD96304LORF	6730	95.75	30	28.5	78.25	350	69
68GD96304LFR0	6730	95.75	30	28.5	78.25	350	69	

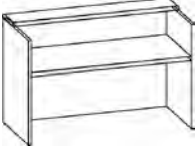
Description	Model	Cherry	W	D	H	KW	Shipping	Cubic
 Reception Desk Shell	68GDS6630	4022	65.25	30	28.5	63	235	45
	68GDS7130	4114	70.5	30	28.5	69.75	250	48
	68GDS8430*	4230	83.5	30	28.5	81.25	275	58
	68GDS9630	4350	95.5	30	28.5	93	295	66

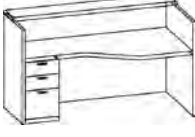
Description	Model	Cherry	W	D	H	KW	Shipping	Cubic
 Reception Corner Desk with Full Height Pedestals	68GCD7124L4F	6184	72.5	36.25	28.5	54.75	280	54
	68GCD7124L4D	6184	72.5	36.25	28.5	54.75	280	54
	68GCD7124R4F	6184	72.5	36.25	28.5	54.75	280	54
	68GCD7124R4D	6184	72.5	36.25	28.5	54.75	280	54
	68GCD8424L4F*	6364	84	36.25	28.5	66.5	310	64
	68GCD8424L4D	6364	84	36.25	28.5	66.5	310	64
	68GCD8424R4F	6364	84	36.25	28.5	66.5	310	64
	68GCD8424R4D	6364	84	36.25	28.5	66.5	310	64
	68GCD9624L4F	6757	95.75	36.25	28.5	78.25	330	73
	68GCD9624L4D	6757	95.75	36.25	28.5	78.25	330	73
	68GCD9624R4F	6757	95.75	36.25	28.5	78.25	330	73
	68GCD9624R4D	6757	95.75	36.25	28.5	78.25	330	73

**ORDERING NOTES:**

Laminate worksurfaces are available at a 10% upcharge. Optional reveals are available at an upcharge of **\$290 list** per running foot of surface area.

Description	Model	Cherry	W	D	H	KW	Shipping	Cubic
 Bow Shaped Transaction Top Option	BT60	212	-	-	-	-	-	-
	BT66	217	-	-	-	-	-	-
	BT72	220	-	-	-	-	-	-
	BT84	247	-	-	-	-	-	-
	BT96*	282	-	-	-	-	-	-

**ORDERING PROCEDURE**

To order, please specify the following:

- 1) Krug product model number
- 2) Wood species and finish, see page 247
- 3) Wood edge detail- I,H, L or P, see page 250
- 4) Pull style, see page 250
- 5) Grommet location if applicable

\*Indicates model illustrated by line drawing.

**CODE DESCRIPTION**

- 0 - no pedestal
- 3 - 3/4 height pedestal
- 4 - full height pedestal
- L - left handed pedestal position
- right handed pedestal position
- D - 2 file drawer
- F - 2 box, 1 file drawer

**STANDARD FINISHES**

For a complete list of standard wood finishes please see page 247.

**RECEPTION PANELS**

Reception desks, returns, linking units and credenzas have 43" high perimeter panels.

**INLAY OPTION**

Add 10% list for optional laminate inlay.

MILLENNIUM | RECEPTION

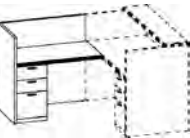
Description	Model	Cherry		W	D	H	KW	Shipping Weight	Cubic Feet
		Walnut	Maple						
Reception Return, Desk Height with Full Height Pedestals 	68GRH3624L4D	3668		36.25	24.25	28.5	20	154	25
	68GRH3624L4F	3668		36.25	24.25	28.5	20	154	25
	68GRH3624R4D	3668		36.25	24.25	28.5	20	154	25
	68GRH3624R4F	3668		36.25	24.25	28.5	20	154	25
	68GRH4224L4D	3885		42.5	24.25	28.5	26.5	176	29
	68GRH4224L4F*	3885		42.5	24.25	28.5	26.5	176	29
	68GRH4224R4D	3885		42.5	24.25	28.5	26.5	176	29
	68GRH4224R4F	3885		42.5	24.25	28.5	26.5	176	29
	68GRH4824L4D	3996		48.5	24.25	28.5	32.25	202	33
	68GRH4824L4F	3996		48.5	24.25	28.5	32.25	202	33
	68GRH4824R4D	3996		48.5	24.25	28.5	32.25	202	33
	68GRH4824R4F	3996		48.5	24.25	28.5	32.25	202	33
	68GRH5424L4D	4084		54.25	24.25	28.5	38	224	37
	68GRH5424L4F	4084		54.25	24.25	28.5	38	224	37
	68GRH5424R4D	4084		54.25	24.25	28.5	38	224	37
	68GRH5424R4F	4084		54.25	24.25	28.5	38	224	37
	68GRH6024L4D	4167		60	24.25	28.5	44	245	41
	68GRH6024L4F	4167		60	24.25	28.5	44	245	41
	68GRH6024R4D	4167		60	24.25	28.5	44	245	41
	68GRH6024R4F	4167		60	24.25	28.5	44	245	41
	68GRH6624L4D	4261		66.25	24.25	28.5	54	269	46
	68GRH6624L4F	4261		66.25	24.25	28.5	54	269	46
	68GRH6624R4D	4261		66.25	24.25	28.5	54	269	46
	68GRH6624R4F	4261		66.25	24.25	28.5	54	269	46
	68GRH7124L4D	4397		72	24.25	28.5	59	292	50
	68GRH7124L4F	4397		72	24.25	28.5	59	292	50
	68GRH7124R4D	4397		72	24.25	28.5	59	292	50
	68GRH7124R4F	4397		72	24.25	28.5	59	292	50

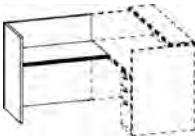
Open Reception Return, Desk Height 	68GRH3620L	2028		36.25	20.25	28.5	35	102	21
	68GRH3620R	2028		36.25	20.25	28.5	35	102	21
	68GRH3624L	2059		36.25	24.25	28.5	35	122	25
	68GRH3624R	2059		36.25	24.25	28.5	35	122	25
	68GRH4220L*	2091		42.5	20.25	28.5	41	120	25
	68GRH4220R	2091		42.5	20.25	28.5	41	120	25
	68GRH4224L	2121		42.5	24.25	28.5	41	144	29
	68GRH4224R	2121		42.5	24.25	28.5	41	144	29
	68GRH4820L	2145		48.5	20.25	28.5	47	142	28
	68GRH4820R	2145		48.5	20.25	28.5	47	142	28
	68GRH4824L	2173		48.5	24.25	28.5	47	170	33
	68GRH4824R	2173		48.5	24.25	28.5	47	170	33
	68GRH5420L	2212		54.25	20.25	28.5	53	160	32
	68GRH5420R	2212		54.25	20.25	28.5	53	160	32
	68GRH5424L	2241		54.25	24.25	28.5	53	192	37
	68GRH5424R	2241		54.25	24.25	28.5	53	192	37
	68GRH6020L	2266		60	20.25	28.5	58.75	178	41
	68GRH6020R	2266		60	20.25	28.5	58.75	178	41
	68GRH6024L	2268		60	24.25	28.5	58.75	213	41
	68GRH6024R	2268		60	24.25	28.5	58.75	213	41
	68GRH6620L	2304		66.25	20.25	28.5	65	198	39
	68GRH6620R	2304		66.25	20.25	28.5	65	198	39
	68GRH6624L	2359		66.25	24.25	28.5	65	237	46
	68GRH6624R	2359		66.25	24.25	28.5	65	237	46
	68GRH7120L	2387		72	20.25	28.5	70.75	217	42
	68GRH7120R	2387		72	20.25	28.5	70.75	217	42
	68GRH7124L	2430		72	24.25	28.5	70.75	260	50
	68GRH7124R	2430		72	24.25	28.5	70.75	260	50

**DIMENSION KEY**

W - width  
 D - depth  
 H - height

**CODE DESCRIPTION**

0 - no pedestal  
 H - desk height  
 4 - full height pedestal



**STANDARD FINISHES**

For a complete list of standard wood finishes please see page 247.

**LAMINATE**

Laminate worksurfaces are available at a 10% upcharge. Optional reveals are available at an upcharge of **\$290 list** per running foot of surface area.

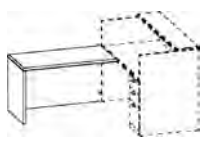
# MILLENNIUM | RECEPTION

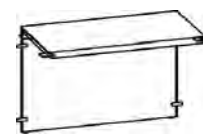
Description	Model	Cherry	W	D	H	KW	Shipping Weight	Cubic Feet
		Walnut Maple						
 Open Return, Desk Height for Reception Unit	68RHD2024L	2018	20	24.25	28.5	18.75	50	11
	68RHD2024R	2018	20	24.25	28.5	18.75	50	11
	68RHD2424L	2064	24	24.25	28.5	22.75	55	13
	68RHD2424R	2064	24	24.25	28.5	22.75	55	13
	68RHD3024L	2113	30	24.25	28.5	28.5	60	15
	68RHD3024R	2113	30	24.25	28.5	28.5	60	15
	68RHD3624L	2176	36	24.25	28.5	34.5	67	18
	68RHD3624R	2176	36	24.25	28.5	34.5	67	18
	68RHD4224L*	2205	42	24.25	28.5	40.5	75	21
	68RHD4224R	2205	42	24.25	28.5	40.5	75	21
	68RHD4824L	2256	48	24.25	28.5	46.5	82	23
	68RHD4824R	2256	48	24.25	28.5	46.5	82	23
	68RHD5424L	2302	54	24.25	28.5	52.5	90	26
	68RHD5424R	2302	54	24.25	28.5	52.5	90	26
	68RHD6024L	2366	60	24.25	28.5	58.5	97	29
	68RHD6024R	2366	60	24.25	28.5	58.5	97	29
	68RHD6624L	2421	65.75	24.25	28.5	64.5	105	32
	68RHD6624R	2421	65.75	24.25	28.5	64.5	105	32
	68RHD7124L	2486	71	24.25	28.5	69.5	113	34
	68RHD7124R	2486	71	24.25	28.5	69.5	113	34
68RHD8424L	2577	84	24.25	28.5	82.75	120	40	
68RHD8424R	2577	84	24.25	28.5	82.75	120	40	
 Reception Linking Unit, Desk Height	68GLU3624H	2010	35.25	24.25	28.5		90	24
	68GLU4224H	2105	41.5	24.25	28.5		100	28
	68GLU4824H*	2215	47.5	24.25	28.5		110	32
	68GLU6024H	2508	59.5	24.25	28.5		130	41
	68GLU6624H	2586	65.25	24.25	28.5		140	45
	68GLU7124H	2686	70.5	24.25	28.5		150	49
 Linking Unit, Desk Height for Reception Unit	68LUD3024HL	1828	29.75	24.25	28.5		57	6
	68LUD3024HR	1828	29.75	24.25	28.5		57	6
	68LUD3624HL	1861	35.75	24.25	28.5		68	7
	68LUD3624HR	1861	35.75	24.25	28.5		68	7
	68LUD4224HL	2004	41.75	24.25	28.5		82	8
	68LUD4224HR*	2004	41.75	24.25	28.5		82	8
	68LUD4824HL	2051	47.75	24.25	28.5		97	9
	68LUD4824HR	2051	47.75	24.25	28.5		97	9
	68LUD5424HL	2122	54.5	24.25	28.5		111	10
	68LUD5424HR	2122	54.5	24.25	28.5		111	10
	68LUD6024HL	2148	59.75	24.25	28.5		123	11
	68LUD6024HR	2148	59.75	24.25	28.5		123	11
	68LUD6624HL	2185	65.5	24.25	28.5		137	12
	68LUD6624HR	2185	65.5	24.25	28.5		137	12
68LUD7124HL	2219	70.75	24.25	28.5		148	13	
68LUD7124HR	2219	70.75	24.25	28.5		148	13	

**ORDERING NOTES:**

Laminate worksurfaces are available at a 10% upcharge.

**ORDERING PROCEDURE**

To order, please specify the following:

- 1) Krug product model number
- 2) Wood species and finish, see page 247
- 3) Wood edge detail- I,H, L or P, see page 250
- 4) Pull style, see page 250
- 5) Grommet location if applicable

\*Indicates model illustrated by line drawing.

**CODE DESCRIPTION**

- 4 - full height pedestal
- L - hinged left
- R - hinged right
- D - 2 file drawer
- F - 2 box, 1 file drawer

**STANDARD FINISHES**

For a complete list of standard wood finishes please see page 247.

**PEDESTALS**

Pedestals are designed for use with open shells or open returns. Pedestals require field installation in shell units and are secured in place with the provided hardware.

MILLENNIUM | RECEPTION

Description	Model	Cherry		W	D	H	Shipping Weight	Cubic Feet
		Walnut	Maple					
	68GRT60	1103		60.5	12	-	25	1
	68GRT66	1163		66.5	12	-	35	1
	68GRT71*	1228		72.5	12	-	45	2
	68GRT78	1305		78.5	12	-	48	2.5
	68GRT84	1380		84.5	12	-	53	3
	68GRT90	1440		90	12	-	56	3

**ORDERING NOTES:**

Reception Return Transaction Top is designed to be used with a 42" return.

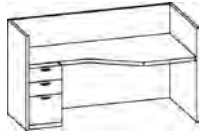
Description	Model	Cherry		W	D	H	Shipping Weight	Cubic Feet	
		Walnut	Maple						
	68GCC7124L4F	5443		71.75	36.25	28.5	54.75	270	54
	68GCC7124R4F	5443		71.75	36.25	28.5	54.75	270	54
	68GCC7124L4D	5443		71.75	36.25	28.5	54.75	270	54
	68GCC7124R4D	5443		71.75	36.25	28.5	54.75	270	54
	68GCC8424L4F	6039		83.5	36.25	28.5	66.5	290	54
	68GCC8424R4F	6039		83.5	36.25	28.5	66.5	290	54
	68GCC8424L4D	6039		83.5	36.25	28.5	66.5	290	54
	68GCC8424R4D	6039		83.5	36.25	28.5	66.5	290	54
	68GCC9024L4F*	6183		89.5	36.25	28.5	72.5	300	64
	68GCC9024R4F	6183		89.5	36.25	28.5	72.5	300	64
	68GCC9024L4D	6183		89.5	36.25	28.5	72.5	300	64
	68GCC9024R4D	6183		89.5	36.25	28.5	72.5	300	64
	68GCC9624L4F	6985		95.25	36.25	28.5	78.25	310	69
	68GCC9624R4F	6985		95.25	36.25	28.5	78.25	310	69
	68GCC9624L4D	6985		95.25	36.25	28.5	78.25	310	69
	68GCC9624R4D	6985		95.25	36.25	28.5	78.25	310	69

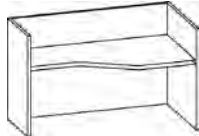
Description	Model	Cherry		W	D	H	Shipping Weight	Cubic Feet	
		Walnut	Maple						
	68GCC6624L	4005		65.25	36.25	28.5	63	250	69
	68GCC6624R	4005		65.25	36.25	28.5	63	250	69
	68GCC7124L*	4084		71.75	36.25	28.5	69.75	260	73
	68GCC7124R	4084		71.75	36.25	28.5	69.75	260	73
	68GCC8424L	4131		83.5	36.25	28.5	81.25	270	73
	68GCC8424R	4131		83.5	36.25	28.5	81.25	270	73
	68GCC9624L	4378		85.25	36.25	28.5	93	290	73
	68GCC9624R	4378		85.25	36.25	28.5	93	290	73

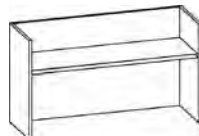
Description	Model	Cherry		W	D	H	Shipping Weight	Cubic Feet	
		Walnut	Maple						
	68GCS6624	3489		65.25	24.25	28.5	63	235	45
	68GCS7124	3587		71.75	24.25	28.5	69.75	255	47
	68GCS8424*	3631		83.5	24.25	28.5	81.25	275	58
	68GCS9624	3773		95.25	24.25	28.5	93	295	66

**ORDERING NOTES:**

Laminate worksurfaces are available at a 10% upcharge. Optional reveals are available at an upcharge of **\$290 list** per running foot of surface area.

**DIMENSION KEY**

W - width  
D - depth  
H - height

**CODE DESCRIPTION**

0 - no pedestal  
3 - 3/4 height pedestal  
4 - full height pedestal  
L - left handed pedestal position  
R - right handed pedestal position  
D - 2 file drawer  
F - 2 box, 1 file drawer

**STANDARD FINISHES**

For a complete list of standard wood finishes please see page 247.

**RECEPTION PANELS**

Reception desks, returns, linking units and credenzas have 43" high perimeter panels.

**INLAY OPTION**

Add 10% list for optional laminate inlay.

## ARTEMIS | TABLE OF CONTENTS

324	Environmental Summary
325	Features
329	Power Management Options
330	Sample Configuration
331	Desks
341	Height Adjustable Worksurfaces
349	Desk Runoffs for 3/4 Height Credenzas
362	Returns
377	Linking & Corner Units
379	Credenzas
391	Overheads
395	Wall Mounted & Magnetic Back-Painted Glass
396	Hutches
400	Pedestals
401	PowerPorts
402	Power/Data & Cable Management
405	Bookcases
406	Storage
411	Wardrobes
413	Benches
414	Modular Components
419	Reception
420	Media Wall
421	Media Hub
441	Wood Finishes
441	Non-Standard Product Guidelines for Pricing
442	Installation Instructions

# ARTEMIS | ENVIRONMENTAL SUMMARY

## LEED CI CREDITS



MATERIAL CONTENT:

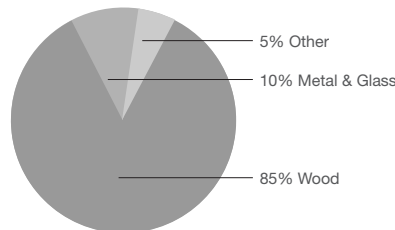

PRE-CONSUMER RECYCLED CONTENT - 81%

POST-CONSUMER RECYCLED CONTENT - 3%

		CONTRIBUTES TO
Credit 2.1 - 2.2	Construction Waste Management	1 point
Credit 3.3	Resource Reuse	1 point
Credit 4.1	Recycled Content	1 point
Credit 4.2	Recycled Content	1 point
Credit 4.5	Low Emitting Materials, (MUST BE REQUESTED)	
	Composite Wood & Laminate Adhesives	1 point
	Regional Materials*	1 point
Credit 5.1	Rapidly Renewable Materials (MUST BE REQUESTED)	1 point
Credit 7	Certified Wood (MUST BE REQUESTED)	1 point

\* This credit is only applicable if in total 20% of the combined value of the procurement of construction materials and in the furniture are manufactured within a radius of 500 miles. This credit will apply if the installation of the finished product occurs within 500 miles of Toronto, Ontario.

## level® CERTIFICATION, AIR EMISSIONS AND FSC® CERTIFICATION



### level® Certification

BIFMA's e3 Furniture Sustainability Standard is a voluntary, multi-attribute standard that measures the degree of sustainability of furniture. This standard evaluates product and company environmental attributes and compliance systems in a wide range of elements which include Materials, Energy & Atmosphere, Human & Ecosystem Health and Social Responsibility. Artemis products have earned level®, BIFMA's sustainability certification program for furniture, certification through third-party verification against the e3 standard. All Artemis products can be supplied with level® certification. In order to accomplish this, the product must also be ordered with the air-emissions-certification option. Contact customer service for information and upcharges.



### Air Emissions

All Artemis products can be supplied with air emissions-certification. Contact customer service for information and upcharges.

### FSC®

FSC® In 2005, Krug received Forest Stewardship Council® (FSC®) Chain-of-Custody certification for our manufacturing facilities. The FSC® Chain-of-Custody tracks certified wood from seedling to final sale. It verifies that the material for our FSC® certified products only come from well-managed, FSC®-certified forests and other controlled sources. FSC® is dedicated to the promotion of responsible forest management worldwide helping to take care of forests for future generations. Artemis and other Krug products can be specified with FSC® Certification. Contact customer service for further information, pricing and lead times.



The mark of responsible forestry

In addition, architects, designers, and building professionals can specify FSC®-certified products in order to achieve a point from the U.S. Green Building Council's Leadership in Energy and Environmental Design (LEED) Rating System.

# ARTEMIS | FEATURES

## WORK SURFACES

Tops are 1 1/4" thick veneered particle board core with face and back veneer. All worksurface height tops have profiled edges on all sides, except when using the M Profile in a Polymer Edge where the profile appears on the front and back sides only of desks. Credenzas, returns, and link units side and back edges are flush. All worksurface height tops have a chemically impregnated polycell backer for additional strength.

## MODESTY PANELS

Modesty panels are standard on all desks, and optional on shaped tops, returns, linking units and credenzas. Modesty panels on credenzas are 3/4" thick, and linking unit modesty panels are 1 1/8" thick.

## METAL LEGS

The metal legs in Artemis have a Silver Metallic finish.

## VENEER

External face veneers are rift cut Red Oak, and flat sliced Cherr, Maple, and Walnut bookmatched veneer.

## FINISH

A five step catalyzed va nish finish that when dry has a sheen value of 35°, is applied to all finished cases

## LOCKS

Locks are standard on all pedestals and storage unit lateral file drawers. Locks are optional on door fronts and must be specified at time of order. Locks are not available on glass doors.

## LATCHES

All hutch, overhead and bookcase doors are equipped with touch latches mounted inside the top edge of the door.

## DRAWERS

Desk box and file drawers have fully progressive full extension slides and are load rated at 125 lbs. per drawer. All drawer interiors are birch components. All file drawers are equipped for letter and legal filing. All box/box/file pedestals in desks are supplied with one molded black pencil tray.

## GLIDES

Adjustable glides are 1" long and allow for a range of adjustment of 1". Glide inserts are installed at factory. Glides need to be field installed.

## HINGES

Hinges on all hutch, overhead and bookcase doors are European style with 110 degree opening. All hinges are fully adjustable.

## PULLS

All pulls are die cast with a choice of Silver Metallic powder coat, and Grey Metallic powder coat finish options. Pulls are supplied on all drawers.

## TESTING INFORMATION

Artemis meets or exceeds the testing requirements of ANSI/BIFMA X5.5-2014 and/or X5.9 - 2012.



## EDGE PROFILES



Flat Edge - T

Radius Edge - D

Fluted Edge - M

Desks, Credenzas, Curvilinear Desks, Returns, Linking Units, Corner Units, Bookcase and 2 Hi Storage Units have profiles on all edges, with the exception of Artemis Edge - Fluted Profile Polymer Edge

Fluted Profile Polymer Edge - Desks, Credenzas, Curvilinear Desks, Returns, Linking Units, Corner Units, Bookcase and 2Hi Storage Units have profiles on all front & backs. Plan views of each are shown below.

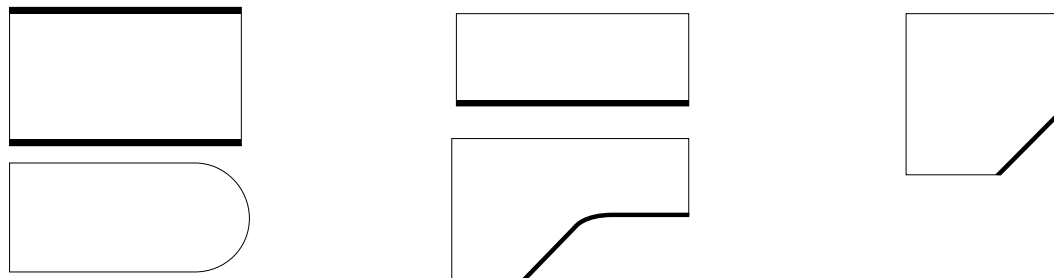

# ARTEMIS | FEATURES

## DRAWER PULLS

Artemis pulls are available in two standard finishes - SILVER METALLIC and GRAY METALLIC. Please specify finish color on purchase order. Artemis pulls are standard on drawer fronts and can be specified on doors. See below for orientation of pulls.



Athena

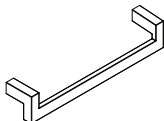

Diana

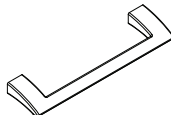

Hera

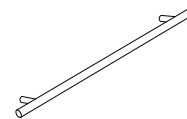

Sono

Doors with Pulls  
Above Work Surface

Height:	
Athena	Vertical
Diana	Vertical
Hera	Vertical
Sono	Vertical

Doors with Pulls  
Below Work Surface

Height:	
Athena	Vertical
Diana	Horizontal
Hera	Horizontal
Sono	Horizontal

Pulls on All Drawer  
Fronts:

Athena	Vertical
Diana	Horizontal
Hera	Horizontal
Sono	Horizontal

## LOCKS

Locks are provided as standard features on all pedestals, except bookcase pedestals, including those in desks, credenzas, and lateral file storage units. Lock plugs are located on the fronts of all cases. Locks are available on the bookcase doors at an upcharge of **\$152 list** per set of (2) doors, please specify at time of order. If a hutch or overhead has an uneven amount of doors the single lock required is also **\$152 list**. Lock plugs for bookcase doors are generally located on the top inside corner of the door front. Lock plugs for hutch and overhead doors are generally located on the lower inside corners. Suites can be keyed alike at no upcharge, please specify on purchase order. Lock plugs are Silver Metallic.

## GROMMETS



All cases may be specified with one grommet in a standard position at no upcharge. The round grommet features a Satin Metallic finish with an open and shut mouse hole which serves to provide cable passage for areas not requiring a large opening. Grommets can be field installed with a power drill, 60 mm hole saw. Please keep in mind the location of the grommets when specifying paper managers or pier hutches for use with worksurfaces. For example, a paper manager on the left-hand side may be used with a "C", "BR" or "AR" grommet. A **\$152 list** upcharge will apply to additional grommets in standard positions and for grommets requested in non-standard positions a **\$152 list** upcharge will apply. The grommet position must be indicated for each case on the order.

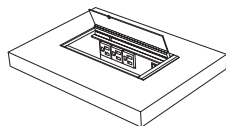

## POWERPORT

A PowerPort is a unique worksurface mounted module that can be specified to a location that best serves the user's needs. It includes a UL approved electrical, voice and data power bar, containing two 115 - volt electrical simplex outlets which are accessible from the work surface, plus a utility outlet at the end for daisy chaining purposes. 3 data versions are available, please see page 79 for options.

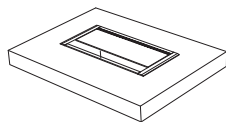

## PORT

A service module having no power bar will serve as a large grommet. A hinged lid easily enables the passage of several cables and devices.

## 76PDVM POWER/ DATA/ VOICE MODULE

This unit is also an option in the worksurface. It is CSA/UL approved, and includes 2 - 115 volt electrical outlets, plus 1 - RJ11 communication port and one RJ45 data port. It features a flip door that retracts into the worksurface when open.

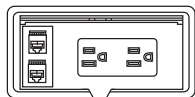

## HUTCH POWER/ DATA/ VOICE MODULE

Access to power and data is made simple by using a hutch with a power/data/voice module built right into the tackboard. The module is fully installed at the factory but can be removed to connect data links on site. It features a flip door that retracts into the case of the unit when open.

Please keep in mind the location of Powerports, Ports, and 76PDVM's when specifying paper managers or pier door hutches for use with worksurfaces. For example, a paper manager or a pier on the left-hand side may be used with a "C", "BR", or "AR" Powerport.



# ARTEMIS | FEATURES

## LAMINATE WORKSURFACES

Krug defines "HPL" as High-Pressure Laminate. Laminate worksurfaces are available for the Artemis product line with two options - Laminate Tops with Wood Edge or Laminate Tops with Polymer Edge.

Krug will order and procure laminates. Purchase orders with a plastic laminate option must include laminate name.

When specifying laminate worksurfaces, the grain direction is such that the grain pattern runs as shown in the diagrams below. Please note, in veneer grain direction runs lengthwise on desks and credenzas and front to back on returns and linking units. In laminate the grain direction runs lengthwise on all components. Please contact Krug Customer Service for questions pertaining to laminate grain direction.

The diagram below illustrates the placement of laminate on Krug worksurfaces.

The shaded areas represent laminate, while the non-shaded area indicates the profiled wood edge or polyme .

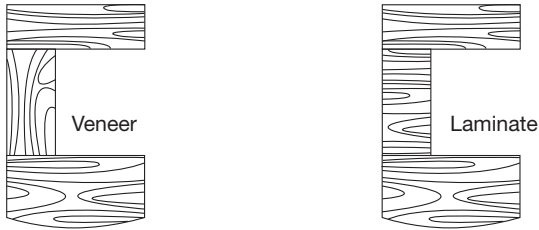

## CREDENZAS

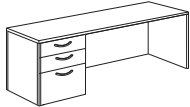

### Credenzas

Artemis offers a wide variety of credenzas for use as stand alone storage pieces, part of a connected work surface configuration, or behind a desk. Choose from single or double pedestal options, with fixed or hinged modesty panel.

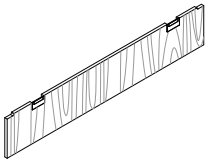

### Modesty Panels

Credenzas without hinged modesty panels provide ease access to wall mounted electrical sources. Credenzas with modesty panels have an added finished look, and all cases are available with a wiring grommet in a standard position for added cable management, please specify on your order. Wiring grommets can be specified above the pedestal location.

### Pedestals

Artemis credenzas are available with single, lateral file, combination pedestals or bookcase pedestals.

## LINKING UNITS AND CORNER UNITS

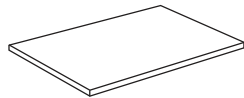

Artemis linking units and corner units are available in a range of sizes for ease of use in configuring a connected worksurface.

### Linking Units

Linking Units are for use between desks and credenzas in creating a U-shaped configuration, and must be supported at both ends. They are available with or without modesty panels.

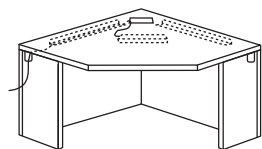

### Corner Units

A corner unit can also be used on a U-shaped configuration, or it can be an integral part of a L-shaped work area with returns linked to either side. Corner units have a standard grommet included in the back corner for ease of cable management, and have additional wire management access grommets in the half gables so that cable can be run to other areas of the connected worksurface. This can be assisted by a cut length of wire management cover.

**HUTCHES, OVERHEADS, & TACKBOARDS**

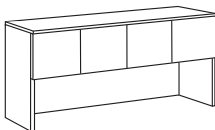

**Hutches and Overheads**

Artemis offers hutch and overhead options for use in a work area configuration. All hutches and overheads include tasklights that are factory installed and require no field adjustment. Tasklights are mounted beneath the cabinet and hidden from view. Selected hutches and overheads are available with silver metallic framed frosted glass doors.

**Doors**

Doors are equipped with fully adjustable European style hinges. Locks are optional and can be specified at time of order for an upcharge of **\$152 per set** of (2) doors. If an uneven amount of doors require locks, the lock on the single door is **\$152**. Locks are not available on glass doors.



**Hutch Power/ Data/ Voice Module**

Access to power and data is made simple by using a hutch with a power/data/voice module built right into the tackboard. The module is fully installed at the factory but can be removed to connect data links on site. It features a flip door that retracts into the case of the unit when open.

**Tackboards**

Please note, not all fabrics are suitable for tackboard application. Tackboard fabric selections should be supplied with the order information. Tackboards are not included with overheads, see page 72 for pricing. Overhead tackboards include wall mounting hardware and instructions. Tackboards for hutches are installed at the factory and require no additional set up on site. Only hutches and overhead tackboards in Krug panel fabrics are available on KrugExpress.

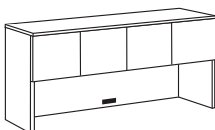

**Tasklights**

Tasklights are included with hutches and overheads. On hutches, the tasklight cord is threaded behind the hutch through a standard access grommet on the upper right hand side of the back panel. Tasklights are installed on the underside of overhead units. Cords run down the right hand side of the tasklight to the worksurface where they can be routed behind the worksurface top. The use of a wall mounted Overhead tackboard conceals the cord from view.

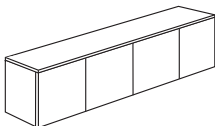

**Installation**

Hutch and overhead installation instructions are included with every case or can be found in this guide on page 118. All mounting hardware required is included with the product.

**MEDIA HUB AND MEDIA WALL**

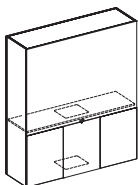

**Media Hub**

Bookcase storage comes with touch latch doors. Wire management cutout in the base of center bookcase is 10-1/4" x 12-3/4". Optional hangover panel comes standard in any of our palette finishes and can be specified with or without white boards. Optional runoff tops and bases sold separately and available in both desk and bar heights. Desk height runoff tops are mounted at 29.5" in height. Bar height runoff tops are mounted at 42" in height. Bank of drawers includes 3 box drawers. Back of unit is finished

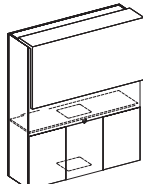

**Media Wall**

No storage. Removable access panel for wire management. Wire management cutout in the base of center bookcase is 10-1/4" x 12-3/4". Media Wall units must be used in conjunction with a media hub runoff top and base. Runoff tops and bases sold separately and available in both desk and bar heights. Desk height runoff tops are mounted at 29.5" in height. Bar height runoff tops are mounted at 42" in height. Bank of drawers includes 3 box drawers. Back of unit is unfinished

# ARTEMIS | POWER MANAGEMENT OPTIONS

## Standard Grommet & PowerPort Positions Desks, Credenzas, Link Units & Returns

AL BL C BR AR

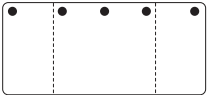

30" deep desks:  
Position Code:  
AL – left corner  
BL – left end beside pedestal gable  
C – center  
BR – right end beside pedestal gable  
AR – right corner

AL BL C BR AR

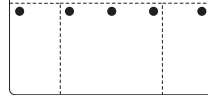

36" deep desks:  
Position Code:  
AL – left corner  
BL – left end beside pedestal gable  
C – center  
BR – right end beside pedestal gable  
AR – right corner

"BR" and "BL" are only available on tops 60" or longer.

## 3/4 height Credenzas for Mounted Runoffs with Power/Data Option



ML MC MR

Position Code:  
ML - Mounted Left  
MC - Mounted Center ( applies to 90" and 96" tops only)  
MR - Mounted Right

## Curvilinear Top Grommets & PowerPorts

"AL" and "AR" are the only grommet and PowerPort locations that apply to curvilinear returns. Please note these locations are not applicable on the 36" deep top and fixed modesty panel.

Guest Side



Guest Side



Position code:  
AL - left corner on right hand return  
AR - right corner on left hand return

Curvilinear desk grommets and PowerPorts can only be specified in "C" position.



User Side



User Side



User Side

Position Code: C center

## Crescent Return Grommets

Grommets and PowerPorts are available on Crescent returns.

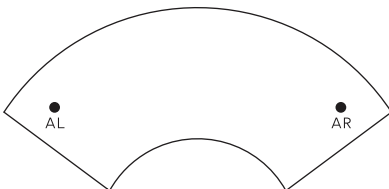

Position Code:  
AL - left corner on return  
AR - right corner on return

# ARTEMIS | SAMPLE CONFIGURATIONS

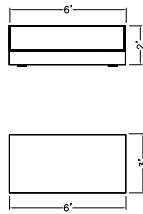
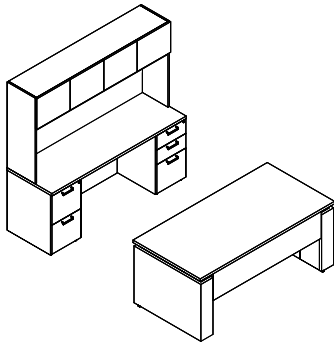

	Model	Rift Oak or Palette w/ Wood or Lam Top & Wood Edge	C,M,W w/ Wood or Lam Top & Wood Edge
Height Adj. Desk	76HA7236ETSGV21	6184	6493
Hutch	76HT721640	3292	3456
Credenza	76CY72244LDRF	4048	4252
<b>TOTAL</b>		13524	14201

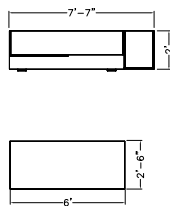
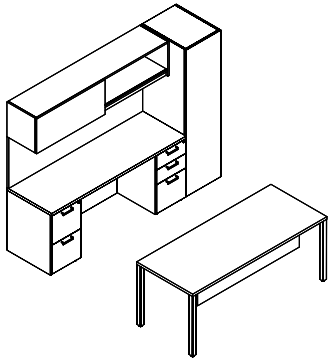

	Model	Rift Oak or Palette w/ Wood or Lam Top & Wood Edge	C,M,W w/ Wood or Lam Top & Wood Edge
Desk	76TD7230MV21	2713	2848
Overhead	76OSW721616	2140	2249
Tackboard	76TBOHW7224	512	512
Credenza	76CY72244LDRF	4048	4252
Storage	76ST19246911R	3076	3231
<b>TOTAL</b>		12489	13092

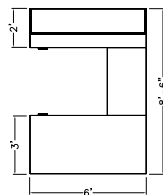
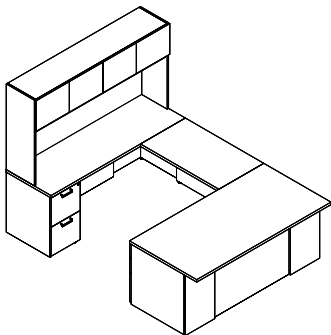

	Model	Rift Oak or Palette w/ Wood or Lam Top & Wood Edge	C,M,W w/ Wood or Lam Top & Wood Edge
Desk	76D72364L0RF	3491	3665
Link Unit	76LU4224HX41	1312	1377
Hutch	76HT721640	3292	3456
Credenza	76CY72244LDR0	3767	3955
<b>TOTAL</b>		11862	12453

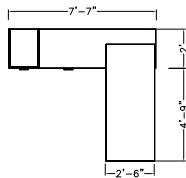
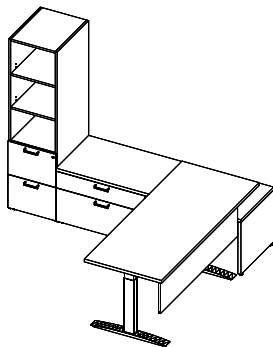

	Model	Rift Oak or Palette w/ Wood or Lam Top & Wood Edge	C,M,W w/ Wood or Lam Top & Wood Edge
Height Adj. Desk	76HA7230ETSO16V21	4286	4499
Credenza	76CY72203L3611R0	3090	3376
Storage	76ST19246990	3112	3267
<b>TOTAL</b>		10488	11142

# ARTEMIS | DESKS

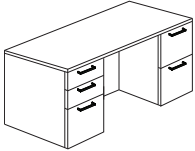
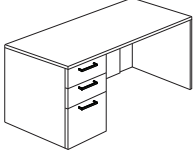
Description	Model	Rift Oak or	Rift Oak or	C,M,W w/	C,M,W w/	W	D	H	KW	Shipping Cubic	
		Palette w/ Lam Top & Polymer Edge	Palette w/ Wood or Lam Top & Wood Edge	C,M,W w/ Lam Top & Polymer Edge	C,M,W w/ Wood or Lam Top & Wood Edge					Weight	Feet
	76D60304LDRF	3743	3856	3931	4048	59.75	30	29.5	28.5	218	39
	76D60304LFRD	3743	3856	3931	4048	59.75	30	29.5	28.5	218	39
	76D60304LFRF	3743	3856	3931	4048	59.75	30	29.5	28.5	218	39
	76D66304LDRF	3771	3885	3959	4079	65.75	30	29.5	34.5	224	42.75
	76D66304LFRD*	3771	3885	3959	4079	65.75	30	29.5	34.5	224	42.75
	76D66304LFRF	3771	3885	3959	4079	65.75	30	29.5	34.5	224	42.75
	76D66364LDRF	3790	3906	3981	4099	65.75	36	29.5	34.5	236	50
	76D66364LFRD	3790	3906	3981	4099	65.75	36	29.5	34.5	236	50
	76D66364LFRF	3790	3906	3981	4099	65.75	36	29.5	34.5	236	50
	76D72304LDRF	3803	3918	3993	4112	71.75	30	29.5	40.5	246	46.5
	76D72304LFRD	3803	3918	3993	4112	71.75	30	29.5	40.5	246	46.5
	76D72304LFRF	3803	3918	3993	3981	71.75	30	29.5	40.5	246	46.5
	76D72364LDRF	3844	3959	4036	4155	71.75	36	29.5	40.5	248	54.75
	76D72364LFRD	3844	3959	4036	4155	71.75	36	29.5	40.5	248	54.75
	76D72364LFRF	3844	3959	4036	4155	71.75	36	29.5	40.5	248	54.75
	76D78304LDRF	3865	3981	4058	4179	77.75	30	29.5	46.5	248	50
	76D78304LFRD	3865	3981	4058	4179	77.75	30	29.5	46.5	248	50
	76D78304LFRF	3865	3981	4058	4179	77.75	30	29.5	46.5	248	50
	76D78364LDRF	3890	4005	4083	4207	77.75	36	29.5	46.5	248	59
	76D78364LFRD	3890	4005	4083	4207	77.75	36	29.5	46.5	248	59
76D78364LFRF	3890	4005	4083	4207	77.75	36	29.5	46.5	248	59	
76D84304LFRF	3589	3697	3768	3881	83.75	30	29.5	52.5	311	53.75	
76D84304LDRF	3589	3697	3768	3881	83.75	30	29.5	52.5	306	53.75	
76D84304LFRD	3589	3697	3768	3881	83.75	30	29.5	52.5	306	53.75	
76D84364LDRF	3907	4024	4103	4224	83.75	36	29.5	52.5	272	63	
76D84364LFRD	3907	4024	4103	4224	83.75	36	29.5	52.5	272	63	
76D84364LFRF	3907	4024	4103	4224	83.75	36	29.5	52.5	272	63	
	76D60304LFR0	3278	3376	3441	3543	59.75	30	29.5	43	206	39
	76D60304LORF	3278	3376	3441	3543	59.75	30	29.5	43	206	39
	76D66304LFR0*	3305	3403	3471	3575	65.75	30	29.5	49	212	42.75
	76D66304LORF	3305	3403	3471	3575	65.75	30	29.5	49	212	42.75
	76D66364LFR0	3333	3431	3501	3605	65.75	36	29.5	49	224	50
	76D66364LORF	3333	3431	3501	3605	65.75	36	29.5	49	224	50
	76D72304LFR0	3339	3433	3505	3608	71.75	30	29.5	55	224	46.5
	76D72304LORF	3339	3433	3505	3608	71.75	30	29.5	55	224	46.5
	76D72364LFR0	3389	3491	3561	3665	71.75	36	29.5	55	236	54.75
	76D72364LORF	3389	3491	3561	3665	71.75	36	29.5	55	236	54.75
	76D78304LFR0*	3410	3512	3580	3687	77.75	30	29.5	61	236	50
	76D78304LORF	3410	3512	3580	3687	77.75	30	29.5	61	236	50
	76D78364LFR0	3449	3553	3620	3731	77.75	36	29.5	61	242	59
	76D78364LORF	3449	3553	3620	3731	77.75	36	29.5	61	242	59
	76D84304LFR0	3437	3541	3609	3717	83.75	30	29.5	67	251	53.75
	76D84304LORF	3437	3541	3609	3717	83.75	30	29.5	67	251	53.75
76D84364LFR0	3490	3596	3665	3773	83.75	36	29.5	67	260	63	
76D84364LORF	3490	3596	3665	3773	83.75	36	29.5	67	260	63	

\*\* shows overhang on 36" Desks

### ORDERING PROCEDURE

To order, please specify the following:

- 1) Krug product model number
- 2) Wood species and finish, see page 11
- 3) Wood edge detail- I,H, L or P, see Page 3
- 4) Pull style, see Page 4
- 5) Grommet location if applicable

\*Indicates model illustrated by line drawing.

### CODE DESCRIPTION

- 4 - full height pedestal
- D - 2 file drawers
- F - 2 box, 1 file drawer
- L - left handed pedestal position
- R - right handed pedestal position
- 0 - no pedestal



### STANDARD FINISHES

For a complete list of standard wood finishes please see page 117.

### GROMMETS

One grommet in standard position is optional at no charge. Additional rectangular grommets are available at an upcharge of **\$152 list**.

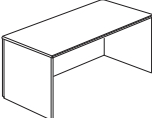
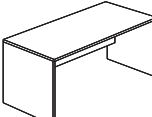
# ARTEMIS | DESKS

Description	Model	Rift Oak or	Rift Oak or	C,M,W w/	C,M,W w/	W	D	H	KW	Shipping Cubic	
		Palette w/ Lam Top & Polymer Edge	Wood or Lam Top & Wood Edge	C,M,W w/ Lam Top & Polymer Edge	Wood or Lam Top & Wood Edge					Weight	Feet
	76SD6030X41	2321	2388	2436	2508	59.75	30	29.5	57.5	154	39
	76SD6630X41*	2347	2418	2464	2538	65.75	30	29.5	63.5	198	42.75
	76SD6636X41	2376	2445	2493	2568	65.75	36	29.5	63.5	215	50
	76SD7230X41	2405	2476	2524	2597	71.75	30	29.5	69.5	210	46.5
	76SD7236X41	2431	2503	2553	2631	71.75	36	29.5	69.5	228	54.75
	76SD7830X41	2473	2549	2596	2673	77.75	36	29.5	69.5	241	59
	76SD7836X41	2489	2564	2613	2694	77.75	36	29.5	75.5	241	59
	76SD8436X41	2527	2602	2654	2735	83.75	36	29.5	81.5	254	63
	76SD6030X31	2277	2343	2390	2461	59.75	30	29.5	57.5	146	39
	76SD6630X31*	2301	2369	2415	2488	65.75	30	29.5	63.5	198	42.75
	76SD6636X31	2327	2396	2444	2517	65.75	36	29.5	63.5	215	50
	76SD7230X31	2354	2422	2471	2543	71.75	30	29.5	69.5	210	46.5
	76SD7236X31	2382	2451	2500	2574	71.75	36	29.5	69.5	228	54.75
	76SD7830X31	2423	2497	2548	2623	71.75	36	29.5	75.5	228	54.75
	76SD7836X31	2443	2516	2564	2640	77.75	36	29.5	75.5	241	59
	76SD8436X31	2478	2551	2601	2680	83.75	36	29.5	81.5	254	63
	BT76D6030	397	408	416	428	59.75	36	-	-	68	1
	BT76D6630	412	427	435	448	65.75	36	-	-	73	1.25
	BT76D6636	434	446	455	468	65.75	42	-	-	84	1.25
	BT76D7230*	452	465	476	487	71.75	36	-	-	79	1.5
	BT76D7236	464	478	487	501	71.75	42	-	-	91	1.5
	BT76D7830	434	448	455	470	77.75	36	-	-	251	59
	BT76D7836	481	494	508	520	77.75	42	-	-	98	1.5
	BT76D8436	487	501	512	529	83.75	42	-	-	105	1.75

**DIMENSION KEY**

W - width  
D - depth  
H - height

**CODE DESCRIPTION**

X41 - full height modesty  
X31 - 3/4 height modesty panel

**STANDARD FINISHES**

For a complete list of standard wood finishes please see Page 117.

# ARTEMIS | CURVILINEAR DESKS

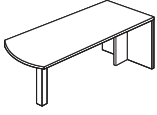
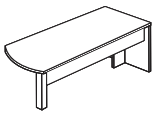
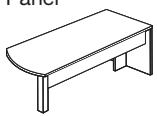
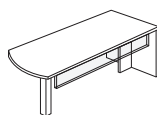
Description	Model	Rift Oak or	Rift Oak or	C,M,W w/		W	D	H	KW	Shipping Cubic		
		Palette w/ Lam Top & Polymer Edge	Wood or Lam Top & Wood Edge	C,M,W w/ Lam Top & Polymer Edge	Wood or Lam Top & Wood Edge					Weight	Feet	
	Arc Desk with Square Wood Leg and no Modesty Panel	76DA6030S1	2279	2346	2391	2463	59.75	30	29.5	32	117	39.25
		76DA6630S1	2488	2563	2612	2692	65.75	30	29.5	38	126	42.75
		76DA6636S1	2508	2585	2635	2715	65.75	36	29.5	35	146	50
		76DA7230S1*	2532	2608	2659	2740	71.75	30	29.5	44	132	46.5
		76DA7236S1	2587	2665	2716	2798	71.75	36	29.5	41	155	54.75
		76DA7830S1	2614	2695	2745	2829	77.75	30	29.5	50	141	50
		76DA7836S1	2632	2712	2763	2846	77.75	36	29.5	47	163	59
		76DA8430S1	2642	2723	2776	2859	83.75	30	29.5	56	154	53.75
		76DA8436S1	2682	2763	2816	2899	83.75	36	29.5	53	178	63
		Arc Desk with Square Wood Leg and 1/2 Height Floating Wood Modesty Panel	76DA6030LV21S1	2433	2506	2555	2634	59.75	30	29.5	32	127
		76DA6030RV21S1	2433	2506	2555	2634	59.75	30	29.5	32	127	39.25
		76DA6630LV21S1	2681	2761	2815	2898	65.75	30	29.5	38	135	42.75
		76DA6630RV21S1	2681	2761	2815	2898	65.75	30	29.5	38	135	42.75
		76DA7230LV21S1	2728	2810	2866	2952	71.75	30	29.5	44	142	46.5
		76DA7230RV21S1	2728	2810	2866	2952	71.75	30	29.5	44	142	46.5
		76DA7830LV21S1	2787	2872	2926	3014	77.75	30	29.5	50	150	50
		76DA7830RV21S1*	2787	2872	2926	3014	77.75	30	29.5	50	150	50
		76DA8430LV21S1	2842	2927	2984	3073	83.75	30	29.5	56	158	53.75
		76DA8430RV21S1	2842	2927	2984	3073	83.75	30	29.5	56	158	53.75
	Arc Desk with Square Wood Leg, 1/2 Height Fixed Wood Modesty Panel	76DA6636X21S1	2705	2787	2839	2924	65.75	36	29.5	35	148	50
		76DA7236X21S1 *	2787	2872	2926	3014	71.75	36	29.5	41	158	54.75
		76DA7836X21S1	2848	2934	2991	3080	77.75	36	29.5	47	168	59
		76DA8436X21S1	2910	2996	3056	3145	83.75	36	29.5	53	186	63
	Arc Desk with Square Wood Leg and 1/2 Height Floating Acrylic Modesty Panel	76DA6030LV29S1	2433	2506	2555	2634	59.75	30	29.5	32	121	39.25
		76DA6030RV29S1	2433	2506	2555	2634	59.75	30	29.5	32	121	39.25
		76DA6630LV29S1	2681	2761	2815	2898	65.75	30	29.5	38	131	42.75
		76DA6630RV29S1	2681	2761	2815	2898	65.75	30	29.5	38	131	42.75
		76DA6636LV29S1	2705	2787	2839	2924	65.75	36	29.5	35	150	50
		76DA6636RV29S1	2705	2787	2839	2924	65.75	36	29.5	35	150	50
		76DA7230LV29S1	2728	2810	2866	2952	71.75	30	29.5	44	138	46.5
		76DA7230RV29S1	2728	2810	2866	2952	71.75	30	29.5	44	138	46.5
		76DA7236LV29S1	2787	2872	2926	3014	71.75	36	29.5	41	160	54.75
		76DA7236RV29S1*	2787	2872	2926	3014	71.75	36	29.5	41	160	54.75
		76DA7830LV29S1	2818	2903	2959	3047	77.75	30	29.5	50	147	50
		76DA7830RV29S1	2818	2903	2959	3047	77.75	30	29.5	50	147	50
		76DA7836LV29S1	2838	2924	2982	3070	77.75	36	29.5	47	169	59
		76DA7836RV29S1	2838	2924	2982	3070	77.75	36	29.5	47	169	59
	76DA8430LV29S1	2848	2934	2991	3080	83.75	30	29.5	56	162	53.75	
	76DA8430RV29S1	2848	2934	2991	3080	83.75	30	29.5	56	162	53.75	
	76DA8436LV29S1	2907	2994	3053	3142	83.75	36	29.5	53	186	63	
	76DA8436RV29S1	2907	2994	3053	3142	83.75	36	29.5	53	186	63	

**ORDERING NOTES:**

Curvilinear/Curved corner desks are not stand alone cases. They must be used in conjunction with returns or linking units. All Desks with a "S1" at the end of the model number are available with a 4" diameter metal leg, please replace "S1" with a "D8" to the existing model number ie: 76DA8436D8. All Desks with a "S1" at the end of the model number are available with a Panel Leg, please replace "S1" with "P1" in the model number ie: 76DA8436P1

**ORDERING PROCEDURE**

To order, please specify the following:

- 1) Krug product model number
- 2) Wood species and finish, see Page 11
- 3) Wood edge detail- I,H, L or P, see Page 3
- 4) Pull style, see Page 4
- 5) Grommet location if applicable

\*Indicates model illustrated by line drawing.

**CODE DESCRIPTION**

- S1 - square wood leg
- V21 - 1/2 height floating wood modesty panel
- X21 - 1/2 height fixed wood modesty panel
- D8 - 4" diameter metal leg
- P1 - panel leg

**STANDARD FINISHES**

For a complete list of standard wood finishes please see Page 117.

**GROMMETS**

One grommet in standard position is optional at no charge. Additional rectangular grommets are available at an upcharge of \$152 list.

# ARTEMIS | CURVILINEAR DESKS

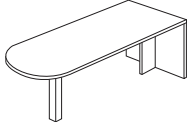
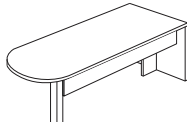
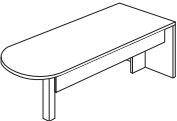
Description	Model	Rift Oak or	Rift Oak or	C,M,W w/		W	D	H	KW	Shipping Cubic	
		Palette w/ Lam Top & Polymer Edge	Wood or Lam Top & Wood Edge	C,M,W w/ Lam Top & Polymer Edge	Wood or Lam Top & Wood Edge					Weight	Feet
Bullet Desk with Square Wood Leg and no Modesty Panel  	76DB6030S1	2441	2515	2563	2639	59.75	30	29.5	32	117	39
	76DB6036S1	2462	2535	2586	2663	59.75	36	29.5	29	135	46
	76DB6630S1	2488	2563	2612	2692	65.75	30	29.5	38	124	42.75
	76DB6636S1	2508	2585	2635	2715	65.75	36	29.5	35	144	50
	76DB7230S1*	2532	2608	2659	2740	71.75	30	29.5	44	130	46.5
	76DB7236S1	2587	2665	2716	2798	71.75	36	29.5	41	153	54.75
	76DB7836S1	2632	2712	2763	2846	77.75	36	29.5	47	161	59
	76DB8436S1	2682	2763	2816	2899	83.75	36	29.5	53	176	63
Bullet Desk with Square Wood Leg and 1/2 Height Wood Floating Modesty Panel  	76DB6030LV21S1	2631	2710	2761	2845	59.75	30	29.5	32	127	39
	76DB6030RV21S1	2631	2710	2761	2845	59.75	30	29.5	32	127	39
	76DB6630LV21S1	2681	2761	2815	2898	65.75	30	29.5	38	135	42.75
	76DB6630RV21S1	2681	2761	2815	2898	65.75	30	29.5	38	135	42.75
	76DB7230LV21S1	2728	2810	2866	2952	71.75	30	29.5	44	144	46.5
	76DB7230RV21S1*	2728	2810	2866	2952	71.75	30	29.5	44	144	46.5
	76DB7830LV21S1	2787	2872	2926	3014	77.75	30	29.5	50	153	50
	76DB7830RV21S1	2787	2872	2926	3014	77.75	30	29.5	50	153	50
Bullet Desk with Square Wood Leg and 1/2 Height Fixed Wood Modesty Panel  	76DB6036X21S1	2652	2734	2783	2867	59.75	36	29.5	29	134	46
	76DB6636X21S1	2705	2787	2839	2924	65.75	36	29.5	35	146	50
	76DB7236X21S1*	2787	2872	2783	2867	71.75	36	29.5	41	156	54.75
	76DB7836X21S1	2848	2934	2839	2924	77.75	36	29.5	47	166	59
	76DB8436X21S1	2910	2996	2783	2867	83.75	36	29.5	53	176	63

**ORDERING NOTES:**

Curvilinear/Curved corner desks are not stand alone cases. They must be used in conjunction with returns or linking units. All Desks with a "S1" at the end of the model number are available with a 4" diameter metal leg, please replace "S1" with a "D8" to the existing model number ie: 76DB8436D8. All Desks with a "S1" at the end of the model number are available with a Panel Leg, please replace "S1" with "P1" in the model number ie: 76DB8436P1

DIMENSION KEY	CODE DESCRIPTION	STANDARD FINISHES
W - width	S1 - square wood leg	For a complete list of standard wood finishes please see Page 117.
D - depth	V29 - 1/2 height floating acrylic modesty panel	
H - height	V21 - 1/2 height floating wood modesty panel	
	D8 - 4" diameter metal leg	
	P1 - panel leg	

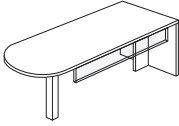
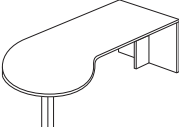
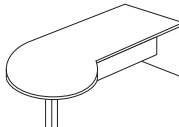

# ARTEMIS | CURVILINEAR DESKS

Description	Model	Rift Oak or		C,M,W w/		W	D	H	KW	Shipping Cubic	
		Palette w/ Lam Top & Polymer Edge	Wood or Lam Top & Wood Edge	C,M,W w/ Lam Top & Polymer Edge	Wood or Lam Top & Wood Edge					Weight	Feet
 Bullet Desk with Square Wood Leg and 1/2 Height Floating Acrylic Modesty Panel	76DB6030LV29S1	2631	2710	2761	2845	59.75	30	29.5	32	121	39
	76DB6030RV29S1	2631	2710	2761	2845	59.75	30	29.5	32	121	39
	76DB6036LV29S1	2652	2734	2783	2867	59.75	36	29.5	29	135	46
	76DB6036RV29S1	2652	2734	2783	2867	59.75	36	29.5	29	135	46
	76DB6630LV29S1	2681	2761	2815	2898	65.75	30	29.5	38	129	42.75
	76DB6630RV29S1	2681	2761	2815	2898	65.75	30	29.5	38	129	42.75
	76DB6636LV29S1	2705	2787	2839	2924	65.75	36	29.5	35	148	50
	76DB6636RV29S1	2705	2787	2839	2924	65.75	36	29.5	35	148	50
	76DB7230LV29S1	2728	2810	2866	2952	71.75	30	29.5	44	136	46.5
	76DB7230RV29S1*	2728	2810	2866	2952	71.75	30	29.5	44	136	46.5
	76DB7236LV29S1	2787	2872	2926	3014	71.75	36	29.5	41	158	54.75
	76DB7236RV29S1	2787	2872	2926	3014	71.75	36	29.5	41	158	54.75
	76DB7830LV29S1	2818	2903	2959	3047	77.75	30	29.5	50	145	50
	76DB7830RV29S1	2818	2903	2959	3047	77.75	30	29.5	50	145	50
	76DB7836LV29S1	2838	2924	2982	3070	77.75	36	29.5	47	167	59
	76DB7836RV29S1	2838	2924	2982	3070	77.75	36	29.5	47	167	59
	76DB8430LV29S1	2848	2934	2991	3080	83.75	30	29.5	56	160	53.75
	76DB8430RV29S1	2848	2934	2991	3080	83.75	30	29.5	56	160	53.75
76DB8436LV29S1	2907	2994	3053	3142	83.75	36	29.5	53	184	63	
76DB8436RV29S1	2907	2994	3053	3142	83.75	36	29.5	53	184	63	
 P Desk with Square Wood Leg and no Modesty Panel	76DP6636LS1	3103	3195	3259	3355	65.75	42	29.5	32	156	57.75
	76DP6636RS1	3103	3195	3259	3355	65.75	42	29.5	32	156	57.75
	76DP7236LS1	3242	3341	3404	3507	71.75	42	29.5	38	166	62.75
	76DP7236RS1	3242	3341	3404	3507	71.75	42	29.5	38	166	62.75
	76DP7836LS1	3307	3405	3472	3577	77.75	42	29.5	44	173	67.75
	76DP7836RS1	3307	3405	3472	3577	77.75	42	29.5	44	173	67.75
	76DP8436LS1	3369	3470	3538	3643	83.75	42	29.5	50	182	72.75
76DP8436RS1*	3369	3470	3538	3643	83.75	42	29.5	50	182	72.75	
 P-Desk with Square Wood Leg and 1/2 Height Floating Wood Modesty Panel	76DP6630RV21S1	3173	3268	3330	3432	65.75	42	29.5	32	156	57.75
	76DP6630LV21S1	3173	3268	3330	3432	65.75	42	29.5	32	156	57.75
	76DP7230LV21S1	3244	3342	3405	3509	71.75	30	29.5	38	140	54.75
	76DP7230RV21S1*	3244	3342	3405	3509	71.75	30	29.5	38	140	54.75
	76DP7830LV21S1	3313	3411	3479	3582	77.75	42	29.5	44	173	67.75
	76DP7830RV21S1	3313	3411	3479	3582	77.75	42	29.5	44	173	67.75
	76DP8430LV21S1	3383	3484	3553	3658	83.75	42	29.5	32	182	72.75
76DP8430RV21S1	3383	3484	3553	3658	83.75	42	29.5	32	182	72.75	

**ORDERING NOTES:**

Curvilinear/Curved corner desks are not stand alone cases. They must be used in conjunction with returns or linking units. All Desks with a "S1" at the end of the model number are available with a 4" diameter metal leg, please replace "S1" with a "D8" to the existing model number ie: 76DP8436RD8. All Desks with a "S1" at the end of the model number are available with a Panel Leg, please replace "S1" with "P1" in the model number ie: 76DP8436RP1

**ORDERING PROCEDURE**

To order, please specify the following:

- 1) Krug product model number
- 2) Wood species and finish, see Page 11
- 3) Wood edge detail- I,H, L or P, see Page 3
- 4) Pull style, see Page 4
- 5) Grommet location if applicable

**CODE DESCRIPTION**

- S1 - square wood leg
- X21 - 1/2 height fixed wood modesty panel
- V29 - 1/2 height floating acrylic modesty panel
- L - left handed position
- R - right handed position
- D8 - 4" diameter metal leg
- P1 - panel leg

**STANDARD FINISHES**

For a complete list of standard wood finishes please see Page 117.

**GROMMETS**

One grommet in standard position is optional at no charge. Additional rectangular grommets are available at an upcharge of **\$152 list.**

# ARTEMIS | CURVILINEAR DESKS

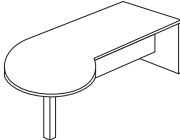
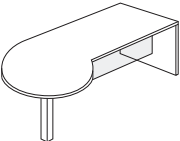
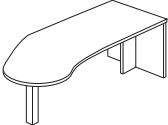
Description	Model	Rift Oak or	Rift Oak or	C,M,W w/		W	D	H	KW	Shipping Weight	Cubic Feet	
		Palette w/ Lam Top & Polymer Edge	Wood or Lam Top & Wood Edge	C,M,W w/ Lam Top & Polymer Edge	C,M,W w/ Lam Top & Wood Edge							
	P Desk with Square Wood Leg and 1/2 Height Fixed Wood Modesty Panel	76DP6636LX21S1	3353	3454	3520	3627	65.75	42	29.5	32	156	57.75
		76DP6636RX21S1	3353	3454	3520	3627	65.75	42	29.5	32	156	57.75
		76DP7230LX21S1	3244	3342	3405	3509	71.75	30	29.5	38	145	54.75
		76DP7230RX21S1*	3244	3342	3405	3509	71.75	30	29.5	38	145	54.75
		76DP7236LX21S1	3499	3606	3673	3785	71.75	42	29.5	38	166	62.75
		76DP7236RX21S1	3499	3606	3673	3785	71.75	42	29.5	38	166	62.75
		76DP7836LX21S1	3568	3679	3748	3862	77.75	42	29.5	44	178	67.75
		76DP7836RX21S1	3568	3679	3748	3862	77.75	42	29.5	44	178	67.75
		76DP8436LX21S1	3639	3748	3820	3935	83.75	42	29.5	50	188	72.75
		76DP8436RX21S1	3639	3748	3820	3935	83.75	42	29.5	50	188	72.75
	P Desk with Square Wood Leg and 1/2 Height Floating Acrylic Modesty Panel	76DP6636LV29S1	3353	3454	3520	3627	65.75	42	29.5	32	159	57.75
		76DP6636RV29S1	3353	3454	3520	3627	65.75	42	29.5	32	59	57.75
		76DP7236LV29S1	3499	3606	3673	3785	71.75	42	29.5	38	168	62.75
		76DP7236RV29S1	3499	3606	3673	3785	71.75	42	29.5	38	168	62.75
		76DP7836LV29S1	3568	3679	3748	3862	77.75	42	29.5	44	178	67.75
		76DP7836RV29S1*	3568	3679	3748	3862	77.75	42	29.5	44	178	67.75
		76DP8436LV29S1	3639	3748	3820	3935	83.75	42	29.5	50	183	72.75
		76DP8436RV29S1	3639	3748	3820	3935	83.75	42	29.5	50	183	72.75
	J Desk with Square Wood Leg	76DJ7233LS1	3242	3341	3404	3507	71.75	33	29.5	36	136	62.75
		76DJ7233RS1	3242	3341	3404	3507	71.75	33	29.5	36	136	62.75
		76DJ7833LS1	3307	3405	3472	3577	77.75	33	29.5	42	144	62.75
		76DJ7833RS1	3307	3405	3472	3577	77.75	33	29.5	42	144	62.75
		76DJ8433LS1	3369	3470	3538	3643	83.75	33	29.5	48	152	72.75
		76DJ8433RS1*	3369	3470	3538	3643	83.75	33	29.5	48	152	72.75

**ORDERING NOTES:**

Curvilinear/Curved corner desks are not stand alone cases. They must be used in conjunction with returns or linking units. All Desks with a "S1" at the end of the model number are available with a 4" diameter metal leg, please replace "S1" with a "D8" to the existing model number ie: 76DJ8433RD8. All Desks with a "S1" at the end of the model number are available with a Panel Leg, please replace "S1" with "P1" in the model number ie: 76DJ8433RP1

**DIMENSION KEY**

W - width  
D - depth  
H - height

**CODE DESCRIPTION**

S1 - square wood leg  
V21 - 1/2 height floating wood modesty panel  
X21 - 1/2 height fixed wood modesty panel  
V29 - 1/2 height floating acrylic modesty panel  
L - left handed position  
R - right handed position  
D8 - 4" diameter metal leg  
P1 - panel leg

**STANDARD FINISHES**

For a complete list of standard wood finishes please see Page 117.

# ARTEMIS | CURVED CORNER DESKS

Description	Model	Rift Oak or	Rift Oak or	C,M,W w/	C,M,W w/	W	D	H	KW	Shipping Cubic	
		Palette w/ Lam Top & Polymer Edge	Palette w/ Wood or Lam Top & Wood Edge	Lam Top & Polymer Edge	Lam Top & Wood Edge					Weight	Feet
Curved Corner Arc Desk with Square Wood Leg and no Modesty Panel	76UDA723048R24LS1	3686	3796	3870	3987	71.75	48	29.5	31	192	71
	76UDA723048L24RS1	3686	3796	3870	3987	71.75	48	29.5	31	192	71
	76UDA783048R24LS1	3728	3841	3915	4033	77.75	48	29.5	37	185	76.75
	76UDA783048L24RS1	3728	3841	3915	4033	77.75	48	29.5	37	185	76.75
	76UDA843048R24LS1	3767	3880	3955	4072	83.75	48	29.5	43	191	82
	76UDA843048L24RS1*	3767	3880	3955	4072	83.75	48	29.5	43	191	82



Curved Corner Arc Desk with Square Wood Leg and 1/2 Height Floating Wood Modesty Panel	76UDA723048R24LV21S1	3981	4099	4180	4306	71.75	48	29.5	31	195	71
	76UDA723048L24RV21S1	3981	4099	4180	4306	71.75	48	29.5	31	195	71
	76UDA783048R24LV21S1	4022	4142	4223	4350	77.75	48	29.5	37	205	76.75
	76UDA783048L24RV21S1	4022	4142	4223	4350	77.75	48	29.5	37	205	76.75
	76UDA843048R24LV21S1	4064	4185	4267	4395	83.75	48	29.5	43	223	82
	76UDA843048L24RV21S1*	4064	4185	4267	4395	83.75	48	29.5	43	223	82



Curved Corner Bullet Desk with Square Wood Leg and no Modesty Panel	76UDB723048R24LS1	3686	3796	3870	3987	71.75	48	29.5	31	184	71
	76UDB723048L24RS1	3686	3796	3870	3987	71.75	48	29.5	31	184	71
	76UDB783048R24LS1	3728	3841	3915	4033	77.75	48	29.5	37	192	76.75
	76UDB783048L24RS1	3728	3841	3915	4033	77.75	48	29.5	37	192	76.75
	76UDB843048R24LS1	3767	3880	3955	4072	83.75	48	29.5	43	208	82
	76UDB843048L24RS1*	3767	3880	3955	4072	83.75	48	29.5	43	208	82



Curved Corner Bullet Desk with Square Wood Leg and 1/2 Height Floating Wood Modesty Panel	76UDB723048R24LV21S1	3981	4099	4180	4306	71.75	48	29.5	31	195	71
	76UDB723048L24RV21S1	3981	4099	4180	4306	71.75	48	29.5	31	195	71
	76UDB783048R24LV21S1	4022	4142	4223	4350	77.75	48	29.5	37	205	76.75
	76UDB783048L24RV21S1	4022	4142	4223	4350	77.75	48	29.5	37	205	76.75
	76UDB843048R24LV21S1	4064	4185	4267	4395	83.75	48	29.5	43	223	82
	76UDB843048L24RV21S1*	4064	4185	4267	4395	83.75	48	29.5	43	223	82



### ORDERING NOTES:

Curved corner desks are not stand alone cases. They must be used in conjunction with returns or linking units. All Desks with a "S1" at the end of the model number are available with a 4" diameter metal leg, please replace "S1" with a "D8" to the existing model number ie: 76UDA843048L24RD8. All Desks with a "S1" at the end of the model number are available with a Panel Leg, please replace "S1" with "P1" in the model number ie: 76UDA843048L24RP1. For U-shaped configuration see page 57, Curved Corner Credenza.

### ORDERING PROCEDURE

To order, please specify the following:

- 1) Krug product model number
- 2) Wood species and finish, see Page 11
- 3) Wood edge detail- I,H, L or P, see Page 3
- 4) Pull style, see Page 4
- 5) Grommet location if applicable

### CODE DESCRIPTION

S1 - square wood leg  
 V21 - 1/2 height floating wood modesty panel  
 L - left handed position  
 R - right handed position  
 D8 - 4" diameter metal leg  
 P1 - panel leg

### STANDARD FINISHES

For a complete list of standard wood finishes please see Page 117.

### GROMMETS

One grommet in standard position is optional at no charge. Additional rectangular grommets are available at an upcharge of **\$152 list.**

# ARTEMIS | CURVED CORNER DESKS

Description	Model	Rift Oak or	Rift Oak or	C,M,W w/		W	D	H	KW	Shipping	
		Palette w/ Lam Top & Polymer Edge	Palette w/ Wood or Lam Top & Wood Edge	C,M,W w/ Lam Top & Polymer Edge	C,M,W w/ Wood or Lam Top & Wood Edge					Weight	Feet
	76UDP663648R24LS1	3701	3814	3886	4003	65.75	48	29.5	22	168	65.5
	76UDP663648L24RS1	3701	3814	3886	4003	65.75	48	29.5	22	168	65.5
	76UDP723648R24LS1	3783	3894	3970	4089	71.75	48	29.5	28	177	71
	76UDP723648L24RS1	3783	3894	3970	4089	71.75	48	29.5	28	177	71
	76UDP783648R24LS1	3845	3960	4037	4156	77.75	48	29.5	34	186	76.75
	76UDP783648L24RS1	3845	3960	4037	4156	77.75	48	29.5	34	186	76.75
	76UDP843648R24LS1	3906	4023	4102	4223	83.75	48	29.5	40	202	82
	76UDP843648L24RS1*	3906	4023	4102	4223	83.75	48	29.5	40	202	82

	76UDP663648R24LX21S1	3983	4103	4183	4310	65.75	48	29.5	22	172	65.5
	76UDP663648L24RX21S1	3983	4103	4183	4310	65.75	48	29.5	22	172	65.5
	76UDP723648R24LX21S1	4065	4186	4268	4396	71.75	48	29.5	28	182	71
	76UDP723648L24RX21S1	4065	4186	4268	4396	71.75	48	29.5	28	182	71
	76UDP783648R24LX21S1	4128	4249	4334	4461	77.75	48	29.5	34	192	76.75
	76UDP783648L24RX21S1	4128	4249	4334	4461	77.75	48	29.5	34	192	76.75
	76UDP843648R24LX21S1	4186	4312	4396	4529	83.75	48	29.5	40	204	82
	76UDP843648L24RX21S1*	4186	4312	4396	4529	83.75	48	29.5	40	204	82

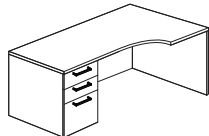
	76UD723042L24RF	3409	3510	3579	3685	71.75	42	29.5	32	269	62.75
	76UD723042R24LF*	3409	3510	3579	3685	71.75	42	29.5	32	269	62.75
	76UD783042L24RF	3479	3581	3654	3761	77.75	42	29.5	38	279	67.75
	76UD783042R24LF	3479	3581	3654	3761	77.75	42	29.5	38	279	67.75
	76UD843042L24RF	3546	3655	3724	3839	83.75	42	29.5	44	289	72.75
	76UD843042R24LF	3546	3655	3724	3839	83.75	42	29.5	44	289	72.75

**ORDERING NOTES:**

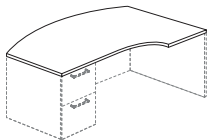
	BT76UD723048L*	449	464	473	486	71.75	48		1.13	88	6.25
	BT76UD723048R	449	464	473	486	71.75	48		1.13	88	6.25
	BT76UD783048L	468	483	491	509	77.75	48		1.13	95	6.75
	BT76UD783048R	468	483	491	509	77.75	48		1.13	95	6.75
	BT76UD843048L	486	500	511	527	83.75	48		1.13	105	7.25
	BT76UD843048R	486	500	511	527	83.75	48		1.13	105	7.25

**ORDERING NOTES:**

Curved corner desks are not stand alone cases. They must be used in conjunction with returns or linking units. All Desks with a "S1" at the end of the model number are available with a 4" diameter metal leg, please replace "S1" with a "D8" to the existing model number ie: 76UDA843048L24RD8. All Desks with a "S1" at the end of the model number are available with a Panel Leg, please replace "S1" with "P1" in the model number ie: 76UDA843048L24RP1. For U-shaped configuration see page xx, Curved Corner Credenza.

**DIMENSION KEY**

W - width  
D - depth  
H - height



**CODE DESCRIPTION**

S1 - square wood leg  
X21 - 1/2 height fixed wood modesty panel  
L - left handed position  
R - right handed position  
D8 - 4" diameter metal leg  
P1 - panel leg

**STANDARD FINISHES**

For a complete list of standard wood finishes please see Page 117.

# ARTEMIS | TABLE DESKS

Description	Model	Rift Oak or	Rift Oak or	C,M,W w/	C,M,W w/	W	D	H	KW	Shipping Cubic		
		Palette w/ Lam Top & Polymer Edge	Palette w/ Wood or Lam Top & Wood Edge	C,M,W w/ Lam Top & Polymer Edge	C,M,W w/ Wood or Lam Top & Wood Edge					Weight	Feet	
	Table Desk with 4" Rectangular Gables	76TD6030	2227	2294	2339	2408	59.75	30	29.5	52	177	41
	76TD6036	2670	2748	2804	2888	59.75	30	29.5	52	190	41	
	76TD6630	2449	2523	2570	2649	65.75	36	29.5	58	198	45.75	
	76TD6636	2937	3028	3087	3179	65.75	36	29.5	58	198	45.75	
	76TD7230	2670	2748	2804	2888	71.75	36	29.5	64	228	54	
	76TD7236*	3121	3215	3278	3376	71.75	36	29.5	64	228	54	
	76TD7830	2818	2903	2958	3047	77.75	30	29.5	70	241	58.5	
	76TD7836	3173	3268	3330	3432	77.75	36	29.5	70	241	58.5	
	76TD8430	3127	3219	3283	3382	83.75	30	29.5	76	254	63	
	76TD8436	3229	3323	3388	3491	83.75	36	29.5	76	254	63	
	Table Desk with 4" Rectangular Gables & 1/2 Ht. Floating Wood Modesty Panel	76TD6030V21	2313	2383	2430	2503	59.75	30	29.5	52	177	41
	76TD6036V21	2776	2859	2916	3003	59.75	30	29.5	52	190	41	
	76TD6630V21	2543	2620	2671	2751	65.75	36	29.5	58	198	45.75	
	76TD6636V21	3054	3144	3207	3303	65.75	36	29.5	58	198	45.75	
	76TD7230V21*	2776	2859	2916	3003	71.75	36	29.5	64	228	54	
	76TD7236V21	3246	3344	3409	3510	71.75	36	29.5	64	228	54	
	76TD7830V21	3208	3304	3368	3469	77.75	30	29.5	70	241	58.5	
	76TD7836V21	3303	3402	3468	3573	77.75	36	29.5	70	241	58.5	
	76TD8430V21	2964	3054	3112	3207	83.75	30	29.5	76	254	63	
	76TD8436V21	3355	3456	3522	3630	83.75	36	29.5	76	254	63	
	Table Desk with 4" Rectangular Gables & 1/2 Ht. Floating Acrylic Modesty Panel	76TD6030V29	2405	2476	2524	2601	59.75	30	29.5	52	177	41
	76TD6036V29	2883	2969	3029	3118	59.75	30	29.5	52	190	41	
	76TD6630V29	2642	2721	2776	2859	65.75	30	29.5	58	198	45.75	
	76TD6636V29	3172	3267	3329	3431	65.75	36	29.5	58	198	45.75	
	76TD7230V29	2883	2969	3029	3118	71.75	30	29.5	64	228	54	
	76TD7236V29*	3368	3470	3537	3643	71.75	36	29.5	64	228	54	
	76TD7830V29	3040	3134	3193	3290	77.75	30	29.5	70	241	58.5	
	76TD7836V29	3429	3533	3602	3709	77.75	36	29.5	70	241	58.5	
	76TD8430V29	3077	3167	3232	3327	83.75	30	29.5	76	254	63	
	76TD8436V29	3486	3588	3661	3768	83.75	36	29.5	76	254	63	

**ORDERING PROCEDURE**

To order, please specify the following:

- 1) Krug product model number
- 2) Wood species and finish, see Page 11
- 3) Wood edge detail- I,H, L or P, see Page 3
- 4) Pull style, see Page 4
- 5) Grommet location if applicable

**CODE DESCRIPTION**

V21 - 1/2 height floating wood modesty panel  
 V29 - 1/2 height floating acrylic modesty panel



**STANDARD FINISHES**

For a complete list of standard wood finishes please see Page 117.

**GROMMETS**

One grommet in standard position is optional at no charge. Additional rectangular grommets are available at an upcharge of **\$152 list.**

**ARTEMIS | TABLE DESKS**

Description	Model	Rift Oak or	Rift Oak or	C,M,W w/		W	D	H	KW	Shipping Weight	Cubic Feet
		Palette w/ Lam Top & Polymer Edge	Palette w/ Wood or Lam Top & Wood Edge	C,M,W w/ Lam Top & Polymer Edge	C,M,W w/ Wood or Lam Top & Wood Edge						
Table Desk with 2" Square Metal Leg 	76TD6030M	2109	2172	2215	2281	59.75	30	29.5	56	173	41
	76TD6036M	2531	2608	2658	2739	59.75	30	29.5	56	173	41
	76TD6630M	2321	2390	2436	2508	65.75	30	29.5	62	198	45.75
	76TD6636M	2783	2866	2922	3011	65.75	36	29.5	62	198	45.75
	76TD7230M	2531	2608	2658	2739	71.75	30	29.5	68	228	54
	76TD7236M*	2968	3057	3117	3210	71.75	36	29.5	68	228	54
	76TD7830M	2957	3045	3104	3197	77.75	30	29.5	74	241	58.5
	76TD7836M	3022	3112	3172	3268	77.75	36	29.5	74	241	58.5
	76TD8430M	2713	2793	2848	2933	83.75	30	29.5	80	254	63
	76TD8436M	3074	3165	3229	3323	83.75	36	29.5	80	254	63
Table Desk with 2" Square Metal Leg & 1/2 Ht. Floating Wood Modesty Panel 	76TD6030MV21	2195	2263	2306	2376	59.75	30	29.5	56	173	41
	76TD6036MV21	2635	2714	2767	2849	59.75	30	29.5	56	173	41
	76TD6630MV21	2415	2488	2535	2611	65.75	30	29.5	62	198	45.75
	76TD6636MV21	2896	2985	3040	3134	65.75	36	29.5	62	198	45.75
	76TD7230MV21	2634	2713	2765	2848	71.75	30	29.5	68	228	54
	76TD7236MV21*	3090	3239	3341	3497	71.75	36	29.5	68	228	54
	76TD7830MV21	3067	3159	3219	3315	77.75	30	29.5	74	241	58.5
	76TD7836MV21	3141	3237	3299	3398	77.75	36	29.5	74	241	58.5
	76TD8430MV21	2820	2906	2962	3052	83.75	30	29.5	80	254	63
	76TD8436MV21	3252	3352	3415	3519	83.75	36	29.5	80	254	63
Table Desk with 2" Square Metal Leg & 1/2 Ht. Floating Acrylic Modesty Panel 	76TD6030MV29	2279	2347	2391	2464	59.75	30	29.5	56	173	41
	76TD6036MV29	2738	2818	2873	2958	59.75	30	29.5	56	173	41
	76TD6630MV29	2506	2581	2632	2713	65.75	30	29.5	62	198	45.75
	76TD6636MV29	3009	3099	3160	3252	65.75	36	29.5	62	198	45.75
	76TD7230MV29	2738	2818	2873	2958	71.75	30	29.5	68	228	54
	76TD7236MV29*	3207	3303	3367	3468	71.75	36	29.5	68	228	54
	76TD7830MV29	3172	3267	3330	3430	77.75	30	29.5	74	241	58.5
	76TD7836MV29	3266	3363	3429	3532	77.75	36	29.5	74	241	58.5
	76TD8430MV29	2929	3016	3076	3167	83.75	30	29.5	80	254	63
	76TD8436MV29	3379	3481	3546	3654	83.75	36	29.5	80	254	63

**DIMENSION KEY**

W - width  
D - depth  
H - height

**CODE DESCRIPTION**

V21 - 1/2 height floating wood modesty panel  
V29 - 1/2 height floating acrylic modesty panel

**STANDARD FINISHES**

For a complete list of standard wood finishes please see Page 117.

# ARTEMIS | HEIGHT ADJUSTABLE DESKS

Description	Model	Laminate Top & Polymer Edge	Rift Oak Wood Edge	C,M,W w/ Wood or Lam Top & Wood Edge	W	D	H	KW	Shipping Cubic	
				Edge					Weight	Feet
Electronic Height Adjustable Worksurface	76HA3024ETS	2757	2973	2983	29.75	24	-	17	108.5	11.5
	76HA3624ETS	2833	2920	3066	35.75	24	-	23	109	14
	76HA4224ETS	2886	2972	3121	41.75	24	-	29	109	16.5
	76HA4824ETS	2947	3036	3186	47.75	24	-	35	109.5	19
	76HA5424ETS	2987	3077	3232	53.5	24	-	41	110	21.5
	76HA6024ETS	3068	3160	3316	59.75	24	-	47	111	24
	76HA6624ETS	3285	3382	3553	65.75	24	-	53	114	26.5
	76HA7224ETS	3439	3542	3718	71.75	24	-	59	119.5	29
	76HA7824ETS	3555	3662	3845	77.75	24	-	65	122.5	31.5
	76HA8424ETS	3624	3733	3919	83.75	24	-	71	127	34
	76HA3030ETS	2884	3097	3120	29.75	30	-	17	121.5	36.75
	76HA3630ETS	2956	3043	3195	35.75	30	-	23	122	14.25
	76HA4230ETS	3008	3096	3251	41.75	30	-	29	122	17.5
	76HA4830ETS	3070	3162	3321	47.75	30	-	35	122.5	20.5
	76HA5430ETS	3129	3221	3383	53.5	30	-	41	123	23.5
	76HA6030ETS	3197	3294	3458	59.75	30	-	47	124	26.5
	76HA6630ETS	3356	3457	3631	65.75	30	-	53	131	29.75
	76HA7230ETS	3508	3610	3792	71.75	30	-	59	132.5	32.75
	76HA7830ETS*	3630	3739	3924	77.75	30	-	65	142.5	35.75
	76HA8430ETS	3701	3814	4003	83.75	30	-	71	143.5	38.75
	76HA3036ETS	3061	3156	3312	29.75	36	-	17	121.5	42
	76HA3636ETS	3112	3206	3366	35.75	36	-	23	122	45.5
	76HA4236ETS	3158	3251	3412	41.75	36	-	29	122	17.25
	76HA4836ETS	3245	3343	3509	47.75	36	-	35	122.5	20.75
	76HA5436ETS	3312	3410	3580	53.5	36	-	41	123	24.5
	76HA6036ETS	3374	3476	3648	59.75	36	-	47	124	28.25
	76HA6636ETS	3507	3609	3790	65.75	36	-	53	134	32
	76HA7236ETS	3622	3732	3918	71.75	36	-	59	151.5	35.5
	76HA7836ETS	3907	4023	4224	77.75	36	-	65	158.5	39.25
	76HA8436ETS	3991	4111	4316	83.75	36	-	71	159.5	43

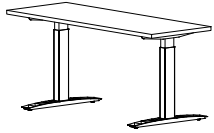

**ORDERING NOTES:**

To order a height adjustable work surface with a top overhang of 16" at one end add O16 to the end of the model number. eg. 76HA6024ETSO16. Please note that this option is not available on electronic height adjustable work surfaces that are 42" or less in length. This option is not available on dual stage electronic height adjustable worksurfaces.

To order a dual stage height adjustable base **add \$674 to the list price** and replace ETS with ETD. eg. 76HA6030ETD. Lifts come standard with an up/down button. Standard color is silver, please contact customer service for other available colors. A 4 position programmable display is available, please see page 597 for price and model number. Standard base is a T-base. A C base can be specified at the same price. To order a C-base on worksurfaces, up to 30" deep only, replace "T" with "C" e.g. 76HA4830ECS.

Single stage mechanism height adjustable range: 26" - 45.5"

Dual stage mechanism height adjustable range: 21" - 47"

**ORDERING PROCEDURE**

To order, please specify the following:

- 1) Krug product model number
- 2) Wood species and finish, see Page 11
- 3) Wood edge detail- I,H, L or P, see Page 3
- 4) Pull style, see Page 4
- 5) Grommet location if applicable

**CODE DESCRIPTION**

- ETS - electric T- base single stage
- O16 - top overhang of 16"
- D - dual stage height adjustable base
- C - C- base

**STANDARD FINISHES**

For a complete list of standard wood finishes please see Page 117.

**GROMMETS**

One grommet in standard position is optional at no charge. Additional rectangular grommets are available at an upcharge of **\$152 list.**

# ARTEMIS | HEIGHT ADJUSTABLE DESKS

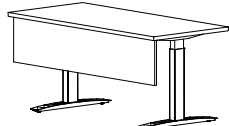
Description	Model	Rift Oak or	Rift Oak or	C,M,W w/		W	D	H	KW	Shipping Weight	Cubic Feet
		Palette w/ Lam Top & Polymer Edge	Wood or Lam Top & Wood Edge	C,M,W w/ Lam Top & Polymer Edge	Wood or Lam Top & Wood Edge						
Electronic Height Adjustable Worksurface, Floating Wood Modesty Panel 	76HA3024ETSV21	3188	3286	3348	3449	29.75	24	-	17	114.5	11.5
	76HA3624ETSV21	3193	3290	3353	3455	35.75	24	-	23	117	14
	76HA4224ETSV21	3307	3405	3471	3577	41.75	24	-	29	118	16.5
	76HA4824ETSV21	3428	3532	3599	3708	47.75	24	-	35	119.5	19
	76HA5424ETSV21	3529	3634	3706	3816	53.5	24	-	41	122	21.5
	76HA6024ETSV21	3704	3814	3888	4004	59.75	24	-	47	124	24
	76HA6624ETSV21	3921	4039	4117	4242	65.75	24	-	53	128	26.5
	76HA7224ETSV21	4090	4214	4294	4424	71.75	24	-	59	134.5	29
	76HA7824ETSV21	4217	4345	4428	4562	77.75	24	-	65	139.5	31.5
	76HA8424ETSV21	4297	4428	4513	4649	83.75	24	-	71	145	34
	76HA3030ETSV21	3311	3409	3473	3579	29.75	30	-	17	127.5	36.75
	76HA3630ETSV21	3316	3415	3484	3587	35.75	30	-	23	130	14.25
	76HA4230ETSV21	3428	3532	3599	3708	41.75	30	-	29	131	17.5
	76HA4830ETSV21	3553	3658	3731	3843	47.75	30	-	35	132.5	20.5
	76HA5430ETSV21	3668	3780	3851	3966	53.5	30	-	41	135	23.5
	76HA6030ETSV21	3831	3949	4024	4145	59.75	30	-	47	137	26.5
	76HA6630ETSV21	3995	4114	4193	4319	65.75	30	-	53	145	29.75
	76HA7230ETSV21	4160	4286	4368	4499	71.75	30	-	59	147.5	32.75
	76HA7830ETSV21*	4292	4422	4507	4643	77.75	30	-	65	159.5	35.75
	76HA8430ETSV21	4377	4507	4595	4734	83.75	30	-	71	161.5	38.75
	76HA3036ETSV21	3363	3462	3532	3636	29.75	36	-	17	127.5	42
76HA3636ETSV21	3472	3578	3646	3756	35.75	36	-	23	130	45.5	
76HA4236ETSV21	3577	3684	3756	3867	41.75	36	-	29	131	17.25	
76HA4836ETSV21	3724	3839	3911	4029	47.75	36	-	35	132.5	20.75	
76HA5436ETSV21	3851	3966	4042	4167	53.5	36	-	41	135	24.5	
76HA6036ETSV21	4008	4130	4209	4336	59.75	36	-	47	137	28.25	
76HA6636ETSV21	4143	4268	4352	4481	65.75	36	-	53	148	32	
76HA7236ETSV21	4274	4401	4487	4622	71.75	36	-	59	166.5	35.5	
76HA7836ETSV21	4571	4709	4798	4944	77.75	36	-	65	175.5	39.25	
76HA8436ETSV21	4667	4810	4900	5047	83.75	36	-	71	177.5	43	

**ORDERING NOTES:**

To order a height adjustable work surface with a top overhang of 16" at one end insert O16 into the model number after ETS. eg. 76HA6024ETSO16V21. Please note that this option is not available on electronic height adjustable work surfaces that are 42" or less in length. This option is not available on dual stage electronic height adjustable worksurfaces.

To order a dual stage height adjustable base **add \$674 to the list price** and replace ETS with ETD. eg. 76HA6030ETDV21.

Lifts come standard with an up/down button. Standard color is silver, please contact customer service for other available colors. A 4 position programable display is available, please see page 597 for price and model number. Standard base is a T-base. A C base can be specified at the same price. To order a C-base on worksurfaces, up to 30" deep only, replace "T" with "C" e.g. 76HA3030ECV21

Single stage mechanism height adjustable range: 26" - 45.5" Dual stage mechanism height adjustable range: 21" - 47"

Modesty Panel options (replace "V21" with suffix below)

- Floating Laminate V26
- Floating Palette V22
- Floating Acrylic V29
- Full Fixed Wood X41

DIMENSION KEY	CODE DESCRIPTION	STANDARD FINISHES
W - width	ETS - electric T- base single stage	For a complete list of standard wood finishes please see Page 117.
D - depth	V21- half height floating wood modesty panel	
H - height	O16 - top overhang of 16"	
	D - dual stage height adjustable base	
	C - C- base	



# ARTEMIS | HEIGHT ADJUSTABLE DESKS

Description	Model	Rift Oak or	Rift Oak or	C,M,W w/	C,M,W w/	W	D	H	KW	Shipping Cubic	
		Palette w/ Lam Top & Polymer Edge	Palette w/ Wood or Lam Top & Wood Edge	C,M,W w/ Lam Top & Polymer Edge	C,M,W w/ Wood or Lam Top & Wood Edge					Weight	Feet
Electronic Height	76HA4224ETSG	4654	4793	4887	5034	41.75	24	-	24	154	16.5
Adjustable Worksurface,	76HA4824ETSG	4713	4857	4949	5098	47.75	24	-	30	154.5	19
Base Enclosures	76HA5424ETSG	4756	4899	4994	5142	53.5	24	-	36	155	21.5
	76HA6024ETSG	4835	4979	5078	5230	59.75	24	-	42	156	24
	76HA6624ETSG	5053	5205	5305	5465	65.75	24	-	48	159	26.5
	76HA7224ETSG	5209	5364	5469	5633	71.75	24	-	54	164.5	29
	76HA7824ETSG	5322	5481	5588	5757	77.75	24	-	60	167.5	31.5
	76HA8424ETSG	5392	5554	5661	5831	83.75	24	-	66	172	34
	76HA4230ETSG	4986	5135	5235	5391	41.75	30	-	24	177	17.5
	76HA4830ETSG	5049	5201	5300	5460	47.75	30	-	30	177.5	20.5
	76HA5430ETSG	5107	5259	5362	5523	53.5	30	-	36	178	23.5
	76HA6030ETSG	5176	5331	5436	5598	59.75	30	-	42	179	26.5
	76HA6630ETSG	5336	5496	5603	5768	65.75	30	-	48	186	29.75
	76HA7230ETSG	5483	5649	5758	5932	71.75	30	-	54	187.5	32.75
	76HA7830ETSG*	5607	5773	5888	6063	77.75	30	-	60	197.5	35.75
	76HA8430ETSG	5884	6059	6179	6361	83.75	30	-	66	198.5	38.75
	76HA4236ETSG	5338	5498	5605	5771	41.75	36	-	24	187	17.25
	76HA4836ETSG	5427	5589	5696	5868	47.75	36	-	30	187.5	20.75
	76HA5436ETSG	5494	5658	5767	5940	53.5	36	-	36	188	24.5
	76HA6036ETSG	5556	5721	5834	6008	59.75	36	-	42	189	28.25
	76HA6636ETSG	5688	5859	5971	6153	65.75	36	-	48	199	32
	76HA7236ETSG	5602	5767	5881	6055	71.75	36	-	54	216.5	35.5
	76HA7836ETSG	6088	6270	6392	6584	77.75	36	-	60	223.5	39.25
	76HA8436ETSG	6171	6358	6480	6676	83.75	36	-	66	224.5	43

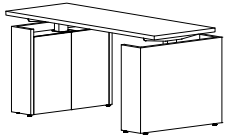

**ORDERING NOTES:**

To order a height adjustable work surface with a top overhang of 16" at one end insert O16 into the model number after ETS. eg. 76HA6024ETSO16G. Please note that this option is not available on height adjustable work surfaces that have base enclosures and are 48" or less in length. This option is not available on dual stage electronic height adjustable worksurfaces.

To order a dual stage height adjustable base **add \$674 to the list price** and replace ETS with ETD. eg. 76HA6030ETDG. Lifts come standard with an up/down button. Standard color is silver, please contact customer service for other available colors. A 4 position programable display is available, please see page 597 for price and model number.

Single stage height adjustable range: 26" - 45.5"

Dual stage height adjustable range: 21" - 47"

**ORDERING PROCEDURE**

To order, please specify the following:

- 1) Krug product model number
- 2) Wood species and finish, see Page 11
- 3) Wood edge detail- I,H, L or P, see Page 3
- 4) Pull style, see Page 4
- 5) Grommet location if applicable

\*Indicates model illustrated by line drawing.

**CODE DESCRIPTION**

ETSG - electric T- base single stage with base enclosure  
 O16 - top overhang of 16"  
 D - dual stage height adjustable base  
 C - C- base

**STANDARD FINISHES**

For a complete list of standard wood finishes please see Page 117.

**GROMMETS**

One grommet in standard position is optional at no charge. Additional rectangular grommets are available at an upcharge of **\$152 list.**

# ARTEMIS | HEIGHT ADJUSTABLE DESKS

Description	Model	Rift Oak or	Rift Oak or	C,M,W w/		W	D	H	KW	Shipping Weight	Cubic Feet
		Palette w/ Lam Top & Polymer Edge	Palette w/ Wood Lam Top & Wood Edge	C,M,W w/ Lam Top & Polymer Edge	C,M,W w/ Wood Lam Top & Wood Edge						
Electronic Height Adjustable Worksurface,	76HA4224ETSGV21	4917	5063	5160	5316	41.75	24	-	24	163	16.5
Base Enclosure, Floating Wood Modesty Panel	76HA4824ETSGV21	4988	5138	5238	5393	47.75	24	-	30	164.5	19
	76HA5424ETSGV21	5040	5191	5293	5453	53.5	24	-	36	167	21.5
	76HA6024ETSGV21	5137	5288	5392	5554	59.75	24	-	42	169	24
	76HA6624ETSGV21	5367	5529	5636	5806	65.75	24	-	48	173	26.5
	76HA7224ETSGV21	5538	5705	5814	5991	71.75	24	-	54	179.5	29
	76HA7824ETSGV21	5673	5841	5957	6135	77.75	24	-	60	184.5	31.5
	76HA8424ETSGV21	5758	5931	6046	6227	83.75	24	-	66	90	34
	76HA4230ETSGV21	5244	5403	5507	5673	41.75	30	-	24	186	17.5
	76HA4830ETSGV21	5322	5481	5588	5756	47.75	30	-	30	187.5	20.5
	76HA5430ETSGV21	5392	5554	5661	5831	53.5	30	-	36	190	23.5
	76HA6030ETSGV21	5477	5641	5751	5923	59.75	30	-	42	192	26.5
	76HA6630ETSGV21	5650	5821	5933	6111	65.75	30	-	48	200	29.75
	76HA7230ETSGV21	5814	5991	6107	6290	71.75	30	-	54	202.5	32.75
	76HA7830ETSGV21*	5955	6135	6253	6440	77.75	30	-	60	214.5	35.75
	76HA8430ETSGV21	6247	6436	6560	6758	83.75	30	-	66	216.5	38.75
	76HA4236ETSGV21	5598	5765	5876	6053	41.75	36	-	24	196	17.25
	76HA4836ETSGV21	5698	5869	5985	6163	47.75	36	-	30	197.5	20.75
	76HA5436ETSGV21	5781	5954	6070	6250	53.5	36	-	36	200	24.5
	76HA6036ETSGV21	5857	6033	6149	6334	59.75	36	-	42	202	28.25
	76HA6636ETSGV21	6003	6184	6303	6493	65.75	36	-	48	213	32
	76HA7236ETSGV21	5932	6109	6228	6414	71.75	36	-	54	231.5	35.5
	76HA7836ETSGV21	6438	6630	6760	6962	77.75	36	-	60	240.5	39.25
	76HA8436ETSGV21	6539	6734	6864	7071	83.75	36	-	66	242.5	43

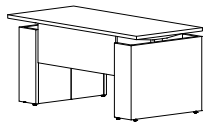

**ORDERING NOTES:**

To order a height adjustable work surface with a top overhang of 16" at one end insert O16 into the model number after ETS. eg. 76HA6024ETSO16GV21. Please note that this option is not available on height adjustable work surfaces that have base enclosures and are 48" or less in length. This option is not available on dual stage electronic height adjustable worksurfaces.

To order a dual stage height adjustable base **add \$674 to the list price** and replace ETS with ETD. eg.76HA6030ETDGV21.

Lifts come standard with an up/down button. Standard color is silver, please contact customer service for other available colors.

A 4 position programable display is available, please see page 597 for price and model number.

Single stage height adjustable range: 26" - 45.5"

Dual stage height adjustable range: 21" - 47"

Modesty Panel options (replace "V21" with suffix below)

Floating Laminate	V26
Floating Palette	V22
Floating Acrylic	V29
Full Fixed Wood	X41

**DIMENSION KEY**

W - width  
D - depth  
H - height

**CODE DESCRIPTION**

ETS - electric T- base single stage  
V21- half height floating wood modesty panel  
O16 - top overhang of 16"  
D - dual stage height adjustable base  
C - C- base

**STANDARD FINISHES**

For a complete list of standard wood finishes please see Page 117.

# ARTEMIS | HEIGHT ADJUSTABLE RETURNS

Description	Model	Laminate		C,M,W w/ Wood or Lam Top & Wood Edge						
		Top & Polymer Edge	Rift Oak Wood Edge	Wood Edge	Wood Edge					
Electronic Height	76HA4824RHETS	2947	3036	3186	47.75	24	-	35	109.5	19
Adjustable Return (cross grain) Worksurface	76HA5424RHETS	2987	3077	3232	53.5	24	-	41	110	21.5
	76HA6024RHETS	3068	3160	3316	59.75	24	-	47	111	24
	76HA6624RHETS	3285	3382	3553	65.75	24	-	53	114	26.5
	76HA7224RHETS	3439	3542	3718	71.75	24	-	59	119.5	29
	76HA7824RHETS	3555	3662	3845	77.75	24	-	65	122.5	31.5
	76HA8424RHETS	3624	3733	3919	83.75	24	-	71	127	34
	76HA4830RHETS	3070	3162	3321	47.75	30	-	35	122.5	20.5
	76HA5430RHETS	3129	3221	3383	53.5	30	-	41	123	23.5
	76HA6030RHETS	3197	3294	3458	59.75	30	-	47	124	26.5
	76HA6630RHETS	3356	3457	3631	65.75	30	-	53	131	29.75
	76HA7230RHETS	3508	3610	3792	71.75	30	-	59	132.5	32.75
	76HA7830RHETS*	3630	3739	3924	77.75	30	-	65	142.5	35.75
	76HA8430RHETS	3701	3814	4003	83.75	30	-	71	143.5	38.75
	76HA4836RHETS	3245	3343	3509	47.7	36	-	35	122.5	20.75
	76HA5436RHETS	3312	3410	3580	53.5	36	-	41	123	24.5
	76HA6036RHETS	3374	3476	3648	59.75	36	-	47	124	28.25
	76HA6636RHETS	3507	3609	3790	65.75	36	-	53	134	32
	76HA7236RHETS	3622	3732	3918	71.75	36	-	59	151.5	35.5
	76HA7836RHETS	3907	4023	4224	77.75	36	-	65	158.5	39.25
	76HA8436RHETS	3991	4111	4316	83.75	36	-	71	159.5	43

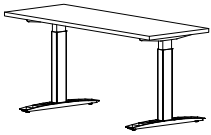

**ORDERING NOTES:**

To order a height adjustable work surface with a top overhang of 16" at one end add O16 to the end of the model number. eg. 76HA6024ETSO16. Please note that this option is not available on electronic height adjustable work surfaces that are 42" or less in length. This option is not available on dual stage electronic height adjustable worksurfaces.

To order a dual stage height adjustable base **add \$674 to the list price** and replace ETS with ETD.

Please contact customer service for other available colors. A 4 position programmable display is available, please see page 79 for price and model number. Standard base is a T-base. A C base can be specified at the same price. To order a C-base on worksurfaces, up to 30" deep only, replace "T" with "C" e.g. 76HA4830ECS.

Single stage mechanism height adjustable range: 26" - 45.5"

Dual stage mechanism height adjustable range: 21" - 47"

**ORDERING PROCEDURE**

To order, please specify the following:

- 1) Krug product model number
- 2) Wood species and finish, see Page 11
- 3) Wood edge detail- I,H, L or P, see Page 3
- 4) Pull style, see Page 4
- 5) Grommet location if applicable

\*Indicates model illustrated by line drawing.

**CODE DESCRIPTION**

- ETS - electric T- base single stage
- O16 - top overhang of 16"
- D - dual stage height adjustable base
- C - C- base

**STANDARD FINISHES**

For a complete list of standard wood finishes please see Page 117.

**GROMMETS**

One grommet in standard position is optional at no charge. Additional rectangular grommets are available at an upcharge of **\$152 list.**

# ARTEMIS | HEIGHT ADJUSTABLE RETURNS

Description	Model	Rift Oak or	Rift Oak or	C,M,W w/		W	D	H	KW	Shipping Weight	Cubic Feet
		Palette w/ Lam Top & Polymer Edge	Palette w/ Wood Lam Top & Wood Edge	C,M,W w/ Lam Top & Polymer Edge	C,M,W w/ Wood Lam Top & Wood Edge						
Electronic Height Adjustable Return (cross grain) Worksurface, Floating Wood Modesty Panel	76HA4824RHETSV21	3428	3532	3599	3708	47.75	24	-	30	164.5	19
	76HA5424RHETSV21	3529	3634	3706	3816	53.5	24	-	36	167	21.5
	76HA6024RHETSV21	3704	3814	3888	4004	59.75	24	-	42	169	24
	76HA6624RHETSV21	3921	4039	4117	4242	65.75	24	-	48	173	26.5
	76HA7224RHETSV21	4090	4214	4294	4424	71.75	24	-	54	179.5	29
	76HA7824RHETSV21	4217	4345	4428	4562	77.75	24	-	60	184.5	31.5
	76HA8424RHETSV21	4297	4428	4513	4649	83.75	24	-	66	90	34
	76HA4830RHETSV21	3553	3658	3731	3843	47.75	30	-	30	187.5	20.5
	76HA5430RHETSV21	3668	3780	3851	3966	53.5	30	-	36	190	23.5
	76HA6030RHETSV21	3831	3949	4024	4145	59.75	30	-	42	192	26.5
	76HA6630RHETSV21	3995	4114	4193	4319	65.75	30	-	48	200	29.75
	76HA7230RHETSV21	4160	4286	4368	4499	71.75	30	-	54	202.5	32.75
	76HA7830RHETSV21*	4292	4422	4507	4643	77.75	30	-	60	214.5	35.75
	76HA8430RHETSV21	4377	4507	4595	4734	83.75	30	-	66	216.5	38.75
	76HA4836RHETSV21	3724	3839	3911	4029	47.75	36	-	30	197.5	20.75
	76HA5436RHETSV21	3851	3966	4042	4167	53.5	36	-	36	200	24.5
	76HA6036RHETSV21	4008	4130	4209	4336	59.75	36	-	42	202	28.25
	76HA6636RHETSV21	4143	4268	4352	4481	65.75	36	-	48	213	32
	76HA7236RHETSV21	4274	4401	4487	4622	71.75	36	-	54	231.5	35.5
	76HA7836RHETSV21	4571	4709	4798	4944	77.75	36	-	60	240.5	39.25
	76HA8436RHETSV21	4667	4810	4900	5047	83.75	36	-	66	242.5	43

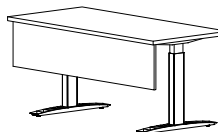

**ORDERING NOTES:**

To order a height adjustable work surface with a top overhang of 16" at one end insert O16 into the model number after ETS. eg. 76HA6024ETSO16V21. Please note that this option is not available on electronic height adjustable work surfaces that are 42" or less in length. This option is not available on dual stage electronic height adjustable worksurfaces.

To order a dual stage height adjustable base **add \$674 to the list price** and replace ETS with ETD. eg. 76HA6030ETDV21.

Lifts come standard with an up/down button. Standard colors are Silver Metallic & Black, please contact customer service for other available colors. A 4 position programmable display is available, please see page 79 for price and model number. Standard base is a T-base. A C-base can be specified at the same price. To order a C-base on worksurfaces, up to 30" deep only, replace "T" with "C" e.g. 76HA3030ECSV21

Single stage mechanism height adjustable range: 26" - 45.5" Dual stage mechanism height adjustable range: 21" - 47"

Modesty Panel options (replace "V21" with suffix below)

Floating Laminate	V26
Floating Palette	V22
Floating Acrylic	V29
Full Fixed Wood	X41

**DIMENSION KEY**

W - width  
D - depth  
H - height

**CODE DESCRIPTION**

ETS - electric T- base single stage  
V21- half height floating wood modesty panel  
O16 - top overhang of 16"  
D - dual stage height adjustable base  
C - C- base

**STANDARD FINISHES**

For a complete list of standard wood finishes please see Page 117.

# ARTEMIS | HEIGHT ADJUSTABLE RETURNS

Description	Model	Rift Oak or	Rift Oak or	C,M,W w/	C,M,W w/	W	D	H	KW	Shipping Weight	Cubic Feet
		Palette w/ Lam Top & Polymer Edge	Palette w/ Wood Lam Top & Wood Edge	C,M,W w/ Lam Top & Polymer Edge	C,M,W w/ Wood Lam Top & Wood Edge						
Electronic Height Adjustable Return (cross grain) Worksurface, Base Enclosures	76HA4824RHETSG	4713	4857	4949	5098	47.75	24	-	30	154.5	19
	76HA5424RHETSG	4756	4899	4994	5142	53.5	24	-	36	155	21.5
	76HA6024RHETSG	4835	4979	5078	5230	59.75	24	-	42	156	24
	76HA6624RHETSG	5053	5205	5305	5465	65.75	24	-	48	159	26.5
	76HA7224RHETSG	5209	5364	5469	5633	71.75	24	-	54	164.5	29
	76HA7824RHETSG	5322	5481	5588	5757	77.75	24	-	60	167.5	31.5
	76HA8424RHETSG	5392	5554	5661	5831	83.75	24	-	66	172	34
	76HA4830RHETSG	5049	5201	5300	5460	47.75	30	-	30	177.5	20.5
	76HA5430RHETSG	5107	5259	5362	5523	53.5	30	-	36	178	23.5
	76HA6030RHETSG	5176	5331	5436	5598	59.75	30	-	42	179	26.5
	76HA6630RHETSG	5336	5496	5603	5768	65.75	30	-	48	186	29.75
	76HA7230RHETSG	5483	5649	5758	5932	71.75	30	-	54	187.5	32.75
	76HA7830RHETSG*	5607	5773	5888	6063	77.75	30	-	60	197.5	35.75
	76HA8430RHETSG	5884	6059	6179	6361	83.75	30	-	66	198.5	38.75
	76HA4836RHETSG	5427	5589	5696	5868	47.7	36	-	35	187.5	20.75
	76HA5436RHETSG	5494	5658	5767	5940	53.5	36	-	41	188	24.5
	76HA6036RHETSG	5556	5721	5834	6008	59.75	36	-	47	189	28.25
	76HA6636RHETSG	5688	5859	5971	6153	65.75	36	-	53	199	32
	76HA7236RHETSG	5602	5767	5881	6055	71.75	36	-	59	216.5	35.5
	76HA7836RHETSG	6088	6270	6392	6584	77.75	36	-	65	223.5	39.25
	76HA8436RHETSG	6171	6358	6480	6676	83.75	36	-	71	224.5	43

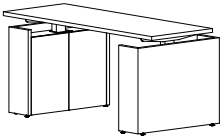

**ORDERING NOTES:**

To order a height adjustable work surface with a top overhang of 16" at one end add O16 to the end of the model number. eg. 76HA6024ETSO16G. Please note that this option is not available on electronic height adjustable work surfaces that are 42" or less in length. This option is not available on dual stage electronic height adjustable worksurfaces.

To order a dual stage height adjustable base **add \$674 to the list price** and replace ETS with ETD. eg. 76HA6030ETD. Lifts come standard with an up/down button. Standard colors are Silver Metallic & Black, please contact customer service for other available colors. A 4 position programmable display is available, please see page 79 for price and model number.

Single stage height adjustable range: 26" - 45.5"  
 Dual stage height adjustable range: 21" - 47"

**ORDERING PROCEDURE**

To order, please specify the following:

- 1) Krug product model number
- 2) Wood species and finish, see Page 11
- 3) Wood edge detail, see Page 3
- 4) Pull style, see Page 4
- 5) Grommet location if applicable

\*Indicates model illustrated by line drawing.

**CODE DESCRIPTION**

ETSG - electric T- base single stage with base enclosure  
 O16 - top overhang of 16"  
 D - dual stage height adjustable base  
 C - C- base

**STANDARD FINISHES**

For a complete list of standard wood finishes please see Page 117.

**GROMMETS**

One grommet in standard position is optional at no charge. Additional rectangular grommets are available at an upcharge of **\$152 list.**

# ARTEMIS | HEIGHT ADJUSTABLE RETURNS

Description	Model	Rift Oak or	Rift Oak or	C,M,W w/		W	D	H	KW	Shipping Weight	Cubic Feet
		Palette w/ Lam Top & Polymer Edge	Palette w/ Wood Lam Top & Wood Edge	C,M,W w/ Lam Top & Polymer Edge	C,M,W w/ Wood Lam Top & Wood Edge						
Electronic Height Adjustable Return (cross grain) Worksurface, Base Enclosure, Floating Wood Modesty Panel	76HA4824RHETSGV21	4988	5138	5238	5393	47.75	24	-	30	164.5	19
	76HA5424RHETSGV21	5040	5191	5293	5453	53.5	24	-	36	167	21.5
	76HA6024RHETSGV21	5137	5288	5392	5554	59.75	24	-	42	169	24
	76HA6624RHETSGV21	5367	5529	5636	5806	65.75	24	-	48	173	26.5
	76HA7224RHETSGV21	5538	5705	5814	5991	71.75	24	-	54	179.5	29
	76HA7824RHETSGV21	5673	5841	5957	6135	77.75	24	-	60	184.5	31.5
	76HA8424RHETSGV21	5758	5931	6046	6227	83.75	24	-	66	90	34
	76HA4830RHETSGV21	5322	5481	5588	5756	47.75	30	-	30	187.5	20.5
	76HA5430RHETSGV21	5392	5554	5661	5831	53.5	30	-	36	190	23.5
	76HA6030RHETSGV21	5477	5641	5751	5923	59.75	30	-	42	192	26.5
	76HA6630RHETSGV21	5650	5821	5933	6111	65.75	30	-	48	200	29.75
	76HA7230RHETSGV21	5814	5991	6107	6290	71.75	30	-	54	202.5	32.75
	76HA7830RHETSGV21*	5955	6135	6253	6440	77.75	30	-	60	214.5	35.75
	76HA8430RHETSGV21	6247	6436	6560	6758	83.75	30	-	66	216.5	38.75
	76HA4836RHETSGV21	5698	5869	5985	6163	47.75	36	-	30	197.5	20.75
	76HA5436RHETSGV21	5781	5954	6070	6250	53.5	36	-	36	200	24.5
	76HA6036RHETSGV21	5857	6033	6149	6334	59.75	36	-	42	202	28.25
	76HA6636RHETSGV21	6003	6184	6303	6493	65.75	36	-	48	213	32
	76HA7236RHETSGV21	5932	6109	6228	6414	71.75	36	-	54	231.5	35.5
	76HA7836RHETSGV21	6438	6630	6760	6962	77.75	36	-	60	240.5	39.25
	76HA8436RHETSGV21	6539	6734	6864	7071	83.75	36	-	66	242.5	43

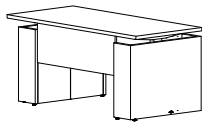

**ORDERING NOTES:**

To order a height adjustable work surface with a top overhang of 16" at one end insert O16 into the model number after ETS. eg. 76HA6024ETSO16GV21. Please note that this option is not available on electronic height adjustable work surfaces that are 42" or less in length. This option is not available on dual stage electronic height adjustable worksurfaces.

To order a dual stage height adjustable base **add \$674 to the list price** and replace ETS with ETD. eg. 76HA6030ETDGV21.

Lifts come standard with an up/down button. Standard colors are Silver Metallic & Black, please contact customer service for other available colors. A 4 position programmable display is available, please see page 79 for price and model number. Single stage mechanism height adjustable range: 26" - 45.5"

Dual stage mechanism height adjustable range: 21" - 47"

Modesty Panel options (replace "V21" with suffix below)

Floating Laminate	V26
Floating Palette	V22
Floating Acrylic	V29
Full Fixed Wood	X41

DIMENSION KEY	CODE DESCRIPTION	STANDARD FINISHES
W - width	ETS - electric T- base single stage	For a complete list of standard wood finishes please see Page 117.
D - depth	V21- half height floating wood modesty panel	
H - height	O16 - top overhang of 16"	
	D - dual stage height adjustable base	
	C - C- base	

# ARTEMIS | DESK RUNOFFS FOR 3/4 HEIGHT CREDENZAS

Description	Model	Rift Oak or	Rift Oak or	C,M,W w/	C,M,W w/	W	D	H	KW	Shipping Cubic	
		Palette w/ Lam Top & Polymer Edge	Wood or Lam Top & Wood Edge	Lam Top & Polymer Edge	Wood or Lam Top & Wood Edge					Weight	Feet
Desk Runoffs no Modesty	76DR60303LGB	2252	2319	2364	2434	59.75	30	29.5	36.4	132	39.25
Panel for 3/4 Ht.	76DR60303RGB	2252	2319	2364	2434	59.75	30	29.5	36.4	132	39.25
Credenzas, Gable	76DR66303LGB	2273	2342	2386	2459	65.75	30	29.5	42	141	42.75
	76DR66303RGB	2273	2342	2386	2459	65.75	30	29.5	42	141	42.75
	76DR72303LGB	2347	2418	2464	2538	71.75	30	29.5	48.1	149	46.5
	76DR72303RGB	2347	2418	2464	2538	71.75	30	29.5	48.1	149	46.5
	76DR72363LGB	2370	2443	2489	2564	71.75	36	29.5	48.1	174	54.75
	76DR72363RGB*	2370	2443	2489	2564	71.75	36	29.5	48.1	174	54.75
	76DR78303LGB	2463	2538	2587	2664	71.75	30	29.5	54	149	46.5
	76DR78303RGB	2463	2538	2587	2664	71.75	30	29.5	54	149	46.5
	76DR78363LGB	2806	2891	2947	3035	71.75	36	29.5	54	174	54.75
	76DR78363RGB	2806	2891	2947	3035	71.75	36	29.5	54	174	54.75
	76DR84303LGB	2580	2658	2710	2790	83.75	30	29.5	60	165	53.75
	76DR84303RGB	2580	2658	2710	2790	83.75	30	29.5	60	165	53.75
	76DR84363LGB	3166	3263	3324	3427	83.75	36	29.5	60	165	53.75
	76DR84363RGB	3166	3263	3324	3427	83.75	36	29.5	60	165	53.75
Desk Runoffs no Modesty	76DR60303LLG	2020	2083	2121	2186	59.75	30	29.5	35	109	16
Panel for 3/4 Ht.	76DR60303RLG	2020	2083	2121	2186	59.75	30	29.5	35	109	16
Credenzas, Legs	76DR66303LLG	2048	2109	2148	2214	65.75	30	29.5	41	118	17.5
	76DR66303RLG	2048	2109	2148	2214	65.75	30	29.5	41	118	17.5
	76DR72303LLG	2113	2176	2219	2285	71.75	30	29.5	47	126	18.5
	76DR72303RLG	2113	2176	2219	2285	71.75	30	29.5	47	126	18.5
	76DR72363LLG	2135	2198	2241	2308	71.75	36	29.5	47	145	21.5
	76DR72363RLG*	2135	2198	2241	2308	71.75	36	29.5	47	145	21.5
	76DR78303LLG	2206	2272	2316	2385	71.75	30	29.5	53	126	18.5
	76DR78303RLG	2206	2272	2316	2385	71.75	30	29.5	53	126	18.5
	76DR78363LLG	2218	2283	2328	2398	71.75	36	29.5	53	145	21.5
	76DR78363RLG	2218	2283	2328	2398	71.75	36	29.5	53	145	21.5
	76DR84303LLG	2788	2872	2927	3014	83.75	30	29.5	59	142	21.5
	76DR84303RLG	2788	2872	2927	3014	83.75	30	29.5	59	142	21.5
	76DR84363LLG	3866	3982	4060	4182	83.75	36	29.5	59	142	21.5
	76DR84363RLG	3866	3982	4060	4182	83.75	36	29.5	59	142	21.5
Desk Runoffs no Modesty	76DR60303LDB	1803	1857	1893	1949	59.75	30	29.5		109	16
Panel for 3/4 Ht.	76DR60303RDB	1803	1857	1893	1949	59.75	30	29.5		109	16
Credenzas, Disc Base	76DR66303LDB	1832	1884	1922	1980	65.75	30	29.5		118	17.5
	76DR66303RDB	1832	1884	1922	1980	65.75	30	29.5		118	17.5
	76DR72303LDB	1896	1954	1990	2053	71.75	30	29.5		126	18.5
	76DR72303RDB	1896	1954	1990	2053	71.75	30	29.5		126	18.5
	76DR72363LDB	1918	1976	2014	2073	71.75	36	29.5		145	21.5
	76DR72363RDB*	1918	1976	2014	2073	71.75	36	29.5		145	21.5
	76DR78303LDB	1988	2048	2087	2148	71.75	30	29.5		126	18.5
	76DR78303RDB	1988	2048	2087	2148	71.75	30	29.5		126	18.5
	76DR78363LDB	2271	2339	2384	2457	71.75	36	29.5		145	21.5
	76DR78363RDB	2271	2339	2384	2457	71.75	36	29.5		145	21.5
	76DR84303LDB	2569	2658	2716	2807	83.75	30	29.5		142	21.5
	76DR84303RDB	2569	2658	2716	2807	83.75	30	29.5		142	21.5
	76DR84363LDB	3084	3179	3239	3336	83.75	36	29.5		142	21.5
	76DR84363RDB	3084	3179	3239	3336	83.75	36	29.5		142	21.5

### ORDERING PROCEDURE

To order, please specify the following:

- 1) Krug product model number
- 2) Wood species and finish, see Page 11
- 3) Wood edge detail- I,H, L or P, see Page 3
- 4) Pull style, see Page 4
- 5) Grommet location if applicable

\*Indicates model illustrated by line drawing.

### CODE DESCRIPTION

- L - left hand position
- R - right hand position
- GB - gable support
- LG - legs support
- DB - disc base support



### STANDARD FINISHES

For a complete list of standard wood finishes please see Page 117.

### GROMMETS

One grommet in standard position is optional at no charge. Additional rectangular grommets are available at an upcharge of **\$152 list.**

# ARTEMIS | DESK RUNOFFS FOR 3/4 HEIGHT CREDENZAS

Description	Model	Rift Oak or	Rift Oak or	C,M,W w/		W	D	H	KW	Shipping Weight	Cubic Feet
		Palette w/ Lam Top & Polymer Edge	Palette w/ Wood Lam Top & Wood Edge	C,M,W w/ Lam Top & Polymer Edge	C,M,W w/ Wood Lam Top & Wood Edge						
 Desk Runoffs no Modesty Panel for 3/4 Ht. Credenzas, 4/4 Pedestal	76DR60303L4F	3249	3348	3412	3516	59.75	30	29.5	22	181	39
	76DR60303R4F	3249	3348	3412	3516	59.75	30	29.5	22	81	39
	76DR66303L4F	3278	3378	3441	3543	65.75	30	29.5	28	190	43
	76DR66303R4F	3278	3378	3441	3543	65.75	30	29.5	28	190	43
	76DR72303L4F	3344	3445	3512	3617	71.75	30	29.5	33.5	199	46.5
	76DR72303R4F	3344	3445	3512	3617	71.75	30	29.5	33.5	199	46.5
	76DR72363L4F	3418	3521	3589	3697	71.75	30	29.5	33.5	217	54.5
	76DR72363R4F	3418	3521	3589	3697	71.75	30	29.5	33.5	217	54.5
	76DR78303L4F	3363	3462	3532	3636	71.75	30	29.5	38.5	199	46.5
	76DR78303R4F	3363	3462	3532	3636	71.75	30	29.5	38.5	199	46.5
	76DR78363L4F	4033	4153	4235	4361	71.75	30	29.5	38.5	217	54.5
	76DR78363R4F	4033	4153	4235	4361	71.75	30	29.5	38.5	217	54.5
	76DR84303L4F	3554	3661	3732	3844	83.75	30	29.5	45.5	215	53.75
	76DR84303R4F	3554	3661	3732	3844	83.75	30	29.5	45.5	215	53.75
	76DR84363L4F	4264	4393	4478	4611	83.75	36	29.5	45.5	215	53.75
	76DR84363R4F	4264	4393	4478	4611	83.75	36	29.5	45.5	215	53.75
 Desk Runoffs no Modesty Panel for 3/4 Ht. Credenzas, Extended 3/4 Pedestal	76DRPM60303L3F	3903	4021	4098	4221	59.75	36	29.5	27.5	248	51
	76DRPM60303R3F	3903	4021	4098	4221	59.75	36	29.5	27.5	248	51
	76DRPM66303L3F	3924	4041	4119	4244	65.75	36	29.5	33.5	259	55.5
	76DRPM66303R3F	3924	4041	4119	4244	65.75	36	29.5	33.5	259	55.5
	76DRPM72303L3F	3999	4118	4198	4323	71.75	36	29.5	39.5	270	60
	76DRPM72303R3F	3999	4118	4198	4323	71.75	36	29.5	39.5	270	60
	76DRPM72363L3F*	4071	4193	4277	4402	71.75	42	29.5	39.5	307	69
	76DRPM72363R3F	4071	4193	4277	4402	71.75	42	29.5	39.5	307	69
	76DRPM78303L3F	4114	4238	4321	4452	71.75	36	29.5	45.5	270	60
	76DRPM78303R3F	4114	4238	4321	4452	71.75	36	29.5	45.5	270	60
	76DRPM78363L3F	4190	4317	4399	4532	71.75	42	29.5	45.5	307	69
	76DRPM78363R3F	4190	4317	4399	4532	71.75	42	29.5	45.5	307	69
	76DRPM84303L3F	4233	4360	4443	4576	83.75	36	29.5	51.5	291	68.5
	76DRPM84303R3F	4233	4360	4443	4576	83.75	36	29.5	51.5	291	68.5
	76DRPM84363L3F	4310	4437	4525	4659	83.75	42	29.5	51.5	328	78.5
	76DRPM84363R3F	4310	4437	4525	4659	83.75	42	29.5	51.5	328	78.5

**DIMENSION KEY**

W - width  
 D - depth  
 H - height

**CODE DESCRIPTION**



L - left hand position  
 R - right hand position  
 4F -full height pedsestal support  
 3F -3/4 height pedsestal support

**STANDARD FINISHES**

For a complete list of standard wood finishes please see Page 117.



# ARTEMIS | DESK RUNOFFS FOR 3/4 HEIGHT CREDENZAS

Description	Model	Rift Oak or	Rift Oak or	C,M,W w/	C,M,W w/	W	D	H	KW	Shipping Cubic	
		Palette w/ Lam Top & Polymer Edge	Wood or Lam Top & Wood Edge	C,M,W w/ Lam Top & Polymer Edge	Wood or Lam Top & Wood Edge					Weight	Feet
Rectangular Desk Runoffs with Wood Modesty Panel for 3/4 Ht. Credenzas, Gable  	76DR60303LGB_V21	2397	2470	2518	2593	59.75	30	29.5	36.4	132	39.25
	76DR60303RGB_V21	2397	2470	2518	2593	59.75	30	29.5	36.4	132	39.25
	76DR66303LGB_V21	2432	2505	2554	2631	65.75	30	29.5	42	141	42.75
	76DR66303RGB_V21	2432	2505	2554	2631	65.75	30	29.5	42	141	42.75
	76DR72303LGB_V21	2523	2597	2649	2727	71.75	30	29.5	48.1	149	46.5
	76DR72303RGB_V21	2523	2597	2649	2727	71.75	30	29.5	48.1	149	46.5
	76DR72363LGB_V21	2545	2621	2672	2753	71.75	36	29.5	48.1	174	54.75
	76DR72363RGB_V21*	2545	2621	2672	2753	71.75	36	29.5	48.1	174	54.75
	76DR78303LGB_V21	2576	2654	2705	2785	71.75	30	29.5	53	149	46.5
	76DR78303RGB_V21	2576	2654	2705	2785	71.75	30	29.5	53	149	46.5
	76DR78363LGB_V21	3090	3182	3244	3342	71.75	36	29.5	53	174	54.75
	76DR78363RGB_V21	3090	3182	3244	3342	71.75	36	29.5	53	174	54.75
	76DR84303LGB_V21	2785	2867	2924	3011	83.75	30	29.5	60	165	53.75
	76DR84303RGB_V21	2785	2867	2924	3011	83.75	30	29.5	60	165	53.75
	76DR84363LGB_V21	3342	3441	3509	3613	83.75	36	29.5	60	165	53.75
76DR84363RGB_V21	3342	3441	3509	3613	83.75	36	29.5	60	165	53.75	
Rectangular Desk Runoffs with Wood Modesty Panel for 3/4 Ht. Credenzas, Legs  	76DR60303LLG_V21	2166	2230	2274	2342	59.75	30	29.5	35	109	16
	76DR60303RLG_V21	2166	2230	2274	2342	59.75	30	29.5	35	109	16
	76DR66303LLG_V21	2209	2273	2318	2386	65.75	30	29.5	41	118	17.5
	76DR66303RLG_V21	2209	2273	2318	2386	65.75	30	29.5	41	118	17.5
	76DR72303LLG_V21	2287	2357	2405	2476	71.75	30	29.5	47	126	18.5
	76DR72303RLG_V21	2287	2357	2405	2476	71.75	30	29.5	47	126	18.5
	76DR72363LLG_V21	2310	2381	2427	2497	71.75	36	29.5	47	145	21.5
	76DR72363RLG_V21*	2310	2381	2427	2497	71.75	36	29.5	47	145	21.5
	76DR78303LLG_V21	2361	2432	2480	2554	71.75	30	29.5	53	126	18.5
	76DR78303RLG_V21	2361	2432	2480	2554	71.75	30	29.5	53	126	18.5
	76DR78363LLG_V21	2833	2919	2973	3066	71.75	36	29.5	53	145	21.5
	76DR78363RLG_V21	2833	2919	2973	3066	71.75	36	29.5	53	145	21.5
	76DR84303LLG_V21	2527	2605	2654	2735	83.75	30	29.5	59	142	21.5
	76DR84303RLG_V21	2527	2605	2654	2735	83.75	30	29.5	59	142	21.5
	76DR84363LLG_V21	3032	3122	3185	3279	83.75	36	29.5	59	142	21.5
76DR84363RLG_V21	3032	3122	3185	3279	83.75	36	29.5	59	142	21.5	
Desk Runoffs with Wood Modesty Panel for 3/4 Ht. Credenzas, Disc Base  	76DR60303LDB_V21	1947	2006	2045	2107	59.75	30	29.5	21.5	109	16
	76DR60303RDB_V21	1947	2006	2045	2107	59.75	30	29.5	21.5	109	16
	76DR66303LDB_V21	1989	2051	2088	2149	65.75	30	29.5	27.5	118	17.5
	76DR66303RDB_V21	1989	2051	2088	2149	65.75	30	29.5	27.5	118	17.5
	76DR72303LDB_V21	2070	2133	2173	2240	71.75	30	29.5	33.5	126	18.5
	76DR72303RDB_V21	2070	2133	2173	2240	71.75	30	29.5	33.5	126	18.5
	76DR72363LDB_V21	2091	2157	2196	2264	71.75	36	29.5	30	145	21.5
	76DR72363RDB_V21*	2091	2157	2196	2264	71.75	36	29.5	30	145	21.5
	76DR78303LDB_V21	2144	2210	2252	2319	71.75	30	29.5	39	126	18.5
	76DR78303RDB_V21	2144	2210	2252	2319	71.75	30	29.5	39	126	18.5
	76DR78363LDB_V21	2614	2695	2745	2829	71.75	36	29.5	36	145	21.5
	76DR78363RDB_V21	2614	2695	2745	2829	71.75	36	29.5	36	145	21.5
	76DR84303LDB_V21	2916	3003	3061	3155	83.75	30	29.5	45	142	21.5
	76DR84303RDB_V21	2916	3003	3061	3155	83.75	30	29.5	45	142	21.5
	76DR84363LDB_V21	3430	3534	3687	3710	83.75	36	29.5	42	142	21.5
76DR84363RDB_V21	3430	3534	3687	3710	83.75	36	29.5	42	142	21.5	

**ORDERING NOTES:**

Add -20 before V21 when runoff is to be used with a 20" deep credenza.

Add -24 before V21 when runoff is to be used with a 24" deep credenza

**ORDERING PROCEDURE**

To order, please specify the following:

- 1) Krug product model number
- 2) Wood species and finish, see Page 11
- 3) Wood edge detail- I,H, L or P, see Page 3
- 4) Pull style, see page 4
- 5) Grommet location if applicable

\*Indicates model illustrated by line drawing.

**CODE DESCRIPTION**

- L - left hand position
- R - right hand position
- GB - gable support
- LG - legs support
- DB - disc base support
- V21 - 1/2 height floating wood modesty panel

**STANDARD FINISHES**

For a complete list of standard wood finishes please see Page 117.

**GROMMETS**

One grommet in standard position is optional at no charge. Additional rectangular grommets are available at an upcharge of **\$152 list.**

# ARTEMIS | DESK RUNOFFS FOR 3/4 HEIGHT CREDENZAS

Description	Model	Rift Oak or	Rift Oak or	C,M,W w/		W	D	H	KW	Shipping Cubic	
		Palette w/ Lam Top & Polymer Edge	Wood or Lam Top & Wood Edge	C,M,W w/ Lam Top & Polymer Edge	Wood or Lam Top & Wood Edge					Weight	Feet
Rectangular Desk	76DR60303L4F__V21	3397	3498	3565	3672	59.75	30	29.5	22	181	39
Runoffs with Wood	76DR60303R4F__V21	3397	3498	3565	3672	59.75	30	29.5	22	181	39
Modesty Panel for	76DR66303L4F__V21	3435	3539	3608	3715	65.75	30	29.5	28	190	43
3/4 Ht.Credenzas,	76DR66303R4F__V21	3435	3539	3608	3715	65.75	30	29.5	28	190	43
4/4 Pedestal	76DR72303L4F__V21	3519	3626	3696	3806	71.75	30	29.5	33.5	199	46.5
Support	76DR72303R4F__V21	3519	3626	3696	3806	71.75	30	29.5	33.5	199	46.5
	76DR72363L4F__V21*	3594	3701	3772	3886	71.75	30	29.5	33.5	217	54.5
	76DR72363R4F__V21	3594	3701	3772	3886	71.75	30	29.5	33.5	217	54.5
	76DR78303L4F__V21	3520	3627	3697	3809	71.75	30	29.5	53	199	46.5
	76DR78303R4F__V21	3520	3627	3697	3809	71.75	30	29.5	53	199	46.5
	76DR78363L4F__V21	4223	4350	4435	4567	71.75	30	29.5	53	217	54.5
	76DR78363R4F__V21	4223	4350	4435	4567	71.75	30	29.5	53	217	54.5
	76DR84303L4F__V21	3757	3870	3946	4064	83.75	30	29.5	45.5	215	53.75
	76DR84303R4F__V21	3757	3870	3946	4064	83.75	30	29.5	45.5	215	53.75
	76DR84363L4F__V21	4509	4644	4735	4877	83.75	36	29.5	45.5	215	53.75
	76DR84363R4F__V21	4509	4644	4735	4877	83.75	36	29.5	45.5	215	53.75



Rectangular Desk	76DRPM60303L3F__V21	4048	4171	4251	4379	59.75	36	29.5	27.5	248	51
Runoffs with Wood	76DRPM60303R3F__V21	4048	4171	4251	4379	59.75	36	29.5	27.5	248	51
Modesty Panel for	76DRPM66303L3F__V21	4084	4206	4288	4417	65.75	36	29.5	33.5	259	55.5
3/4 Ht. Credenzas,	76DRPM66303R3F__V21	4084	4206	4288	4417	65.75	36	29.5	33.5	259	55.5
Extended 3/4	76DRPM72303L3F__V21	4173	4296	4382	4512	71.75	36	29.5	39.5	270	60
Pedestal Support	76DRPM72303R3F__V21	4173	4296	4382	4512	71.75	36	29.5	39.5	270	60
	76DRPM72363L3F__V21	4248	4377	4460	4593	71.75	42	29.5	39.5	307	69
	76DRPM72363R3F__V21*	4248	4377	4460	4593	71.75	42	29.5	39.5	307	69
	76DRPM78303L3F__V21	4112	4236	4317	4447	71.75	36	29.5	53	270	60
	76DRPM78303R3F__V21	4112	4236	4317	4447	71.75	36	29.5	53	270	60
	76DRPM78363L3F__V21	4932	5082	5181	5336	71.75	42	29.5	53	307	69
	76DRPM78363R3F__V21	4932	5082	5181	5336	71.75	42	29.5	53	307	69
	76DRPM84303L3F__V21	4436	4570	4658	4796	83.75	36	29.5	51.5	291	68.5
	76DRPM84303R3F__V21	4436	4570	4658	4796	83.75	36	29.5	51.5	291	68.5
	76DRPM84363L3F__V21	4510	4645	4736	4878	83.75	42	29.5	51.5	328	78.5
	76DRPM84363R3F__V21	4510	4645	4736	4878	83.75	42	29.5	51.5	328	78.5



**ORDERING NOTES:**

Add -20 before V21 when runoff is to be used with a 20" deep credenza  
 Add -24 before V21 when runoff is to be used with a 24" deep credenza

**DIMENSION KEY**

W - width  
 D - depth  
 H - height

**CODE DESCRIPTION**

L - left hand position  
 R - right hand position  
 4F - full height pedestal, 2 box, 1 file drawer  
 3F - 3/4 height pedestal, 1 box, 1 file drawer  
 V21 - 1/2 height floating wood modesty panel

**STANDARD FINISHES**

For a complete list of standard wood finishes please see Page 117.

# ARTEMIS | DESK RUNOFFS FOR 3/4 HEIGHT CREDENZAS

Description	Model	Rift Oak or	Rift Oak or	C,M,W w/	C,M,W w/	W	D	H	KW	Shipping Weight	Cubic Feet
		Palette w/ Lam Top & Polymer Edge	Palette w/ Wood Lam Top & Wood Edge	C,M,W w/ Lam Top & Polymer Edge	C,M,W w/ Wood Lam Top & Wood Edge						
Rectangular Desk	76DR60303LGB_V29	2819	2904	2959	3049	59.75	30	29.5	36.4	132	39.25
Runoffs with Acrylic	76DR60303RGB_V29	2819	2904	2959	3049	59.75	30	29.5	36.4	132	39.25
Modesty Panel for 3/4 Ht. Credenzas, Gable	76DR66303LGB_V29	2894	2984	3039	3133	65.75	30	29.5	42	141	42.75
	76DR66303RGB_V29	2894	2984	3039	3133	65.75	30	29.5	42	141	42.75
	76DR72303LGB_V29	3027	3115	3179	3271	71.75	30	29.5	48.1	149	46.5
	76DR72303RGB_V29	3027	3115	3179	3271	71.75	30	29.5	48.1	149	46.5
	76DR72363LGB_V29	3052	3141	3203	3297	71.75	36	29.5	48.1	174	54.75
	76DR72363RGB_V29*	3052	3141	3203	3297	71.75	36	29.5	48.1	174	54.75
	76DR78303LGB_V29	2817	2902	2957	3045	71.75	30	29.5	53	149	46.5
	76DR78303RGB_V29	2817	2902	2957	3045	71.75	30	29.5	53	149	46.5
	76DR78363LGB_V29	3381	3483	3547	3655	71.75	36	29.5	53	174	54.75
	76DR78363RGB_V29	3381	3483	3547	3655	71.75	36	29.5	53	174	54.75
	76DR84303LGB_V29	3163	3259	3321	3423	83.75	30	29.5	60	165	53.75
	76DR84303RGB_V29	3163	3259	3321	3423	83.75	30	29.5	60	165	53.75
	76DR84363LGB_V29	3638	3745	3819	3934	83.75	36	29.5	60	165	53.75
	76DR84363RGB_V29	3638	3745	3819	3934	83.75	36	29.5	60	165	53.75



Rectangular Desk	76DR60303LLG_V29	2586	2663	2715	2795	59.75	30	29.5	35	109	16
Runoffs with Acrylic	76DR60303RLG_V29	2586	2663	2715	2795	59.75	30	29.5	35	109	16
Modesty Panel for 3/4 Ht. Credenzas, Legs	76DR66303LLG_V29	2668	2746	2802	2884	65.75	30	29.5	41	118	17.5
	76DR66303RLG_V29	2668	2746	2802	2884	65.75	30	29.5	41	118	17.5
	76DR72303LLG_V29	2791	2877	2932	3021	71.75	30	29.5	47	126	18.5
	76DR72303RLG_V29	2791	2877	2932	3021	71.75	30	29.5	47	126	18.5
	76DR72363LLG_V29	2815	2898	2955	3042	71.75	36	29.5	47	145	21.5
	76DR72363RLG_V29*	2815	2898	2955	3042	71.75	36	29.5	47	145	21.5
	76DR78303LLG_V29	2817	2902	2957	3045	71.75	30	29.5	53	126	18.5
	76DR78303RLG_V29	2817	2902	2957	3045	71.75	30	29.5	53	126	18.5
	76DR78363LLG_V29	3381	3483	3547	3655	71.75	36	29.5	53	145	21.5
	76DR78363RLG_V29	3381	3483	3547	3655	71.75	36	29.5	53	145	21.5
	76DR84303LLG_V29	3115	3209	3271	3369	83.75	30	29.5	59	142	21.5
	76DR84303RLG_V29	3115	3209	3271	3369	83.75	30	29.5	59	142	21.5
	76DR84363LLG_V29	3739	3849	3924	4041	83.75	36	29.5	59	142	21.5
	76DR84363RLG_V29	3739	3849	3924	4041	83.75	36	29.5	59	142	21.5



**ORDERING NOTES:**

Add -20 before V21 when runoff is to be used with a 20" deep credenza  
 Add -24 before V21 when runoff is to be used with a 24" deep credenza

**ORDERING PROCEDURE**

To order, please specify the following:

- 1) Krug product model number
- 2) Wood species and finish, see Page 11
- 3) Wood edge detail- I,H, L or P, see Page 3
- 4) Pull style, see Page 4
- 5) Grommet location if applicable

**CODE DESCRIPTION**

L - left hand position  
 R - right hand position  
 GB - gable support  
 LG - legs support  
 V29 - 1/2 height floating acrylic modesty panel

**STANDARD FINISHES**

For a complete list of standard wood finishes please see Page 117.

**GROMMETS**

One grommet in standard position is optional at no charge. Additional rectangular grommets are available at an upcharge of **\$152 list.**

# ARTEMIS | DESK RUNOFFS FOR 3/4 HEIGHT CREDENZAS

Description	Model	Rift Oak or	Rift Oak or	C,M,W w/	C,M,W w/	W	D	H	KW	Shipping Cubic	
		Palette w/ Lam Top & Polymer Edge	Palette w/ Wood Lam Top & Wood Edge	Lam Top & Polymer Edge	Lam Top & Wood Edge					Weight	Feet
Desk Runoffs with Acrylic Modesty Panel for 3/4 Ht. Credenzas, Disc Base	76DR60303LDB_V29	2368	2440	2487	2562	59.75	30	29.5	21.5	109	16
	76DR60303RDB_V29	2368	2440	2487	2562	59.75	30	29.5	21.5	109	16
	76DR66303LDB_V29	2449	2523	2570	2649	65.75	30	29.5	27.5	118	17.5
	76DR66303RDB_V29	2449	2523	2570	2649	65.75	30	29.5	27.5	118	17.5
	76DR72303LDB_V29	2574	2652	2703	2783	71.75	30	29.5	33.5	126	18.5
	76DR72303RDB_V29	2574	2652	2703	2783	71.75	30	29.5	33.5	126	18.5
	76DR72363LDB_V29	2595	2672	2726	2807	71.75	36	29.5	30	145	21.5
	76DR72363RDB_V29*	2595	2672	2726	2807	71.75	36	29.5	30	145	21.5
	76DR78303LDB_V29	2597	2676	2728	2810	71.75	30	29.5	39	126	18.5
	76DR78303RDB_V29	2597	2676	2728	2810	71.75	30	29.5	39	126	18.5
	76DR78363LDB_V29	3162	3257	3320	3420	71.75	36	29.5	36	145	21.5
	76DR78363RDB_V29	3162	3257	3320	3420	71.75	36	29.5	36	145	21.5
	76DR84303LDB_V29	2898	2986	3042	3135	83.75	30	29.5	45	142	21.5
	76DR84303RDB_V29	2898	2986	3042	3135	83.75	30	29.5	45	142	21.5
	76DR84363LDB_V29	3520	3627	3697	3809	83.75	36	29.5	42	142	21.5
	76DR84363RDB_V29	3520	3627	3697	3809	83.75	36	29.5	42	142	21.5

Rectangular Desk Runoffs with Acrylic Modesty Panel for 3/4 Ht. Credenzas, 4/4 Pedestal	76DR60303L4F_V29	3818	3933	4008	4130	59.75	30	29.5	22	181	39
	76DR60303R4F_V29	3818	3933	4008	4130	59.75	30	29.5	22	181	39
	76DR66303L4F_V29	3899	4019	4095	4217	65.75	30	29.5	28	190	43
	76DR66303R4F_V29	3899	4019	4095	4217	65.75	30	29.5	28	190	43
	76DR72303L4F_V29	4022	4142	4222	4350	71.75	30	29.5	33.5	199	46.5
	76DR72303R4F_V29	4022	4142	4222	4350	71.75	30	29.5	33.5	199	46.5
	76DR72363L4F_V29	4097	4219	4299	4429	71.75	30	29.5	33.5	217	54.5
	76DR72363R4F_V29*	4097	4219	4299	4429	71.75	30	29.5	33.5	217	54.5
	76DR78303L4F_V29	3977	4095	4176	4297	71.75	30	29.5	53	199	46.5
	76DR78303R4F_V29	3977	4095	4176	4297	71.75	30	29.5	53	199	46.5
	76DR78363L4F_V29	4772	4917	5009	5160	71.75	30	29.5	53	217	54.5
	76DR78363R4F_V29	4772	4917	5009	5160	71.75	30	29.5	53	217	54.5
	76DR84303L4F_V29	4347	4477	4564	4702	83.75	30	29.5	45.5	215	53.75
	76DR84303R4F_V29	4347	4477	4564	4702	83.75	30	29.5	45.5	215	53.75
	76DR84363L4F_V29	5216	5370	5477	5640	83.75	36	29.5	45.5	215	53.75
	76DR84363R4F_V29	5216	5370	5477	5640	83.75	36	29.5	45.5	215	53.75



**ORDERING NOTES:**

Add -20 before V29 when runoff is to be used with a 20" deep credenza  
 Add -24 before V29 when runoff is to be used with a 24" deep credenza

**DIMENSION KEY**

W - width  
 D - depth  
 H - height  
 KW - kneehole width  
 Dimensions are in inches and approximate.  
 Contact Customer Service if dimensions are critical.

\* Indicates model illustrated by the line drawing.

**CODE DESCRIPTION**

L - left hand position  
 R - right hand position  
 DB - disc base support  
 4F - 2 box, 1 file drawer  
 V29 - 1/2 height floating acrylic modesty pane

**STANDARD FINISHES**

For a complete list of standard wood finishes please see Page 117.

# ARTEMIS | DESK RUNOFFS FOR 3/4 HEIGHT CREDENZAS

Description	Model	Rift Oak or	Rift Oak or	C,M,W w/		W	D	H	KW	Shipping Weight	Cubic Feet
		Palette w/ Lam Top & Polymer Edge	Palette w/ Wood Lam Top & Wood Edge	C,M,W w/ Lam Top & Polymer Edge	C,M,W w/ Wood Lam Top & Wood Edge						
Rectangular Desk Runoffs with Acrylic Modesty Panel for 3/4 Ht. Credenzas, Extended 3/4 Pedestal	76DRPM60303L3F_V29	4470	4606	4693	4835	59.75	36	29.5	27.5	248	51
	76DRPM60303R3F_V29	4470	4606	4693	4835	59.75	36	29.5	27.5	248	51
	76DRPM66303L3F_V29	4547	4684	4777	4920	65.75	36	29.5	33.5	259	55.5
	76DRPM66303R3F_V29	4547	4684	4777	4920	65.75	36	29.5	33.5	259	55.5
	76DRPM72303L3F_V29	4678	4817	4911	5059	71.75	36	29.5	39.5	270	60
	76DRPM72303R3F_V29	4678	4817	4911	5059	71.75	36	29.5	39.5	270	60
	76DRPM72363L3F_V29*	4752	4893	4990	5139	71.75	42	29.5	39.5	307	69
	76DRPM72363R3F_V29	4752	4893	4990	5139	71.75	42	29.5	39.5	307	69
	76DRPM78303L3F_V29	4566	4706	4794	4941	71.75	36	29.5	53	270	60
	76DRPM78303R3F_V29	4566	4706	4794	4941	71.75	36	29.5	53	270	60
	76DRPM78363L3F_V29	4902	5050	5147	5302	71.75	42	29.5	53	307	69
	76DRPM78363R3F_V29	4902	5050	5147	5302	71.75	42	29.5	53	307	69
	76DRPM84303L3F_V29	5024	5174	5275	5434	83.75	36	29.5	51.5	291	68.5
	76DRPM84303R3F_V29	5024	5174	5275	5434	83.75	36	29.5	51.5	291	68.5
	76DRPM84363L3F_V29	5103	5256	5359	5517	83.75	42	29.5	51.5	328	78.5
	76DRPM84363R3F_V29	5103	5256	5359	5517	83.75	42	29.5	51.5	328	78.5



Rectangular Desk Runoffs with Glass Modesty Panel for 3/4 Ht. Credenzas, Gable	76DR60303LGB_V24	3193	3290	3353	3455	59.75	30	29.5	36.4	132	39.25
	76DR60303RGB_V24	3193	3290	3353	3455	59.75	30	29.5	36.4	132	39.25
	76DR66303LGB_V24	3252	3352	3415	3519	65.75	30	29.5	36.4	141	42.75
	76DR66303RGB_V24	3252	3352	3415	3519	65.75	30	29.5	36.4	141	42.75
	76DR72303LGB_V24	3368	3469	3536	3642	71.75	30	29.5	48.1	149	46.5
	76DR72303RGB_V24	3368	3469	3536	3642	71.75	30	29.5	48.1	149	46.5
	76DR72363LGB_V24	3390	3493	3561	3668	71.75	36	29.5	48.1	174	54.75
	76DR72363RGB_V24*	3390	3493	3561	3668	71.75	36	29.5	48.1	174	54.75
	76DR78303LGB_V24	3523	3631	3701	3812	71.75	30	29.5	53	149	46.5
	76DR78303RGB_V24	3523	3631	3701	3812	71.75	30	29.5	53	149	46.5
	76DR78363LGB_V24	3866	3982	4060	4182	71.75	36	29.5	53	174	54.75
	76DR78363RGB_V24	3866	3982	4060	4182	71.75	36	29.5	53	174	54.75
	76DR84303LGB_V24	3693	3804	3878	3995	83.75	30	29.5	60	165	53.75
	76DR84303RGB_V24	3693	3804	3878	3995	83.75	30	29.5	60	165	53.75
	76DR84363LGB_V24	4284	4414	4498	4632	83.75	36	29.5	60	165	53.75
	76DR84363RGB_V24	4284	4414	4498	4632	83.75	36	29.5	60	165	53.75



**ORDERING NOTES:**

Add -20 before V29 when runoff is to be used with a 20" deep credenza  
 Add -24 before V29 when runoff is to be used with a 24" deep credenza

**ORDERING PROCEDURE**

To order, please specify the following:

- 1) Krug product model number
- 2) Wood species and finish, see Page 11
- 3) Wood edge detail- L, H, L or P, see Page 3
- 4) Pull style, see Page 4
- 5) Grommet location if applicable

\*Indicates model illustrated by line drawing.

**CODE DESCRIPTION**

L - left hand position  
 R - right hand position  
 3F - 1 box, 1 file drawer  
 GB - gable support  
 V29 - 1/2 height floating acrylic modesty panel  
 V24 - 1/2 height glass modesty panel

**STANDARD FINISHES**

For a complete list of standard wood finishes please see Page 117.

**GROMMETS**

One grommet in standard position is optional at no charge. Additional rectangular grommets are available at an upcharge of **\$152 list.**

# ARTEMIS | DESK RUNOFFS FOR 3/4 HEIGHT CREDENZAS

Description	Model	Rift Oak or	Rift Oak or	C,M,W w/	C,M,W w/	W	D	H	KW	Shipping Cubic	
		Palette w/ Lam Top & Polymer Edge	Palette w/ Wood Lam Top & Wood Edge	C,M,W w/ Lam Top & Polymer Edge	C,M,W w/ Wood Lam Top & Wood Edge					Weight	Feet
Rectangular Desk	76DR60303LLG_V24	2963	3053	3111	3205	59.75	30	29.5	35	109	16
Runoffs with Glass	76DR60303RLG_V24	2963	3053	3111	3205	59.75	30	29.5	35	109	16
Modesty Panel for 3/4 Ht.	76DR66303LLG_V24	3029	3118	3181	3274	65.75	30	29.5	41	118	17.5
Credenzas, Legs	76DR66303RLG_V24	3029	3118	3181	3274	65.75	30	29.5	41	118	17.5
	76DR72303LLG_V24	3135	3231	3291	3389	71.75	30	29.5	47	126	18.5
	76DR72303RLG_V24	3135	3231	3291	3389	71.75	30	29.5	47	126	18.5
	76DR72363LLG_V24	3158	3249	3314	3412	71.75	36	29.5	47	145	21.5
	76DR72363RLG_V24*	3158	3249	3314	3412	71.75	36	29.5	47	145	21.5
	76DR78303LLG_V24	3266	3363	3429	3533	71.75	30	29.5	53	126	18.5
	76DR78303RLG_V24	3266	3363	3429	3533	71.75	30	29.5	53	126	18.5
	76DR78363LLG_V24	3279	3379	3444	3545	71.75	36	29.5	53	145	21.5
	76DR78363RLG_V24	3279	3379	3444	3545	71.75	36	29.5	53	145	21.5
	76DR84303LLG_V24	3435	3539	3608	3715	83.75	30	29.5	59	142	21.5
	76DR84303RLG_V24	3435	3539	3608	3715	83.75	30	29.5	59	142	21.5
	76DR84363LLG_V24	3899	4019	4095	4217	83.75	36	29.5	59	142	21.5
	76DR84363RLG_V24	3899	4019	4095	4217	83.75	36	29.5	59	142	21.5

Desk Runoffs with Glass Modesty Panel for 3/4 Ht.	76DR60303LDB_V24	2744	2827	2882	2968	59.75	30	29.5	21.5	109	16
Credenzas, Disc Base	76DR60303RDB_V24	2744	2827	2882	2968	59.75	30	29.5	21.5	109	16
	76DR66303LDB_V24	2810	2894	2952	3039	65.75	30	29.5	27.5	118	17.5
	76DR66303RDB_V24	2810	2894	2952	3039	65.75	30	29.5	27.5	118	17.5
	76DR72303LDB_V24	2917	3004	3062	3156	71.75	30	29.5	33.5	126	18.5
	76DR72303RDB_V24	2917	3004	3062	3156	71.75	30	29.5	33.5	126	18.5
	76DR72363LDB_V24	2937	3027	3084	3179	71.75	36	29.5	30	145	21.5
	76DR72363RDB_V24*	2937	3027	3084	3179	71.75	36	29.5	30	145	21.5
	76DR78303LDB_V24	3047	3138	3200	3294	71.75	30	29.5	39	126	18.5
	76DR78303RDB_V24	3047	3138	3200	3294	71.75	30	29.5	39	126	18.5
	76DR78363LDB_V24	3061	3155	3215	3312	71.75	36	29.5	36	145	21.5
	76DR78363RDB_V24	3061	3155	3215	3312	71.75	36	29.5	36	145	21.5
	76DR84303LDB_V24	3219	3315	3381	3483	83.75	30	29.5	45	142	21.5
	76DR84303RDB_V24	3219	3315	3381	3483	83.75	30	29.5	45	142	21.5
76DR84363LDB_V24	3683	3792	3866	3982	83.75	36	29.5	42	142	21.5	
76DR84363RDB_V24	3683	3792	3866	3982	83.75	36	29.5	42	142	21.5	

**ORDERING NOTES:**

Add -20 before V24 when runoff is to be used with a 20" deep credenza  
 Add -24 before V24 when runoff is to be used with a 24" deep credenza

**DIMENSION KEY**

W - width  
 D - depth  
 H - height

**CODE DESCRIPTION**

L - left hand position  
 R - right hand position  
 LG - legs support  
 DB - disc base support  
 V24 - 1/2 height glass modesty panel

**STANDARD FINISHES**

For a complete list of standard wood finishes please see Page 117.

# ARTEMIS | DESK RUNOFFS FOR 3/4 HEIGHT CREDENZAS

Description	Model	Rift Oak or	Rift Oak or	C,M,W w/	C,M,W w/	W	D	H	KW	Shipping Weight	Cubic Feet
		Palette w/ Lam Top & Polymer Edge	Palette w/ Wood or Lam Top & Wood Edge	C,M,W w/ Lam Top & Polymer Edge	C,M,W w/ Wood or Lam Top & Wood Edge						
Rectangular Desk	76DR60303L4F_V24	4192	4318	4401	4533	59.75	30	29.5	22	181	39
Runoffs with Glass	76DR60303R4F_V24	4192	4318	4401	4533	59.75	30	29.5	22	181	39
Modesty Panel for	76DR66303L4F_V24	4259	4387	4471	4606	65.75	30	29.5	28	190	43
3/4 Ht. Credenzas,	76DR66303R4F_V24	4259	4387	4471	4606	65.75	30	29.5	28	190	43
4/4 Pedestal	76DR72303L4F_V24	4365	4496	4583	4720	71.75	30	29.5	33.5	199	46.5
	76DR72303R4F_V24	4365	4496	4583	4720	71.75	30	29.5	33.5	199	46.5
	76DR72363L4F_V24	4439	4572	4663	4799	71.75	30	29.5	33.5	217	54.5
	76DR72363R4F_V24*	4439	4572	4663	4799	71.75	30	29.5	33.5	217	54.5
	76DR78303L4F_V24	4423	4558	4644	4784	71.75	30	29.5	53	199	46.5
	76DR78303R4F_V24	4423	4558	4644	4784	71.75	30	29.5	53	199	46.5
	76DR78363L4F_V24	5093	5245	5347	5507	71.75	30	29.5	53	217	54.5
	76DR78363R4F_V24	5093	5245	5347	5507	71.75	30	29.5	53	217	54.5
	76DR84303L4F_V24	4667	4810	4900	5047	83.75	30	29.5	45.5	215	53.75
	76DR84303R4F_V24	4667	4810	4900	5047	83.75	30	29.5	45.5	215	53.75
	76DR84363L4F_V24	5374	5538	5646	5814	83.75	36	29.5	45.5	215	53.75
	76DR84363R4F_V24	5374	5538	5646	5814	83.75	36	29.5	45.5	215	53.75



Rectangular Desk	76DRPM60303L3F_V24	4844	4990	5086	5240	59.75	36	29.5	27.5	248	51
Runoffs with Glass	76DRPM60303R3F_V24	4844	4990	5086	5240	59.75	36	29.5	27.5	248	51
Modesty Panel for	76DRPM66303L3F_V24	4904	5053	5150	5305	65.75	36	29.5	33.5	259	55.5
3/4 Ht. Credenzas,	76DRPM66303R3F_V24	4904	5053	5150	5305	65.75	36	29.5	33.5	259	55.5
Extended	76DRPM72303L3F_V24	5021	5170	5272	5428	71.75	36	29.5	39.5	270	60
3/4 Pedestal	76DRPM72303R3F_V24	5021	5170	5272	5428	71.75	36	29.5	39.5	270	60
	76DRPM72363L3F_V24*	5093	5245	5347	5507	71.75	42	29.5	39.5	307	69
	76DRPM72363R3F_V24	5093	5245	5347	5507	71.75	42	29.5	39.5	307	69
	76DRPM78303L3F_V24	5176	5328	5436	5587	71.75	36	29.5	53	270	60
	76DRPM78303R3F_V24	5176	5328	5436	5587	71.75	36	29.5	53	270	60
	76DRPM78363L3F_V24	5254	5407	5510	5681	71.75	42	29.5	53	307	69
	76DRPM78363R3F_V24	5254	5407	5510	5681	71.75	42	29.5	53	307	69
	76DRPM84303L3F_V24	5345	5506	5612	5782	83.75	36	29.5	51.5	291	68.5
	76DRPM84303R3F_V24	5345	5506	5612	5782	83.75	36	29.5	51.5	291	68.5
	76DRPM84363L3F_V24	5422	5584	5693	5865	83.75	42	29.5	51.5	328	78.5
	76DRPM84363R3F_V24	5422	5584	5693	5865	83.75	42	29.5	51.5	328	78.5



**ORDERING NOTES:**

Add -20 before V24 when runoff is to be used with a 20" deep credenza  
 Add -24 before V24 when runoff is to be used with a 24" deep credenza

**ORDERING PROCEDURE**

To order, please specify the following:

- 1) Krug product model number
- 2) Wood species and finish, see Page 11
- 3) Wood edge detail- I,H, L or P, see Page 3
- 4) Pull style, see Page 4
- 5) Grommet location if applicable

\*Indicates model illustrated by line drawing.

**CODE DESCRIPTION**

L - left hand position  
 R - right hand position  
 4F - 2 box, 1 file drawer  
 3F - 1 box, 1 file drawer  
 V24 - 1/2 height glass modesty panel

**STANDARD FINISHES**

For a complete list of standard wood finishes please see Page 117.

**GROMMETS**

One grommet in standard position is optional at no charge. Additional rectangular grommets are available at an upcharge of **\$152 list.**

# ARTEMIS | CURVILINEAR DESK RUNOFFS FOR 3/4 HEIGHT CREDENZAS

Description	Model	Rift Oak or	Rift Oak or	C,M,W w/		W	D	H	KW	Shipping Cubic	
		Palette w/ Lam Top & Polymer Edge	Wood or Lam Top & Wood Edge	C,M,W w/ Lam Top & Polymer Edge	Wood or Lam Top & Wood Edge					Weight	Feet
 Arc End Desk Runoffs no Modesty Panel for 3/4 Ht. Credenzas, Disc Base	76DRA60303LDB	1803	1857	1893	1949	59.75	30	29.5	21.5	109	16
	76DRA60303RDB	1803	1857	1893	1949	59.75	30	29.5	21.5	109	16
	76DRA66303LDB	1832	1884	1922	1980	65.75	30	29.5	27.5	118	17.5
	76DRA66303RDB	1832	1884	1922	1980	65.75	30	29.5	27.5	118	17.5
	76DRA72303LDB	1896	1954	1990	2053	71.75	30	29.5	33.5	126	18.5
	76DRA72303RDB	1896	1954	1990	2053	71.75	30	29.5	33.5	126	18.5
	76DRA72363LDB*	1918	1976	2014	2073	71.75	36	29.5	30	145	21.5
	76DRA72363RDB	1918	1976	2014	2073	71.75	36	29.5	30	145	21.5
	76DRA78303LDB	1988	2048	2087	2148	71.75	30	29.5	39	126	18.5
	76DRA78303RDB	1988	2048	2087	2148	71.75	30	29.5	39	126	18.5
	76DRA78363LDB	2271	2339	2384	2457	71.75	36	29.5	36	145	21.5
	76DRA78363RDB	2271	2339	2384	2457	71.75	36	29.5	36	145	21.5
	76DRA84303LDB	2569	2646	2698	2779	83.75	30	29.5	45	142	21.5
	76DRA84303RDB	2569	2646	2698	2779	83.75	30	29.5	45	142	21.5
	76DRA84363LDB	3084	3179	3239	3336	83.75	36	29.5	42	142	21.5
76DRA84363RDB	3084	3179	3239	3336	83.75	36	29.5	42	142	21.5	

 Arc End Desk Runoffs with Wood Modesty Panel for 3/4 Ht. Credenzas, Disc Base	76DRA60303LDB_V21	1947	2006	2045	2107	59.75	30	29.5	21.5	109	16
	76DRA60303RDB_V21	1947	2006	2045	2107	59.75	30	29.5	21.5	109	16
	76DRA66303LDB_V21	1989	2051	2088	2149	65.75	30	29.5	27.5	118	17.5
	76DRA66303RDB_V21	1989	2051	2088	2149	65.75	30	29.5	27.5	118	17.5
	76DRA72303LDB_V21	2070	2133	2173	2240	71.75	30	29.5	33.5	126	18.5
	76DRA72303RDB_V21	2070	2133	2173	2240	71.75	30	29.5	33.5	126	18.5
	76DRA72363LDB_V21*	2091	2157	2196	2264	71.75	36	29.5	30	145	21.5
	76DRA72363RDB_V21	2091	2157	2196	2264	71.75	36	29.5	30	145	21.5
	76DRA78303LDB_V21	2144	2210	2252	2319	71.75	30	29.5	39	126	18.5
	76DRA78303RDB_V21	2144	2210	2252	2319	71.75	30	29.5	39	126	18.5
	76DRA78363LDB_V21	2614	2695	2745	2829	71.75	36	29.5	36	145	21.5
	76DRA78363RDB_V21	2614	2695	2745	2829	71.75	36	29.5	36	145	21.5
	76DRA84303LDB_V21	2916	3003	3061	3155	83.75	30	29.5	45	142	21.5
	76DRA84303RDB_V21	2916	3003	3061	3155	83.75	30	29.5	45	142	21.5
	76DRA84363LDB_V21	3430	3534	3687	3710	83.75	36	29.5	42	142	21.5
76DRA84363RDB_V21	3430	3534	3687	3710	83.75	36	29.5	42	142	21.5	

**ORDERING NOTES:**

Add -20 before V21 when runoff is to be used with a 20" deep credenza  
Add -24 before V21 when runoff is to be used with a 24" deep credenza

**DIMENSION KEY**

W - width  
D - depth  
H - height

**CODE DESCRIPTION**

L - left hand position  
R - right hand position  
DB - disc base support  
V21 - 1/2 height floating wood modesty panel

**STANDARD FINISHES**

For a complete list of standard wood finishes please see Page 117.



# ARTEMIS | CURVILINEAR DESK RUNOFFS FOR 3/4 HEIGHT CREDENZAS

Description	Model	Rift Oak or	Rift Oak or	C,M,W w/	C,M,W w/	W	D	H	KW	Shipping Weight	Cubic Feet
		Palette w/ Lam Top & Polymer Edge	Palette w/ Wood Lam Top & Wood Edge	C,M,W w/ Lam Top & Polymer Edge	C,M,W w/ Wood Lam Top & Wood Edge						
Arc End Desk Runoffs with Acrylic Modesty Panel for 3/4 Ht. Credenzas, Disc Base	76DRA60303LDB_V29	2368	2440	2487	2562	59.75	30	29.5	21.5	109	16
	76DRA60303RDB_V29	2368	2440	2487	2562	59.75	30	29.5	21.5	109	16
	76DRA66303LDB_V29	2449	2523	2570	2649	65.75	30	29.5	27.5	118	17.5
	76DRA66303RDB_V29	2449	2523	2570	2649	65.75	30	29.5	27.5	118	17.5
	76DRA72303LDB_V29	2574	2652	2703	2783	71.75	30	29.5	33.5	126	18.5
	76DRA72303RDB_V29	2574	2652	2703	2783	71.75	30	29.5	33.5	126	18.5
	76DRA72363LDB_V29*	2595	2672	2726	2807	71.75	36	29.5	30	145	21.5
	76DRA72363RDB_V29	2595	2672	2726	2807	71.75	36	29.5	30	145	21.5
	76DRA78303LDB_V29	2597	2676	2728	2810	71.75	30	29.5	39	126	18.5
	76DRA78303RDB_V29	2597	2676	2728	2810	71.75	30	29.5	39	126	18.5
	76DRA78363LDB_V29	3162	3257	3320	3420	71.75	36	29.5	36	145	21.5
	76DRA78363RDB_V29	3162	3257	3320	3420	71.75	36	29.5	36	145	21.5
	76DRA84303LDB_V29	2898	2986	3042	3135	83.75	30	29.5	45	142	21.5
	76DRA84303RDB_V29	2898	2986	3042	3135	83.75	30	29.5	45	142	21.5
	76DRA84363LDB_V29	3520	3627	3697	3809	83.75	36	29.5	42	142	21.5
	76DRA84363RDB_V29	3520	3627	3697	3809	83.75	36	29.5	42	142	21.5



Arc End Desk Runoffs with Glass Modesty Panel for 3/4 Ht. Credenzas, Disc Base	76DRA60303LDB_V24	2744	2827	2882	2968	59.75	30	29.5	21.5	109	16
	76DRA60303RDB_V24	2744	2827	2882	2968	59.75	30	29.5	21.5	109	16
	76DRA66303LDB_V24	2810	2894	2952	3039	65.75	30	29.5	27.5	118	17.5
	76DRA66303RDB_V24	2810	2894	2952	3039	65.75	30	29.5	27.5	118	17.5
	76DRA72303LDB_V24	2917	3004	3062	3156	71.75	30	29.5	33.5	126	18.5
	76DRA72303RDB_V24	2917	3004	3062	3156	71.75	30	29.5	33.5	126	18.5
	76DRA72363LDB_V24*	2937	3027	3084	3179	71.75	36	29.5	30	145	21.5
	76DRA72363RDB_V24	2937	3027	3084	3179	71.75	36	29.5	30	145	21.5
	76DRA78303LDB_V24	3047	3138	3200	3294	71.75	30	29.5	39	126	18.5
	76DRA78303RDB_V24	3047	3138	3200	3294	71.75	30	29.5	39	126	18.5
	76DRA78363LDB_V24	3061	3155	3215	3312	71.75	36	29.5	36	145	21.5
	76DRA78363RDB_V24	3061	3155	3215	3312	71.75	36	29.5	36	145	21.5
	76DRA84303LDB_V24	3219	3315	3381	3483	83.75	30	29.5	45	142	21.5
	76DRA84303RDB_V24	3219	3315	3381	3483	83.75	30	29.5	45	142	21.5
	76DRA84363LDB_V24	3683	3792	3866	3982	83.75	36	29.5	42	142	21.5
	76DRA84363RDB_V24	3683	3792	3866	3982	83.75	36	29.5	42	142	21.5



**ORDERING NOTES:**

Add -20 before V when runoff is to be used with a 20" deep credenza  
 Add -24 before V when runoff is to be used with a 24" deep credenza

**ORDERING PROCEDURE**

To order, please specify the following:

- 1) Krug product model number
- 2) Wood species and finish, see Page 11
- 3) Wood edge detail- I,H, L or P, see Page 3
- 4) Pull style, see Page 4
- 5) Grommet location if applicable

\*Indicates model illustrated by line drawing.

**CODE DESCRIPTION**

L - left hand position  
 R - right hand position  
 DB - disc base support  
 V29 - 1/2 height floating acrylic modesty panel  
 V24 - 1/2 height glass modesty panel

**STANDARD FINISHES**

For a complete list of standard wood finishes please see Page 117.

**GROMMETS**

One grommet in standard position is optional at no charge. Additional rectangular grommets are available at an upcharge of **\$152 list.**

# ARTEMIS | CURVILINEAR DESK RUNOFFS FOR 3/4 HEIGHT CREDENZAS

Description	Model	Rift Oak or	Rift Oak or		C,M,W w/	W	D	H	KW	Shipping Cubic	
		Palette w/ Lam Top & Polymer Edge	Palette w/ Wood or Lam Top & Wood Edge	C,M,W w/ Lam Top & Polymer Edge	C,M,W w/ Wood or Lam Top & Wood Edge					Weight	Feet
Bullet End Desk	76DRB60303LDB	1803	1857	1893	1949	59.75	30	29.5	21.5	109	16
Runoffs no Modesty	76DRB60303RDB	1803	1857	1893	1949	59.75	30	29.5	21.5	109	16
Panel for 3/4	76DRB66303LDB	1832	1884	1922	1980	65.75	30	29.5	27.5	118	17.5
Ht. Credenzas,	76DRB66303RDB	1832	1884	1922	1980	65.75	30	29.5	27.5	118	17.5
Disc Base	76DRB72303LDB	1896	1954	1990	2053	71.75	30	29.5	33.5	126	18.5
	76DRB72303RDB	1896	1954	1990	2053	71.75	30	29.5	33.5	126	18.5
	76DRB72363LDB*	1918	1976	2014	2073	71.75	36	29.5	30	145	21.5
	76DRB72363RDB	1918	1976	2014	2073	71.75	36	29.5	30	145	21.5
	76DRB78303LDB	1988	2048	2087	2148	71.75	30	29.5	39	126	18.5
	76DRB78303RDB	1988	2048	2087	2148	71.75	30	29.5	39	126	18.5
	76DRB78363LDB	2271	2339	2384	2457	71.75	36	29.5	36	145	21.5
	76DRB78363RDB	2271	2339	2384	2457	71.75	36	29.5	36	145	21.5
	76DRB84303LDB	2569	2646	2698	2779	83.75	30	29.5	45	142	21.5
	76DRB84303RDB	2569	2646	2698	2779	83.75	30	29.5	45	142	21.5
	76DRB84363LDB	3084	3179	3239	3336	83.75	36	29.5	42	142	21.5
	76DRB84363RDB	3084	3179	3239	3336	83.75	36	29.5	42	142	21.5



Bullet End Desk	76DRB60303LDB_V21	1947	2006	2045	2107	59.75	30	29.5	21.5	109	16
Runoffs with Wood	76DRB60303RDB_V21	1947	2006	2045	2107	59.75	30	29.5	21.5	109	16
Modesty Panel	76DRB66303LDB_V21	1989	2051	2088	2149	65.75	30	29.5	27.5	118	17.5
for 3/4 Ht.	76DRB66303RDB_V21	1989	2051	2088	2149	65.75	30	29.5	27.5	118	17.5
Credenzas,	76DRB72303LDB_V21	2070	2133	2173	2104	71.75	30	29.5	33.5	126	18.5
Disc Base	76DRB72303RDB_V21	2070	2133	2173	2104	71.75	30	29.5	33.5	126	18.5
	76DRB72363LDB_V21*	2091	2157	2196	2264	71.75	36	29.5	30	145	21.5
	76DRB72363RDB_V21	2091	2157	2196	2264	71.75	36	29.5	30	145	21.5
	76DRB78303LDB_V21	2144	2210	2252	2319	71.75	30	29.5	39	126	18.5
	76DRB78303RDB_V21	2144	2210	2252	2319	71.75	30	29.5	39	126	18.5
	76DRB78363LDB_V21	2614	2695	2745	2829	71.75	36	29.5	36	145	21.5
	76DRB78363RDB_V21	2614	2695	2745	2829	71.75	36	29.5	36	145	21.5
	76DRB84303LDB_V21	2916	3003	3061	3155	83.75	30	29.5	45	142	21.5
	76DRB84303RDB_V21	2916	3003	3061	3155	83.75	30	29.5	45	142	21.5
	76DRB84363LDB_V21	3430	3534	3687	3710	83.75	36	29.5	42	142	21.5
	76DRB84363RDB_V21	3430	3534	3687	3710	83.75	36	29.5	42	142	21.5



**ORDERING NOTES:**

Add -20 before V21 when runoff is to be used with a 20" deep credenza  
 Add -24 before V21 when runoff is to be used with a 24" deep credenza

**DIMENSION KEY**

W - width  
 D - depth  
 H - height

**CODE DESCRIPTION**

L - left hand position  
 R - right hand position  
 DB - disc base support  
 V21 - 1/2 height floating wood modesty panel

**STANDARD FINISHES**

For a complete list of standard wood finishes please see Page 117.

# ARTEMIS | CURVILINEAR DESK RUNOFFS FOR 3/4 HEIGHT CREDENZAS

Description	Model	Rift Oak or	Rift Oak or	C,M,W w/					Shipping Weight	Cubic Feet	
		Palette w/ Lam Top & Polymer Edge	Palette w/ Wood Lam Top & Wood Edge	C,M,W w/ Lam Top & Polymer Edge	C,M,W w/ Wood Lam Top & Wood Edge	W	D	H			KW
Bullet End Desk Runoffs with Acrylic Modesty Panel for 3/4 Ht. Credenzas, Disc Base	76DRB60303LDB_V29	2368	2440	2487	2562	59.75	30	29.5	21.5	109	16
	76DRB60303RDB_V29	2368	2440	2487	2562	59.75	30	29.5	21.5	109	16
	76DRB66303LDB_V29	2449	2523	2570	2649	65.75	30	29.5	27.5	118	17.5
	76DRB66303RDB_V29	2449	2523	2570	2649	65.75	30	29.5	27.5	118	17.5
	76DRB72303LDB_V29	2574	2652	2703	2783	71.75	30	29.5	33.5	126	18.5
	76DRB72303RDB_V29	2574	2652	2703	2783	71.75	30	29.5	33.5	126	18.5
	76DRB72363LDB_V29*	2595	2672	2726	2807	71.75	36	29.5	30	145	21.5
	76DRB72363RDB_V29	2595	2672	2726	2807	71.75	36	29.5	30	145	21.5
	76DRB78303LDB_V29	2597	2676	2728	2810	71.75	30	29.5	39	126	18.5
	76DRB78303RDB_V29	2597	2676	2728	2810	71.75	30	29.5	39	126	18.5
	76DRB78363LDB_V29	3162	3257	3320	3420	71.75	36	29.5	36	145	21.5
	76DRB78363RDB_V29	3162	3257	3320	3420	71.75	36	29.5	36	145	21.5
	76DRB84303LDB_V29	2898	2986	3042	3135	83.75	30	29.5	45	142	21.5
	76DRB84303RDB_V29	2898	2986	3042	3135	83.75	30	29.5	45	142	21.5
	76DRB84363LDB_V29	3520	3627	3697	3809	83.75	36	29.5	42	142	21.5
	76DRB84363RDB_V29	3520	3627	3697	3809	83.75	36	29.5	42	142	21.5



Bullet End Desk Runoffs with Glass Modesty Panel for 3/4 Ht. Credenzas, Disc Base	76DRB60303LDB_V24	2744	2827	2882	2968	59.75	30	29.5	21.5	109	16
	76DRB60303RDB_V24	2744	2827	2882	2968	59.75	30	29.5	21.5	109	16
	76DRB66303LDB_V24	2810	2894	2952	3039	65.75	30	29.5	27.5	118	17.5
	76DRB66303RDB_V24	2810	2894	2952	3039	65.75	30	29.5	27.5	118	17.5
	76DRB72303LDB_V24	2917	3004	3062	3156	71.75	30	29.5	33.5	126	18.5
	76DRB72303RDB_V24	2917	3004	3062	3156	71.75	30	29.5	33.5	126	18.5
	76DRB72363LDB_V24*	2937	3027	3084	3179	71.75	36	29.5	30	145	21.5
	76DRB72363RDB_V24	2937	3027	3084	3179	71.75	36	29.5	30	145	21.5
	76DRB78303LDB_V24	3047	3138	3200	3294	71.75	30	29.5	39	126	18.5
	76DRB78303RDB_V24	3047	3138	3200	3294	71.75	30	29.5	39	126	18.5
	76DRB78363LDB_V24	3061	3155	3215	3312	71.75	36	29.5	36	145	21.5
	76DRB78363RDB_V24	3061	3155	3215	3312	71.75	36	29.5	36	145	21.5
	76DRB84303LDB_V24	3219	3315	3381	3483	83.75	30	29.5	45	142	21.5
	76DRB84303RDB_V24	3219	3315	3381	3483	83.75	30	29.5	45	142	21.5
	76DRB84363LDB_V24	3683	3792	3866	3982	83.75	36	29.5	42	142	21.5
	76DRB84363RDB_V24	3683	3792	3866	3982	83.75	36	29.5	42	142	21.5



**ORDERING NOTE:** Add -20 before V when runoff is to be used with a 20" deep credenza Add -24 before V when runoff is to be used with a 24" deep credenza

Shell Return with Full Height Wood Modesty Panel	76SRH3024LX41	1185	1222	1244	1282	30	24	29.5	29	72.5	18
	76SRH3024RX41	1185	1222	1244	1282	30	24	29.5	29	72.5	18
	76SRH3624LX41	1266	1304	1330	1370	36	24	29.5	35	87	21.5
	76SRH3624RX41	1266	1304	1330	1370	36	24	29.5	35	87	21.5
	76SRH4224LX41	1415	1456	1484	1529	42	24	29.5	41	98	23
	76SRH4224RX41*	1415	1456	1484	1529	42	24	29.5	41	98	23
	76SRH4824LX41	1421	1464	1493	1537	48	24	29.5	47	108	26
	76SRH4824RX41	1421	1464	1493	1537	48	24	29.5	47	108	26
	76SRH5424LX41	1464	1509	1537	1584	54	24	29.5	53	114.5	32.5
	76SRH5424RX41	1464	1509	1537	1584	54	24	29.5	53	114.5	32.5
	76SRH6024LX41	1506	1554	1583	1631	59.75	24	29.5	65	124	36
	76SRH6024RX41	1506	1554	1583	1631	59.75	24	29.5	65	124	36
	76SRH6624LX41	1554	1597	1631	1677	65.75	24	29.5	65	133	39.5
	76SRH6624RX41	1554	1597	1631	1677	65.75	24	29.5	65	133	39.5
	76SRH7224LX41	1598	1645	1678	1730	71.75	24	29.5	71	142	43
	76SRH7224RX41	1598	1645	1678	1730	71.75	24	29.5	71	142	43

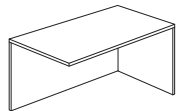

### ORDERING PROCEDURE

To order, please specify the following:

- 1) Krug product model number
- 2) Wood species and finish, see Page 11
- 3) Wood edge detail- I, H, L or P, see Page 3
- 4) Pull style, see Page 4
- 5) Grommet location if applicable

### CODE DESCRIPTION

L - left hand position  
 R - right hand position  
 DB - disc base support  
 V29 - 1/2 height floating acrylic modesty panel  
 V24 - 1/2 height glass modesty panel  
 X41 - full height wood modesty panel

### STANDARD FINISHES

For a complete list of standard wood finishes please see Page 117.

### GROMMETS

One grommet in standard position is optional at no charge. Additional rectangular grommets are available at an upcharge of **\$152 list.**

ARTEMIS | RETURNS

Description	Model	Rift Oak or	Rift Oak or	C,M,W w/	C,M,W w/	W	D	H	KW	Shipping Cubic	
		Palette w/ Lam Top & Polymer Edge	Palette w/ Wood Lam Top & Wood Edge	C,M,W w/ Lam Top & Polymer Edge	C,M,W w/ Wood Lam Top & Wood Edge					Weight	Feet
Single Pedestal Return with 1/2 Height Fixed Wood Modesty Panel	76RH3620L4DX21	1960	2019	2059	2119	36	20	29.5	20	104	18.25
	76RH3620L4FX21	1960	2019	2059	2119	36	20	29.5	20	104	18.25
	76RH3620R4DX21	1960	2019	2059	2119	36	20	29.5	20	108	18.25
	76RH3620R4FX21	1960	2019	2059	2119	36	20	29.5	20	108	18.25
	76RH3624L4DX21	2024	2085	2126	2190	36	24	29.5	20	115	21.5
	76RH3624L4FX21	2024	2085	2126	2190	36	24	29.5	20	115	21.5
	76RH3624R4DX21	2024	2085	2126	2190	36	24	29.5	20	119	21.5
	76RH3624R4FX21	2024	2084	2121	2190	36	24	29.5	20	119	21.5
	76RH4220L4DX21	2504	2579	2630	2710	42	20	29.5	26	100	20
	76RH4220L4FX21	2504	2579	2630	2710	42	20	29.5	26	100	20
	76RH4220R4DX21*	2504	2579	2630	2710	42	20	29.5	26	100	20
	76RH4220R4FX21	2504	2579	2630	2710	42	20	29.5	26	100	20
	76RH4224L4DX21	2538	2596	2664	2744	42	24	29.5	26	104	23
	76RH4224L4FX21	2538	2596	2664	2744	42	24	29.5	26	104	23
	76RH4224R4DX21	2538	2596	2664	2744	42	24	29.5	26	104	23
	76RH4224R4FX21	2538	2596	2664	2744	42	24	29.5	26	104	23
	76RH4820L4DX21	2560	2618	2686	2769	48	20	29.5	32	104	22.5
	76RH4820R4DX21	2560	2618	2686	2769	48	20	29.5	32	104	22.5
	76RH4820L4FX21	2560	2618	2686	2769	48	20	29.5	32	104	22.5
	76RH4820R4FX21	2560	2618	2686	2769	48	20	29.5	32	104	22.5
	76RH4824L4DX21	2569	2630	2697	2779	48	24	29.5	32	108	26
	76RH4824R4DX21	2569	2630	2697	2779	48	24	29.5	32	108	26
	76RH4824L4FX21	2569	2630	2697	2779	48	24	29.5	32	108	26
	76RH4824R4FX21	2569	2630	2697	2779	48	24	29.5	32	108	26
	<b>76RH5424L4DX21</b>	2523	2597	2649	2727	54	24	29.5	38	138	32.5
	<b>76RH5424L4FX21</b>	2523	2597	2649	2727	54	24	29.5	38	138	32.5
	<b>76RH5424R4DX21*</b>	2523	2597	2649	2727	54	24	29.5	38	142	32.5
	<b>76RH5424R4FX21</b>	2523	2597	2649	2727	54	24	29.5	38	142	32.5
	<b>76RH6024L4DX21</b>	2595	2672	2726	2807	59.75	24	29.5	44	146	36
	<b>76RH6024L4FX21</b>	2595	2672	2726	2807	59.75	24	29.5	44	146	36
<b>76RH6024R4DX21</b>	2595	2672	2726	2807	59.75	24	29.5	44	150	36	
<b>76RH6024R4FX21</b>	2595	2672	2726	2807	59.75	24	29.5	44	150	36	
<b>76RH6624L4DX21</b>	2672	2753	2806	2891	65.75	24	29.5	50	158	39.5	
<b>76RH6624L4FX21</b>	2672	2753	2806	2891	65.75	24	29.5	50	158	39.5	
<b>76RH6624R4DX21</b>	2672	2753	2806	2891	65.75	24	29.5	50	162	39.5	
<b>76RH6624R4FX21</b>	2672	2753	2806	2891	65.75	24	29.5	50	162	39.5	
<b>76RH7224L4DX21</b>	2753	2837	2891	2978	71.75	24	29.5	56	166	43	
<b>76RH7224L4FX21</b>	2753	2837	2891	2978	71.75	24	29.5	56	166	43	
<b>76RH7224R4DX21</b>	2753	2837	2891	2978	71.75	24	29.5	56	170	43	
<b>76RH7224R4FX21</b>	2753	2837	2891	2978	71.75	24	29.5	56	170	43	

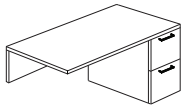

**DIMENSION KEY**

W - width  
D - depth  
H - height

**CODE DESCRIPTION**

L - left hand position  
R - right hand position  
4D - 2 file drawers  
4F - 2 box, 1 file drawer  
X21 - 1/2 height fixed wood modesty panel

**STANDARD FINISHES**

For a complete list of standard wood finishes please see Page 117.

# ARTEMIS | RETURNS

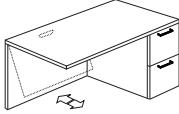
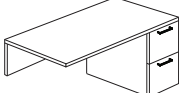
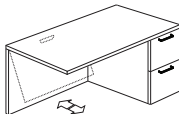
Description	Model	Rift Oak or	Rift Oak or	C,M,W w/	C,M,W w/	W	D	H	KW	Shipping Weight	Cubic Feet
		Palette w/ Lam Top & Polymer Edge	Palette w/ Wood Lam Top & Wood Edge	C,M,W w/ Lam Top & Polymer Edge	C,M,W w/ Wood Lam Top & Wood Edge						
 Single Pedestal Return with Hinged Wood Modesty Panel	76RHY3620L4D	2220	2286	2332	2403	36	20	29.5	20	110	17.25
	76RHY3620L4F	2220	2286	2332	2403	36	20	29.5	20	110	17.25
	76RHY3620R4D	2220	2286	2332	2403	36	20	29.5	20	114	17.25
	76RHY3620R4F	2220	2286	2332	2403	36	20	29.5	20	114	17.25
	76RHY4220L4D	2756	2839	2894	2982	42	20	29.5	26	104	20
	76RHY4220L4F	2756	2839	2894	2982	42	20	29.5	26	104	20
	76RHY4220R4D	2756	2839	2894	2982	42	20	29.5	26	104	20
	76RHY4220R4F	2756	2839	2894	2982	42	20	29.5	26	104	20
	76RHY4224L4D	2791	2858	2933	3021	42	24	29.5	26	108	23
	76RHY4224L4F	2791	2858	2933	3021	42	24	29.5	26	108	23
	76RHY4224R4D*	2791	2858	2933	3021	42	24	29.5	26	108	23
	76RHY4224R4F	2791	2858	2933	3021	42	24	29.5	26	108	23
	76RHY4820L4D	2817	2882	2958	3045	48	20	29.5	32	108	22.5
	76RHY4820L4F	2817	2882	2958	3045	48	20	29.5	32	108	22.5
	76RHY4820R4D	2817	2882	2958	3045	48	20	29.5	32	108	22.5
	76RHY4820R4F	2817	2882	2958	3045	48	20	29.5	32	108	22.5
	76RHY4824L4D	2835	2902	2978	3067	48	24	29.5	32	112	26
	76RHY4824L4F	2835	2902	2978	3067	48	24	29.5	32	112	26
	76RHY4824R4D	2835	2902	2978	3067	48	24	29.5	32	112	26
	76RHY4824R4F	2835	2902	2978	3067	48	24	29.5	32	112	26
 Single Pedestal Return for Table Desk, 1/2 Height Fixed Wood Modesty Panel	76RHTD4224L4FX21	2347	2418	2464	2538	42	24	29.5	26	61	23.25
	76RHTD4224R4FX21	2347	2418	2464	2538	42	24	29.5	26	61	23.25
	76RHTD4824L4FX21	2373	2443	2491	2566	48	24	29.5	32	67	26.25
	76RHTD4824R4FX21*	2373	2443	2491	2566	48	24	29.5	32	67	26.25
	76RHTD6024L4FX21	2398	2470	2520	2594	59.75	24	29.5	44	78	32.25
76RHTD6024R4FX21	2398	2470	2520	2594	59.75	24	29.5	44	78	32.25	
 Single Pedestal Return for Table Desk, Full Height Hinged Wood Modesty Panel	76RHYTD4224L4FX41	2634	2714	2765	2848	42	24	29.5	26	98	23
	76RHYTD4224R4FX41	2634	2684	2718	2773	42	24	29.5	26	98	23
	76RHYTD4824L4FX41	2660	2741	2791	2878	48	24	29.5	32	108	26
	76RHYTD4824R4FX41*	2660	2713	2745	2802	48	24	29.5	32	108	26

### ORDERING PROCEDURE

To order, please specify the following:

- 1) Krug product model number
- 2) Wood species and finish, see Page 11
- 3) Wood edge detail- I, H, L or P, see Page 3
- 4) Pull style, see Page 4
- 5) Grommet location if applicable

### CODE DESCRIPTION

- L - left hand position
- R - right hand position
- 4D - 2 file drawers
- 4F - 2 box, 1 file drawer
- X21 - 1/2 height fixed wood modesty panel
- X41 - full height wood modesty panel

### STANDARD FINISHES

For a complete list of standard wood finishes please see Page 117.

### GROMMETS

One grommet in standard position is optional at no charge. Additional rectangular grommets are available at an upcharge of **\$152 list.**

# ARTEMIS | CURVILINEAR RETURNS

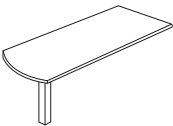
Description	Model	Rift Oak or	Rift Oak or	C,M,W w/	C,M,W w/	W	D	H	KW	Shipping Weight	Cubic Feet
		Palette w/ Lam Top & Polymer Edge	Palette w/ Wood or Lam Top & Wood Edge	C,M,W w/ Lam Top & Polymer Edge	C,M,W w/ Wood or Lam Top & Wood Edge						
Arc Return with Square Wood Leg and no Modesty Panel 	76RHA4830LS1	1559	1607	1639	1686	47.75	30	29.5	30.75	58	8.5
	76RHA4830RS1	1559	1607	1639	1686	47.75	30	29.5	30.75	58	8.5
	76RHA4836LS1	1569	1618	1647	1698	47.75	36	29.5	27.75	66	9.5
	76RHA4836RS1	1569	1618	1647	1698	47.75	36	29.5	27.75	66	9.5
	76RHA5430LS1	1584	1632	1664	1713	53.75	30	29.5	36.75	63	9
	76RHA5430RS1	1584	1632	1664	1713	53.75	30	29.5	36.75	63	9
	76RHA5436LS1	1594	1642	1673	1724	53.75	36	29.5	33.75	71	10.5
	76RHA5436RS1	1594	1642	1673	1724	53.75	36	29.5	33.75	71	10.5
	76RHA6030LS1	1607	1654	1688	1736	59.75	30	29.5	42.75	68	10
	76RHA6030RS1	1607	1654	1688	1736	59.75	30	29.5	42.75	68	10
	76RHA6036LS1	1619	1667	1702	1751	59.75	36	29.5	39.75	77	11.5
	76RHA6036RS1	1619	1667	1702	1751	59.75	36	29.5	39.75	77	11.5
	76RHA6630LS1	1632	1677	1713	1764	65.75	30	29.5	48.75	99	10.75
	76RHA6630RS1	1632	1677	1713	1764	65.75	30	29.5	48.75	99	10.75
	76RHA6636LS1*	1647	1699	1732	1781	65.75	36	29.5	45.75	88	12.5
	76RHA6636RS1	1647	1699	1732	1781	65.75	36	29.5	45.75	88	12.5
	76RHA7230LS1	1693	1746	1778	1834	71.75	30	29.5	54.75	104	11.5
	76RHA7230RS1	1693	1746	1778	1834	71.75	30	29.5	54.75	104	11.5
	<b>76RHA7236LS1</b>	1735	1789	1822	1879	71.75	36	29.5	51.75	55	13.5
	<b>76RHA7236RS1</b>	1735	1789	1822	1879	71.75	36	29.5	51.75	55	13.5
	<b>76RHA7830LS1</b>	1844	1899	1936	1995	77.75	30	29.5	56.75	58	8.5
	<b>76RHA7830RS1</b>	1844	1899	1936	1995	77.75	30	29.5	56.75	58	8.5
	<b>76RHA7836LS1</b>	2004	2058	2106	2168	77.75	36	29.5	56.75	66	9.5
	<b>76RHA7836RS1*</b>	2004	2058	2106	2168	77.75	36	29.5	56.75	66	9.5
	<b>76RHA8430LS1</b>	1801	1855	1890	1946	83.75	30	29.5	66.75	114	13
	<b>76RHA8430RS1</b>	1801	1855	1890	1946	83.75	30	29.5	66.75	114	13
<b>76RHA8436LS1</b>	1819	1875	1911	1967	83.75	36	29.5	63.75	108	15	
<b>76RHA8436RS1</b>	1819	1875	1911	1967	83.75	36	29.5	63.75	108	15	

**ORDERING NOTES:**

All Returns with a "S1" at the end of the model number are available with a 4" diameter metal leg, please replace "S1" with a "D8" to the existing model number ie: 76RHA4830LD8. All returns with a "S1" at the end of the model number are available with a Panel Leg, please replace "S1" with "P1" in the model number ie: 76RHA4830LP1

**DIMENSION KEY**

W - width  
D - depth  
H - height

**CODE DESCRIPTION**

L - left hand position  
R - right hand position  
S1 - square wood leg  
D8 - 4" diameter metal leg  
P1 - panel leg

**STANDARD FINISHES**

For a complete list of standard wood finishes please see Page 117.

**PALETTE FINISHES**

Artemis Casegoods are available for full cases in a PALETTE finish for the same price as the Rift Oak with Polymer Edge column in the price guide.

# ARTEMIS | CURVILINEAR RETURNS

Description	Model	Rift Oak or	Rift Oak or	C,M,W w/	C,M,W w/	W	D	H	KW	Shipping Weight	Cubic Feet
		Palette w/ Lam Top & Polymer Edge	Palette w/ Wood or Lam Top & Wood Edge	C,M,W w/ Lam Top & Polymer Edge	C,M,W w/ Wood or Lam Top & Wood Edge						
Arc Return with Disc Base and no Modesty Panel 	76RHA4830LDB	1918	1976	2014	2073	47.75	30	29.5	30.75	56	8.5
	76RHA4830RDB	1918	1976	2014	2073	47.75	30	29.5	30.75	56	8.5
	76RHA4836LDB	1928	1987	2026	2087	47.75	36	29.5	27.75	64	12
	76RHA4836RDB	1928	1987	2026	2087	47.75	36	29.5	27.75	64	12
	76RHA5430LDB	1944	2002	2040	2103	53.75	30	29.5	36.75	61	9
	76RHA5430RDB	1944	2002	2040	2103	53.75	30	29.5	36.75	61	9
	76RHA5436LDB	1954	2012	2053	2112	53.75	36	29.5	33.75	69	13
	76RHA5436RDB	1954	2012	2053	2112	53.75	36	29.5	33.75	69	13
	76RHA6030LDB	1965	2024	2063	2126	59.75	30	29.5	42.75	65	10
	76RHA6030RDB	1965	2024	2063	2126	59.75	30	29.5	42.75	65	10
	76RHA6036LDB	1980	2037	2079	2139	59.75	36	29.5	39.75	75	13.75
	76RHA6036RDB	1980	2037	2079	2139	59.75	36	29.5	39.75	75	13.75
	76RHA6630LDB	1989	2051	2088	2149	65.75	30	29.5	48.75	70	10.75
	76RHA6630RDB	1989	2051	2088	2149	65.75	30	29.5	48.75	70	10.75
	76RHA6636LDB*	2007	2066	2108	2170	65.75	36	29.5	45.75	93	14
	76RHA6636RDB	2007	2066	2108	2170	65.75	36	29.5	45.75	93	14
	76RHA7230LDB	2055	2114	2158	2220	71.75	30	29.5	54.75	79	11.5
	76RHA7230RDB	2055	2114	2158	2220	71.75	30	29.5	54.75	79	11.5
	76RHA7236LDB	2094	2160	2198	2266	71.75	36	29.5	51.75	100	15
	76RHA7236RDB	2094	2160	2198	2266	71.75	36	29.5	51.75	100	15
	76RHA7830LDB	2205	2271	2315	2384	77.75	30	29.5	56.75	84	13
	76RHA7830RDB	2205	2271	2315	2384	77.75	30	29.5	56.75	84	13
	76RHA7836LDB	2364	2434	2483	2557	77.75	36	29.5	53.75	106	16
	76RHA7836RDB	2364	2434	2483	2557	77.75	36	29.5	53.75	106	16
	76RHA8430LDB	2569	2646	2698	2779	83.75	30	29.5	66.75	89	14.5
	76RHA8430RDB	2569	2646	2698	2779	83.75	30	29.5	66.75	89	14.5
	76RHA8436LDB	3084	3179	3239	3336	83.75	36	29.5	63.75	113	17
	76RHA8436RDB	3084	3179	3239	3336	83.75	36	29.5	63.75	113	17

### ORDERING PROCEDURE

To order, please specify the following:

- 1) Krug product model number
- 2) Wood species and finish, see Page 11
- 3) Wood edge detail- I,H, L or P, see Page 3
- 4) Pull style, see Page 4
- 5) Grommet location if applicable

\*Indicates model illustrated by line drawing.

### CODE DESCRIPTION

L - left hand pedestal position  
 R - right hand pedestal position  
 DB - disc base support  
 D8- 4" metal leg

### STANDARD FINISHES

For a complete list of standard wood finishes please see Page 117.

### GROMMETS

One grommet in standard position is optional at no charge. Additional rectangular grommets are available at an upcharge of **\$152 list.**

# ARTEMIS | CURVILINEAR RETURNS

Description	Model	Rift Oak or	Rift Oak or	C,M,W w/	C,M,W w/	Shipping Cubic					
		Palette w/ Lam Top & Polymer Edge	Palette w/ Wood Lam Top & Wood Edge	C,M,W w/ Lam Top & Polymer Edge	C,M,W w/ Wood Lam Top & Wood Edge	W	D	H	KW	Weight	Feet
Arc Return with	76RHA4830LV21S1	1685	1735	1769	1821	47.75	30	29.5	30.75	67	9
Square Wood Leg	76RHA4830RV21S1	1685	1735	1769	1821	47.75	30	29.5	30.75	67	9
and 1/2 Height	76RHA4836LV21S1	1695	1747	1779	1835	47.75	36	29.5	27.75	69	10
Floating Wood	76RHA4836RV21S1	1695	1747	1779	1835	47.75	36	29.5	27.75	69	10
Modesty Panel	76RHA5430LV21S1	1709	1761	1796	1849	53.75	30	29.5	36.75	73	10
	76RHA5430RV21S1	1709	1761	1796	1849	53.75	30	29.5	36.75	73	10
	76RHA5436LV21S1	1724	1776	1810	1863	53.75	36	29.5	33.75	75	11
	76RHA5436RV21S1	1724	1776	1810	1863	53.75	36	29.5	33.75	75	11
	76RHA6030LV21S1	1735	1789	1822	1879	59.75	30	29.5	42.75	80	11
	76RHA6030RV21S1	1735	1789	1822	1879	59.75	30	29.5	42.75	80	11
	76RHA6036LV21S1	1748	1802	1836	1892	59.75	36	29.5	39.75	82	12
	76RHA6036RV21S1	1748	1802	1836	1892	59.75	36	29.5	39.75	82	12
	76RHA6630LV21S1	1765	1817	1854	1908	65.75	30	29.5	48.75	128	12
	76RHA6630RV21S1	1765	1817	1854	1908	65.75	30	29.5	48.75	128	12
	76RHA6636LV21S1*	1780	1836	1870	1926	65.75	36	29.5	45.75	103	13
	76RHA6636RV21S1	1780	1836	1870	1926	65.75	36	29.5	45.75	103	13
	76RHA7230LV21S1	1828	1883	1921	1979	71.75	30	29.5	54.75	136	13
	76RHA7230RV21S1	1828	1883	1921	1979	71.75	30	29.5	54.75	136	13
	76RHA7236LV21S1	1871	1927	1965	2024	71.75	36	29.5	51.75	110	14
	76RHA7236RV21S1	1871	1927	1965	2024	71.75	36	29.5	51.75	110	14
	76RHA7830LV21S1	1884	1941	1980	2037	47.75	30	29.5	60.75	67	9
	76RHA7830RV21S1	1884	1941	1980	2037	47.75	30	29.5	60.75	67	9
	76RHA7836LV21S1	1921	1979	2017	2077	47.75	36	29.5	57.75	69	10
	76RHA7836RV21S1	1921	1979	2017	2077	47.75	36	29.5	57.75	69	10
	76RHA8430LV21S1	1938	1997	2033	2094	83.75	30	29.5	66.75	153	15
	76RHA8430RV21S1	1938	1997	2033	2094	83.75	30	29.5	66.75	153	15
	76RHA8436LV21S1	1966	2026	2063	2126	83.75	36	29.5	63.75	124	16
	76RHA8436RV21S1	1966	2026	2063	2126	83.75	36	29.5	63.75	124	16



**ORDERING NOTES:**

All Returns with a "S1" at the end of the model number are available with a 4" diameter metal leg, please replace "S1" with a "D8" to the existing model number ie: 76RH\_6630LD8. All returns with a "S1" at the end of the model number are available with a Panel Leg, please replace "S1" with "P1" in the model number ie: 76RH\_6630LP1

<p><b>DIMENSION KEY</b>                  W - width                  D - depth                  H - height</p>	<p><b>CODE DESCRIPTION</b>                  L - left hand pedestal position                  R - right hand pedestal position                  V21 - 1/2 height floating wood modesty panel                  S1- square wood leg                  D8- 4" metal leg                  P1- panel leg</p>	<p><b>STANDARD FINISHES</b>                  For a complete list of standard wood finishes please see Page 117.</p>
---	---	---



# ARTEMIS | CURVILINEAR RETURNS

Description	Model	Rift Oak or	Rift Oak or	C,M,W w/		W	D	H	KW	Shipping Weight	Cubic Feet
		Palette w/ Lam Top & Polymer Edge	Palette w/ Wood Lam Top & Wood Edge	C,M,W w/ Lam Top & Polymer Edge	C,M,W w/ Wood Lam Top & Wood Edge						
Arc Return with Disc Base and 1/2 Height Floating Wood Modesty Panel	76RHA4830LV21DB	2043	2106	2145	2211	47.75	30	29.5	30.75	56	8.5
	76RHA4830RV21DB	2043	2106	2145	2211	47.75	30	29.5	30.75	56	8.5
	76RHA4836LV21DB	2056	2117	2160	2221	47.75	36	29.5	27.75	64	12
	76RHA4836RV21DB	2056	2117	2160	2221	47.75	36	29.5	27.75	64	12
	76RHA5430LV21DB	2066	2132	2172	2238	53.75	30	29.5	36.75	61	9
	76RHA5430RV21DB	2066	2132	2172	2238	53.75	30	29.5	36.75	61	9
	76RHA5436LV21DB	2085	2146	2190	2253	53.75	36	29.5	33.75	69	13
	76RHA5436RV21DB	2085	2146	2190	2253	53.75	36	29.5	33.75	69	13
	76RHA6030LV21DB	2094	2160	2198	2266	59.75	30	29.5	42.75	65	10
	76RHA6030RV21DB	2094	2160	2198	2266	59.75	30	29.5	42.75	65	10
	76RHA6036LV21DB	2108	2170	2214	2280	59.75	36	29.5	39.75	75	13.75
	76RHA6036RV21DB	2108	2170	2214	2280	59.75	36	29.5	39.75	75	13.75
	76RHA6630RV21DB	2122	2186	2229	2297	65.75	30	29.5	48.75	70	10.75
	76RHA6630LV21DB	2122	2186	2229	2297	65.75	30	29.5	48.75	70	10.75
	76RHA6636LV21DB*	2139	2205	2247	2315	65.75	36	29.5	45.75	93	14
	76RHA6636RV21DB	2139	2205	2247	2315	65.75	36	29.5	45.75	93	14
	76RHA7230LV21DB	2190	2254	2298	2366	71.75	30	29.5	54.75	79	11.5
	76RHA7230RV21DB	2190	2254	2298	2366	71.75	30	29.5	54.75	79	11.5
	76RHA7236LV21DB	2230	2298	2342	2412	71.75	36	29.5	51.75	100	15
	76RHA7236RV21DB	2230	2298	2342	2412	71.75	36	29.5	51.75	100	15
	76RHA7830LV21DB	2542	2618	2670	2747	77.75	30	29.5	58.75	84	13
	76RHA7830RV21DB	2542	2618	2670	2747	77.75	30	29.5	58.75	84	13
	76RHA7836LV21DB	2698	2779	2833	2919	77.75	36	29.5	55.75	106	16
	76RHA7836RV21DB	2698	2779	2833	2919	77.75	36	29.5	55.75	106	16
	76RHA8430LV21DB	2916	3003	3061	3155	83.75	30	29.5	66.75	89	14.5
	76RHA8430RV21DB	2916	3003	3061	3155	83.75	30	29.5	66.75	89	14.5
	76RHA8436LV21DB	3430	3534	3603	3710	83.75	36	29.5	63.75	113	17
	76RHA8436RV21DB	3430	3534	3603	3710	83.75	36	29.5	63.75	113	17



Arc Return with Square Wood Leg and 1/2 Height Fixed Wood Modesty Panel	76RHA4836LX21S1	1695	1747	1779	1835	47.75	36	29.5	27.75	101	36.5
	76RHA4836RX21S1	1695	1747	1779	1835	47.75	36	29.5	27.75	101	36.5
	76RHA5436LX21S1	1724	1776	1810	1863	53.75	36	29.5	33.75	111	40.5
	76RHA5436RX21S1	1724	1776	1810	1863	53.75	36	29.5	33.75	111	40.5
	76RHA6036LX21S1	1748	1802	1836	1892	59.75	36	29.5	39.75	120	44.5
	76RHA6036RX21S1	1748	1802	1836	1892	59.75	36	29.5	39.75	120	44.5
	76RHA6636LX21S1*	1780	1836	1870	1926	65.75	36	29.5	45.75	128	50
	76RHA6636RX21S1	1780	1836	1870	1926	65.75	36	29.5	45.75	128	50
	76RHA7236LX21S1	1871	1927	1965	2024	71.75	36	29.5	51.75	136	54.75
	76RHA7236RX21S1	1871	1927	1965	2024	71.75	36	29.5	51.75	136	54.75
	76RHA7830LX21S1	1964	2023	2061	2124	77.75	30	29.5	57.75	149	58
	76RHA7830RX21S1	1964	2023	2061	2124	77.75	30	29.5	57.75	149	58
	76RHA7836LX21S1	1921	1979	2017	2077	77.75	36	29.5	57.75	150	36.5
	76RHA7836RX21S1	1921	1979	2017	2077	77.5	36	29.5	57.75	150	36.5
	76RHA8436LX21S1	1966	2026	2063	2126	83.75	36	29.5	63.75	153	63
	76RHA8436RX21S1	1966	2026	2063	2126	83.75	36	29.5	63.75	153	63



**ORDERING NOTES:**

All Returns with a "S1" at the end of the model number are available with a 4" diameter metal leg, please replace "S1" with a "D8" to the existing model number ie: 76RH\_6630LD8. All returns with a "S1" at the end of the model number are available with a Panel Leg, please replace "S1" with "P1" in the model number ie: 76RH\_6630LP1

**ORDERING PROCEDURE**

To order, please specify the following:

- 1) Krug product model number
- 2) Wood species and finish, see Page 11
- 3) Wood edge detail- I,H, L or P, see Page 3
- 4) Pull style, see Page 4
- 5) Grommet location if applicable

**CODE DESCRIPTION**

- L - left hand pedestal position
- R - right hand pedestal position
- V21 - 1/2 height floating wood modesty panel
- DB - disc base support
- S1 - square wood leg
- D8- 4" metal leg
- P1 - panel leg

**STANDARD FINISHES**

For a complete list of standard wood finishes please see Page 117.

**GROMMETS**

One grommet in standard position is optional at no charge. Additional rectangular grommets are available at an upcharge of **\$152 list.**

# ARTEMIS | CURVILINEAR RETURNS

Description	Model	Rift Oak or	Rift Oak or	C,M,W w/		W	D	H	KW	Shipping Cubic	
		Palette w/ Lam Top & Polymer Edge	Wood or Lam Top & Wood Edge	C,M,W w/ Lam Top & Polymer Edge	Wood or Lam Top & Wood Edge					Weight	Feet
Arc Return with Square Wood Leg and 1/2 Height Floating Acrylic Modesty Panel	76RHA4830LV29S1	1685	1735	1769	1821	47.75	30	29.5	30.75	62	8.75
	76RHA4830RV29S1	1685	1735	1769	1821	47.75	30	29.5	30.75	62	8.75
	76RHA4836LV29S1	1695	1747	1779	1835	47.75	36	29.5	27.75	69	10
	76RHA4836RV29S1	1695	1747	1779	1835	47.75	36	29.5	27.75	69	10
	76RHA5430LV29S1	1709	1761	1796	1849	53.75	30	29.5	36.75	67	9
	76RHA5430RV29S1	1709	1761	1796	1849	53.75	30	29.5	36.75	67	9
	76RHA5436LV29S1	1724	1776	1810	1863	53.75	36	29.5	33.75	75	11
	76RHA5436RV29S1	1724	1776	1810	1863	53.75	36	29.5	33.75	75	11
	76RHA6030LV29S1	1735	1789	1822	1879	59.75	30	29.5	42.75	72	10
	76RHA6030RV29S1	1735	1789	1822	1879	59.75	30	29.5	42.75	72	10
	76RHA6036LV29S1	1748	1802	1836	1892	59.75	36	29.5	39.75	82	12
	76RHA6036RV29S1	1748	1802	1836	1892	59.75	36	29.5	39.75	82	12
	76RHA6630LV29S1	1765	1817	1854	1908	65.75	30	29.5	48.75	103	11.5
	76RHA6630RV29S1	1765	1817	1854	1908	65.75	30	29.5	48.75	103	11.5
	76RHA6636LV29S1*	1780	1836	1870	1926	65.75	36	29.5	45.75	103	13
	76RHA6636RV29S1	1780	1836	1870	1926	65.75	36	29.5	48.75	103	13
	76RHA7230LV29S1	1828	1883	1921	1979	71.75	30	29.5	54.75	110	12
	76RHA7230RV29S1	1828	1883	1921	1979	71.75	30	29.5	54.75	110	12
	76RHA7236LV29S1	1871	1927	1965	2024	71.75	36	29.5	51.75	110	14
	76RHA7236RV29S1	1871	1927	1965	2024	71.75	36	29.5	51.75	110	14
	76RHA7830LV29S1	1964	2023	2061	2124	77.5	30	29.5	58.75	62	8.75
	76RHA7830RV29S1	1964	2023	2061	2124	77.5	30	29.5	58.75	62	8.75
	76RHA7836LV29S1	1921	1979	2017	2077	77.5	36	29.5	55.75	69	10
	76RHA7836RV29S1	1921	1979	2017	2077	77.5	36	29.5	55.75	69	10
	76RHA8430LV29S1	1938	1997	2033	2094	83.75	30	29.5	66.75	124	14
	76RHA8430RV29S1	1938	1997	2033	2094	83.75	30	29.5	66.75	124	14
	76RHA8436LV29S1	1966	2026	2063	2126	83.75	36	29.5	63.75	124	16
76RHA8436RV29S1	1966	2026	2063	2126	83.75	36	29.5	63.75	124	16	
Bullet Return with Disc Base and no Modesty Panel	76RHB4830LDB	1918	1976	2014	2073	47.75	30	29.5	30.75	56	8.5
	76RHB4830RDB	1918	1976	2014	2073	47.75	30	29.5	30.75	56	8.5
	76RHB4836LDB	1928	1987	2026	2087	47.75	36	29.5	27.75	64	12
	76RHB4836RDB	1928	1987	2026	2087	47.75	36	29.5	27.75	64	12
	76RHB5430LDB	1944	2002	2040	2103	53.75	30	29.5	36.75	61	9
	76RHB5430RDB	1944	2002	2040	2103	53.75	30	29.5	36.75	61	9
	76RHB5436LDB	1954	2012	2053	2112	53.75	36	29.5	33.75	69	13
	76RHB5436RDB	1954	2012	2053	2112	53.75	36	29.5	33.75	69	13
	76RHB6030LDB	1965	2024	2063	2126	59.75	30	29.5	42.75	65	10
	76RHB6030RDB	1965	2024	2063	2126	59.75	30	29.5	42.75	65	10
	76RHB6036LDB	1980	2037	2079	2139	59.75	36	29.5	39.75	75	13.75
	76RHB6036RDB	1980	2037	2079	2139	59.75	36	29.5	39.75	75	13.75
	76RHB6630RDB	1989	2051	2088	2149	65.75	30	29.5	48.75	70	10.75
	76RHB6630LDB	1989	2051	2088	2149	65.75	30	29.5	48.75	70	10.75
	76RHB6636LDB	2007	2066	2108	2170	65.75	36	29.5	54.75	93	14
	76RHB6636RDB	2007	2066	2108	2170	65.75	36	29.5	54.75	93	14
	76RHB7230LDB	2055	2114	2158	2220	71.75	30	29.5	51.75	79	11.5
	76RHB7230RDB*	2055	2114	2158	2220	71.75	30	29.5	51.75	79	11.5
	76RHB7236LDB	2094	2160	2198	2266	71.75	36	29.5	58.75	100	15
76RHB7236RDB	2094	2160	2198	2266	71.75	36	29.5	58.75	100	15	



**DIMENSION KEY**

W - width  
D - depth  
H - height



**CODE DESCRIPTION**

L - left hand pedestal position  
R - right hand pedestal position  
V29 - 1/2 height floating acrylic modesty panel  
S1 - square wood leg  
D8- 4" metal leg  
P1- panel leg  
DB - disc base support

**STANDARD FINISHES**

For a complete list of standard wood finishes please see Page 117.

# ARTEMIS | CURVILINEAR RETURNS

Description	Model	Rift Oak or	Rift Oak or	C,M,W w/	C,M,W w/	W	D	H	KW	Shipping Weight	Cubic Feet
		Palette w/ Lam Top & Polymer Edge	Palette w/ Wood Lam Top & Wood Edge	C,M,W w/ Lam Top & Polymer Edge	C,M,W w/ Wood Lam Top & Wood Edge						
Bullet Return with Disc Base and no Modesty Panel continued 	76RHB7830LDB	2205	2271	2315	2384	77.75	30	29.5	58.75	84	13
	76RHB7830RDB	2205	2271	2315	2384	77.75	30	29.5	58.75	84	13
	76RHB7836LDB	2364	2434	2483	2557	77.75	36	29.5	55.75	106	16
	76RHB7836RDB	2364	2434	2483	2557	77.75	36	29.5	55.75	106	16
	76RHB8430LDB	2569	2646	2698	2779	83.75	30	29.5	66.75	89	14.5
	76RHB8430RDB	2569	2646	2698	2779	83.75	30	29.5	66.75	89	14.5
	76RHB8436LDB	3084	3179	3239	3336	83.75	36	29.5	63.75	113	17
	76RHB8436RDB	3084	3179	3239	3336	83.75	36	29.5	63.75	113	17
Bullet Return with Square Wood Leg and 1/2 Height Floating Wood Modesty Panel 	76RHB4830LV21S1	1685	1735	1769	1821	47.75	30	29.5	30	66	9
	76RHB4830RV21S1	1685	1735	1769	1821	47.75	30	29.5	30	66	9
	76RHB5430LV21S1	1709	1761	1796	1849	53.75	30	29.5	36	72	9.75
	76RHB5430RV21S1	1709	1761	1796	1849	53.75	30	29.5	36	72	9.75
	76RHB5436LV21S1	1723	1774	1809	1862	54	36	29.5	33	101	10
	76RHB5436RV21S1	1723	1774	1809	1862	54	36	29.5	33	101	10
	76RHB6030LV21S1	1735	1789	1822	1879	59.75	30	29.5	42	108	11
	76RHB6030RV21S1	1735	1789	1822	1879	59.75	30	29.5	42	108	11
	76RHB6630LV21S1*	1765	1817	1854	1908	65.75	30	29.5	48	115	12
	76RHB6630RV21S1	1765	1817	1854	1908	65.75	30	29.5	48	115	12
	76RHB7230LV21S1	1828	1883	1921	1979	71.75	30	29.5	54	122	13
	76RHB7230RV21S1	1828	1883	1921	1979	71.75	30	29.5	54	122	13
	76RHB7830LV21S1	1884	1942	1980	2037	77.75	30	29.5	60	129	14
	76RHB7830RV21S1	1884	1942	1980	2037	77.75	30	29.5	60	129	14
76RHB8430LV21S1	1938	1997	2033	2094	83.75	30	29.5	66	136	15	
76RHB8430RV21S1	1938	1997	2033	2094	83.75	30	29.5	66	136	15	
Bullet Return with Square Wood Leg and 1/2 Height Fixed Wood Modesty Panel 	76RHB4836LX21S1	1695	1747	1779	1835	47.75	36	29.5	27	71	36.5
	76RHB4836RX21S1	1695	1747	1779	1835	47.75	36	29.5	27	71	36.5
	76RHB5436LX21S1	1724	1776	1810	1863	53.75	36	29.5	33	78	40.5
	76RHB5436RX21S1	1724	1776	1810	1863	53.75	36	29.5	33	78	40.5
	76RHB6036LX21S1	1751	1804	1839	1894	59.75	36	29.5	39	117	46
	76RHB6036RX21S1	1751	1804	1839	1894	59.75	36	29.5	39	117	46
	76RHB6636LX21S1	1780	1836	1870	1926	65.75	36	29.5	45	125	50
	76RHB6636RX21S1*	1780	1836	1870	1926	65.75	36	29.5	45	125	50
	76RHB7236LX21S1	1871	1927	1965	2024	71.75	36	29.5	51	133	54.75
	76RHB7236RX21S1	1871	1927	1965	2024	71.75	36	29.5	51	133	54.75
	76RHB7836LX21S1	1921	1979	2017	2077	77.75	36	29.5	57	141	57
	76RHB7836RX21S1	1921	1979	2017	2077	77.75	36	29.5	57	141	57
76RHB8436LX21S1	1966	2026	2063	2126	83.75	36	29.5	63	150	63	
76RHB8436RX21S1	1966	2026	2063	2126	83.75	36	29.5	63	150	63	

**ORDERING NOTES:**

All Returns with a "S1" at the end of the model number are available with a 4" diameter metal leg, please replace "S1" with a "D8" to the existing model number ie: 76RH\_6630LD8. All returns with a "S1" at the end of the model number are available with a Panel Leg, please replace "S1" with "P1" in the model number ie: 76RH\_6630LP1

**ORDERING PROCEDURE**

To order, please specify the following:

- 1) Krug product model number
- 2) Wood species and finish, see Page 11
- 3) Wood edge detail- I,H, L or P, see Page 3
- 4) Pull style, see Page 4
- 5) Grommet location if applicable

\*Indicates model illustrated by line drawing.

**CODE DESCRIPTION**

**CODE DESCRIPTION**

- L - left hand pedestal position
- R - right hand pedestal position
- DB - disc base support
- X21 - 1/2 height fixed wood modesty panel
- V21 - 1/2 height floating wood modesty panel
- S1 - square wood leg
- D8- 4" metal leg
- P1- panel leg



**STANDARD FINISHES**

For a complete list of standard wood finishes please see Page 117.

**GROMMETS**

One grommet in standard position is optional at no charge. Additional rectangular grommets are available at an upcharge of **\$152 list.**

# ARTEMIS | CURVILINEAR RETURNS

Description	Model	Rift Oak or	Rift Oak or	C,M,W w/		W	D	H	KW	Shipping Cubic	
		Palette w/ Lam Top & Polymer Edge	Palette w/ Wood Lam Top & Wood Edge	C,M,W w/ Lam Top & Polymer Edge	C,M,W w/ Wood Lam Top & Wood Edge					Weight	Feet
	76RHB4830LV29S1	1685	1735	1769	1821	47.75	30	29.5	30	60	9
	76RHB4830RV29S1	1685	1735	1769	1821	47.75	30	29.5	30	60	10.5
	76RHB4836LV29S1	1695	1747	1779	1835	47.75	36	29.5	27	66	10.5
	76RHB4836RV29S1	1695	1747	1779	1835	47.75	36	29.5	27	66	10.5
	76RHB5430LV29S1	1709	1761	1796	1849	53.75	30	29.5	36	65	9.75
	76RHB5430RV29S1	1709	1761	1796	1849	53.75	30	29.5	36	65	11.5
	76RHB5436LV29S1	1724	1776	1810	1863	53.75	36	29.5	33	72	11.5
	76RHB5436RV29S1	1724	1776	1810	1863	53.75	36	29.5	33	72	11.5
	76RHB6030LV29S1	1735	1789	1822	1879	59.75	30	29.5	42	87	10.5
	76RHB6030RV29S1*	1735	1789	1822	1879	59.75	30	29.5	42	87	10.5
	76RHB6036LV29S1	1751	1804	1839	1894	59.75	36	29.5	39	94	12
	76RHB6036RV29S1	1751	1804	1839	1894	59.75	36	29.5	39	94	12
	76RHB6630LV29S1	1765	1817	1854	1908	65.75	30	29.5	48	93	11.5
	76RHB6630RV29S1	1765	1817	1854	1908	65.75	30	29.5	48	93	11.5
	76RHB6636LV29S1	1780	1836	1870	1926	65.75	36	29.5	45	100	13
	76RHB6636RV29S1	1780	1836	1870	1926	65.75	36	29.5	45	100	13
	76RHB7230LV29S1	1828	1883	1921	1979	71.75	30	29.5	54	99	12
	76RHB7230RV29S1	1828	1883	1921	1979	71.75	30	29.5	54	99	12
	76RHB7236LV29S1	1871	1927	1965	2024	71.75	36	29.5	51	107	14
	76RHB7236RV29S1	1871	1927	1965	2024	71.75	36	29.5	51	107	14
76RHB7830LV29S1	1884	1942	1980	2037	77.75	30	29.5	60	104	13	
76RHB7830RV29S1	1884	1942	1980	2037	77.75	30	29.5	60	104	13	
76RHB7836LV29S1	1921	1979	2017	2077	77.75	36	29.5	57	114	15	
76RHB7836RV29S1*	1921	1979	2017	2077	77.75	36	29.5	57	114	15	
76RHB8430LV29S1	1938	1997	2033	2094	83.75	30	29.5	66	110	14	
76RHB8430RV29S1	1938	1997	2033	2094	83.75	30	29.5	66	110	14	
76RHB8436LV29S1	1966	2026	2063	2126	83.75	36	29.5	63	120	16	
76RHB8436RV29S1	1966	2026	2063	2126	83.75	36	29.5	63	120	16	
	76RHC4830LS1	1559	1607	1639	1686	47.75	32	29.5		54	36.5
	76RHC4830RS1	1559	1607	1639	1686	47.75	32	29.5		54	36.5
	76RHC5430LS1	1584	1633	1664	1713	53.75	32.5	29.5		59	40.5
	76RHC5430RS1	1584	1633	1664	1713	53.75	32.5	29.5		59	40.5
	76RHC6030LS1	1607	1657	1688	1736	59.75	33	29.5		64	44.5
	76RHC6030RS1	1607	1657	1688	1736	59.75	33	29.5		64	44.5
	76RHC6630LS1	1632	1678	1713	1764	65.75	33.5	29.5		69	49
	76RHC6630RS1*	1632	1678	1713	1764	65.75	33.5	29.5		69	49
	76RHC7230LS1	1693	1746	1778	1834	71.75	33.75	29.5		86	67
	76RHC7230RS1	1693	1746	1778	1834	71.75	33.75	29.5		86	67
	76RHC7830LS1	1756	1810	1844	1899	77.75	34.25	29.5		92	72.75
	76RHC7830RS1	1756	1810	1844	1899	77.75	34.25	29.5		92	72.75
	76RHC8430LS1	1819	1875	1911	1967	83.75	34.5	29.5		95	82.75
	76RHC8430RS1	1819	1875	1911	1967	83.75	34.5	29.5		95	82.75

**ORDERING NOTES:**

All Returns with a "S1" at the end of the model number are available with a 4" diameter metal leg, please replace "S1" with a "D8" to the existing model number ie: 76RH\_6630LD8. All returns with a "S1" at the end of the model number are available with a Panel Leg, please replace "S1" with "P1" in the model number ie: 76RH\_6630LP1

**DIMENSION KEY**

W - width  
D - depth  
H - height

**CODE DESCRIPTION**

L - left hand pedestal position  
R - right hand pedestal position  
S1 - square wood leg  
P1 - panel leg  
D8- 4" metal leg  
V29 - 1/2 height floating acrylic modesty pane

**STANDARD FINISHES**

For a complete list of standard wood finishes please see Page 117.

# ARTEMIS | RETURNS

Description	Model	Rift Oak or	Rift Oak or	C,M,W w/		W	D	H	KW	Shipping Weight	Cubic Feet
		Palette w/ Lam Top & Polymer Edge	Wood or Lam Top & Wood Edge	C,M,W w/ Lam Top & Polymer Edge	C,M,W w/ Wood or Lam Top & Wood Edge						
	76RHC4830LDB	1918	1976	2014	2073	47.75	30	29.5		56	8.5
	76RHC4830RDB	1918	1976	2014	2073	47.75	30	29.5		56	8.5
	76RHC5430LDB	1944	2002	2040	2103	53.75	30	29.5		61	9
	76RHC5430RDB	1944	2002	2040	2103	53.75	30	29.5		61	9
	76RHC6030LDB	1965	2024	2063	2126	59.75	30	29.5		65	10
	76RHC6030RDB	1965	2024	2063	2126	59.75	30	29.5		65	10
	76RHC6630RDB	1989	2048	2088	2148	65.75	30	29.5		70	10.75
	76RHC6630LDB*	1989	2048	2088	2148	65.75	30	29.5		70	10.75
	76RHC7230LDB	2055	2113	2154	2215	71.75	30	29.5		79	11.5
	76RHC7230RDB	2055	2113	2154	2215	71.75	30	29.5		79	11.5
	76RHC7830LDB	2117	2180	2221	2287	77.75	30	29.5		84	13
	76RHC7830RDB	2117	2180	2221	2287	77.75	30	29.5		84	13
	76RHC8430LDB	2705	2787	2839	2926	83.75	30	29.5		89	14.5
	76RHC8430RDB	2705	2787	2839	2926	83.75	30	29.5		89	14.5

Description	Model	Rift Oak or	Rift Oak or	C,M,W w/		W	D	H	KW	Shipping Weight	Cubic Feet
		Palette w/ Lam Top & Polymer Edge	Wood or Lam Top & Wood Edge	C,M,W w/ Lam Top & Polymer Edge	C,M,W w/ Wood or Lam Top & Wood Edge						
	76RHDR4830L	1818	1872	1909	1966	47.75	30	29.5	43.75	91	36.5
	76RHDR4830R	1818	1872	1909	1966	47.75	30	29.5	43.75	91	36.5
	76RHDR4836L	1842	1898	1935	1993	47.75	36	29.5	43.75	96	36.5
	76RHDR4836R	1842	1898	1935	1993	47.75	36	29.5	43.75	96	36.5
	76RHDR5430L	1869	1924	1962	2020	53.75	30	29.5	49.75	99	40.5
	76RHDR5430R	1869	1924	1962	2020	53.75	30	29.5	49.75	99	40.5
	76RHDR5436L	1894	1953	1989	2051	53.75	36	29.5	49.75	104	40.5
	76RHDR5436R	1894	1953	1989	2051	53.75	36	29.5	49.75	104	40.5
	76RHDR6030L	1921	1979	2017	2077	59.75	30	29.5	55.75	106	44.5
	76RHDR6030R	1921	1979	2017	2077	59.75	30	29.5	55.75	106	44.5
	76RHDR6036L	1946	2004	2043	2105	59.75	36	29.5	55.75	111	44.5
	76RHDR6036R	1946	2004	2043	2105	59.75	36	29.5	55.75	111	44.5
	76RHDR6630L	1968	2029	2065	2131	65.75	30	29.5	61.75	112	49
	76RHDR6630R	1968	2029	2065	2131	65.75	30	29.5	61.75	112	49
	76RHDR6636L	1995	2056	2092	2158	65.75	36	29.5	61.75	117	50
	76RHDR6636R*	1995	2056	2092	2158	65.75	36	29.5	61.75	117	50
	76RHDR7230L	2020	2083	2121	2185	71.75	30	29.5	67.75	119	53
	76RHDR7230R	2020	2083	2121	2185	71.75	30	29.5	67.75	119	53
	76RHDR7236L	2046	2108	2147	2214	71.75	36	29.5	67.75	124	54.75
	76RHDR7236R	2046	2108	2147	2214	71.75	36	29.5	67.75	124	54.75
	76RHDR7830L	2072	2134	2174	2241	77.75	30	29.5	73.75	126	57
	76RHDR7830R	2072	2134	2174	2241	77.75	30	29.5	73.75	126	57
	76RHDR7836L	2096	2161	2202	2268	77.75	36	29.5	73.75	131	57
	76RHDR7836R	2096	2161	2202	2268	77.75	36	29.5	73.75	131	57
	76RHDR8430L	2121	2185	2228	2295	83.75	30	29.5	79.75	132	61
	76RHDR8430R	2121	2185	2228	2295	83.75	30	29.5	79.75	132	61
	76RHDR8436L	2146	2212	2254	2322	83.75	36	29.5	79.75	137	63
76RHDR8436R	2146	2212	2254	2322	83.75	36	29.5	79.75	137	63	

### ORDERING PROCEDURE

To order, please specify the following:

- 1) Krug product model number
- 2) Wood species and finish, see Page 11
- 3) Wood edge detail- I,H, L or P, see Page 3
- 4) Pull style, see Page 4
- 5) Grommet location if applicable

\*Indicates model illustrated by line drawing.

### CODE DESCRIPTION

L - left hand position  
 R - right hand position  
 DB - disc base support



### STANDARD FINISHES

For a complete list of standard wood finishes please see Page 117.

### GROMMETS

One grommet in standard position is optional at no charge. Additional rectangular grommets are available at an upcharge of **\$152 list.**

ARTEMIS | RETURNS

Description	Model	Rift Oak or	Rift Oak or	C,M,W w/	C,M,W w/	W	D	H	KW	Shipping Cubic	
		Palette w/ Lam Top & Polymer Edge	Palette w/ Wood or Lam Top & Wood Edge	C,M,W w/ Lam Top & Polymer Edge	C,M,W w/ Wood or Lam Top & Wood Edge					Weight	Feet
Rectangular Desk	76RHDR4830LX21	1964	2023	2061	2122	47.75	30	29.5	43.75	106	36.5
Return with 4" Gable	76RHDR4830RX21	1964	2023	2061	2122	47.75	30	29.5	43.75	106	36.5
and 1/2 Height Fixed	76RHDR4836LX21	1990	2053	2089	2154	47.75	36	29.5	43.75	112	36.5
Wood Modesty Panel	76RHDR4836RX21	1990	2053	2089	2154	47.75	36	29.5	43.75	112	36.5
	76RHDR5430LX21	2019	2080	2119	2184	53.75	30	29.5	49.75	114	40.5
	76RHDR5430RX21	2019	2080	2119	2184	53.75	30	29.5	49.75	114	40.5
	76RHDR5436LX21	2046	2108	2147	2214	53.75	36	29.5	49.75	120	40.5
	76RHDR5436RX21	2046	2108	2147	2214	53.75	36	29.5	49.75	120	40.5
	76RHDR6030LX21	2073	2135	2176	2242	59.75	30	29.5	55.75	122	44.5
	76RHDR6030RX21*	2073	2135	2176	2242	59.75	30	29.5	55.75	122	44.5
	76RHDR6036LX21	2100	2164	2206	2272	59.75	36	29.5	55.75	128	44.5
	76RHDR6036RX21	2100	2164	2206	2272	59.75	36	29.5	55.75	128	44.5
	76RHDR6630LX21	2130	2192	2237	2302	65.75	30	29.5	61.75	130	49
	76RHDR6630RX21	2130	2192	2237	2302	65.75	30	29.5	61.75	130	49
	76RHDR6636LX21	2157	2219	2265	2332	65.75	36	29.5	61.75	136	50
	76RHDR6636RX21	2157	2219	2265	2332	65.75	36	29.5	61.75	136	50
	76RHDR7230LX21	2182	2244	2291	2359	71.75	30	29.5	67.75	138	53
	76RHDR7230RX21	2182	2244	2291	2359	71.75	30	29.5	67.75	138	53
	76RHDR7236LX21	2210	2274	2319	2388	71.75	36	29.5	67.75	144	54.75
	76RHDR7236RX21	2210	2274	2319	2388	71.75	36	29.5	67.75	144	54.75
	76RHDR7830LX21	2238	2304	2348	2419	77.75	30	29.5	73.75	148	57
	76RHDR7830RX21	2238	2304	2348	2419	77.75	30	29.5	73.75	148	57
	76RHDR7836LX21	2265	2332	2378	2449	77.75	36	29.5	73.75	152	57
	76RHDR7836RX21	2265	2332	2378	2449	77.75	36	29.5	73.75	152	57
76RHDR8430LX21	2291	2359	2406	2478	83.75	30	29.5	79.75	154	61	
76RHDR8430RX21	2291	2359	2406	2478	83.75	30	29.5	79.75	154	61	
76RHDR8436LX21	2319	2387	2434	2507	83.75	36	29.5	79.75	160	63	
76RHDR8436RX21	2319	2387	2434	2507	83.75	36	29.5	79.75	160	63	
Rectangular Desk	76RHDR4830LV29	1964	2023	2061	2122	47.75	30	29.5	43.75	105	36.5
Return with 4" Gable	76RHDR4830RV29	1964	2023	2061	2122	47.75	30	29.5	43.75	105	36.5
and 1/2 Height Floating	76RHDR4836LV29	1990	2053	2089	2154	47.75	36	29.5	43.75	111	36.5
Acrylic Modesty Panel	76RHDR4836RV29	1990	2053	2089	2154	47.75	36	29.5	43.75	111	36.5
	76RHDR5430LV29	2019	2080	2119	2184	53.75	30	29.5	49.75	113	40.5
	76RHDR5430RV29	2019	2080	2119	2184	53.75	30	29.5	49.75	113	40.5
	76RHDR5436LV29	2046	2108	2147	2214	53.75	36	29.5	49.75	119	40.5
	76RHDR5436RV29	2046	2108	2147	2214	53.75	36	29.5	49.75	119	40.5
	76RHDR6030LV29	2073	2135	2176	2242	59.75	30	29.5	55.75	120	44.5
	76RHDR6030RV29	2073	2135	2176	2242	59.75	30	29.5	55.75	120	44.5
	76RHDR6036LV29	2100	2164	2206	2272	59.75	36	29.5	55.75	126	44.5
	76RHDR6036RV29	2100	2164	2206	2272	59.75	36	29.5	55.75	126	44.5
	76RHDR6630LV29	2130	2192	2237	2302	65.75	30	29.5	61.75	127	49
	76RHDR6630RV29	2130	2192	2237	2302	65.75	30	29.5	61.75	127	49
	76RHDR6636LV29	2157	2219	2265	2332	65.75	36	29.5	61.75	132	50
	76RHDR6636RV29*	2157	2219	2265	2332	65.75	36	29.5	61.75	132	50
	76RHDR7230LV29	2182	2244	2291	2359	71.75	30	29.5	67.75	133	53
	76RHDR7230RV29	2182	2244	2291	2359	71.75	30	29.5	67.75	133	53

**DIMENSION KEY**

W - width  
D - depth  
H - height

**CODE DESCRIPTION**

L - left hand position  
R - right hand position  
X21 - 1/2 height fixed wood modesty panel  
V29 - 1/2 height floating acrylic modesty pane

**STANDARD FINISHES**

For a complete list of standard wood finishes please see Page 117.

# ARTEMIS | RETURNS

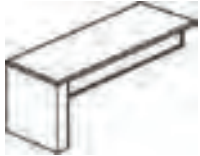
Description	Model	Rift Oak or	Rift Oak or	C,M,W w/	C,M,W w/	W	D	H	KW	Shipping Weight	Cubic Feet
		Palette w/ Lam Top & Polymer Edge	Palette w/ Wood Lam Top & Wood Edge	C,M,W w/ Polymer Edge	C,M,W w/ Wood Lam Top & Wood Edge						
Rectangular Desk	76RHDR7236LV29	2210	2274	2319	2388	71.75	36	29.5	67.75	139	54.75
Return with 4" Gable	76RHDR7236RV29	2210	2274	2319	2388	71.75	36	29.5	67.75	139	54.75
and 1/2 Height Floating	76RHDR7830LV29	2238	2304	2348	2419	77.75	30	29.5	73.75	141	57
Acrylic Modesty Panel	76RHDR7830RV29	2238	2304	2348	2419	77.75	30	29.5	73.75	141	57
cont.	76RHDR7836LV29	2265	2332	2378	2449	77.75	36	29.5	73.75	139	57
	76RHDR7836RV29	2265	2332	2378	2449	77.75	36	29.5	73.75	139	57
	76RHDR8430LV29	2291	2359	2406	2478	83.75	30	29.5	79.75	146	61
	76RHDR8430RV29	2291	2359	2406	2478	83.75	30	29.5	79.75	146	61
	76RHDR8436LV29	2319	2387	2434	2507	83.75	36	29.5	79.75	152	63
	76RHDR8436RV29	2319	2387	2434	2507	83.75	36	29.5	79.75	152	63

Rectangular Desk	76RHDR4830LM	1495	1538	1567	1612	47.75	30	29.5	43.75	58	8
Return with 2" Square	76RHDR4830RM	1495	1538	1567	1612	47.75	30	29.5	43.75	58	8
Metal Leg and no	76RHDR4836LM	1515	1562	1590	1640	47.75	36	29.5	43.75	66	10
Modesty Panel	76RHDR4836RM	1515	1562	1590	1640	47.75	36	29.5	43.75	66	10
	76RHDR5430LM	1537	1585	1615	1663	53.75	30	29.5	49.75	63	8.5
	76RHDR5430RM	1537	1585	1615	1663	53.75	30	29.5	49.75	63	8.5
	76RHDR5436LM	1558	1606	1638	1685	53.75	36	29.5	49.75	71	10.75
	76RHDR5436RM	1558	1606	1638	1685	53.75	36	29.5	49.75	71	10.75
	76RHDR6030LM	1579	1624	1659	1705	59.75	30	29.5	55.75	72	9
	76RHDR6030RM	1579	1624	1659	1705	59.75	30	29.5	55.75	72	9
	76RHDR6036LM	1598	1646	1678	1730	59.75	36	29.5	55.75	81	11.5
	76RHDR6036RM	1598	1646	1678	1730	59.75	36	29.5	55.75	81	11.5
	76RHDR6630LM	1619	1668	1702	1751	65.75	30	29.5	61.75	76	10
	76RHDR6630RM	1619	1668	1702	1751	65.75	30	29.5	61.75	76	10
	76RHDR6636LM	1601	1647	1683	1730	65.75	36	29.5	61.75	93	12.5
	76RHDR6636RM	1601	1647	1683	1730	65.75	36	29.5	61.75	93	12.5
	76RHDR7230LM*	1662	1712	1745	1796	71.75	30	29.5	67.75	81	10.75
	76RHDR7230RM	1662	1712	1745	1796	71.75	30	29.5	67.75	81	10.75
	76RHDR7236LM	1680	1731	1767	1818	71.75	36	29.5	67.75	100	13.5
	76RHDR7236RM	1680	1731	1767	1818	71.75	36	29.5	67.75	100	13.5
	76RHDR7830LM	1703	1753	1788	1841	77.75	30	29.5	73.75	86	11.5
	76RHDR7830RM	1703	1753	1788	1841	77.75	30	29.5	73.75	86	11.5
	76RHDR7836LM	1724	1776	1810	1863	77.75	36	29.5	73.75	106	14
	76RHDR7836RM	1724	1776	1810	1863	77.75	36	29.5	73.75	106	14
	76RHDR8430LM	1745	1797	1833	1885	83.75	30	29.5	79.75	91	13
	76RHDR8430RM	1745	1797	1833	1885	83.75	30	29.5	79.75	91	13
	76RHDR8436LM	1767	1818	1855	1911	83.75	36	29.5	79.75	113	15
	76RHDR8436RM	1767	1818	1855	1911	83.75	36	29.5	79.75	113	15

### ORDERING PROCEDURE

To order, please specify the following:

- 1) Krug product model number
- 2) Wood species and finish, see Page 11
- 3) Wood edge detail- I,H, L or P, see Page 3
- 4) Pull style, see Page 4
- 5) Grommet location if applicable

\*Indicates model illustrated by line drawing.

### CODE DESCRIPTION

L - left hand pedestal position  
 R - right hand pedestal position  
 V29 - 1/2 height floating acrylic modesty panel  
 M - twin metal legs

### STANDARD FINISHES

For a complete list of standard wood finishes please see Page 117.

### GROMMETS

One grommet in standard position is optional at no charge. Additional rectangular grommets are available at an upcharge of **\$152 list.**

ARTEMIS | RETURNS

Description	Model	Rift Oak or	Rift Oak or	C,M,W w/		W	D	H	KW	Shipping Cubic	
		Palette w/ Lam Top & Polymer Edge	Palette w/ Wood or Lam Top & Wood Edge	C,M,W w/ Lam Top & Polymer Edge	C,M,W w/ Wood or Lam Top & Wood Edge					Weight	Feet
Rectangular Desk	76RHDR4830LV29M	1617	1666	1698	1747	47.75	30	29.5	43.75	63	8
Return with 2" square	76RHDR4830RV29M	1617	1666	1698	1747	47.75	30	29.5	43.75	63	8
Metal Leg and 1/2	76RHDR4836LV29M	1639	1689	1719	1772	47.75	36	29.5	43.75	70	10
Height Floating Acrylic	76RHDR4836RV29M	1639	1689	1719	1772	47.75	36	29.5	43.75	70	10
Modesty Panel	76RHDR5430LV29M	1662	1712	1745	1796	53.75	30	29.5	49.75	68	8.5
	76RHDR5430RV29M	1662	1712	1745	1796	53.75	30	29.5	49.75	68	8.5
	76RHDR5436LV29M	1683	1734	1768	1819	53.75	36	29.5	49.75	76	10.75
	76RHDR5436RV29M*	1683	1734	1768	1819	53.75	36	29.5	49.75	76	10.75
	76RHDR6030LV29M	1705	1756	1791	1844	59.75	30	29.5	55.75	78	9
	76RHDR6030RV29M	1705	1756	1791	1844	59.75	30	29.5	55.75	78	9
	76RHDR6036LV29M	1728	1778	1813	1867	59.75	36	29.5	55.75	87	11.5
	76RHDR6036RV29M	1728	1778	1813	1867	59.75	36	29.5	55.75	87	11.5
	76RHDR6630LV29M	1748	1802	1836	1892	65.75	30	29.5	61.75	83	10
	76RHDR6630RV29M	1748	1802	1836	1892	65.75	30	29.5	61.75	83	10
	76RHDR6636LV29M	1729	1779	1815	1870	65.75	36	29.5	61.75	108	13
	76RHDR6636RV29M	1729	1779	1815	1870	65.75	36	29.5	61.75	108	13
	76RHDR7230LV29M	1795	1849	1884	1941	71.75	30	29.5	67.75	89	10.75
	76RHDR7230RV29M	1795	1849	1884	1941	71.75	30	29.5	67.75	89	10.75
	76RHDR7236LV29M	1815	1869	1906	1962	71.75	36	29.5	67.75	115	14
	76RHDR7236RV29M	1815	1869	1906	1962	71.75	36	29.5	67.75	115	14
	76RHDR7830LV29M	1837	1893	1928	1987	77.75	30	29.5	73.75	94	11.5
	76RHDR7830RV29M	1837	1893	1928	1987	77.75	30	29.5	73.75	94	11.5
	76RHDR7836LV29M	1862	1920	1956	2016	77.75	36	29.5	73.75	115	15
	76RHDR7836RV29M	1862	1920	1956	2016	77.75	36	29.5	73.75	115	15
	76RHDR8430LV29M	1884	1942	1980	2037	83.75	30	29.5	79.75	100	13
	76RHDR8430RV29M	1884	1942	1980	2037	83.75	30	29.5	79.75	100	13
	76RHDR8436LV29M	1908	1965	2002	2062	83.75	36	29.5	79.75	128	16
	76RHDR8436RV29M	1908	1965	2002	2062	83.75	36	29.5	79.75	128	16
Rectangular Desk	76RHDR4830LP1	1495	1538	1567	1612	47.75	30	29.5	43.75	56	8.5
Return with Panel Leg	76RHDR4830RP1	1495	1538	1567	1612	47.75	30	29.5	43.75	56	8.5
and no Modesty Panel	76RHDR4836LP1	1515	1562	1590	1640	47.75	36	29.5	43.75	64	12
	76RHDR4836RP1	1515	1562	1590	1640	47.75	36	29.5	43.75	64	12
	76RHDR5430LP1	1537	1585	1615	1663	53.75	30	29.5	49.75	61	9
	76RHDR5430RP1	1537	1585	1615	1663	53.75	30	29.5	49.75	61	9
	76RHDR5436LP1	1558	1606	1638	1685	53.75	36	29.5	49.75	69	13
	76RHDR5436RP1	1558	1606	1638	1685	53.75	36	29.5	49.75	69	13
	76RHDR6030LP1	1579	1624	1659	1705	59.75	30	29.5	55.75	65	10
	76RHDR6030RP1	1579	1624	1659	1705	59.75	30	29.5	55.75	65	10
	76RHDR6036LP1	1598	1646	1678	1730	59.75	36	29.5	55.75	75	13.75
	76RHDR6036RP1	1598	1646	1678	1730	59.75	36	29.5	55.75	75	13.75
	76RHDR6630LP1	1619	1668	1702	1751	65.75	30	29.5	61.75	70	10.75
	76RHDR6630RP1	1619	1668	1702	1751	65.75	30	29.5	61.75	70	10.75
	76RHDR6636LP1*	1640	1689	1719	1771	65.75	36	29.5	61.75	93	14
	76RHDR6636RP1	1640	1689	1719	1771	65.75	36	29.5	61.75	93	14
	76RHDR7230LP1	1662	1712	1745	1796	71.75	30	29.5	67.75	79	11.5
	76RHDR7230RP1	1662	1712	1745	1796	71.75	30	29.5	67.75	79	11.5
	76RHDR7236LP1	1680	1731	1767	1818	71.75	36	29.5	67.75	100	15
	76RHDR7236RP1	1680	1731	1767	1818	71.75	36	29.5	67.75	100	15
	76RHDR7830LP1	1703	1753	1788	1841	77.75	30	29.5	73.75	84	13
	76RHDR7830RP1	1703	1753	1788	1841	77.75	30	29.5	73.75	84	13

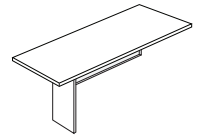

**DIMENSION KEY**

W - width  
D - depth  
H - height

**CODE DESCRIPTION**

L - left hand pedestal position  
R - right hand pedestal position  
V29 - 1/2 height floating acrylic modesty panel  
M - twin metal legs  
P1 - panel leg

**STANDARD FINISHES**

For a complete list of standard wood finishes please see Page 117.



# ARTEMIS | RETURNS

Description	Model	Rift Oak or	Rift Oak or	C,M,W w/	C,M,W w/	W	D	H	KW	Shipping Cubic	
		Palette w/ Lam Top & Polymer Edge	Palette w/ Wood or Lam Top & Wood Edge	Lam Top & Polymer Edge	Lam Top & Wood Edge					Weight	Feet
Rectangular Desk	76RHDR7836LP1	1724	1776	1810	1863	77.75	36	29.5	73.75	106	16
Return with Panel Leg	76RHDR7836RP1	1745	1776	1810	1863	77.75	36	29.5	73.75	106	16
and no Modesty Panel	76RHDR8430LP1	1745	1797	1833	1885	83.75	30	29.5	79.75	89	14.5
cont.	76RHDR8430RP1	1767	1797	1833	1885	83.75	30	29.5	79.75	89	14.5
	76RHDR8436LP1	1767	1818	1855	1911	83.75	36	29.5	79.75	113	17
	76RHDR8436RP1	1767	1818	1855	1911	83.75	36	29.5	79.75	113	17

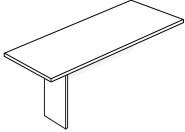

Rectangular Desk	76RHDR4830LV29P1	1617	1666	1698	1747	47.75	30	29.5	43.75	59	8.5
Return with Panel Leg	76RHDR4830RV29P1	1617	1666	1698	1747	47.75	30	29.5	43.75	59	8.5
and 1/2 Height Floating	76RHDR4836LV29P1	1639	1689	1719	1772	47.75	36	29.5	43.75	67	12
Wood Modesty Panel	76RHDR4836RV29P1	1639	1689	1719	1772	47.75	36	29.5	43.75	67	12
	76RHDR5430LV29P1	1662	1712	1745	1796	53.75	30	29.5	49.75	65	9
	76RHDR5430RV29P1	1662	1712	1745	1796	53.75	30	29.5	49.75	65	9
	76RHDR5436LV29P1	1683	1734	1768	1819	53.75	36	29.5	49.75	73	13
	76RHDR5436RV29P1	1683	1734	1768	1819	53.75	36	29.5	49.75	73	13
	76RHDR6030LV29P1	1705	1756	1791	1844	59.75	30	29.5	55.75	70	10
	76RHDR6030RV29P1	1705	1756	1791	1844	59.75	30	29.5	55.75	70	10
	76RHDR6036LV29P1	1728	1778	1813	1867	59.75	36	29.5	55.75	80	13.75
	76RHDR6036RV29P1	1728	1778	1813	1867	59.75	36	29.5	55.75	80	13.75
	76RHDR6630LV29P1	1748	1802	1836	1892	65.75	30	29.5	61.75	76	10.75
	76RHDR6630RV29P1	1748	1802	1836	1892	65.75	30	29.5	61.75	76	10.75
	76RHDR6636LV29P1*	1729	1779	1815	1870	65.75	36	29.5	61.75	108	14.5
	76RHDR6636RV29P1	1729	1779	1815	1870	65.75	36	29.5	61.75	108	14.5
	76RHDR7230LV29P1	1795	1849	1884	1941	71.75	30	29.5	67.75	86	11.5
	76RHDR7230RV29P1	1795	1849	1884	1941	71.75	30	29.5	67.75	86	11.5
	76RHDR7236LV29P1	1815	1869	1906	1962	71.75	36	29.5	67.75	115	15.75
	76RHDR7236RV29P1	1815	1869	1906	1962	71.75	36	29.5	67.75	115	15.75
	76RHDR7830LV29P1	1837	1893	1928	1987	77.75	30	29.5	73.75	91	13
	76RHDR7830RV29P1	1837	1893	1928	1987	77.75	30	29.5	73.75	91	13
	76RHDR7836LV29P1	1862	1920	1956	2016	77.75	36	29.5	73.75	121	16.75
	76RHDR7836RV29P1	1862	1920	1956	2016	77.75	36	29.5	73.75	121	16.75
	76RHDR8430LV29P1	1884	1942	1980	2037	83.75	30	29.5	79.75	96	14.5
	76RHDR8430RV29P1	1884	1942	1980	2037	83.75	30	29.5	79.75	96	14.5
	76RHDR8436LV29P1	1908	1965	2002	2062	83.75	36	29.5	79.75	128	17.75
	76RHDR8436RV29P1	1908	1965	2002	2062	83.75	36	29.5	79.75	128	17.75

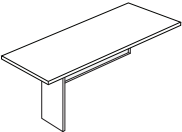

### ORDERING PROCEDURE

To order, please specify the following:

- 1) Krug product model number
- 2) Wood species and finish, see Page 11
- 3) Wood edge detail- I,H, L or P, see Page 3
- 4) Pull style, see Page 4
- 5) Grommet location if applicable

### CODE DESCRIPTION

L - left hand pedestal position  
 R - right hand pedestal position  
 P1 - panel leg  
 V29 - 1/2 height floating acrylic modesty panel



### STANDARD FINISHES

For a complete list of standard wood finishes please see Page 117.

### GROMMETS

One grommet in standard position is optional at no charge. Additional rectangular grommets are available at an upcharge of **\$152 list.**

ARTEMIS | RETURNS

Description	Model	Rift Oak or	Rift Oak or	C,M,W w/	C,M,W w/	W	D	H	KW	Shipping Weight	Cubic Feet
		Palette w/ Lam Top & Polymer Edge	Wood or Lam Top & Wood Edge	Wood or Lam Top & Polymer Edge	Wood or Lam Top & Wood Edge						
Rectangular Desk	76RHDR4830LDB	1709	1761	1796	1849	47.75	30	29.5	30.75	56	8.5
Return with Disc Base	76RHDR4830RDB	1709	1761	1796	1849	47.75	30	9.5	30.75	56	8.5
and no Modesty Panel	76RHDR4836LDB	1730	1780	1816	1870	47.75	36	29.5	27.75	64	12
	76RHDR4836RDB	1730	1780	1816	1870	47.75	36	29.5	27.75	64	12
	76RHDR5430LDB	1751	1804	1839	1894	53.75	30	29.5	36.75	61	9
	76RHDR5430RDB	1751	1804	1839	1894	53.75	30	29.5	36.75	61	9
	76RHDR5436LDB	1772	1823	1860	1915	53.75	36	29.5	33.75	69	13
	76RHDR5436RDB	1772	1823	1860	1915	53.75	36	29.5	33.75	69	13
	76RHDR6030LDB	1791	1844	1881	1938	59.75	30	29.5	42.75	65	10
	76RHDR6030RDB	1791	1844	1881	1938	59.75	30	29.5	42.75	65	10
	76RHDR6036LDB	1813	1867	1905	1960	59.75	36	29.5	39.75	75	13.75
	76RHDR6036RDB	1813	1867	1905	1960	59.75	36	29.5	39.75	75	13.75
	76RHDR6630LDB	1834	1886	1924	1982	65.75	30	29.5	48.75	70	10.75
	76RHDR6630RDB*	1834	1886	1924	1982	65.75	30	29.5	48.75	70	10.75
	76RHDR6636LDB	1815	1869	1906	1962	65.75	36	29.5	45.75	93	14
	76RHDR6636RDB	1815	1869	1906	1962	65.75	36	29.5	45.75	93	14
	76RHDR7230LDB	1875	1929	1967	2029	71.75	30	29.5	54.75	79	11.5
	76RHDR7230RDB	1875	1929	1967	2029	71.75	30	29.5	54.75	79	11.5
	76RHDR7236LDB	1894	1953	1989	2051	71.75	36	29.5	41.75	100	15
	76RHDR7236RDB	1894	1953	1989	2051	71.75	36	29.5	51.75	100	15
	76RHDR7830LDB	1915	1974	2012	2072	77.75	30	29.5	58.75	84	13
	76RHDR7830RDB	1915	1974	2012	2072	77.75	30	29.5	58.75	84	13
	76RHDR7836LDB	1938	1997	2034	2094	77.75	36	29.5	55.75	106	16
	76RHDR7836RDB	1938	1997	2034	2094	77.75	36	29.5	55.75	106	16
	76RHDR8430LDB	1957	2017	2056	2117	83.75	30	29.5	66.75	89	14.5
	76RHDR8430RDB	1957	2017	2056	2117	83.75	30	29.5	66.75	89	14.5
	76RHDR8436LDB	1980	2037	2079	2139	83.75	36	29.5	63.75	113	17
	76RHDR8436RDB	1980	2037	2079	2139	83.75	36	29.5	63.75	113	17
Rectangular Desk	76RHDR4830LV21DB	1832	1884	1922	1980	47.75	30	29.5	30.75	56	8.5
Return with Disc Base	76RHDR4830RV21DB	1832	1884	1922	1980	47.75	30	29.5	30.75	56	8.5
and 1/2 Height	76RHDR4836LV21DB	1853	1908	1945	2002	47.75	36	29.5	27.75	64	12
Floating Wood	76RHDR4836RV21DB	1853	1908	1945	2002	47.75	36	29.5	27.75	64	12
Modesty Panel	76RHDR5430LV21DB	1875	1929	1967	2029	53.75	30	29.5	36.75	61	9
	76RHDR5430RV21DB	1875	1929	1967	2029	53.75	30	29.5	36.75	61	9
	76RHDR5436LV21DB*	1896	1954	1990	2053	53.75	36	29.5	33.75	69	13
	76RHDR5436RV21DB	1896	1954	1990	2053	53.75	36	29.5	33.75	69	13
	76RHDR6030LV21DB	1920	1977	2016	2076	59.75	30	29.5	42.75	65	10
	76RHDR6030RV21DB	1920	1977	2016	2076	59.75	30	29.5	42.75	65	10
	76RHDR6036LV21DB	1941	1999	2037	2098	59.75	36	29.5	39.75	75	13.75
	76RHDR6036RV21DB	1941	1999	2037	2098	59.75	36	29.5	39.75	75	13.75
	76RHDR6630LV21DB	1989	2051	2088	2149	65.75	30	29.5	48.75	70	10.75
	76RHDR6630RV21DB	1989	2051	2088	2149	65.75	30	29.5	48.75	70	10.75
	76RHDR6636LV21DB	2034	2096	2136	2201	65.75	36	29.5	45.75	93	14
	76RHDR6636RV21DB	2034	2096	2136	2201	65.75	36	29.5	45.75	93	14
	76RHDR7230LV21DB	2070	2133	2173	2240	71.75	30	29.5	54.75	79	11.5
	76RHDR7230RV21DB	2070	2133	2173	2240	71.75	30	29.5	54.75	79	11.5

**DIMENSION KEY**

W - width  
D - depth  
H - height

**CODE DESCRIPTION**

L - left hand pedestal position  
R - right hand pedestal position  
V21 - 1/2 height floating wood modesty panel  
DB - disc base support

**STANDARD FINISHES**

For a complete list of standard wood finishes please see Page 117.

# ARTEMIS | RETURNS & LINKING UNITS

Description	Model	Rift Oak or	Rift Oak or	C,M,W w/		W	D	H	KW	Shipping Weight	Cubic Feet
		Palette w/ Lam Top & Polymer Edge	Palette w/ Wood Lam Top & Wood Edge	C,M,W w/ Lam Top & Polymer Edge	C,M,W w/ Wood Lam Top & Wood Edge						
Rectangular Desk	76RHDR7236LV21DB	2091	2157	2196	2264	71.75	36	29.5	51.75	100	15
Return with Disc Base	76RHDR7236RV21DB	2091	2157	2196	2264	71.75	36	29.5	51.75	100	15
and 1/2 Height	76RHDR7830LV21DB	2144	2210	2252	2319	77.75	30	29.5	58.75	84	13
Floating Wood	76RHDR7830RV21DB	2144	2210	2252	2319	77.75	30	29.5	58.75	84	13
Modesty Panel cont.	76RHDR7836LV21DB	2614	2695	2745	2829	77.75	36	29.5	55.75	106	16
	76RHDR7836RV21DB	2614	2695	2745	2829	77.75	36	29.5	55.75	106	16
	76RHDR8430LV21DB	2916	3003	3061	3155	83.75	30	29.5	66.75	89	14.5
	76RHDR8430RV21DB	2916	3003	3061	3155	83.75	30	29.5	66.75	89	14.5
	76RHDR8436LV21DB	3428	3532	3599	3708	83.75	36	29.5	63.75	113	17
	76RHDR8436RV21DB	3428	3532	3599	3708	83.75	36	29.5	63.75	113	17



Description	Model	530	543	556	570	30	24	29.5		Shipping Weight	Cubic Feet
Linking Top	76LU3024H	530	543	556	570	30	24	29.5		19.5	2
	76LU3620H	583	599	611	628	36	20	29.5		15	1.5
	76LU3624H	592	613	622	642	36	24	29.5		16	1.75
	76LU4220H	611	628	641	661	42	20	29.5		20	1.5
	76LU4224H	628	648	661	679	42	24	29.5		24	2
	76LU4820H	637	658	669	689	48	20	29.5		29	1.75
	76LU4824H	655	674	688	707	48	24	29.5		36	2
	76LU5424H	777	799	812	838	54	24	29.5		35	3.5
	76LU6024H*	821	845	861	887	59.75	24	29.5		38.5	3.75
	76LU6624H	868	892	910	937	65.75	24	29.5		42.5	4
	76LU7224H	935	962	983	1014	71.75	24	29.5		46.5	4.5



Description	Model	1027	1058	1080	1109	30	24	29.5		Shipping Weight	Cubic Feet
Linking Unit with Fixed Wood Modesty Panel	76LU3024HX41	1027	1058	1080	1109	30	24	29.5		46	3
	76LU3620HX41	1162	1195	1218	1254	36	20	29.5		59	3
	76LU3624HX41	1213	1249	1273	1312	36	24	29.5		64	3
	76LU4220HX41	1252	1289	1315	1355	42	20	29.5		67	3.75
	76LU4224HX41	1273	1312	1336	1377	42	24	29.5		72	3.75
	76LU4820HX41	1307	1346	1373	1414	48	20	29.5		78	4
	76LU4824HX41	1389	1430	1458	1503	48	24	29.5		80	4
	76LU5424HX41	1468	1514	1543	1590	54	24	29.5		81	4.75
	76LU6024HX41*	1555	1598	1632	1678	59.75	24	29.5		89	5
	76LU6624HX41	1636	1685	1716	1769	65.75	24	29.5		97	5.5
	76LU7224HX41	1715	1768	1802	1855	71.75	20	29.5		105.5	6



Description	Model	1265	1303	1328	1369	30	24	29.5		Shipping Weight	Cubic Feet
Linking Unit with Hinged Wood Modesty Panel	76LUY3024H	1265	1303	1328	1369	30	24	29.5		35.5	3
	76LUY3620H	1279	1316	1341	1381	36	20	29.5		59	3
	76LUY3624H	1338	1378	1404	1447	36	24	29.5		64	3
	76LUY4220H	1384	1425	1453	1497	42	20	29.5		67	3.5
	76LUY4224H	1403	1445	1474	1518	42	24	29.5		72	3.5
	76LUY4820H	1443	1485	1514	1560	48	20	29.5		78	4
	76LUY4824H	1458	1501	1529	1578	48	24	29.5		80	4
	76LUY5424H	1522	1559	1585	1624	54	24	29.5		76.5	4.75
	76LUY6020H*	1538	1585	1615	1664	59.75	20	29.5		83	5

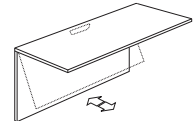

## ORDERING PROCEDURE

To order, please specify the following:

- 1) Krug product model number
- 2) Wood species and finish, see Page 11
- 3) Wood edge detail- I,H, L or P, see Page 3
- 4) Pull style, see Page 4
- 5) Grommet location if applicable

## CODE DESCRIPTION

- L - left hand pedestal position
- R - right hand pedestal position
- V21 - 1/2 height floating wood modesty panel
- DB - disc base support
- X41 - full height fixed wood modesty pane

## STANDARD FINISHES

For a complete list of standard wood finishes please see Page 117.

## GROMMETS

One grommet in standard position is optional at no charge. Additional rectangular grommets are available at an upcharge of **\$152 list.**

# ARTEMIS | LINKING UNITS & CORNER UNITS

Description	Model	Rift Oak or	Rift Oak or	C,M,W w/	C,M,W w/	W	D	H	KW	Shipping Weight	Cubic Feet
		Palette w/ Lam Top & Polymer Edge	Palette w/ Wood Lam Top & Wood Edge	C,M,W w/ Lam Top & Polymer Edge	C,M,W w/ Wood Lam Top & Wood Edge						
Linking Units for Table Desks, Wood Modesty Panel 	76LUTD4220HLX41	1162	1195	1220	1254	42	20	29.5		67	20
	76LUTD4220HRX41	1162	1195	1220	1254	42	24	29.5		67	20
	76LUTD4224HLX41	1179	1213	1239	1275	42	24	29.5		71	23
	76LUTD4224HRX41	1179	1213	1239	1275	42	20	29.5		71	23
	76LUTD4820HLX41	1210	1245	1271	1309	48	20	29.5		78	22.5
	76LUTD4820HRX41	1210	1245	1271	1309	48	24	29.5		78	22.5
	76LUTD4824HLX41*	1228	1263	1288	1328	48	24	29.5		79	26
	76LUTD4824HRX41	1228	1263	1288	1328	48	24	29.5		79	26

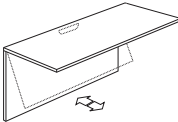
Linking Units for Table Desks, Hinged Modesty Panel 	76LUYTD4224HL	1285	1319	1346	1384	42	24	29.5		72	23
	76LUYTD4224HR	1285	1319	1346	1384	42	24	29.5		72	23
	76LUYTD4824HL*	1298	1349	1384	1438	48	24	29.5		80	26
	76LUYTD4824HR	1298	1349	1384	1438	48	24	29.5		80	26

Corner Unit 	76CU363620	2312	2382	2429	2500	36	36	29.5	22.5	106	29
	76CU363624	2312	2382	2429	2500	36	36	29.5	17	106	29
	76CU424220	2538	2614	2663	2743	42	42	29.5	31	131	38
	76CU424224*	2538	2614	2663	2743	42	42	29.5	25.25	131	38

**DIMENSION KEY**

W - width  
 D - depth  
 H - height

**CODE DESCRIPTION**

L - left hand pedestal position  
 R - right hand pedestal position  
 X41 - full height wood modesty panel  
 Y - hinged modesty panel

**STANDARD FINISHES**

For a complete list of standard wood finishes please see Page 117.

# ARTEMIS | CREDENZAS

Description	Model	Rift Oak or	Rift Oak or	C,M,W w/						Shipping Weight	Cubic Feet
		Palette w/ Lam Top & Polymer Edge	Wood or Lam Top & Wood Edge	C,M,W w/ Lam Top & Polymer Edge	Wood or Lam Top & Wood Edge	W	D	H	KW		
Credenza Shell without modesty panel 	76SC5424	1765	1817	1853	1908	54	24	29.5	51.5	88	29
	76SC6024	1896	1954	1990	2053	59.75	24	29.5	57.5	109	27.75
	76SC6624	2031	2090	2132	2196	65.75	24	29.5	63.5	104	35
	76SC7224	2172	2238	2281	2352	71.75	24	29.5	69.5	112	38
	76SC7824*	2299	2368	2413	2486	77.75	24	29.5	75.5	120	40
	76SC8424	2430	2502	2552	2629	83.75	24	29.5	81.5	128	44
	76SC9624	2776	2859	2916	3003	95.75	24	29.5	93.5	88	29

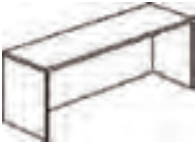
Credenza Shell with Fixed Modesty Panel 	76SC3624X41	1474	1519	1547	1593	36	24	29.5	39.5	84	20
	76SC4224X41	1596	1643	1676	1727	42	24	29.5	39.5	94	23
	76SC4824X41	1732	1786	1819	1875	48	24	29.5	45.5	106	26
	76SC5424X41	1869	1924	1962	2020	54	24	29.5	51.5	117	29
	76SC6024X41	2018	2079	2118	2182	59.75	24	29.5	57.5	116	27.75
	76SC6624X41	2155	2218	2264	2370	65.75	24	29.5	63.5	104	35
	76SC7224X41	2302	2370	2418	2489	71.75	24	29.5	69.5	112	38
	76SC7824X41*	2437	2511	2560	2637	77.75	24	29.5	75.5	120	40
	76SC8424X41	2576	2654	2705	2785	83.75	24	29.5	81.5	128	44
76SC9624X41	2943	3031	3090		95.75	24	29.5	93.5	84	20	

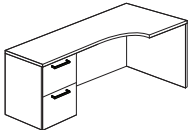
Curved Corner Credenza Single Pedestal and Wood Modesty Panel 	76UC722448L24RDX41	3817	3932	4007	4129	71.75	48	29.5	32	249	71
	76UC722448R24LDX41*	3817	3932	4007	4129	71.75	48	29.5	32	249	71
	76UC722448L24RFX41	3817	3932	4007	4129	71.75	48	29.5	32	249	71
	76UC722448R24LFX41	3817	3932	4007	4129	71.75	48	29.5	32	249	71
	76UC782448L24RDX41	3914	4030	4108	4234	77.75	48	29.5	38	260	76.75
	76UC782448R24LDX41	3914	4030	4108	4234	77.75	48	29.5	38	260	76.75
	76UC782448L24RFX41	3914	4030	4108	4234	77.75	48	29.5	38	260	76.75
	76UC782448R24LFX41	3914	4030	4108	4234	77.75	48	29.5	38	260	76.75
	76UC842448L24RDX41	4007	4129	4208	4335	83.75	48	29.5	44	271	82
	76UC842448R24LDX41	4007	4129	4208	4335	83.75	48	29.5	44	271	82
	76UC842448L24RFX41	4007	4129	4208	4335	83.75	48	29.5	44	271	82
	76UC842448R24LFX41	4007	4129	4208	4335	83.75	48	29.5	44	271	82

**ORDERING NOTES:**

For U-shaped configuration see page xx, Curved Corner Desks.

**ORDERING PROCEDURE**

To order, please specify the following:

- 1) Krug product model number
- 2) Wood species and finish, see Page 11
- 3) Wood edge detail- I,H, L or P, see Page 3
- 4) Pull style, see Page 4
- 5) Grommet location if applicable

**CODE DESCRIPTION**

- L - left hand pedestal position
- R - right hand pedestal position
- D - 2 file drawers
- F - 2 box, 1 file drawer
- X41 - full height wood modesty panel

**STANDARD FINISHES**

For a complete list of standard wood finishes please see Page 117.

**GROMMETS**

One grommet in standard position is optional at no charge. Additional rectangular grommets are available at an upcharge of **\$152 list.**

**ARTEMIS | CREDENZAS**

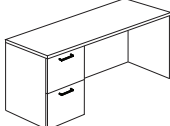
Description	Model	Rift Oak or	Rift Oak or	C,M,W w/		W	D	H	KW	Shipping Weight	Cubic Feet
		Palette w/ Lam Top & Polymer Edge	Wood or Lam Top & Wood Edge	C,M,W w/ Lam Top & Polymer Edge	Wood or Lam Top & Wood Edge						
Single Pedestal Credenza with Fixed modesty panel  	76C60204XLDR0	3217	3314	3379	3481	59.75	20	29.5	43	120	27.75
	76C60204XLFR0	3217	3314	3379	3481	59.75	20	29.5	43	120	27.75
	76C60204XL0RD	3217	3314	3379	3481	59.75	20	29.5	43	120	27.75
	76C60204XL0RF	3217	3314	3379	3481	59.75	20	29.5	43	120	27.75
	76C60244XLDR0	3242	3340	3404	3507	59.75	24	29.5	43	128	32
	76C60244XLFR0	3242	3340	3404	3507	59.75	24	29.5	43	128	32
	76C60244XL0RD	3242	3340	3404	3507	59.75	24	29.5	43	128	32
	76C60244XL0RF	3242	3340	3404	3507	59.75	24	29.5	43	128	32
	76C66204XLDR0*	3268	3364	3431	3535	65.75	20	29.5	49	136	30
	76C66204XLFR0	3268	3364	3431	3535	65.75	20	29.5	49	36	30
	76C66204XL0RD	3268	3364	3431	3535	65.75	20	29.5	49	136	30
	76C66204XL0RF	3268	3364	3431	3535	65.75	20	29.5	49	136	30
	76C66244XLDR0	3283	3379	3446	3552	65.75	24	29.5	49	144	35
	76C66244XLFR0	3283	3379	3446	3552	65.75	24	29.5	49	144	35
	76C66244XL0RD	3283	3379	3446	3552	65.75	24	29.5	49	144	35
	76C66244XL0RF	3283	3379	3446	3552	65.75	24	29.5	49	144	35
	76C72204XLDR0*	3294	3395	3458	3563	71.75	20	29.5	55	152	32.75
	76C72204XLFR0	3294	3395	3458	3563	71.75	20	29.5	55	152	32.75
	76C72204XL0RD	3294	3395	3458	3563	71.75	20	29.5	55	152	32.75
	76C72204XL0RF	3294	3395	3458	3563	71.75	20	29.5	55	152	32.75
	76C72244XLDR0	3323	3424	3490	3595	71.75	24	29.5	55	160	38
	76C72244XLFR0	3323	3424	3490	3595	71.75	24	29.5	55	160	38
	76C72244XL0RD	3323	3424	3490	3595	71.75	24	29.5	55	160	38
	76C72244XL0RF	3323	3424	3490	3595	71.75	24	29.5	55	160	38
	76C78204XLDR0	3333	3432	3497	3605	77.75	20	29.5	61	168	35.5
	76C78204XLFR0	3333	3432	3497	3605	77.75	20	29.5	61	168	35.5
	76C78204XL0RD	3333	3432	3497	3605	77.75	20	29.5	61	168	35.5
	76C78204XL0RF	3333	3432	3497	3605	77.75	20	29.5	61	168	35.5
	76C78244XLDR0	3342	3441	3505	3613	77.75	24	29.5	61	172	41
	76C78244XLFR0	3342	3441	3505	3613	77.75	24	29.5	61	172	41
76C78244XL0RD	3342	3441	3505	3613	77.75	24	29.5	61	172	41	
76C78244XL0RF	3342	3441	3505	3613	77.75	24	29.5	61	172	41	
76C84204XLDR0	3345	3446	3509	3618	83.75	20	29.5	67	184	38	
76C84204XLFR0	3345	3446	3509	3618	83.75	20	29.5	67	184	38	
76C84204XL0RD	3345	3446	3509	3618	83.75	20	29.5	67	184	38	
76C84204XL0RF	3345	3446	3509	3618	83.75	20	29.5	67	184	38	
76C84244XLDR0	3354	3455	3517	3628	83.75	24	29.5	67	192	44	
76C84244XLFR0	3354	3455	3517	3628	83.75	24	29.5	67	192	44	
76C84244XL0RD	3354	3455	3517	3628	83.75	24	29.5	67	192	44	
76C84244XL0RF	3354	3455	3517	3628	83.75	24	29.5	67	192	44	

**DIMENSION KEY**

W - width  
D - depth  
H - height

**CODE DESCRIPTION**

X - full height fixed modesty panel  
L - left handed pedestal  
R - right handed pedestal  
D - 2 file drawers  
F - 2 box, 1 file drawer  
0 - no pedestal

**STANDARD FINISHES**

For a complete list of standard wood finishes please see Page 117.

# ARTEMIS | CREDENZAS

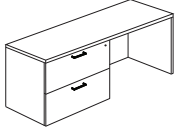
Description	Model	Rift Oak or	Rift Oak or	C,M,W w/		W	D	H	KW	Shipping Weight	Cubic Feet
		Palette w/ Lam Top & Polymer Edge	Wood or Lam Top & Wood Edge	C,M,W w/ Lam Top & Polymer Edge	C,M,W w/ Wood or Lam Top & Wood Edge						
Single Pedestal	76C6020XLBR0	2890	2977	3035	3126	59.75	20	29.5	29	107	27.75
Credenza Lateral File or Bookcase with	76C6020XLORB	2890	2977	3035	3126	59.75	20	29.5	29	107	27.75
Fixed Wood Modesty Panel	76C6020XLFR0	3135	3229	3292	3389	59.75	20	29.5	29	140	27.75
	76C6020XLORF	3135	3229	3292	3389	59.75	20	29.5	29	140	27.75
	76C6024XLBR0	2998	3088	3147	3242	59.75	24	29.5	29	113	32
	76C6024XLORB	2998	3088	3147	3242	59.75	24	29.5	29	113	32
	76C6024XLFR0*	3244	3342	3406	3509	59.75	24	29.5	29	147	32
	76C6024XLORF	3244	3342	3406	3509	59.75	24	29.5	29	147	32
	76C6620XLBR0	2919	3008	3066	3158	65.75	20	29.5	35	118	30
	76C6620XLORB	2919	3008	3066	3158	65.75	20	29.5	35	118	30
	76C6620XLFR0	3163	3260	3322	3423	65.75	20	29.5	35	154	30
	76C6620XLORF	3163	3260	3322	3423	65.75	20	29.5	35	154	30
	76C6624XLBR0	3029	3119	3181	3274	65.75	24	29.5	35	125	35
	76C6624XLORB	3029	3119	3181	3274	65.75	24	29.5	35	125	35
	76C6624XLFR0*	3273	3371	3437	3541	65.75	24	29.5	35	162	35
	76C6624XLORF	3273	3371	3437	3541	65.75	24	29.5	35	162	35
	76C7220XLBR0	3068	3160	3220	3316	71.75	20	29.5	35	128	32.75
	76C7220XLORB	3068	3160	3220	3316	71.75	20	29.5	35	128	32.75
	76C7220XLFR0	3465	3567	3639	3746	71.75	20	29.5	35	168	32.75
	76C7220XLORF	3465	3567	3639	3746	71.75	20	29.5	35	168	32.75
	76C7224XLBR0	3182	3277	3342	3441	71.75	24	29.5	35	136	38
	76C7224XLORB	3182	3277	3342	3441	71.75	24	29.5	35	136	38
	76C7224XLFR0*	3521	3628	3698	3811	71.75	24	29.5	35	176	38
	76C7224XLORF	3521	3628	3698	3811	71.75	24	29.5	35	176	38
	76C7820XLBR0	3112	3206	3267	3364	77.75	20	29.5	41	155	35.5
	76C7820XLORB	3112	3206	3267	3364	77.75	20	29.5	41	155	35.5
	76C7820XLFR0	3579	3686	3759	3871	77.75	20	29.5	41	195	35.5
	76C7820XLORF	3579	3686	3759	3871	77.75	20	29.5	41	195	35.5
	76C7824XLBR0	3206	3301	3364	3468	77.75	24	29.5	41	174	41
	76C7824XLORB	3206	3301	3364	3468	77.75	24	29.5	41	174	41
	76C7824XLFR0*	3652	3762	3834	3952	77.75	24	29.5	41	199	41
	76C7824XLORF	3652	3762	3834	3952	77.75	24	29.5	41	199	41
	76C8420XLBR0	3159	3251	3315	3415	83.75	20	29.5	47	181	38
	76C8420XLORB	3159	3251	3315	3415	83.75	20	29.5	47	181	38
	76C8420XLFR0	3691	3804	3877	3994	83.75	20	29.5	47	221	38
	76C8420XLORF	3691	3804	3877	3994	83.75	20	29.5	47	221	38
	76C8424XLBR0	3232	3326	3390	3494	83.75	24	29.5	47	212	44
	76C8424XLORB	3232	3326	3390	3494	83.75	24	29.5	47	212	44
	76C8424XLFR0	3784	3895	3972	4090	83.75	24	29.5	47	252	44
	76C8424XLORF	3784	3895	3972	4090	83.75	24	29.5	47	252	44

**ORDERING NOTES:** Credenzas have the option of pulls instead of the standard touch latch doors. To select this option, please change the prefix in the model number from "76" to "77" ie: 77C7224XLBR0. Please refer to page 514 for pull orientation below the worksurface. Locks are available on wood doors for an upcharge of **\$152 list**.

**ORDERING PROCEDURE**

To order, please specify the following:

- 1) Krug product model number
- 2) Wood species and finish, see Page 11
- 3) Wood edge detail- I,H, L or P, see Page 3
- 4) Pull style, see Page 4
- 5) Grommet location if applicable

**CODE DESCRIPTION**

- D - 2 file drawers
- F - 2 box, 1 file drawer
- L - left handed pedestal
- R - right handed pedestal
- 0 - no pedestal
- B - bookcase
- F - lateral file
- X - full height modesty

**STANDARD FINISHES**

For a complete list of standard wood finishes please see Page 117.

**GROMMETS**

One grommet in standard position is optional at no charge. Additional rectangular grommets are available at an upcharge of **\$152 list**.

ARTEMIS | CREDENZAS

Description	Model	Rift Oak or	Rift Oak or	C,M,W w/		W	D	H	KW	Shipping Weight	Cubic Feet
		Palette w/ Lam Top & Polymer Edge	Palette w/ Wood Lam Top & Wood Edge	C,M,W w/ Lam Top & Polymer Edge	C,M,W w/ Wood Lam Top & Wood Edge						
Single 36" Combination Pedestal Credenza with Fixed Wood Modesty Panel	76C7220XL3602R0	3220	3316	3382	3484	71.75	20	29.5	35	168	32.75
	76C7220XL0R3604	3220	3316	3382	3484	71.75	20	29.5	35	168	32.75
	76C7224XL3602R0	3341	3439	3508	3610	71.75	24	29.5	35	176	38
	76C7224XL0R3604	3341	3439	3508	3610	71.75	24	29.5	35	176	38
	76C7820XL3602R0*	3268	3366	3431	3535	77.75	20	29.5	41	174	35.5
	76C7820XL0R3604	3268	3366	3431	3535	77.75	20	29.5	41	174	35.5
	76C7824XL3602R0	3368	3469	3537	3642	77.75	24	29.5	41	182	41
	76C7824XL0R3604	3368	3469	3537	3642	77.75	24	29.5	41	182	41
	76C8420XL3602R0	3314	3412	3481	3582	83.75	20	29.5	47	180	38
	76C8420XL0R3604	3314	3412	3481	3582	83.75	20	29.5	47	180	38
	76C8424XL3602R0	3395	3495	3564	3670	83.75	24	29.5	47	188	44
	76C8424XL0R3604	3395	3495	3564	3670	83.75	24	29.5	47	188	44
Double Pedestal Credenza with Fixed Wood Modesty Panel	76C60204XLDRD	3457	3561	3631	3739	59.75	20	29.5	28.5	200	27.75
	76C60204XLDRF	3457	3561	3631	3739	59.75	20	29.5	28.5	200	27.75
	76C60204XLFRD	3457	3561	3631	3739	59.75	20	29.5	28.5	200	27.75
	76C60204XLFRF	3457	3561	3631	3739	59.75	20	29.5	28.5	200	27.75
	76C60244XLDRD*	3486	3588	3661	3768	59.75	24	29.5	28.5	208	32
	76C60244XLDRF	3486	3588	3661	3768	59.75	24	29.5	28.5	208	32
	76C60244XLFRD	3486	3588	3661	3768	59.75	24	29.5	28.5	208	32
	76C60244XLFRF	3486	3588	3661	3768	59.75	24	29.5	28.5	208	32
	76C66204XLDRD	3512	3618	3687	3797	65.75	20	29.5	34.5	216	30
	76C66204XLDRF	3512	3618	3687	3797	65.75	20	29.5	34.5	216	30
	76C66204XLFRD	3512	3618	3687	3797	65.75	20	29.5	34.5	216	30
	76C66204XLFRF	3512	3618	3687	3797	65.75	20	29.5	34.5	216	30
	76C66244XLDRD	3517	3624	3693	3804	65.75	24	29.5	34.5	224	35
	76C66244XLDRF	3517	3624	3693	3804	65.75	24	29.5	34.5	224	35
	76C66244XLFRD	3517	3624	3693	3804	65.75	24	29.5	34.5	224	35
	76C66244XLFRF	3517	3624	3693	3804	65.75	24	29.5	34.5	224	35
	76C72204XLDRD	3543	3651	3721	3834	71.75	20	29.5	40.5	232	32.75
	76C72204XLDRF	3543	3651	3721	3834	71.75	20	29.5	40.5	232	32.75
	76C72204XLFRD	3543	3651	3721	3834	71.75	20	29.5	40.5	232	32.75
	76C72204XLFRF	3543	3651	3721	3834	71.75	20	29.5	40.5	232	32.75
	76C72244XLDRD*	3575	3682	3752	3866	71.75	24	29.5	40.5	240	38
	76C72244XLDRF	3575	3682	3752	3866	71.75	24	29.5	40.5	240	38
	76C72244XLFRD	3575	3682	3752	3866	71.75	24	29.5	40.5	240	38
	76C72244XLFRF	3575	3682	3752	3866	71.75	24	29.5	40.5	240	38
	76C78204XLDRD	3578	3684	3754	3870	77.75	20	29.5	46.5	248	35.5
	76C78204XLDRF	3578	3684	3754	3870	77.75	20	29.5	46.5	248	35.5
	76C78204XLFRD	3578	3684	3754	3870	77.75	20	29.5	46.5	248	35.5
	76C78204XLFRF	3578	3684	3754	3870	77.75	20	29.5	46.5	248	35.5
	76C78244XLDRD	3581	3687	3759	3874	77.75	24	29.5	46.5	256	41
	76C78244XLDRF	3581	3687	3759	3874	77.75	24	29.5	46.5	256	41
	76C78244XLFRD	3581	3687	3759	3874	77.75	24	29.5	46.5	256	41
	76C78244XLFRF	3581	3687	3759	3874	77.75	24	29.5	46.5	256	41
	76C84204XLDRD	3587	3691	3762	3878	83.75	20	29.5	52.5	264	38
	76C84204XLDRF	3587	3691	3762	3878	83.75	20	29.5	52.5	264	38
	76C84204XLFRD	3587	3691	3762	3878	83.75	20	29.5	52.5	264	38
	76C84204XLFRF	3587	3691	3762	3878	83.75	20	29.5	52.5	264	38
	76C84244XLDRD	3604	3712	3785	3896	83.75	24	29.5	52.5	272	44
	76C84244XLDRF	3604	3712	3785	3896	83.75	24	29.5	52.5	272	44
	76C84244XLFRD	3604	3712	3785	3896	83.75	24	29.5	52.5	272	44
	76C84244XLFRF	3604	3712	3785	3896	83.75	24	29.5	52.5	272	44

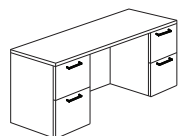
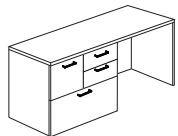

**DIMENSION KEY**  
W - width  
D - depth  
H - height

**CODE DESCRIPTION**  
X - fixed modesty  
L - left handed pedestal  
R - right handed pedestal  
02 - 2 box, 1 file, 1 lateral file pedestals  
04 - 1 file, 2 box, 1 lateral file pedestals  
0 - no pedestal  
4 - full height pedestal  
D - 2 file drawers  
F - 2 box, 1 file drawer

**STANDARD FINISHES**  
For a complete list of standard wood finishes please see Page 117.

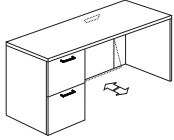

# ARTEMIS | CREDENZAS

Description	Model	Rift Oak or	Rift Oak or	C,M,W w/	C,M,W w/	W	D	H	KW	Shipping Weight	Cubic Feet
		Palette w/ Lam Top & Polymer Edge	Palette w/ Wood or Lam Top & Wood Edge	C,M,W w/ Lam Top & Polymer Edge	C,M,W w/ Wood or Lam Top & Wood Edge						
Single Pedestal	76CY60204LDR0	3539	3647	3717	3829	59.75	20	29.5	43	120	27.75
Credenza with Hinged Wood Modesty Panel	76CY60204LFR0	3539	3647	3717	3829	59.75	20	29.5	43	120	27.75
	76CY60204LORD	3539	3647	3717	3829	59.75	20	29.5	43	120	27.75
	76CY60204LORF	3539	3647	3717	3829	59.75	20	29.5	43	120	27.75
	76CY60244LDR0	3564	3671	3742	3855	59.75	24	29.5	43	128	32
	76CY60244LFR0	3564	3671	3742	3855	59.75	24	29.5	43	128	32
	76CY60244LORD	3564	3671	3742	3855	59.75	24	29.5	43	128	32
	76CY60244LORF	3564	3671	3742	3855	59.75	24	29.5	43	128	32
	76CY66204LDR0	3595	3706	3773	3890	65.75	20	29.5	49	136	30
	76CY66204LFR0*	3595	3706	3773	3890	65.75	20	29.5	49	136	30
	76CY66204LORD	3595	3706	3773	3890	65.75	20	29.5	49	136	30
	76CY66204LORF	3595	3706	3773	3890	65.75	20	29.5	49	136	30
	76CY66244LDR0	3609	3718	3790	3904	65.75	24	29.5	49	144	35
76CY66244LFR0	3609	3718	3790	3904	65.75	24	29.5	49	144	35	
76CY66244LORD	3609	3718	3790	3904	65.75	24	29.5	49	144	35	
76CY66244LORF	3609	3718	3790	3904	65.75	24	29.5	49	144	35	
76CY72204LDR0	3630	3739	3811	3924	71.75	20	29.5	55	152	32.75	
76CY72204LFR0	3630	3739	3811	3924	71.75	20	29.5	55	52	32.75	
76CY72204LORD	3630	3739	3811	3924	71.75	20	29.5	55	152	32.75	
76CY72204LORF	3630	3739	3811	3924	71.75	20	29.5	55	152	32.75	
76CY72244LDR0	3656	3767	3840	3955	71.75	24	29.5	55	160	38	
76CY72244LFR0	3656	3767	3840	3955	71.75	24	29.5	55	160	38	
76CY72244LORD	3656	3767	3840	3955	71.75	24	29.5	55	160	38	
76CY72244LORF	3656	3767	3840	3955	71.75	24	29.5	55	160	38	
76CY78204LDR0	3668	3780	3851	3966	77.75	20	29.5	61	168	35.5	
76CY78204LFR0	3668	3780	3851	3966	77.75	20	29.5	61	168	35.5	
76CY78204LORD	3668	3780	3851	3966	77.75	20	29.5	61	168	35.5	
76CY78204LORF	3668	3780	3851	3966	77.75	20	29.5	61	168	35.5	
76CY78244LDR0	3671	3784	3855	3972	77.75	24	29.5	61	176	41	
76CY78244LFR0	3671	3784	3855	3972	77.75	24	29.5	61	176	41	
76CY78244LORD	3671	3784	3855	3972	77.75	24	29.5	61	176	41	
76CY78244LORF	3671	3784	3855	3972	77.75	24	29.5	61	176	41	
76CY84204LDR0	3679	3788	3862	3978	83.75	20	29.5	67	184	38	
76CY84204LFR0	3679	3788	3862	3978	83.75	20	29.5	67	184	38	
76CY84204LORD	3679	3788	3862	3978	83.75	20	29.5	67	184	38	
76CY84204LORF	3679	3788	3862	3978	83.75	20	29.5	67	184	38	
76CY84244LDR0	3690	3803	3876	3993	83.75	24	29.5	67	192	44	
76CY84244LFR0	3690	3803	3876	3993	83.75	24	29.5	67	192	44	
76CY84244LORD	3690	3803	3876	3993	83.75	24	29.5	67	192	44	
76CY84244LORF	3690	3803	3876	3993	83.75	24	29.5	67	192	44	

**ORDERING PROCEDURE**

To order, please specify the following:

- 1) Krug product model number
- 2) Wood species and finish, see Page 11
- 3) Wood edge detail- I,H, L or P, see Page 3
- 4) Pull style, see Page 4
- 5) Grommet location if applicable

**CODE DESCRIPTION**

- 4 - full height pedestal
- L - left hand pedestal position
- R - right hand pedestal position
- D - 2 file drawers
- F - 2 box, 1 file drawer
- 0 - no pedestal

**STANDARD FINISHES**

For a complete list of standard wood finishes please see Page 117.

**GROMMETS**

One grommet in standard position is optional at no charge. Additional rectangular grommets are available at an upcharge of **\$152 list.**

ARTEMIS | CREDENZAS

Description	Model	Rift Oak or	Rift Oak or	C,M,W w/		W	D	H	KW	Shipping Weight	Cubic Feet
		Palette w/ Lam Top & Polymer Edge	Wood or Lam Top & Wood Edge	C,M,W w/ Lam Top & Polymer Edge	Wood or Lam Top & Wood Edge						
Single 36" Pedestal	76CY7220LBR0	3373	3472	3541	3647	71.75	20	29.5	35	116	32.75
Lateral File or	76CY7220LORB	3373	3472	3541	3647	71.75	20	29.5	35	116	32.75
Bookcase	76CY7220LFR0	3814	3929	4004	4120	71.75	20	29.5	35	156	32.75
Credenza with Hinged	76CY7220LORF	3814	3929	4004	4120	71.75	20	29.5	35	156	32.75
Wood Modesty Panel	76CY7224LBR0	3497	3604	3671	3783	71.75	24	29.5	35	120	38
	76CY7224LORB	3497	3604	3671	3783	71.75	24	29.5	35	120	38
	76CY7224LFR0*	3874	3991	4067	4189	71.75	24	29.5	35	160	38
	76CY7224LORF	3874	3991	4067	4189	71.75	24	29.5	35	160	38
	76CY7820LBR0	3454	3557	3627	3735	77.75	20	29.5	41	155	35.5
	76CY7820LORB	3454	3557	3627	3735	77.75	20	29.5	41	155	35.5
	76CY7820LFR0	3958	4077	4155	4281	77.75	20	29.5	41	195	35.5
	76CY7820LORF	3958	4077	4155	4281	77.75	20	29.5	41	195	35.5
	76CY7824LBR0	3545	3654	3723	3836	77.75	24	29.5	41	174	41
	76CY7824LORB	3545	3654	3723	3836	77.75	24	29.5	41	174	41
	76CY7824LFR0	4033	4153	4235	4361	77.75	24	29.5	41	199	41
	76CY7824LORF	4033	4153	4235	4361	77.75	24	29.5	41	199	41
	76CY8420LBR0	3497	3604	3671	3783	83.75	20	29.5	47	181	38
	76CY8420LORB	3497	3604	3671	3783	83.75	20	29.5	47	181	38
	76CY8420LFR0	4070	4192	4274	4401	83.75	20	29.5	47	221	38
	76CY8420LORF	4070	4192	4274	4401	83.75	20	29.5	47	221	38
	76CY8424LBR0	3573	3680	3752	3864	83.75	24	29.5	47	212	44
	76CY8424LORB	3573	3680	3752	3864	83.75	24	29.5	47	212	44
	76CY8424LFR0	4161	4287	4369	4500	83.75	24	29.5	47	252	44
	76CY8424LORF	4161	4287	4369	4500	83.75	24	29.5	47	252	44

Single 36"	76CY7220L3602R0	3541	3648	3718	3830	71.75	20	29.5	35	168	32.75
Combination	76CY7220LOR3604	3541	3648	3718	3830	71.75	20	29.5	35	168	32.75
Pedestal Credenza	76CY7224L3602R0*	3670	3783	3854	3970	71.75	24	29.5	35	176	38
with Hinged Wood	76CY7224LOR3604	3670	3783	3854	3970	71.75	24	29.5	35	176	38
Modesty Panel	76CY7820L3602R0	3686	3796	3870	3987	77.75	20	29.5	41	174	35.5
	76CY7820LOR3604	3686	3796	3870	3987	77.75	20	29.5	41	174	35.5
	76CY7824L3602R0	3760	3873	3949	4066	77.75	24	29.5	41	182	41
	76CY7824LOR3604	3760	3873	3949	4066	77.75	24	29.5	41	182	41
	76CY8420L3602R0	3830	3948	4022	4142	83.75	20	29.5	47	180	38
	76CY8420LOR3604	3830	3948	4022	4142	83.75	20	29.5	47	180	38
	76CY8424L3602R0	3847	3962	4039	4160	83.75	24	29.5	47	188	44
	76CY8424LOR3604	3847	3962	4039	4160	83.75	24	29.5	47	188	44

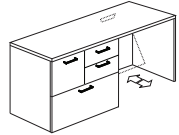
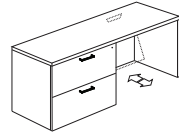

**ORDERING NOTES:**

Credenzas have the option of pulls instead of the standard touch latch doors. To select this option, please change the prefix in the model number from "76" to "77" ie: 77C7220LXLRX. Please refer to Page 4 for pull orientation below the worksurface. Locks are available on wood doors for an upcharge of **\$152 list**.

**DIMENSION KEY**

W - width  
D - depth  
H - height

**CODE DESCRIPTION**

L - left hand pedestal position  
R - right hand pedestal position  
B - bookcase  
F - Lateral File  
0 - no pedestal  
Y - hinged modesty panel  
02 - 2 box, 1 file, 1 lateral file pedest  
04 - 1 file, 2 box, 1 lateral file pedest

**STANDARD FINISHES**

For a complete list of standard wood finishes please see Page 117.

# ARTEMIS | CREDENZAS

Description	Model	Rift Oak or	Rift Oak or	C,M,W w/	C,M,W w/	W	D	H	KW	Shipping Weight	Cubic Feet
		Palette w/ Lam Top & Polymer Edge	Palette w/ Wood or Lam Top & Wood Edge	C,M,W w/ Lam Top & Polymer Edge	C,M,W w/ Wood or Lam Top & Wood Edge						
Double Pedestal Credenza with Hinged Wood Modesty Panel	76CY60204LDRD	3806	3920	3995	4114	59.75	20	29.5	28.5	220	27.75
	76CY60204LDRF	3806	3920	3995	4114	59.75	20	29.5	28.5	220	27.75
	76CY60204LFRD	3806	3920	3995	4114	59.75	20	29.5	28.5	220	27.75
	76CY60204LFRF	3806	3920	3995	4114	59.75	20	29.5	28.5	220	27.75
	76CY60244LDRD	3830	3948	4022	4142	59.75	24	29.5	28.5	220	32
	76CY60244LDRF	3830	3948	4022	4142	59.75	24	29.5	28.5	220	32
	76CY60244LFRD	3830	3948	4022	4142	59.75	24	29.5	28.5	220	32
	76CY60244LFRF	3830	3948	4022	4142	59.75	24	29.5	28.5	220	32
	76CY66204LDRD	3859	3977	4053	4173	65.75	20	29.5	34.5	228	30
	76CY66244LDRD	3867	3983	4060	4182	65.75	24	29.5	34.5	228	35
	76CY66204LDRF	3859	3977	4053	4173	65.75	20	29.5	34.5	228	30
	76CY66244LDRF*	3867	3983	4060	4182	65.75	24	29.5	34.5	228	35
	76CY66204LFRD	3859	3977	4053	4173	65.75	20	29.5	34.5	228	30
	76CY66244LFRD	3867	3983	4060	4182	65.75	24	29.5	34.5	228	35
	76CY66204LFRF	3859	3977	4053	4173	65.75	20	29.5	34.5	228	30
	76CY66244LFRF	3867	3983	4060	4182	65.75	24	29.5	34.5	228	35
	76CY72204LDRD	3899	4019	4095	4217	71.75	20	29.5	40.5	228	32.75
	76CY72204LDRF	3899	4019	4095	4217	71.75	20	29.5	40.5	228	32.75
	76CY72204LFRD	3899	4019	4095	4217	71.75	20	29.5	40.5	228	32.75
	76CY72204LFRF	3899	4019	4095	4217	71.75	20	29.5	40.5	228	32.75
	76CY72244LDRD	3932	4048	4130	4252	71.75	24	29.5	40.5	236	38
	76CY72244LDRF	3932	4048	4130	4252	71.75	24	29.5	40.5	236	38
	76CY72244LFRD	3932	4048	4130	4252	71.75	24	29.5	40.5	236	38
	76CY72244LFRF	3932	4048	4130	4252	71.75	24	29.5	40.5	236	38
	76CY78204LDRD	3939	4059	4139	4261	77.75	20	29.5	46.5	234	35.5
	76CY78204LDRF	3939	4059	4139	4261	77.75	20	29.5	46.5	234	35.5
	76CY78204LFRD	3939	4059	4139	4261	77.75	20	29.5	46.5	234	35.5
	76CY78204LFRF	3939	4059	4139	4261	77.75	20	29.5	46.5	234	35.5
	76CY78244LDRD	3946	4064	4142	4267	77.75	24	29.5	46.5	242	41
	76CY78244LDRF	3946	4064	4142	4267	77.75	24	29.5	46.5	242	41
	76CY78244LFRD	3946	4064	4142	4267	77.75	24	29.5	46.5	242	41
	76CY78244LFRF	3946	4064	4142	4267	77.75	24	29.5	46.5	242	41
	76CY84204LDRD	3950	4067	4146	4271	83.75	20	29.5	52.5	240	38
	76CY84204LDRF	3950	4067	4146	4271	83.75	20	29.5	52.5	240	38
	76CY84204LFRD	3950	4067	4146	4271	83.75	20	29.5	52.5	240	38
	76CY84204LFRF	3950	4067	4146	4271	83.75	20	29.5	52.5	240	38
	76CY84244LDRD	3960	4080	4160	4284	83.75	24	29.5	52.5	248	44
	76CY84244LDRF	3960	4080	4160	4284	83.75	24	29.5	52.5	248	44
	76CY84244LFRD	3960	4080	4160	4284	83.75	24	29.5	52.5	248	44
	76CY84244LFRF	3960	4080	4160	4284	83.75	24	29.5	52.5	248	44

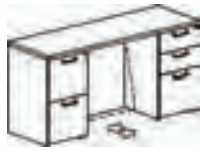

### ORDERING PROCEDURE

To order, please specify the following:

- 1) Krug product model number
- 2) Wood species and finish, see Page 11
- 3) Wood edge detail- I,H, L or P, see Page 3
- 4) Pull style, see Page 4
- 5) Grommet location if applicable

### CODE DESCRIPTION

- 4 - full height pedestal
- L - left hand pedestal position
- R - right hand pedestal position
- D - 2 file drawers
- F - 2 box, 1 file drawer
- Y - wood hinged modesty panel





### STANDARD FINISHES

For a complete list of standard wood finishes please see Page 117.

### GROMMETS

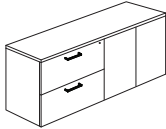
One grommet in standard position is optional at no charge. Additional rectangular grommets are available at an upcharge of **\$152 list.**

# ARTEMIS | CREDENZAS

Description	Model	Rift Oak or	Rift Oak or	C,M,W w/		W	D	H	Shipping Weight	Cubic Feet	
		Palette w/ Lam Top & Polymer Edge	Palette w/ Wood Lam Top & Wood Edge	C,M,W w/ Lam Top & Polymer Edge	C,M,W w/ Wood Lam Top & Wood Edge						
	76C6020LBRB	3348	3448	3516	3620	59.75	20	29.5	176	28	
	76C6020LBRF	3512	3618	3687	3797	59.75	20	29.5	192	28	
	76C6020LFRB	3512	3618	3687	3797	59.75	20	29.5	192	28	
	76C6020LFRF	3672	3785	3856	3974	59.75	20	29.5	208	28	
	76C6024LBRB	3393	3494	3563	3669	59.75	24	29.5	192	33	
	76C6024LBRF*	3591	3698	3770	3882	59.75	24	29.5	210	33	
	76C6024LFRB	3591	3698	3770	3882	59.75	24	29.5	210	33	
	76C6024LFRF	3788	3902	3978	4097	59.75	24	29.5	230	33	
	76C7220LBRB	3735	3846	3920	4038	71.75	20	29.5	208	32.75	
	76C7220LBRF	4387	4515	4606	4743	71.75	20	29.5	228	32.75	
	76C7220LFRB	4387	4515	4606	4743	71.75	20	29.5	228	32.75	
	76C7220LFRF	4809	4951	5047	5196	71.75	20	29.5	248	32.75	
	76C7224LBRB	3785	3896	3974	4092	71.75	24	29.5	224	38	
	76C7224LBRF	4466	4600	4689	4831	71.75	24	29.5	236	38	
	76C7224LFRB	4466	4600	4689	4831	71.75	24	29.5	236	38	
76C7224LFRF	4868	5013	5112	5264	71.75	24	29.5	256	38		
	76C6024LBRHAES*	5345	5506	5612	5782	59.75	24	29.5	176	28	
	76C6024LHAESRB	5345	5506	5612	5782	59.75	24	29.5	192	28	
	76C6024LFRHAES	5549	5717	5828	6002	59.75	24	29.5	192	28	
	76C6024LHAESRF	5549	5717	5828	6002	59.75	24	29.5	248	28	
	76C7224LBRHAES	5860	6035	6154	6336	71.75	24	29.5	192	33	
	76C7224LHAESRB	5860	6035	6154	6336	71.75	24	29.5	210	33	
	76C7224LFRHAES	5985	6163	6285	6471	71.75	24	29.5	210	33	
	76C7224LHAESRF	5985	6163	6285	6471	71.75	24	29.5	230	33	
<b>NOTE:</b> Height range of electric lift is 29.5" to 46.5".											
	76CC7224XL4D*	2873	2958	3015	3105	71.75	24	29.5	32	192	38
	76CC7224XL4F	2873	2958	3015	3105	71.75	24	29.5	32	192	38
	76CC7224XR4D	2873	2958	3015	3105	71.75	24	29.5	32	192	38
	76CC7224XR4F	2873	2958	3015	3105	71.75	24	29.5	32	192	38
	76CC7824XL4D	2903	2988	3047	3138	77.75	24	29.5	38	200	41
	76CC7824XL4F	2903	2988	3047	3138	77.75	24	29.5	38	200	41
	76CC7824XR4D	2903	2988	3047	3138	77.75	24	29.5	38	200	41
	76CC7824XR4F	2903	2988	3047	3138	77.75	24	29.5	38	200	41
	76CC8424XL4D	2933	3017	3078	3172	83.75	24	29.5	44	208	44
	76CC8424XL4F	2933	3017	3078	3172	83.75	24	29.5	44	208	44
	76CC8424XR4D	2933	3017	3078	3172	83.75	24	29.5	44	208	44
	76CC8424XR4F	2933	3017	3078	3172	83.75	24	29.5	44	208	44
		76CCC7224XL4D*	2929	3016	3076	3167	71.75	24	29.5	32	192
76CCC7224XL4F		2929	3016	3076	3167	71.75	24	29.5	32	192	38
76CCC7224XR4D		2929	3016	3076	3167	71.75	24	29.5	32	192	38
76CCC7224XR4F		2929	3016	3076	3167	71.75	24	29.5	32	192	38
76CCC7824XL4D		2962	3052	3109	3203	77.75	24	29.5	38	200	41
76CCC7824XL4F		2962	3052	3109	3203	77.75	24	29.5	38	200	41
76CCC7824XR4D		2962	3052	3109	3203	77.75	24	29.5	38	200	41
76CCC7824XR4F		2962	3052	3109	3203	77.75	24	29.5	38	200	41
76CCC8424XL4D		2991	3081	3140	3236	83.75	24	29.5	44	208	44
76CCC8424XL4F		2991	3081	3140	3236	83.75	24	29.5	44	208	44
76CCC8424XR4D		2991	3081	3140	3236	83.75	24	29.5	44	208	44
76CCC8424XR4F		2991	3081	3140	3236	83.75	24	29.5	44	208	44

**DIMENSION KEY**

W - width  
D - depth  
H - height

**CODE DESCRIPTION**



L - left hand pedestal position  
R - right hand pedestal position  
B - bookcase  
F - Lateral File  
HAES - Height Adjustable Electric Lift (Single Stage)

**STANDARD FINISHES**

For a complete list of standard wood finishes please see Page 117.

Credenzas have the option of pulls instead of the standard touch latch doors. To select this option, please change the prefix in the model number from "76" to "77" ie: 77C7220XLXRX. Locks are available on wood doors for an up-charge of **\$152 list**.

# ARTEMIS | 3/4 HEIGHT CREDENZAS

Description	Model	Rift Oak or	Rift Oak or	C,M,W w/		W	D	H	KW	Shipping Weight	Cubic Feet
		Palette w/ Lam Top & Polymer Edge	Wood or Lam Top & Wood Edge	C,M,W w/ Lam Top & Polymer Edge	C,M,W w/ Lam Top & Wood Edge						
Single Pedestal 3/4 Height Credenzas	76C60203LOR3011	2726	2807	2861	2948	59.75	20	23	28	191	21
	76C60203LOR3016*	2789	2873	2928	3016	59.75	20	23	28	202	21
	76C60203L3011RO	2726	2807	2861	2948	59.75	20	23	28	191	21
	76C60203L3016RO	2789	2873	2928	3016	59.75	20	23	28	202	21
	76C60243LOR3011**	3118	3211	3274	3373	59.75	24	23	28	204	25
	76C60243LOR3016	3193	3290	3353	3454	59.75	24	23	28	226	25
	76C60243L3011RO	3118	3211	3274	3373	59.75	24	23	28	191	25
	76C60243L3016RO	3193	3290	3353	3454	59.75	24	23	28	242	25
	76C66203LOR3611	2781	2864	2921	3009	59.75	20	23	28.5	191	21
	76C66203LOR3616	2846	2932	2985	3071	59.75	20	23	28.5	202	21
	76C66203L3611RO	2781	2864	2921	3009	59.75	20	23	28.5	191	21
	76C66203L3616RO	2846	2932	2985	3071	59.75	20	23	28.5	202	21
	76C66243LOR3611	3182	3278	3342	3441	59.75	24	23	28.5	204	25
	76C66243LOR3616	3257	3354	3420	3521	59.75	24	23	28.5	226	25
	76C66243L3611RO	3182	3278	3342	3441	59.75	24	23	28.5	191	25
	76C66243L3616RO	3257	3354	3420	3521	59.75	24	23	28.5	242	25
	76C72203LOR3611	2838	2922	2982	3069	71.75	20	23	34.5	191	25.5
	76C72203LOR3616	2903	2989	3048	3138	71.75	20	23	34.5	202	25.5
	76C72203L3611RO	2838	2922	2982	3069	71.75	20	23	34.5	191	25.5
	76C72203L3616RO	2903	2989	3047	3138	71.75	20	23	34.5	202	25.5
	76C72243LOR3611	3246	3344	3409	3510	71.75	24	23	34.5	204	30
	76C72243LOR3616	3322	3424	3489	3594	71.75	24	23	34.5	226	30
	76C72243L3611RO	3246	3344	3409	3510	71.75	24	23	34.5	191	30
	76C72243L3616RO	3322	3424	3489	3594	71.75	24	23	34.5	242	30
	76C84203LOR3611	3236	3331	3397	3498	83.75	20	23	46.5	191	29.5
	76C84203LOR3616	3301	3399	3465	3568	83.75	20	23	46.5	202	29.5
	76C84203L3611RO	3236	3331	3397	3498	83.75	20	23	46.5	191	29.5
	76C84203L3616RO	3301	3399	3468	3568	83.75	20	23	46.5	202	29.5
	76C84243LOR3611	3661	3770	3844	3958	83.75	24	23	46.5	204	35
	76C84243LOR3616	3606	3713	3787	3899	83.75	24	23	46.5	226	35
76C84243L3611RO	3661	3770	3844	3958	83.75	24	23	46.5	191	35	
76C84243L3616RO	3606	3713	3787	3899	83.75	24	23	46.5	242	35	
76C96243LOR3616	3567	3678	3745	3859	95.5	24	23	58.5	254	40	
76C96243LOR3611	3142	3236	3298	3398	95.5	24	23	58.5	240	40	
76C96243L3611RO	3299	3398	3463	3567	95.5	24	23	58.5	240	40	
76C96243L3616RO	3567	3678	3745	3859	95.5	24	23	58.5	254	40	

**ORDERING NOTES:**

For the hinged modesty panel option add Y after C -eg. 76CY60203LOR3011 and add a 10% upcharge. Credenzas have the option of pulls instead of the standard touch latch doors. To select this option, please change the prefix in the model number from "76" to "77" ie: 77C7220XLXRX. Please refer to Page 4 for pull orientation below the worksurface. Locks are available on wood doors for an upcharge of **\$152 list**. The 15 open/lateral file module can be used in place of the 16 box/file module at the same price. The 18 open/closed bookcase module can be used in place of the 11 closed module at the same price.

**ORDERING PROCEDURE**

To order, please specify the following:

- 1) Krug product model number
- 2) Wood species and finish, see Page 11
- 3) Wood edge detail- I,H, L or P, see Page 3
- 4) Pull style, see Page 4
- 5) Grommet location if applicable

**CODE DESCRIPTION**

- 3 - 3/4 height credenza
- L - left hand pedestal position
- R - right hand pedestal position
- 0 - no pedestal
- 11 - closed bookcase
- 15 - top open, lateral file
- 16 - box, lateral file
- 17 - open bookcase
- 18 - top open, closed bookcase

**STANDARD FINISHES**

For a complete list of standard wood finishes please see Page 117.

**GROMMETS**

One grommet in standard position is optional at no charge. Additional rectangular grommets are available at an upcharge of **\$152 list**.

# ARTEMIS | 3/4 HEIGHT CREDENZAS

Description	Model	Rift Oak or	Rift Oak or	C,M,W w/		W	D	H	Shipping Weight	Cubic Feet
		Palette w/ Lam Top & Polymer Edge	Wood or Lam Top & Wood Edge	C,M,W w/ Lam Top & Polymer Edge	Wood or Lam Top & Wood Edge					
Full Face 3/4 Height Credenzas 	76C60203L3011R3011	3697	3809	3881	3997	59.75	20	23	186	21
	76C60203L3011R3016	4284	4414	4498	4632	59.75	20	23	191	21
	76C60203L3011R3017	3307	3405	3471	3577	59.75	20	23	171	21
	76C60203L3016R3011	3718	3830	3906	4022	59.75	24	23	191	21
	76C60203L3016R3016	3696	3806	3880	3996	59.75	20	23	202	21
	76C60203L3016R3017	4141	4265	4348	4478	59.75	20	23	179	21
	76C60203L3017R3011	3307	3405	3471	3577	59.75	20	23	171	21
	76C60203L3017R3016	4141	4265	4348	4478	59.75	20	23	179	21
	76C60203L3017R3017	2806	2891	2947	3035	59.75	20	23	156	21
	76C60243L3011R3011	3771	3885	3960	4079	59.75	24	23	193	25
	76C60243L3011R3016	3855	3972	4047	4170	59.75	24	23	204	25
	76C60243L3011R3017	3373	3473	3541	3647	59.75	24	23	178	25
	76C60243L3016R3011	3855	3972	4047	4170	59.75	24	23	204	25
	76C60243L3016R3016	3830	3948	4023	4143	59.75	24	23	226	25
	76C60243L3016R3017	3732	3844	3918	4036	59.75	24	23	216	25
	76C60243L3017R3011	3373	3473	3541	3647	59.75	24	23	178	25
	76C60243L3017R3016	3732	3844	3918	4036	59.75	24	23	216	25
	76C60243L3017R3017	2917	3004	3062	3156	59.75	24	23	163	25
	76C72203L3611R3611	3845	3959	4037	4158	71.5	24	23	197	25.5
	76C72203L3611R3616	3991	4110	4189	4316	71.75	20	23	213.5	25.5
	76C72203L3611R3617	3439	3594	3697	3856	71.5	20	23	182	25.5
	76C72203L3616R3611	3991	4110	4189	4316	71.75	20	23	213.5	25.5
	76C72203L3616R3616	3965	4085	4164	4289	71.75	20	23	218.5	25.5
	76C72203L3616R3617	3858	3975	4053	4172	71.75	20	23	218.5	25.5
	76C72203L3617R3611	3439	3577	3666	3810	71.5	20	23	182	25.5
	76C72203L3617R3616	3858	3975	4053	4172	71.75	20	23	199	25.5
	76C72203L3617R3617	3035	3197	3307	3479	71.5	20	23	167	25.5
	76C72243L3611R3611	3921	4085	4193	4366	71.5	24	23	200	30
	76C72243L3611R3616	4140	4264	4347	4477	71.75	24	23	240	30
	76C72243L3611R3617	3509	3613	3684	3793	71.5	24	23	185	30
	76C72243L3616R3611	4140	4264	4347	4477	71.75	24	23	240	30
	76C72243L3616R3616	4112	4236	4317	4447	71.75	24	23	237	30
	76C72243L3616R3617	4003	4120	4204	4327	71.75	24	23	224.5	30
	76C72243L3617R3611	3509	3613	3684	3793	71.5	24	23	185	30
	76C72243L3617R3616*	4003	4120	4204	4327	71.75	24	23	224.5	30
	76C72243L3617R3617	3095	3187	3248	3346	71.5	24	23	170	30
	76C84203L2411C3016R3011	5436	5600	5708	5878	83.5	20	23	276	29.5
	76C84203L2411C3016R3016	5227	5384	5488	5652	83.5	20	23	293	29.5
	76C84203L2411C3016R3017	5023	5173	5274	5430	83.5	20	23	266	29.5
	76C84203L2411C3017R3011	4439	4572	4663	4799	83.5	20	23	269	29.5
76C84203L2411C3017R3016	5023	5173	5274	5430	83.5	20	23	266	29.5	
76C84203L3011C3016R2411	5436	5600	5708	5878	83.5	20	23	276	29.5	
76C84203L3011C3017R2411	4439	4572	4663	4799	83.5	20	23	269	29.5	
76C84203L3016C3016R2411	5227	5227	5227	5227	83.5	20	23	293	29.5	
76C84203L3016C3017R2411	5023	5173	5274	5430	83.5	20	23	266	29.5	
76C84203L3017C3016R2411	5023	5173	5274	5430	83.5	20	23	266	29.5	

**DIMENSION KEY**

W - width  
D - depth  
H - height

**STANDARD FINISHES**

For a complete list of standard wood finishes please see Page 117.

# ARTEMIS | 3/4 HEIGHT CREDENZAS

Description	Model	Rift Oak or	Rift Oak or	C,M,W w/		W	D	H	Shipping Weight	Cubic Feet
		Palette w/ Lam Top & Polymer Edge	Wood or Lam Top & Wood Edge	C,M,W w/ Lam Top & Polymer Edge	Wood or Lam Top & Wood Edge					
Full Face 3/4 Height Credenzas cont. 	76C84243L2411C3016R3011	5545	5712	5822	5995	83.5	24	23	315	35
	76C84243L2411C3016R3016	5331	5493	5598	5765	83.5	24	23	328	35
	76C84243L2411C3016R3017*	5122	5277	5381	5539	83.5	24	23	305	35
	76C84243L2411C3017R3011	4530	4680	4781	4939	83.5	24	23	269	35
	76C84243L2411C3017R3016	5122	5274	5372	5531	83.5	24	23	305	35
	76C84243L3011C3016R2411	5545	5694	5794	5954	83.5	24	23	315	35
	76C84243L3011C3017R2411	4530	4680	4781	4939	83.5	24	23	269	35
	76C84243L3016C3016R2411	5331	5481	5582	5740	83.5	24	23	328	35
	76C84243L3016C3017R2411	5122	5274	5372	5531	83.5	24	23	305	35
	76C84243L3017C3016R2411	5122	5274	5372	5531	83.5	24	23	305	35
	76C90203L3011C3016R3017	4600	5603	5703	5860	89.5	20	23	271	32
	76C90203L3011C3017R3016	5452	5603	5703	5860	89.5	20	23	271	32
	76C90203L3016C3016R3016	5751	5902	6002	6159	89.5	20	23	311	32
	76C90203L3016C3017R3011	5452	5614	5722	5895	89.5	20	23	271	32
	76C90203L3016C3017R3016	5562	5729	5840	6016	89.5	20	23	300	32
	76C90203L3017C3016R3011	5452	5614	5722	5895	89.5	20	23	271	32
	76C90243L3011C3016R3017	5560	5726	5838	6014	89.5	24	23	282	37
	76C90243L3011C3017R3016	5604	5773	5888	6067	89.5	24	23	282	37
	76C90243L3016C3016R3016	5560	5726	5838	6014	89.5	24	23	312	37
	76C90243L3016C3017R3011	5674	5844	5958	6137	89.5	24	23	282	37
	76C90243L3016C3017R3016	5560	5726	5838	6014	89.5	24	23	293	37
	76C90243L3017C3016R3011	6141	6328	6448	6642	89.5	24	23	282	37
	76C96203L2411C3616R3611	5904	6081	6199	6387	95.5	20	23	307	36.5
	76C96203L2411C3616R3616	5674	5844	5958	6137	95.5	20	23	326	36.5
	76C96203L2411C3616R3617	5010	5161	5261	5420	95.5	20	23	294	36.5
	76C96203L2411C3617R3611	5674	5844	5958	6137	95.5	20	23	262	36.5
	76C96203L2411C3617R3616	6141	6328	6448	6642	95.5	20	23	294	36.5
	76C96203L3611C3616R2411	5016	5168	5267	5425	95.5	20	23	307	36.5
	76C96203L3611C3617R2411	5904	6081	6199	6387	95.5	20	23	262	36.5
	76C96203L3616C3616R2411	6141	6328	6448	6642	95.5	20	23	326	36.5
	76C96203L3616C3617R2411	6141	6328	6448	6642	95.5	20	23	304	36.5
	76C96203L3617C3616R2411	6079	6262	6385	6575	95.5	20	23	304	36.5
	76C96203L3011C3016R3617	6079	6262	6385	6575	95.5	20	23	304	36.5
	76C96203L3011C3617R3016	6543	6739	6870	7078	95.5	20	23	304	36.5
	76C96203L3016C3616R3016	6311	6498	6625	6823	95.5	24	23	348	40
76C96203L3016C3616R3017	6228	6414	6540	6735	95.5	24	23	304	40	
76C96203L3016C3617R3011	6311	6498	6625	6823	95.5	24	23	304	40	
76C96203L3016C3617R3016	6311	6498	6625	6823	95.5	24	23	336	40	
76C96203L3617C3016R3016	6079	6263	6385	6575	95.5	24	23	336	40	
76C96203L3617C3016R3011	6266	6454	6580	6777	95.5	24	23	304	40	

**ORDERING NOTES:**

For the hinged modesty panel option add Y after C -eg. 76CY60203L0R3011 and add a 10% upcharge. Credenzas have the option of pulls instead of the standard touch latch doors. To select this option, please change the prefix in the model number from "76" to "77" ie: 77C7220XLXR. Please refer to page 4 for pull orientation below the worksurface. Locks are available on wood doors for an **upcharge of \$152 list**. The 15 open/lateral file module can be used in place of the 16 box/file module at the same price. The 18 open/closed bookcase module can be used in place of the 11 closed module at the same price.

**ORDERING PROCEDURE**

To order, please specify the following:

- 1) Krug product model number
- 2) Wood species and finish, see Page 11
- 3) Wood edge detail- I,H, L or P, see Page 3
- 4) Pull style, see Page 4
- 5) Grommet location if applicable

\*Indicates model illustrated by line drawing.

**CODE DESCRIPTION**

- 3 - 3/4 height credenza
- L - left hand pedestal position
- R - right hand pedestal position
- 11 - closed bookcase
- 15 - top open, lateral file
- 16 - box, lateral file
- 17 - open bookcase
- 18 - top open, closed bookcase

**STANDARD FINISHES**

For a complete list of standard wood finishes please see Page 117.

**GROMMETS**

One grommet in standard position is optional at no charge. Additional rectangular grommets are available at an upcharge of **\$152 list**.

# ARTEMIS | 3/4 HEIGHT & CORNER CREDENZAS

Description	Model	Rift Oak or Palette w/ C,M,W w/ Wood or Lam Top & Polymer				W	D	H	Shipping Weight	Cubic Feet
		Edge	Edge	Edge	Edge					
	76C96243L2411C3616R3611	6024	6207	6325	6515	95.5	20	23	320	36.5
	76C96243L2411C3616R3616	5791	5965	6080	6263	95.5	20	23	334	36.5
	76C96243L2411C3616R3617	5116	5272	5370	5534	95.5	20	23	320	36.5
	76C96243L2411C3617R3611	5791	5965	6080	6263	95.5	20	23	288	36.5
	76C96243L2411C3617R3616	6266	6454	6580	6777	95.5	20	23	320	36.5
	76C96243L3611C3616R2411	5116	5302	5424	5616	95.5	20	23	320	36.5
	76C96243L3611C3617R2411	6024	6207	6325	6515	95.5	20	23	288	36.5
	76C96243L3616C3616R2411	5791	5791	5791	5791	95.5	20	23	334	36.5
	76C96243L3616C3617R2411	5791	5965	6080	6263	95.5	20	23	320	36.5
	76C96243L3617C3616R2411	6200	6388	6511	6708	95.5	20	23	320	36.5
	76C96243L3011C3016R3617*	6200	6388	6511	6708	95.5	20	23	316	36.5
	76C96243L3011C3617R3016	6674	6873	7007	7216	95.5	20	23	316	36.5
	76C96243L3016C3616R3016	6438	6630	6760	6962	95.5	24	23	360	40
	76C96243L3016C3616R3017	6353	6543	6671	6870	95.5	24	23	328	40
	76C96243L3016C3617R3011	5791	5965	6080	6263	95.5	24	23	316	40
	76C96243L3016C3617R3016	6438	6630	6760	6962	95.5	24	23	328	40
	76C96243L3617C3016R3016	6438	6630	6760	6962	95.5	24	23	328	40
	76C96243L3617C3016R3011	6353	6543	6671	6870	95.5	24	23	316	40

**DIMENSION KEY**

W - width  
D - depth  
H - height

**CODE DESCRIPTION**

L - left hand pedestal position  
R - right hand pedestal position  
4 - full height pedestal  
X - full height fixed modesty  
D - 2 file drawers  
F - 2 box, 1 file drawer

**STANDARD FINISHES**





For a complete list of standard wood finishes please see Page 117.

**LOCKS**

Locks are available on wood doors for an upcharge of \$152 list.

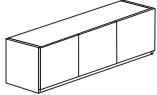

# ARTEMIS | OVERHEADS

Description	Model	Cherry		W	D	H	Doors	Shipping Weight	Cubic Feet
		Rift Oak Palette	Maple Walnut						
Single Wall Mounted Overhead with Wood Doors 	76OHW361616	1141	1199	35.75	15.75	16	2	64	7
	76OHW421616	1195	1254	41.75	15.75	16	2	71	8.5
	76OHW481616*	1285	1349	47.75	15.75	16	3	82	9
	76OHW541616	1331	1396	53.75	15.75	16	4	89.5	10.75
	76OHW601616	1374	1443	59.75	15.75	16	4	96	11.5
	76OHW661616	1449	1521	65.75	15.75	16	4	102	12.75
	76OHW721616	1526	1603	71.75	15.75	16	4	109	13.75
	76OHW841616	1899	1995	83.75	15.75	16	4	129	16.25
Single Wall Mounted Overhead with Frosted Glass Doors 	76OHW361616X	1372	1440	35.75	15.75	16	2	64	7
	76OHW421616X*	1434	1506	41.72	15.75	16	2	71	8.5
	76OHW481616X	1540	1619	47.75	15.75	16	3	82	9
	76OHW541616X	1593	1673	53.75	15.75	16	4	89.5	10.75
	76OHW601616X	1646	1731	59.75	15.75	16	4	96	11.5
	76OHW661616X	1738	1825	71.75	15.75	16	4	109	13.75
	76OHW721616X	1828	1921	65.75	15.75	16	4	102	12.75
	76OHW841616X	2280	2394	71.75	15.75	16	4	129	13.75
Single Height Overhead with Paper Manager 	76OHPMW361620	1485	1560	35.75	15.75	20	2	78	8.5
	76OHPMW421620	1556	1633	41.75	15.75	20	2	84	10
	76OHPMW481620	1642	1724	47.75	15.75	20	3	96	10.5
	76OHPMW541620	1728	1813	53.75	15.75	20	4	106	12.75
	76OHPMW601620*	1788	1878	59.75	15.75	20	4	114	13.5
	76OHPMW661620	1882	1977	65.75	15.75	20	4	122	15.25
	76OHPMW721620	1984	2084	71.75	15.75	20	4	129	16.25
	76OHPMW841620	2470	2593	83.75	15.75	20	4	150	19
Single Height Overhead with Paper Manager 	76OHPMW361620X	1782	1872	35.75	15.75	20	2	78	8.5
	76OHPMW421620X	1866	1959	41.75	15.75	20	2	84	10
	76OHPMW481620X	2004	2106	47.75	15.75	20	3	96	10.5
	76OHPMW541620X	2073	2176	53.75	15.75	20	4	106	12.75
	76OHPMW601620X*	2144	2252	59.75	15.75	20	4	114	13.5
	76OHPMW661620X	2257	2373	65.75	15.75	20	4	122	15.25
	76OHPMW721620X	2381	2497	71.75	15.75	20	4	129	16.25
	76OHPMW841620X	2964	3112	83.75	15.75	20	4	150	19

**ORDERING NOTES**

Fluorescent tasklights come standard with all overheads. L.E.D. tasklights are available, please see page 72 for the upcharge price.

**ORDERING PROCEDURE**

To order, please specify the following:

- 1) Krug product model number
- 2) Wood species and finish, see Page 11
- 3) Wood edge detail- I,H, L or P, see Page 3
- 4) Pull style, see Page 4
- 5) Grommet location if applicable

**CODE DESCRIPTION**

X - silver metallic framed frosted glass doors

**STANDARD FINISHES**

For a complete list of standard wood finishes please see Page 117.

# ARTEMIS | OVERHEADS

Description	Model	Cherry		W	D	H	Doors	Shipping Weight	Cubic Feet
		Rift Oak Palette	Maple Walnut						
Single Height Overhead with Sliding Wood Doors	76OSW481616	1827	1920	47.75	16	16	1	95	10
	76OSW601616	2024	2126	59.75	16	16	1	112	12
	76OSW661616*	2086	2191	65.75	16	16	1	121	13
	76OSW721616	2140	2249	71.5	16	16	1	129	14.5
	76OSW781616	2500	2625	77.5	16	16	2	148	15.5
	76OSW841616	2673	2807	83.5	16	16	2	157	16.5
	76OSW901616	3027	3179	89.5	16	16	2	166	17.5
76OSW961616	3237	3398	95.5	16	16	2	174	19	

Single Height Overhead with Sliding Back Painted Glass Doors	76OSW481616Z	2370	2489	47.75	16	16	1	99	10
	76OSW601616Z	2609	2740	59.75	16	16	1	117	12
	76OSW661616Z*	2742	2880	65.75	16	16	1	126	13
	76OSW721616Z	2824	2965	71.5	16	16	1	134	14.5
	76OSW781616Z	3965	4164	77.5	16	16	2	156	15.5
	76OSW841616Z	4141	4348	83.5	16	16	2	165	16.5
	76OSW901616Z	4600	4830	89.5	16	16	2	174	17.5
76OSW961616Z	4921	5168	95.5	16	16	2	183	19	

Single Height Overhead, Open End with Sliding Wood Doors	76OSOEW721616	2313	2430	71.5	16	16	2	91	14.5
	76OSOEW781616*	2601	2732	77.5	16	16	2	99	15.5
	76OSOEW841616	2780	2920	77.5	16	16	2	103	16.5
	76OSOEW901616	3147	3307	89.5	16	16	2	118	18.5
	76OSOEW961616	3368	3536	95.5	16	16	2	126	19.5
	76OSOEW1201616	3974	4172	120	16	16	2	162	24
	76OSOEW1441616	4454	4675	144	16	16	2	188	28.5

Single Height Overhead, Open End with Sliding Back Painted Glass Doors	76OSOEW721616Z	3655	3851	71.5	16	16	2	91	14.5
	76OSOEW781616Z*	4125	4331	77.5	16	16	2	99	15.5
	76OSOEW841616Z	4308	4521	77.5	16	16	2	103	16.5
	76OSOEW901616Z	4785	5024	89.5	16	16	2	118	18.5
	76OSOEW961616Z	5117	5372	95.5	16	16	2	126	19.5
	76OSOEW1201616Z	5859	6153	120	16	16	2	162	24
	76OSOEW1441616Z	5935	6230	144	16	16	2	188	28.5

**ORDERING NOTES**

120" and 144" overheads are shipped in 2 pieces.  
 L.E.D. tasklights come standard on all sliding door overheads. Fluorescent lights are not available on sliding door overheads.

**DIMENSION KEY**

W - width  
 D - depth  
 H - height

**CODE DESCRIPTION**

Z - back painted glass doors

**STANDARD FINISHES**

For a complete list of standard wood finishes please see Page 117.

# ARTEMIS | OVERHEADS

Description	Model	Cherry		W	D	H	Doors	Shipping Weight	Cubic Feet
		Rift Oak Palette	Maple Walnut						
Double Wall Mounted Overhead with Wood Doors	76OHW361630 76OHW421630 76OHW481630*	1598 1668 1789	1678 1748 1869	35.75 41.75 47.75	15.75 15.75 15.75	29.5 29.5 29.5	2 2 3	100 112 130	12 14.5 16



Double Wall Mounted Overhead with Frosted Glass Doors	76OHW361630X 76OHW421630X* 76OHW481630X	1920 2104 2253	2016 2210 2366	35.75 41.75 47.75	15.75 15.75 15.75	29.5 29.5 29.5	2 2 3	100 112 130	12 14.5 16
---	---	----------------------	----------------------	-------------------------	-------------------------	----------------------	-------------	-------------------	------------------



Double Height Overhead with Paper Manager	76OHPMW361633 76OHPMW421633 76OHPMW481633*	2080 2166 2313	2184 2274 2430	35.75 41.75 47.75	15.75 15.75 15.75	33 33 33	2 2 3	90 111 136	14 16.25 18.25
---	--	----------------------	----------------------	-------------------------	-------------------------	----------------	-------------	------------------	----------------------



Double Height Overhead with Glass Doors and Paper Manager	76OHPMW361633X 76OHPMW421633X 76OHPMW481633X*	2493 2601 2773	2618 2732 2912	35.75 41.75 47.75	15.75 15.75 15.75	33 33 33	2 2 3	90 111 136	14 16.25 18.25
---	---	----------------------	----------------------	-------------------------	-------------------------	----------------	-------------	------------------	----------------------



### ORDERING NOTES

Fluorescent tasklights come standard with all overheads. L.E.D. tasklights are available, please see page 72 for the upcharge price.

### ORDERING PROCEDURE

To order, please specify the following:

- 1) Krug product model number
- 2) Wood species and finish, see Page 11
- 3) Wood edge detail- I, H, L or P, see Page 3
- 4) Pull style, see Page 4
- 5) Grommet location if applicable

### CODE DESCRIPTION

X - silver metallic framed frosted glass doors

### STANDARD FINISHES

For a complete list of standard wood finishes please see Page 117.

### GROMMETS

One grommet in standard position is optional at no charge. Additional rectangular grommets are available at an upcharge of **\$152 list.**

# ARTEMIS | OVERHEADS & WALL MOUNTED TACKBOARDS

Description	Model	Cherry		W	D	H	Doors	Shipping Weight	Cubic Feet
		Rift Oak Palette	Maple Walnut						
	76OSW481630	2220	2332	47.75	16	30	1	1221	17
	76OSW601630	2422	2545	59.75	16	30	1	158	20.5
	76OSW661630*	2684	2819	65.75	16	30	1	175	22.5
	76OSW721630	2944	3092	71.5	16	30	1	194	24.5
	76OSW781630	3090	3244	77.5	16	30	2	211	26.5
	76OSW841630	3161	3319	83.5	16	30	2	230	28.5
	76OSW961630	3847	4039	95.5	16	30	2	256	32.5

	76OSW481630Z	2827	2968	47.75	16	30	1	122	17
	76OSW601630Z	3177	3336	59.75	16	30	1	158	20.5
	76OSW661630Z*	3533	3709	65.75	16	30	1	175	22.5
	76OSW721630Z	3886	4080	71.5	16	30	1	194	24.5
	76OSW781630Z	5205	5466	77.5	16	30	2	211	26.5
	76OSW841630Z	5373	5642	83.5	16	30	2	230	28.5
	76OSW961630Z	6224	6536	95.5	16	30	2	256	32.5

**ORDERING NOTES:** L.E.D. tasklights come standard on all sliding door overheads. Fluorescent lights are not available on sliding door overheads.

Description	Model	Tasklight Count									W	H	COM	WT
		1	2	3	4	5	6	7	8	9				
Wall Mounted Tackboard	76TBOHW3624	302	420	446	561	680	791	912	1058	1252	35.75	24	1.5	1.75
	76TBOHW4224	337	454	480	596	716	824	948	1090	1286	35.75	24	1.5	2.25
	76TBOHW4824	376	465	487	613	733	840	971	1117	1341	47.75	24	1.75	2.25
	76TBOHW6024	426	568	596	648	764	1058	1222	1387	1647	59.75	24	2	3
	76TBOHW6624*	465	634	677	827	989	1178	1338	1529	1821	65.75	24	2	3.25
	76TBOHW7224	512	783	816	1084	1332	1348	1547	1767	2058	71.75	24	2.25	3.5
Wall Mounted Tackboard for 3/4 Height Credenzas	76TBOHW3630	379	422	464	531	691	844	995	1158	1360	35.75	30	1.5	2.25
	76TBOHW4230	422	567	599	744	895	1032	1181	1394	1609	42.75	30	1.5	2.5
	76TBOHW4830	470	583	610	765	917	1053	1212	1394	1677	47.75	30	1.75	3
	76TBOHW6030	533	710	744	928	1116	1318	1528	1734	2061	59.75	30	2	3.5
	76TBOHW6630*	583	793	848	661	1240	1474	1672	1913	2279	65.75	30	2	4
	76TBOHW7230	640	981	1021	1355	1664	1686	1934	2206	2570	71.75	30	2.25	4.5
Wall Mounted Tackboard for Overheads with Paper Management	76TBOHPMW3620	380	423	465	533	693	846	1001	1164	1370	35.75	20	1.25	2.25
	76TBOHPMW4220	423	522	602	747	898	1036	1190	1371	1615	42.75	20	1.25	2.5
	76TBOHPMW4820	471	585	613	767	921	1058	1220	1403	1688	47.75	20	1.5	3
	76TBOHPMW5420	502	648	679	849	1019	1193	1434	1572	1881	53.75	20	1.75	3.5
	76TBOHPMW6020	535	714	747	931	1120	1328	1535	1745	2072	59.75	20	1.75	3.5
	76TBOHPMW6620*	586	798	852	1038	1245	1481	1680	1922	2291	65.75	20	2	4
76TBOHPMW7220	643	984	1027	1359	1671	1693	1944	1922	2291	71.75	20	2	4.5	

LED Light Upcharges	Model	Price
	36"- 48" Overhead/ Hutch	236
	54"- 84" Overhead/ Hutch	246
	90"-108" Overhead/ Hutch	473
	120"- 144" Overhead/Hutch	494

**ORDERING NOTES:**  
L.E.D. can replace the standard task light on both overheads and hutches. Please note clearly on purchase order.

**DIMENSION KEY**  
W - width  
D - depth  
H - height

**CODE DESCRIPTION**  
Z - back painted glass doors

**STANDARD FINISHES**  
For a complete list of standard wood finishes please see Page 117.

# ARTEMIS | WALL MOUNTED BACK-PAINTED GLASS

Description	Model	Price	W	D	H	Shipping Weight	Cubic Feet	
	Wall Mounted Back Painted Glass 23.5"	76GPW3624	1765	35.75	-	23.5	48	1.5
	76GPW4224	1852	41.75	-	23.5	56	1.75	
	76GPW4824	1936	47.75	-	23.5	64	2	
	76GPW5424	2023	53.75	-	23.5	72	2.25	
	76GPW6024	2136	59.75	-	23.5	80	2.5	
	76GPW6624*	2295	65.75	-	23.5	88	2.75	
	76GPW7224	2452	71.5	-	23.5	96	3	
	76GPW7824	2638	77.5	-	23.5	104	3.25	
	76GPW8424	2810	83.5	-	23.5	112	3.5	
	76GPW9024	3255	89.5	-	23.5	120	3.75	
76GPW9624	3384	95.5	-	23.5	128	4		

**ORDERING NOTES:** Use between wall mounted Overheads and Full Height Credenza.

	Wall Mounted Back Painted Glass 30"	76GPW3630	2108	35.75	-	30	60	2
	76GPW4230	2221	41.75	-	30	70	2.25	
	76GPW4830	2323	47.75	-	30	80	2.5	
	76GPW5430	2410	53.75	-	30	90	2.75	
	76GPW6030	2567	59.75	-	30	100	3.25	
	76GPW6630*	2984	65.75	-	30	110	3.5	
	76GPW7230	3184	71.5	-	30	120	3.75	
	76GPW7830	3428	77.5	-	30	130	4	
	76GPW8430	3628	83.5	-	30	140	4.25	
	76GPW9030	3798	89.5	-	30	150	4.75	
76GPW9630	3798	95.5	-	30	160	5		

**ORDERING NOTES:** Use between wall mounted Overheads and 3/4 Height Credenzas.

	Magnetic Back Painted Glass 23.5"	76GPW3624M	1936	35.75	-	23.5	48	1.5
	76GPW4224M	2053	41.75	-	23.5	56	1.75	
	76GPW4824M	2166	47.75	-	23.5	64	2	
	76GPW5424M	2280	53.75	-	23.5	72	2.25	
	76GPW6024M	2422	59.75	-	23.5	80	2.5	
	76GPW6624M*	2625	65.75	-	23.5	88	2.75	
	76GPW7224M	2824	71.5	-	23.5	96	3	
	76GPW7824M	3055	77.5	-	23.5	104	3.25	
	76GPW8424M	3269	83.5	-	23.5	112	3.5	
	76GPW9024M	3757	89.5	-	23.5	120	3.75	
76GPW9624M	3930	95.5	-	23.5	128	4		

**ORDERING NOTES:** Use between wall mounted Overheads and Full Height Credenza. Please note that magnets are not supplied.

	Magnetic Back Painted Glass 30"	76GPW3630M	2323	35.75	-	30	60	2
	76GPW4230M	2465	41.75	-	30	70	2.25	
	76GPW4830M	2595	47.75	-	30	80	2.5	
	76GPW5430M	2723	53.75	-	30	90	2.75	
	76GPW6030M	2911	59.75	-	30	100	3.25	
	76GPW6630M*	3156	65.75	-	30	110	3.5	
	76GPW7230M	3412	71.5	-	30	120	3.75	
	76GPW7830M	3656	77.5	-	30	130	4	
	76GPW8430M	3941	83.5	-	30	140	4.25	
	76GPW9030M	4186	89.5	-	30	150	4.75	
76GPW9630M	4401	95.5	-	30	160	5		

**ORDERING NOTES:** Use between wall mounted Overheads and 3/4 Height Credenzas. Please note that magnets are not supplied.

## ORDERING PROCEDURE

To order, please specify the following:

- 1) Krug product model number
- 2) Wood species and finish, see Page 11
- 3) Wood edge detail- I, H, L or P, see Page 3
- 4) Pull style, see Page 4
- 5) Grommet location if applicable

## CODE DESCRIPTION

M- magnetic back-painted glass

## BACK PAINTED GLASS

Standard finish is white

**ARTEMIS | HUTCHES**

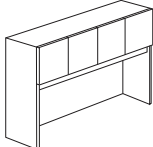
Description	Model	Cherry		W	D	H	Tackboard Height	Shipping Weight	Cubic Feet
		Rift Oak Palette	Maple Walnut						
 5 Hi Hutch with Wood Doors	76HT601640	2707	2842	59.75	30	39.5	23.5	167	24.5
	76HT661640	2881	3027	65.75	15.75	39.5	23.5	181	28.5
	76HT721640	3292	3456	71.75	15.75	39.5	23.5	193	31
	76HT781640*	3547	3727	77.75	15.75	39.5	23.5	206	33.5
	76HT841640	3803	3993	83.75	15.75	39.5	23.5	219	36
	76HT961640	3866	4060	96	16	39.5	23.5	247	43
	76HT1021640	4728	4965	102	16	39.5	23.5	296	43
	76HT1081640	4908	5154	108	16	39.5	23.5	310	58.5

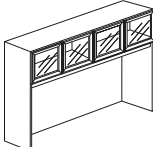
 5 Hi Hutch with Frosted Glass Doors	76HT601640X	3032	3180	59.75	16	39.5	23.5	167	24.5
	76HT661640X	3224	3386	65.75	15.75	39.5	23.5	181	28.5
	76HT721640X	3688	3873	71.75	15.75	39.5	23.5	193	31
	76HT781640X*	3975	4173	77.75	15.75	39.5	23.5	208	33.5
	76HT841640X	4261	4473	83.75	15.75	39.5	23.5	219	36
	76HT961640X	4331	4540	96	16	39.5	23.5	247	43
	76HT1021640X	5295	5549	102	16	39.5	23.5	296	43
	76HT1081640X	5498	5765	108	16	39.5	23.5	310	58.5

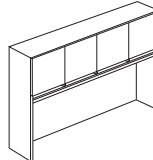
 5 Hi Hutch with Wood Doors and Paper Manager	76HTPM601640	3330	3497	59.75	16	39.5	20.5	186	24.5
	76HTPM661640	3552	3728	65.75	15.75	39.5	20.5	199	28.5
	76HTPM721640	4059	4261	71.75	15.75	39.5	20.5	214	31
	76HTPM781640*	4120	4328	77.75	15.75	39.5	20.5	228	33.5
	76HTPM841640	4185	4395	83.75	15.75	39.5	20.5	242	36
	76HTPM961640	4756	4994	96	16	39.5	20.5	276	43

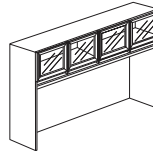
 5 Hi Hutch with Frosted Glass Doors and Paper Manager	76HTPM601640X	3732	3918	59.75	16	39.5	20.5	186	24.5
	76HTPM661640X	3978	4177	65.75	15.75	39.5	20.5	199	28.5
	76HTPM721640X	4545	4773	71.75	15.75	39.5	20.5	214	31
	76HTPM781640X*	4616	4846	77.75	15.75	39.5	20.5	228	33.5
	76HTPM841640X	4690	4924	83.75	15.75	39.5	20.5	242	36
	76HTPM961640X	5328	5595	96	16	39.5	20.5	276	43

**ORDERING NOTES:** Fluorescent tasklights and grade 1 tackboards come standard with all hutches. L.E.D. tasklights are available, please see page 72 for upcharge price. To specify a Voice/Power/Data module with any hutch, please add "W" at the end of the model number and a **\$252 list** upcharge.

**DIMENSION KEY**

W - width  
D - depth  
H - height

**CODE DESCRIPTION**

X - silver metallic framed frosted glass doors

**STANDARD FINISHES**

For a complete list of standard wood finishes please see Page 117.

# ARTEMIS | HUTCHES

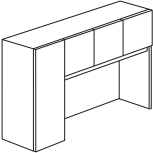
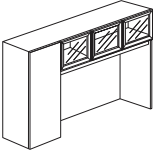
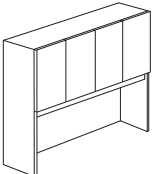
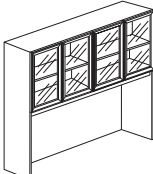
Description	Model	Rift Oak Palette	Cherry Maple Walnut	W	D	H	Tackboard Height	Shipping Weight	Cubic Feet
5 Hi Hutch Single Pier with Wood Doors on Overhead  	76HTPR661640LOOHR11	3710	3894	65.75	16	39.5	23.5	202	26.75
	76HTPR661640L11OHR0	3710	3894	65.75	16	39.5	23.5	202	26.75
	76HTPR721640L11OHR0*	3952	4147	71.75	15.75	39.5	23.5	215	31
	76HTPR721640LOOHR11	3952	4147	71.75	15.75	39.5	23.5	215	31
	76HTPR781640L11OHR0	4258	4469	77.75	15.75	39.5	23.5	233	33.5
	76HTPR781640LOOHR11	4258	4469	77.75	15.75	39.5	23.5	233	33.5
	76HTPR841640L11OHR0	4564	4793	83.75	15.75	39.5	23.5	251	36
	76HTPR841640LOOHR11	4564	4793	83.75	15.75	39.5	23.5	251	36
	76HTPR961640LOOHR11	4897	5141	96	16	39.5	23.5	266	43
	76HTPR961640L11OHR0	4897	5141	96	16	39.5	23.5	266	43
5 Hi Hutch Single Pier with Frosted Glass Doors on Overhead  	76HTPR661640LOOHR11X	4155	4363	65.75	16	39.5	23.5	202	26.75
	76HTPR661640L11XOHR0	4155	4363	65.75	16	39.5	23.5	202	26.75
	76HTPR721640L11OHXR0*	4189	4398	71.75	15.75	39.5	23.5	215	31
	76HTPR721640LOOHXR11	4189	4398	71.75	15.75	39.5	23.5	215	31
	76HTPR781640L11OHXR0	4496	4712	77.75	15.75	39.5	23.5	233	33.5
	76HTPR781640LOOHXR11	4496	4712	77.75	15.75	39.5	23.5	233	33.5
	76HTPR841640L11OHXR0	4799	5038	83.75	15.75	39.5	23.5	251	36
	76HTPR841640LOOHXR11	4799	5038	83.75	15.75	39.5	23.5	251	36
	76HTPR961640LOOHR11X	5483	5758	96	16	39.5	23.5	266	43
	76HTPR961640L11XOHR0	5483	5758	96	16	39.5	23.5	266	43
6 Hi Hutch with Wood Doors  	76HT601653	2789	2928	59.75	16	53	23.5	231	32.5
	76HT661653*	3028	3179	65.75	15.75	53	23.5	250	37.75
	76HT721653	3439	3610	71.75	15.75	53	23.5	268	41
	76HT781653	3718	3904	77.75	15.75	53	23.5	287	44.5
	76HT841653	3995	4196	83.75	15.75	53	23.5	305	47.75
	76HT961653	4162	4370	96	16	53	23.5	354	56
6 Hi Hutch with Frosted Glass Doors  	76HT601653X	3126	3280	59.75	16	53	23.5	231	32.5
	76HT661653X*	3381	3547	65.75	15.75	53	23.5	250	37.75
	76HT721653X	3846	4038	71.75	15.75	53	23.5	268	41
	76HT781653X	4131	4337	77.75	15.75	53	23.5	287	44.5
	76HT841653X	4417	4637	83.75	15.75	53	23.5	305	47.75
	76HT961653X	4664	4897	96	16	53	23.5	354	56

**ORDERING NOTES:** To specify a Voice/Power/Data module with any hutch, please add "W" at the end of the model number and a **\$252 list** upcharge.

### ORDERING PROCEDURE

To order, please specify the following:

- 1) Krug product model number
- 2) Wood species and finish, see Page 11
- 3) Wood edge detail- I,H, L or P, see Page 3
- 4) Pull style, see Page 4
- 5) Grommet location if applicable

### CODE DESCRIPTION

- X - silver metallic framed frosted glass doors
- L - left handed position
- R - right handed position
- 0 - no pier
- 11 - closed door wood pier

### STANDARD FINISHES

For a complete list of standard wood finishes please see Page 117.

# ARTEMIS | HUTCHES

Description	Model	Cherry		W	D	H	Tackboard Height	Shipping Weight	Cubic Feet
		Rift Oak Palette	Maple Walnut						
6 Hi Hutch with Wood Doors and Paper Manager	76HTPM661653*	3710	3894	65.75	15.75	53	20.25	269	37.75
	76HTPM721653	4221	4432	71.75	15.75	53	20.25	289	41
	76HTPM781653	4281	4494	77.75	15.75	53	20.25	298	44.5
	76HTPM841653	4340	4558	83.75	15.75	53	20.25	328	47.75

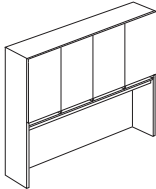

6 Hi Hutch with Frosted Glass Doors and Paper Manager	76HTPM661653X*	4131	4337	65.75	15.75	53	20.25	269	37.75
	76HTPM721653X	4692	4928	71.75	15.75	53	20.25	289	41
	76HTPM781653X	4773	5010	77.75	15.75	53	20.25	298	44.5
	76HTPM841653X	4848	5093	83.75	15.75	53	20.25	328	47.75

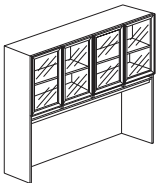

6 Hi Hutch Single Pier with Wood Doors on Overhead	76HTPR721653L11OHR0*	4131	4337	71.75	15.75	53	23.5	294	41
	76HTPR721653L0OHR11	4131	4337	71.75	15.75	53	23.5	294	41
	76HTPR781653L11OHR0	4437	4658	77.75	15.75	53	23.5	303	44.5
	76HTPR781653L0OHR11	4437	4658	77.75	15.75	53	23.5	303	44.5
	76HTPR841653L11OHR0	4746	4984	83.75	15.75	53	23.5	312	47.75
	76HTPR841653L0OHR11	4746	4984	83.75	15.75	53	23.5	312	47.75

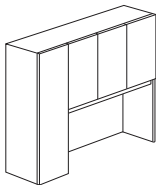

6 Hi Hutch Single Pier with Frosted Glass Doors on Overhead	76HTPR721653L11OHXR0*	4429	4652	71.75	15.75	53	23.5	294	41
	76HTPR721653L0OHXR11	4429	4652	71.75	15.75	53	23.5	294	41
	76HTPR781653L11OHXR0	4722	4959	77.75	15.75	53	23.5	303	44.5
	76HTPR781653L0OHXR11	4722	4959	77.75	15.75	53	23.5	303	44.5
	76HTPR841653L11OHXR0	5016	5267	83.75	15.75	53	23.5	312	47.75
	76HTPR841653L0OHXR11	5016	5267	83.75	15.75	53	23.5	312	47.75

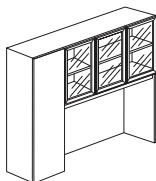

**ORDERING NOTES:** Fluorescent tasklights and grade 1 tackboards come standard with all hutches. L.E.D. tasklights are available, please see page 72 for upcharge price. Pier hutches have an option of a pull on the pier door only. To select this option, change model number from "76" to "77" ie:77HTPR841640L11OHXR0.

**DIMENSION KEY**

W - width  
D - depth  
H - height

**CODE DESCRIPTION**

X - silver metallic framed frosted glass doors  
L - left handed position  
R - right handed position  
0 - no pier  
11 - closed door wood pier  
PM - paper manager

**STANDARD FINISHES**

For a complete list of standard wood finishes please see Page 117.



# ARTEMIS | TACKBOARD UPCHARGES & PAPER MANAGERS

All hutches include a tackboard in Krug panel grade 1 fabric . Use this chart to find the upcharge for tackboard fabrics grades 2-9 and add it to the cost of the hutch. Only Krug panel fabrics are available on KrugExpress.

Description		FABRIC GRADES								COM
		2	3	4	5	6	7	8	9	
Tackboard	60" Tackboard	143	309	468	633	799	962	1131	1327	2
Upcharges for standard hutches	66" Tackboard	165	359	521	697	869	1021	1199	1487	2
	72" Tackboard	199	426	622	837	1036	1236	1437	1727	2.25
	78" Tackboard	234	500	735	974	1206	1443	1677	2003	2.5
	84" Tackboard	278	580	859	1136	1414	1690	1965	2322	2.5
	90" Tackboard	287	601	894	1179	1467	1755	2043	2415	2.75
	96" Tackboard	299	626	930	1228	1528	1827	2126	2415	3
	102" Tackboard	331	714	1048	1403	1743	2070	2433	2988	3
	108" Tackboard	363	781	1149	1536	1909	2271	2638	3273	3
	72" single pier door hutch tackboard	149	317	460	615	764	910	1059	1285	1.5
	78" single pier door hutch tackboard	149	317	460	615	764	910	1059	1285	1.5
84" single pier door hutch tackboard	165	357	521	697	868	1032	1199	1487	2	

**ORDERING NOTES:** Tasklights come standard with all hutches.

Description	Model	Rift Oak	Cherry	W	D	H	Shipping Weight	Cubic Feet
		Palette	Maple Walnut					
Paper Manager with Open Shelves	76PM18122002*	948	994	17.75	12	19.75	50	3
	76PM18122003**	960	1011	17.75	12	19.75	50	3



**ORDERING PROCEDURE**

To order, please specify the following:

- 1) Krug product model number
- 2) Wood species and finish, see Page 11
- 3) Wood edge detail- I,H, L or P, see Page 3
- 4) Pull style, see Page 4
- 5) Grommet location if applicable

**CODE DESCRIPTION**

PM - paper manager

**STANDARD FINISHES**

For a complete list of standard wood finishes please see Page 117

# ARTEMIS | PEDESTALS

Description	Model	Cherry		W	D	H	Shipping Weight	Cubic Feet
		Rift Oak Palette	Maple Walnut					
Pedestal Desk Height 2 Box, 1 File	76P16184F*	1276	1342	15.75	18	28.5	61	6.5
	76P16284F	1474	1547	15.75	27.5	28.5	66	9



Pedestal Desk Height 2 File	76P16184D*	1179	1239	15.75	18	28.5	61	6.5
	76P16284D	1374	1443	15.75	27.5	28.5	66	9



Pedestal Lateral File	76P301801*	1569	1647	30	18	28.5	104	11.5
	76P361801	1758	1845	36	18	28.5	112	13.5

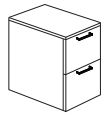

Pedestal 36" 1 File/ 2 Box & Lateral File Combination	76P361802	1729	1815	36	18	28.5	112	13.5
---	-----------	------	------	----	----	------	-----	------

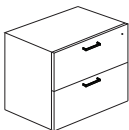

Pedestal 36" 2 Box, 1 File & Lateral File Combination	76P361804	1729	1815	36	18	28.5	112	13.5
---	-----------	------	------	----	----	------	-----	------



**ORDERING NOTES:** Unfinished top and back pedestals are to be used with desk or credenza shells.

**DIMENSION KEY**

W - width  
D - depth  
H - height

**CODE DESCRIPTION**

D - 2 file drawers  
F - 2 box, 1 file drawer  
01 - lateral file  
02 - 1 file/2 box & lateral file  
04 - 2 box, 1 file & lateral file

**STANDARD FINISHES**

For a complete list of standard wood finishes please see Page 117.

**PALETTE FINISHES**

Artemis Casegoods are available for full cases in a PALETTE finish for the same price as the Rift Oak.

# POWERPORTS

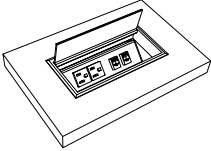
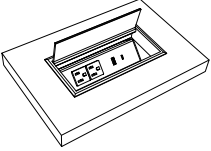
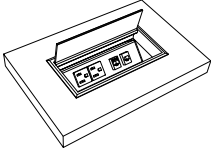
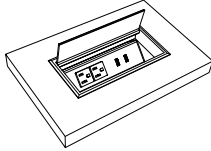
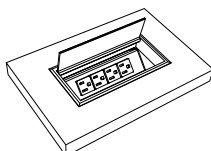
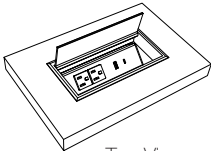
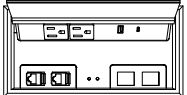
Description	Model	Price	W	D	H	Shipping Weight	Cubic Feet
PowerPort 1 - 2 RJ45s (Category 5/6)	PORT1	278	8	4	-	-	-
	<b>Port Includes:</b> 2 accessible power outlets & 1 side utility outlet powered by a 10' plug-in cord; 2 RJ45 (category 5/6) each with hard wired 10' data cords; 2 velcro wire managers and metal PowerPort shroud. PortPort lid is Silver Metallic. <b>NOTE:</b> RJ45 jacks with hard wired data cords included here must be within 10' of building utilities source to be functional.						
PowerPort 2 - USB-A & USB-C	PORT2	280	8	4	-	-	-
	<b>Port Includes:</b> 2 accessible power outlets & 1 side utility outlet; 1 USB-A & 1 USB-C charging ports all powered by a 10' plug-in cord; 2 velcro wire managers and metal PowerPort shroud. PortPort lid is Silver Metallic.						
PowerPort 3 - RJ11 & RJ45	PORT3	269	8	4	-	-	-
	<b>Port Includes:</b> 2 accessible power outlets & 1 side utility outlet; 1 RJ11 & 1 RJ45 (Category 5/6); 2 Velcro wire managers & PowerPort Shroud; 1 x 10 Foot Data Cords (T568A) & 1 x 14 Foot RJ11 (Telecomm); powered by a 10' plug-in cord. PortPort lid is Silver Metallic. <b>NOTE:</b> RJ45 & RJ11 jacks with hard wired data cords included here must be within 10' of building utilities source to be functional.						
PowerPort 4 - 2 USB-A	PORT4	286	8	4	-	-	-
	<b>Port Includes:</b> 2 accessible power outlets & 1 side utility outlet; 2- USB-A charging ports all powered by a 10' plug-in cord; 2 velcro wire managers and metal PortPort shroud. PortPort lid is Silver Metallic.						
PowerPort 5 - 4 Receptacles	PORT5	280	8	4	-	-	-
	<b>Port Includes:</b> 4 accessible power outlets & 1 side utility outlet powered by a 10' plug-in cord; 2 velcro wire managers and metal power port shroud. PortPort lid is Silver Metallic.						
PowerPort 6 - USB-A, USB-C & RJ45	PORT6	406	8	4	-	-	-
 	<b>Port Includes:</b> 2 accessible power outlets & 1 side utility outlet 1 USB-A, 1 USB-C charging ports all powered by a 10' plug-in power cord. Includes 2 velcro wire managers and metal PortPort shroud with 2 data plate knock outs, 1 #M02 plate insert & 2 #S01W RJ45 female input, punch down terminal output snap in jacks. 2nd data plate knock out is blank for future use. PortPort lid is Silver Metallic.						

# POWERPORTS

Description	Model	Price	W	D	H	Shipping Weight	Cubic Feet
Port - no Powerbar	Port0	137	8	4	-	-	-

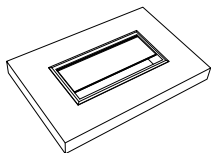

**Port Includes:** Port lid & Shroud only.

**ORDERING NOTE:** Velcro wire managers not included, see below for pricing. Port lid is Silver Metallic.

PowerPort Shroud with 2 Data Plate Knock-outs	SHROUD2KO	Must be requested - no upcharge	-	-	-	-	-
---	-----------	---------------------------------	---	---	---	---	---

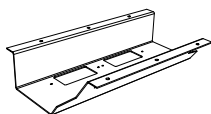

Angled PowerPort Shroud Includes: shroud with 2 data plate knock-outs in the bottom.

**ORDERING NOTE:** Please refer to data plate, data and AV integration options on page XX.

Velcro Wire Manager (qty 1)	WM-4	26	2	4.5	0.5	-	-
-----------------------------	------	----	---	-----	-----	---	---

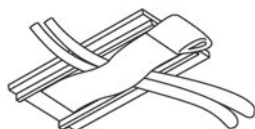

2 velcro wire managers are included with Ports 1-5.

Wire Management Trough	WM-72	182	72	3	1	-	-
------------------------	-------	-----	----	---	---	---	---



Wire Management Trough is standard in a 72" length & can be cut to specific length; double-sided tape installation.

4-Channel Wire Management	CM-72	231	72	3	1	-	-
---------------------------	-------	-----	----	---	---	---	---

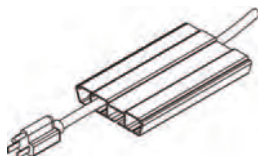

4-Channel Wire Management is standard in a 72" length & can be cut to specific length; double-sided tape installation.

Round Grommet	Round Grommet - Silver Metallic	152	-	-	-	-	-
	Round Grommet - Black	152	-	-	-	-	-



One 60mm Grommet in a standard position is available at no charge per table.

POWER/DATA

SNAP IN PORTS	Reference Code	Description	List Price
---------------	----------------	-------------	------------

**ADAPTOR PLATES**

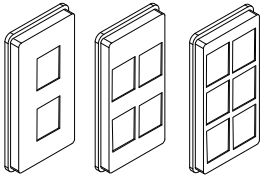

<b>M02</b>	<b>Adaptor Plate (2)</b> - accepts two snap in data ports	38
<b>M04</b>	<b>Adaptor Plate (4)</b> - accepts four snap in data ports	38
<b>M06</b>	<b>Adaptor Plate (6)</b> - accepts six snap in data ports	38

**ORDERING NOTES:** Blank covers are required when port is not in use, please see page 55.



	<b>RJ-45</b> - Category 6 data connection. This connector is also downwards compatible with Category 5 cabling. Connector is a female input with a #110 punch-down terminal block output (back side of Console interface) for on-site hard wire connection.	47
<b>S01W</b>	RJ45-CAT6 (White)	
<b>S01B</b>	RJ45-CAT6 (Blue)	
<b>S01R</b>	RJ45-CAT6 (Red)	

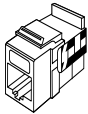

	<b>RJ11</b> - Telephone type connection. Connector is a female input with a #110 punch-down terminal block output (back side of Console interface) for on-site hard wire connection.	32
<b>S02W</b>	RJ11 (White)	
<b>S02B</b>	RJ11-B (Black)	
<b>S02G</b>	RJ11-G (Green)	
<b>S02R</b>	RJ11-R (Red)	
<b>S02Y</b>	RJ11-Y (Yellow)	

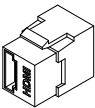

<b>S04</b>	<b>HDMI</b> - High Definition Multimedia Interface connection. Connector carries both HD audio and video data. Connector is a female-to-female pass through.	173
------------	--	-----

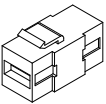

<b>S08</b>	<b>USB-A</b> - Full size USB "A" style connection. Connector is a female-to-female pass through.	61
------------	--	----

Description	Model	Price	W	D	H	Shipping Weight	Cubic Feet
Power Data Module	76PVDM	226	6.25	3.25	-	1	0.25



Height Adjustable Table Programmable Display- 4 Position Memory	88HAPD	376	-	-	-	-	-
---	--------	-----	---	---	---	---	---



## ARTEMIS | ACCESSORIES &amp; CABLE MANAGEMENT

Description	Model	Price	W	D	H	Shipping Weight	Cubic Feet
Keyboard Tray for Standard Units	76KBAMT1912*	411	28	-	8.25	20	20
	76KBAMT1912S	483	28	-	8.25	20	20



Keyboard Tray for Angled & Curved Units	76KBAMT1912X	428	28	-	8.25	20	20
---	--------------	-----	----	---	------	----	----



**ORDERING NOTES:** Must be used on Corner Desk or Corner Credenzas.

Pencil Drawer	76PD2119*	295	21	19	2	2	1
	76PD2119S	331	21	19	2	2	1

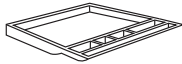

**ORDERING NOTES:** Pencil drawer is black in color.

Pencil Cup	76APH	193				1	0.25
------------	-------	-----	--	--	--	---	------



**ORDERING NOTES:** Pencil Cup is Silver Metallic in color.

Silver Metallic Trough	76CT36	59	-	-	-	0.25	-
	76CT42	74	-	-	-	0.25	-
	76CT48	91	-	-	-	0.25	-
	76CT54	105	-	-	-	0.5	-
	76CT60	121	-	-	-	0.5	-
	76CT66	137	-	-	-	0.5	-
	76CT72	152	-	-	-	0.75	-
	76CT84	168	-	-	-	0.75	-



Height Adjustable Work Surface Cable Manager	88HACM1	89	4	3	21.5	5	0.25
--	---------	----	---	---	------	---	------

**DIMENSION KEY**

W - width  
D - depth  
H - height

# ARTEMIS | BOOKCASES

Description	Model	Rift Oak/ Palette	Cherry Maple Walnut	W	D	H	Shipping Weight	Cubic Feet
3 Hi Bookcase	76BC361642	1929	2028	36	16	42	103	17.5

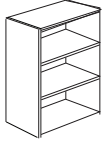

4 Hi Bookcase Open Shelves	76BC301655*	1966	2063	30	15.75	55.25	64	18
	76BC361655	2010	2109	36	15.75	55.25	72	21.75

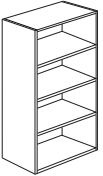

5 Hi Bookcase Open Shelves	76BC301669*	2131	2238	30	15.75	69	100	22.75
	76BC361669	2173	2282	36	15.75	69	112	27

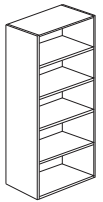

6 Hi Bookcase	76BC301683*	2502	2636	30	16	82.75	163	28.25
	76BC361683	2560	2686	36	16	82.75	-	28



## ORDERING PROCEDURE

To order, please specify the following:

- 1) Krug product model number
- 2) Wood species and finish, see Page 11
- 3) Wood edge detail- I, H, L or P, see page 3
- 4) Pull style, see Page 4
- 5) Grommet location if applicable

## STANDARD FINISHES

For a complete list of standard wood finishes please see Page 117.

# ARTEMIS | 1.5 HI & 2 HI STORAGE

Description	Model	Rift Oak or	Rift Oak or	C,M,W w/		W	D	H	Shipping Weight	Cubic Feet
		Palette w/ Lam Top & Polymer Edge	Wood or Lam Top & Wood Edge	C,M,W w/ Lam Top & Polymer Edge	Wood or Lam Top & Wood Edge					
1.5 Hi Storage Unit, Closed Bookcase	76ST30242311*	1840	1896	1932	1990	30	24	23	87	46.5
	76ST36242311	1988	2043	2083	2139	36	24	23	115.5	50.25



1.5 Hi Storage Unit, Box/Lateral File	76ST30242316	2149	2214	2257	2326	30	24	23	115.75	54.5
	76ST36242316*	2301	2368	2415	2487	36	24	23	75	11.75



1.5 Hi Storage Unit, Open Bookcase	76ST30242317	1647	1699	1732	1782	30	24	23	98	11.75
	76ST36242317*	1781	1837	1871	1927	36	24	23	101.25	16.25



2 Hi Storage Unit Closed Bookcase	76ST36202911*	1911	1967	2004	2064	36	20	29.5	104	14.75
	76ST36242911	1949	2007	2046	2107	36	24	29.5	108	17.5



2 Hi Storage Unit Lateral File	76ST30202901	2230	2298	2341	2412	30	20	29.5	205	11.5
	76ST30242901*	2340	2410	2458	2530	30	24	29.5	222	13.75
	76ST36202901	2518	2593	2642	2721	36	20	29.5	116	14.75
	76ST36242901	2552	2630	2680	2760	36	24	29.5	120	17.5



2 Hi Bookcase Open Shelves	76BC301629*	1539	1588	1618	1666	30	15.75	29.5	48	10
	76BC361629	1583	1632	1662	1712	36	15.75	29.5	56	12



**DIMENSION KEY**

W - width  
D - depth  
H - height

**CODE DESCRIPTION**

11 - closed bookcase  
16 - box/lateral file  
17 - open bookcase  
01 - 2 lateral files

**STANDARD FINISHES**

For a complete list of standard wood finishes please see Page 117.

**PALETTE FINISHES**

Artemis Caseloads are available for full cases in a PALETTE finish for the same price as the Rift Oak with Polymer Edge column in the price guide.



# ARTEMIS | STORAGE

Description	Model	Cherry		W	D	H	Shipping Weight	Cubic Feet
		Rift Oak/ Palette	Maple Walnut					
3 Hi Storage Units,	76ST36204201	3378	3545	36	20	29.5	175	25.25
Lateral Files	76ST36244201*	3452	3624	36	24	29.5	187	30



4 Hi Storage Unit	76ST30205501	3164	3322	30	20	55.25	218	16
Lateral File	76ST36205501*	3560	3738	36	20	55.25	176	27
	76ST36245501	3786	3975	36	24	55.25	196	32



5 Hi, 19", Storage Unit Closed Shelves	76ST19246911L*	3076	3231	18.75	24	69	132	21.75
	76ST19246911R	3076	3231	18.75	24	69	132	21.75

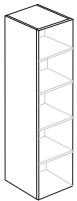

5 Hi, 19", Storage Unit 2 File, 3 Open Shelves	76ST19246990	3112	3267	18.75	24	69	132	21.75
--	--------------	------	------	-------	----	----	-----	-------

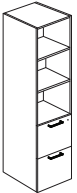

5 Hi, 19", Storage Unit 2 File, 3 Closed Shelves	76ST19246991L*	3336	3501	18.75	24	69	132	21.75
	76ST19246991R	3336	3501	18.75	24	69	132	21.75

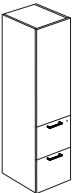

**ORDERING NOTES:** Storage units have the option of pulls instead of the standard touch latch doors. To select this option, please change the prefix in the model number from "76" to "77" ie: 77WR36246901. Please refer to Page 4 for pull orientation above and below the worksurface.

### ORDERING PROCEDURE

To order, please specify the following:

- 1) Krug product model number
- 2) Wood species and finish, see Page 11
- 3) Wood edge detail- I,H, L or P, see Page 3
- 4) Pull style, see Page 4
- 5) Grommet location if applicable

### CODE DESCRIPTION

- 01 - lateral files
- L - door hinged left
- R - door hinged right
- 11 - closed shelves
- 90 - 2 file, 3 open shelves
- 91 - 2 file, 3 closed shelves

### STANDARD FINISHES

For a complete list of standard wood finishes please see Page 117.

### LOCKS

Locks are available on wood doors for an upcharge of **\$152 list**.

# ARTEMIS | STORAGE

Description	Model	Finish		W	D	H	Shipping Weight	Cubic Feet
		Rift Oak/ Palette	Cherry Maple Walnut					
5 Hi Storage Unit - 2 Lateral File, 3 Open Shelves	76ST36206903*	3881	4074	36	20	69	180	33.5
	76ST36246903	3927	4119	36	24	69	188	39.75



5 Hi Storage Unit - 2 Lateral File, 3 Closed Shelves	76ST30246904	3743	3931	30	24	69	240	31.25
	76ST36206904*	4332	4547	36	20	69	192	33.5
	76ST36246904	4381	4600	36	24	69	200	39.75

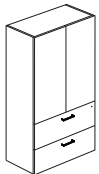

5 Hi Storage Unit 2 Lateral File, 3 Closed Shelves, Frosted Glass Doors	76ST36206904X*	4590	4818	36	20	69	192	33.5
	76ST36246904X	4643	4874	36	24	69	200	39.75

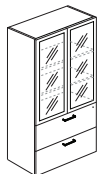

5 Hi Storage Unit 2 Closed, 3 Open Shelves	76ST36206913	3104	3260	36	20	69	104	33.5
	76ST36246913*	3140	3295	36	24	69	116	39.75

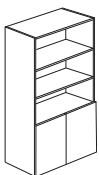

5 Hi Storage Unit 3 Lateral File, 2 Closed Shelves	76ST36246908	4816	5056	36	24	69	192	39.75
--	--------------	------	------	----	----	----	-----	-------

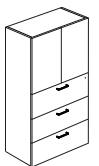

**ORDERING NOTES:** Storage units have the option of pulls instead of the standard touch latch doors. To select this option, please change the prefix in the model number from "76" to "77" ie: 77WR36246901. Please refer to Page 4 for pull orientation above and below the worksurface.

**DIMENSION KEY**

W - width  
D - depth  
H - height

**CODE DESCRIPTION**

03 - 2 lateral File, 3 open shelves  
04 - 2 lateral File, 3 closed shelves  
13 - 2 closed, 3 open shelves  
08 - 3 lateral File, 2 closed shelves  
X - silver metallic framed frosted glass doors

**STANDARD FINISHES**

For a complete list of standard wood finishes please see Page 117.

**LOCKS**

Locks are available on wood doors for an up-charge of **\$152 list**.

# ARTEMIS | STORAGE

Description	Model	Finish		W	D	H	Shipping Weight	Cubic Feet
		Rift Oak/ Palette	Cherry Maple Walnut					
6 Hi Storage Unit	76ST19248311L*	3356	3523	18.75	24	82.75	160	26
Closed Shelves	76ST19248311R	3356	3523	18.75	24	82.75	160	26

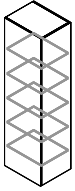

6 Hi Storage Unit 2 File, 4 Open Shelves	76ST19248390	3393	3562	18.75	24	82.75	160	26
---	--------------	------	------	-------	----	-------	-----	----

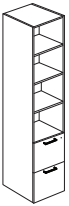

6 Hi Storage Unit	76ST19248391L*	3630	3812	18.75	24	82.75	160	26
2 File, 4 Closed Shelves	76ST19248391R	3630	3812	18.75	24	82.75	160	26



6 Hi Storage Unit 2 Lateral File, 4 Open Shelves	76ST36208303*	4035	4236	36	20	82.75	216	40
	76ST36248303	3969	4168	36	24	82.75	224	47.5

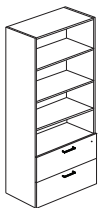

**ORDERING NOTES:** Storage units have the option of pulls instead of the standard touch latch doors. To select this option, please change the prefix in the model number from "76" to "77" ie: 77WR36246901. Please refer to Page 4 for pull orientation above and below the worksurface.

### ORDERING PROCEDURE

To order, please specify the following:

- 1) Krug product model number
- 2) Wood species and finish, see Page 11
- 3) Wood edge detail- I,H, L or P, see Page 3
- 4) Pull style, see Page 4
- 5) Grommet location if applicable

### CODE DESCRIPTION

- L - door hinged left
- R - door hinged right
- 11 - closed shelves
- 90 - 2 file, 3 open shelves
- 91 - 2 file, 3 closed shelves
- 03 - 2 lateral File, 3 open shelves

### STANDARD FINISHES

For a complete list of standard wood finishes please see Page 117.

### LOCKS

Locks are available on wood doors for an upcharge of **\$152 list**.

# ARTEMIS | STORAGE

Description	Model	Cherry		W	D	H	Shipping Weight	Cubic Feet
		Rift Oak/ Palette	Maple Walnut					
6 Hi Storage Unit 2	76ST30248304	3954	4140	30	24	82.75	228	37.5
Lateral File, 4 Closed Shelves	76ST36208304*	4355	4573	36	20	82.75	220	40
	76ST36248304	4405	4635	36	24	82.75	279	47.5

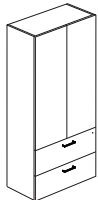

6 Hi Storage Unit 2	76ST36208304X*	4762	5000	36	20	82.75	220	40
Lateral File, 4 Closed Shelves with Frosted Glass Doors	76ST36248304X	4796	5036	36	24	82.75	228	40

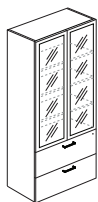

6 Hi Storage Unit 2	76ST36208313*	3246	3409	36	20	82.75	200	40
Closed, 4 Open Shelves	76ST36248313	3286	3452	36	24	82.75	208	40

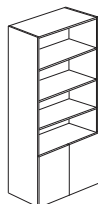

6 Hi Storage Unit 3	76ST36248308	4628	4860	36	24	82.75	220	40
Lateral File, 3 Closed Shelves								

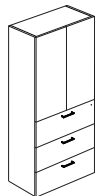

**ORDERING NOTES:** Storage units have the option of pulls instead of the standard touch latch doors. To select this option, please change the prefix in the model number from "76" to "77" ie: 77WR36246901. Please refer to Page 4 for pull orientation above and below the worksurface.

**DIMENSION KEY**

W - width  
D - depth  
H - height

**CODE DESCRIPTION**

04 - 2 lateral File, 3 closed shelves  
X - silver metallic framed frosted glass doors  
13 - 2 closed, 3 open shelves  
08 - 3 lateral File, 2 closed shelves

**STANDARD FINISHES**

For a complete list of standard wood finishes please see Page 117.

**PALETTE FINISHES**

Artemis Caseloads are available for full cases in a PALETTE finish for the same price as the Rift Oak.

# ARTEMIS | WARDROBES

Description	Model	Rift Oak/ Palette	Cherry Maple Walnut	W	D	H	Shipping Weight	Cubic Feet
5 Hi, 19" Wardrobe	76WR19246902L*	2552	2680	19	24	69	172	25.5
	76WR19246902R	2552	2680	19	24	69	172	25.5



5 Hi Wardrobe, 2 Files 3 Closed Shelves with Wood Door	76WR24246914*	3790	3980	24	24	69	260	29
	76WR24246915	3790	3980	24	24	69	260	29

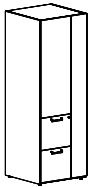

**NOTE:** Locks are available on all wood doors at **\$152 list per lock**. 24",30" & 36" wardrobes require 2 locks.

5 Hi Wardrobe with Closed Shelves	76WR30246901	2926	3071	30	24	69	240	31.25
	76WR30246903*	2926	3071	30	24	69	240	31.25
	76WR36246901	3252	3415	35.75	24	69	164	39.75
	76WR36246903	3252	3415	35.75	24	69	164	39.75

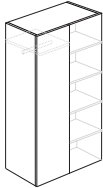

**NOTE:** Locks are available on all wood doors at **\$152 list per lock**. 24",30" & 36" wardrobes require 2 locks.

5 Hi Full Width Wardrobe	76WR36246902	2718	2853	35.75	24	69	135	39.75
--------------------------	--------------	------	------	-------	----	----	-----	-------



**NOTE:** Locks are available on all wood doors at **\$152 list per lock**. 24",30" & 36" wardrobes require 2 locks.

**ORDERING NOTES:** Wardrobes have the option of pulls instead of the standard touch latch doors. To select this option, please change the prefix in the model number from "76" to "77" ie: 77WR36246901. Please refer to Page 4 for pull orientation above and below the worksurface.

### ORDERING PROCEDURE

To order, please specify the following:

- 1) Krug product model number
- 2) Wood species and finish, see Page 11
- 3) Wood edge detail- I,H, L or P, see Page 3
- 4) Pull style, see Page 4
- 5) Grommet location if applicable

### CODE DESCRIPTION

- 02 - closed wood doors
- L - door hinged left
- R - door hinged right
- 14 - 2 Files 3 Closed Shelves, Wardrobe
- 15 - wardrobe, 2 Files 3 Closed Shelves
- 01 - closed shelves, wardrobe
- 03 - wardrobe, closed shelves

### STANDARD FINISHES

For a complete list of standard wood finishes please see Page 117.

### LOCKS

Locks are available on wood doors for an upcharge of **\$152 list**.

# ARTEMIS | WARDROBES

Description	Model	Cherry		W	D	H	Shipping Weight	Cubic Feet
		Rift Oak/ Palette	Maple Walnut					
6 Hi Wardrobe with Closed Shelves	76WR30248301	4083	4288	30	24	83	286	37.5
	76WR30248303	4083	4288	30	24	83	286	37.5
	76WR36248301*	4331	4545	36	24	83	272	44.5
	76WR36248303	4331	4545	36	24	83	272	44.5



NOTE: Locks are available on all wood doors at **\$152 list** per lock. 24",30" & 36" wardrobes require 2 locks.

6 Hi Wardrobe, 2 Files	76WR24248314*	4143	4350	24	24	83	280	35
4 Closed Shelves with Wood Door	76WR24248315	4143	4350	24	24	83	280	35

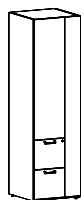

NOTE: Locks are available on all wood doors at **\$152 list per lock**. 24",30" & 36" wardrobes require 2 locks.

**ORDERING NOTES:** Wardrobes have the option of pulls instead of the standard touch latch doors. To select this option, please change the prefix in the model number from "76" to "77" ie: 77WR36246901. Please refer to Page 4 for pull orientation above and below the worksurface.

**DIMENSION KEY**

W - width  
D - depth  
H - height

**CODE DESCRIPTION**

14 - 2 Files 3 Closed Shelves, Wardrobe  
15 - wardrobe, 2 Files 3 Closed Shelves  
01 - closed shelves, wardrobe  
03 - wardrobe, closed shelves







**STANDARD FINISHES**

For a complete list of standard wood finishes please see Page 117.

**PALETTE FINISHES**

Artemis Caseloads are available for full cases in a PALETTE finish for the same price as the Rift Oak.

# ARTEMIS | BENCHES

Description	Model	Cherry		W	D	H	Shipping Weight	Cubic Feet
		Rift Oak/ Palette	Maple Walnut					
 1 Hi Bench, Lateral File	76BN30201701	2168	2278	29.75	20	17	122	7
	76BN30241701	2201	2312	29.75	24	17	118	8.25
	76BN36201701*	2221	2334	35.75	20	17	134	8.25
	76BN36241701	2255	2369	35.75	24	17	132	9.75
 1 Hi Bench, Closed Bookcase	76BN30201711	2277	2388	29.75	20	17	64	7
	76BN30241711	2308	2423	29.75	24	17	62	8.25
	76BN36201711*	2329	2447	35.75	20	17	76	8.25
	76BN36241711	2366	2486	35.75	24	17	84	9.75
 1 Hi Bench, Open Bookcase	76BN30201717	1875	1967	29.75	20	17	54	7
	76BN30241717	1902	1997	29.75	24	17	62	8.25
	76BN36201717*	1912	2007	35.75	20	17	66	8.25
	76BN36241717	1940	2035	35.75	24	17	74	9.75
 1.5 Hi Bench, Lateral Box/ Lateral File	76BN30202316	2368	2487	29.75	20	23	147	9.25
	76BN30242316	2405	2524				153	11
	76BN36202316*	2440	2562	35.75	20	23	159	11
	76BN36242316	2479	2602	35.75	24	23	167	13
 1.5 Hi Bench, Closed Bookcase	76BN30202311	2553	2681	29.75	20	23	92	9.25
	76BN30242311	2591	2719				96	11
	76BN36202311*	2642	2776	35.75	24	23	94	11
	76BN36242311	2684	2819	35.75	24	23	98	13
 1.5 Hi Bench, Open Bookcase	76BN30202317	2457	2579	29.75	20	23	82	9.25
	76BN30242317	2492	2615				86	11
	76BN36202317*	2543	2671	35.75	24	23	84	11
	76BN36242317	2579	2709	35.75	24	23	88	13

**UPHOLSTERED CUSHION UPCHARGES FOR BENCHES:** Artemis Benches come with grade 1 upholstered pad seats. COM and Grade 1 textiles can be specified at no upcharge. For Grade 2-9 textiles, use the chart below to find the upcharge and add it to the price of the bench. For Krug stocked and graded-in textiles, please use our textile cards and seating price guide.

GRADE	2	3	4	5	6	7	8	9
30" Bench	51	100	159	259	359	458	560	661
36" Bench	59	116	172	287	404	516	632	746

**ORDERING PROCEDURE**

To order, please specify the following:

- 1) Krug product model number
- 2) Wood species and finish, see Page 11
- 3) Wood edge detail- I,H, L or P, see Page 3
- 4) Pull style, see Page 4
- 5) Grommet location if applicable

**CODE DESCRIPTION**

- 01 - lateral file
- 11 - closed bookcase
- 17 - open
- 16 - box, lateral fil

**STANDARD FINISHES**

For a complete list of standard wood finishes please see Page 117.

**LOCKS**

Locks are available on wood doors for an upcharge of **\$152 list.**

# ARTEMIS | MODULAR COMPONENTS

Description	Model	Wood Finish		W	D	H	Shipping	
		Rift Oak/ Palette	Cherry Maple Walnut				Wght	Cubic Feet
 Pedestals w/ht FinishedBack	76PFB16204F	1617	1698	15.75	20	28.5	61	6.5
	76PFB16204D	1423	1494	15.75	20	28.5	59	6.5
	76PFB16244F*	1734	1821	15.75	24	28.5	72	6.5
	76PFB16244D	1528	1606	15.75	24	28.5	70	6.5
	76PFB16304F	1840	1932	15.75	30	28.5	83	9.5
	76PFB16304D	1633	1714	15.75	30	28.5	78	9.5

 Pedestal, Finished Back & Lateral File	76PFB30202801	1871	1965	29.75	20	28	187	11.25
	76PFB30242801*	1918	2014	29.75	24	28	190	13.5
	76PFB36202801	1999	2100	35.75	20	28	187	11.25
	76PFB36242801	2035	2138	35.75	24	28	190	13.5

 Pedestal, Finished Back, Closed Book case	76PFB302028BC	1647	1732	29.75	20	28	712	13.25
	76PFB302428BC*	1705	1790	29.75	24	28	174	16
	76PFB362028BC	1705	1790	29.75	24	28	174	16
	76PFB362428BC	1760	1846	35.75	24	28	174	16

 Combination Pedestal, Finished Back	76PFB36202802	2198	2310	35.75	20	28	178	13.5
	76PFB36202804	2198	2310	35.75	20	28	178	13.5
	76PFB36242802*	2240	2353	35.75	24	28	162	16
	76PFB36242804	2240	2353	35.75	24	28	162	16

**ORDERING NOTES:**

Artemis includes a range of standard components for creating modular and reconfigurable units that are non-handed, and adaptable to changing needs. Non standard modular components can also be specified. In addition, a number of the desk, credenza and return models in the pricelist-aswell as non standard models and sizes-carbe quoted and ordered as KD(Knockdown)units, please contact Customer Service for assistance in specifying and pricing modular and KD components. Standard modular pedestals are not to be used with desk or credenza shells due to hardware clearance, these can easily be configured with modular tops and supports.

**DIMENSION KEY**

W - width  
D - depth  
H - height

**CODE DESCRIPTION**

D - 2 file drawers  
F - 2 box, 1 file drawer  
01 - lateral file  
BC - bookcase  
02 - 1 1/2 box & lateral file  
04 - 2 box, 1 file & lateral file

**STANDARD FINISHES**

For a complete list of standard wood finishes please see Page 117.

**PALETTE FINISHES**

Artemis Casegoods are available for full cases in a PALETTE finish for the same price as the Rift Oak with Polymer Edge column in the price guide.



# ARTEMIS | MODULAR COMPONENTS

Description	Model	Rift Oak or Palette w/ Lam Top & Polymer Edge	Rift Oak or Palette w/ Wood or Lam Top & Wood Edge	C,M,W w/ Lam Top & Polymer Edge	C,M,W w/ Wood or Lam Top & Wood Edge	W	D	H	Shipping Weight	Cubic Feet
	76MP161927F*	1288	1328	1356	1384	15.75	18.5	26.75	82	6.5
	76MP161927D	1336	1377	1404	1446	15.75	18.5	26.75	82	6.5
	76MP162827F	1543	1590	1622	1669	15.75	28	26.75	112	9
	76MP162827D	1615	1664	1695	1747	15.75	28	26.75	112	9

Description	Model	Rift Oak/ Palette	Cherry Maple Walnut	W	D	H	Shipping Weight	Cubic Feet
	76LB2029L	651	685	17	20	29.5	55	2
	76LB2029R	651	685	17	20	29.5	55	2
	76LB2429L	689	723	17	24	29.5	60	3
	76LB2429R	689	723	17	24	29.5	60	3
	76LB3029L	731	766	17	30	29.5	70	3.5
	76LB3029R	731	766	17	30	29.5	70	3.5
	76LB3629L	769	807	17	30	29.5	76	4
	76LB3629R	769	807	17	30	29.5	76	4

Description	Model	310	327	28	0.75	28.5	22	1.5
	76MP60	310	327	28	0.75	28.5	22	1.5
	76MP66	328	344	34	0.75	28.5	26	4.5
	76MP72	366	382	40	0.75	28.5	30	5
	76MP78	423	437	46	0.75	28.5	30	5
	76MP84	547	564	52	0.75	28.5	28.5	3.25
	76MP90	614	643	58	0.75	28.5	29	3.75
	76MP96	645	677	64	0.75	28.5	32	4

**ORDERING NOTES:**

Artemis includes a range of standard components for creating modular and reconfigurable units that are non-handed, and adaptable to changing needs. Non standard modular components can also be specified. In addition, a number of the desk, credenza and return models in the price list-as well as non standard models and sizes-can be quoted and ordered as KD (Knockdown) units, please contact Customer Service for assistance in specifying and pricing modular and KD components.

**ORDERING PROCEDURE**

To order, please specify the following:

- 1) Krug product model number
- 2) Wood species and finish, see Page 11
- 3) Wood edge detail- I,H, L or P, see Page 3
- 4) Pull style, see Page 4
- 5) Grommet location if applicable

**CODE DESCRIPTION**

- D - 2 file drawers
- F - 2 box, 1 file drawer
- LF - lateral file
- L - left handed position
- R - right handed position

**STANDARD FINISHES**

For a complete list of standard wood finishes please see Page 117.

**GROMMETS**

One wiring grommet in standard position is optional at no charge. See page 7 for more wiring grommet information.

# ARTEMIS | MODULAR SUPPORTS & BASES

Description	Model	Rift Oak/ Palette	Cherry Maple Walnut	W	D	H	Shipping Weight	Cubic Feet
Half Gable Desk	76HG0829	343	359	8	1.12	28.5	4	1.5
Height, Used with Modesty Panel	76HG1229	379	397	12	1.12	28.5	8	1.5



Half Gable Desk Height, Used without Modesty Panel	76HG1029NMP	488	513	8	1.12	28.5	4	1.5
--	-------------	-----	-----	---	------	------	---	-----



Panel Leg	76LG1429P1	405	424	14	1.12	28.5	8	1.5
-----------	------------	-----	-----	----	------	------	---	-----



Drum Base	76101829	744	782	18	18	28.5	97	7
	76101829WMD	1061	1114	18	18	28.5	97	7
	76102429	1152	1209	24	24	28.5	130	12
	76102429WMD	1779	1869	24	24	28.5	130	12



**ORDERING NOTES:**  
 18" Dia - 36", 42" & 48" round tops  
 24" Dia - 54" round top

Disc Base	76141828*	313		18	18	28.5	30	8
	76142428	334		24	24	28.5	40	12
	76142828	483		28	28	28.5	50	15



**ORDERING NOTES:**  
 18" - 30" round top  
 24" - 36" & 42" round top  
 28" - 48" & 54" round top

**DIMENSION KEY**

W - width  
 D - depth  
 H - height

Dimensions are in inches and approximate.  
 Contact Customer Service if dimensions are critical.



**CODE DESCRIPTION**

WMD - wire management drum

**STANDARD FINISHES**

For a complete list of standard wood finishes please see Page 117.

# ARTEMIS | MODULAR TOPS

Description	Model	Rift Oak or Lam Top & Polymer Edge	C,M,W w/ Lam Top & wood Edge	W	D	H	Shipping Weight	Cubic Feet	
	Round Tops	760536	1332	1440	36	36	1.13	50	5.75
		760542	1554	1677	42	42	1.13	62	7.5
		760548	1697	1836	48	48	1.13	80	9.5
		760554*	1842	1993	54	54	1.13	102	10.5
	Modular Tops	76TP3624	695	751	35.75	24	1.13	47	3
		76TP3630	782	845	35.75	30	1.13	57	3.75
		76TP3636	939	1015	35.75	36	1.13	57	3.75
		76TP4224	731	791	41.75	24	1.13	47	3
		76TP4230	819	885	41.75	30	1.13	57	3.75
		76TP4236	982	1062	41.75	36	1.13	57	3.75
		76TP4824	766	830	47.75	24	1.13	47	3
		76TP4830	857	929	47.75	30	1.13	57	3.75
		76TP4836	1032	1117	47.75	36	1.13	57	3.75
		76TP5424*	805	870	53.75	24	1.13	47	3
		76TP5430	910	984	53.75	30	1.13	57	3.75
		76TP5436	1093	1181	53.75	36	1.13	57	3.75
		76TP6020	823	890	59.75	20	1.13	40	3.25
		76TP6024	879	953	59.75	24	1.13	47	3.75
		76TP6030	960	1039	59.75	30	1.13	57	4.5
		76TP6036	1153	1247	59.75	36	1.13	57	3.75
		76TP6620	1045	1134	65.75	20	1.13	43	3.5
		76TP6624	1083	1170	65.75	24	1.13	50	4
		76TP6630	1120	1212	65.75	30	1.13	64	4.75
		76TP6636	1270	1373	65.75	36	1.13	77	5.5
		76TP7220	1195	1292	71.75	20	1.13	44	3.75
		76TP7224	1237	1336	71.75	24	1.13	55	4.25
		76TP7230	1271	1374	71.75	30	1.13	65	5.25
		76TP7236	1384	1497	71.75	36	1.13	84	6
		76TP7820	1307	1415	77.75	20	1.13	46	4
		76TP7824	1346	1456	77.75	24	1.13	58	4.75
		76TP7830	1387	1501	77.75	30	1.13	75	5.5
		76TP7836	1666	1802	77.75	36	1.13	91	6.5
		76TP8420	1373	1484	83.75	20	1.13	53.5	4.25
		76TP8424	1411	1526	83.75	24	1.13	62.5	5
		76TP8430	1452	1569	83.75	30	1.13	76	6
		76TP8436	1744	1884	83.75	36	1.13	76	5
		76TP9024	1513	1638	89.75	24	1.13	47	3
	76TP9030	1558	1685	89.75	30	1.13	57	3.75	
	76TP9036*	1867	2019	89.75	36	1.13	57	3.75	
	76TP9620	1579	1705	95.75	20	1.13	60	5	
	76TP9624	1620	1752	95.75	24	1.13	75	5.75	
	76TP9630	1669	1804	95.75	30	1.13	85.5	6.75	
	76TP9636	2002	2166	95.75	36	1.13	85.5	7	

**ORDERING NOTES:** See page 92 for base options.

**ORDERING PROCEDURE**

To order, please specify the following:

- 1) Krug product model number
- 2) Wood species and finish, see Page 11
- 3) Wood edge detail- I,H, L or P, see Page 3
- 4) Pull style, see Page 4
- 5) Grommet location if applicable

**STANDARD FINISHES**

For a complete list of standard wood finishes please see Page 117.

## ARTEMIS | MODULAR TOPS

Description	Model	Rift Oak/ Palette	Cherry Maple Walnut	W	D	H	Shipping Weight	Cubic Feet
Modular Return Tops 	76TPR3624L	695	751	36	24	1.13	47	2.25
	76TPR3624R	695	751	36	24	1.13	47	2.25
	76TPR3630L	782	845	36	30	1.13	57	2.75
	76TPR3630R	782	845	36	30	1.13	57	2.75
	76TPR3636L	939	1015	36	36	1.13	57	3.25
	76TPR3636R	939	1015	36	36	1.13	57	3.25
	76TPR4220L	640	693	42	20	1.13	28	2.25
	76TPR4220R	640	693	42	20	1.13	28	2.25
	76TPR4224L	665	720	42	24	1.13	18	2.75
	76TPR4224R	665	720	42	24	1.13	18	2.75
	76TPR4230L	819	885	42	30	1.13	57	3.25
	76TPR4230R	819	885	42	30	1.13	57	3.25
	76TPR4236L	982	1062	42	36	1.13	57	3.75
	76TPR4236R	982	1062	42	36	1.13	57	3.75
	76TPR4820L	661	715	48	20	1.13	31	2.5
	76TPR4820R	661	715	48	20	1.13	31	2.5
	76TPR4824L	687	741	48	24	1.13	20	3
	76TPR4824R	687	741	48	24	1.13	20	3
	76TPR4830L	857	929	48	30	1.13	57	3.5
	76TPR4830R	857	929	48	30	1.13	57	3.5
	76TPR4836L	1032	1117	48	36	1.13	57	4.25
	76TPR4836R	1032	1117	48	36	1.13	57	4.25
	76TPR5424L*	861	930	54	24	1.13	43	3.25
	76TPR5424R	861	930	54	24	1.13	43	3.25
	76TPR5430L	910	984	54	30	1.13	57	4
	76TPR5430R	910	984	54	30	1.13	57	4
	76TPR5436L	1093	1181	54	36	1.13	57	4.75
	76TPR5436R	1093	1181	54	36	1.13	57	4.75
	76TPR6024L	879	953	59.75	24	1.13	47	3.75
	76TPR6024R	879	953	59.75	24	1.13	47	3.75
76TPR6030L	960	1039	59.75	30	1.13	57	4.5	
76TPR6030R	960	1039	59.75	30	1.13	57	4.5	
76TPR6036L	1153	1247	59.75	36	1.13	57	4.75	
76TPR6036R	1153	1247	59.75	36	1.13	57	4.75	
76TPR6624L*	1031	1116	65.75	24	1.13	50	4	
76TPR6624R	1031	1116	65.75	24	1.13	50	4	
76TPR6630L	1120	1212	65.75	30	1.13	64	4.75	
76TPR6630R	1120	1212	65.75	30	1.13	64	4.75	
76TPR6636L	1004	1087	65.75	36	1.13	77	5.5	
76TPR6636R	1004	1087	65.75	36	1.13	77	5.5	
76TPR7224L	1178	1273	71.75	24	1.13	55	4.25	
76TPR7224R	1178	1273	71.75	24	1.13	55	4.25	
76TPR7230L	1271	1374	71.75	30	1.13	65	5.25	
76TPR7230R	1271	1374	71.75	30	1.13	65	5.25	
76TPR7236L	1384	1497	71.75	36	1.13	84	6	
76TPR7236R	1384	1497	71.75	36	1.13	84	6	
76TPR8424L	1421	1537	83.75	24	1.13	65.5	5	
76TPR8424R	1421	1537	83.75	24	1.13	65.5	5	
76TPR8430L	1452	1569	83.75	30	1.13	76	6	
76TPR8430R	1452	1569	83.75	30	1.13	76	6	
76TPR8436L	1744	1884	83.75	36	1.13	76	7	
76TPR8436R	1744	1884	83.75	36	1.13	76	7	

**DIMENSION KEY**

W - width  
D - depth  
H - height

Dimensions are in inches and approximate.  
Contact Customer Service if dimensions are critical.

**CODE DESCRIPTION**

L - left hand position  
R - right hand position  
4 - full height pedestal  
D - 2 file drawers  
F - 2 box, 1 file drawer

**STANDARD FINISHES**

For a complete list of standard wood finishes please see Page 117.

**GROMMETS**

One wiring grommet in standard position is optional at no charge. See page 7 for more wiring grommet information.

# ARTEMIS | RECEPTION

Description	Model	Rift Oak or	Rift Oak or	C,M,W w/		W	D	H	KW	Shipping Weight	Cubic Feet	
		Palette w/ Lam Top & Polymer Edge	Palette w/ Wood or Lam Top & Wood Edge	C,M,W w/ Lam Top & Polymer Edge	C,M,W w/ Wood or Lam Top & Wood Edge							
	Gallery Reception Desk Shell	76GSD6630	3235	3329	3395	3497	65.75	30	29.5	63.5	206	61.5
		76GSD7230	3582	3690	3762	3876	71.75	30	41.75	69.5	216	65
		76GSD7830*	3670	3783	3854	3970	77.75	30	41.75	75.5	229	68
		76GSD8430	3759	3871	3948	4064	83.75	30	41.75	81.5	241	75.5
		76GSD9630	3961	4081	4161	4286	95.75	30	41.75	93.5	265	85.75

	Gallery Reception Credenza Shell	76GSC7224	3568	3679	3748	3862	71.75	24	41.75	69.5	197	53.75
		76GSC7824*	3661	3770	3843	3958	77.75	24	41.75	75.5	209	58
		76GSC8424	3743	3856	3931	4048	83.75	24	41.75	81.5	221	62
		76GSC9624	3919	4037	4113	4238	95.75	24	41.75	93.5	244	70.5

	Gallery Reception Return Shell	76GSRH4224L	2668	2746	2802	2883	42	24	41.75	40.75	118	32.5
		76GSRH4224R	2668	2746	2802	2883	42	24	41.75	46.75	118	32.5
		76GSRH4824L*	2769	2852	2908	2995	48	24	41.75	40.75	128	36.75
		76GSRH4824R	2769	2852	2908	2995	48	24	41.75	46.75	128	36.75

	Gallery Reception Linking Unit	76GLU4224H	1530	1578	1609	1657	42	24	41.75	-	76	32.5
		76GLU4824H*	1583	1632	1662	1712	48	24	41.75	-	87	36.75

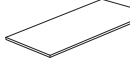
	Linking Tops for Gallery Cases	76LUD4224HL	583	598	611	628	42	24	29.5	-	33	2.25
		76LUD4224HR	583	598	611	628	42	24	29.5	-	33	2.25
		76LUD4824HL*	603	622	634	655	48	24	29.5	-	36	2.5
		76LUD4824HR	603	622	634	655	48	24	29.5	-	36	2.5

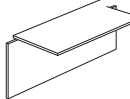
	Linking Units for Gallery Cases with Fixed Wood Modesty Panel	76LUD4224HLX41	1179	1215	1239	1275	42	24	29.5	-	71	23
		76LUD4224HRX41	1179	1215	1239	1275	42	24	29.5	-	71	23
		76LUD4824HLX41*	1228	1265	1288	1328	48	24	29.5	-	79	26
		76LUD4824HRX41	1228	1265	1288	1328	48	24	29.5	-	79	26

## ORDERING PROCEDURE

To order, please specify the following:

- 1) Krug product model number
- 2) Wood species and finish, see Page 11
- 3) Wood edge detail- I, H, L or P, see Page 3
- 4) Pull style, see Page 4
- 5) Grommet location if applicable

## CODE DESCRIPTION

- H - full height
- L - left handed position
- R - right handed position
- X41 - fixed wood modesty panel

## STANDARD FINISHES

For a complete list of standard wood finishes please see Page 117.

## GROMMETS

One wiring grommet in standard position is optional at no charge. See page 7 for more wiring grommet information.

# ARTEMIS | MEDIA WALL

Description	Model	Rift Oak/ Palette	Cherry Maple Walnut	W	D	H	Shipping Weight	Cubic Feet
1 TV Area, Unfinished Back	76MW541269S14	3368	3536	53.75	12	69	164	26
	76MW601269S14	3481	3655	59.75	12	69	220	35
	76MW541269S16	3368	3536	53.75	12	69	164	26
	76MW601269S16	3481	3655	59.75	12	69	220	35

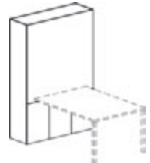

1 TV Area, Finished Back	76MW541269S14FB	4428	4652	53.75	12	69	213	26
	76MW601269S14FB	4590	4818	59.75	12	69	285	35
	76MW541269S16FB	4428	4652	53.75	12	69	213	26
	76MW601269S16FB	4590	4818	59.75	12	69	285	35

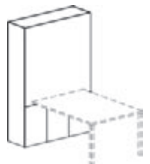

1 TV Area, Finished Back with Drawers	76MW541269S14FBB	6388	6708	53.75	12	69	238	30
	76MW601269S14FBB	6625	6956	59.75	12	69	318	41
	76MW541269S16FBB	6388	6708	53.75	12	69	238	30
	76MW601269S16FBB	6625	6956	59.75	12	69	318	41

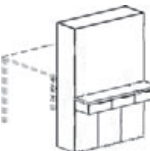

**ORDERING NOTES:**

Media Wall units are not stand alone cases. They must be used in conjunction with a Media Hub runoff top. Runoff tops and bases are sold separately, please see pages 111-114 for model numbers and pricing.

**DIMENSION KEY**

W - width  
D - depth  
H - height

Dimensions are in inches and approximate. Contact Customer Service if dimensions are critical.

**CODE DESCRIPTION**

S14 - use with desk height runoff  
S16 - use with bar height runoff  
FBB - finished back with drawer bank  
FB - finished bac

**STANDARD FINISHES**

For a complete list of standard wood finishes please see Page 117.

# ARTEMIS | 1 TV AREA

Description	Model	Rift Oak/ Palette	Cherry Maple Walnut	W	D	H	Shipping Weight	Cubic Feet
Media Hub, 1 TV Area no Runoff	76MH54187211S1	5035	5287	53.75	17.75	72	359	57.75
	76MH54188011S1	5187	5444	53.75	17.75	80	399	63.75
	76MH60187211S1*	5292	5558	59.75	17.75	72	385	63.5
	76MH60188011S1	5448	5720	59.75	17.75	80	437	70.25

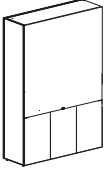

Media Hub, 1 TV Area, Desk Ht. Runoff	76MH54187211S14	5035	5287	53.75	17.75	72	359	57.75
	76MH54188011S14	5187	5444	53.75	17.75	80	399	63.75
	76MH60187211S14*	5292	5558	59.75	17.75	72	385	63.5
	76MH60188011S14	5448	5720	59.75	17.75	80	437	70.25

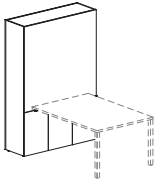

Media Hub, 1 TV Area, Bar Ht. Runoff	76MH54187211S16	5035	5287	53.75	17.75	72	359	57.75
	76MH54188011S16	5187	5444	53.75	17.75	80	399	63.75
	76MH60187211S16*	5292	5558	59.75	17.75	72	385	63.5
	76MH60188011S16	5448	5720	59.75	17.75	80	437	70.25

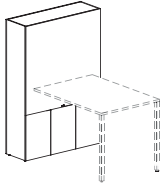

Media Hub, 1 TV Area, Drawers	76MH54187211S1B	7012	7360	53.75	17.75	72	359	57.75
	76MH54188011S1B	7159	7519	53.75	17.75	80	399	63.75
	76MH60187211S1B*	7329	7696	59.75	17.75	72	385	63.5
	76MH60188011S1B	7484	7860	59.75	17.75	80	437	70.25

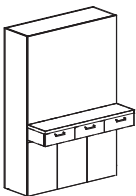

**ORDERING NOTES:**

Please note that runoff tops and bases are sold separately, please see pages 111-114 for item numbers and pricing. Hangover panel is available in veneer or palette. If not specified white palette is default

**ORDERING PROCEDURE**

To order, please specify the following:

- 1) Krug product model number
- 2) Wood species and finish, see Page 11
- 3) Wood edge detail see Page 3
- 4) Pull style, see Page 4
- 5) Grommet location if applicable

**CODE DESCRIPTION**

- 11 - closed bookcase
- S1 - 1 TV area
- B - drawer bank
- 4 - use with desk height runoff
- 6 - use with bar height runoff
- WB - white board

**STANDARD FINISHES**

For a complete list of standard wood finishes please see Page 117.

# ARTEMIS | 1 TV AREA WITH 1 HANG OVER PANEL

Description	Model	Rift Oak/ Palette	Cherry Maple Walnut	W	D	H	Shipping Weight	Cubic Feet
Media Hub,	76MH54217211S1	6649	6982	53.75	20.75	72	442	65.25
1 Hangover Panel, 1	76MH54218011S1	6861	7204	53.75	20.75	80	493	72.25
TV Area no Runoff	76MH60217211S1*	7081	7436	59.75	20.75	72	468	71.75
	76MH60218011S1	7292	7656	59.75	20.75	80	543	79.5

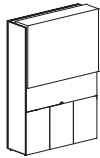

Media Hub, 1	76MH54217211S14	6649	6982	53.75	20.75	72	442	65.25
Hangover	76MH54218011S14	6861	7204	53.75	20.75	80	493	72.25
Panel, 1 TV Area,	76MH60217211S14*	7081	7436	59.75	20.75	72	468	71.75
Desk Ht. Runoff	76MH60218011S14	7292	7656	59.75	20.75	80	543	79.5

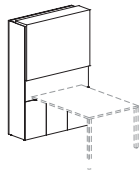

Media Hub,	76MH54217211S16	6649	6982	53.75	20.75	72	442	65.25
1 Hangover	76MH54218011S16	6861	7204	53.75	20.75	80	493	72.25
Panel, 1 TV Area,	76MH60217211S16*	7081	7436	59.75	20.75	72	468	71.75
Bar Ht. Runoff	76MH60218011S16	7292	7656	59.75	20.75	80	543	79.5

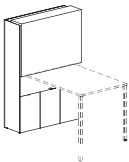

Media Hub,	76MH54217211S1B	8623	9055	53.75	20.75	72	442	65.25
1 Hangover	76MH54218011S1B	8728	9164	53.75	20.75	80	493	72.25
Panel, 1 TV Area,	76MH60217211S1B*	9117	9573	59.75	20.75	72	468	71.75
Drawers	76MH60218011S1B	9329	9795	59.75	20.75	80	543	79.5

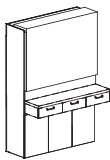

**ORDERING NOTES:**

Please note that runoff tops and bases are sold separately, please see pages 111-114 for item numbers and pricing. Hangover panel is available in veneer or palette. If not specified white palette is default

DIMENSION KEY	CODE DESCRIPTION	STANDARD FINISHES
W - width D - depth H - height	11 - closed bookcase S1 - 1 TV area B - drawer bank 4 - use with desk height runoff 6 - use with bar height runoff WB - white board	For a complete list of standard wood finishes please see Page 117.
Dimensions are in inches and approximate. Contact Customer Service if dimensions are critical.		



# ARTEMIS MEDIA HUB | 1 TV AREA WITH 1 HANG OVER PANEL AND WHITE BOARD

Description	Model	Cherry		W	D	H	Shipping Weight	Cubic Feet
		Rift Oak/ Palette	Maple Walnut					
Media Hub,	76MH54217211S1WB	8068	8471	53.75	20.75	72	455	65.25
1 Hangover	76MH54218011S1WB	8278	8692	53.75	20.75	80	506	72.25
Panel with White	76MH60217211S1WB*	8499	8921	59.75	20.75	72	481	71.75
Board, 1 TV Area, no Runoff	76MH60218011S1WB	8707	9144	59.75	20.75	80	556	79.5

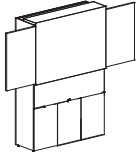

Media Hub,	76MH54217211S14WB	8068	8471	53.75	20.75	72	455	65.25
1 Hangover	76MH54218011S14WB	8278	8692	53.75	20.75	80	506	72.25
Panel with White	76MH60217211S14WB*	8499	8921	59.75	20.75	72	481	71.75
Board, 1 TV Area, Desk Ht. Runoff	76MH60218011S14WB	8707	9144	59.75	20.75	80	556	79.5

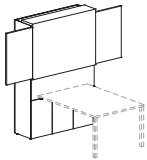

Media Hub,	76MH54217211S16WB	8068	8471	53.75	20.75	72	455	65.25
1 Hangover	76MH54218011S16WB	8278	8692	53.75	20.75	80	506	72.25
Panel with White	76MH60217211S16WB*	8499	8921	59.75	20.75	72	481	71.75
Board, 1 TV Area, Bar Ht. Runoff	76MH60218011S16WB	8707	9144	59.75	20.75	80	556	79.5

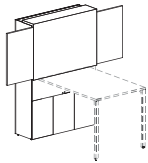

Media Hub,	76MH54221011S1WBB	10042	10544	53.75	20.75	72	455	65.25
1 Hangover	76MH54218011S1WBB	10249	10764	53.75	20.75	80	506	72.25
Panel with White	76MH60217211S1WBB*	10536	11062	59.75	20.75	72	481	71.75
Board, 1 TV Area,	76MH60218011S1WBB	10745	11283	59.75	20.75	80	556	79.5

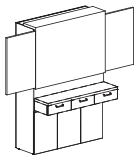

**ORDERING NOTES:** Please note that runoff tops and bases are sold separately, please see pages 111-114 for item numbers and pricing. Hangover panel is available in veneer or palette. If not specified white palette is default

### ORDERING PROCEDURE

To order, please specify the following:

- 1) Krug product model number
- 2) Wood species and finish, see Page 11
- 3) Wood edge detail- I,H, L or P, see Page 3
- 4) Pull style, see Page 4
- 5) Grommet location if applicable

### CODE DESCRIPTION

11 - closed bookcase  
 S1 - 1 TV area  
 B - drawer bank  
 4 - use with desk height runoff  
 6 - use with bar height runoff  
 WB - white board

### STANDARD FINISHES

For a complete list of standard wood finishes please see Page 117.

# ARTEMIS MEDIA HUB | 2 TV AREAS

Description	Model	Rift Oak/ Palette	Cherry Maple Walnut	W	D	H	Shipping Weight	Cubic Feet
Media Hub, 2 TV Areas no Runoff	76MH54187211S2	5125	5384	53.75	17.75	72	359	57.75
	76MH54188011S2	5125	5384	53.75	17.75	80	399	63.75
	76MH60187211S2*	5281	5545	59.75	17.75	72	385	63.5
	76MH60188011S2	5389	5658	59.75	17.75	80	437	70.25
		5548	5825					



Media Hub, 2 TV Areas, Desk Ht. Runoff	76MH54187211S244	5125	5384	53.75	17.75	72	359	57.75
	76MH54188011S244	5281	5545	53.75	17.75	80	399	63.75
	76MH60187211S244*	5389	5658	59.75	17.75	72	385	63.5
	76MH60188011S244	5548	5825	59.75	17.75	80	437	70.25

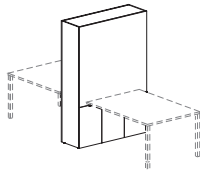

Media Hub, 2 TV Areas, Bar Ht. Runoff	76MH54187211S266	5125	5384	53.75	17.75	72	359	57.75
	76MH54188011S266	5125	5384	53.75	17.75	80	399	63.75
	76MH60187211S266*	5281	5545	59.75	17.75	72	385	63.5
	76MH60188011S266	5389	5658	59.75	17.75	80	437	70.25
		5548	5825					

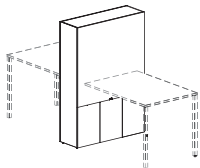

Media Hub, 2 TV Areas, 1 Desk & 1 Bar Ht. Runoff	76MH54187211S246	5125	5384	53.75	17.75	72	359	57.75
	76MH54188011S246	5281	5545	53.75	17.75	80	399	63.75
	76MH60187211S246*	5389	5658	59.75	17.75	72	385	63.5
	76MH60188011S246	5548	5825	59.75	17.75	80	437	70.25

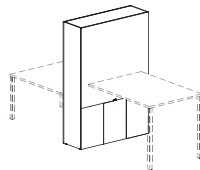

**ORDERING NOTES:** Please note that runoff tops and bases are sold separately, please see pages 111-114 for item numbers and pricing

**DIMENSION KEY**

W - width  
D - depth  
H - height

Dimensions are in inches and approximate. Contact Customer Service if dimensions are critical.

**CODE DESCRIPTION**

11 - closed bookcase  
S2 - 2 TV areas  
B - drawer bank  
4 - use with desk height runoff  
6 - use with bar height runoff  
WB - white board

**STANDARD FINISHES**

For a complete list of standard wood finishes please see Page 117.

# ARTEMIS MEDIA HUB | 2 TV AREAS

Description	Model	Rift Oak/ Palette	Cherry Maple Walnut	W	D	H	Shipping	
							Weight	Cubic Feet
Media Hub, 2 TV	76MH54187211S2B4	7101	7455	53.75	17.75	72	359	57.75
Areas, Drawers/Desk	76MH54188011S2B4	7256	7617	53.75	17.75	80	399	63.75
Ht. Runoff	76MH60187211S2B4*	7423	7794	59.75	17.75	72	385	63.5
	76MH60188011S2B4	7585	7964	59.75	17.75	80	437	70.25

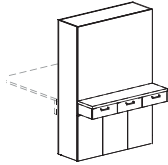

Media Hub, 2 TV	76MH54187211S2B6	7101	7455	53.75	17.75	72	359	57.75
Areas, Drawers/	76MH54188011S2B6	7256	7617	53.75	17.75	80	399	63.75
Bar Ht. Runoff	76MH60187211S2B6*	7423	7794	59.75	17.75	72	385	63.5
	76MH60188011S2B6	7585	7964	59.75	17.75	80	437	70.25

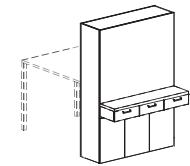

Media Hub, 2 TV	76MH54187211S2BB	9075	9528	53.75	17.75	72	359	57.75
Areas, 2 Drawers	76MH54188011S2BB	9229	9691	53.75	17.75	80	399	63.75
	76MH60187211S2BB*	9460	9934	59.75	17.75	72	385	63.5
	76MH60188011S2BB	9620	10099	59.75	17.75	80	437	70.25

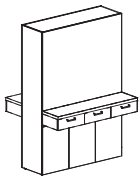

**ORDERING NOTES:**

Please note that runoff tops and bases are sold separately, please see pages 111-114 for item numbers and pricing.

**ORDERING PROCEDURE**

To order, please specify the following:

- 1) Krug product model number
- 2) Wood species and finish, see Page 11
- 3) Wood edge detail see Page 3
- 4) Pull style, see Page 4
- 5) Grommet location if applicable

**CODE DESCRIPTION**

- 11 - closed bookcase
- S2 - 2 TV areas
- B - drawer bank
- 4 - use with desk height runoff
- 6 - use with bar height runoff
- WB - white board

**STANDARD FINISHES**

For a complete list of standard wood finishes please see Page 117.

# ARTEMIS MEDIA HUB | 2 TV AREAS WITH 1 HANG OVER PANEL

Description	Model	Cherry		W	D	H	Shipping Weight	Cubic Feet
		Rift Oak/ Palette	Maple Walnut					
Media Hub, 1 Hang-over Panel, 2 TV Areas no Runoff	76MH54217211S2	6739	7078	53.75	20.75	72	442	65.25
	76MH54218011S2	6954	7302	53.75	20.75	80	493	72.25
	76MH60217211S2*	7178	7536	59.75	20.75	72	468	71.75
	76MH60218011S2	7392	7761	59.75	20.75	80	543	79.5



Media Hub, 1 Hangover Panel, 2 TV Areas, Desk Ht. Runoff	76MH54217211S244	6739	7078	53.75	20.75	72	442	65.25
	76MH54218011S244	6954	7302	53.75	20.75	80	493	72.25
	76MH60217211S244*	7178	7536	59.75	20.75	72	468	71.75
	76MH60218011S244	7392	7761	59.75	20.75	80	543	79.5

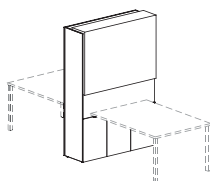

Media Hub, 1 Hangover Panel, 2 TV Areas, Bar Ht. Runoff	76MH54217211S266	6739	7078	53.75	20.75	72	442	65.25
	76MH54218011S266	6954	7302	53.75	20.75	80	493	72.25
	76MH60217211S266*	7178	7536	59.75	20.75	72	468	71.75
	76MH60218011S266	7392	7761	59.75	20.75	80	543	79.5

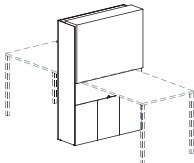

Media Hub, 1 Hangover Panel, 2 TV Areas, Bar Ht. Runoff	76MH54217211S246	6739	7078	53.75	20.75	72	442	65.25
	76MH54218011S246	6954	7302	53.75	20.75	80	493	72.25
	76MH60217211S246*	7178	7536	59.75	20.75	72	468	71.75
	76MH60218011S246	7392	7761	59.75	20.75	80	543	79.5

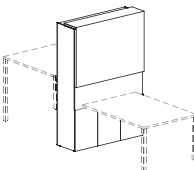

**ORDERING NOTES:**

Please note that runoff tops and bases are sold separately, please see pages 111-114 for item numbers and pricing. Hangover panel is available in veneer or palette. If not specified white palette is default

**DIMENSION KEY**

W - width  
D - depth  
H - height

Dimensions are in inches and approximate. Contact Customer Service if dimensions are critical.

**CODE DESCRIPTION**

11 - closed bookcase  
S2 - 2 TV areas  
B - drawer bank  
4 - use with desk height runoff  
6 - use with bar height runoff  
WB - white board

**STANDARD FINISHES**

For a complete list of standard wood finishes please see Page 117.

# ARTEMIS MEDIA HUB | 1 TV AREA WITH 1 HANG OVER PANEL

Description	Model	Cherry		W	D	H	Shipping Weight	Cubic Feet
		Rift Oak/ Palette	Maple Walnut					
Media Hub,	76MH54217211S264	6739	7078	53.75	20.75	72	442	65.25
1 Hangover Panel,	76MH54218011S264	6954	7302	53.75	20.75	80	493	72.25
2 TV Areas, Bar Ht./	76MH60217211S264*	7178	7536	59.75	20.75	72	468	71.75
Desk Ht. Runoff	76MH60218011S264	7392	7761	59.75	20.75	80	543	79.5

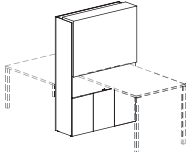

Media Hub,	76MH54217211S2B4	8715	9148	53.75	20.75	72	442	65.25
1 Hangover	76MH54218011S2B4	8931	9376	53.75	20.75	80	493	72.25
Panel, 2 TV Areas,	76MH60217211S2B4*	9210	9670	59.75	20.75	72	468	71.75
Drawers/ Desk Ht. Runoff	76MH60218011S2B4	9424	9900	59.75	20.75	80	543	79.5



Media Hub,	76MH54217211S24B	8715	9148	53.75	20.75	72	442	65.25
1 Hangover	76MH54218011S24B	8931	9376	53.75	20.75	80	493	72.25
Panel, 2 TV Areas,	76MH60217211S24B*	9210	9670	59.75	20.75	72	468	71.75
Desk Ht. Runoff/Drawers	76MH60218011S24B	9424	9900	59.75	20.75	80	543	79.5

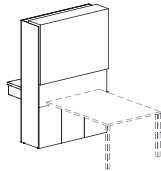

Media Hub,	76MH54217211S2B6	8715	9148	53.75	20.75	72	442	65.25
1 Hangover	76MH54218011S2B6	8931	9376	53.75	20.75	80	493	72.25
Panel, 2 TV Areas,	76MH60217211S2B6*	9210	9670	59.75	20.75	72	468	71.75
Drawers/ Bar Ht. Runoff	76MH60218011S2B6	9424	9900	59.75	20.75	80	543	79.5

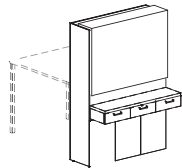

**ORDERING NOTES:** Please note that runoff tops and bases are sold separately, please see pages 111-114 for item numbers and pricing. Hangover panel is available in veneer or palette. If not specified white palette is default

### ORDERING PROCEDURE

To order, please specify the following:

- 1) Krug product model number
- 2) Wood species and finish, see Page 11
- 3) Wood edge detail, see Page 3
- 4) Pull style, see Page 4
- 5) Grommet location if applicable

### CODE DESCRIPTION

11 - closed bookcase  
 S2 - 2 TV areas  
 B - drawer bank  
 4 - use with desk height runoff  
 6 - use with bar height runoff  
 WB - white board

### STANDARD FINISHES

For a complete list of standard wood finishes please see Page 117.

# ARTEMIS MEDIA HUB | 2 TV AREAS WITH 1 HANG OVER PANEL

Description	Model	Cherry		W	D	H	Shipping Weight	Cubic Feet
		Rift Oak/ Palette	Maple Walnut					
Media Hub,	76MH54217211S26B	8715	9148	53.75	20.75	72	442	65.25
1 Hangover	76MH54218011S26B	8931	9376	53.75	20.75	80	493	72.25
Panel, 2 TV Areas,	76MH60217211S26B*	9210	9670	59.75	20.75	72	468	71.75
Bar Ht.	76MH60218011S26B	9424	9900	59.75	20.75	80	543	79.5
Runoff/Drawers								

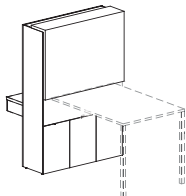

Description	Model	Cherry		W	D	H	Shipping Weight	Cubic Feet
		Rift Oak/ Palette	Maple Walnut					
Media Hub,	76MH54217211S2BB	10689	11224	53.75	20.75	72	442	65.25
1 Hangover	76MH54218011S2BB	10904	11449	53.75	20.75	80	493	72.25
Panel, 2 TV Areas,	76MH60217211S2BB*	11245	11808	59.75	20.75	72	468	71.75
2 Drawers	76MH60218011S2BB	11460	12034	59.75	20.75	80	543	79.5

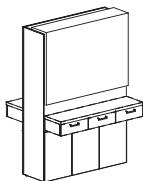

**ORDERING NOTES:**

Please note that runoff tops and bases are sold separately, please see pages 111-114 for item numbers and pricing. Hangover panel is available in veneer or palette. If not specified white palette is default

DIMENSION KEY	CODE DESCRIPTION	STANDARD FINISHES
W - width D - depth H - height  Dimensions are in inches and approximate. Contact Customer Service if dimensions are critical.	11 - closed bookcase S2 - 2 TV areas B - drawer bank 6 - use with bar height runoff WB - white board	For a complete list of standard wood finishes please see Page 117.

# ARTEMIS MEDIA HUB | 2 TV AREAS, 1 HANG OVER PANEL WITH WHITE BOARD

Description	Model	Cherry		W	D	H	Shipping Weight	Cubic Feet
		Rift Oak/ Palette	Maple Walnut					
Media Hub,	76MH542172112WB	8442	8864	53.75	20.75	72	455	65.25
1 Hangover	76MH542180112WB	8655	9088	53.75	20.75	80	506	72.25
Panel with White	76MH602172112WB*	8877	9322	59.75	20.75	72	481	71.75
Board, 2 TV Areas no Runoff	76MH602180112WB	9094	9548	59.75	20.75	80	556	79.5

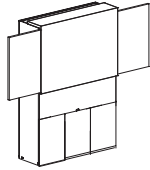

Media Hub,	76MH54217211S244WB	8442	8864	53.75	20.75	72	455	65.25
1 Hangover	76MH54218011S244WB	8655	9088	53.75	20.75	80	506	72.25
Panel with White	76MH60217211S244WB*	8877	9322	59.75	20.75	72	481	71.75
Board, 2 TV Areas, Desk Ht. Runoff	76MH60218011S244WB	9094	9548	59.75	20.75	80	556	79.5

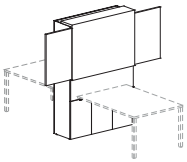

Media Hub,	76MH54217211S266WB	8442	8864	53.75	20.75	72	455	65.25
1 Hangover Panel with	76MH54218011S266WB	8655	9088	53.75	20.75	80	506	72.25
White Board, 2 TV	76MH60217211S266WB*	8877	9322	59.75	20.75	72	481	71.75
Areas, Bar Ht. Runoff	76MH60218011S266WB	9094	9548	59.75	20.75	80	556	79.5

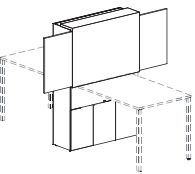

Media Hub,	76MH54217211S246WB	8442	8864	53.75	20.75	72	455	65.25
1 Hangover	76MH54218011S246WB	8655	9088	53.75	20.75	80	506	72.25
Panel with White	76MH60217211S246WB*	8877	9322	59.75	20.75	72	481	71.75
Board, 2 TV Areas, Desk Ht./ Bar Ht. Runoff	76MH60218011S246WB	9094	9548	59.75	20.75	80	556	79.5

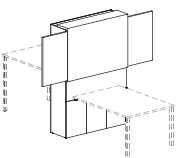

**ORDERING NOTES:**

Please note that runoff tops and bases are sold separately, please see pages 111-114 for item numbers and pricing. Hangover panel is available in veneer or palette. If not specified white palette is default

**ORDERING PROCEDURE**

To order, please specify the following:

- 1) Krug product model number
- 2) Wood species and finish, see Page 11
- 3) Wood edge detail, see Page 3
- 4) Pull style, see Page 4
- 5) Grommet location if applicable

**CODE DESCRIPTION**

- 11 - closed bookcase
- S2 - 2 TV areas
- B - drawer bank
- 4 - use with desk height runoff
- 6 - use with bar height runoff
- WB - white board

**STANDARD FINISHES**

For a complete list of standard wood finishes please see Page 117.

# ARTEMIS MEDIA HUB | 2 TV AREAS, 1 HANG OVER PANEL WITH WHITE BOARD

Description	Model	Cherry		W	D	H	Shipping Weight	Cubic Feet
		Rift Oak/ Palette	Maple Walnut					
Media Hub,	76MH54217211S2B4WB	10414	10936	53.75	20.75	72	455	65.25
1 Hangover	76MH54218011S2B4WB	10630	11162	53.75	20.75	80	506	72.25
Panel with White	76MH60217211S2B4WB*	10914	11460	59.75	20.75	72	481	71.75
Board, 2 TV Areas, Drawers/ Desk Ht. Runoff	76MH60218011S2B4WB	11130	11688	59.75	20.75	80	556	79.5

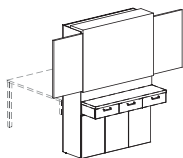

Media Hub,	76MH54217211S2B6WB	10414	10936	53.75	20.75	72	455	65.25
1 Hangover	76MH54218011S2B6WB	10630	11162	53.75	20.75	80	506	72.25
Panel with White	76MH60217211S2B6WB*	10914	11460	59.75	20.75	72	481	71.75
Board, 2 TV Areas, Drawers/ Bar Ht. Runoff	76MH60218011S2B6WB	11130	11688	59.75	20.75	80	556	79.5

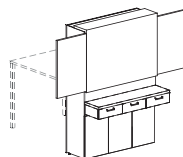

Media Hub,	76MH54217211S2BBWB	12388	13009	53.75	20.75	72	455	65.25
1 Hangover	76MH54218011S2BBWB	12606	13237	53.75	20.75	80	506	72.25
Panel with White	76MH60217211S2BBWB*	12951	13598	59.75	20.75	72	481	71.75
Board, 2 TV Areas, Drawers/ Bar Ht. Runoff	76MH60218011S2BBWB	13168	13825	59.75	20.75	80	556	79.5

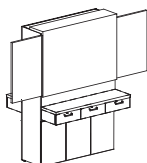

**ORDERING NOTES:**

Please note that runoff tops and bases are sold separately, please see pages 111-114 for item numbers and pricing. Hangover panel is available in veneer or palette. If not specified white palette is default

DIMENSION KEY	CODE DESCRIPTION	STANDARD FINISHES
W - width D - depth H - height	11 - closed bookcase S2 - 2 TV areas B - drawer bank 4 - use with desk height runoff 6 - use with bar height runoff WB - white board	For a complete list of standard wood finishes please see Page 117.
Dimensions are in inches and approximate. Contact Customer Service if dimensions are critical.		



# ARTEMIS MEDIA HUB | 2 TV AREAS, 2 HANG OVER PANELS

Description	Model	Cherry		W	D	H	Shipping Weight	Cubic Feet
		Rift Oak/ Palette	Maple Walnut					
Media Hub,	76MH54247241S2	8356	8771	53.75	23.75	72	532	72.75
2 Hangover	76MH54248011S2	8628	9060	53.75	23.75	80	594	80.75
Panels, 2 TV Areas no	76MH60247241S2*	8965	9413	59.75	23.75	72	558	80.25
Runoff	76MH60248011S2	9234	9696	59.75	23.75	80	656	89

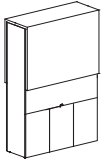

Media Hub,	76MH54247241S244	8356	8771	53.75	23.75	72	532	72.75
2 Hangover	76MH54248011S244	8628	9060	53.75	23.75	80	594	80.75
Panels, 2 TV Areas,	76MH60247241S244*	8965	9413	59.75	23.75	72	558	80.25
Desk Ht. Runoff	76MH60248011S244	9234	9696	59.75	23.75	80	656	89

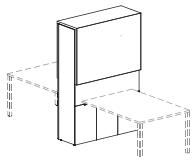

Media Hub,	76MH54247241S266	8356	8771	53.75	23.75	72	532	72.75
2 Hangover Panels, 2	76MH54248011S266	8628	9060	53.75	23.75	80	594	80.75
TV Areas, Bar	76MH60247241S266*	8965	9413	59.75	23.75	72	558	80.25
Ht. Runoff	76MH60248011S266	9234	9696	59.75	23.75	80	656	89

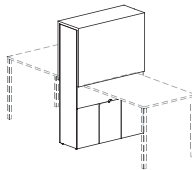

Media Hub,	76MH54247241S246	8356	8771	53.75	23.75	72	532	72.75
2 Hangover Panels,	76MH54248011S246	8628	9060	53.75	23.75	80	594	80.75
2 TV Areas, Desk Ht.	76MH60247241S246*	8965	9413	59.75	23.75	72	558	80.25
& Bar Ht. Runoff	76MH60248011S246	9234	9696	59.75	23.75	80	656	89

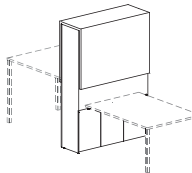

**ORDERING NOTES:**

Please note that runoff tops and bases are sold separately, please see pages 111-114 for item numbers and pricing. Hangover panel is available in veneer or palette. If not specified white palette is default

**ORDERING PROCEDURE**

To order, please specify the following:

- 1) Krug product model number
- 2) Wood species and finish, see Page 11
- 3) Wood edge detail, see Page 3
- 4) Pull style, see Page 4
- 5) Grommet location if applicable

\*Indicates model illustrated by line drawing.

**CODE DESCRIPTION**

- 11 - closed bookcase
- S2 - 2 TV areas
- B - drawer bank
- 4 - use with desk height runoff
- 6 - use with bar height runoff
- WB - white board

**STANDARD FINISHES**

For a complete list of standard wood finishes please see Page 117.

## ARTEMIS MEDIA HUB | 2 TV AREAS, 2 HANG OVER PANELS

Description	Model	Cherry		W	D	H	Shipping Weight	Cubic Feet
		Rift Oak/ Palette	Maple Walnut					
Media Hub,	76MH54247241S2B4	10329	10845	53.75	23.75	72	532	72.75
2 Hangover	76MH54248011S2B4	10602	11135	53.75	23.75	80	594	80.75
Panels, 2 TV Areas,	76MH60247241S2B4*	10996	11548	59.75	23.75	72	558	80.25
Drawers/ Desk Ht. Runoff	76MH60248011S2B4	11272	11836	59.75	23.75	80	656	89

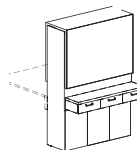

Media Hub,	76MH54247241S2B6	10329	10845	53.75	23.75	72	532	72.75
2 Hangover	76MH54248011S2B6	10602	11135	53.75	23.75	80	594	80.75
Panels, 2 TV Areas,	76MH60247241S2B6*	10996	11548	59.75	23.75	72	558	80.25
Drawers/ Bar Ht. Runoff	76MH60248011S2B6	11272	11836	59.75	23.75	80	656	89

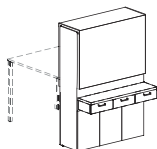

Media Hub,	76MH54247241S2BB	12303	12916	53.75	23.75	72	532	72.75
2 Hangover	76MH54248011S2BB	12579	13209	53.75	23.75	80	594	80.75
Panels, 2 TV Areas,	76MH60247241S2BB*	13035	13687	59.75	23.75	72	558	80.25
2 Drawers	76MH60248011S2BB	13309	13973	59.75	23.75	80	656	89

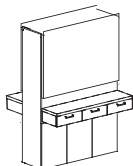

**ORDERING NOTES:**

Please note that runoff tops and bases are sold separately, please see pages 111-114 for item numbers and pricing. Hangover panel is available in veneer or palette. If not specified white palette is default

**DIMENSION KEY**

W - width  
D - depth  
H - height

Dimensions are in inches and approximate. Contact Customer Service if dimensions are critical.

**CODE DESCRIPTION**

11 - closed bookcase  
S2 - 2 TV areas  
B - drawer bank  
4 - use with desk height runoff  
6 - use with bar height runoff  
WB - white board

**STANDARD FINISHES**

For a complete list of standard wood finishes please see Page 117.

# ARTEMIS MEDIA HUB | 2 TV AREAS, 2 HANG OVER PANELS WITH WHITE BOARD

Description	Model	Cherry		W	D	H	Shipping Weight	Cubic Feet
		Rift Oak/ Palette	Maple Walnut					
Media Hub,	76MH54247211S2WB	11188	11747	53.75	23.75	72	559	72.75
2 Hangover Panels	76MH54248011S2WB	11462	12036	53.75	23.75	80	621	80.75
with White Board, 2 TV	76MH60247211S2WB*	11798	12388	59.75	23.75	72	585	80.25
Areas no Runoff	76MH60248011S2WB	12068	12672	59.75	23.75	80	683	89

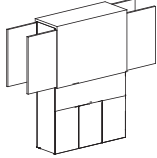

Media Hub,	76MH54247211S244WB	11188	11747	53.75	23.75	72	559	72.75
2 Hangover Panels	76MH54248011S244WB	11462	12036	53.75	23.75	80	621	80.75
with White Board, 2 TV	76MH60247211S244WB*	11798	12388	59.75	23.75	72	585	80.25
Areas/ Desk Ht. Runoff	76MH60248011S244WB	12068	12672	59.75	23.75	80	683	89

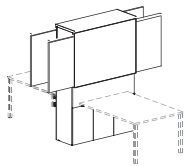

Media Hub,	76MH54247211S266WB	11188	11747	53.75	23.75	72	559	72.75
2 Hangover Panels	76MH54248011S266WB	11462	12036	53.75	23.75	80	621	80.75
with White Board, 2 TV	76MH60247211S266WB*	11798	12388	59.75	23.75	72	585	80.25
Areas, Bar Ht. Runoff	76MH60248011S266WB	12068	12672	59.75	23.75	80	683	89

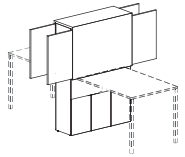

Media Hub,	76MH54247211S246WB	11188	11747	53.75	23.75	72	559	72.75
2 Hangover Panels	76MH54248011S246WB	11462	12036	53.75	23.75	80	621	80.75
with White Board, 2	76MH60247211S246WB*	11798	12388	59.75	23.75	72	585	80.25
TV Areas, Desk Ht. & Bar Ht. Runoff	76MH60248011S246WB	12068	12672	59.75	23.75	80	683	89



## ORDERING NOTES:

Please note that runoff tops and bases are sold separately, please see pages 111-114 for item numbers and pricing. Hangover panel is available in veneer or palette. If not specified white palette is default

## ORDERING PROCEDURE

To order, please specify the following:

- 1) Krug product model number
- 2) Wood species and finish, see Page 11
- 3) Wood edge detail, see Page 3
- 4) Pull style, see Page 4
- 5) Grommet location if applicable

## CODE DESCRIPTION

11 - closed bookcase  
 S2 - 2 TV areas  
 B - drawer bank  
 4 - use with desk height runoff  
 6 - use with bar height runoff  
 WB - white board

## STANDARD FINISHES

For a complete list of standard wood finishes please see Page 117.

# ARTEMIS MEDIA HUB | 2 TV AREAS, 2 HANG OVER PANELS WITH WHITE BOARD

Description	Model	Cherry		W	D	H	Shipping Weight	Cubic Feet
		Rift Oak/ Palette	Maple Walnut					
Media Hub,	76MH54247211S2B4WB	10329	10844	53.75	23.75	72	559	72.75
2 Hangover	76MH54248011S2B4WB	10602	11135	53.75	23.75	80	621	80.75
Panels with White	76MH60247211S2B4WB*	10996	11515	59.75	23.75	72	585	80.25
Board, 2 TV Areas, Drawers/Desk Ht. Runoff	76MH60248011S2B4WB	11272	11788	59.75	23.75	80	683	89

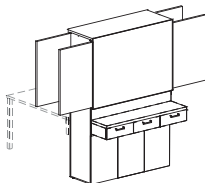

Media Hub,	76MH54247211S2B6WB	10329	10844	53.75	23.75	72	559	72.75
2 Hangover Panels	76MH54248011S2B6WB	10602	11135	53.75	23.75	80	621	80.75
with White Board, 2	76MH60247211S2B6WB*	10996	11515	59.75	23.75	72	585	80.25
TV Areas, Drawers/ Bar Ht. Runoff	76MH60248011S2B6WB	11272	11788	59.75	23.75	80	683	89

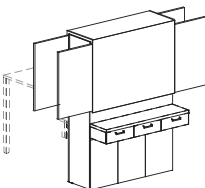

Media Hub, 2	76MH54247211S2BBWB	12303	12916	53.75	23.75	72	559	72.75
Hangover Panels	76MH54248011S2BBWB	12579	13209	53.75	23.75	80	621	80.75
with White Board,	76MH60247211S2BBWB*	13035	13687	59.75	23.75	72	585	80.25
2 TV Areas, 2 Drawers	76MH60248011S2BBWB	13309	13973	59.75	23.75	80	683	89

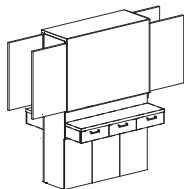

**ORDERING NOTES:**

Please note that runoff tops and bases are sold separately, please see pages 111-114 for item numbers and pricing. Hangover panel is available in veneer or palette. If not specified white palette is default

**DIMENSION KEY**

W - width  
D - depth  
H - height

Dimensions are in inches and approximate. Contact Customer Service if dimensions are critical.



**CODE DESCRIPTION**

11 - closed bookcase  
S2 - 2 TV areas  
B - drawer bank  
4 - use with desk height runoff  
6 - use with bar height runoff  
WB - white board

**STANDARD FINISHES**

For a complete list of standard wood finishes please see Page 117.

# ARTEMIS MEDIA HUB | DESK HEIGHT RUNOFF TOPS

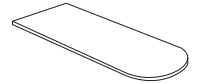
Description	Model	Rift Oak or Lam Top w/ Polymer Edge	C,M,W or Lam Top & wood Edge	W	D	H	Shipping Weight	Cubic Feet	
	Rectangular Runoff Top	76MHR60364	1401	1514	59.5	35.75	29.5	85	5
	76MHR60424	1749	1892	59.5	41.75	29.5	98	6	
	76MHR66364	1456	1573	65.5	35.75	29.5	93	5.5	
	76MHR66424	1811	1959	65.5	41.75	29.5	106	6.5	
	76MHR72364	1559	1688	71.5	35.75	29.5	100	6	
	76MHR72424	1923	2080	71.5	41.75	29.5	115	7	
	76MHR78364	1832	1980	77.5	35.75	29.5	108	6.5	
	76MHR78424*	2198	2381	77.5	41.75	29.5	118	7.5	
	76MHR84364	1879	2031	83.5	35.75	29.5	115	7	
	76MHR84424	2247	2431	83.5	41.75	29.5	135	8	
	76MHR96364	1979	2138	95.5	35.75	29.5	140	7.5	
76MHR96424	2347	2538	95.5	41.75	29.5	160	9		
	Arc Runoff Top	76MHAR60364	1460	1581	59.5	35.75	29.5	85	5
	76MHAR60424	1809	1956	59.5	41.75	29.5	98	6	
	76MHAR66364	1515	1640	65.5	35.75	29.5	93	5.5	
	76MHAR66424	1871	2024	65.5	41.75	29.5	106	6.5	
	76MHAR72364	1619	1751	71.5	35.75	29.5	100	6	
	76MHAR72424	1982	2144	71.5	41.75	29.5	115	7	
	76MHAR78364*	1890	2043	77.5	35.75	29.5	108	6.5	
	76MHAR78424	2261	2444	77.5	41.75	29.5	118	7.5	
	76MHAR84364	1936	2092	83.5	35.75	29.5	115	7	
	76MHAR84424	2307	2495	83.5	41.75	29.5	135	8	
	76MHAR96364	2035	2202	95.5	35.75	29.5	140	7.5	
76MHAR96424	1809	1956	95.5	41.75	29.5	160	9		
	Bullet Runoff Top	76MHBR60364	1515	1640	59.5	35.75	29.5	85	5
	76MHBR60424	1871	2024	59.5	41.75	29.5	98	6	
	76MHBR66364	1619	1751	65.5	35.75	29.5	93	5.5	
	76MHBR66424	1982	2144	65.5	41.75	29.5	106	6.5	
	76MHBR72364	1890	2043	71.5	35.75	29.5	100	6	
	76MHBR72424	2261	2444	71.5	41.75	29.5	115	7	
	76MHBR78364	1936	2092	77.5	35.75	29.5	108	6.5	
	76MHBR78424	2307	2495	77.5	41.75	29.5	118	7.5	
	76MHBR84364	2035	2202	83.5	35.75	29.5	115	7	
	76MHBR84424	2406	2602	83.5	41.75	29.5	135	8	
	76MHBR96364	2406	2602	95.5	35.75	29.5	140	7.5	
76MHBR96424	2406	2602	95.5	41.75	29.5	160	9		

**ORDERING NOTES:**

Please note that 2" Square Metal legs cannot be specified with the Bullet Runoff top.

**ORDERING PROCEDURE**



To order, please specify the following:

- 1) Krug product model number
- 2) Wood species and finish, see Page 11
- 3) Wood edge detail, see Page 3
- 4) Pull style, see Page 4
- 5) Grommet location if applicable

**STANDARD FINISHES**

For a complete list of standard wood finishes please see Page 117. Disc bases and metal legs are available in a Brushed Stainless finish.

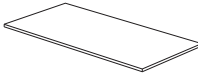
# ARTEMIS MEDIA HUB | BAR HEIGHT RUNOFFS

Description	Model	Rift Oak or Lam Top w/ Polymer Edge	C,M,W or Lam Top & wood Edge	W	D	H	Shipping Weight	Cubic Feet
	76MHVR6036-424	1671	1809	59.5	35.75	29.5	98	6
	76MHVR6042-484	2058	2223	59.5	41.75	29.5	110	6.5
	76MHVR6636-424	1731	1871	65.5	35.75	29.5	106	6.5
	76MHVR6642-484	2131	2303	65.5	41.75	29.5	120	7
	76MHVR7236-424	1834	1982	71.5	35.75	29.5	115	7
	76MHVR7242-484	2254	2437	71.5	41.75	29.5	130	7.5
	76MHVR7836-424	2089	2261	77.5	35.75	29.5	118	7.5
	76MHVR7842-484*	2507	2714	77.5	41.75	29.5	145	8
	76MHVR8436-424	2134	2307	83.5	35.75	29.5	135	8
	76MHVR8442-484	2560	2768	83.5	41.75	29.5	155	9
	76MHVR9636-424	2149	2326	95.5	35.75	29.5	160	9
76MHVR9642-484	2221	2405	95.5	41.75	29.5	175	10	
	76MHR60366	1401	1514	59.5	35.75	29.5	85	5
	76MHR60426	1749	1892	59.5	41.75	29.5	98	6
	76MHR66366	1456	1573	65.5	35.75	29.5	93	5.5
	76MHR66426	1811	1959	65.5	41.75	29.5	106	6.5
	76MHR72366	1559	1688	71.5	35.75	29.5	100	6
	76MHR72426	1923	2080	71.5	41.75	29.5	115	7
	76MHR78366*	1832	1980	77.5	35.75	29.5	108	6.5
	76MHR78426	2198	2381	77.5	41.75	29.5	118	7.5
	76MHR84366	1879	2031	83.5	35.75	29.5	115	7
	76MHR84426	2247	2431	83.5	41.75	29.5	135	8
	76MHR96366	1979	2138	95.5	35.75	29.5	140	7.5
	76MHR96426	2347	2538	95.5	41.75	29.5	160	9
	76MHAR60366	1460	1581	59.5	35.75	41.5	85	5
	76MHAR60426	1809	1956	59.5	41.75	41.5	98	6
	76MHAR66366	1515	1640	65.5	35.75	41.5	93	5.5
	76MHAR66426	1871	2024	65.5	41.75	41.5	106	6.5
	76MHAR72366	1619	1751	71.5	35.75	41.5	100	6
	76MHAR72426	1982	2144	71.5	41.75	41.5	115	7
	76MHAR78366*	1890	2043	77.5	35.75	41.5	108	6.5
	76MHAR78426	2261	2444	77.5	41.75	41.5	118	7.5
	76MHAR84366	1936	2092	83.5	35.75	41.5	115	7
	76MHAR84426	2307	2495	83.5	41.75	41.5	135	8
	76MHAR96366	2035	2202	95.5	35.75	41.5	140	7.5
76MHAR96426	2406	2602	95.5	41.75	41.5	160	9	

**DIMENSION KEY**

W - width  
 D - depth  
 H - height

Dimensions are in inches and approximate. Contact Customer Service if dimensions are critical.

**STANDARD FINISHES**

For a complete list of standard wood finishes please see Page 117. Disc bases and metal legs are available in a Brushed Stainless finish.

# ARTEMIS MEDIA HUB | BAR HEIGHT RUNOFFS

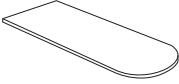
Description	Model	Wood Species		W	D	H	Shipping Weight	Cubic Feet
		Rift Oak/ Palette	Cherry Maple Walnut					
	76MHBR60366	1460	1581	59.5	35.75	41.5	85	5
	76MHBR60426	1809	1956	59.5	41.75	41.5	98	6
	76MHBR66366	1515	1640	65.5	35.75	41.5	93	5.5
	76MHBR66426	1871	2024	65.5	41.75	41.5	106	6.5
	76MHBR72366	1619	1751	71.5	35.75	41.5	100	6
	76MHBR72426	1982	2144	71.5	41.75	41.5	115	7
	76MHBR78366	1890	2043	77.5	35.75	41.5	108	6.5
	76MHBR78426	2261	2444	77.5	41.75	41.5	118	7.5
	76MHBR84366	1936	2092	83.5	35.75	41.5	115	7
	76MHBR84426	2307	2495	83.5	41.75	41.5	135	8
	76MHBR96366	2035	2202	95.5	35.75	41.5	140	7.5
	76MHBR96426	2406	2602	95.5	41.75	41.5	160	9

**ORDERING NOTES:** Please note that 2" Square Metal legs cannot be specified with the Bullet Runoff top.

	76MHVR6036-426	1671	1809	59.5	35.75	41.5	98	6
	76MHVR6042-486	2058	2223	59.5	41.75	41.5	110	6.5
	76MHVR6636-426	1731	1871	65.5	35.75	41.5	106	6.5
	76MHVR6642-486	2131	2303	65.5	41.75	41.5	120	7
	76MHVR7236-426	1834	1982	71.5	35.75	41.5	115	7
	76MHVR7242-486	2254	2437	71.5	41.75	41.5	130	7.5
	76MHVR7836-426*	2089	2261	77.5	35.75	41.5	118	7.5
	76MHVR7842-486	2507	2714	77.5	41.75	41.5	145	8
	76MHVR8636-426	2134	2307	83.5	35.75	41.5	135	8
	76MHVR8642-486	2560	2768	83.5	41.75	41.5	155	9
	76MHVR9636-426	2221	2405	95.5	35.75	41.5	160	9
	76MHVR9662-486	2668	2884	95.5	41.75	41.5	175	10

	76MHVAR6036-426	1723	1862	59.5	35.75	41.5	98	6
	76MHVAR6042-486	1855	2004	59.5	41.75	41.5	110	6.5
	76MHVAR6636-426	1781	1927	65.5	35.75	41.5	106	6.5
	76MHVAR6642-486	2193	2373	65.5	41.75	41.5	120	7
	76MHVAR7236-426	1886	2040	71.5	35.75	41.5	115	7
	76MHVAR7242-486	2321	2508	71.5	41.75	41.5	130	7.5
	76MHVAR7836-426*	2154	2327	77.5	35.75	41.5	118	7.5
	76MHVAR7842-486	2584	2793	77.5	41.75	41.5	145	8
	76MHVAR8436-426	2197	2378	83.5	35.75	41.5	135	8
	76MHVAR8442-486	2636	2851	83.5	41.75	41.5	155	9
	76MHVAR9636-426	2287	2476	95.5	35.75	41.5	160	9
	76MHVAR9642-486	2746	2970	95.5	41.75	41.5	175	10

## ORDERING PROCEDURE

To order, please specify the following:

- 1) Krug product model number
- 2) Wood species and finish, see Page 11
- 3) Wood edge detail, see Page 3
- 4) Pull style, see Page 4
- 5) Grommet location if applicable

## STANDARD FINISHES

For a complete list of standard wood finishes please see Page 117.

# ARTEMIS MEDIA HUB | BASES

Description	Model	Price	W	D	H	Shipping Weight	Cubic Feet
4" Square Wood Leg	76LG429S1	516	4	4	29	-	1
	76LG442S1*	556	4	4	41	-	1.5



**Legs required per runoff: 1**

4" Diameter Metal Leg	76LG429DB	759	4	4	28	-	1
	76LG442DB*	811	4	4	41	-	1.5



**Legs required per runoff: 1**

Disc Base	76141828	313	18	18	28.5	30	8
	76141842*	350	18	18	41	35	8.5



**Legs required per runoff: 1**

2" Square Metal Leg	76LG229M	480	2	2	28	-	1
	76LGX242M*	537	2	2	41	-	1.5



**Legs required per runoff: 1**

**ORDERING NOTES:** Please note that 2" Square Metal legs cannot be specified with the Bullet Runoff top.

T-Base	76LG2029TR5	465	3	20	28	19	3
	76LG2042TR5*	706	3	2	41	26	4



**Legs required per runoff: 1**

**ORDERING NOTES:** Please note that 29" base is to be used to achieve a desk height runoff, 42" base is to be used for bar height runoff.

**DIMENSION KEY**

W - width  
D - depth  
H - height

Dimensions are in inches and approximate. Contact Customer Service if dimensions are critical.





# ARTEMIS MEDIA HUB | STORAGE

Description	Model	Cherry		W	D	H	Shipping Weight	Cubic Feet
		Rift Oak/ Palette	Maple Walnut					
Media Hub Storage & Waste/Recycling 	76MHST241872103L	4238	4452	24	17.75	72	132	20
	76MHST241872103R	4238	4452	24	17.75	72	132	20
	76MHST241880103L*	4299	4515	24	17.75	80	156	22.5
	76MHST241880103R	4299	4515	24	17.75	80	156	22.5

Media Hub Storage, 5 Closed 	76MHST24187211L	2696	2830	24	17.75	72	160	20
	76MHST24187211R	2696	2830	24	17.75	72	160	20
	76MHST24188011L*	3291	3456	24	17.75	80	188	22.25
	76MHST24188011R	3291	3456	24	17.75	80	188	22.25

Media Hub Storage, 2 Box/1File Drw/ 3 Closed 	76MHST24187293L	3713	3899	24	17.75	72	118	20
	76MHST24187293R	3713	3899	24	17.75	72	118	20
	76MHST24188093L*	3867	4061	24	17.75	80	152	22.25
	76MHST24188093R	3867	4061	24	17.75	80	152	22.25

Media Hub Storage, 2 Box/1File Drw/ 3 Closed Frosted Glass Doors 	76MHST24187293XL	4811	5050	24	17.75	72	118	20
	76MHST24187293XR	4811	5050	24	17.75	72	118	20
	76MHST24188093XL*	5065	5319	24	17.75	80	152	22.25
	76MHST24188093XR	5065	5319	24	17.75	80	152	22.25

Media Hub Wardrobe, Coat Hooks & Shelf 	76MHWR24187201L	2481	2606	24	17.75	72	148	20
	76MHWR24187201R	2481	2606	24	17.75	72	148	20
	76MHWR24188001L*	2817	2957	24	17.75	80	174	22.5
	76MHWR24188001R	2817	2957	24	17.75	80	174	22.5

## ORDERING PROCEDURE

To order, please specify the following:

- 1) Krug product model number
- 2) Wood species and finish, see Page 11
- 3) Wood edge detail, 3
- 4) Pull style, see Page 4
- 5) Grommet location if applicable

\*Indicates model illustrated by line drawing.

## CODE DESCRIPTION

103 - waste/recycling  
 11 - closed bookcase  
 93 - 2 Box/1File Drw/ 3 Closed  
 X - frosted glass  
 01 - wardrobe

## STANDARD FINISHES

For a complete list of standard wood finishes please see Page 117.

# ARTEMIS MEDIA HUB | POWER / MEDIA

Description	Model	Price	W	D	H	Shipping Weight	Cubic Feet
HDMI Technology Bay, Graphite Gray	88HDMITB	9746	13.25	8	9.5	-	-



HDMI to VGA Adaptor pack with Audio Support	88HDMI/ VGA	599	-	-	-	-	-
---	-------------	-----	---	---	---	---	---



HDMI to Display Port & Adaptor Pack	88HDMI/DP	187	60	2.5	1	5	0.75
-------------------------------------	-----------	-----	----	-----	---	---	------



HDMI to Mini Display Port & Thunderbolt Adaptor Pack	88HDMI/ MDP	164	3.5	1.75	-	5	0.25
--	-------------	-----	-----	------	---	---	------



This module includes: 4 simplex receptacles, 4 HDMI show me cables, HDMI 4 position switchbox, 2 plate cutouts, 15' HDMI monitor cable, 108" power cord.

**ORDERING NOTES:**

This module is mounted in the runoff tops near the media hub cabinet.  
 This module is large and knee clearance can be an issue on 36" deep tops if someone is seated next to it.  
 Technology adaptors are available for use in the 2 plate cutouts. Please see below for options.

**DIMENSION KEY**

W - width  
 D - depth  
 H - height

Dimensions are in inches and approximate.  
 Contact Customer Service if dimensions are critical.

# ARTEMIS | WOOD FINISHES

## WOOD FINISHES

Standard wood finishes are:  
SPECIES FINISH

Cherry	Light Cherry Natural Cherry American Cherry Medium Cherry Standard Cherry Imperial Cherry Appalachian Cherry Sable Cherry
Maple	Clear Maple Honey Maple Wheat Maple
Oak*	Light Oak SilverGrey on Oak Harvest Oak Mahogany Oak
* Oak veneers are rift cut	Medium Cherry on Oak Mellow Oak Walnut on Oak Espresso on Oak
Walnut	Natural Walnut Regular Walnut Mahogany on Walnut Dark Walnut Cordovan Walnut

## WOOD FINISHES TO MATCH STANDARD LAMINATES

- Willow on Rift Oak
- Dune on Rift Oak
- Portobello on Rift Oak
- Ash on Rift Oak
- Copper on Cherry
- Shiraz Cherry
- Park Avenue Walnut
- Chocolate on Walnut
- Nutmeg on Walnut
- Dark Walnut
- Hardrock Maple

## Natural Characteristics of Wood

Wood is a natural product with inherent color variations that will never be fully mitigated by the finishing process. Please anticipate variation in colors within a single unit, from piece to piece, and from Krug wood finish samples. If a very close match is required, a sample must be provided with the order and an upcharge will apply. Exact color matches are not possible.

## Custom Wood Finishes

Add 10% list to your order for special finishes, minimum upcharge is **\$551 list** per finish per order. (For example, on all orders up to \$5512 list, an upcharge of **\$551 will list apply**, on orders \$5512 and up add 10% list to your order.) For orders with special finishes, a sample that is a minimum 3" by 3" must be received with the order. Special finishes may add additional lead time to production schedules. Since wood is a natural product, some variations in grain, color and stain acceptance will occur. In our finishing processes, we try to minimize variations, but some variation between samples and finished goods should be anticipated.

## Dual Finishes

Add 10% list per item if specifying dual finish.

## Palette Finishes

Artemis Casegoods are available fully finished in Palette solid color finishes at the same pricing as the Rift Oak pricing in the price list. Artemis Casegoods can also be specified with a combination of PALETTE finishes and veneer. For pricing and specific lead times, please contact Customer Service. Please note PALETTE finishes are not available on the KrugExpress Program.

When specifying Palette in first column pricing please change the model number prefix to 74. ie. 74OHW721616

## PALETTE FINISHES

Standard solid color finishes are:  
Black White Sand Soft green Steel blue Slate

# ARTEMIS | NON-STANDARD PRODUCT GUIDELINES FOR PRICING

## PRICING METHODS

Customer widths: Apply the price that is one standard size larger than the desired case size (but same depth). Example: required dimension is 74" x 24", so take the price of the 78" x 24" unit. Customer depths: Apply the price of the same unit one size deeper (but same width). Example: required dimension is 72" x 26", so take the price of the 72" x 30" unit. Custom width & depth: Apply the price of the same unit both one size wider and one size deeper. Example: required dimension is 74" x 26", so take price of the first standard size above 84" x 30" unit.

Custom height of desk height cases, Add:	18% (31-32" H)
Grommets in non-standard positions, add:	\$152 list
To remove hutch or overhead doors, deduct:	4% list
Bookcase with optional pull out printer shelf, add:	\$238 list
Bookcase with optional vent in back (includes 2 vents and 1 grommet), add:	\$302 list
2 lateral file drawers on shelves - convert to half open, add	15% list
2 lateral file drawers larger than largest shown on price list, add:	15% list
To remove storage doors for open shelves, deduct:	4% list
Non-standard extension on drawer slides.	

Non-standard drawer depths in standard depth pedestals.

Glass door – any style.

Glass – face mounted modesty panels.

Perforated modesty panels.

Cases with curvilinear tops where the radius becomes non-standard.

A/V cabinets.

Any case with flipper doors.

Please contact Specials Coordinator or Krug Customer Service at 1.888.578.KRUG if you require assistance.

PLEASE NOTE: Cases with non-standard features do not apply to the rules above.

# ARTEMIS | INSTALLATION INSTRUCTIONS



Drawers will be offered for letter and legal size filing. All units are equipped with file bars that are fixed in place for shipping.

### Desk Pedestal File Drawers

Filing Capacity:  
 15" DRAWERS:  
 21" of letter filing front to back or  
 12" of legal filing side to side  
 22" pedestal drawer depths allow only one row of side to side files.  
 Weight capacity of pedestal file drawers is 90 lbs.  
 Credenza and Return Pedestal File Drawers



Filing Capacity:  
 15" DRAWERS:  
 15" of letter filing front to back or  
 12" of legal filing side to side  
 16" pedestal drawer depths allow only one row of side to side files.  
 Weight capacity of pedestal file drawers is 90 lbs.  
 Credenza, Return or Storage Lateral File Drawers

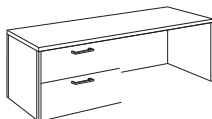

Filing Capacity:  
 30" WIDE DRAWERS:  
 30" letter filing front to back, or 25" legal filing  
 side to side 15" or legal filing front to back.  
 When filing front to back, 30" lateral file drawer widths allow two rows of  
 letter filing, but only one row of legal file width.

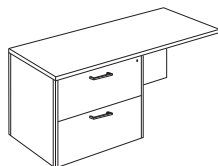

Filing capacity:  
 36" WIDE DRAWERS:  
 30" letter filing front to back, or  
 36" legal filing side to side, or 30"  
 legal filing front to back.  
 Weight capacity of lateral file drawers is 135 lbs.

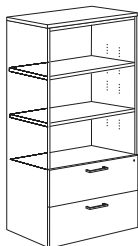

### Linking Units, Tops and Returns

It is important that the main units (desk, credenza) to which the linking unit or return is being attached be in their final position and leveled. Units are connected with mending plates under the worksurface and from the modesty and to the end panel off the connecting units. Attach the mending plates under the worksurface, level cases if necessary by adjusting the glides to achieve flush and firm joints before installation of mending plates to modesty and end panels.

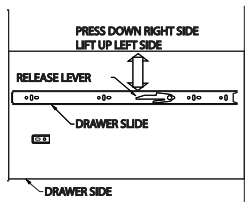

### Drawer Removal

Pull drawer and slide out to the full extension position. With index finger, lift up the release lever on the left and press down the release lever on the right side of the drawer (as shown). Pull out the drawer with the attached drawer channel from the cabinet member. To re-assemble, insert the drawer through the guide.

### Glide Adjustment

Raise one corner of the unit at a time and adjust the glide to the desired height by turning the glide to the hole. Make sure unit is level after adjusting the glides. Please note that the maximum adjustment range of the glides is 1 1/4". When moving units after glides have been inserted, dial the glides to the lowest position to prevent damage.

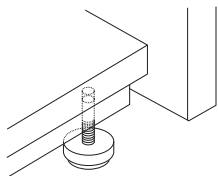

### Door Adjustments

Hinges on all bookcase, overhead and hutch doors are designed to be adjusted for depth, horizontal and vertical alignment. This is easily done by adjusting the appropriate screw. See drawing. To remove a door, pull the release clip and pull out the door, disconnecting hinges.

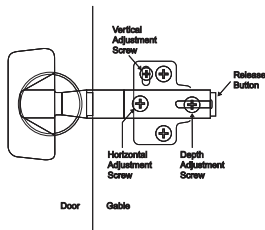

# ARTEMIS | INSTALLATION INSTRUCTIONS

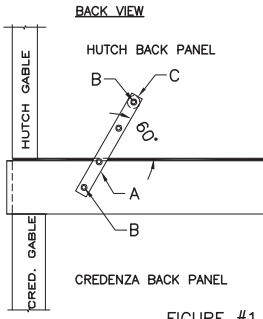

FIGURE #1

## Hutch Installation

Before installing the hutch, insure that the worksurface has been placed in the final position and leveled. The worksurface should then be moved out a sufficient distance to allow access to the back. It is recommended that the minimum amount of movement be used with the leveling glides extended to prevent damage to the glides. The hutch comes with self-adhesive foam strips that must be applied to the bottom edge prior to placing the hutch on the credenza. The foam is best applied with the hutch lying on its back. Do not leave any gaps in the foam strip, in order to prevent scratches to the credenza top while placing the hutch. Place the hutch securely on the worksurface. Try to minimize any movement of the hutch to prevent scratching. Use of a blanket on the front portion of the credenza is recommended. Using the supplied hardware, screw the  $60^\circ$  at bracket (A) to the top of the credenza at each end, using the  $3/4"$  screws (B). Swing the bracket up to approximately  $60^\circ$  and place the supplied washer (C) behind the top hole in the bracket. Screw through the bracket and washer into the hutch back with the  $3/4"$  screws (B). Tighten all screws. Move combined hutch and credenza back to final location. Check for level again and adjust as required.

## Overhead Unit

The wall mount overhead units must be installed on wall studs. The first step for installation is to locate the studs in the wall where the overhead is to be mounted. Position the overhead hanger rail on the wall to insure studs line up with pre-drilled holes in the hanger rail and mark the location on the wall. Drill holes at the marked hole locations. Fasteners are to be provided by the installer, so hole size will be determined by size of fastener chosen. If studs cannot be accessed, then appropriate drywall plugs or butterfly bolts should be used. If the end of the wall rail is further than 3" from a stud, toggle bolts must be fastened through holes 1 and 3. Fasten the mounting rail to the wall insuring that it is level. Remove the black plugs located on the inside face of the back panel to gain access to the adjusting screws on the hanging brackets. Hang the overhead on the mounting rail. The hanging brackets provide vertical and plumb adjusting screws. Level the cabinet by using these screws. All brackets must be adjusted so that they all support the cabinet. When leveling of the overhead is complete, insert the black plugs in the holes to cover the adjusting screws. Installation instructions included with each case must be followed exactly.

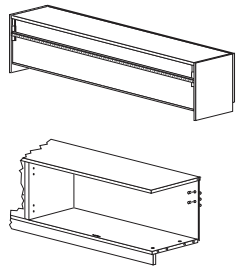

# ARTEMIS | HEIGHT ADJUSTABLE WORKSURFACE WITH BASE ENCLOSURE

## Single Stage Mechanism With Base Enclosure

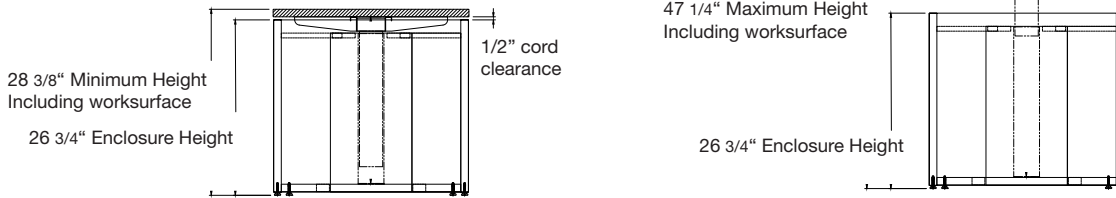

The Single Stage mechanism with Base Enclosure has an adjustable height range of 28 3/8 - 47 1/4 inches. When the worksurface is at the lowest stage - desk height, the space between underside of the worksurface and the top of the Base Enclosure is 1 1/2 inches.

## Dual Stage Mechanism With Base Enclosure

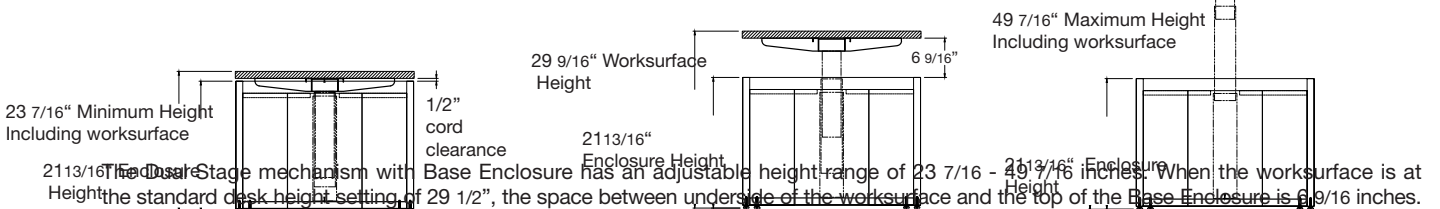

The Dual Stage mechanism with Base Enclosure has an adjustable height range of 23 7/16 - 49 7/16 inches. When the worksurface is at the standard desk height setting of 29 1/2", the space between underside of the worksurface and the top of the Base Enclosure is 6 9/16 inches. This allows for the full range of height adjustments.

Custom Base Enclosures for the Dual Stage are available decreasing the gap below the worksurface to 1 1/2" inches.

Caution: this eliminates the ability to use the lower stage settings.

Custom Base Enclosures to further lower the minimum worksurface height are also available, removing the inside enclosure floor completely and allowing a minimum desk height of 22 7/16". Contact customer service for a quote.

## GRADED-IN UPHOLSTERY PROGRAMS

Krug has partnered with several textile brands to grade in their offerings, designed to provide a wide range of upholstery selections for our seating products.

Upholstery pricing and availability is subject to change without notice. We grade this upholstery according to the pricing of the fabric suppliers - when their pricing changes, the Krug grade may change. When placing an order, a Krug customer must specify the complete upholstery number, along with the appropriate Krug model number and finish. Krug will supply the complete product at the prices listed. Orders specifying graded-in upholstery cannot be cancelled once the upholstery has been ordered.

### Upholstery Grades

To determine the price of a product for graded-in upholstery, use the reference lists located on Krug's website under - Products - Textiles, to view the upholstery grade (1-9). Krug is not responsible for the discontinuation of this upholstery. Please contact Customer Service for information on upholstery not listed.

When two upholstery selections are specified for use on seating, the higher grade upholstery price will apply to the order.

High Performance upholstery; Polyurethane, Vinyl or Crypton, is particularly suitable for healthcare and other intensive-use environments.

### Upholstery Samples

If you require additional samples or memos for presentation, please contact fabric supplier directly.

### Flammability Standards

- Tunnel Test Surface Ratings Class A rating
- Class 1 UFAC
- Passes State of California Technical Bulletin CAL 117-2013

Please contact fabric supplier directly for further flammability information pertaining to specific upholstery.

### Special Conditions

Acknowledgements will give the estimated delivery date of the finished product. Some upholstery is imported, and availability may affect estimated delivery time. For large projects, please contact fabric supplier directly for availability of yardage.

## TACKBOARD FABRICS

### KRUG PANEL FABRIC PROGRAM

Tackboards can be upholstered in COM material supplied by the customer, and in a selection of stocked tackboard fabrics supplied by Momentum. The in-stock Momentum fabrics are priced at Grade 1 and are available on Krug Express. They are 100% polyester. For additional information and color selections, please refer to our Panel Fabrics card and Krug's website. [www.krug.ca](http://www.krug.ca) If memo samples are required please call Momentum at 1-800-366-6839. The Momentum panel fabrics pass ASTM-E84-87 Fire Codes.

### PROGRAM DETAILS

KrugExpress orders are ready to ship by the date acknowledged. Delivery and shipping schedules may result in actual shipping of orders at a later date. Statutory holidays and scheduled factory vacations may add to acknowledged lead times of KrugExpress orders. Unless otherwise specified on the order, the customer's standard method of shipping Krug products will be utilized. Available factory capacity for KrugExpress is filled by orders received on a "first come, first serve" basis. If the normal KrugExpress lead time is not available for your order because available capacity has been filled, you will be immediately advised of the earliest available ready-to-ship date. Please consult your Customer Service representative in advance if you wish to confirm the specific lead time availability for a KrugExpress order. Orders must be received by midnight of a given day for that day to be considered the official day the order is received. Order lead times are acknowledged from the date the order is received, but not including the date the order is received. KrugExpress orders must be "clean" when received in order to be considered officially received on a given day, and lead times will be acknowledged from the date orders are determined to be "clean". Changes to KrugExpress orders are not allowed under any

circumstances. Orders for product on KrugExpress must clearly state: "KrugExpress". \*Some conditions apply. Please note PALETTE finishes are not available on KrugExpress.

### CASEGOODS PROGRAM

Orders for casegood products on the KrugExpress program may be subject to quantity maximums. Please contact Krug Customer Service for more information. Quantity maximums are dependent upon available capacity, in order to insure that we ship all orders on time. Only actual casegood pieces and conference tables tops and bases are considered "units". Items such as tasklights, tackboards, keyboard trays and drawers, electrical and wire management components, etc., are not considered under the quantity restrictions. For example, a typical office configuration that includes a desk, linking unit, credenza and hutch/overhead, equals a total of four units for the purposes of the quantity maximum. Only Krug In-stock panel fabric is available on the KrugExpress program. Only standard wood finishes are available for KrugExpress orders. Grommets can be specified in standard positions only. KrugExpress also includes all Krug seating and occasional tables as well as Krug conference products to complement this casegoods offering.

## KRUGEXPRESS

## CUSTOMER’S OWN MATERIAL - C.O.M.

### Customer’s Own Material (COM)

**COM must be received three weeks prior to the acknowledged ship date. Orders with COM not received by the required deadline will be delayed.**

A description of the fabric, including supplier name, fabric name and color number must be included with the purchase order. When the COM fabric is received at Krug, it must be clearly identified with the fabric name and color, and tagged with name of the Krug customer and purchase order number. Krug will inspect all COM fabric when received to determine if it will be suitable for upholstery. Where Krug feels that the fabric or leather specified will compromise the quality or integrity of our products, customers will be contacted to direct these concerns. Further, Krug reserves the right to refuse to accept and use any COM fabrics or leathers that will compromise our products in any way that is unacceptable to Krug. Krug cannot assume responsibility for the durability or tailoring quality of customer’s own material.

Yardage specified in this price guide is approximate. In the case of multiple product orders, multiply the number of items by the COM yardage specified to determine fabric required, unless otherwise indicated. Additional yardage may be needed if the material is less than 54” wide, or patterned or striped and requires matching. As fabric is applied horizontally, non-directional fabrics are recommended. COM fabrics are applied as they come off the roll unless otherwise specified. All striped fabrics will be applied vertically unless otherwise stated by the customer and after approval by Krug. It is the customer’s responsibility to advise Krug if the upholstery is to be applied otherwise, and to advise Krug of any special upholstery instructions. Special instructions should be sent to Krug Customer Service, including a sample (or photocopy) of the fabric. Krug is not responsible for instructions sent with the fabric rolls, or for the method of upholstery if no instructions have been provided. COM fabrics for tackboards may be specified in either Maharam or Momentum panel fabrics. Krug is not responsible for determining if a fabric is not ideal for tackboard application.

Please contact Maharam at 1-800-645-3943 or Momentum at

### COM Shipping Procedures

**For tackboard COM fabrics, please send fabrics to:**

**Krug Inc.  
111 Ahrens Street  
Kitchener, Ontario  
Canada N2H 4C2  
Attention: RECEIVER**

All packages must be clearly marked “For Customs Clearance by Willson International Custom Brokers”. According to the North American Free Trade Agreement (NAFTA), goods shipped between the United States and Canada can qualify for exemption from all duties, or for a reduction in duties, if the goods can be proven to originate in either the United States, Canada or Mexico. Canada Customs requires that a NAFTA Certificate of Origin and a Commercial Invoice be completed and sent with the fabric shipment. The Commercial Invoice must clearly state the description of the fabric, the selling price, the make-up or content, and the purchaser. The absence of these two documents will delay the shipments at the U.S./Canada border, thereby potentially delaying the customer order. If the total value of the shipment is less than \$1200 U.S., Customs will accept a Low Value Statement of Origin in place of the NAFTA Certificate of Origin. The Low Value Statement must be signed by a representative of the exporting company. This statement may either be included on the commercial invoice or attached to the invoice.

Krug is happy to answer any questions or concerns about COM shipping procedures and the required documents. Please contact our Customs Specialist at 1.888.578.5784.

## STANDARD LAMINATE PROGRAM

### LAMINATES

Krug’s in-stock Laminates are available in 17 different laminate selections. Please note that 4 of the colors (Gingerbread, Portobello, Ash and Willow) have textured finishes and may not be appropriate for use in patient areas due to infection control concerns. Minimum order quantities and extended lead times may apply for exotic laminate colors, please check with customer service. Polymer Edge will be selected to match the worksurface. Krug’s previous laminate in-stock program will be phased out as in-stock supply depletes. Please contact customer service for availability.

### IN-STOCK LAMINATES

Wood Grain Laminates	High Pressure Laminate Supplier	Textured Wood Grain Laminates	High Pressure Laminate Supplier
Champagne	Tafisa T492CR	Gingerbread	Tafisa T556UR
Hardrock Maple	Formica 86992-58	Portobello	Tafisa T557UR
Dune	Tafisa T491CR	Ash	Tafisa T535AT
Copper	Tafisa T521CR	Willow	Tafisa T543AT
Shiraz Cherry	Tafisa T472CR		
Park Avenue Walnut	Wilsonart 7984-38	<b>Solid Laminates</b>	
Chocolate	Tafisa T498CR	Designer White	Wilsonart D354-60
Nutmeg	Tafisa T477CR	Platinum	Tafisa T202CR
Dark Walnut	Tafisa T469CR	Earth	Tafisa T767CR
	Almond - Black- Shadows - Edgewood Sycamore - Gunstock Walnut	Charcoal	Tafisa T228CR

### PHASE OUT LAMINATES

### Non-Stocked Laminates

For specific lead time and application questions, please contact Krug Customer Service for your requirement. Upcharges will be applicable for non-stocked laminates, depending on their cost. Non-stock laminates may require a minimum order quantity, please contact customer service. Stocked polymer edges only can be specified for use with non-stocked laminates or tops will be self-edged.

**ARTEMIS LAMINATE | TABLE OF CONTENTS**

445	Environmental Summary
446	Laminates
447	General Product Specification
447	Non-Standard Product Guidelines for Pricing
455	Sample Configuration
456	Desks
465	Returns
477	Linking
479	Credenzas
486	Overheads
488	Hutches
492	Modular Pedestals
493	PowerPorts
496	Keyboard Tray & Cable Management
497	Bookcases
498	Storage
503	Wardrobes
504	Modular Tops & Meeting Tables
505	Modular Support
507	Reception
508	Metal Modular Components
512	Media Wall



# ARTEMIS LAMINATE | ENVIRONMENTAL SUMMARY

## LEED CERTIFICATION



MATERIAL CONTENT:

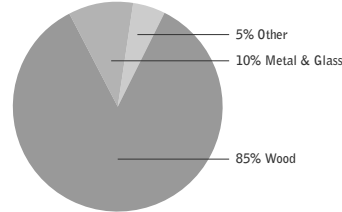

PRE-CONSUMER RECYCLED CONTENT - 81%

POST-CONSUMER RECYCLED CONTENT - 3%

Credit	Description	CONTRIBUTES TO
Credit 2.1 - 2.2	Construction Waste Management	1-
Credit 3.3	Resource Reuse	1 point
Credit 4.1	Recycled Content	1 point
Credit 4.2	Recycled Content	1 point
Credit 4.5	Low Emitting Materials, (MUST BE REQUESTED ) Composite Wood & Laminate Adhesives	1 point
Credit 5.1	Regional Materials*	1 point
Credit 6	Rapidly Renewable Materials (MUST BE REQUESTED )	1 point
Credit 7	Certified Wood (MUST BE REQUESTED )	1 point

\*This credit is only applicable if in total 20% of the combined value of the procurement of construction materials and in the furniture are manufactured within a radius of 500 miles. This credit will apply if the installation of the finished product occurs within 500 miles of Kitchener, Ontario.

### level® CERTIFICATION

BIFMA's e3 Furniture Sustainability Standard is a voluntary, multi-attribute standard that measures the degree of sustainability of furniture. This standard evaluates product and company environmental attributes and compliance systems in a wide range of elements which include Materials, Energy & Atmosphere, Human & Ecosystem Health and Social Responsibility. Artemis products have earned level®, BIFMA's sustainability certification program for furniture, certification through third-party verification against the e3 standard. All Artemis products can be supplied with level® certification. In order to accomplish this, the product must also be ordered with the air-emissions-certification option. Contact customer service for information and upcharges.



### AIR-EMISSIONS

All Artemis products can be supplied with air-emissions-certified materials. Contact customer service for information and upcharges.

### FSC®

FSC® In 2005, Krug received Forest Stewardship Council® (FSC®) Chain-of-Custody certification for our manufacturing facilities. The FSC® Chain-of-Custody tracks certified wood from seedling to final sale. It verifies that the material for our FSC® certified products only come from well-managed, FSC®-certified forests and other controlled sources. FSC® is dedicated to the promotion of responsible forest management worldwide helping to take care of forests for future generations. Artemis Laminate and other Krug products can be specified with FSC® Certification. Contact customer service for further information, pricing and lead times.



www.fsc.org  
FSC® C021699

the mark of responsible forest



In addition, architects, designers, and building professionals can specify FSC®-certified products in order to achieve a point from the US. Green Building Council's Leadership in Energy and Environmental Design (LEED) Rating System.

# LAMINATE - TECHNICAL SPECIFICATIONS

(All references to "Laminate" in this price list mean thermofused melamine. This material is also known as low-pressure laminate or Laminate)

PROPERTIES	DESCRIPTION	(LD 3-2005)	PROGRAM
Wear Resistance	Measure of the ability of the surface to keep its design or color under abrasive wear	400 cycles	400 cycles - Solid Colors 125 cycles - Prints
Appearance	Presence of visual defects on decorative surface	No surface defects	No surface defects
Scratch Resistance	Measure of the ability of decorative surface to scratch by diamond tip tool	n/a	3.4 N
Stain Resistance	Measure of the ability of the decorative surface to resist to stain when exposed to 15 household products see list below of products tested)	1 to 10 no effect 11 to 15 moderate (difficult to perceive the stain)	1 to 10 no effect 11 to 15 moderate
Cleanability	Measure of the ability of a decorative surface to be cleaned when exposed to 15 soiling agents (See list below)	Maximum 20	Maximum 20
Light Resistance	Measure of the ability of a decorative surface to retain its color when exposed to a light source close to sunlight	Slight	Slight
High Temperature Resistance	Measure of the ability of a decorative surface to maintain its color and aspect when exposed to high temperature	Slight	Slight
Radiant Heat Resistance	Measure of the ability of a decorative surface to resist any damage when exposed to a radiant heat source	No effect after 60 seconds	No effect after 60 seconds
Boiling Water Resistance	Measure of the ability of a decorative surface to resist any damage when exposed to boiling water for 20 minutes	No effect	No effect
Impact Resistance	Measure of the maximal falling height of a steel ball that does not cause fracture to the decorative surface	381 mm/n 15 in	381 mm/n 15 in
Fire Resistance	Measure of flame spread rating under controlled conditions	n/a	Class III
Warping	Measure of the maximal departure of the surface from flatness	n/a	3 mm/m

STAIN RESISTANCE (see above)  
products tested:

STAIN	PREPARATION NOTES	APPLICATION
1. Distilled Water	As received	Apply 2 drops (6 mm spot) cover with watch glass
2. Ethyl Alcohol Solution	A solution of 50% ethyl alcohol and 50% distilled water as received	As above
3. Acetone	As received	As above
4. Household Ammonia	As received (non-sudsing type)	As above
5. 10% Citric Acid	A solution of 10% citric acid in distilled water	As above
6. Vegetable Oil	As received	As above
7. Fresh Coffee	1 teaspoon instant coffee per 180 ml of distilled water	As above
8. Fresh Tea	Brew 1 tea bag per 120 ml distilled boiling water for 2 minutes	As above
9. Ketchup	As received	As above
10. Yellow Mustard	As received	As above
11. 10% Povidone Iodine	As received	As above
12. Black Permanent Marker	As received	Mark spot (6 mm spot), do not cover
13. #2 Pencil	As received	As above
14. Wax Crayon	As received	As above
15. Black Paste Shoe Polish	As received	Apply (6 mm spot) do not cover

\* NEMA is the recognized standard for high-pressure laminates.

# HIGH-PRESSURE WORKSURFACE LAMINATE- TECHNICAL SPECIFICATIONS

PHYSICAL PROPERTIES	NEMA LD3-2005	STANDARD HPLs
Appearance	3.1	No ABC Defects
Light Resistance	3.3	Slight
Cleanability	3.4	20 (maximum)
Stain Resistance (see Products Tested on previous page)	3.4	
Reagents 1-10		No Effect
Reagents 11-15		Moderate
Boiling Water Resistance	3.5	Slight
High Temperature Resistance	3.6	Slight
Ball Impact Resistance - mm - in	3.8	762 (minimum) 30 (minimum)
Radiant Heat Resistance - sec	3.10	100 (minimum)
Dimensional Change	3.11	
Machine Direction - %		1.1 (maximum)
Cross Direction - %		1.4 (maximum)
Wear Resistance - cycles	3.13	400 (minimum)

## ARTEMIS LAMINATE | LAMINATES

### LAMINATES

Krug's in-stock Laminates are available in 17 different laminate selections. Please note that 4 of the colors (Gingerbread, Portobello, Ash and Willow) have textured finishes and may not be appropriate for use in patient areas due to infection control concerns. Minimum order quantities and extended lead times may apply for exotic laminate colors, please check with customer service. Polymer Edge will be selected to match the worksurface. Krug's previous laminate in-stock program will be phased out as in-stock supply depletes. Please contact customer service for availability.

### IN-STOCK LAMINATES

Wood Grain Laminate	LPL SUPPLIER	HPL SUPPLIER
Champagne	Tafisa T492CR	Arborite T492KR
Hardrock Maple	Formica 86992-58	Formica 86992-58
Dune	Tafisa T491CR	Arborite T491KR
Copper	Tafisa T521CR	Arborite T521KR
Shiraz Cherry	Tafisa T472CR	Arborite T472CA
Park Avenue Walnut	Wilsonart 7984-38	Arborite T484KR
Chocolate	Tafisa T498CR	Arborite T498KR
Nutmeg	Tafisa T477CR	Arborite T477KR
Dark Walnut	Tafisa T469CR	Arborite T469KR
<b>Textured Wood Grain Laminate</b>		
Gingerbread	Tafisa L556R	Arborite T556UR
Portobello	Tafisa L557R	Arborite T557UR
Ash	Tafisa L535A	Arborite T535AT
Willow	Tafisa L543A	Arborite T543AT
<b>Solid Laminate</b>		
Designer White	Uniboard 555D	Wilsonart D354-60
Platinum	Tafisa L202C	Arborite T202KR
Earth	Tafisa L767C	Arborite T767KR
Charcoal	Tafisa L228C	Arborite T228KR

### PHASE OUT LAMINATES

#### Solid Laminate

Almond  
Black  
Shadows

#### Exotic Laminate

Edgewood Sycamore  
Gunstock Walnut

Candlelight

Antique White

### Non-Stocked Laminates

For specific lead time and application questions, please contact Krug Customer Service for your requirement. Upcharges will be applicable for non-stocked laminates, depending on their cost. Non-stock laminates may require a minimum order quantity, please contact customer service. Stocked polymer edges only can be specified for use with non-stocked laminates or tops will be self-edged.

### Dual Laminates

Two laminate colors can be combined on the same unit, with one laminate color on the worksurface and another laminate on the rest of the unit, at an upcharge of 5%. Combinations of more than one laminate in the body of the unit are not available.

# ARTEMIS LAMINATE | GENERAL PRODUCT SPECIFICATIONS

## Worksurfaces

Laminate worksurfaces are 1-1/4" thick, and have thermally fused laminate applied to particle board core. High Pressure plastic Laminate (HPL) worksurfaces are 1-1/8" thick, and have plastic laminate applied to particle board core, with a laminate backer. All worksurface height tops have profiled edges on all sides, except when using the M p ofile in a polymer edge on a laminate top. In this case the profile appear on the front and back sides only on desks. On credenza, return, linking unit, and 2 hi storage unit tops the side and back edges are not profiled.

## Modesty Panels

Modesty panels are standard on all desks, and optional on shaped tops, returns, linking units and credenzas.

## Metal Legs

The metal legs in Artemis Laminate have a Silver Metallic finish.

## Locks

Locks are standard on all pedestals and storage unit lateral file drawers. Locks are optional on door fronts and must be specified at time of order. All lock cores are Silver. Locks are not available on glass doors.

## Latches

Bookcase doors are equipped with touch latches mounted inside the top edge of the door when no pulls are specified. Pier hutches have an option of a pull on the pier door only, touch latched will not be provided.

## Drawers

Desk box and file drawers have fully progressive full extension slides and are load rated at 125 lbs. per drawer. All drawer interiors are maple print components with a 1/4" matching laminate bottom. All file drawers are equipped for letter and legal filing. All box/box/file pedestals in desks are supplied with one molded black pencil tray.

## Glides

Adjustable glides are 1-1/2" long and allow for a range of adjustment of 1 1/4".

## Hinges

Hinges on all hutch, overhead and bookcase laminate doors are European style with 165 degree opening. Frosted glass doors have 105 degree opening. All hinges are fully adjustable.

## Pulls

All pulls are die cast with a choice of Silver Metallic powder coat and Grey Metallic powder coat finish options. Pulls are supplied on all drawers.

## Metal Cabinets

Steel frame construction is welded and channels are formed in key areas for strength. Inner frame is 20 gauge metal. Fronts, tops, outer panels are 20 and 22 gauge steel. Standard PAINT FINISH • Silver Metallic Powder Coat • Additional colors are available upon request.

## Testing Information

Artemis Laminate meets or exceeds the testing requirements of ANSI/BIFMA X5.5-2014 and/or X5.9 - 2012.



# ARTEMIS LAMINATE | NON-STANDARD PRODUCT GUIDELINES FOR PRICING

## PRICING METHODS

Custom widths: Apply the price that is one standard size larger than the desired case size (but same depth). Example: required dimension is 74" x 24", so take the price of the 78" x 24" unit. Custom depths: Apply the price of the same unit one size deeper (but same width). Example: required dimension is 72" x 26", so take the price of the 72" x 30" unit. Custom width & depth: Apply the price of the same unit both one size wider and one size deeper. Example: required dimension is 74" x 26", so take price of the first standa d size above 84" x 30" unit.

Custom height of desk height cases: Add	18% (31-32" HI)
Grommets in non-standard positions, add:	\$152 list
To remove hutch or overhead doors, deduct:	4% list
Bookcase with optional pull out printer shelf, add:	\$238 list
Bookcase with optional vent in back (includes 2 vents and 1 grommet), add:	\$302 list
2 lateral file and 3 or 4 closed shelves - convert to half open, half closed shelves, add:	15% lis
2 lateral file and 3 or 4 closed shelves - convert to half open, half wa drobe, add:	15% list
To remove storage doors for open shelves, deduct:	4% list

## EXCEPTIONS TO THE PRICING METHODS ABOVE

Sizes larger than largest shown in Price List.  
 Glass door – any style.  
 Cases with curvilinear tops where the radius becomes non-standard.

Please contact Specials Coordinator or Krug Customer Service at 1.888.578.KRUG if you require assistance.  
 PLEASE NOTE: Cases with non-standard features do not apply to the rules above. Contact Krug Customer Service if you require assistance.

# ARTEMIS LAMINATE | GENERAL PRODUCT SPECIFICATIONS

## EDGE PROFILES



Flat Edge - T



Radius Edge - D

### T and D Profiles Polymer Edge

The T and D profiles are applied to all edges of Desks, Credenzas, Curvilinear Desks, Returns, Linking Units, Corner Units, Bookcase and 2 Hi Storage Units tops. Plan views of each are shown below.

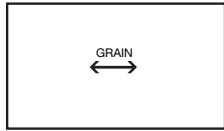

Desks



Returns and Linking Units

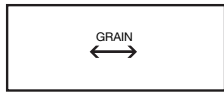

Credenza

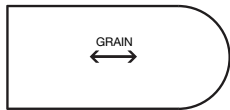
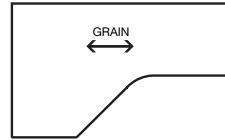

Curvilinear Desks

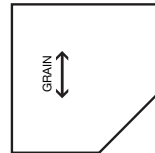

Corner Units

## ARTEMIS LAMINATE | PULLS & LOCKS

### Drawer Pulls

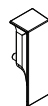

Athena

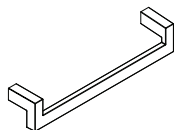

Diana

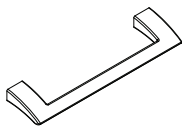

Hera

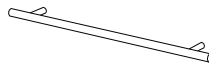

Sono

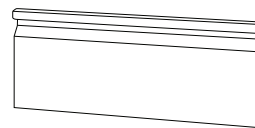

Finger Pull - Metal Cases Only

Artemis pulls are available in two standard finishes - Silver Metallic and Grey Metallic. Please specify finish color on purchase order. Artemis pulls are standard on drawer fronts and can be specified on doors. See below for orientation of pulls

Doors with Pulls Above  
Work Surface Height:

Athena Vertical  
Diana Vertical  
Hera Vertical  
Sono Vertical

Doors with Pulls Below  
Work Surface Height:

Athena Vertical  
Diana Horizontal  
Hera Horizontal  
Sono Horizontal

Pulls on All Drawer Fronts:

Athena Vertical  
Diana Horizontal  
Hera Horizontal  
Sono Horizontal

Artemis Metal Pedestals will be supplied with a finger pull as standard. Diana, Hera and Sono pulls can be specified for metal drawer fronts at no up-charge. Athena pulls will not be available on metal fronts.

### Locks

Locks are provided as standard features on all pedestals, except bookcase pedestals, including those in desks, credenzas, and lateral file storage units. Satin Aluminum lock plugs are located on the fronts of all cases.

Locks are available on the bookcase doors at an **upcharge of \$152 list per set** of (2) doors, please specify at time of order. If a hutch or overhead has an uneven amount of doors the single lock required is **also \$152**. Lock plugs for bookcase doors are generally located on the top inside corner of the door front. Lock plugs for hutch and overhead doors are generally located on the lower inside corners. Suites can be keyed alike at no upcharge, please specify on purchase order.

## ARTEMIS LAMINATE | POWER MANAGEMENT

### GROMMETS - Optional (Top Only)

All cases may be specified with one grommet in a standard position at no upcharge. A **\$152 list upcharge** will apply to additional grommets in standard positions and for grommets requested in non-standard positions a **\$152 list upcharge** will apply.

The grommet position must be indicated for each case on the order. Please specify location of grommet when ordering.



### GROMMETS - Round

A round grommet in a satin metallic finish with an open and shut mouse hole serves to provide cable passage for areas not requiring a large opening. The grommet position must be indicated for each case on the order. Please specify location of grommet when ordering.

Grommets can be field installed with a power drill, 60 mm hole saw. Please keep in mind the location of the grommets when specifying paper managers or pier hutches for use with worksurfaces. For example, a paper-manager on the left-hand side may be used with a "C", "BR" or "AR" grommet.

### POWERPORT

A PowerPort is a unique worksurface mounted module that can be specified to a location that best serves the user's needs. It includes a UL approved electrical, voice and data power bar, containing two 115 - volt electrical simplex outlets which are accessible from the work surface, plus a utility outlet at the end for daisy chaining purposes. 3 data versions are available, please see page 494 for options.

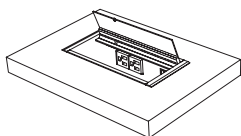

### PORT

A service module having no power bar will serve as a large grommet. A hinged lid easily enables the passage of several cables and devices.

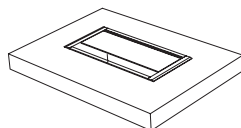

### 76PDVM (Power/ Data/ Voice Module)

The worksurface mounted 76PDVM can be specified to a standard location that best serves the user's needs. It is CSA/UL approved, and comes with 2 - 115 volt electrical convenience outlets, 1 - RJ 11 communication port, and 1 - RJ 45 data port.



Please keep in mind the location of Powerports, Ports, and 76PDVM's when specifying paper managers or pier door hutches for use with worksurfaces. For example, a paper manager or a pier on the left-hand side may be use with a "C", "BR", or "AR" Power port.

## Standard Grommet & PowerPort Positions

### Desks, Credenzas, Link Units & Returns

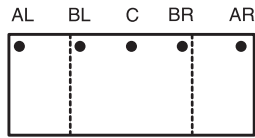

30" deep desks:  
 Position Code:  
 AL – left corner  
 BL – left end beside pedestal gable  
 C – center  
 BR – right end beside pedestal gable  
 AR – right corner

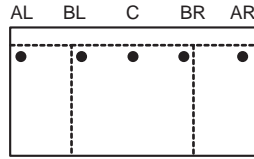

36" deep desks:  
 Position Code:  
 AL – left corner  
 BL – left end beside pedestal gable  
 C – center  
 BR – right end beside pedestal gable  
 AR – right corner

"BR" and "BL" are only available on tops 60" or longer.

### Curvilinear Top Grommets & PowerPorts

"AL" and "AR" are the only grommet and PowerPort locations that apply to **curvilinear returns**. Please note these locations are not applicable on the 36" deep top and fixed modesty panel.

Guest Side

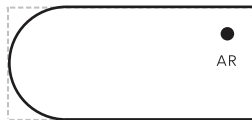

Guest Side



Position code:  
 AL - left corner on right hand return  
 AR - right corner on left hand return

**Curvilinear desk** grommets and PowerPorts can only be specified in "C" position.



User Side



User Side

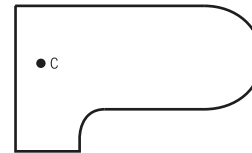

User Side

Position Code: C center

### Crescent Return Grommets

PowerPorts are not available on Crescent returns.

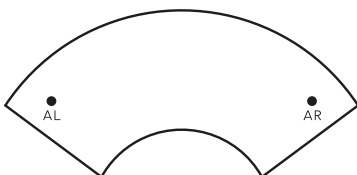

Position Code:  
 AL - left corner on return  
 AR - right corner on return

## ARTEMIS LAMINATE | LAMINATE WORKSURFACES

### Laminate Worksurfaces

Standard Artemis laminate casegoods will have low pressure laminate worksurfaces and a low pressure laminate chassis. Optional high pressure laminate worksurfaces are available.

Worksurfaces are available with the following options:

- 1) Laminate with Polymer Edge
- 2) High Pressure Laminate (HPL) with Polymer Edge.

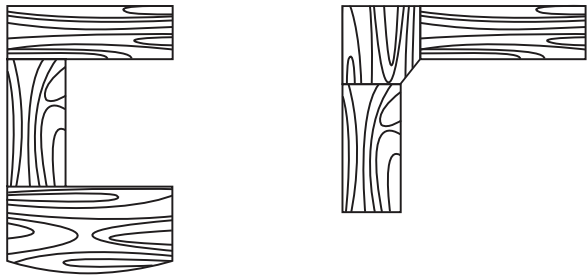

The grain direction runs lengthwise on all worksurfaces .

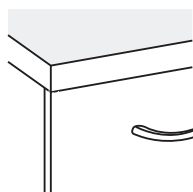

The diagram illustrates the placement of laminate on Krug worksurfaces. The shaded areas represent laminate, while the non-shaded area indicates the polymer edge.

Grain Direction: All components have vertical grain direction except, there will be a horizontal grain on hutch back panels, half modesty panels on desk returns, returns with curvilinear tops, and credenza shell backs. Desk shells, desk returns, gallery desks and linking units incorporate split panels in order to maintain vertical grain direction.

## ARTEMIS LAMINATE | CREDENZAS

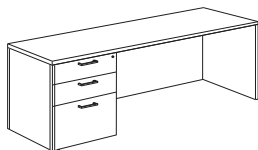

### Credenzas

Artemis Laminate offers a wide variety of credenzas for use as stand alone storage pieces, part of a connected worksurface configuration, or behind a desk.

Choose from single or double pedestal options, with fixed or hinged modesty panel

### Modesty Panels

Credenzas with hinged modesty panels provide easy access to wall mounted electrical sources without wiring difficulties

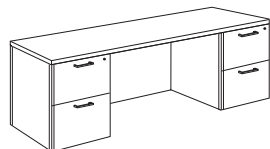

Credenzas with modesty panels have an added finished look, and all cases are available with a wiring grommet in a standard position for added cable management, please specify on your order. Wiring grommets can be specified above the pedestal location

### Pedestals

Artemis Laminate credenzas are available with single, lateral file, combination pedestals or bookcase pedestals.

## ARTEMIS LAMINATE | MEDIA WALL SPECIFICATIONS

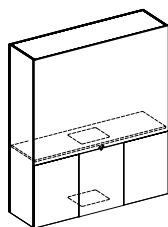



## ARTEMIS LAMINATE | LINKING & CORNER UNITS

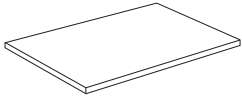

Artemis Laminate linking units and corner units are available in a range of sizes for ease of use in configuring a connected worksurface.

### Linking Units

Linking Units are for use between desks and credenzas in creating a U-shaped configuration, and must be supported at both ends. They are available with or without modesty panels.

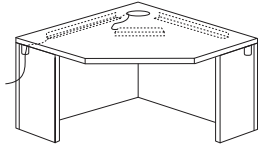

### Corner Units

A corner unit can also be used on a U-shaped configuration, or it can be an integral part of a L-shaped work area with returns or linking units linked to either side.

Corner units have a standard grommet included in the back corner for ease of cable management, and have additional wire management access grommets in the half gables so that cable can be run to other areas of the connected worksurface. This can be assisted by a cut length of wire management cover.

## ARTEMIS LAMINATE | HUTCHES, OVERHEADS, & TACKBOARDS

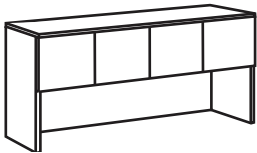

### Hutches and Overheads

Artemis Laminate offers hutch and overhead options for use in a work area configuration

All hutches and overheads include tasklights that are factory installed and require no field adjustment. Tasklights are mounted beneath the cabinet and hidden from view. Selected hutches are available with Silver Metallic framed frosted glass doors.

### Doors

Doors are equipped with fully adjustable European style hinges. Locks are optional and can be specified at time of order for an **upcharge of \$152 per set** of (2) doors. If an uneven amount of doors require locks, the **lock on the single door is \$152**. Locks are not available on glass doors.

### Hutch Power/ Data/ Voice Module

Access to power and data is made simple by using a hutch with a power/data/voice module built right into the tackboard. The module is fully installed at the factory but can be removed to connect data links on site. It features a flip door that retracts into the case of the unit when open.



Please note, not all fabrics are suitable for tackboard application. Tackboard fabric selections should be supplied with the order information.

Tackboards are not included with overheads, see page 487 for pricing. Overhead tackboards include wall mounting hardware and instructions.

Only hutches and overhead tackboards in Krug panel fabrics are available on KrugExpress.

### Tasklights

Tasklights are included with hutches and overheads. On hutches, the tasklight cord is threaded behind the hutch through a standard access grommet on the upper right hand side of the back panel.

Tasklights are installed on the underside of overhead units. Cords run down the right hand side of the tasklight to the worksurface where they can be routed behind the worksurface top. The use of a wall mounted Overhead tackboard conceals the cord from view.

### Installation

Hutch and overhead installation instructions are included with every case or can be found in this guide on page 454. All mounting hardware required is included with the product.

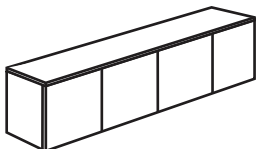

# ARTEMIS LAMINATE | FILING INSTRUCTIONS

Drawers will be offered for letter and legal size filing. All units are equipped with file bars that are fixed in place for shipping.

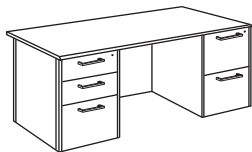

### Desk Pedestal File Drawers

Filing Capacity:  
 15" drawers  
 21" of letter filing front to back or  
 12" of legal filling side to side  
 22" pedestal drawer depths allow only one row of side to side files

Weight capacity of pedestal file drawers is 125 lbs

### Credenza and Return Pedestal File Drawers

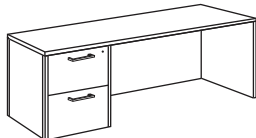

Filing Capacity:  
 15" drawers  
 15" of letter filing front to back or  
 12" of legal filling side to side  
 16" pedestal drawer depths allow only one row of side to side files

Weight capacity of pedestal file drawers is 125 lbs

### Credenza, Return or Storage Lateral File Drawers

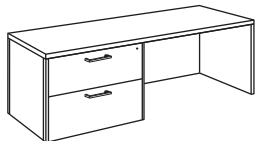

Filing Capacity:  
 30" wide drawers:  
 30" letter filing front to back, or  
 25" legal filing side to side  
 15" or legal filing front to back.  
 When filing front to back, 30" lateral file drawer widths allow two rows of letter filing, but only one row of legal file width

Filing capacity:  
 36" wide drawers:  
 30" letter filing front to back, or  
 36" legal filing side to side, or  
 30" legal filing front to back.

Weight capacity of lateral file drawers is 135 lbs

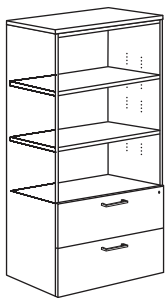
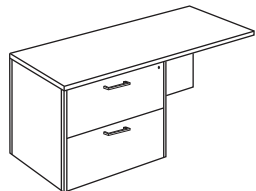

### Linking Units, Tops and Returns

It is important that the main units (desk, credenza) to which the linking unit or return is being attached be in their final position and leveled.

Units are connected with mending plates under the worksurface from the modesty to the end panels. Attach the mending plates under the worksurface, ensure cases are level and if necessary adjust the glides to achieve flush and firm joints before completing installation of mending plates to the modesty and end panels.

### Drawer Removal

Pull drawer and slide out to the full extension position. With index finger, lift up the release lever on the left and press down the release lever on the right side of the drawer (as shown).

Pull out the drawer with the attached drawer channel from the cabinet member. To re-assemble, insert the drawer through the guide.

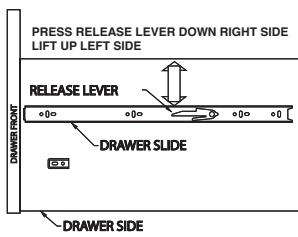

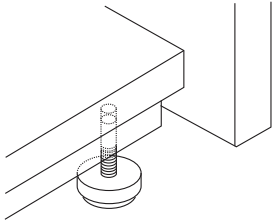

### Glide Adjustment

Raise one corner of the unit at a time and adjust the glide to the desired height by turning the glide in the hole. Make sure unit is level after adjusting the glides.

Please note that the maximum adjustment range of the glides is 1 1/4" on all laminate units. The maximum adjustment range of the glides is 1 5/8" for metal pedestals, 5/8" for metal bookcases and 7/8" for metal storage cabinets.

When moving units after glides have been inserted, dial the glides to the lowest position to prevent damage.

### Hutch Installation

Before installing the hutch, insure that the worksurface has been placed in the final position and leveled. The worksurface should then be moved out a sufficient distance to allow access to the back. It is recommended that the minimum amount of movement be used with the leveling glides extended to prevent damage to the glides. The hutch comes with self-adhesive foam strips that must be applied to the bottom edge prior to placing the hutch on the credenza. The foam is best applied with the hutch lying on its back. Do not leave any gaps in the foam strip, in order to prevent scratches to the credenza top while placing the hutch.

Place the hutch securely on the worksurface. Try to minimize any movement of the hutch to prevent scratching. Use of a blanket on the front portion of the credenza is recommended.

Using the supplied hardware, screw the flat bracket (A) to the top of the credenza at each end, using the 3/4" screws (B). Swing the bracket up to approximately 60° and place the supplied washer (C) behind the top hole in the bracket. Screw through the bracket and washer into the hutch back with the 3/4" screws (B). Tighten all screws. Move combined hutch and credenza back to final location. Check for level again and adjust as required.

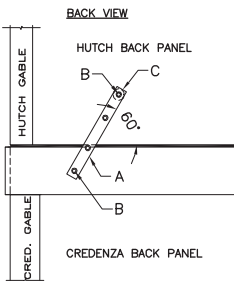

### Door Adjustments

Hinges on all bookcase, overhead and hutch doors are designed to be adjusted for depth, horizontal and vertical alignment. This is easily done by adjusting the appropriate screw. See drawing.

To remove a door, pull the release clip and pull out the door, disconnecting hinges.

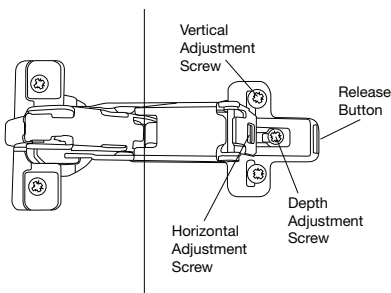

### Overhead Units

The wall mount overhead units must be installed on wall studs. The first step for installation is to locate the studs in the wall where the overhead is to be mounted.

Position the overhead hanger rail on the wall to insure studs line up with pre-drilled holes in the hanger rail and mark the location on the wall.

Drill holes at the marked hole locations. Fasteners are to be provided by the installer, so hole size will be determined by size of fastener chosen. If studs cannot be accessed, then appropriate drywall plugs or butterfly bolts should be used. If the end of the wall rail is further than 3" from a stud, toggle bolts must be fastened through holes 1 and 3. Fasten the mounting rail to the wall insuring that it is level.

Remove the black plugs located on the inside face of the back panel to gain access to the adjusting screws on the hanging brackets. Hang the overhead on the mounting rail. The hanging brackets provide vertical and plumb adjusting screws. Level the cabinet by using these screws. All brackets must be adjusted so that they all support the cabinet. When leveling of the overhead is complete, insert the black plugs in the holes to cover the adjusting screws.

Installation instructions (included with each case) must be followed exactly.

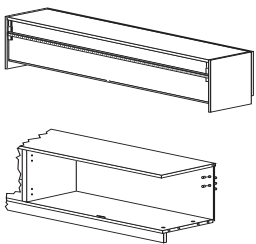

# ARTEMIS LAMINATE | SAMPLE CONFIGURATIONS

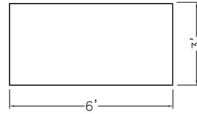
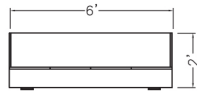
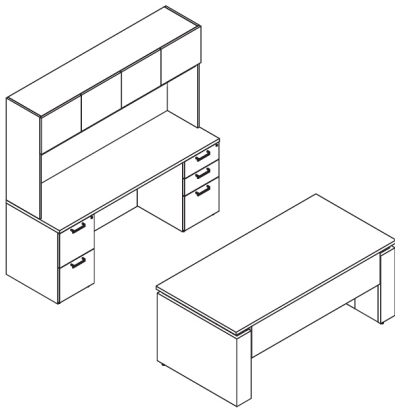

	Model	Laminate/ Poly Edge	High Pressure Laminate/ Poly Edge
Desk	72TD7236	4286	4499
Hutch	72HT721640	3090	3376
Credenza	72CY72244LDRF	3112	3267
<b>TOTAL</b>		10488	11142

\*with laminate hutch

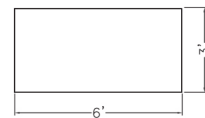
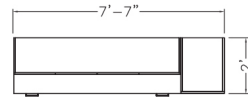
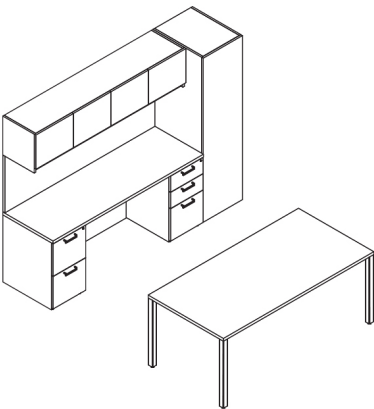

	Model	Laminate/ Poly Edge	High Pressure Laminate/ Poly Edge
Desk	72TD7236M	2080	2968
Overhead	72OHW721616	1563	1563
Tackboard	72TBOHW7224	512	512
Credenza	72CY72244LDRF	2898	3235
Storage	72ST19246911R	1620	1620
<b>TOTAL</b>		8673	9898

\*with laminate overhead & storage

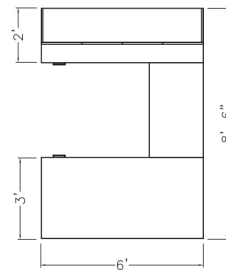
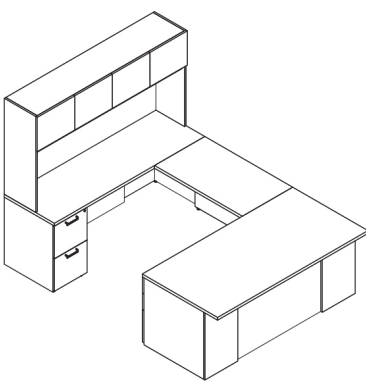

	Model	Laminate/ Poly Edge	High Pressure Laminate/ Poly Edge
Desk	72D72364LORF	2370	2818
Link Unit	72LU4224HX46	669	823
Hutch	72HT721640	2452	2576
Credenza	72C72244XLDR0	1991	2283
<b>TOTAL</b>		7482	8500

\*with laminate hutch

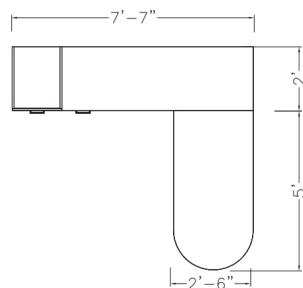
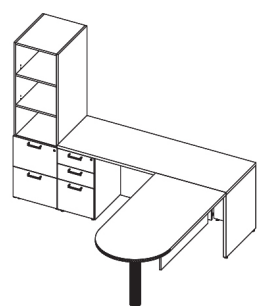

	Model	Laminate/ Poly Edge	High Pressure Laminate/ Poly Edge
Return	72RHB6030RV26D8	1021	1330
Storage	72ST19246990	1861	1861
Credenza	72CY7220LFR0	2585	2936
<b>TOTAL</b>		5467	6127

\*with laminate hutch

# ARTEMIS LAMINATE | DESKS

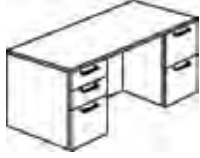
Description	Model	Laminate Top/Polymer Edge	HPL Top/Polymer Edge	W	D	H	KW	Shipping Weight	Cubic Feet
Rectangular Desk	72D60304LDRF	2602	2966	59.75	30	29.5	28.5	218	39
Double Pedestal	72D60304LFRD	2602	2966	59.75	30	29.5	28.5	218	39
	72D66304LFRF	2602	2966	59.75	30	29.5	28.5	218	39
	72D66304LDRF*	2741	3126	65.75	30	29.5	34.5	224	42.75
	72D66304LFRD	2741	3126	65.75	30	29.5	34.5	224	42.75
	72D66304LFRF	2741	3126	65.75	30	29.5	34.5	224	42.75
	72D66364LDRF	2830	3224	65.75	36	29.5	34.5	236	50
	72D66364LFRD	2830	3224	65.75	36	29.5	34.5	236	50
	72D66364LFRF	2830	3224	65.75	36	29.5	34.5	236	50
	72D72304LDRF	2788	3180	71.75	30	29.5	40.5	246	46.5
	72D72304LFRD	2788	3180	71.75	30	29.5	40.5	246	46.5
	72D72304LFRF	2788	3180	71.75	30	29.5	40.5	246	46.5
	72D72364LDRF	2883	3307	71.75	36	29.5	40.5	248	54.75
	72D72364LFRD**	2883	3307	71.75	36	29.5	40.5	248	54.75
	72D72364LFRF	2883	3307	71.75	36	29.5	40.5	248	54.75
	72D78304LDRF	2891	3315	77.75	30	29.5	46.5	248	50
	72D78304LFRD	2891	3315	77.75	30	29.5	46.5	248	50
	72D78304LFRF	2891	3315	77.75	30	29.5	46.5	248	50
	72D78364LDRF	3032	3479	77.75	36	29.5	46.5	248	59
	72D78364LFRD	3032	3479	77.75	36	29.5	46.5	248	59
72D78364LFRF	3032	3479	77.75	36	29.5	46.5	248	59	
72D84364LDRF	3231	3706	77.75	36	29.5	54.5	272	63	
72D84364LFRD	3231	3706	83.75	36	29.5	54.5	272	63	
72D84364LFRF	3231	3706	83.75	36	29.5	54.5	272	63	

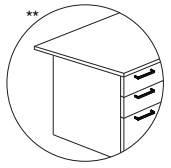

**ORDERING NOTES:**  
 \*\*Shows overhang on 36" Desks

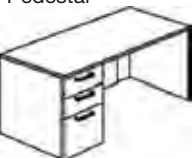
Description	Model	Laminate Top/Polymer Edge	HPL Top/Polymer Edge	W	D	H	KW	Shipping Weight	Cubic Feet
Rectangular Desk Single Pedestal	72D60304LFR0	1929	2297	59.75	30	29.5	43	206	39
	72D60304L0RF	1929	2297	59.75	30	29.5	43	206	39
	72D66304LFR0*	2066	2459	65.75	30	29.5	49	212	42.75
	72D66304L0RF	2066	2459	65.75	30	29.5	49	212	42.75
	72D66364LFR0	2243	2668	65.75	36	29.5	49	224	50
	72D66364L0RF	2243	2668	65.75	36	29.5	49	224	50
	72D72304LFR0	2164	2571	71.75	30	29.5	55	224	46.5
	72D72304L0RF	2164	2571	71.75	30	29.5	55	224	46.5
	72D72364LFR0	2370	2818	71.75	36	29.5	55	236	54.75
	72D72364L0RF	2370	2818	71.75	36	29.5	55	236	54.75
	72D78304LFR0	2322	2763	77.75	30	29.5	61	236	50
	72D78304L0RF	2322	2763	77.75	30	29.5	61	236	50
	72D78364LFR0	2504	2978	77.75	36	29.5	61	242	59
	72D78364L0RF	2504	2978	77.75	36	29.5	61	242	59
	72D84364LFR0	2623	3118	83.75	36	29.5	67	260	63
	72D84364L0RF	2623	3118	83.75	36	29.5	67	260	63

**ORDERING PROCEDURE**

To order, please specify the following:

- 1) Krug product model number
- 2) Laminate, see page 446
- 3) Edge detail- I,H, L or P, see page 448
- 4) Pull style, see page 449
- 5) Grommet location if applicable

\*Indicates model illustrated by line drawing.

**CODE DESCRIPTION**

- L - left handed pedestal position
- R - right handed pedestal position
- 4 - full height pedestal
- D - 2 file drawer
- F - 2 box, 1 file drawer
- 0 - no pedestal

**STANDARD LAMINATES**

For a complete list of standard laminates please see page 446.

**GROMMETS**

One grommet in standard position is optional at no charge. See page 494 for more power management information.

# ARTEMIS LAMINATE | DESKS

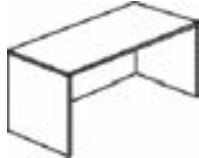
Description	Model	Laminate Top/Polymer Edge	HPL Top/Polymer Edge	W	D	H	KW	Shipping Weight	Cubic Feet	
	Rectangular Desk Shell with Full Height Modesty Panel	72SD6030X46	1141	1453	59.75	30	29.5	57.5	154	39
		72SD6630X46	1212	1540	65.75	30	29.5	63.5	198	42.75
		72SD6636X46	1328	1689	65.75	36	29.5	63.5	215	50
		72SD7230X46*	1258	1601	71.75	30	29.5	69.5	210	46.5
		72SD7236X46	1374	1808	71.75	36	29.5	69.5	228	54.75
		72SD7830X46	1434	1825	77.75	30	29.5	75.5	210	46.5
		72SD7836X46	1494	1966	77.75	36	29.5	75.5	241	59
		72SD8436X46	1631	2073	78.75	36	29.5	81.5	254	63

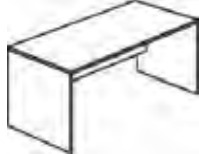
	Rectangular Desk Shell with 3/4 Height Modesty Panel	72SD6030X36	1141	1453	59.75	30	29.5	57.5	146	39
		72SD6630X36	1212	1540	65.75	30	29.5	63.5	198	42.75
		72SD6636X36	1328	1689	65.75	36	29.5	63.5	215	50
		72SD7230X36	1258	1601	71.75	30	29.5	69.5	210	46.5
		72SD7236X36*	1258	1601	71.75	30	29.5	69.5	210	46.5
		72SD7236X36*	1374	1748	71.75	36	29.5	69.5	228	54.75
		72SD7830X36	1434	1825	77.75	30	29.5	75.5	210	46.5
		72SD7836X36	1494	1905	77.75	36	29.5	75.5	241	59
	72SD8436X36	1631	2073	78.75	36	29.5	81.5	254	63	

	Bow Top Option	BT72D6030	203	269	59.75	36	-	-	68	1
		BT72D6630	213	283	65.75	36	-	-	73	1.25
		BT72D6636	224	295	65.75	42	-	-	84	1.25
		BT72D7230*	233	310	71.75	36	-	-	79	1.5
		BT72D7236	240	318	71.75	42	-	-	91	1.5
		BT72D7830	243	330	77.75	36	-	-	94	1.5
		BT72D7836	246	334	77.75	42	-	-	98	1.5
		BT72D8430	250	366	83.75	36	-	-	101	1.75
		BT72D8436	253	374	83.75	42	-	-	105	1.75

**DIMENSION KEY**

W - width  
D - depth  
H - height

Dimensions are in inches and approximate. Contact Customer Service if dimensions are critical.

**CODE DESCRIPTION**

L - left handed pedestal position  
R - right handed pedestal position  
4 - full height pedestal  
D - 2 file drawer  
F - 2 box, 1 file drawer  
0 - no pedestal  
X46 - full height fixed laminate modesty panel  
X36 - 3/4 height fixed laminate modesty panel  
BT - bow top

**STANDARD LAMINATES**

For a complete list of standard laminates please see page 446.

**GROMMETS**

One grommet in standard position is optional at no charge. See page 494 for more power management information.

# ARTEMIS LAMINATE | DESKS

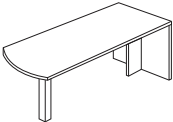
Description	Model	Laminate Top/Polymer Edge	HPL Top/Polymer Edge	W	D	H	KW	Shipping Weight	Cubic Feet	
	Arc Desk with Square Laminate Leg and no Modesty Panel	72DA6630S6	1137	1459	65.75	30	29.5	38	126	42.75
		72DA6636S6	1253	1610	65.75	36	29.5	35	146	50
		72DA7230S6*	1187	1524	71.75	30	29.5	44	132	46.5
		72DA7236S6	1286	1651	71.75	36	29.5	41	155	54.75
		72DA7830S6	1342	1724	77.75	30	29.5	50	141	50
		72DA7836S6	1386	1777	77.75	36	29.5	47	163	59
		72DA8430S6	1529	1962	83.75	30	29.5	56	154	53.75
	72DA8436S6	1572	2019	83.75	36	29.5	53	178	63	

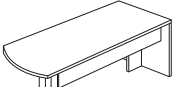
	Arc Desk with Square Laminate Leg and 1/2 Height Floating Modesty Panel	72DA6630LV26S6	1273	1610	65.75	30	29.5	38	135	42.75
		72DA6630RV26S6	1273	1610	65.75	30	29.5	38	135	42.75
		72DA7230LV26S6	1323	1671	71.75	30	29.5	44	142	46.5
		72DA7230RV26S6*	1323	1671	71.75	30	29.5	44	142	46.5
		72DA7830LV26S6	1537	1941	77.75	30	29.5	50	150	50
		72DA7830RV26S6	1537	1941	77.75	30	29.5	50	150	50
		72DA8430LV26S6	1746	2202	83.75	30	29.5	56	158	53.75
	72DA8430RV26S6	1746	2202	83.75	30	29.5	56	158	53.75	

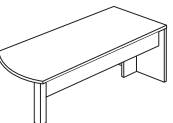
	Arc Desk with Square Laminate Leg and 1/2 Height Fixed Modesty Panel	72DA6636X26S6	1315	1661	65.75	36	29.5	35	148	50
		72DA7236X26S6*	1348	1692	71.75	36	29.5	41	158	54.75
		72DA7836X26S6	1423	1769	77.75	36	29.5	47	168	59
		72DA8436X26S6	1686	2030	83.75	36	29.5	53	186	63

**ORDERING NOTES:**

Curvilinear/Curved corner desks are not stand alone cases. They must be used in conjunction with returns or linking units. All Desks with a "S6" at the end of the model number are available with a 4" diameter metal leg. To order the metal leg please replace "S6" with a "D8" to the existing model number ie: 72DA6630D8. All Desks with a "S6" at the end of the model number are available with a Panel Leg. To order panel leg please replace "S6" with "P6" in the model number ie: 72DA6630P6.

**ORDERING PROCEDURE**

To order, please specify the following:

- 1) Krug product model number
- 2) Laminate, see page 446
- 3) Edge detail- I,H, L or P, see page 448
- 4) Pull style, see page 449
- 5) Grommet location if applicable

\*Indicates model illustrated by line drawing.

**CODE DESCRIPTION**

L - left-handed position  
 R - right-handed position  
 S6 - square Laminate leg  
 V29 - 1/2 height floating Laminate modesty panel  
 V26 - 1/2 height floating Laminate modesty panel  
 X26 - 1/2 height fixed Laminate modesty panel

**STANDARD LAMINATES**

For a complete list of standard laminates please see page 446.

**GROMMETS**

One grommet in standard position is optional at no charge. See page 494 for more power management information.

# ARTEMIS LAMINATE | DESKS

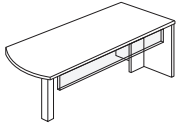
Description	Model	Laminate Top/Polymer Edge	HPL Top/Polymer Edge	W	D	H	KW	Shipping Weight	Cubic Feet	
	Arc Desk with square Laminate Leg and 1/2 Height Floating Acrylic Modesty Panel	72DA6630LV29S6	1887	2167	65.75	30	29.5	38	131	42.75
	72DA6630RV29S6	1887	2167	65.75	30	29.5	38	131	42.75	
	72DA6636LV29S6	1926	2210	65.75	36	29.5	35	150	50	
	72DA6636RV29S6	1926	2210	65.75	36	29.5	35	150	50	
	72DA7230LV29S6	2129	2440	71.75	30	29.5	44	138	46.5	
	72DA7230RV29S6	2129	2440	71.75	30	29.5	44	138	46.5	
	72DA7236LV29S6	2148	2464	71.75	36	29.5	41	160	54.75	
	72DA7236RV29S6*	2148	2464	71.75	36	29.5	41	160	54.75	
	72DA7830LV29S6	2237	2682	77.75	30	29.5	50	147	50	
	72DA7830RV29S6	2237	2682	77.75	30	29.5	50	147	50	
	72DA7836LV29S6	2347	2817	77.75	36	29.5	47	169	59	
	72DA7836RV29S6	2347	2817	77.75	36	29.5	47	169	59	
	72DA8430LV29S6	2637	3164	83.75	30	29.5	56	162	53.75	
	72DA8430RV29S6	2637	3164	83.75	30	29.5	56	162	53.75	
	72DA8436LV29S6	2697	3236	83.75	36	29.5	53	186	63	
72DA8436RV29S6	2697	3236	83.75	36	29.5	53	186	63		

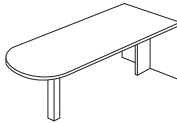
	Bullet Desk with Square Laminate Leg and no Modesty Panel	72DB6030S6	1096	1409	59.75	30	29.5	32	117	39
	72DB6036S6	1140	1463	59.75	36	29.5	29	135	46	
	72DB6630S6	1137	1459	65.75	30	29.5	38	124	42.75	
	72DB6636S6	1253	1610	65.75	36	29.5	35	144	50	
	72DB7230S6*	1187	1524	71.75	30	29.5	44	130	46.5	
	72DB7236S6	1286	1717	71.75	36	29.5	44	153	54.75	
	72DB7830S6	1260	1617	77.75	30	29.5	50	130	46.5	
	72DB7836S6	1334	1796	77.75	36	29.5	50	161	59	
	72DB8430S6	1451	1861	83.75	30	29.5	56	130	46.5	
	72DB8436S6	1551	2055	83.75	36	29.5	56	176	63	

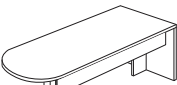
	Bullet Desk with Square Laminate Leg and 1/2 Height Floating Laminate Modesty Panel	72DB6030LV26S6	1239	1563	59.75	30	29.5	32	127	39
	72DB6030RV26S6	1239	1563	59.75	30	29.5	32	127	39	
	72DB6630LV26S6	1275	1611	65.75	30	29.5	38	135	42.75	
	72DB6630RV26S6	1275	1611	65.75	30	29.5	38	135	42.75	
	72DB7230LV26S6	1328	1673	71.75	30	29.5	44	144	46.5	
	72DB7230RV26S6*	1328	1673	71.75	30	29.5	44	144	46.5	
	72DB7830LV26S6	1351	1705	77.75	30	29.5	50	153	50	
	72DB7830RV26S6	1351	1705	77.75	30	29.5	50	153	50	
	72DB8430LV26S6	1563	1976	83.75	30	29.5	56	167	53.75	
72DB8430RV26S6	1563	1976	83.75	30	29.5	56	167	53.75		

**ORDERING NOTES:**

Curvilinear/Curved corner desks are not stand alone cases. They must be used in conjunction with returns or linking units. All Desks with a "S6" at the end of the model number are available with a 4" diameter metal leg. To order the metal leg please replace "S6" with a "D8" to the existing model number ie: 72DA6630D8. All Desks with a "S6" at the end of the model number are available with a Panel Leg. To order panel leg please replace "S6" with "P6" in the model number ie: 72DA6630P6.

DIMENSION KEY	CODE DESCRIPTION	STANDARD LAMINATES
W - width	L - left handed pedestal position	For a complete list of standard laminates please see page 446.
D - depth	R - right handed pedestal position	
H - height	4 - full height pedestal	<b>GROMMETS</b> One grommet in standard position is optional at no charge. See page 494 for more power management information.
Dimensions are in inches and approximate. Contact Customer Service if dimensions are critical.	D - 2 file drawer	
	F - 2 box, 1 file drawer	
	0 - no pedestal	
	X46 - full height fixed laminate modesty panel	
	X36 - 3/4 height fixed laminate modesty panel	
	BT - bow top	



# ARTEMIS LAMINATE | DESKS

Description	Model	Laminate Top/Polymer Edge	HPL Top/Polymer Edge	W	D	H	KW	Shipping Weight	Cubic Feet
Bullet Desk with Square Laminate Leg and 1/2 Height Fixed Laminate Modesty Panel	72DB6036X26S6	1103	1452	59.75	36	29.5	38.5	134	46
	72DB6636X26S6	1137	1493	65.75	36	29.5	44.5	146	50
	72DB7236X26S6*	1187	1610	71.75	36	29.5	50.5	156	54.75
	72DB7836X26S6	1258	1719	77.75	36	29.5	56.5	166	59
	72DB8436X26S6	1465	1927	83.75	36	29.5	62.5	176	63

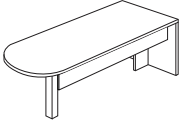

Bullet Desk with Square Laminate Leg and 1/2 Height Floating Acrylic Modesty Panel	72DB6030LV29S6	1703	2024	59.75	30	29.5	32	121	39
	72DB6030RV29S6	1703	2024	59.75	30	29.5	32	121	39
	72DB6036LV29S6	1813	2157	59.75	36	29.5	32	135	46
	72DB6036RV29S6	1813	2157	59.75	36	29.5	32	135	46
	72DB6630LV29S6	1749	2080	65.75	30	29.5	38	129	42.75
	72DB6630RV29S6*	1749	2080	65.75	30	29.5	38	129	42.75
	72DB6636LV29S6	1863	2217	65.75	36	29.5	38	148	50
	72DB6636RV29S6	1863	2217	65.75	36	29.5	38	148	50
	72DB7230LV29S6	1988	2362	71.75	30	29.5	44	136	46.5
	72DB7230RV29S6	1988	2362	71.75	30	29.5	44	136	46.5
	72DB7236LV29S6	2105	2502	71.75	36	29.5	44	158	54.75
	72DB7236RV29S6	2105	2502	71.75	36	29.5	44	158	54.75
	72DB7830LV29S6	2066	2459	77.75	30	29.5	50	145	50
	72DB7830RV29S6	2066	2459	77.75	30	29.5	50	145	50
	72DB7836LV29S6	2136	2631	77.75	36	29.5	50	167	59
	72DB7836RV29S6	2136	2631	77.75	36	29.5	50	167	59
	72DB8430LV29S6	2285	2717	83.75	30	29.5	56	160	53.75
	72DB8430RV29S6	2285	2717	83.75	30	29.5	56	160	53.75
	72DB8436LV29S6	2359	2805	83.75	36	29.5	56	184	63
	72DB8436RV29S6	2359	2805	83.75	36	29.5	56	184	63

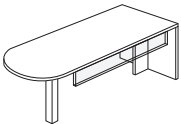

J Desk with Square Laminate Leg	72DJ7233LS6	1386	1795	71.75	33	29.5	36	136	62.75
	72DJ7233RS6	1386	1795	71.75	33	29.5	36	136	62.75
	72DJ7833LS6	1461	1892	77.75	33	29.5	42	144	62.75
	72DJ7833RS6	1461	1892	77.75	33	29.5	42	144	62.75
	72DJ8433LS6*	1669	2161	83.75	33	29.5	48	152	72.75
	72DJ8433RS6	1669	2161	83.75	33	29.5	48	152	72.75

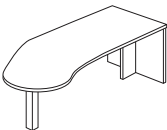

## ORDERING NOTES:

Curvilinear/Curved corner desks are not stand alone cases. They must be used in conjunction with returns or linking units. All Desks with a "S6" at the end of the model number are available with a 4" diameter metal leg. To order the metal leg please replace "S6" with a "D8" to the existing model number ie: 72DA6630D8. All Desks with a "S6" at the end of the model number are available with a Panel Leg. To order panel leg please replace "S6" with "P6" in the model number ie: 72DA6630P6.

## ORDERING PROCEDURE

To order, please specify the following:

- 1) Krug product model number
- 2) Laminate, see page 446
- 3) Edge detail- I,H, L or P, see page 448
- 4) Pull style, see page 449
- 5) Grommet location if applicable

\*Indicates model illustrated by line drawing.

## CODE DESCRIPTION

L - left-handed position  
 R - right-handed position  
 S6 - square Laminate leg  
 V29 - 1/2 height floating Laminate modesty panel  
 V26 - 1/2 height floating Laminate modesty panel  
 X26 - 1/2 height fixed Laminate modesty panel

## STANDARD LAMINATES

For a complete list of standard laminates finishes please see page 446.

## GROMMETS

One grommet in standard position is optional at no charge. See page 494 for more power management information.

# ARTEMIS LAMINATE | DESKS

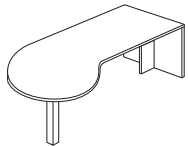
Description	Model	Laminate Top/Polymer Edge	HPL Top/Polymer Edge	W	D	H	KW	Shipping Weight	Cubic Feet
 <p>P Desk with Square Laminate Leg and no Modesty Panel</p>	72DP6636LS6	1351	1804	65.75	36	29.5	32	156	57.75
	72DP6636RS6	1351	1804	65.75	36	29.5	32	156	57.75
	72DP7236LS6	1386	1881	71.75	36	29.5	38	166	62.75
	72DP7236RS6	1386	1881	71.75	36	29.5	38	166	62.75
	72DP7836LS6	1461	1999	77.75	36	29.5	44	173	67.75
	72DP7836RS6	1461	1999	77.75	36	29.5	44	173	67.75
	72DP8436LS6	1669	2247	83.75	36	29.5	50	182	72.75
	72DP8436RS6*	1669	2247	83.75	36	29.5	50	182	72.75

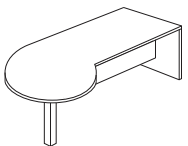
 <p>P Desk with Square Laminate Leg and 1/2 Height Fixed Laminate Modesty Panel</p>	72DP6636LX26S6	1455	1912	65.75	36	29.5	32	156	57.75
	72DP6636RX26S6	1455	1912	65.75	36	29.5	32	156	57.75
	72DP7236LX26S6	1488	1990	71.75	36	29.5	38	166	62.75
	72DP7236RX26S6	1488	1990	71.75	36	29.5	38	166	62.75
	72DP7836LX26S6	1566	2108	77.75	36	29.5	44	178	67.75
	72DP7836RX26S6	1566	2108	77.75	36	29.5	44	178	67.75
	72DP8436LX26S6	1642	2230	83.75	36	29.5	50	188	72.75
	72DP8436RX26S6*	1642	2230	83.75	36	29.5	50	188	72.75

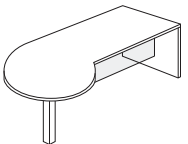
 <p>P Desk with Square Laminate Leg and 1/2 Height Floating Acrylic Modesty Panel</p>	72DP6636LV29S6	2066	2503	65.75	36	29.5	32	159	57.75
	72DP6636RV29S6	2066	2503	65.75	36	29.5	32	159	57.75
	72DP7236LV29S6	2294	2773	71.75	36	29.5	38	168	62.75
	72DP7236RV29S6	2294	2773	71.75	36	29.5	38	168	62.75
	72DP7836LV29S6	2378	2879	77.75	36	29.5	44	178	67.75
	72DP7836RV29S6	2378	2879	77.75	36	29.5	44	178	67.75
	72DP8436LV29S6	2594	3138	83.75	36	29.5	50	183	72.75
	72DP8436RV29S6*	2594	3138	83.75	36	29.5	50	183	72.75

**ORDERING NOTES:**

Curvilinear/Curved corner desks are not stand alone cases. They must be used in conjunction with returns or linking units. All Desks with a "S6" at the end of the model number are available with a 4" diameter metal leg. To order the metal leg please replace "S6" with a "D8" to the existing model number ie: 72DA6630D8. All Desks with a "S6" at the end of the model number are available with a Panel Leg. To order panel leg please replace "S6" with "P6" in the model number ie: 72DA6630P6.

<p><b>DIMENSION KEY</b>                  W - width                  D - depth                  H - height</p> <p>Dimensions are in inches and approximate. Contact Customer Service if dimensions are critical.</p>	<p><b>CODE DESCRIPTION</b>                  L - left-handed position                  R - right-handed position                  S6 - square Laminate leg                  V29 - 1/2 height floating Laminate modesty panel                  V26 - 1/2 height floating Laminate modesty panel                  X26 - 1/2 height fixed Laminate modesty panel</p>	<p><b>STANDARD LAMINATES</b>                  For a complete list of standard laminates please see page 446.</p> <p><b>GROMMETS</b>                  One grommet in standard position is optional at no charge. See page 645 for more power management information.</p>
---	--	---

# ARTEMIS LAMINATE | DESKS

Description	Model	Laminate Top/Polymer Edge	HPL Top/Polymer Edge	W	D	H	KW	Shipping Weight	Cubic Feet
Curved Corner Arc Desk with Square Laminate Leg and no Modesty Panel	72UDA723048L24RS6	1921	2463	71.75	48	29.5	31	192	71
	72UDA723048R24LS6	1921	2463	71.75	48	29.5	31	192	71
	72UDA783048L24RS6	1981	2542	77.75	48	29.5	37	185	76.75
	72UDA783048R24LS6	1981	2542	77.75	48	29.5	37	185	76.75
	72UDA843048L24RS6	2190	2808	83.75	48	29.5	43	191	82
	72UDA843048R24LS6*	2190	2808	83.75	48	29.5	43	191	82



Curved Corner Arc Desk with Square Laminate Leg and 1/2 Height Floating Laminate Modesty Panel	72UDA723048L24RV26S6	1946	2496	71.75	48	29.5	31	195	71
	72UDA723048R24LV26S6	1946	2496	71.75	48	29.5	31	195	71
	72UDA783048L24RV26S6	2001	2568	77.75	48	29.5	37	205	76.75
	72UDA783048R24LV26S6	2001	2568	77.75	48	29.5	37	205	76.75
	72UDA843048L24RV26S6	2214	2844	83.75	48	29.5	43	223	82
	72UDA843048R24LV26S6*	2214	2844	83.75	48	29.5	43	223	82



Curved Corner Bullet Desk with Square Laminate Leg and no Modesty Panel	72UDB723048L24RS6	1921	2463	71.75	48	29.5	38	184	71
	72UDB723048R24LS6	1921	2463	71.75	48	29.5	38	184	71
	72UDB783048L24RS6	1981	2542	77.75	48	29.5	44	192	76.75
	72UDB783048R24LS6	1981	2542	77.75	48	29.5	44	192	76.75
	72UDB843048L24RS6	2190	2808	83.75	48	29.5	50	208	82
	72UDB843048R24LS6*	2190	2808	83.75	48	29.5	50	208	82



**ORDERING NOTES:** Curvilinear/Curved corner desks are not stand alone cases. They must be used in conjunction with curved corner credenzas, linking units or returns. All Desks with a "S6" at the end of the model number are available with a 4" diameter metal leg. To order the metal leg please replace "S6" with a "D8" to the existing model number ie: 72DA6630D8. All Desks with a "S6" at the end of the model number are available with a Panel Leg. To order panel leg please replace "S6" with "P6" in the model number ie: 72DA6630P6.

## ORDERING PROCEDURE

To order, please specify the following:

- 1)Krug product model number
- 2)Laminate, see page 446
- 3)Edge detail- I,H, L or P, see page 448
- 4)Pull style, see page 449
- 5)Grommet location if applicable

\*Indicates model illustrated by line drawing.

## CODE DESCRIPTION

L - left-handed position  
 R - right-handed position  
 S6 - square Laminate leg  
 V29 - 1/2 height floating Laminate modesty panel  
 V26 - 1/2 height floating Laminate modesty panel  
 X26 - 1/2 height fixed Laminate modesty panel

## STANDARD LAMINATES

For a complete list of laminates please see page 446

## GROMMETS

One grommet in standard position is optional at no charge. See page 494 for more power management information.

# ARTEMIS LAMINATE | DESKS

Description	Model	Laminate Top/Polymer Edge	HPL Top/Polymer Edge	W	D	H	KW	Shipping Weight	Cubic Feet
Curved Corner Bullet Desk with Square Laminate Leg & 1/2 Height Floating Laminate Modesty Panel	72UDB723048L24RV26S6	1946	2496	71.75	48	29.5	38	195	71
	72UDB723048R24LV26S6	1946	2496	71.75	48	29.5	38	195	71
	72UDB783048L24RV26S6	2001	2568	77.75	48	29.5	44	205	76.75
	72UDB783048R24LV26S6	2001	2568	77.75	48	29.5	44	205	76.75
	72UDB843048L24RV26S6*	2214	2844	83.75	48	29.5	50	223	82
	72UDB843048R24LV26S6	2214	2844	83.75	48	29.5	50	223	82



Curved Corner P Desk with Square Laminate Leg & no Modesty Panel	72UDP663648L24RS6	2170	2741	65.75	48	29.5	22	168	65.5
	72UDP663648R24LS6	2170	2741	65.75	48	29.5	22	168	65.5
	72UDP723648L24RS6	2234	2820	71.75	48	29.5	28	177	71
	72UDP723648R24LS6	2234	2820	71.75	48	29.5	28	177	71
	72UDP783648L24RS6	2295	2896	77.75	48	29.5	34	186	76.75
	72UDP783648R24LS6	2295	2896	77.75	48	29.5	34	186	76.75
	72UDP843648L24RS6*	2356	2972	83.75	48	29.5	40	202	82
	72UDP843648R24LS6	2356	2972	83.75	48	29.5	40	202	82

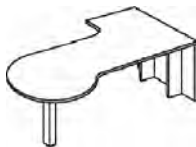

Curved Corner P Desk with Square Laminate Leg & 1/2 Height Fixed Laminate Modesty Panel	72UDP663648L24RX26S6	2194	2769	65.75	48	29.5	22	172	65.5
	72UDP663648R24LX26S6	2194	2769	65.75	48	29.5	22	172	65.5
	72UDP723648L24RX26S6	2256	2851	71.75	48	29.5	28	182	71
	72UDP723648R24LX26S6	2256	2851	71.75	48	29.5	28	182	71
	72UDP783648L24RX26S6	2319	2927	77.75	48	29.5	34	192	76.75
	72UDP783648R24LX26S6	2319	2927	77.75	48	29.5	34	192	76.75
	72UDP843648L24RX26S6*	2381	3004	83.75	48	29.5	40	204	82
	72UDP843648R24LX26S6	2381	3004	83.75	48	29.5	40	204	82



Curved Corner Rectangular Top Desk Single Pedestal and Modesty Panel	72UD723042L24RF	2431	2966	71.75	42	29.5	32	269	62.75
	72UD723042R24LF*	2431	2966	71.75	42	29.5	32	269	62.75
	72UD783042L24RF	2610	3185	77.75	42	29.5	38	279	67.75
	72UD783042R24LF	2610	3185	77.75	42	29.5	38	279	67.75
	72UD843042L24RF	2802	3420	83.75	42	29.5	44	289	72.75
	72UD843042R24LF	2802	3420	83.75	42	29.5	44	289	72.75



**ORDERING NOTES:**

Curvilinear/Curved corner desks are not stand alone cases. They must be used in conjunction with returns or linking units. All Desks with a "S6" at the end of the model number are available with a 4" diameter metal leg. To order the metal leg please replace "S6" with a "D8" to the existing model number ie: 72DA6630D8. All Desks with a "S6" at the end of the model number are available with a Panel Leg. To order panel leg please replace "S6" with "P6" in the model number ie: 72DA6630P6.

**DIMENSION KEY**

W - width  
D - depth  
H - height

Dimensions are in inches and approximate. Contact Customer Service if dimensions are critical.

**CODE DESCRIPTION**

L - left-handed position  
R - right-handed position  
S6 - square Laminate leg  
V29 - 1/2 height floating Laminate modesty panel  
V26 - 1/2 height floating Laminate modesty panel  
X26 - 1/2 height fixed Laminate modesty panel

**STANDARD LAMINATES**

For a complete list of standard laminates please see page 446.

**GROMMETS**

One grommet in standard position is optional at no charge. See page 494 for more power management information.

# ARTEMIS LAMINATE | DESKS

Description	Model	Laminate Top/Polymer Edge	HPL Top/Polymer Edge	W	D	H	KW	Shipping Weight	Cubic Feet
 Bow Top Option for Corner Desks	BT72UD723048L*	232	309	71.75	48	-		88	1.25
	BT72UD723048R	232	309	71.75	48	-		88	1.25
	BT72UD783048L	242	328	77.75	48	-		95	5
	BT72UD783048R	242	328	77.75	48	-		95	1.5
	BT72UD843048L	250	340	83.75	48	-		105	1.75
	BT72UD843048R	250	340	83.75	48	-		105	1.75

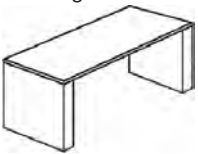
Description	Model	Laminate Top/Polymer Edge	HPL Top/Polymer Edge	W	D	H	KW	Shipping Weight	Cubic Feet
 Table Desk with 4" Rectangular Gable	72TD6636	1669	2072	65.75	36	29.5	58	198	45.75
	72TD7236*	1902	2361	71.75	36	29.5	64	228	54
	72TD7836	2003	2487	77.75	36	29.5	70	241	58.5
	72TD8436	2106	2607	83.75	36	29.5	76	254	63

Description	Model	Laminate Top/Polymer Edge	HPL Top/Polymer Edge	W	D	H	KW	Shipping Weight	Cubic Feet
 Table Desk with 2" Square Metal Legs	72TD6636M	1896	2783	65.75	36	29.5	62	198	45.75
	72TD7236M*	2080	2968	71.75	36	29.5	68	228	54
	72TD7836M	2133	3022	77.75	36	29.5	74	241	58.5
	72TD8436M	2193	3074	83.75	36	29.5	80	254	63

## ORDERING PROCEDURE

To order, please specify the following:

- 1) Krug product model number
- 2) Laminate, see page 26
- 3) Edge detail- I,H, L or P, see page 448
- 4) Pull style, see page 449
- 5) Grommet location if applicable

\*Indicates model illustrated by line drawing.

## CODE DESCRIPTION

L - left-handed position  
 R - right-handed position  
 X46 - full height fixed Laminate modesty panel  
 D - 2 file drawer  
 F - 2 box/ 1 file drawer  
 M - twin metal legs

## STANDARD LAMINATES

For a complete list of standard Laminates & HPL, please see page 446.

## GROMMETS

One grommet in standard position is optional at no charge. See page 494 for more power management information.

# ARTEMIS LAMINATE | RETURNS

Description	Model	Laminate Top/Polymer Edge	HPL Top/Polymer Edge	W	D	H	KW	Shipping Weight	Cubic Feet
Shell Return with Full Height Laminate Modesty Panel	72SRH4224LX46	760	928	42	24	29.5	41	98	23
	72SRH4224RX46*	760	928	42	24	29.5	41	98	23
	72SRH4824LX46	796	974	48	24	29.5	47	108	26
	72SRH4824RX46	796	974	48	24	29.5	47	108	26



Single Pedestal Return with 1/2 Height Fixed Laminate Modesty Panel	72RH4220L4DX26	1409	1587	42	20	29.5	26	100	20
	72RH4220L4FX26	1409	1587	42	20	29.5	26	100	20
	72RH4220R4DX26	1409	1587	42	20	29.5	26	100	20
	72RH4220R4FX26	1409	1587	42	20	29.5	26	100	20
	72RH4224L4DX26	1478	1663	42	24	29.5	26	104	23
	72RH4224L4FX26	1478	1663	42	24	29.5	26	104	23
	72RH4224R4DX26*	1478	1663	42	24	29.5	26	104	23
	72RH4224R4FX26	1478	1663	42	24	29.5	26	104	23
	72RH4820L4DX26	1478	1663	48	20	29.5	32	104	22.5
	72RH4820L4FX26	1478	1663	48	20	29.5	2	104	22.5
	72RH4820R4DX26	1478	1663	48	20	29.5	2	104	22.5
	72RH4820R4FX26	1478	1663	48	20	29.5	32	104	22.5
	72RH4824L4DX26	1533	1724	48	24	29.5	32	108	26
	72RH4824L4FX26	1533	1724	48	24	29.5	32	108	26
	72RH4824R4DX26	1533	1724	48	24	29.5	32	108	26
	72RH4824R4FX26	1533	1724	48	24	29.5	32	108	26

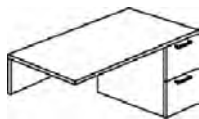

Single Pedestal Return with Hinged Laminate Modesty Panel	72RHY4220L4D	1752	1936	42	20	29.5	26	104	20
	72RHY4220L4F	1752	1936	42	20	29.5	26	104	20
	72RHY4220R4D	1752	1936	42	20	29.5	26	104	20
	72RHY4220R4F	1752	1936	42	20	29.5	26	104	20
	72RHY4224L4D	1822	2014	42	24	29.5	26	108	23
	72RHY4224L4F	1822	2014	42	24	29.5	26	108	23
	72RHY4224R4D*	1822	2014	42	24	29.5	26	108	23
	72RHY4224R4F	1822	2014	42	24	29.5	26	108	23
	72RHY4820L4D	1822	2014	48	20	29.5	32	108	22.5
	72RHY4820L4F	1822	2014	48	20	29.5	32	108	22.5
	72RHY4820R4D	1822	2014	48	20	29.5	32	108	22.5
	72RHY4820R4F	1822	2014	48	20	29.5	32	108	22.5
	72RHY4824L4D	1884	2084	48	24	29.5	32	112	26
	72RHY4824L4F	1884	2084	48	24	29.5	32	112	26
	72RHY4824R4D	1884	2084	48	24	29.5	32	112	26
	72RHY4824R4F	1884	2084	48	24	29.5	32	112	26

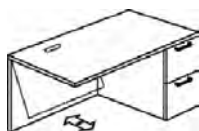

**DIMENSION KEY**

W - width  
D - depth  
H - height

Dimensions are in inches and approximate. Contact Customer Service if dimensions are critical.

**CODE DESCRIPTION**

L - left hand pedestal position  
R - right hand pedestal position  
S6 - square Laminate leg  
X26 - 1/2 height fixed Laminate modesty panel  
X46 - full height Laminate modesty panel  
D - 2 file drawers  
F - 2 box, 1 file drawer  
V26 - 1/2 height floating Laminate modesty panel  
V29 - 1/2 height floating acrylic modesty panel  
M - metal legs

**STANDARD LAMINATES**

For a complete list of standard Laminates & HPL, please see page 446.

**GROMMETS**

One grommet in standard position is optional at no charge. See page 494 for more power management information.

# ARTEMIS LAMINATE | RETURNS

Description	Model	Laminate Top/Polymer Edge	HPL Top/Polymer Edge	W	D	H	KW	Shipping Weight	Cubic Feet
Arc Return with Square Laminate Leg and no Modesty Panel	72RHA4830LS6	854	1122	47.75	30	29.5	30.75	58	8.5
	72RHA4830RS6	854	1122	47.75	30	29.5	30.75	58	8.5
	72RHA4836LS6	885	1199	47.75	36	29.5	27.75	66	9.5
	72RHA4836RS6	885	1199	47.75	36	29.5	27.75	66	9.5
	72RHA5430LS6	885	1199	53.75	30	29.5	36.75	63	9
	72RHA5430RS6	885	1199	53.75	30	29.5	36.75	63	9
	72RHA5436LS6	912	1246	53.75	36	29.5	33.75	71	10.5
	72RHA5436RS6	912	1246	53.75	36	29.5	33.75	71	10.5
	72RHA6030LS6	912	1246	59.75	30	29.5	42.75	68	10
	72RHA6030RS6	912	1246	59.75	30	29.5	42.75	68	10
	72RHA6036LS6	940	1268	59.75	36	29.5	39.75	77	11.5
	72RHA6036RS6	940	1268	59.75	36	29.5	39.75	77	11.5
	72RHA6630LS6	940	1268	65.75	30	29.5	48.75	99	10.75
	72RHA6630RS6	940	1268	65.75	30	29.5	48.75	99	10.75
	72RHA6636LS6	1015	1387	65.75	36	29.5	45.75	88	12.5
	72RHA6636RS6	1015	1387	65.75	36	29.5	45.75	88	12.5
	72RHA7230LS6*	1146	1548	71.75	30	29.5	54.75	104	11.5
	72RHA7230RS6	1146	1548	71.75	30	29.5	54.75	104	11.5
	72RHA7236LS6	1183	1618	71.75	36	29.5	51.75	95	13.5
	72RHA7236RS6	1183	1618	71.75	36	29.5	51.75	95	13.5
	72RHA7830LS6	1158	1562	77.75	30	29.5	60.75	104	11.5
	72RHA7830RS6	1158	1562	77.75	30	29.5	60.75	104	11.5
	72RHA7836LS6	1257	1717	77.75	36	29.5	57.75	95	13.5
	72RHA7836RS6	1257	1717	77.75	36	29.5	57.75	95	13.5
	72RHA8430LS6	1243	1698	83.75	30	29.5	66.75	114	13
	72RHA8430RS6	1243	1698	83.75	30	29.5	30.75	114	13
	72RHA8436LS6	1355	1854	83.75	36	29.5	63.75	108	15
	72RHA8436RS6	1355	1854	83.75	36	29.5	63.75	108	15

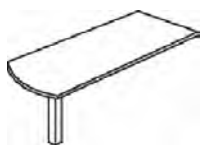

## ORDERING NOTES:

All Returns with a "S6" at the end of the model number are available with a 4" diameter metal leg, please replace "S6" with a "D8" to the existing model number ie: 72RHB6630LD8. All returns with a "S6" at the end of the model number are available with a Panel Leg, please replace "S6" with "P6" in the model number ie: 72RH6630LP6.

### ORDERING PROCEDURE

To order, please specify the following:

- 1) Krug product model number
- 2) Laminates, see page 446
- 3) Wood edge detail- I, H, L or P, see page 448
- 4) Pull style, see page 449
- 5) Grommet location if applicable

\*Indicates model illustrated by line drawing.

### CODE DESCRIPTION

L - left hand pedestal position  
 R - right hand pedestal position  
 S6 - square Laminate leg  
 X26 - 1/2 height fixed Laminate modesty panel  
 X46 - full height Laminate modesty panel  
 D - 2 file drawer  
 F - 2 box, 1 file drawer  
 V26 - 1/2 height floating Laminate modesty panel  
 V29 - 1/2 height floating acrylic modesty panel  
 M - metal legs

### STANDARD LAMINATES

For a complete list of standard Laminates please see page 446.

### GROMMETS

One grommet in standard position is optional at no charge. See page 494 for more power management information.

# ARTEMIS LAMINATE | RETURNS

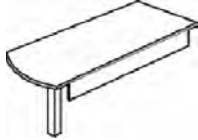
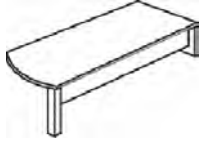
Description	Model	Laminate Top/Polymer Edge	HPL Top/Polymer Edge	W	D	H	KW	Shipping Weight	Cubic Feet	
	Arc Return with Square Laminate Leg and 1/2 Height Floating Laminate Modesty Panel	72RHA4830LV26S6	982	1247	47.75	30	29.5	30.75	67	9
	72RHA4830RV26S6	982	1247	47.75	30	29.5	30.75	67	9	
	72RHA4836LV26S6	1011	1309	47.75	36	29.5	27.75	69	10	
	72RHA4836RV26S6	1011	1309	47.75	36	29.5	27.75	69	10	
	72RHA5430LV26S6	1011	1309	53.75	30	29.5	36.75	73	10	
	72RHA5430RV26S6	1011	1309	53.75	30	29.5	36.75	73	10	
	72RHA5436LV26S6	1037	1376	53.75	36	29.5	33.75	75	11	
	72RHA5436RV26S6	1037	1376	53.75	36	29.5	33.75	75	11	
	72RHA6030LV26S6	1037	1376	59.75	30	29.5	42.75	80	11	
	72RHA6030RV26S6	1037	1376	59.75	30	29.5	42.75	80	11	
	72RHA6036LV26S6	1065	1414	59.75	36	29.5	39.75	82	12	
	72RHA6036RV26S6	1065	1414	59.75	36	29.5	39.75	82	12	
	72RHA6630LV26S6	1065	1414	65.75	30	29.5	48.75	128	12	
	72RHA6630RV26S6	1065	1414	65.75	30	29.5	48.75	128	12	
	72RHA6636LV26S6	1131	1497	65.75	36	29.5	45.75	103	13	
	72RHA6636RV26S6	1131	1497	65.75	36	29.5	45.75	103	13	
	72RHA7230LV26S6	1263	1661	71.75	30	29.5	54.75	136	13	
	72RHA7230RV26S6*	1263	1661	71.75	30	29.5	54.75	136	13	
	72RHA7236LV26S6	1306	1730	71.75	36	29.5	51.75	110	14	
	72RHA7236RV26S6	1306	1730	71.75	36	29.5	51.75	110	14	
	72RHA7830LV26S6	1351	1776	77.75	30	29.5	60.75	145	14	
	72RHA7830RV26S6	1351	1776	77.75	30	29.5	60.75	145	14	
	72RHA7836LV26S6	1396	1853	77.75	36	29.5	57.75	117	15	
	72RHA7836RV26S6	1396	1853	77.75	36	29.5	57.75	117	15	
	72RHA8430LV26S6	1447	1902	83.75	30	29.5	66.75	153	15	
	72RHA8430RV26S6	1447	1902	83.75	30	29.5	66.75	153	15	
	72RHA8436LV26S6	1558	2064	83.75	36	29.5	63.75	124	16	
	72RHA8436RV26S6	1558	2064	83.75	36	29.5	63.75	124	16	
	Arc Return with Square Laminate Leg and 1/2 Height Fixed Modesty Panel	72RHA4836LX26S6	1118	1446	47.75	36	29.5	27.75	101	36.5
	72RHA4836RX26S6	1118	1446	47.75	36	29.5	27.75	101	36.5	
	72RHA5436LX26S6	1146	1495	53.75	36	29.5	33.75	111	40.5	
	72RHA5436RX26S6	1146	1495	53.75	36	29.5	33.75	111	40.5	
	72RHA6036LX26S6	1172	1530	59.75	36	29.5	39.75	120	44.5	
	72RHA6036RX26S6	1172	1530	59.75	36	29.5	39.75	120	44.5	
	72RHA6636LX26S6	1209	1579	65.75	36	29.5	45.75	128	50	
	72RHA6636RX26S6	1209	1579	65.75	36	29.5	45.75	128	50	
	72RHA7236LX26S6	1262	1685	71.75	36	29.5	51.75	136	54.75	
	72RHA7236RX26S6*	1262	1685	71.75	36	29.5	51.75	136	54.75	
	72RHA7836LX26S6	1333	1795	77.75	36	29.5	57.75	145	57	
	72RHA7836RX26S6	1333	1795	77.75	36	29.5	57.75	145	57	
	72RHA8436LX26S6	1414	1918	83.75	36	29.5	63.75	153	63	
	72RHA8436RX26S6	1414	1918	83.75	36	29.5	63.75	153	63	

**ORDERING NOTES:**

All Returns with a "S6" at the end of the model number are available with a 4" diameter metal leg, please replace "S6" with a "D8" to the existing model number ie: 72RHB6630LD8. All returns with a "S6" at the end of the model number are available with a Panel Leg, please replace "S6" with "P6" in the model number ie: 72RH6630LP6.

**DIMENSION KEY**

W - width  
D - depth  
H - height

Dimensions are in inches and approximate. Contact Customer Service if dimensions are critical.

**CODE DESCRIPTION**

L - left hand pedestal position  
R - right hand pedestal position  
S6 - square Laminate leg  
X26 - 1/2 height fixed Laminate modesty panel  
X46 - full height Laminate modesty panel  
D - 2 file drawers  
F - 2 box, 1 file drawer  
V26 - 1/2 height floating Laminate modesty panel  
V29 - 1/2 height floating acrylic modesty panel  
M - metal legs

**STANDARD LAMINATES**

For a complete list of standard Laminates please see page 446.

**GROMMETS**

One grommet in standard position is optional at no charge. See page 494 for more power management information.



# ARTEMIS LAMINATE | RETURNS

Description	Model	Laminate Top/Polymer Edge	HPL Top/Polymer Edge	W	D	H	KW	Shipping Weight	Cubic Feet
Arc Return with Square Laminate Leg and 1/2 Height Floating Acrylic Modesty Panel	72RHA4830LV29S6	1319	1612	47.75	30	29.5	27.75	62	8.75
	72RHA4830RV29S6	1319	1612	47.75	30	29.5	27.75	62	8.75
	72RHA4836LV29S6	1342	1653	47.75	36	29.5	27.75	69	10
	72RHA4836RV29S6	1342	1653	47.75	36	29.5	27.75	69	10
	72RHA5430LV29S6	1351	1663	53.75	30	29.5	33.75	67	9
	72RHA5430RV29S6	1351	1663	53.75	30	29.5	33.75	67	9
	72RHA5436LV29S6	1373	1691	53.75	36	29.5	33.75	75	11
	72RHA5436RV29S6	1373	1691	53.75	36	29.5	33.75	75	11
	72RHA6030LV29S6	1380	1698	59.75	30	29.5	39.75	72	10
	72RHA6030RV29S6	1380	1698	59.75	30	29.5	39.75	72	10
	72RHA6036LV29S6	1398	1720	59.75	36	29.5	39.75	82	12
	72RHA6036RV29S6	1398	1720	59.75	36	29.5	39.75	82	12
	72RHA6630LV29S6	1405	1730	65.75	30	29.5	45.75	103	11.5
	72RHA6630RV29S6	1405	1730	65.75	30	29.5	45.75	103	11.5
	72RHA6636LV29S6	1529	1882	65.75	36	29.5	45.75	103	13
	72RHA6636RV29S6	1529	1882	65.75	36	29.5	45.75	103	13
	72RHA7230LV29S6	1752	2158	71.75	30	29.5	51.75	110	12
	72RHA7230RV29S6	1752	2158	71.75	30	29.5	51.75	110	12
	72RHA7236LV29S6	1863	2295	71.75	36	29.5	51.75	110	14
	72RHA7236RV29S6*	1863	2295	71.75	36	29.5	51.75	110	14
	72RHA7830LV29S6	1899	2341	77.75	30	29.5	57.75	110	12
	72RHA7830RV29S6	1899	2341	77.75	30	29.5	57.75	110	12
	72RHA7836LV29S6	1935	2383	77.75	36	29.5	57.75	117	15
	72RHA7836RV29S6	1935	2383	77.75	36	29.5	57.75	117	15
	72RHA8430LV29S6	1924	2369	83.75	30	29.5	63.75	124	14
	72RHA8430RV29S6	1924	2369	83.75	30	29.5	63.75	124	14
	72RHA8436LV29S6	2011	2476	83.75	36	29.5	63.75	124	16
	72RHA8436RV29S6	2011	2476	83.75	36	29.5	63.75	124	16

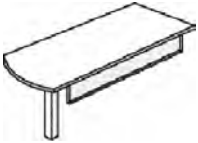

## ORDERING NOTES:

All Returns with a "S6" at the end of the model number are available with a 4" diameter metal leg, please replace "S6" with a "D8" to the existing model number ie: 72RHB6630LD8. All returns with a "S6" at the end of the model number are available with a Panel Leg, please replace "S6" with "P6" in the model number ie: 72RH6630LP6.

### ORDERING PROCEDURE

To order, please specify the following:

- 1) Krug product model number
- 2) Laminates, see page 446
- 3) Wood edge detail- I,H, L or P, see page 448
- 4) Pull style, see page 449
- 5) Grommet location if applicable

\*Indicates model illustrated by line drawing.

### CODE DESCRIPTION

L - left hand pedestal position  
 R - right hand pedestal position  
 S6 - square Laminate leg  
 X26 - 1/2 height fixed Laminate modesty panel  
 X46 - full height Laminate modesty panel  
 D - 2 file drawer  
 F - 2 box, 1 file drawer  
 V26 - 1/2 height floating Laminate modesty panel  
 V29 - 1/2 height floating acrylic modesty panel  
 M - metal legs



### STANDARD LAMINATES

For a complete list of standard Laminates please see page 446.

### GROMMETS

One grommet in standard position is optional at no charge. See page 494 for more power management information.

# ARTEMIS LAMINATE | RETURNS

Description	Model	Laminate Top/Polymer Edge	HPL Top/Polymer Edge	W	D	H	KW	Shipping Weight	Cubic Feet	
	Bullet Return with Square Laminate Leg and no Modesty Panel	72RHB4830LS6	852	1120	47.75	30	29.5	30.75	56	8.75
		72RHB4830RS6	852	1120	47.75	30	29.5	30.75	56	8.75
		72RHB4836LS6	861	1168	47.75	36	29.5	27.75	63	9
		72RHB4836RS6	861	1168	47.75	36	29.5	27.75	63	9
		72RHB5430LS6	878	1171	53.75	30	29.5	36.75	61	9
		72RHB5430RS6	878	1171	53.75	30	29.5	36.75	61	9
		72RHB5436LS6	896	1245	53.75	36	29.5	33.75	69	9.75
		72RHB5436RS6	896	1245	53.75	36	29.5	33.75	69	9.75
		72RHB6030LS6	905	1227	59.75	30	29.5	42.75	72	10
		72RHB6030RS6	905	1227	59.75	30	29.5	42.75	72	10
		72RHB6036LS6	912	1246	59.75	36	29.5	39.75	79	11.5
		72RHB6036RS6	912	1246	59.75	36	29.5	39.75	79	11.5
		72RHB6630LS6	940	1268	65.75	30	29.5	48.75	78	10.75
		72RHB6630RS6	940	1268	65.75	30	29.5	48.75	78	10.75
		72RHB6636LS6	1015	1387	65.75	36	29.5	45.75	85	12.5
		72RHB6636RS6	1015	1387	65.75	36	29.5	45.75	85	12.5
		72RHB7230LS6*	1146	1543	71.75	30	29.5	54.75	84	11.5
		72RHB7230RS6	1146	1543	71.75	30	29.5	54.75	84	11.5
		72RHB7236LS6	1183	1643	71.75	36	29.5	51.75	96	13.5
		72RHB7236RS6	1183	1643	71.75	36	29.5	51.75	96	13.5
		72RHB7830LS6	1194	1618	77.75	30	29.5	60.75	103	12.5
		72RHB7830RS6	1194	1618	77.75	30	29.5	60.75	103	12.5
		72RHB7836LS6	1298	1747	77.75	36	29.5	57.75	116	14
		72RHB7836RS6	1298	1747	77.75	36	29.5	57.75	116	14
		72RHB8430LS6	1298	1747	83.75	30	29.5	66.75	121	13
		72RHB8430RS6	1298	1747	83.75	30	29.5	66.75	121	13
		72RHB8436LS6	1416	1935	83.75	36	29.5	63.75	135	15
		72RHB8436RS6	1416	1935	83.75	36	29.5	66.75	135	15
	Bullet Return with Square Laminate Leg and 1/2 Height Floating Laminate Modesty Panel	72RHB4830LV26S6	941	1207	47.75	30	29.5	30	66	9
		72RHB4830RV26S6	941	1207	47.75	30	29.5	30	66	9
		72RHB5430LV26S6	978	1273	53.75	30	29.5	36	72	9.75
		72RHB5430RV26S6	978	1273	53.75	30	29.5	36	72	9.75
		72RHB6030LV26S6	1021	1330	59.75	30	29.5	42	108	11
		72RHB6030RV26S6	1021	1330	59.75	30	29.5	42	108	11
		72RHB6630LV26S6	1065	1402	65.75	30	29.5	48	115	12
		72RHB6630RV26S6	1065	1402	65.75	30	29.5	48	115	12
		72RHB7230LV26S6	1131	1466	71.75	30	29.5	54	122	13
		72RHB7230RV26S6	1131	1466	71.75	30	29.5	54	122	13
		72RHB7830LV26S6	1197	1570	77.75	30	29.5	60	129	14
		72RHB7830RV26S6*	1197	1570	77.75	30	29.5	60	129	14
		72RHB8430LV26S6	1396	1837	83.75	30	29.5	66	136	15
		72RHB8430RV26S6	1396	1837	83.75	30	29.5	66	136	15

**ORDERING NOTES:**

All Returns with a "S6" at the end of the model number are available with a 4" diameter metal leg, please replace "S6" with a "D8" to the existing model number ie: 72RHB6630LD8. All returns with a "S6" at the end of the model number are available with a Panel Leg, please replace "S6" with "P6" in the model number ie: 72RH6630LP6. If ordering a pencil drawer for a curvilinear return please see page 691 for details.

<p><b>DIMENSION KEY</b>                  W - width                  D - depth                  H - height</p> <p>Dimensions are in inches and approximate. Contact Customer Service if dimensions are critical.</p>	<p><b>CODE DESCRIPTION</b>                  L - left hand pedestal position                  R - right hand pedestal position                  S6 - square Laminate leg                  X26 - 1/2 height fixed Laminate modesty panel                  X46 - full height Laminate modesty panel                  D - 2 file drawer                  F - 2 box, 1 file drawer                  V26 - 1/2 height floating Laminate modesty panel                  V29 - 1/2 height floating acrylic modesty panel</p>	<p><b>STANDARD LAMINATES</b>                  For a complete list of standard Laminates please see page 446.</p> <p><b>GROMMETS</b>                  One grommet in standard position is optional at no charge. See page 494 for more power management information.</p> <p style="text-align: right;">CASEGOODS   GSA   471</p>
---	--	---

# ARTEMIS LAMINATE | RETURNS

Description	Model	Laminate Top/Polymer Edge	HPL Top/Polymer Edge	W	D	H	KW	Shipping Weight	Cubic Feet
 Bullet Return with Square Laminate Leg and 1/2 Height Fixed Laminate Modesty Panel	72RHB4836LX26S6	1017	1338	47.75	36	29.5	27	71	36.5
	72RHB4836RX26S6	1017	1338	47.75	36	29.5	27	71	36.5
	72RHB5436LX26S6	1053	1381	53.75	36	29.5	33	78	40.5
	72RHB5436RX26S6	1053	1381	53.75	36	29.5	33	78	40.5
	72RHB6036LX26S6	1088	1430	59.75	36	29.5	39	117	46
	72RHB6036RX26S6	1088	1430	59.75	36	29.5	39	117	46
	72RHB6636LX26S6	1163	1528	65.75	36	29.5	45	125	50
	72RHB6636RX26S6	1163	1528	65.75	36	29.5	45	125	50
	72RHB7236LX26S6*	1209	1590	71.75	36	29.5	51	133	54.75
	72RHB7236RX26S6	1209	1590	71.75	36	29.5	51	133	54.75
	72RHB7836LX26S6	1330	1747	77.75	36	29.5	57	141	57
	72RHB7836RX26S6	1330	1747	77.75	36	29.5	57	141	57
	72RHB8436LX26S6	1459	1920	83.75	36	29.5	63	150	63
	72RHB8436RX26S6	1459	1920	83.75	36	29.5	63	150	63

 Bullet Return with Square Laminate Leg & 1/2 Height Floating Acrylic Modesty Panel	72RHB4830LV29S6	1288	1569	47.75	30	29.5	30	60	9
	72RHB4830RV29S6	1288	1569	47.75	30	29.5	30	60	10.5
	72RHB4836LV29S6	1373	1691	47.75	36	29.5	27	66	10.5
	72RHB4836RV29S6	1373	1691	47.75	36	29.5	27	66	10.5
	72RHB5430LV29S6	1317	1622	53.75	30	29.5	36	65	9.75
	72RHB5430RV29S6	1317	1622	53.75	30	29.5	36	65	11.5
	72RHB5436LV29S6	1403	1728	53.75	36	29.5	33	72	11.5
	72RHB5436RV29S6	1403	1728	53.75	36	29.5	33	72	11.5
	72RHB6030LV29S6	1380	1705	59.75	30	29.5	42	87	10.5
	72RHB6030RV29S6	1380	1705	59.75	30	29.5	42	87	10.5
	72RHB6036LV29S6	1447	1780	59.75	36	29.5	39	94	12
	72RHB6036RV29S6	1447	1780	59.75	36	29.5	39	94	12
	72RHB6630LV29S6	1405	1730	65.75	30	29.5	48	93	11.5
	72RHB6630RV29S6	1405	1730	65.75	30	29.5	48	93	11.5
	72RHB6636LV29S6*	1487	1894	65.75	36	29.5	45	100	13
	72RHB6636RV29S6	1487	1894	65.75	36	29.5	45	100	13
	72RHB7230LV29S6	1752	2158	71.75	30	29.5	54	99	12
	72RHB7230RV29S6	1752	2158	71.75	30	29.5	54	99	12
	72RHB7236LV29S6	1823	2243	71.75	36	29.5	51	107	14
	72RHB7236RV29S6	1823	2243	71.75	36	29.5	51	107	14
	72RHB7830LV29S6	1818	2239	77.75	30	29.5	60	104	13
	72RHB7830RV29S6	1818	2239	77.75	30	29.5	60	104	13
	72RHB7836LV29S6	1929	2377	77.75	36	29.5	57	114	15
72RHB7836RV29S6	1929	2377	77.75	36	29.5	57	114	15	
72RHB8430LV29S6	1885	2321	83.75	30	29.5	66	110	14	
72RHB8430RV29S6	1885	2321	83.75	30	29.5	66	110	14	
72RHB8436LV29S6	2053	2526	83.75	36	29.5	63	120	16	
72RHB8436RV29S6	2053	2526	83.75	36	29.5	63	120	16	

## ORDERING NOTES:

All Returns with a "S6" at the end of the model number are available with a 4" diameter metal leg, please replace "S6" with a "D8" to the existing model number ie: 72RHB6630LD8. All returns with a "S6" at the end of the model number are available with a Panel Leg, please replace "S6" with "P6" in the model number ie: 72RH6630LP6.

## ORDERING PROCEDURE

To order, please specify the following:

- 1) Krug product model number
- 2) Laminates, see page 446
- 3) Edge detail- I,H, L or P, see page 448
- 4) Pull style, see page 449
- 5) Grommet location if applicable

\*Indicates model illustrated by line drawing.

## CODE DESCRIPTION

L - left hand pedestal position  
 R - right hand pedestal position  
 S6 - square Laminate leg  
 X26 - 1/2 height fixed Laminate modesty panel  
 X46 - full height Laminate modesty panel  
 D - 2 file drawer  
 F - 2 box, 1 file drawer  
 V26 - 1/2 height floating Laminate modesty panel  
 V29 - 1/2 height floating acrylic modesty panel  
 M - metal legs

## STANDARD LAMINATES

For a complete list of standard laminates please see page 446.

## GROMMETS

One grommet in standard position is optional at no charge. See page 494 for more power management information.

# ARTEMIS LAMINATE | RETURNS

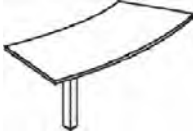
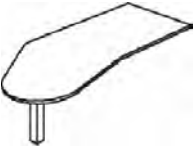
Description	Model	Laminate Top/Polymer Edge	HPL Top/Polymer Edge	W	D	H	Shipping Weight	Cubic Feet
 <p>Crescent Return with Square Laminate Leg</p>	72RHC4830LS6	977	1356	47.75	39	29.5	54	8
	72RHC4830RS6	977	1356	47.75	39	29.5	54	8
	72RHC5430LS6	1022	1420	53.75	39	29.5	59	9
	72RHC5430RS6	1022	1420	53.75	39	29.5	59	9
	72RHC6030LS6	1086	1506	59.75	42	29.5	64	10
	72RHC6030RS6	1086	1506	59.75	42	29.5	64	10
	72RHC6630LS6	1163	1612	65.75	42	29.5	69	10.5
	72RHC6630RS6	1163	1612	65.75	42	29.5	69	10.5
	72RHC7230LS6	1245	1809	71.75	45	29.5	86	11.5
	72RHC7230RS6*	1245	1809	71.75	45	29.5	86	11.5
	72RHC7830LS6	1505	2087	71.75	45	29.5	92	12.5
	72RHC7830RS6	1505	2087	71.75	45	29.5	92	12.5
	72RHC8430LS6	1640	2277	83.75	48.75	29.5	95	13
	72RHC8430RS6	1640	2277	83.75	48.75	29.5	95	13
 <p>J Return with Square Laminate Leg</p>	72RHJ4833LS6*	997	1310	33	47.75	29.5	128	11.5
	72RHJ4833RS6	997	1310	33	47.75	29.5	128	11.5
	72RHJ5433LS6	1042	1391	33	53.75	29.5	128	11.5
	72RHJ5433RS6	1042	1391	33	53.75	29.5	128	11.5
	72RHJ6033LS6	1080	1461	33	59.75	29.5	128	11.5
	72RHJ6033RS6	1080	1461	33	59.75	29.5	128	11.5
	72RHJ6633LS6	1120	1534	33	65.75	29.5	128	11.5
	72RHJ6633RS6	1120	1534	33	65.75	29.5	128	11.5
	72RHJ7233LS6	1165	1592	33	71.75	29.5	135	12.5
	72RHJ7233RS6	1165	1592	33	71.75	29.5	135	12.5
	72RHJ7833LS6	1415	1920	33	77.75	29.5	139	13.5
	72RHJ7833RS6	1415	1920	33	77.75	29.5	139	13.5
	72RHJ8433LS6	1539	2089	33	83.75	29.5	144	14
	72RHJ8433RS6	1539	2089	33	83.75	29.5	144	14

**ORDERING NOTES:**

All Returns with a "S6" at the end of the model number are available with a 4" diameter metal leg, please replace "S6" with a "D8" to the existing model number ie: 72RHB6630LD8. All returns with a "S6" at the end of the model number are available with a Panel Leg, please replace "S6" with "P6" in the model number ie: 72RH6630LP6.

**DIMENSION KEY**

W - width  
D - depth  
H - height

Dimensions are in inches and approximate. Contact Customer Service if dimensions are critical.

**CODE DESCRIPTION**

L - left hand pedestal position  
R - right hand pedestal position  
S6 - square Laminate leg  
X26 - 1/2 height fixed Laminate modesty panel  
X46 - full height Laminate modesty panel  
D - 2 file drawer  
F - 2 box, 1 file drawer  
V26 - 1/2 height floating Laminate modesty panel  
V29 - 1/2 height floating acrylic modesty panel  
M - metal legs

**STANDARD LAMINATES**

For a complete list of standard Laminates please see page 446.

**GROMMETS**

One grommet in standard position is optional at no charge. See page 494 for more power management information.

# ARTEMIS LAMINATE | RETURNS

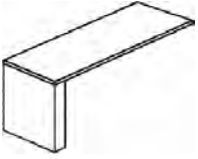
Description	Model	Laminate Top/Polymer Edge	HPL Top/Polymer Edge	W	D	H	KW	Shipping Weight	Cubic Feet
Rectangular Desk	72RHDR4830L	1058	1333	47.75	30	29.5	43.75	91	36.5
Return with 4" Gable	72RHDR4830R	1058	1333	47.75	30	29.5	43.75	91	36.5
and no Modesty Panel	72RHDR4836L	1134	1453	47.75	36	29.5	43.75	96	36.5
	72RHDR4836R	1134	1453	47.75	36	29.5	43.75	96	36.5
	72RHDR5430L	1108	1411	53.75	30	29.5	49.75	99	40.5
	72RHDR5430R	1108	1411	53.75	30	29.5	49.75	99	40.5
	72RHDR5436L	1179	1513	53.75	36	29.5	49.75	104	40.5
	72RHDR5436R	1179	1513	53.75	36	29.5	49.75	104	40.5
	72RHDR6030L	1284	1620	59.75	30	29.5	55.75	106	44.5
	72RHDR6030R	1284	1620	59.75	30	29.5	55.75	106	44.5
	72RHDR6036L	1357	1743	59.75	36	29.5	55.75	111	44.5
	72RHDR6036R	1357	1743	59.75	36	29.5	55.75	111	44.5
	72RHDR6630L	1332	1709	65.75	30	29.5	61.75	112	49
	72RHDR6630R	1332	1709	65.75	30	29.5	61.75	112	49
	72RHDR6636L	1403	1801	65.75	36	29.5	61.75	117	50
	72RHDR6636R	1403	1801	65.75	36	29.5	61.75	117	50
	72RHDR7230L*	1374	1764	71.75	30	29.5	67.75	119	53
	72RHDR7230R	1374	1764	71.75	30	29.5	67.75	119	53
	72RHDR7236L	1638	2100	71.75	36	29.5	67.75	124	54.75
	72RHDR7236R	1638	2100	71.75	36	29.5	67.75	124	54.75
	72RHDR7830L	1480	1897	77.75	30	29.5	73.75	126	57
	72RHDR7830R	1480	1897	77.75	30	29.5	73.75	126	57
	72RHDR7836L	1736	2229	77.75	36	29.5	73.75	131	57
	72RHDR7836R	1736	2229	77.75	36	29.5	73.75	131	57
	72RHDR8430L	1581	2028	83.75	30	29.5	79.75	132	61
	72RHDR8430R	1581	2028	83.75	30	29.5	79.75	132	61
	72RHDR8436L	1837	2356	83.75	36	29.5	79.75	137	63
	72RHDR8436R	1837	2356	83.75	36	29.5	79.75	137	63

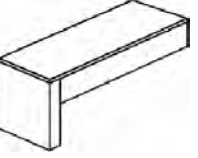
Rectangular Desk	72RHDR4830LX26	1194	1482	47.75	30	29.5	43.75	106	36.5
Return with 4" Gable	72RHDR4830RX26	1194	1482	47.75	30	29.5	43.75	106	36.5
and 1/2 Height Fixed	72RHDR4836LX26	1266	1596	47.75	36	29.5	43.75	112	36.5
Laminate Modesty	72RHDR4836RX26	1266	1596	47.75	36	29.5	43.75	112	36.5
Panel	72RHDR5430LX26	1239	1551	53.75	30	29.5	49.75	114	40.5
	72RHDR5430RX26	1239	1551	53.75	30	29.5	49.75	114	40.5
	72RHDR5436LX26	1309	1651	53.75	36	29.5	49.75	120	40.5
	72RHDR5436RX26	1309	1651	53.75	36	29.5	49.75	120	40.5
	72RHDR6030LX26	1288	1626	59.75	30	29.5	55.75	122	44.5
	72RHDR6030RX26	1288	1626	59.75	30	29.5	55.75	122	44.5
	72RHDR6036LX26	1360	1717	59.75	36	29.5	55.75	128	44.5
	72RHDR6036RX26	1360	1717	59.75	36	29.5	55.75	128	44.5
	72RHDR6630LX26	1332	1680	65.75	30	29.5	61.75	130	49
	72RHDR6630RX26	1332	1680	65.75	30	29.5	61.75	130	49
	72RHDR6636LX26	1403	1772	65.75	36	29.5	61.75	136	50
	72RHDR6636RX26*	1403	1772	65.75	36	29.5	61.75	136	50

## ORDERING PROCEDURE

To order, please specify the following:

- 1) Krug product model number
- 2) Laminates, see page 446
- 3) Edge detail- I,H, L or P, see page 448
- 4) Pull style, see page 449
- 5) Grommet location if applicable

\*Indicates model illustrated by line drawing.

## CODE DESCRIPTION

L - left hand pedestal position  
 R - right hand pedestal position  
 S6 - square Laminate leg  
 X26 - 1/2 height fixed Laminate modesty panel  
 X46 - full height Laminate modesty panel  
 D - 2 file drawer  
 F - 2 box, 1 file drawer  
 V26 - 1/2 height floating Laminate modesty panel  
 V29 - 1/2 height floating acrylic modesty panel  
 M - metal legs

## STANDARD LAMINATES

For a complete list of standard Laminates please see page 446.

## GROMMETS

One grommet in standard position is optional at no charge. See page 494 for more power management information.

ARTEMIS LAMINATE | RETURNS

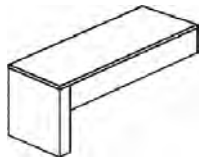
Description	Model	Laminate Top/Polymer Edge	HPL Top/Polymer Edge	W	D	H		Shipping Weight	Cubic Feet	
	Rectangular Desk Return with 4" Gable and 1/2 Height Fixed Laminate Modesty Panel	72RHDR7230LX26	1374	1734	71.75	30	29.5	67.75	138	53
	72RHDR7230RX26	1374	1734	71.75	30	29.5	67.75	138	53	
	72RHDR7236LX26	1504	1896	71.75	36	29.5	67.75	144	54.75	
	72RHDR7236RX26	1504	1896	71.75	36	29.5	67.75	144	54.75	
	72RHDR7830LX26	1480	1866	77.75	30	29.5	73.75	148	57	
	72RHDR7830RX26	1480	1866	77.75	30	29.5	73.75	148	57	
	72RHDR7836LX26	1604	2024	77.75	36	29.5	73.75	152	57	
	72RHDR7836RX26	1604	2024	77.75	36	29.5	73.75	152	57	
	72RHDR8430LX26	1573	1988	83.75	30	29.5	79.75	154	61	
	72RHDR8430RX26	1573	1988	83.75	30	29.5	79.75	154	61	
	72RHDR8436LX26	1704	2149	83.75	36	29.5	79.75	160	63	
	72RHDR8436RX26	1704	2149	83.75	36	29.5	79.75	160	63	

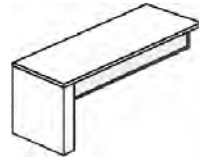
	Rectangular Desk Return with 4" Gable and 1/2 Height Floating Acrylic Modesty Panel	72RHDR4830LV29	1387	1677	47.75	30	29.5	43.75	105	36.5
	72RHDR4830RV29	1387	1677	47.75	30	29.5	43.75	105	36.5	
	72RHDR4836LV29	1459	1767	47.75	36	29.5	43.75	111	36.5	
	72RHDR4836RV29	1459	1767	47.75	36	29.5	43.75	111	36.5	
	72RHDR5430LV29	1429	1730	53.75	30	29.5	49.75	113	40.5	
	72RHDR5430RV29	1429	1730	53.75	30	29.5	49.75	113	40.5	
	72RHDR5436LV29	1508	1822	53.75	36	29.5	49.75	119	40.5	
	72RHDR5436RV29	1508	1822	53.75	36	29.5	49.75	119	40.5	
	72RHDR6030LV29	1615	1954	59.75	30	29.5	55.75	120	44.5	
	72RHDR6030RV29	1615	1954	59.75	30	29.5	55.75	120	44.5	
	72RHDR6036LV29	1686	2039	59.75	36	29.5	55.75	126	44.5	
	72RHDR6036RV29	1686	2039	59.75	36	29.5	55.75	126	44.5	
	72RHDR6630LV29	1659	2004	65.75	30	29.5	61.75	127	49	
	72RHDR6630RV29	1659	2004	65.75	30	29.5	61.75	127	49	
	72RHDR6636LV29	1734	2098	65.75	36	29.5	61.75	132	50	
	72RHDR6636RV29*	1734	2098	65.75	36	29.5	61.75	132	50	
	72RHDR7230LV29	1705	2062	71.75	30	29.5	67.75	133	53	
	72RHDR7230RV29	1705	2062	71.75	30	29.5	67.75	133	53	
	72RHDR7236LV29	2113	2559	71.75	36	29.5	67.75	139	54.75	
	72RHDR7236RV29	2113	2559	71.75	36	29.5	67.75	139	54.75	
	72RHDR7830LV29	1953	2361	77.75	30	29.5	73.75	141	57	
	72RHDR7830RV29	1953	2361	77.75	30	29.5	73.75	141	57	
	72RHDR7836LV29	2206	2669	77.75	36	29.5	73.75	139	57	
	72RHDR7836RV29	2206	2669	77.75	36	29.5	73.75	139	57	
	72RHDR8430LV29	2045	2476	83.75	30	29.5	79.75	146	61	
	72RHDR8430RV29	2045	2476	83.75	30	29.5	79.75	146	61	
	72RHDR8436LV29	2299	2780	83.75	36	29.5	79.75	152	63	
	72RHDR8436RV29	2299	2780	83.75	36	29.5	79.75	152	63	

**DIMENSION KEY**

W - width  
 D - depth  
 H - height

Dimensions are in inches and approximate. Contact Customer Service if dimensions are critical.

**CODE DESCRIPTION**

L - left hand pedestal position  
 R - right hand pedestal position  
 S6 - square Laminate leg  
 X26 - 1/2 height fixed Laminate modesty panel  
 X46 - full height Laminate modesty panel  
 D - 2 file drawer  
 F - 2 box, 1 file drawer  
 V26 - 1/2 height floating Laminate modesty panel  
 V29 - 1/2 height floating acrylic modesty panel  
 M - metal legs

**STANDARD LAMINATES**

For a complete list of standard Laminates please see page 446.

**GROMMETS**

One grommet in standard position is optional at no charge. See page 494 for more power management information.

# ARTEMIS LAMINATE | RETURNS

Description	Model	Laminate Top/Polymer Edge	HPL Top/Polymer Edge	W	D	H	KW	Shipping Weight	Cubic Feet
Rectangular Desk Return with 2"	72RHDR4830LM	931	1205	47.75	30	29.5	45.75	58	8
Square Metal Legs and no Modesty Panel	72RHDR4830RM	1006	1319	47.75	36	29.5	45.75	66	10
	72RHDR4836LM	1006	1319	47.75	36	29.5	45.75	66	10
	72RHDR4836RM	1006	1319	47.75	36	29.5	45.75	66	10
	72RHDR5430LM	977	1272	53.75	30	29.5	51.75	63	8.5
	72RHDR5430RM	977	1272	53.75	30	29.5	51.75	63	8.5
	72RHDR5436LM	1052	1380	53.75	36	29.5	51.75	71	10.75
	72RHDR5436RM	1052	1380	53.75	36	29.5	51.75	71	10.75
	72RHDR6030LM	1158	1524	59.75	30	29.5	57.75	72	9
	72RHDR6030RM	1158	1524	59.75	30	29.5	57.75	72	9
	72RHDR6036LM	1230	1618	59.75	36	29.5	57.75	81	11.5
	72RHDR6036RM	1230	1618	59.75	36	29.5	57.75	81	11.5
	72RHDR6630LM	1202	1567	65.75	30	29.5	63.75	76	10
	72RHDR6630RM	1202	1567	65.75	30	29.5	63.75	76	10
	72RHDR6636LM	1275	1509	65.75	36	29.5	63.75	93	12.5
	72RHDR6636RM*	1275	1509	65.75	36	29.5	63.75	93	12.5
	72RHDR7230LM	1253	1645	71.75	30	29.5	69.75	81	10.75
	72RHDR7230RM	1253	1645	71.75	30	29.5	69.75	81	10.75
	72RHDR7236LM	1463	1923	71.75	36	29.5	69.75	100	13.5
	72RHDR7236RM	1463	1923	71.75	36	29.5	69.75	100	13.5
	72RHDR7830LM	1433	1704	77.75	30	29.5	75.75	86	11.5
	72RHDR7830RM	1433	1704	77.75	30	29.5	75.75	86	11.5
	72RHDR7836LM	1514	1991	77.75	36	29.5	75.75	106	14
	72RHDR7836RM	1514	1991	77.75	36	29.5	75.75	106	14
	72RHDR8430LM	1492	1773	83.75	30	29.5	81.75	91	13
	72RHDR8430RM	1492	1773	83.75	30	29.5	81.75	91	13
	72RHDR8436LM	1581	2079	83.75	36	29.5	81.75	113	15
	72RHDR8436RM	1581	2079	83.75	36	29.5	81.75	113	15



### ORDERING NOTES:

If ordering a pencil drawer or keyboard for any table desk/rectangular return desk, please see page 691 for details.

Rectangular Desk Return with 2" Square Metal Leg and 1/2 Height Floating Acrylic Modesty Panel	72RHDR4830LV29M	1367	1653	47.75	30	29.5	45.75	63	8
	72RHDR4830RV29M	1367	1653	47.75	30	29.5	45.75	63	8
	72RHDR4836LV29M	1438	1752	47.75	36	29.5	45.75	70	10
	72RHDR4836RV29M	1438	1752	47.75	36	29.5	45.75	70	10
	72RHDR5430LV29M	1416	1728	53.75	30	29.5	51.75	68	8.5
	72RHDR5430RV29M	1416	1728	53.75	30	29.5	51.75	68	8.5
	72RHDR5436LV29M	1483	1810	53.75	36	29.5	51.75	76	10.75
	72RHDR5436RV29M	1483	1810	53.75	36	29.5	51.75	76	10.75
	72RHDR6030LV29M	1590	1942	59.75	30	29.5	57.75	78	9
	72RHDR6030RV29M	1590	1942	59.75	30	29.5	57.75	78	9
	72RHDR6036LV29M	1667	2033	59.75	36	29.5	57.75	87	11.5
	72RHDR6036RV29M	1667	2033	59.75	36	29.5	57.75	87	11.5
	72RHDR6630LV29M	1639	1998	65.75	30	29.5	63.75	83	10
	72RHDR6630RV29M	1639	1998	65.75	30	29.5	63.75	83	10
	72RHDR6636LV29M	1715	2092	65.75	36	29.5	63.75	108	13
	72RHDR6636RV29M*	1715	2092	65.75	36	29.5	63.75	108	13

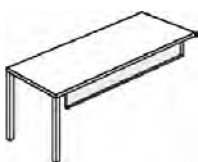

### ORDERING PROCEDURE

To order, please specify the following:

- 1) Krug product model number
- 2) Laminate, see page 26
- 3) Edge detail- I,H, L or P, see page 448
- 4) Pull style, see page 449
- 5) Grommet location if applicable

\*Indicates model illustrated by line drawing.

### CODE DESCRIPTION

L - left hand pedestal position  
 R - right hand pedestal position  
 S6 - square Laminate leg  
 X26 - 1/2 height fixed Laminate modesty panel  
 X46 - full height Laminate modesty panel  
 D - 2 file drawer  
 F - 2 box, 1 file drawer  
 V26 - 1/2 height floating Laminate modesty panel  
 V29 - 1/2 height floating acrylic modesty panel  
 M - metal legs

### STANDARD LAMINATES

For a complete list of standard Laminates please see page 446.

### GROMMETS

One grommet in standard position is optional at no charge. See page 494 for more power management information.

ARTEMIS LAMINATE | RETURNS

Description	Model	Laminate Top/Polymer Edge	HPL Top/Polymer Edge	W	D	H	KW	Shipping Weight	Cubic Feet
Rectangular Desk Return with 2" Square Metal Leg and 1/2 Height Floating Acrylic Modesty Panel 	72RHDR7230LV29M	1688	2059	71.75	30	29.5	69.75	89	10.75
	72RHDR7230RV29M	1688	2059	71.75	30	29.5	69.75	89	10.75
	72RHDR7236LV29M	2064	2520	71.75	36	29.5	69.75	115	14
	72RHDR7236RV29M	2064	2520	71.75	36	29.5	69.75	115	14
	72RHDR7830LV29M	1906	2324	77.75	30	29.5	75.75	94	11.5
	72RHDR7830RV29M	1906	2324	77.75	30	29.5	75.75	94	11.5
	72RHDR7836LV29M	2121	2590	77.75	36	29.5	75.75	115	15
	72RHDR7836RV29M	2121	2590	77.75	36	29.5	75.75	115	15
	72RHDR8430LV29M	1959	2390	83.75	30	29.5	81.75	100	13
	72RHDR8430RV29M	1959	2390	83.75	30	29.5	81.75	100	13
72RHDR8436LV29M	2188	2669	83.75	36	29.5	81.75	128	16	
72RHDR8436RV29M	2188	2669	83.75	36	29.5	81.75	128	16	

Rectangular Desk Return with Panel Leg and no Modesty Panel 	72RHDR4830LP6	779	1038	47.75	30	29.5	27.75	56	8.5
	72RHDR4830RP6	779	1038	47.75	30	29.5	27.75	56	8.5
	72RHDR4836LP6	848	1161	47.75	36	29.5	27.75	64	12
	72RHDR4836RP6	848	1161	47.75	36	29.5	27.75	64	12
	72RHDR5430LP6	820	1111	53.75	30	29.5	33.75	61	9
	72RHDR5430RP6	820	1111	53.75	30	29.5	33.75	61	9
	72RHDR5436LP6	892	1240	53.75	36	29.5	33.75	69	13
	72RHDR5436RP6	892	1240	53.75	36	29.5	33.75	69	13
	72RHDR6030LP6	868	1185	59.75	30	29.5	39.75	65	10
	72RHDR6030RP6	868	1185	59.75	30	29.5	39.75	65	10
	72RHDR6036LP6	941	1315	59.75	36	29.5	39.75	75	13.75
	72RHDR6036RP6	941	1315	59.75	36	29.5	39.75	75	13.75
	72RHDR6630LP6	912	1266	65.75	30	29.5	45.75	70	10.75
	72RHDR6630RP6	912	1266	65.75	30	29.5	45.75	70	10.75
	72RHDR6636LP6*	982	1393	65.75	36	29.5	45.75	93	14
	72RHDR6636RP6	982	1393	65.75	36	29.5	45.75	93	14
	72RHDR7230LP6	1116	1501	71.75	30	29.5	51.75	79	11.5
	72RHDR7230RP6	1116	1501	71.75	30	29.5	51.75	79	11.5
	72RHDR7236LP6	1197	1662	71.75	36	29.5	51.75	100	15
	72RHDR7236RP6	1197	1662	71.75	36	29.5	51.75	100	15
	72RHDR7830LP6	1183	1606	77.75	30	29.5	57.75	84	13
	72RHDR7830RP6	1183	1606	77.75	30	29.5	57.75	84	13
	72RHDR7836LP6	1272	1768	77.75	36	29.5	57.75	106	16
	72RHDR7836RP6	1272	1768	77.75	36	29.5	57.75	106	16
	72RHDR8430LP6	1262	1712	83.75	30	29.5	63.75	89	14.5
	72RHDR8430RP6	1262	1712	83.75	30	29.5	63.75	89	14.5
	72RHDR8436LP6	1347	1884	83.75	36	29.5	63.75	113	17
	72RHDR8436RP6	1347	1884	83.75	36	29.5	63.75	113	17

**DIMENSION KEY**

W - width  
 D - depth  
 H - height

Dimensions are in inches and approximate. Contact Customer Service if dimensions are critical.

**CODE DESCRIPTION**

L - left hand pedestal position  
 R - right hand pedestal position  
 S6 - square Laminate leg  
 X26 - 1/2 height fixed Laminate modesty panel  
 X46 - full height Laminate modesty panel  
 D - 2 file drawer  
 F - 2 box, 1 file drawer  
 V26 - 1/2 height floating Laminate modesty panel  
 V29 - 1/2 height floating acrylic modesty panel  
 M - metal legs

**STANDARD LAMINATES**

For a complete list of standard Laminates please see page 446.

**GROMMETS**

One grommet in standard position is optional at no charge. See page 494 for more power management information.



# ARTEMIS LAMINATE | RETURNS

Description	Model	Laminate Top/Polymer Edge	HPL Top/Polymer Edge	W	D	H	KW	Shipping Weight	Cubic Feet
Rectangular Desk Return with Panel Leg and 1/2 Height Floating Acrylic Modesty Panel	72RHDR4830LV29P6	1229	1512	47.75	30	29.5	30.75	59	8.5
	72RHDR4830RV29P6	1229	1512	47.75	30	29.5	30.75	59	8.5
	72RHDR4836LV29P6	1307	1636	47.75	36	29.5	27.75	67	12
	72RHDR4836RV29P6	1307	1636	47.75	36	29.5	27.75	67	12
	72RHDR5430LV29P6	1275	1584	53.75	30	29.5	36.75	65	9
	72RHDR5430RV29P6	1275	1584	53.75	30	29.5	36.75	65	9
	72RHDR5436LV29P6	1351	1691	53.75	36	29.5	33.75	73	13
	72RHDR5436RV29P6	1351	1691	53.75	36	29.5	33.75	73	13
	72RHDR6030LV29P6	1323	1660	59.75	30	29.5	42.75	70	10
	72RHDR6030RV29P6	1323	1660	59.75	30	29.5	42.75	70	10
	72RHDR6036LV29P6	1405	1760	59.75	36	29.5	39.75	80	13.75
	72RHDR6036RV29P6	1405	1760	59.75	36	29.5	39.75	80	13.75
	72RHDR6630LV29P6	1383	1731	65.75	30	29.5	48.75	76	10.75
	72RHDR6630RV29P6	1383	1731	65.75	30	29.5	48.75	76	10.75
	72RHDR6636LV29P6	1451	1816	65.75	36	29.5	45.75	108	14.5
	72RHDR6636RV29P6	1451	1816	65.75	36	29.5	45.75	108	14.5
	72RHDR7230LV29P6*	1425	1782	71.75	30	29.5	54.75	86	11.5
	72RHDR7230RV29P6	1425	1782	71.75	30	29.5	54.75	86	11.5
	72RHDR7236LV29P6	1683	2106	71.75	36	29.5	51.75	115	15.75
	72RHDR7236RV29P6	1683	2106	71.75	36	29.5	51.75	115	15.75
	72RHDR7830LV29P6	1651	2065	77.75	30	29.5	60.75	91	13
	72RHDR7830RV29P6	1651	2065	77.75	30	29.5	60.75	91	13
	72RHDR7836LV29P6	1892	2368	77.75	36	29.5	57.75	121	16.75
	72RHDR7836RV29P6	1892	2368	77.75	36	29.5	57.75	121	16.75
	72RHDR8430LV29P6	1878	2348	83.75	30	29.5	66.75	96	14.5
	72RHDR8430RV29P6	1878	2348	83.75	30	29.5	66.75	96	14.5
	72RHDR8436LV29P6	1979	2478	83.75	36	29.5	63.75	128	17.75
	72RHDR8436RV29P6	1979	2478	83.75	36	29.5	63.75	128	17.75

## ORDERING PROCEDURE

To order, please specify the following:

- 1) Krug product model number
- 2) Laminate, see page 446
- 3) Edge detail- I,H, L or P, see page 448
- 4) Pull style, see page 449
- 5) Grommet location if applicable

\*Indicates model illustrated by line drawing.

## CODE DESCRIPTION

L - left hand pedestal position  
 R - right hand pedestal position  
 S6 - square Laminate leg  
 X26 - 1/2 height fixed Laminate modesty panel  
 X46 - full height Laminate modesty panel  
 D - 2 file drawer  
 F - 2 box, 1 file drawer  
 V26 - 1/2 height floating Laminate modesty panel  
 V29 - 1/2 height floating acrylic modesty panel  
 M - metal legs

## STANDARD LAMINATES

For a complete list of standard Laminates please see page 446.

## GROMMETS

One grommet in standard position is optional at no charge. See page 494 for more power management information.

# ARTEMIS LAMINATE | LINKING UNITS

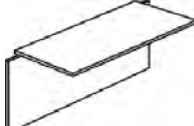
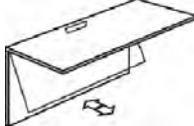
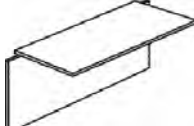
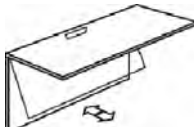
Description	Model	Laminate Top/Polymer Edge	HPL Top/Polymer Edge	W	D	H	Shipping Weight	Cubic Feet
 Linking Tops	72LU3620H	331	457	36	20	-	15	1.5
	72LU3624H	353	508	36	24	-	16	1.75
	72LU4220H*	352	500	42	20	-	20	1.5
	72LU4224H	374	544	42	24	-	24	2
	72LU4820H	397	562	48	20	-	29	1.75
	72LU4824H	422	620	48	24	-	36	2
 Linking Unit with Fixed Laminate Modesty Panel	72LU3620HX46	527	647	36	20	29.5	59	3
	72LU3624HX46	568	699	36	24	29.5	64	3
	72LU4220HX46*	580	711	42	20	29.5	67	3.75
	72LU4224HX46	669	823	42	24	29.5	72	3.75
	72LU4820HX46	644	794	48	20	29.5	78	4
	72LU4824HX46	766	943	48	24	29.5	80	4
 Linking Unit with Hinged Laminate Modesty Panel	72LUY3620H	580	701	36	20	29.5	59	3
	72LUY3624H	626	757	36	24	29.5	64	3
	72LUY4220H	636	767	42	20	29.5	67	3.5
	72LUY4224H*	731	878	42	24	29.5	72	3.5
	72LUY4820H	705	853	48	20	29.5	78	4
	72LUY4824H	834	1011	48	24	29.5	80	4
 Linking Unit for Table Desks with Fixed Laminate Modesty Panel	72LUTD3620HLX46	527	647	36	20	29.5	59	3
	72LUTD3620HRX46	527	647	36	20	29.5	59	3
	72LUTD3624HLX46	568	699	36	24	29.5	64	3
	72LUTD3624HRX46	568	699	36	24	29.5	64	3
	72LUTD4220HLX46	580	711	42	20	29.5	67	3.75
	72LUTD4220HRX46	580	711	42	20	29.5	67	3.75
	72LUTD4224HLX46	669	823	42	24	29.5	72	3.75
	72LUTD4224HRX46	669	823	42	24	29.5	72	3.75
	72LUTD4820HLX46	644	794	48	20	29.5	78	4
	72LUTD4820HRX46	644	794	48	20	29.5	78	4
	72LUTD4824HLX46	766	943	48	24	29.5	80	4
	72LUTD4824HRX46	766	943	48	24	29.5	80	4
 Linking Unit for Table Desks with Hinged Laminate Modesty Panel	72LUYTD3620HL	580	711	36	20	29.5	59	3
	72LUYTD3620HR	580	711	36	20	29.5	59	3
	72LUYTD3624HL	626	757	36	24	29.5	64	3
	72LUYTD3624HR	626	757	36	24	29.5	64	3
	72LUYTD4220HL	636	783	42	20	29.5	67	3.75
	72LUYTD4220HR	636	783	42	20	29.5	67	3.75
	72LUYTD4224HL	731	878	42	24	29.5	72	3.75
	72LUYTD4224HR	731	878	42	24	29.5	72	3.75
	72LUYTD4820HL	705	868	48	20	29.5	78	4
	72LUYTD4820HR	705	868	48	20	29.5	78	4
	72LUYTD4824HL	834	1011	48	24	29.5	80	4
	72LUYTD4824HR	834	1011	48	24	29.5	80	4

**ORDERING NOTES:**

**DIMENSION KEY**

W - width  
D - depth  
H - height

Dimensions are in inches and approximate. Contact Customer Service if dimensions are critical.

**CODE DESCRIPTION**

X46 - full height wood modesty panel  
Y - Laminate hinged modesty panel  
H - desk height

**STANDARD LAMINATES**

For a complete list of standard Laminates please see page 446.

**GROMMETS**

One grommet in standard position is optional at no charge. See page 494 for more power management information.

# ARTEMIS LAMINATE | LINKING TOPS, UNITS & CORNER UNITS

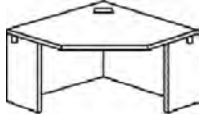
Description	Model	Laminate Top/Polymer Edge	HPL Top/Polymer Edge	W	D	H	KW	Shipping Weight	Cubic Feet
 Corner Unit	72CU363620	1141	1383	36	36	29.5	22.5	106	29
	72CU363624*	1141	1383	36	36	29.5	17	106	29
	72CU424220	1354	1638	42	42	29.5	31	131	38
	72CU424224	1354	1638	42	42	29.5	25.25	131	38

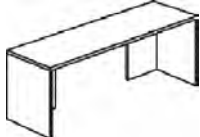
Description	Model	Laminate Top/Polymer Edge	HPL Top/Polymer Edge	W	D	H	KW	Shipping Weight	Cubic Feet
 Credenza Shell with no Modesty Panel	72SC6624	1063	1331	24	65.75	29.5	63.5	104	35
	72SC7224*	1119	1414	24	71.75	29.5	69.5	112	38
	72SC7824	1257	1570	24	77.75	29.5	75.5	120	40
	72SC8424	1354	1692	24	83.75	29.5	81.5	128	44

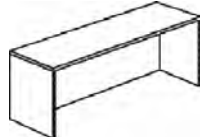
Description	Model	Laminate Top/Polymer Edge	HPL Top/Polymer Edge	W	D	H	KW	Shipping Weight	Cubic Feet
 Credenza Shell with full Modesty Panel	72SC6624X46	1273	1594	24	65.75	29.5	63.5	104	35
	72SC7224X46	1346	1698	24	71.75	29.5	69.5	112	38
	72SC7824X46	1508	1886	24	77.75	29.5	75.5	120	40
	72SC8424X46	1622	2032	24	83.75	29.5	81.5	128	44

## ORDERING PROCEDURE

To order, please specify the following:

- 1) Krug product model number
- 2) Laminates, see page 446
- 3) Edge detail- I,H, L or P, see page 448
- 4) Pull style, see page 449
- 5) Grommet location if applicable

\*Indicates model illustrated by line drawing.

## CODE DESCRIPTION

X46 - full height modesty panel  
 Y - Laminate hinged modesty panel  
 H - desk height

## STANDARD LAMINATES

For a complete list of standard laminates please see page 446.

## GROMMETS

One grommet in standard position is optional at no charge. See page 494 for more power management information.

## ARTEMIS LAMINATE | CREDENZAS

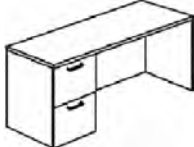
Description	Model	Laminate Top/Polymer Edge	HPL Top/Polymer Edge	W	D	H	KW	Shipping Weight	Cubic Feet
Single Pedestal	72C60204XLDR0	1781	2045	59.75	20	29.5	43	120	27.75
Credenza with	72C60204XLFR0	1781	2045	59.75	20	29.5	43	120	27.75
Fixed Laminate	72C60204XLORD	1781	2045	59.75	20	29.5	43	120	27.75
Modesty Panel	72C60204XLORF	1781	2045	59.75	20	29.5	43	120	27.75
	72C60244XLDR0	1898	2177	59.75	24	29.5	43	128	32
	72C60244XLFR0	1898	2177	59.75	24	29.5	43	128	32
	72C60244XLORD	1898	2177	59.75	24	29.5	43	128	32
	72C60244XLORF	1898	2177	59.75	24	29.5	43	128	32
	72C66204XLDR0*	1828	2096	65.75	20	29.5	49	136	30
	72C66204XLFR0	1828	2096	65.75	20	29.5	49	136	30
	72C66204XLORD	1828	2096	65.75	20	29.5	49	36	30
	72C66204XLORF	1828	2096	65.75	20	29.5	49	136	30
	72C66244XLDR0	1923	2206	65.75	24	29.5	49	144	35
	72C66244XLFR0	1923	2206	65.75	24	29.5	49	144	35
	72C66244XLORD	1923	2206	65.75	24	29.5	49	144	35
	72C66244XLORF	1923	2206	65.75	24	29.5	49	144	35
	72C72204XLDR0	1855	2129	71.75	20	29.5	55	152	32.75
	72C72204XLFR0	1855	2129	71.75	20	29.5	55	152	32.75
	72C72204XLORD	1855	2129	71.75	20	29.5	55	152	32.75
	72C72204XLORF	1855	2129	71.75	20	29.5	55	152	32.75
	72C72244XLDR0	1991	2283	71.75	24	29.5	55	160	38
	72C72244XLFR0	1991	2283	71.75	24	29.5	55	160	38
	72C72244XLORD	1991	2283	71.75	24	29.5	55	160	38
	72C72244XLORF	1991	2283	71.75	24	29.5	55	160	38
	72C78204XLDR0	1981	2272	77.75	20	29.5	61	168	35.5
	72C78204XLFR0	1981	2272	77.75	20	29.5	61	168	35.5
	72C78204XLORD	1981	2272	77.75	20	29.5	61	168	35.5
	72C78204XLORF	1981	2272	77.75	20	29.5	61	168	35.5
	72C78244XLDR0	2129	2440	77.75	24	29.5	61	172	41
	72C78244XLFR0	2129	2440	77.75	24	29.5	61	172	41
	72C78244XLORD	2129	2440	77.75	24	29.5	61	172	41
	72C78244XLORF	2129	2440	77.75	24	29.5	61	172	41
72C84204XLDR0	2165	2483	83.75	20	29.5	67	184	38	
72C84204XLFR0	2165	2483	83.75	20	29.5	67	184	38	
72C84204XLORD	2165	2483	83.75	20	29.5	67	184	38	
72C84204XLORF	2165	2483	83.75	20	29.5	67	184	38	
72C84244XLDR0	2326	2668	83.75	24	29.5	67	192	44	
72C84244XLFR0	2326	2668	83.75	24	29.5	67	192	44	
72C84244XLORD	2326	2668	83.75	24	29.5	67	192	44	
72C84244XLORF	2326	2668	83.75	24	29.5	67	192	44	

**DIMENSION KEY**

W - width  
D - depth  
H - height

Dimensions are in inches and approximate.  
Contact Customer Service if dimensions are critical.

**CODE DESCRIPTION**

L - left hand pedestal position  
R - right hand pedestal position  
0 - no pedestal  
4 - full height pedestal  
B - bookcase  
D - 2 file drawer  
F - 2 box, 1 file drawer  
Y - hinged modesty panel  
X - includes a modesty panel  
1 - lateral file pedestal  
2 - 1 file, 2 box, 1 lateral file pedestal  
04 - 2 box, 1 file, 1 lateral file pedestal

**STANDARD LAMINATES**

For a complete list of standard Laminates please see page 446.

**GROMMETS**

One grommet in standard position is optional at no charge. See page 494 for more power management information.

# ARTEMIS LAMINATE | CREDENZA

Description	Model	Laminate Top/Polymer Edge	HPL Top/Polymer Edge	W	D	H	KW	Shipping Weight	Cubic Feet
Single 36" Pedestal	72C7220XLFR0	2250	2580	71.75	20	29.5	35	168	32.75
Lateral File or Bookcase	72C7220XL0RF	2250	2580	71.75	20	29.5	35	168	32.75
Credenza with Fixed	72C7220XLBR0	1869	2164	71.75	20	29.5	35	128	32.75
Laminate Modesty Panel	72C7220XL0RB	1869	2164	71.75	20	29.5	35	128	32.75
	72C7224XLFR0*	2373	2744	71.75	24	29.5	35	176	38
	72C7224XL0RF	2373	2744	71.75	24	29.5	35	76	38
	72C7224XLBR0	1991	2304	71.75	24	29.5	35	136	38
	72C7224XL0RB	1991	2304	71.75	24	29.5	35	136	38
	72C7820XLFR0	2502	2870	77.75	20	29.5	41	195	35.5
	72C7820XL0RF	2502	2870	77.75	20	29.5	41	195	35.5
	72C7820XLBR0	2121	2457	77.75	20	29.5	41	155	35.5
	72C7820XL0RB	2121	2457	77.75	20	29.5	41	155	35.5
	72C7824XLFR0	2637	3054	77.75	24	29.5	41	199	41
	72C7824XL0RF	2637	3054	77.75	24	29.5	41	199	41
	72C7824XLBR0	2256	2612	77.75	24	29.5	41	174	41
	72C7824XL0RB	2256	2612	77.75	24	29.5	41	174	41
	72C8420XLFR0	2779	3187	83.75	20	29.5	47	221	38
	72C8420XL0RF	2779	3187	83.75	20	29.5	47	221	38
	72C8420XLBR0	2398	2778	83.75	20	29.5	47	181	38
	72C8420XL0RB	2398	2778	83.75	20	29.5	47	181	38
	72C8424XLFR0	2928	3389	83.75	24	29.5	47	252	44
	72C8424XL0RF	2928	3389	83.75	24	29.5	47	252	44
	72C8424XLBR0	2551	2952	83.75	24	29.5	47	212	44
	72C8424XL0RB	2551	2952	83.75	24	29.5	47	212	44

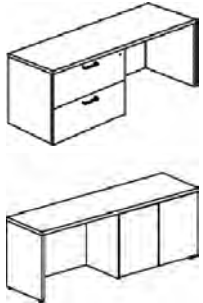

### ORDERING NOTES:

Credenzas with bookcase pedestals have the option of pulls instead of the standard touch latch doors. To select this option, please change the prefix in the model number from "72" to "73" ie: 73C7220XLBR0. Please refer to page 645 for pull orientation below the worksurface. Locks are available on wood doors for an **upcharge of \$152 list**.

Single 36" Combination	72C7220XL3602R0	2326	2618	71.75	20	29.5	35	168	32.75
Pedestal Credenza with	72C7220XL0R3604	2326	2618	71.75	20	29.5	35	168	32.75
Fixed Laminate Modesty	72C7224XL3602R0*	2451	2760	71.75	24	29.5	35	176	38
Panel	72C7224XL0R3604	2451	2760	71.75	24	29.5	35	176	38
	72C7820XL3602R0	2580	2906	77.75	20	29.5	41	174	35.5
	72C7820XL0R3604	2580	2906	77.75	20	29.5	41	174	35.5
	72C7824XL3602R0	2715	3056	77.75	24	29.5	41	182	41
	72C7824XL0R3604	2715	3056	77.75	24	29.5	41	182	41
	72C8420XL3602R0	2854	3215	83.75	20	29.5	47	180	38
	72C8420XL0R3604	2854	3215	83.75	20	29.5	47	180	38
	72C8424XL3602R0	3006	3385	83.75	24	29.5	47	188	44
	72C8424XL0R3604	3006	3385	83.75	24	29.5	47	188	44

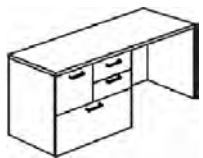

### ORDERING PROCEDURE

To order, please specify the following:

- 1) Krug product model number
- 2) Laminate, see page 446
- 3) Edge detail- I,H, L or P, see page 448
- 4) Pull style, see page 449
- 5) Grommet location if applicable

\*Indicates model illustrated by line drawing.

### CODE DESCRIPTION

L - left hand pedestal position  
 R - right hand pedestal position  
 0 - no pedestal  
 4 - full height pedestal  
 B - bookcase  
 D - 2 file drawer  
 F - 2 box, 1 file drawer  
 Y - hinged modesty panel  
 X - includes a modesty panel  
 1- lateral file pedestal  
 2- 1 file, 2 box, 1 lateral file pedestal  
 04- 2 box, 1 file, 1 lateral file pedestal

### STANDARD LAMINATES

For a complete list of standard laminates please see page 446.

### GROMMETS

One grommet in standard position is optional at no charge. See page 494 for more power management information.

**ARTEMIS LAMINATE | CREDENZA**

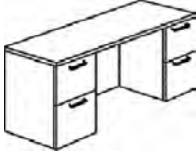
Description	Model	Laminate Top/Polymer Edge	HPL Top/Polymer Edge	W	D	H	KW	Shipping Weight	Cubic Feet	
	Double Pedestal Credenza with Fixed Modesty Panel	72C60204XLDRD	2332	2601	59.75	20	29.5	28.5	200	27.75
	72C60204XLDRF	2332	2601	59.75	20	29.5	28.5	200	27.75	
	72C60204XLFRD	2332	2601	59.75	20	29.5	28.5	200	27.75	
	72C60204XLFRF	2332	2601	59.75	20	29.5	28.5	200	27.75	
	72C60244XLDRD*	2489	2778	59.75	24	29.5	28.5	208	32	
	72C60244XLDRF	2489	2778	59.75	24	29.5	28.5	208	32	
	72C60244XLFRD	2489	2778	59.75	24	29.5	28.5	208	32	
	72C60244XLFRF	2489	2778	59.75	24	29.5	28.5	208	32	
	72C66204XLDRD	2378	2654	65.75	20	29.5	34.5	216	30	
	72C66204XLDRF	2378	2654	65.75	20	29.5	34.5	216	30	
	72C66204XLFRD	2378	2654	65.75	20	29.5	34.5	216	30	
	72C66204XLFRF	2378	2654	65.75	20	29.5	34.5	216	30	
	72C66244XLDRD	2508	2800	65.75	24	29.5	34.5	224	35	
	72C66244XLDRF	2508	2800	65.75	24	29.5	34.5	224	35	
	72C66244XLFRD	2508	2800	65.75	24	29.5	34.5	224	35	
	72C66244XLFRF	2508	2800	65.75	24	29.5	34.5	224	35	
	72C72204XLDRD	2398	2676	71.75	20	29.5	40.5	232	32.75	
	72C72204XLDRF	2398	2676	71.75	20	29.5	40.5	232	32.75	
	72C72204XLFRD	2398	2676	71.75	20	29.5	40.5	232	32.75	
	72C72204XLFRF	2398	2676	71.75	20	29.5	40.5	232	32.75	
	72C72244XLDRD	2629	2917	71.75	24	29.5	40.5	240	38	
	72C72244XLDRF	2629	2917	71.75	24	29.5	40.5	240	38	
	72C72244XLFRD	2629	2917	71.75	24	29.5	40.5	240	38	
	72C72244XLFRF	2629	2917	71.75	24	29.5	40.5	240	38	
	72C78204XLDRD	2629	2917	77.75	20	29.5	46.5	248	35.5	
	72C78204XLDRF	2629	2917	77.75	20	29.5	46.5	248	35.5	
	72C78204XLFRD	2629	2917	77.75	20	29.5	46.5	248	35.5	
	72C78204XLFRF	2629	2917	77.75	20	29.5	46.5	248	35.5	
	72C78244XLDRD	2810	3135	77.75	24	29.5	46.5	256	41	
	72C78244XLDRF	2810	3135	77.75	24	29.5	46.5	256	41	
	72C78244XLFRD	2810	3135	77.75	24	29.5	46.5	256	41	
	72C78244XLFRF	2810	3135	77.75	24	29.5	46.5	256	41	
72C84204XLDRD	2881	3211	83.75	20	29.5	52.5	264	38		
72C84204XLDRF	2881	3211	83.75	20	29.5	52.5	264	38		
72C84204XLFRD	2881	3211	83.75	20	29.5	52.5	264	38		
72C84204XLFRF	2881	3211	83.75	20	29.5	52.5	264	38		
72C84244XLDRD	3078	3433	83.75	24	29.5	52.5	272	44		
72C84244XLDRF	3078	3433	83.75	24	29.5	52.5	272	44		
72C84244XLFRD	3078	3433	83.75	24	29.5	52.5	272	44		
72C84244XLFRF	3078	3433	83.75	24	29.5	52.5	272	44		

**DIMENSION KEY**

W - width  
D - depth  
H - height

Dimensions are in inches and approximate. Contact Customer Service if dimensions are critical.

**CODE DESCRIPTION**

L - left hand pedestal position  
R - right hand pedestal position  
0 - no pedestal  
4 - full height pedestal  
B - bookcase  
D - 2 file drawer  
F - 2 box, 1 file drawer  
Y - hinged modesty panel  
X - includes a modesty panel  
1 - lateral file pedestal  
2 - 1 file, 2 box, 1 lateral file pedestal  
04 - 2 box, 1 file, 1 lateral file pedestal

**STANDARD LAMINATES**

For a complete list of standard Laminates please see page 446.

**GROMMETS**

One grommet in standard position is optional at no charge. See page 494 for more power management information.

# ARTEMIS LAMINATE | CREDENZA

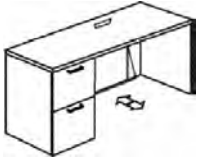
Description	Model	Laminate Top/Polymer Edge	HPL Top/Polymer Edge	W	D	H	KW	Shipping Weight	Cubic Feet	
	Single Pedestal Credenza with Hinged Laminate Modesty Panel	72CY60204LDR0	2117	2407	59.75	20	29.5	43	120	27.75
		72CY60204LFR0	2117	2407	59.75	20	29.5	43	120	27.75
		72CY60204LORD	2117	2407	59.75	20	29.5	43	120	27.75
		72CY60204LORF	2117	2407	59.75	20	29.5	43	120	27.75
		72CY60244LDR0*	2234	2562	59.75	24	29.5	43	128	32
		72CY60244LFR0	2234	2562	59.75	24	29.5	43	128	32
		72CY60244LORD	2234	2562	59.75	24	29.5	43	128	32
		72CY60244LORF	2234	2562	59.75	24	29.5	43	128	32
		72CY66204LDR0	2163	2480	65.75	20	29.5	49	136	30
		72CY66204LFR0	2163	2480	65.75	20	29.5	49	136	30
		72CY66204LORD	2163	2480	65.75	20	29.5	49	136	30
		72CY66204LORF	2163	2480	65.75	20	29.5	49	136	30
		72CY66244LDR0	2163	2587	65.75	24	29.5	49	144	35
		72CY66244LFR0	2255	2587	65.75	24	29.5	49	144	35
		72CY66244LORD	2255	2587	65.75	24	29.5	49	144	35
		72CY66244LORF	2255	2587	65.75	24	29.5	49	144	35
		72CY72204LDR0	2188	2486	71.75	20	29.5	55	152	32.75
		72CY72204LFR0	2188	2486	71.75	20	29.5	55	152	32.75
		72CY72204LORD	2188	2486	71.75	20	29.5	55	152	32.75
		72CY72204LORF	2188	2486	71.75	20	29.5	55	152	32.75
		72CY72244LDR0	2326	2668	71.75	24	29.5	55	160	38
		72CY72244LFR0	2326	2668	71.75	24	29.5	55	160	38
		72CY72244LORD	2326	2668	71.75	24	29.5	55	160	38
		72CY72244LORF	2326	2668	71.75	24	29.5	55	160	38
		72CY78204LDR0	2313	2654	77.75	20	29.5	61	168	35.5
		72CY78204LFR0	2313	2654	77.75	20	29.5	61	168	35.5
		72CY78204LORD	2313	2654	77.75	20	29.5	61	168	35.5
		72CY78204LORF	2313	2654	77.75	20	29.5	61	168	35.5
	72CY78244LDR0	2461	2822	77.75	24	29.5	61	176	41	
	72CY78244LFR0	2461	2822	77.75	24	29.5	61	176	41	
	72CY78244LORD	2461	2822	77.75	24	29.5	61	176	41	
	72CY78244LORF	2461	2822	77.75	24	29.5	61	176	41	
	72CY84204LDR0	2497	2864	83.75	20	29.5	67	184	38	
	72CY84204LFR0	2497	2864	83.75	20	29.5	67	184	38	
	72CY84204LORD	2497	2864	83.75	20	29.5	67	184	38	
	72CY84204LORF	2497	2864	83.75	20	29.5	67	184	38	
	72CY84244LDR0	2659	3049	83.75	24	29.5	67	192	44	
	72CY84244LFR0	2659	3049	83.75	24	29.5	67	192	44	
	72CY84244LORD	2659	3049	83.75	24	29.5	67	192	44	
	72CY84244LORF	2659	3049	83.75	24	29.5	67	192	44	

## ORDERING PROCEDURE

To order, please specify the following:

- 1) Krug product model number
- 2) Laminate, see page 446
- 3) Edge detail- I,H, L or P, see page 448
- 4) Pull style, see page 449
- 5) Grommet location if applicable

\*Indicates model illustrated by line drawing.

## CODE DESCRIPTION

L - left hand pedestal position  
 R - right hand pedestal position  
 0 - no pedestal  
 4 - full height pedestal  
 B - bookcase  
 D - 2 file drawer  
 F - 2 box, 1 file drawer  
 Y - hinged modesty panel  
 X - includes a modesty panel  
 1 - lateral file pedestal  
 2 - 1 file, 2 box, 1 lateral file pedestal  
 04 - 2 box, 1 file, 1 lateral file pedestal

## STANDARD LAMINATES

For a complete list of standard laminates please see page 446.

## GROMMETS

One grommet in standard position is optional at no charge. See page 494 for more power management information.

# ARTEMIS LAMINATE | CREDENZA

Description	Model	Laminate Top/Polymer Edge	HPL Top/Polymer Edge	W	D	H	KW	Shipping Weight	Cubic Feet
Single 36" Pedestal	72CY7220LFR0	2585	2936	71.75	20	29.5	35	156	32.75
Lateral File or Bookcase with Hinged	72CY7220LORF	2585	2936	71.75	20	29.5	35	156	32.75
	72CY7220LBR0	2202	2504	71.75	20	29.5	35	116	32.75
Laminate Modesty Panel	72CY7220LORB	2202	2504	71.75	20	29.5	35	116	32.75
	72CY7224LFR0	2709	3077	71.75	24	29.5	35	160	38
	72CY7224LORF	2709	3077	71.75	24	29.5	35	160	38
	72CY7224LBR0	2326	2642	71.75	24	29.5	35	120	38
	72CY7224LORB	2326	2642	71.75	24	29.5	35	120	38
	72CY7820LFR0	2835	3221	77.75	20	29.5	41	195	35.5
	72CY7820LORF	2835	3221	77.75	20	29.5	41	195	35.5
	72CY7820LBR0	2458	2791	77.75	20	29.5	41	155	35.5
	72CY7820LORB	2458	2791	77.75	20	29.5	41	155	35.5
	72CY7824LFR0	2971	3381	77.75	24	29.5	41	199	41
	72CY7824LORF	2971	3381	77.75	24	29.5	41	199	41
	72CY7824LBR0	2591	2946	77.75	24	29.5	41	174	41
	72CY7824LORB	2591	2946	77.75	24	29.5	41	174	41
	72CY8420LFR0	3112	3536	83.75	20	29.5	47	221	38
	72CY8420LORF	3112	3536	83.75	20	29.5	47	221	38
	72CY8420LBR0	2734	3104	83.75	20	29.5	47	181	38
	72CY8420LORB	2734	3104	83.75	20	29.5	47	181	38
	72CY8424LFR0*	3261	3708	83.75	24	29.5	47	252	44
	72CY8424LORF	3261	3708	83.75	24	29.5	47	252	44
	72CY8424LBR0	2882	3274	83.75	24	29.5	47	212	44
	72CY8424LORB	2882	3274	83.75	24	29.5	47	212	44

**ORDERING NOTES:**

Credenzas with bookcase pedestals have the option of pulls instead of the standard touch latch doors. To select this option, please change the prefix in the model number from "72" to "73" ie: 73C7220XLBR0. Please refer to page 449 for pull orientation below the worksurface. Locks are available on wood doors for an **upcharge of \$152 list.**

Single 36" Combination Pedestal Credenza with Hinged Laminate Modesty Panel	72CY7220L3602R0	2659	2910	71.75	20	29.5	35	168	32.75
	72CY7220LOR3604	2659	2910	71.75	20	29.5	35	168	32.75
	72CY7224L3602R0*	2783	3045	71.75	24	29.5	35	176	38
	72CY7224LOR3604	2783	3045	71.75	24	29.5	35	176	38
	72CY7820L3602R0	2912	3187	77.75	20	29.5	41	174	35.5
	72CY7820LOR3604	2912	3187	77.75	20	29.5	41	174	35.5
	72CY7824L3602R0	3047	3297	77.75	24	29.5	41	182	41
	72CY7824LOR3604	3047	3297	77.75	24	29.5	41	182	41
	72CY8420L3602R0	3188	3491	83.75	20	29.5	47	180	38
	72CY8420LOR3604	3188	3491	83.75	20	29.5	47	180	38
	72CY8424L3602R0	3341	3655	83.75	24	29.5	47	188	44
72CY8424LOR3604	3341	3655	83.75	24	29.5	47	188	44	

**DIMENSION KEY**

W - width  
D - depth  
H - height

Dimensions are in inches and approximate. Contact Customer Service if dimensions are critical.

**CODE DESCRIPTION**

L - left hand pedestal position  
R - right hand pedestal position  
0 - no pedestal  
4 - full height pedestal  
B - bookcase  
D - 2 file drawer  
F - 2 box, 1 file drawer  
Y - hinged modesty panel  
X - includes a modesty panel  
1 - lateral file pedestal  
2 - 1 file, 2 box, 1 lateral file pedestal  
04 - 2 box, 1 file, 1 lateral file pedestal

**STANDARD FINISHES**

For a complete list of standard Laminates please see page 446.

**GROMMETS**

One grommet in standard position is optional at no charge. See page 494 for more power management information.



# ARTEMIS LAMINATE | CREDENZA

Description	Model	Laminate Top/Polymer Edge	HPL Top/Polymer Edge	W	D	H	KW	Shipping Weight	Cubic Feet
Double Pedestal Credenza with Hinged Laminate Modesty Panel	72CY60204LDRD	2665	2972	59.75	20	29.5	28.5	220	27.75
	72CY60204LDRF	2665	2972	59.75	20	29.5	28.5	220	27.75
	72CY60204LFRD	2665	2972	59.75	20	29.5	28.5	220	27.75
	72CY60204LFRF	2665	2972	59.75	20	29.5	28.5	220	27.75
	72CY60244LDRD	2822	3146	59.75	24	29.5	28.5	220	32
	72CY60244LDRF	2822	3146	59.75	24	29.5	28.5	220	32
	72CY60244LFRD*	2822	3146	59.75	24	29.5	28.5	220	32
	72CY60244LFRF	2822	3146	59.75	24	29.5	28.5	220	32
	72CY66204LDRD	2713	3025	65.75	20	29.5	34.5	228	30
	72CY66204LDRF	2713	3025	65.75	20	29.5	34.5	228	30
	72CY66204LFRD	2713	3025	65.75	20	29.5	34.5	228	30
	72CY66204LFRF	2713	3025	65.75	20	29.5	34.5	228	30
	72CY66244LDRD	2845	3172	65.75	24	29.5	34.5	228	35
	72CY66244LDRF	2845	3172	65.75	24	29.5	34.5	228	35
	72CY66244LFRD	2845	3172	65.75	24	29.5	34.5	228	35
	72CY66244LFRF	2845	3172	65.75	24	29.5	34.5	228	35
	72CY72204LDRD	2734	3047	71.75	20	29.5	40.5	228	32.75
	72CY72204LDRF	2734	3047	71.75	20	29.5	40.5	228	32.75
	72CY72204LFRD	2734	3047	71.75	20	29.5	40.5	228	32.75
	72CY72204LFRF	2734	3047	71.75	20	29.5	40.5	228	32.75
	72CY72244LDRD	2898	3235	71.75	24	29.5	40.5	236	38
	72CY72244LDRF	2898	3235	71.75	24	29.5	40.5	236	38
	72CY72244LFRD	2898	3235	71.75	24	29.5	40.5	236	38
	72CY72244LFRF	2898	3235	71.75	24	29.5	40.5	236	38
	72CY78204LDRD	2962	3303	77.75	20	29.5	46.5	234	35.5
	72CY78204LDRF	2962	3303	77.75	20	29.5	46.5	234	35.5
	72CY78204LFRD	2962	3303	77.75	20	29.5	46.5	234	35.5
	72CY78204LFRF	2962	3303	77.75	20	29.5	46.5	234	35.5
	72CY78244LDRD	3142	3508	77.75	24	29.5	46.5	242	41
	72CY78244LDRF	3142	3508	77.75	24	29.5	46.5	242	41
	72CY78244LFRD	3142	3508	77.75	24	29.5	46.5	242	41
	72CY78244LFRF	3142	3508	77.75	24	29.5	46.5	242	41
	72CY84204LDRD	3215	3587	83.75	20	29.5	52.5	240	38
	72CY84204LDRF	3215	3587	83.75	20	29.5	52.5	240	38
	72CY84204LFRD	3215	3587	83.75	20	29.5	52.5	240	38
	72CY84204LFRF	3215	3587	83.75	20	29.5	52.5	240	38
	72CY84244LDRD	3412	3806	83.75	24	29.5	52.5	248	44
	72CY84244LDRF	3412	3806	83.75	24	29.5	52.5	248	44
	72CY84244LFRD	3412	3806	83.75	24	29.5	52.5	248	44
	72CY84244LFRF	3412	3806	83.75	24	29.5	52.5	248	44

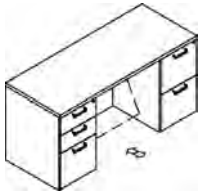

## ORDERING PROCEDURE

To order, please specify the following:

- 1) Krug product model number
- 2) Laminate, see page 446
- 3) Edge detail- I,H, L or P, see page 448
- 4) Pull style, see page 449
- 5) Grommet location if applicable

\*Indicates model illustrated by line drawing.

## CODE DESCRIPTION

L - left hand pedestal position  
 R - right hand pedestal position  
 0 - no pedestal  
 4 - full height pedestal  
 B - bookcase  
 D - 2 file drawer  
 F - 2 box, 1 file drawer  
 Y - hinged modesty panel  
 X - includes a modesty panel  
 1 - lateral file pedestal  
 2 - 1 file, 2 box, 1 lateral file pedestal  
 04 - 2 box, 1 file, 1 lateral file pedestal

## STANDARD LAMINATES

For a complete list of standard laminates please see page 446.

## GROMMETS

One grommet in standard position is optional at no charge. See page 494 for more power management information.

# ARTEMIS LAMINATE | CREDENZA

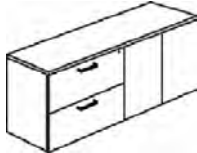
Description	Model	Laminate Top/Polymer Edge	HPL Top/Polymer Edge	W	D	H	KW	Shipping Weight	Cubic Feet
	72C7220LFRF	3105	3431	71.75	20	29.5		248	32.75
	72C7220LBRB	2346	2593	71.75	20	29.5		208	32.75
	72C7220LBRF	2726	3013	71.75	20	29.5		228	32.75
	72C7220LFRB*	2726	3013	71.75	20	29.5		228	32.75
	72C7224LFRF	3255	3596	71.75	24	29.5		256	38
	72C7224LBRB	2495	2757	71.75	24	29.5		224	38
	72C7224LBRF	2878	3180	71.75	24	29.5		236	38
	72C7224LFRB	2878	3180	71.75	24	29.5		236	38

**ORDERING NOTES:**

Credenzas with bookcase pedestals have the option of pulls instead of the standard touch latch doors. To select this option, please change the prefix in the model number from "72" to "73" ie: 73C7220XLBR0. Please refer to page 449 for pull orientation below the worksurface. Locks are available on wood doors for an **upcharge of \$152 list.**

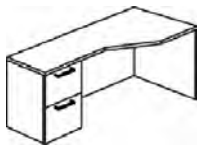
	72CC7224XL4D*	2398	2928	71.75	24	29.5	32	192	38
	72CC7224XL4F	2398	2928	71.75	24	29.5	32	192	38
	72CC7224XR4D	2398	2928	71.75	24	29.5	32	192	38
	72CC7224XR4F	2398	2928	71.75	24	29.5	32	192	38
	72CC7824XL4D	2614	3192	77.75	24	29.5	38	200	41
	72CC7824XL4F	2614	3192	77.75	24	29.5	38	200	41
	72CC7824XR4D	2614	3192	77.75	24	29.5	38	200	41
	72CC7824XR4F	2614	3192	77.75	24	29.5	38	200	41
	72CC8424XL4D	2852	3453	83.75	24	29.5	44	208	44
	72CC8424XL4F	2852	3453	83.75	24	29.5	44	208	44
	72CC8424XR4D	2852	3453	83.75	24	29.5	44	208	44
	72CC8424XR4F	2852	3453	83.75	24	29.5	44	208	44

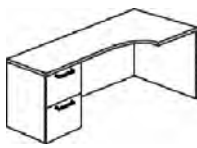
	72CCC7224XL4D	2398	2928	71.75	24	29.5	32	192	38
	72CCC7224XL4F*	2398	2928	71.75	24	29.5	32	192	38
	72CCC7224XR4D	2398	2928	71.75	24	29.5	32	192	38
	72CCC7224XR4F	2398	2928	71.75	24	29.5	32	192	38
	72CCC7824XL4D	2614	3192	77.75	24	29.5	38	200	41
	72CCC7824XL4F	2614	3192	77.75	24	29.5	38	200	41
	72CCC7824XR4D	2614	3192	77.75	24	29.5	38	200	41
	72CCC7824XR4F	2614	3192	77.75	24	29.5	38	200	41
	72CCC8424XL4D	2852	3453	83.75	24	29.5	44	208	44
	72CCC8424XL4F	2852	3453	83.75	24	29.5	44	208	44
	72CCC8424XR4D	2852	3453	83.75	24	29.5	44	208	44
	72CCC8424XR4F	2852	3453	83.75	24	29.5	44	208	44

**ORDERING NOTES:**

Please note, these curved corner credenzas are not compatible with curved corner desks.

**DIMENSION KEY**

W - width  
D - depth  
H - height

Dimensions are in inches and approximate. Contact Customer Service if dimensions are critical.

**CODE DESCRIPTION**

L - left hand pedestal position  
R - right hand pedestal position  
0 - no pedestal  
4 - full height pedestal  
B - bookcase  
D - 2 file drawer  
F - 2 box, 1 file drawer  
Y - hinged modesty panel  
X - includes a modesty panel  
1 - lateral file pedestal  
2 - 1 file, 2 box, 1 lateral file pedestal  
04 - 2 box, 1 file, 1 lateral file pedestal

**STANDARD LAMINATES**

For a complete list of standard Laminates please see page 446.

**GROMMETS**

One grommet in standard position is optional at no charge. See page 494 for more power management information.

# ARTEMIS LAMINATE | OVERHEADS & TACKBOARDS

Description	Model	Laminate	W	D	H	Doors	Shipping Weight	Cubic Feet
Single Wall Mounted Overhead with Laminate Doors	72OHW361616	997	35.75	16	16	2	64	7
	72OHW421616	1093	41.75	16	16	2	71	8.5
	72OHW481616*	1206	47.75	16	16	3	82	9
	72OHW601616	1409	59.75	16	16	4	96	11.5
	72OHW661616	1488	65.75	16	16	4	102	12.75
	72OHW721616	1563	71.75	16	16	4	109	13.75



Single Wall Mounted Overhead with Frosted Glass Doors	72OHW361616X	1484	35.75	16	16		64	7
	72OHW421616X*	1631	41.75	16	16		71	8.5
	72OHW481616X	1836	47.75	16	16		82	9
	72OHW601616X	2202	59.75	16	16		96	11.5
	72OHW661616X	2287	65.75	16	16		102	12.75
	72OHW721616X	2406	71.75	16	16		109	13.75

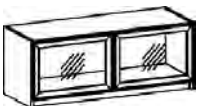

Double Wall Mounted Overhead with Laminate Doors	72OHW361630	1295	35.75	16	29.5	2	100	12
	72OHW421630	1420	41.75	16	29.5	2	112	14.5
	72OHW481630*	1568	47.75	16	29.5	3	130	16

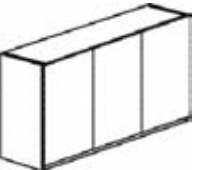

Double Wall Mounted Overhead with Frosted Glass Doors	72OHW361630X	2014	35.75	16	29.5		100	12
	72OHW421630X*	2239	41.75	16	29.5		112	14.5
	72OHW481630X	2489	47.75	16	29.5		130	16



## ORDERING PROCEDURE

To order, please specify the following:

- 1) Krug product model number
- 2) Laminate, see page 446
- 3) Edge detail- I, H, L or P, see page 448
- 4) Pull style, see page 449
- 5) Grommet location if applicable

\*Indicates model illustrated by line drawing.

## CODE DESCRIPTION

X- Silver Metallic framed frosted glass doors

## STANDARD LAMINATES

For a complete list of standard laminates please see page 446.

## GROMMETS

One grommet in standard position is optional at no charge. See page 494 for more power management information.

# ARTEMIS LAMINATE | TACKBOARDS

## FABRIC GRADES

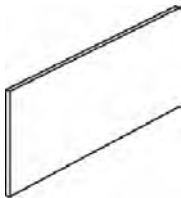
Description	Model	1	2	3	4	5	6	7	8	9	W	H	COM	WT
Wall Mounted Tackboard for Overheads 	72TBOHW3624	302	420	446	561	680	791	912	1058	1252	35.75	24	1.5	1.75
	72TBOHW4224	337	454	480	596	716	824	948	1090	1286	35.75	24	1.5	2.25
	72TBOHW4824*	376	465	487	613	733	840	971	1117	1341	47.75	24	1.75	2.25
	72TBOHW6024	426	568	596	648	764	1058	1222	1387	1647	59.75	24	2	3
	72TBOHW6624	465	634	677	827	989	1178	1338	1529	1821	65.75	24	2	3.25
	72TBOHW7224	512	783	816	1084	1332	1348	1547	1767	2058	71.75	24	2.25	3.5

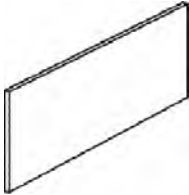
Wall Mounted Tackboard for Overhead Mounted 6" Higher than 5 Hi Storage 	72TBOHW3630	379	422	464	531	691	844	995	1158	1360	35.75	30	1.5	2.25
	72TBOHW4230	422	567	599	744	895	1032	1181	1394	1609	30	1.5	2.5	42.75
	72TBOHW4830*	470	583	610	765	917	1053	1212	1394	1677	30	1.75	3	47.75
	72TBOHW6030	533	710	744	928	1116	1318	1528	1734	2061	30	2	3.5	59.75
	72TBOHW6630	583	793	848	661	1240	1474	1672	1913	2279	65.75	30	2	4
	72TBOHW7230	640	981	1021	1355	1664	1686	1934	2206	2570	71.75	30	2.25	4.5

**DIMENSION KEY**

- W - width
- D - depth
- H - height

Dimensions are in inches and approximate.  
 Contact Customer Service if dimensions are critical.

# ARTEMIS LAMINATE | HUTCHES

Description	Model	Laminate	W	D	H	KW	Shipping Weight	Cubic Feet
5 Hi Hutch with Laminate Doors	72HT661640	2476	65.75	15.75	39.5	23.5	181	28.5
	72HT721640	2576	71.75	15.75	39.5	23.5	193	31
	72HT781640*	2739	77.75	15.75	39.5	23.5	206	33.5
	72HT841640	2957	83.75	15.75	39.5	23.5	219	36



5 Hi Hutch with Frosted Glass Doors	72HT721640X	3381	71.75	15.75	39.5	23.5	193	31
	72HT781640X*	3708	77.75	15.75	39.5	23.5	208	33.5
	72HT841640X	4088	83.75	15.75	39.5	23.5	219	36

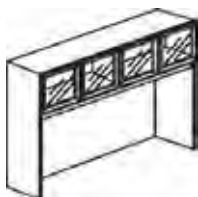

5 Hi Hutch with Laminate Doors and Paper Manager	72HTPM661640	2720	65.75	15.75	39.5	20.25	199	28.5
	72HTPM721640	2848	71.75	15.75	39.5	20.25	214	31
	72HTPM781640*	3059	77.75	15.75	39.5	20.25	228	33.5
	72HTPM841640	3316	83.75	15.75	39.5	20.25	242	36



5 Hi Hutch with Frosted Glass Doors and Paper Manager	72HTPM661640X	3589	65.75	15.75	39.5	20.25	199	28.5
	72HTPM721640X	3718	71.75	15.75	39.5	20.25	214	31
	72HTPM781640X*	4095	77.75	15.75	39.5	20.25	228	33.5
	72HTPM841640X	4515	83.75	15.75	39.5	20.25	242	36

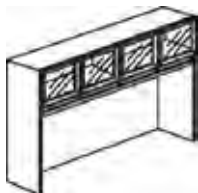

## ORDERING NOTES:

Tasklights and fabric grade 1 tackboards come standard with all hutches. To specify a Power/Data/Voice module with any hutch, please add a "W" at the end of the model number and a **\$252 list upcharge**. Pier hutches have and option of a pull on the pier door only. To select this option, change the model number from "72" to "73"; e.g. 73HTPR841640L11OHXR0.

## ORDERING PROCEDURE

To order, please specify the following:

- 1) Krug product model number
- 2) Laminate, see page 446
- 3) Edge detail- I,H, L or P, see page 448
- 4) Pull style, see page 449
- 5) Grommet location if applicable

\*Indicates model illustrated by line drawing.

## CODE DESCRIPTION

X - Silver Metallic framed frosted glass doors  
 L - left handed position  
 R - right handed position  
 0 - no pier  
 11 - closed door Laminate pier  
 PM - paper manager

## STANDARD LAMINATES

For a complete list of standard laminates please see page 446.

## GROMMETS

One grommet in standard position is optional at no charge. See page 494 for more power management information.

# ARTEMIS LAMINATE | HUTCHES

DESCRIPTION	MODEL	Laminate	W	D	H	KW	Shipping	
							Weight	Cubes
5 Hi Hutch with Laminate Doors and Single Pier 	72HTPR721640L11OHR0	2928	71.75	15.75	39.5	23.5	215	31
	72HTPR721640L0OHR11	2928	71.75	15.75	39.5	23.5	215	31
	72HTPR781640L11OHR0*	3102	77.75	15.75	39.5	23.5	233	33.5
	72HTPR781640L0OHR11	3102	77.75	15.75	39.5	23.5	233	33.5
	72HTPR841640L11OHR0	3353	83.75	15.75	39.5	23.5	251	36
	72HTPR841640L0OHR11	3353	83.75	15.75	39.5	23.5	251	36

5 Hi Hutch with Frosted Glass Doors and Single Pier 	72HTPR721640L11OHXR0	3797	71.75	15.75	39.5	23.5	215	31
	72HTPR721640L0OHXR11	3797	71.75	15.75	39.5	23.5	215	31
	72HTPR781640L11OHXR0*	4138	77.75	15.75	39.5	23.5	233	33.5
	72HTPR781640L0OHXR11	4138	77.75	15.75	39.5	23.5	233	33.5
	72HTPR841640L11OHXR0	4553	83.75	15.75	39.5	23.5	251	36
	72HTPR841640L0OHXR11	4553	83.75	15.75	39.5	23.5	251	36

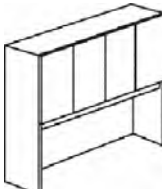
6 Hi Hutch with Laminate Doors 	72HT661653	2659	65.75	15.75	53	23.5	250	37.75
	72HT721653	2790	71.75	15.75	53	23.5	268	41
	72HT781653*	2954	77.75	15.75	53	23.5	287	44.5
	72HT841653	3192	83.75	15.75	53	23.5	305	47.75

6 Hi Hutch with Frosted Glass Doors 	72HT661653X	3685	65.75	15.75	53	23.5	250	37.75
	72HT721653X	3822	71.75	15.75	53	23.5	268	41
	72HT781653X*	4197	77.75	15.75	53	23.5	287	44.5
	72HT841653X	4649	83.75	15.75	53	23.5	305	47.75

**ORDERING NOTES:**

Tasklights and fabric grade 1 tackboards come standard with all hutches. To specify a Power/Data/Voice module with any hutch, please add a "W" at the end of the model number and a **\$252 list upcharge**. Pier hutches have and option of a pull on the pier door only. To select this option, change the model number from "72" to "73"; e.g. 73HTPR841640L11OHXR0.

**DIMENSION KEY**

W - width  
 D - depth  
 H - height

Dimensions are in inches and approximate. Contact Customer Service if dimensions are critical.

**CODE DESCRIPTION**

X - Silver Metallic framed frosted glass doors  
 L - left handed position  
 R - right handed position  
 0 - no pier  
 11 - closed door Laminate pier  
 PM - paper manager

**STANDARD LAMINATES**

For a complete list of standard Laminates please see page 446.

# ARTEMIS LAMINATE | HUTCHES

Description	Model	Laminate	W	D	H	KW	Shipping Weight	Cubic Feet
6 Hi Hutch with Laminate Doors and Paper Manager	72HTPM661653	2904	65.75	15.75	53	20.25	269	37.75
	72HTPM721653	3062	71.75	15.75	53	20.25	289	41
	72HTPM781653*	3277	77.75	15.75	53	20.25	298	44.5
	72HTPM841653	3553	83.75	15.75	53	20.25	328	47.75



6 Hi Hutch with Frosted Glass Doors and Paper Manager	72HTPM661653X	3996	65.75	15.75	53	20.25	269	37.75
	72HTPM721653X	4161	71.75	15.75	53	20.25	289	41
	72HTPM781653X*	4586	77.75	15.75	53	20.25	298	44.5
	72HTPM841653X	5080	83.75	15.75	53	20.25	328	47.75

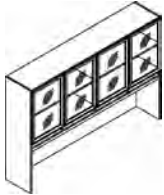

6 Hi Hutch with Laminate Doors and Single Pier	72HTPR721653L11OHR0	3197	71.75	15.75	53	23.5	294	41
	72HTPR721653L0OHR11	3197	71.75	15.75	53	20.25	294	41
	72HTPR781653L11OHR0*	3371	77.75	15.75	53	23.5	303	44.5
	72HTPR781653L0OHR11	3371	77.75	15.75	53	20.25	303	44.5
	72HTPR841653L11OHR0	3648	83.75	15.75	53	23.5	312	47.75
	72HTPR841653L0OHR11	3648	83.75	15.75	53	20.25	312	47.75

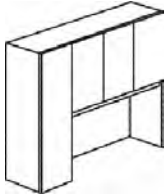

6 Hi Hutch with Frosted Glass Doors and Single Pier	72HTPR721653L11OHXR0	4295	71.75	15.75	53	23.5	294	41
	72HTPR721653L0OHXR11	4295	71.75	15.75	53	23.5	294	41
	72HTPR781653L11OHXR0*	4683	77.75	15.75	53	23.5	303	44.5
	72HTPR781653L0OHXR11	4683	77.75	15.75	53	23.5	303	44.5
	72HTPR841653L11OHXR0	5176	83.75	15.75	53	20.25	312	47.75
	72HTPR841653L0OHXR11	5176	83.75	15.75	53	23.5	312	47.75

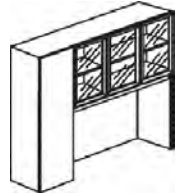

## ORDERING NOTES:

Tasklights and fabric grade 1 tackboards come standard with all hutches. To specify a Power/Data/Voice module with any hutch, please add a "W" at the end of the model number and a **\$252 list upcharge**. Pier hutches have and option of a pull on the pier door only. To select this option, change the model number from "72" to "73"; e.g. 73HTPR841640L11OHXR0.

### DIMENSION KEY

W - width  
D - depth  
H - height

Dimensions are in inches and approximate. Contact Customer Service if dimensions are critical.

### CODE DESCRIPTION

X - Silver Metallic framed frosted glass doors  
L - left handed position  
R - right handed position  
0 - no pier  
11 - closed door Laminate pier  
PM - paper manager

### STANDARD LAMINATES

For a complete list of standard Laminates please see page 446.

# ARTEMIS LAMINATE | HUTCH TACKBOARD CHART & PAPER MANAGER

Description	Model	Fabric Grades								COM
		2	3	4	5	6	7	8	9	
Tackboard	66" hutch	172	374	547	732	912	1084	1260	1562	2
Upcharges for Standard Hutches	72" hutch	199	426	622	837	1036	1236	1437	1727	2.25
	78" hutch*	234	500	735	974	1206	1443	1677	2002	2.5
	84" hutch	278	580	857	1136	1414	1690	1965	2322	2.5
	72" single pier hutch	149	315	460	615	764	910	1059	1285	1.5
	78" single pier hutch	157	337	492	658	816	973	1127	1387	1.75
	84" single pier hutch	164	357	521	697	869	1032	1199	1414	2

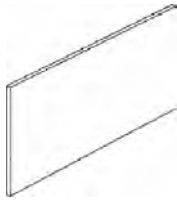

**ORDERING NOTES:**

All hutches include a tackboard in Krug panel grade 1 fabric. Use this chart to find the upcharge for tackboard fabrics grades 2-9 and add it to the cost of the hutch. Only Krug panel fabrics are available on KrugExpress.

Description	Model	Laminate	W	D	H	Shipping Weight	Cubic Feet
Paper Manager with Open Shelves	72PM18122002	422	17	12.5	19.75	50	3
	72PM18122003*	443	17	12.5	19.75	50	3

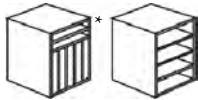

**DIMENSION KEY**

W - width  
D - depth  
H - height

Dimensions are in inches and approximate. Contact Customer Service if dimensions are critical.

**CODE DESCRIPTION**

X - Silver Metallic framed frosted glass doors  
L - left handed position  
R - right handed position  
0 - no pier  
11 - closed door Laminate pier  
PM - paper manager

**STANDARD LAMINATES**

For a complete list of standard Laminates please see page 446.

**GROMMETS**

One grommet in standard position is optional at no charge. See page 494 for more power management information.



# ARTEMIS LAMINATE | PEDESTALS

Description	Model	Laminate	W	D	H	Shipping Weight	Cubic Feet
Pedestal Desk	72P16184F*	1107	15.75	18.25	28.25	61	6.5
Height, 2 Box, 1 File with Unfinished Tops/Backs	72P16284F	1253	15.75	27.5	28.25	66	9



Pedestal Desk Height, 2 File	72P16184D	1093	15.75	18.25	28.25	61	6.5
	72P16284D*	1239	15.75	27.5	28.25	66	9



Pedestal, Lateral File with Unfinished Tops/Backs	72P301801*	1316	29.75	18.25	28.25	104	11.5
	72P361801	1522	35.75	18.25	28.25	112	13.5



Pedestal, 36" File/2 Box & Lateral File Combination	72P361802	1597	35.75	18.25	28.25	112	13.5
---	-----------	------	-------	-------	-------	-----	------



Pedestal, 36" File/2 Box & Lateral File Combination	72P361804	1597	35.75	18.25	28.25	112	13.5
---	-----------	------	-------	-------	-------	-----	------



## ORDERING PROCEDURE

To order, please specify the following:

- 1) Krug product model number
- 2) Laminate, see page 446
- 3) Edge detail- I,H, L or P, see page 448
- 4) Pull style, see page 449
- 5) Grommet location if applicable

\*Indicates model illustrated by line drawing.

## CODE DESCRIPTION

PM - paper manager  
 D - 2 file drawer  
 F - 2 box, 1 file drawer  
 01 - lateral file  
 02 - 1 file, 2 box, 1 lateral file pedestal  
 04 - 2 box, 1 file, 1 lateral file pedestal

## STANDARD LAMINATES

For a complete list of standard laminates please see page 446.

## GROMMETS

One grommet in standard position is optional at no charge. See page 494 for more power management information.

# ARTEMIS LAMINATE | ACCESSORIES

Description	Model	Price	W	D	H	Shipping Weight	Cubic Feet
Articulating Keyboard Tray with Palm Rest and Mouse Pad	72KBAMT1912	411	27	20	7	20	2



Articulating Keyboard Tray with Palm Rest and Mouse Pad with Spacer and Stiffener Bars	72KBAMT1912S	483	27	20	8	20	2
--	--------------	-----	----	----	---	----	---



**ORDERING NOTES:**

This Articulating Keyboard is required on any item that has a stiffener bar. See below for specific items and sizes that use stiffener bars. Note that the vertical knee clearance will be reduced by 1-1/8".

**CASES THAT USE STIFFENER BARS:**

- Arc, Bullet and J Desks -84" and up.
- Curved Corner Arc, Bullet and P Desks -84" and up.
- P Desks -90" and up.
- Arc, Bullet and J Returns -72" and up.
- Crescent Returns -78" and up.
- Desk Returns -54" and up.
- Table Desks -60" and up.

Articulating Keyboard Tray with Palm Rest and Mouse Pad for Angled & Curved Units	72KBAMT1912X	428	27	24	7	20	2
---	--------------	-----	----	----	---	----	---



**ORDERING NOTES:**

Must be used on the curved area or the angled edge on the Corner Desks or Corner Credenzas.

**DIMENSION KEY**

- W - width
- D - depth
- H - height

Dimensions are in inches and approximate. Contact Customer Service if dimensions are critical.

**CODE DESCRIPTION**

- KBAMT - keyboard drawer with mouse tray
- PD - pencil drawer
- X - extended mechanism
- S - spacer

**STANDARD LAMINATES**

For a complete list of standard Laminates please see page 446.

**GROMMETS**

One grommet in standard position is optional at no charge. See page 494 for more power management information.

# POWERPORTS

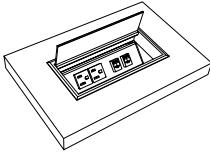
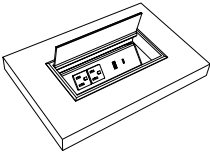
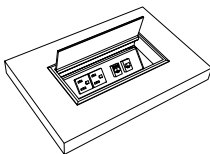
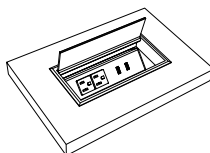
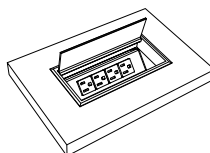
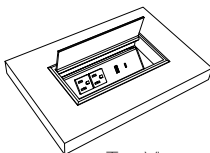
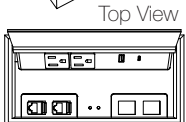
Description	Model	Price	W	D	H	Shipping Weight	Cubic Feet
PowerPort 1 - 2 RJ45s (Category 5/6)	PORT1	278	8	4	-	-	-
	<b>Port Includes:</b> 2 accessible power outlets & 1 side utility outlet powered by a 10' plug-in cord; 2 RJ45 (category 5/6) each with hard wired 10' data cords; 2 velcro wire managers and metal PowerPort shroud. PortPort lid is Silver Metallic. <b>NOTE:</b> RJ45 jacks with hard wired data cords included here must be within 10' of building utilities source to be functional.						
PowerPort 2 - USB-A & USB-C	PORT2	280	8	4	-	-	-
	<b>Port Includes:</b> 2 accessible power outlets & 1 side utility outlet; 1 USB-A & 1 USB-C charging ports all powered by a 10' plug-in cord; 2 velcro wire managers and metal PowerPort shroud. PortPort lid is Silver Metallic.						
PowerPort 3 - RJ11 & RJ45	PORT3	269	8	4	-	-	-
	<b>Port Includes:</b> 2 accessible power outlets & 1 side utility outlet; 1 RJ11 & 1 RJ45 (Category 5/6); 2 Velcro wire managers & PowerPort Shroud; 1 x 10 Foot Data Cords (T568A) & 1 x 14 Foot RJ11 (Telecomm); powered by a 10' plug-in cord. PortPort lid is Silver Metallic. <b>NOTE:</b> RJ45 & RJ11 jacks with hard wired data cords included here must be within 10' of building utilities source to be functional.						
PowerPort 4 - 2 USB-A	PORT4	286	8	4	-	-	-
	<b>Port Includes:</b> 2 accessible power outlets & 1 side utility outlet; 2- USB-A charging ports all powered by a 10' plug-in cord; 2 velcro wire managers and metal PortPort shroud. PortPort lid is Silver Metallic.						
PowerPort 5 - 4 Receptacles	PORT5	280	8	4	-	-	-
	<b>Port Includes:</b> 4 accessible power outlets & 1 side utility outlet powered by a 10' plug-in cord; 2 velcro wire managers and metal power port shroud. PortPort lid is Silver Metallic.						
PowerPort 6 - USB-A, USB-C & RJ45	PORT6	406	8	4	-	-	-
 	<b>Port Includes:</b> 2 accessible power outlets & 1 side utility outlet 1 USB-A, 1 USB-C charging ports all powered by a 10' plug-in power cord. Includes 2 velcro wire managers and metal PortPort shroud with 2 data plate knock outs, 1 #M02 plate insert & 2 #S01W RJ45 female input, punch down terminal output snap in jacks. 2nd data plate knock out is blank for future use. PortPort lid is Silver Metallic.						

# POWERPORTS

Description	Model	Price	W	D	H	Shipping Weight	Cubic Feet
Port - no Powerbar	Port0	137	8	4	-	-	-

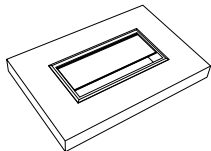

**Port Includes:** Port lid & Shroud only.

**ORDERING NOTE:** Velcro wire managers not included, see below for pricing. Port lid is Silver Metallic.

PowerPort Shroud with 2 Data Plate Knock-outs	SHROUD2KO	Must be requested - no upcharge	-	-	-	-	-
---	-----------	------------------------------------	---	---	---	---	---

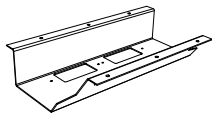

Angled PowerPort Shroud Includes: shroud with 2 data plate knock-outs in the bottom.

**ORDERING NOTE:** Please refer to data plate, data and AV integration options on page XX.

Velcro Wire Manager (qty 1)	WM-4	26	2	4.5	0.5	-	-
-----------------------------	------	----	---	-----	-----	---	---

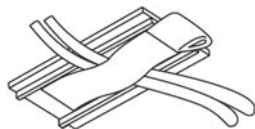

2 velcro wire managers are included with Ports 1-5.

Wire Management Trough	WM-72	182	72	3	1	-	-
------------------------	-------	-----	----	---	---	---	---



Wire Management Trough is standard in a 72" length & can be cut to specific length; double-sided tape installation.

4-Channel Wire Management	CM-72	231	72	3	1	-	-
---------------------------	-------	-----	----	---	---	---	---

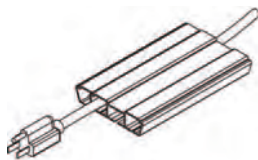



4-Channel Wire Management is standard in a 72" length & can be cut to specific length; double-sided tape installation.

Round Grommet	Round Grommet - Silver Metallic	152	-	-	-	-	-
	Round Grommet - Black	152	-	-	-	-	-

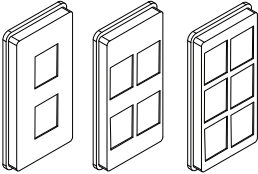

One 60mm Grommet in a standard position is available at no charge per table.

# POWER/DATA

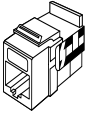
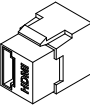
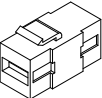
SNAP IN PORTS	Reference Code	Description	List Price
<b>ADAPTOR PLATES</b>			
	<b>M02</b>	<b>Adaptor Plate (2)</b> - accepts two snap in data ports	38
	<b>M04</b>	<b>Adaptor Plate (4)</b> - accepts four snap in data ports	38
	<b>M06</b>	<b>Adaptor Plate (6)</b> - accepts six snap in data ports	38
<b>ORDERING NOTES:</b> Blank covers are required when port is not in use, please see page 55.			
		<b>RJ-45</b> - Category 6 data connection. This connector is also downwards compatible with Category 5 cabling. Connector is a female input with a #110 punch-down terminal block output (back side of Console interface) for on-site hard wire connection.	47
	<b>S01W</b>	RJ45-CAT6 (White)	
	<b>S01B</b>	RJ45-CAT6 (Blue)	
	<b>S01R</b>	RJ45-CAT6 (Red)	
		<b>RJ11</b> - Telephone type connection. Connector is a female input with a #110 punch-down terminal block output (back side of Console interface) for on-site hard wire connection.	32
	<b>S02W</b>	RJ11 (White)	
	<b>S02B</b>	RJ11-B (Black)	
	<b>S02G</b>	RJ11-G (Green)	
	<b>S02R</b>	RJ11-R (Red)	
	<b>S02Y</b>	RJ11-Y (Yellow)	
	<b>S04</b>	<b>HDMI</b> - High Definition Multimedia Interface connection. Connector carries both HD audio and video data. Connector is a female-to-female pass through.	173
	<b>S08</b>	<b>USB-A</b> - Full size USB "A" style connection. Connector is a female-to-female pass through.	61

# ARTEMIS LAMINATE | ACCESSORIES & POWER/ DATA

Description	Model	Price	W	D	H	Shipping Weight	Cubic Feet
Pencil Drawer	72PD2119	295	21	21	2	2	1

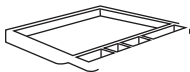

**ORDERING NOTES:**

Pencil drawer is black in color.

Pencil Drawer with Spacer	72PD2119S	331	21	21	3	2	1
---------------------------	-----------	-----	----	----	---	---	---

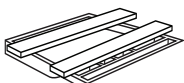

**ORDERING NOTES:**

This pencil drawer is required on any item that has a stiffener bar.

Power Data Module	72PDVM	226
-------------------	--------	-----



**ORDERING PROCEDURE**

To order, please specify the following:

- 1) Krug product model number
- 2) Laminate, see page 446
- 3) Edge detail- I,H, L or P, see page 448
- 4) Pull style, see page 449
- 5) Grommet location if applicable

\*Indicates model illustrated by line drawing.

**CODE DESCRIPTION**

KBAMT - keyboard drawer with mouse tray  
 PD - pencil drawer  
 X - extended mechanism  
 S - spacer

**STANDARD LAMINATES**

For a complete list of standard laminates please see page 446.

**GROMMETS**

One grommet in standard position is optional at no charge. See page 494 for more power management information.

# ARTEMIS LAMINATE | BOOKCASES

Description	Model	Laminate	W	D	H	Shipping Weight	Cubic Feet
2 Hi Bookcase Open Shelves	72BC301629*	898	29.75	15.75	29.5	48	10
	72BC361629	1074	35.75	15.75	29.5	56	12



4 Hi Bookcase Open Shelves	72BC301655*	1303	29.75	15.75	55.25	64	18.25
	72BC361655	1452	35.75	15.75	55.25	72	21.75

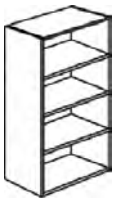

5 Hi Bookcase Open Shelves	72BC301669*	1360	29.75	15.75	69	100	22.75
	72BC361669	1509	35.75	15.75	69	112	27

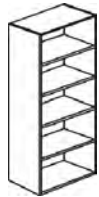

## ORDERING PROCEDURE

To order, please specify the following:

- 1) Krug product model number
- 2) Laminate, see page 446
- 3) Edge detail- I,H, L or P, see page 448
- 4) Pull style, see page 449
- 5) Grommet location if applicable

\*Indicates model illustrated by line drawing.

## CODE DESCRIPTION

ST - storage unit  
 BC - bookcase  
 WR - wardrobe  
 L - door hinged left  
 R - door hinged right  
 X - Silver Metallic framed frosted glass doors

## STANDARD LAMINATES

For a complete list of standard laminates please see page 446.

## GROMMETS

One grommet in standard position is optional at no charge. See page 494 for more power management information.

# ARTEMIS LAMINATE | STORAGE

Description	Model	Laminate Top/Polymer Edge	HPL Top/Polymer Edge	W	D	H	Shipping Weight	Cubic Feet
2 Hi Storage Unit	72ST36202911	1425	1567	35.75	20	29.5	104	14.75
Closed Bookcase	72ST36242911*	1497	1645	35.75	24	29.5	108	17.5

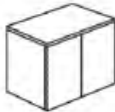

2 Hi Storage Unit	72ST36202901	2072	2279	35.75	20	29.5	116	14.75
Lateral File	72ST36242901*	2143	2356	35.75	24	29.5	120	17.5



4 Hi Storage Unit	72ST36205501	3042		35.75	20	55.25	176	27
Lateral File	72ST36245501*	3215		35.75	24	55.25	196	32



5 Hi Storage Unit	72ST19246911L	1620		18.75	24	69	132	21.75
Closed Shelves	72ST19246911R*	1620		18.75	24	69	132	21.75



5 Hi Storage Unit 2	72ST19246990	1861		18.75	24	69	132	21.75
File, 3 Open Shelves								



**ORDERING NOTES:**

Storage Units have the option of pulls instead of the standard touch latch doors. To select this option, please change the prefix in the model number from "72" to "73" ie: 73ST19246991L. Please refer to page 494 for pull orientation above and below the worksurface height. Locks are available on Laminate doors for an **upcharge of \$152 list.**

**DIMENSION KEY**

W - width  
D - depth  
H - height

Dimensions are in inches and approximate. Contact Customer Service if dimensions are critical.

**CODE DESCRIPTION**

ST - storage unit  
BC - bookcase  
WR - wardrobe  
L - door hinged left  
R - door hinged right  
X - Silver Metallic framed frosted glass doors

**STANDARD LAMINATES**

For a complete list of standard Laminates please see page 446.



# ARTEMIS LAMINATE | STORAGE

Description	Model	Laminate	W	D	H	Shipping Weight	Cubic Feet
5 Hi Storage Unit 2 File, 3 Closed Shelves	72ST19246991L 72ST19246991R*	2060 2060	18.75 18.75	24 24	69 69	132 132	21.75 21.75



5 Hi Storage Unit 2 Lateral File, 3 Open Shelves	72ST36246903* 72ST36206903	2673 2359	35.75 35.75	24 20	69 69	188 180	39.75 33.5
--	-------------------------------	--------------	----------------	----------	----------	------------	---------------

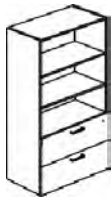

5 Hi Storage Unit 2 Lateral File, 3 Closed Shelves	72ST36206904* 72ST36246904	2591 2908	35.75 35.75	20 24	69 69	192 200	33.5 39.75
--	-------------------------------	--------------	----------------	----------	----------	------------	---------------

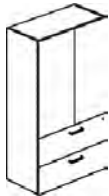

### ORDERING NOTES:

Storage Units have the option of pulls instead of the standard touch latch doors. To select this option, please change the prefix in the model number from "72" to "73" ie: 73ST19246991L. Please refer to page 449 for pull orientation above and below the worksurface height. Locks are available on Laminate doors for an **upcharge of \$152 list.**

### BOOKCASES:

Shelves are adjustable in 1.25" increments.

5 Hi Storage Unit 2 Lateral File, 3 Closed Shelves with Frosted Glass Doors	72ST36206904X* 72ST36246904X	3606 3919	35.75 35.75	20 24	69 69	192 200	33.5 39.75
--	---------------------------------	--------------	----------------	----------	----------	------------	---------------



### ORDERING NOTES:

Please note that glass doors are not available with the pull option or lock option.

### ORDERING PROCEDURE

To order, please specify the following:

- 1) Krug product model number
- 2) Laminate, see page 446
- 3) Edge detail- I,H, L or P, see page 448
- 4) Pull style, see page 449
- 5) Grommet location if applicable

\*Indicates model illustrated by line drawing.

### CODE DESCRIPTION

ST - storage unit  
 BC - bookcase  
 WR - wardrobe  
 L - door hinged left  
 R - door hinged right  
 X - Silver Metallic framed frosted glass doors

### STANDARD LAMINATES

For a complete list of standard laminates please see page 446.

# ARTEMIS LAMINATE | STORAGE

Description	Model	Laminate	W	D	H	Shipping Weight	Cubic Feet
5 Hi Storage Unit 2 Closed, 3 Open Shelves	72ST36206913	1980	35.75	20	69	104	33.5
	72ST36246913*	2294	35.75	24	69	116	39.75

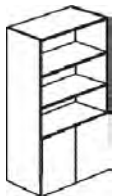

5 Hi Storage Unit 3 Lateral File, 2 Closed Shelves	72ST36246908	3363	35.75	24	69	192	39.75
--	--------------	------	-------	----	----	-----	-------

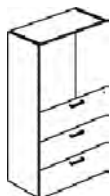

6 Hi Storage Unit Closed Shelves	72ST19248311L	1703	18.75	24	82.75	160	26
	72ST19248311R*	1703	18.75	24	82.75	160	26

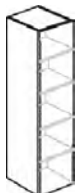

**ORDERING NOTES:**

Storage Units have the option of pulls instead of the standard touch latch doors. To select this option, please change the prefix in the model number from "72" to "73" ie: 73ST19246991L. Please refer to page 449 for pull orientation above and below the worksurface height. Locks are available on Laminate doors for an **upcharge of \$152 list**.

DIMENSION KEY	CODE DESCRIPTION	STANDARD FINISHES
W - width D - depth H - height  Dimensions are in inches and approximate. Contact Customer Service if dimensions are critical.	ST - storage unit BC - bookcase WR - wardrobe L - door hinged left R - door hinged right X - Silver Metallic framed frosted glass doors	For a complete list of standard Laminates & HPL, please see page 446.

# ARTEMIS LAMINATE | STORAGE

Description	Model	Laminate	W	D	H	Shipping Weight	Cubic Feet
6 Hi Storage Unit 2 File, 4 Open Shelves	72ST19248390	1944	18.75	24	82.75	160	26

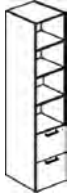

6 Hi Storage Unit	72ST19248391L	2143	18.75	24	82.75	160	26
2 File, 4 Closed Shelves	72ST19248391R*	2143	18.75	24	82.75	160	26



6 Hi Storage Unit	72ST36208303*	2460	35.75	20	82.75	216	40
2 Lateral File, 4 Open Shelves	72ST36248303	2780	35.75	24	82.75	224	47.5

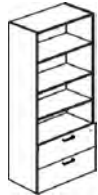

6 Hi Storage Unit	72ST36208304*	2734	35.75	20	82.75	220	40
2 Lateral File, 4 Closed Shelves	72ST36248304	3014	35.75	24	82.75	228	47.5



## ORDERING NOTES:

Storage Units have the option of pulls instead of the standard touch latch doors. To select this option, please change the prefix in the model number from "72" to "73" ie: 73ST19246991L. Please refer to page 449 for pull orientation above and below the worksurface height. Locks are available on Laminate doors for an **upcharge of \$152 list.**

### ORDERING PROCEDURE

To order, please specify the following:

- 1) Krug product model number
- 2) Laminate, see page 446
- 3) Edge detail, L, R or P, see page 448
- 4) Pull style, see page 449
- 5) Grommet location if applicable

### CODE DESCRIPTION

ST - storage unit  
 BC - bookcase  
 WR - wardrobe  
 L - door hinged left  
 R - door hinged right  
 X - Silver Metallic framed frosted glass doors

### STANDARD LAMINATES

For a complete list of standard laminates please see page 446.

# ARTEMIS LAMINATE | STORAGE

Description	Model	Laminate	W	D	H	Shipping Weight	Cubic Feet
6 Hi Storage Unit 2 Lateral File, 4 Closed Shelves with Frosted Glass Doors	72ST36208304X*	3847	35.75	20	82.75	220	40
	72ST36248304X	4169	35.75	24	82.75	228	40



**ORDERING NOTES:**

Please note that glass doors are not available with the pull option or lock option.

6 Hi Storage Unit 2 Closed, 4 Open Shelves	72ST36208313*	2080	35.75	20	82.75	200	40
	72ST36248313	2401	35.75	24	82.75	208	40

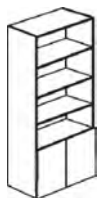

**ORDERING NOTES:**

Storage Units have the option of pulls instead of the standard touch latch doors. To select this option, please change the prefix in the model number from "72" to "73" ie: 73ST19246991L. Please refer to page 449 for pull orientation above and below the worksurface height. Locks are available on Laminate doors for an **upcharge of \$152 list.**

6 Hi Storage Unit 3 Lateral File, 3 Closed Shelves	72ST36248308	3471	35.75	24	82.75	220	40
---	--------------	------	-------	----	-------	-----	----

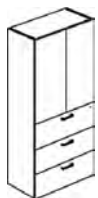

**ORDERING NOTES:**

Storage Units have the option of pulls instead of the standard touch latch doors. To select this option, please change the prefix in the model number from "72" to "73" ie: 73ST19246991L. Please refer to page 449 for pull orientation above and below the worksurface height. Locks are available on Laminate doors for an **upcharge of \$152 list.**

**DIMENSION KEY**

W - width  
D - depth  
H - height

Dimensions are in inches and approximate. Contact Customer Service if dimensions are critical.

**CODE DESCRIPTION**

ST - storage unit  
BC - bookcase  
WR - wardrobe  
L - door hinged left  
R - door hinged right  
X - Silver Metallic framed frosted glass doors

**STANDARD LAMINATES**

For a complete list of standard Laminates please see page 446.

# ARTEMIS LAMINATE | WARDROBES

Description	Model	Laminate	W	D	H	Shipping Weight	Cubic Feet
5 Hi Wardrobe with Closed Shelves	72WR36246901	2503	35.75	24	69	164	39.75
	72WR36246903*	2503	35.75	24	69	164	39.75



**ORDERING NOTES:**

01 - indicates closed left shelves and closed right wardrobe.  
 03 - indicates closed right shelves and closed left wardrobe.

5 Hi Full Width Wardrobe	72WR36246902	2423	35.75	24	69	135	39.75
--------------------------	--------------	------	-------	----	----	-----	-------



**ORDERING NOTES:**

Storage units have the option of pulls instead of the standard touch latch doors. To select this option, please change the prefix in the model number from "72" to "73" ie: 73WR36246901. Please refer to page 449 for pull orientation above and below the worksurface. Locks are available on all wood doors at **\$152 list per lock**. 24", 30" & 36" wardrobes require 2 locks.

**ORDERING PROCEDURE**

To order, please specify the following:

- 1) Krug product model number
- 2) Laminate, see page 446
- 3) Edge detail- I,H, L or P, see page 448
- 4) Pull style, see page 449
- 5) Grommet location if applicable

\*Indicates model illustrated by line drawing.



**CODE DESCRIPTION**

ST - storage unit  
 BC - bookcase  
 WR - wardrobe  
 L - door hinged left  
 R - door hinged right  
 X - Silver Metallic framed frosted glass doors

**STANDARD LAMINATES**

For a complete list of standard laminates please see page 446.

## ARTEMIS LAMINATE | MODULAR TOPS & MEETING TABLES

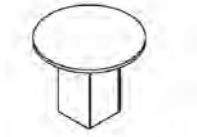
Description	Model	Laminate Top/Polymer Edge	HPL Top/Polymer Edge	W	D	H	Shipping Weight	Cubic Feet
	72TP6620	363	557	66	20	1.13	43	2.75
	72TP6624	416	640	66	24	1.13	50	3
	72TP6630	493	759	66	30	1.13	64	4
	72TP7220	409	627	72	20	1.13	44	3
	72TP7224*	464	711	72	24	1.13	55	3.5
	72TP7230	556	849	72	30	1.13	65	4
	72TP7820	456	702	78	20	1.13	46	3
	72TP7824	517	796	78	24	1.13	58	3.75
72TP7830	621	954	78	30	1.13	75	4.75	
	72TPR4220L	295	434	42	20	1.13	28	1.75
	72TPR4220R	295	434	42	20	1.13	28	1.75
	72TPR4224L	327	476	42	24	1.13	28	1.75
	72TPR4224R	327	476	42	24	1.13	28	1.75
	72TPR4820L*	320	471	48	20	1.13	31	2
	72TPR4820R	320	471	48	20	1.13	31	2
	72TPR4824L	357	522	48	24	1.13	31	2
	72TPR4824R	357	522	48	24	1.13	31	2
	72053629WM*	1357	1598	36	36	29.35	50	5.75
	72054229WM	1555	1862	42	42	29.35	62	7.5
	72054829WM	1676	2011	48	48	29.35	80	9.5

**DIMENSION KEY**

W - width  
 D - depth  
 H - height

Dimensions are in inches and approximate. Contact Customer Service if dimensions are critical.

**CODE DESCRIPTION**

L - left hand position  
 R - right hand position  
 4 - full height pedestal  
 D - 2 file drawer  
 F - 2 box, 1 file drawer  
 P6- panel leg  
 WM- wire management

**STANDARD LAMINATES**

For a complete list of standard Laminates please see page 446.

**GROMMETS**

One grommet in standard position is optional at no charge. See page 494 for more power management information.

# ARTEMIS LAMINATE | MODULAR & KNOCK DOWN COMPONENTS

Description	Model	Laminate	W	D	H	Shipping Weight	Cubic Feet
	72LB2029L	473	16	20	28	55	2
	72LB2029R	473	16	20	28	55	2
	72LB2429L*	511	16	24	28	60	3
	72LB2429R*	511	16	24	28	60	3
	72LB3029L	546	16	30	28	70	3.5
	72LB3029R	546	16	30	28	70	3.5

Half Gable Desk Height	72HG0829	143	8	1.12	28	8	1.5
	72HG1229	152	12	1.12	28	8	1.5



Panel Leg	72LG1429P6	326	12	1.12	28	8	1.5
-----------	------------	-----	----	------	----	---	-----



Modular Laminate	72PFB16204F	1227	15.75	20	28	61	6.5
Pedestals with Finish Back	72PFB16204D	1212	15.75	20	28	59	6.5
	72PFB16244F*	1347	15.75	24	28	72	6.5
	72PFB16244D	1332	15.75	24	28	70	6.5
	72PFB16304F	1465	15.75	30	28	83	9.5
	72PFB16304D	1453	15.75	30	28	78	9.5



## ORDERING NOTES:

Artemis Laminate includes a range of standard components for creating modular and reconfigurable units that are non-handed, and adaptable to changing needs. Non standard modular components can also be specified. In addition, a number of the desk, credenza and return models in this price list can be quoted and ordered as modular components. Please contact Customer Service for assistance in specifying and pricing modular components..

## ORDERING PROCEDURE

To order, please specify the following:

- 1) Krug product model number
- 2) Laminate, see page 446
- 3) Edge detail- I,H, L or P, see page 448
- 4) Pull style, see page 449
- 5) Grommet location if applicable

\*Indicates model illustrated by line drawing.

## CODE DESCRIPTION

L - left hand position  
 R - right hand position  
 4 - full height pedestal  
 D - 2 file drawer  
 F - 2 box, 1 file drawer  
 P6- panel leg  
 WM- wire management

## STANDARD LAMINATES

For a complete list of standard laminates please see page 446.

# ARTEMIS LAMINATE | MODULAR

Description	Model	Laminate	W	D	H	KW	Shipping Weight	Cubic Feet
Mobile Pedestal	72MP161927F*	1181	15.75	18.5	26.75		82	6.5
	72MP161927D	1169	15.75	18.5	26.75		82	6.5



Description	Model	Laminate	W	D	H	KW	Shipping Weight	Cubic Feet
Laminate Modesty Panel	72MP66*	362	0.75	42.75	28		26	4.5
	72MP72	392	0.75	48.75	28		30	5
	72MP78	428	0.75	54.75	28		30	5



**DIMENSION KEY**

W - width  
 D - depth  
 H - height

Dimensions are in inches and approximate. Contact Customer Service if dimensions are critical.

**CODE DESCRIPTION**

L - left hand position  
 R - right hand position  
 4 - full height pedestal  
 D - 2 file drawer  
 F - 2 box, 1 file drawer  
 P6- panel leg  
 WM- wire management

**STANDARD LAMINATES**





For a complete list of standard Laminates please see page 446.

**GROMMETS**

One grommet in standard position is optional at no charge. See page 494 for more power management information.

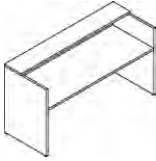

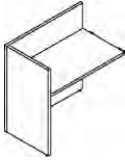
# ARTEMIS LAMINATE | RECEPTION

Description	Model	Laminate Top/Polymer Edge	HPL Top/Polymer Edge	W	D	H	Shipping Weight	Cubic Feet
	72GSD7230	1667	2087	71.75	30	42	216	65
	72GSD7830*	1915	2378	77.75	30	42	229	68
	72GSD8430	1984	2485	83.75	30	42	241	75.5
	72GSD9630	2114	2670	95.75	30	42	265	85.75
	72GSC7224	1440	1695	71.75	24	42	197	53.75
	72GSC7824*	1659	1953	77.75	24	42	209	58
	72GSC8424	1719	2028	83.75	24	42	221	62
	72GSC9624	1832	2234	95.75	24	42	244	70.5
	72GSRH4224L*	999	1166	41.75	24	42	118	32.5
	72GSRH4224R	999	1166	41.75	24	42	118	32.5
	72GSRH4824L	1066	1246	47.75	24	42	128	36.75
	72GSRH4824R	1066	1246	47.75	24	42	128	36.75
	72GLU4224H*	731	878	41.75	24	24	76	32.5
	72GLU4824H	834	1011	47.75	24	24	87	36.75
	MTL72TP6120	321	486	61	20	1.13	42	2.5
	MTL72TP6124	371	560	61	24	1.13	54	2.5
	MTL72TP6620	363	552	66	20	1.13	43	2.5
	MTL72TP6624	416	628	66	24	1.13	50	2.5
	MTL72TP6630	493	746	66	20	1.13	64	3.5
	MTL72TP7220	409	619	72	24	1.13	44	2.75
	MTL72TP7224*	464	699	72	20	1.13	55	3
	MTL72TP7230	556	851	72	24	1.13	65	3.75

## ORDERING NOTES:

Artemis Laminate includes a range of standard components for creating modular and reconfigurable units that are non-handed, and adaptable to changing needs. Non standard modular components can also be specified. In addition, a number of the desk, credenza and return models in this price list can be quoted and ordered as modular components. Please contact Customer Service for assistance in specifying and pricing modular components..

## ORDERING PROCEDURE

To order, please specify the following:

- 1) Krug product model number
- 2) Laminate, see page 446
- 3) Edge detail- I,H, L or P, see page 448
- 4) Pull style, see page 449
- 5) Grommet location if applicable

\*Indicates model illustrated by line drawing.

## CODE DESCRIPTION

L - left hand position  
 R - right hand position  
 4 - full height pedestal  
 D - 2 file drawer  
 F - 2 box, 1 file drawer  
 P6- panel leg  
 WM- wire management

## STANDARD LAMINATES

For a complete list of standard laminates please see page 446.

## ARTEMIS LAMINATE | METAL MODULAR COMPONENTS

Description	Model	Price	W	D	H	Shipping Weight	Cubic Feet
Metal Pedestal Desk	MTL72P15184F*	877	15.25	22	27.75	53	7.2
Height 2 Box/1 File	MTL72P15184D	816	15.25	18	27.75	51	7.2
& File/File	MTL72P15224F	1030	15.25	22	27.75	70	10.6
	MTL72P15224D	971	15.25	18	27.75	70	10.6



Metal Pedestal 2 Hi Lateral File	MTL72P30182801	1396	36	18.25	27.75	101	11.8
----------------------------------	----------------	------	----	-------	-------	-----	------



Metal Pedestal File/2 Box & Lateral File Combination	MTL72P30182802	1568	36	18.25	27.75	105	11.8
--	----------------	------	----	-------	-------	-----	------

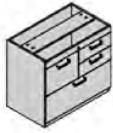

Metal Pedestal 2 Box/ File & Lateral File Combination	MTL72P30182804	1497	36	18.25	27.75	95	11.8
---	----------------	------	----	-------	-------	----	------



Metal Mobile Pedestal	MTL72MP1519227F	1030	15.25	19	27	54	7
-----------------------	-----------------	------	-------	----	----	----	---

**DIMENSION KEY**

W - width  
D - depth  
H - height

Dimensions are in inches and approximate. Contact Customer Service if dimensions are critical.

**CODE DESCRIPTION**

MTL- metal components  
4 - full height pedestal  
D - 2 file drawer  
01 - lateral file drawer

**STANDARD FINISHES**

For a complete list of standard Laminates please see page 446.

# ARTEMIS LAMINATE | METAL MODULAR COMPONENTS

Description	Model	Price	W	D	H	Shipping Weight	Cubic Feet
2 Hi Lateral File	MTL72ST36182801	1736	36	18.25	27.75	108	14



Metal Pedestal File/2 Box & Lateral File Combination	MTL72ST36182811	1567	36	18.25	27.75	101	14
--	-----------------	------	----	-------	-------	-----	----



Metal Pedestal 2 Box/ File & Lateral File Combination	MTL72BC361328	1131	36	13.5	27.75	67	11.3
---	---------------	------	----	------	-------	----	------

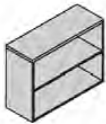

Metal Mobile Pedestal	MTL72ST36185201	2751	36	18.25	51.5	192	25.2
-----------------------	-----------------	------	----	-------	------	-----	------



## DIMENSION KEY

W - width  
D - depth  
H - height

Dimensions are in inches and approximate. Contact Customer Service if dimensions are critical.

## CODE DESCRIPTION

MTL- metal components  
4 - full height pedestal  
D - 2 file drawer  
01 - lateral file drawer

## COLORS AVAILABLE

Silver Metallic  
Additional Colors are available upon request.

## ARTEMIS LAMINATE | METAL MODULAR COMPONENTS

Description	Model	Price	W	D	H	Shipping Weight	Cubic Feet
4 Hi Storage Closed	MTL72ST36185211	2407	36	18.25	51.5	148	25.2



4 Hi Bookcase Open Shelves	MTL72BC361352	1405	36	13.5	51.5	90	14.2
----------------------------	---------------	------	----	------	------	----	------



5 Hi Bookcase Open Shelves	MTL72BC361366	1683	36	13.5	66	118	25.3
----------------------------	---------------	------	----	------	----	-----	------

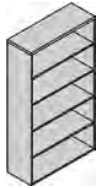

5 Hi Storage-3 Lateral File, 2 Closed	MTL72ST36186608	3534	36	18.25	66	212	30.8
---------------------------------------	-----------------	------	----	-------	----	-----	------



5 Hi Storage-2 Lateral File, 3 Closed	MTL72ST36186604	3329	36	18.25	66	203	30.8
---------------------------------------	-----------------	------	----	-------	----	-----	------



**DIMENSION KEY**

W - width  
D - depth  
H - height

Dimensions are in inches and approximate. Contact Customer Service if dimensions are critical.

**CODE DESCRIPTION**

MTL- metal components  
4 - full height pedestal  
D - 2 file drawer  
01 - lateral file drawer

**COLORS AVAILABLE**

Silver Metallic  
Additional Colors are available upon request.

# ARTEMIS LAMINATE | METAL MODULAR COMPONENTS

Description	Model	Price	W	D	H	Shipping Weight	Cubic Feet
5 Hi Storage- Closed	MTL72ST36186611	2830	36	18.25	66	172	31



5 Hi- 2 File/3 Closed, Shelves/Wardrobe	MTL72WR24246610	3036	23.5	23.5	66	193	25.7
---	-----------------	------	------	------	----	-----	------



**ORDERING NOTES:**

(10) - indicates closed right wardrobe, 3 closed left shelves, 2 file drawers

(11) - indicates closed left wardrobe, 3 closed right shelves, 2 file drawers

5 Hi- Wardrobe, 2 File/3 Closed Shelves	MTL72WR24246611	3036	23.5	23.5	66	193	25.7
---	-----------------	------	------	------	----	-----	------



**ORDERING NOTES:**

(10) - indicates closed right wardrobe, 3 closed left shelves, 2 file drawers

(11) - indicates closed left wardrobe, 3 closed right shelves, 2 file drawers

**DIMENSION KEY**

W - width  
D - depth  
H - height

**CODE DESCRIPTION**



MTL- metal components  
4 - full height pedestal  
D - 2 file drawer  
01 - lateral file drawer

**COLORS AVAILABLE**

Silver Metallic  
Additional Colors are available upon request.

\*Indicates model illustrated by line drawing.

# ARTEMIS LAMINATE | MEDIA WALL

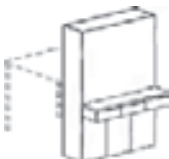
Description	Model	Laminate	W	D	H	Shipping Weight	Cubic Feet
1 TV Area, Unfinished Back 	72MW541269S14	2185	53.75	12	69	164	26
	72MW601269S14	2239	59.75	12	69	220	35
	72MW541269S16	2185	53.75	12	69	164	26
	72MW601269S16	2239	59.75	12	69	220	35
1 TV Area, Finished Back 	72MW541269S14FBB	2632	53.75	12	69	213	26
	72MW601269S14FBB	2703	59.75	12	69	285	35
	72MW541269S16FBB	2632	53.75	12	69	213	26
	72MW601269S16FBB	2703	59.75	12	69	285	35
1 TV Area, Finished Back with Drawers 	72MW541269S14FBB	4200	53.75	12	69	238	30
	72MW601269S14FBB	4941	59.75	12	69	318	41
	72MW541269S16FBB	4200	53.75	12	69	238	30
	72MW601269S16FBB	4941	59.75	12	69	318	41

**ORDERING NOTES:**

Media Wall units are not stand alone cases. They must be used in conjunction with a Media Wall runoff top. Runoff tops and bases are sold separately, please see page 512 for model numbers and pricing.

**DIMENSION KEY**

W - width  
 D - depth  
 H - height

Dimensions are in inches and approximate. Contact Customer Service if dimensions are critical.



**CODE DESCRIPTION**

S14 - use with desk height runoff  
 S16 - use with bar height runoff  
 FBB - finished back with drawer ban  
 FB - finished baCK

**STANDARD LAMINATES**

For a complete list of standard Laminates please see page 446.

# ARTEMIS LAMINATE | MEDIA WALL DESK HEIGHT RUNOFFS

Description	Model	Laminate Top/Polymer Edge	HPL Top/Polymer Edge	W	D	H	Shipping Weight	Cubic Feet
	72MHR60364	879	1346	59.5	35.75	29.5	85	5
	72MHR60424	1097	1683	59.5	41.75	29.5	98	6
	72MHR66364	914	1399	65.5	35.75	29.5	93	5.5
	72MHR66424	1138	1743	65.5	41.75	29.5	106	6.5
	72MHR72364	979	1499	71.5	35.75	29.5	100	6
	72MHR72424	1207	1849	71.5	41.75	29.5	115	7
	72MHR78364	1149	1758	77.5	35.75	29.5	108	6.5
	72MHR78424	1383	2114	77.5	41.75	29.5	118	7.5
	72MHR84364	1180	1804	83.5	35.75	29.5	115	7
	72MHR84424	1412	2161	83.5	41.75	29.5	135	8
	72MHR96364	1243	1901	95.5	35.75	29.5	140	7.5
	72MHR96424	1477	2256	95.5	41.75	29.5	160	9
	72MHAR60364	916	1403	59.5	35.75	29.5	85	5
	72MHAR60424	1137	1738	59.5	41.75	29.5	98	6
	72MHAR66364	954	1458	65.5	35.75	29.5	93	5.5
	72MHAR66424	1177	1798	65.5	41.75	29.5	106	6.5
	72MHAR72364	1017	1557	71.5	35.75	29.5	100	6
	72MHAR72424	1245	1906	71.5	41.75	29.5	115	7
	72MHAR78364	1187	1817	77.5	35.75	29.5	108	6.5
	72MHAR78424	1420	2172	77.5	41.75	29.5	118	7.5
	72MHAR84364	1216	1861	83.5	35.75	29.5	115	7
	72MHAR84424	1451	2218	83.5	41.75	29.5	135	8
	72MHAR96364	1281	1957	95.5	35.75	29.5	140	7.5
	72MHAR96424	1510	2312	95.5	41.75	29.5	160	9
	72MHBR60364	916	1403	59.5	35.75	29.5	85	5
	72MHBR60424	1137	1738	59.5	41.75	29.5	98	6
	72MHBR66364	954	1458	65.5	35.75	29.5	93	5.5
	72MHBR66424	1177	1798	65.5	41.75	29.5	106	6.5
	72MHBR72364	1017	1557	71.5	35.75	29.5	100	6
	72MHBR72424	1245	1906	71.5	41.75	29.5	115	7
	72MHBR78364	1187	1817	77.5	35.75	29.5	108	6.5
	72MHBR78424	1420	2172	77.5	41.75	29.5	118	7.5
	72MHBR84364	1216	1861	83.5	35.75	29.5	115	7
	72MHBR84424	1451	2218	83.5	41.75	29.5	135	8
	72MHBR96364	1281	1957	95.5	35.75	29.5	140	7.5
	72MHBR96424	1510	2312	95.5	41.75	29.5	160	9

## ORDERING NOTES:

Please see page 639 for power/data options. Please note that 2" Square Metal legs cannot be specified with the Bullet Runoff top.

### ORDERING PROCEDURE

To order, please specify the following:

- 1) Krug product model number
- 2) Laminate, see page 446
- 3) Edge detail- I,H, L or P, see page 448
- 4) Pull style, see page 449
- 5) Grommet location if applicable

\*Indicates model illustrated by line drawing.



### CODE DESCRIPTION

S1 - 1 TV area  
 S2 - 2 TV areas  
 WB - white board  
 11 - closed bookcase  
 B - drawer bank  
 4 - use with desk height runoff  
 6 - use with bar height runoff

### STANDARD LAMINATES

For a complete list of standard Laminates please see page 446.

## ARTEMIS LAMINATE | MEDIA WALL BAR HEIGHT RUNOFFS

Description	Model	Laminate Top/Polymer Edge	HPL Top/Polymer Edge	W	D	H	Shipping Weight	Cubic Feet
	72MHVR6036-424	1052	1609	59.5	35.75	29.5	98	6
	72MHVR6042-484	1291	1977	59.5	41.75	29.5	110	6.5
	72MHVR6636-424	1088	1664	65.5	35.75	29.5	106	6.5
	72MHVR6642-484	1338	2046	65.5	41.75	29.5	120	7
	72MHVR7236-424	1151	1761	71.5	35.75	29.5	115	7
	72MHVR7242-484	1416	2167	71.5	41.75	29.5	130	7.5
	72MHVR7836-424	1312	2009	77.5	35.75	29.5	118	7.5
	72MHVR7842-484	1578	2411	77.5	41.75	29.5	145	8
	72MHVR8436-424	1341	2053	83.5	35.75	29.5	135	8
	72MHVR8442-484	1610	2461	83.5	41.75	29.5	155	9
72MHVR9636-424	1351	2066	95.5	35.75	29.5	160	9	
72MHVR9662-484	1396	2136	95.5	41.75	29.5	175	10	
	72MHR60366	879	1346	59.5	35.75	41.5	85	5
	72MHR60426	1097	1683	59.5	41.75	41.5	98	6
	72MHR66366	914	1399	65.5	35.75	41.5	93	5.5
	72MHR66426	1138	1743	65.5	41.75	41.5	106	6.5
	72MHR72366	979	1499	71.5	35.75	41.5	100	6
	72MHR72426	1207	1849	71.5	41.75	41.5	115	7
	72MHR78366	1149	1758	77.5	35.75	41.5	108	6.5
	72MHR78426	1383	2114	77.5	41.75	41.5	118	7.5
	72MHR84366	1180	1804	83.5	35.75	41.5	115	7
	72MHR84426	1412	2161	83.5	41.75	41.5	135	8
	72MHR96366	1243	1901	95.5	35.75	41.5	140	7.5
	72MHR96426	1477	2256	95.5	41.75	41.5	160	9
		72MHAR60366	916	1403	59.5	35.75	41.5	85
72MHAR60426		1137	1738	59.5	41.75	41.5	98	6
72MHAR66366		954	1458	65.5	35.75	41.5	93	5.5
72MHAR66426		1177	1798	65.5	41.75	41.5	106	6.5
72MHAR72366		1017	1557	71.5	35.75	41.5	100	6
72MHAR72426		1245	1906	71.5	41.75	41.5	115	7
72MHAR78366		1187	1817	77.5	35.75	41.5	108	6.5
72MHAR78426		1420	2172	77.5	41.75	41.5	118	7.5
72MHAR84366		1216	1861	83.5	35.75	41.5	115	7
72MHAR84426		1451	2218	83.5	41.75	41.5	135	8
72MHAR96366		1281	1957	95.5	35.75	41.5	140	7.5
72MHAR96426	1510	2312	95.5	41.75	41.5	160	9	

**ORDERING NOTES:**

Please see page 493 for power/data options.

**DIMENSION KEY**

W - width  
D - depth  
H - height

Dimensions are in inches and approximate.  
Contact Customer Service if dimensions are critical.

**CODE DESCRIPTION**



S1 - 1 TV area  
S2 - 2 TV areas  
WB - white board  
11 - closed bookcase  
B - drawer bank  
4 - use with desk height runoff  
6 - use with bar height runoff

**STANDARD LAMINATES**

For a complete list of standard Laminates please see page 446.



# ARTEMIS LAMINATE | MEDIA WALL BAR HEIGHT RUNOFFS

Description	Model	Laminate Top/Polymer Edge	HPL Top/Polymer Edge	W	D	H	Shipping Weight	Cubic Feet
	72MHBR60366	916	1403	59.5	35.75	41.5	85	5
	72MHBR60426	1137	1738	59.5	41.75	41.5	98	6
	72MHBR66366	954	1458	65.5	35.75	41.5	93	5.5
	72MHBR66426	1177	1798	65.5	41.75	41.5	106	6.5
	72MHBR72366	1017	1557	71.5	35.75	41.5	100	6
	72MHBR72426	1245	1906	71.5	41.75	41.5	115	7
	72MHBR78366	1187	1817	77.5	35.75	41.5	108	6.5
	72MHBR78426	1420	2172	77.5	41.75	41.5	118	7.5
	72MHBR84366	1216	1861	83.5	35.75	41.5	115	7
	72MHBR84426	1451	2218	83.5	41.75	41.5	135	8
	72MHBR96366	1281	1957	95.5	35.75	41.5	140	7.5
	72MHBR96426	1510	2312	95.5	41.75	41.5	160	9
		72MHVR6036-426	1052	1609	59.5	35.75	41.5	98
72MHVR6042-486		1291	1977	59.5	41.75	41.5	110	6.5
72MHVR6636-426		1088	1664	65.5	35.75	41.5	106	6.5
72MHVR6642-486		1338	2046	65.5	41.75	41.5	120	7
72MHVR7236-426		1151	1761	71.5	35.75	41.5	115	7
72MHVR7242-486		1416	2167	71.5	41.75	41.5	130	7.5
72MHVR7836-426		1312	2009	77.5	35.75	41.5	118	7.5
72MHVR7842-486		1578	2411	77.5	41.75	41.5	145	8
72MHVR8636-426		1341	2053	83.5	35.75	41.5	135	8
72MHVR8642-486		1610	2461	83.5	41.75	41.5	155	9
72MHVR9636-426		1351	2066	95.5	35.75	41.5	160	9
72MHVR9642-486		1396	2136	95.5	41.75	41.5	175	10
		72MHVAR6036-426	1083	1657	59.5	35.75	41.5	98
	72MHVAR6042-486	1165	1781	59.5	41.75	41.5	110	6.5
	72MHVAR6636-426	1119	1714	65.5	35.75	41.5	106	6.5
	72MHVAR6642-486	1377	2108	65.5	41.75	41.5	120	7
	72MHVAR7236-426	1185	1815	71.5	35.75	41.5	115	7
	72MHVAR7242-486	1459	2230	71.5	41.75	41.5	130	7.5
	72MHVAR7836-426	1354	2069	77.5	35.75	41.5	118	7.5
	72MHVAR7842-486	1622	2483	77.5	41.75	41.5	145	8
	72MHVAR8436-426	1381	2113	83.5	35.75	41.5	135	8
	72MHVAR8442-486	1657	2533	83.5	41.75	41.5	155	9
	72MHVAR9636-426	1438	2198	95.5	35.75	41.5	160	9
	72MHVAR9642-486	1727	2640	95.5	41.75	41.5	175	10

## ORDERING NOTES:

Please note that 2" Square Metal legs cannot be specified with the Bullet Runoff top.

### ORDERING PROCEDURE

To order, please specify the following:

- 1) Krug product model number
- 2) Laminate, see page 446
- 3) Edge detail- I,H, L or P, see page 448
- 4) Pull style, see page 449
- 5) Grommet location if applicable

\*Indicates model illustrated by line drawing.

### CODE DESCRIPTION

- S1 - 1 TV area
- S2 - 2 TV areas
- WB - white board
- 11 - closed bookcase
- B - drawer bank
- 4 - use with desk height runoff
- 6 - use with bar height runoff

### STANDARD LAMINATES

For a complete list of standard Laminates please see page 446.

## ARTEMIS LAMINATE | MEDIA WALL BASES

Description	Model	Price	W	D	H	KW	Shipping Weight	Cubic Feet
4" Diameter Metal Leg	72LG429D8	729	4	4	28		20	1
	72LG442D8	781	4	4	41		30	1.5



Disc Bases	72141828	301	18	18	28.5		30	8
	72141842	337	18	18	41		35	8.5



2" Square Metal Leg	72LG229M	460	2	2	28		10	1
	72LGX242M	515	2	2	41		20	1.5



**ORDERING NOTES:**

Please note that 2" Square Metal legs cannot be specified with the Bullet Runoff top.

T-Base	72LG2029TR5	448	2	2	28		10	1
	72LG2042TR5	678	2	2	41		20	1.5

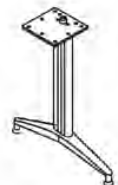

**ORDERING NOTES:**

Please note that 29" base is to be used to achieve a desk height runoff, 42" base is to be used for bar height runoff.

**DIMENSION KEY**

W - width  
D - depth  
H - height

Dimensions are in inches and approximate.  
Contact Customer Service if dimensions are critical.

# LATITUDE | TABLE OF CONTENTS

518	Environmental Summary
519	Veneer & Finishes
520	Non-Standard Product Guidelines for Pricing
520	Edge Profile & Pulls
521	General Product Specifications
528	Sample Configuration
529	Desks
536	Height Adjustable Worksurfaces
541	Desk Runoffs
546	Returns
547	Linking
548	Credenzas
553	Overheads
557	Hutches
559	Wall Mounted Panels
560	PowerPorts & Cable Management
564	Pedestals
565	Bookcases
566	Storage
570	Wardrobes
572	Modular Components

# LATITUDE | ENVIRONMENTAL SUMMARY

## LEED CERTIFICATION



MATERIAL CONTENT:

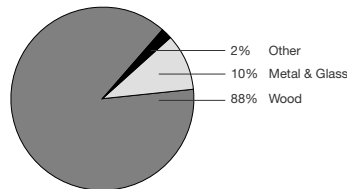

PRE-CONSUMER RECYCLED CONTENT - 81%

POST-CONSUMER RECYCLED CONTENT - 3%

		CONTRIBUTES To
Credit 2.1 - 2.2	Construction Waste Management	1-
Credit 4.1	Recycled Content	1 point
Credit 4.2	Recycled Content	1 point
Credit 4.5	Low Emitting Materials, (MUST BE REQUESTED )	
	Composite Wood & Laminate Adhesives	1 point
Credit 5.1	Regional Materials*	1 point
Credit 7	Certified Wood (MUST BE REQUESTED )	1 point

\*This credit is only applicable if in total 20% of the combined value of the procurement of construction materials and in the furniture are manufactured within a radius of 500 miles. This credit will apply if the installation of the finished product occurs within 500 miles of Kitchener, Ontario.

### level® CERTIFICATION



BIFMA's e3 Furniture Sustainability Standard is a voluntary, multi-attribute standard that measures the degree of sustainability of furniture. This standard evaluates product and company environmental attributes and compliance systems in a wide range of elements which include Materials, Energy & Atmosphere, Human & Ecosystem Health and Social Responsibility. Latitude products have earned level®, BIFMA's sustainability certification program for furniture, certification through third-party verification against the e3 standard. All Latitude products can be supplied with level® certification. In order to accomplish this, the product must also be ordered with the air-emissions-certification option. Contact customer service for information and upcharges.

### AIR-EMISSIONS

All Latitude products can be supplied with air-emissions-certified materials. Contact customer service for information and upcharges.



FSC  
www.fsc.org  
FSC® C021699

the mark of responsible forest

### FSC®

FSC® In 2005, Krug received Forest Stewardship Council® (FSC®) Chain-of-Custody certification for our manufacturing facilities. The FSC® Chain-of-Custody tracks certified wood from seedling to final sale. It verifies that the material for our FSC® certified products only come from well-managed, FSC®-certified forests and other controlled sources. FSC® is dedicated to the promotion of responsible forest management worldwide helping to take care of forests for future generations. Latitude and other Krug products can be specified with FSC® Certification. Contact customer service for further information, pricing and lead times.



In addition, architects, designers, and building professionals can specify FSC®-certified products in order to achieve a point from the U.S. Green Building Council's Leadership in Energy and Environmental Design (LEED) Rating System.

# LATITUDE | VENEERS & FINISHES

## WOOD FINISHES

Standard wood finishes are:

SPECIES	FINISH
<b>OAK</b>	Light Oak
	SilverGrey on Oak
	Espresso Oak
	Harvest Oak
	Mahogany Oak
	Medium Cherry on Oak Mellow Oak
<b>WALNUT</b>	Walnut on Oak
	Natural Walnut
	SilverGrey on Walnut
	Regular Walnut Dark
	Walnut Cordovan Walnut
<b>PALETTE</b>	Black
	White
	Sand
	Soft Green
	Steel Blue
	Slate

**Note:** Palette is available on door fronts, drawer fronts and 1/2 height modesty panels.

## WOOD FINISHES TO MATCH STANDARD LAMINATES

- Willow on Rift Oak
- Dune on Rift Oak
- Portobello on Rift Oak
- Ash on Rift Oak
- Copper on Cherry
- Shiraz Cherry
- Park Avenue Walnut
- Chocolate on Walnut
- Nutmeg on Walnut
- Dark Walnut
- Hardrock Maple

## VENEERS

Latitude is available in Quarter Cut Walnut and Rift Cut Oak veneers, and each is priced in this price guide. Maple and Cherry are also available: for Flat Cut Maple or Cherry veneer, use Column 1 pricing; for Quarter Cut Maple or Cherry, use Column 2 pricing. The grain direction of the veneers on vertical faces is vertical - see below for grain direction specifications.

## NON-STANDARD VENEER SPECIES

In addition to range of standard wood species, Latitude can be made with virtually any commercially available veneers. To specify Anigre, Mozambique or Zebrano add 5% List, for Sycamore add 10% list to Walnut list price. Anigre is available in clear or medium finish, Mozambique, Zebrano & Sycamore are available in clear finish only. Other veneers are also available on Latitude, please contact customer service for more information and pricing on additional wood species not included in Latitude's standard offering.

## NATURAL CHARACTERISTICS OF WOOD

Wood is a natural product with inherent color variations that will never be fully mitigated by the finishing process. Please anticipate variation in colors within a single unit, from piece to piece, and from Krug wood finish samples. If a very close match is required, a sample must be provided with the order and an upcharge will apply. Exact color matches are not possible.

## CUSTOM WOOD FINISHES

Add 10% list to your order for special finishes, minimum upcharge is **\$595 list per finish** per order. (For example, on all orders up to \$5512 list, an **upcharge of \$595** will apply, on orders \$5512 and up add 10% list to your order.)

For orders with special finishes, a sample that is a minimum 3" by 3" must be received with the order. Special finishes may add additional lead time to production schedules.

Since wood is a natural product, some variations in grain, color and stain acceptance will occur. In our finishing processes, we try to minimize variations, but some variation between samples and finished goods should be anticipated.

## FINISH

Latitude Casegoods feature Krug's finish, a proprietary catalyzed varnish formulation, that has repeatedly shown through independent laboratory testing to be the industry leader in durability and abrasion resistance. The Krug finish looks better longer than competitors and is uniquely suited to the demands of high traffic environments.

## VENEER GRAIN DIRECTION

Providing a consistent wood grain direction is important in maintaining consistent color on adjacent worksurface. The arrows on the illustrations below show the grain direction on typical worksurfaces and case fronts.

Desks



Open Desks



Runoffs



Drawer and Door Fronts



Credenza



Returns & Linking Units



Hutches and Overheads

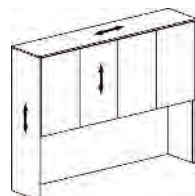

Storage



# LATITUDE | GUIDELINES AND PRICING METHODS

## PRICING METHODS

Custom widths: Apply the price that is one standard size larger than the desired case size (but same depth).

Example: The required custom dimension is 74" x 30". The first standard size above this is 78" x 30", so in this case you would apply the price of the 78" x 30" unit.

Custom depths: Apply the price of the same unit one size deeper (but same width).

Example: The required custom dimension is 72" x 26". The first standard size above this is 72" x 30", so in this case you would apply the price of the 72" x 30" unit.

Custom width & depth: Apply the price of the same unit both one size wider and one size deeper.

Example: The required custom dimension is 74" x 26". The first standard size above this is 84" x 30", so in this case you would apply the price of the 84" x 30" unit.

## LATITUDE | NON-STANDARD PRODUCT GUIDELINES FOR PRICING

### OTHER PRICING METHODS

Custom height of desk height cases: Add 18% (31-32" hi)

Grommets in non-standard positions, add: **\$152 list**

To remove hutch or overhead doors, deduct: **4% list**

Bookcase with optional vent in back (includes 2 vents and 1 grommet), add: **\$302 list**

2 lateral files and 3 or 4 closed shelves - convert to half open, half closed shelves, add: **15% list**

2 lateral files and 3 or 4 closed shelves - convert to half open, half wardrobe, add: **15% list**

To remove storage doors for open shelves, deduct: **4% list**

### EXCEPTIONS TO THE PRICING METHODS ABOVE

Sizes larger than largest shown in Price List.

Glass door – any style.

Cases with curvilinear tops where the radius becomes non-standard.

Please contact Krug Customer Service at 1.888.578.KRUG if you require assistance.

PLEASE NOTE: Cases with non-standard features do not apply to the rules above.

Contact Krug Customer Service if you require assistance.

## LATITUDE | EDGE PROFILE & PULLS

### LATITUDE EDGE PROFILE



Desks, Credenzas, Curvilinear Desks, Returns, Linking Units, Bookcases and 2Hi Storage units have profiles on all edges.

### LATITUDE PULL STYLE



Latitude drawer pulls are Gloss Aluminum finish. Doors feature a touch latch operation.



Latitude drawers have the option of finger pulls in the same finish as the drawer front. To order, note clearly on the purchase order and add **\$277 list** per pedestal.

**TESTING INFORMATION**

Latitude meets or exceeds the testing requirements of ANSI / BIFMA X5.5-2014 and/or X5.9-2012.





**POWERPORTS**

A PowerPort is a unique worksurface mounted module that can be specified to a location that best serves the user’s needs. It includes a UL approved electrical and data power bar, see page 521 for pricing.



**ROUND GROMMETS**

Round grommets are an aluminum finish with an open and shut mouse hole to provide cable passage for areas not requiring a large opening. Round grommets can be field installed with a power drill, 60 mm hole saw. All cases may be specified with one grommet in a standard position at no upcharge. A **\$152 list** upcharge will apply to additional grommets in standard positions and **\$152 list** for non-standard positions. The grommet position must be indicated for each case on the order. Please specify location of grommet when ordering. Please keep in mind the location of the grommets when specifying piers. For example, a pier on the left-hand side may be used with a “C”, “BR” or “AR” grommet.

**STANDARD GROMMET & POWERPORT POSITIONS**

Desks, Credenzas, Link Units & Returns

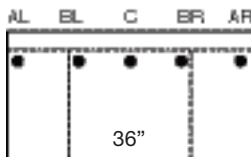
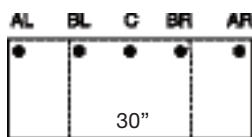

Position Code:

- AL – left corner
- BL – left end beside pedestal gable
- C – center
- BR – right end beside pedestal gable
- AR – right corner

“BR” and “BL” are only available on tops 60” or longer.

**3/4 height Credenzas for Mounted Runoffs with Power/Data Option**

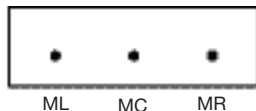

Position Code:

- ML - Mounted Left
- MC - Mounted Center ( applies to 90” and 96” tops only)
- MR - Mounted Right

**Rectangular Runoff Top Grommet & PowerPort**

Guest Side

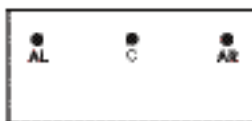

Position code:

- AL – left corner on right hand runoff (“AL” grommet and PowerPort locations apply to **rectangular runoffs**.)
- AR – right corner on left hand runoff
- C – center

**Curvilinear Top Grommets & PowerPorts**

“AL” and “AR” are the only grommet and PowerPort locations that apply to curvilinear returns. Please note these locations are not applicable on the 36” deep top and fixed modesty panel.

Guest Side



Guest Side



Position code:

- AL - left corner on right hand return
- AR - right corner on left hand return

Curvilinear desk grommets and PowerPorts can only be specified in “C” position.

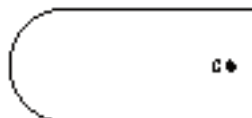

User Side

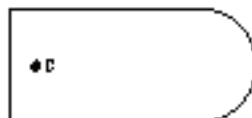

User Side

Position Code: C center



# LATITUDE | CABLE MANAGEMENT

## PEDESTAL ACCESS CABLE MANAGEMENT

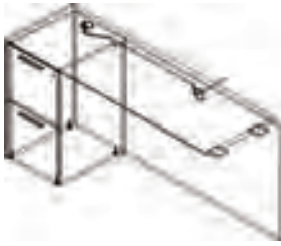

All Latitude casegood desks, returns and credenzas allow for wire management behind the pedestal drawers. Pedestal gables feature a standard cable management opening allowing access to the rear of the pedestal cavity. By specifying a wiring grommet in a standard AL or AR position (see grommet locations above) cable can be conveniently threaded behind the pedestal drawers and through the wire management access grommet.

### Velcro Cable Manager

A velcro wire management strip is available to assist in containing the cables



### Cable Management PVC Trough

PVC Cable manager is used in credenzas, L and U workstations.



### Cable Management for Runoffs

The Silver Metallic Trough is used to route cables from desk runoffs to credenza and out to the source.



## HEIGHT ADJUSTABLE WORKSURFACE WITH BASE ENCLOSURE

### Single Stage Mechanism With Base Enclosure

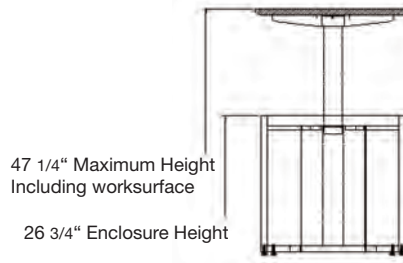
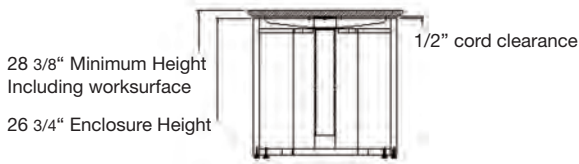

The Single Stage mechanism with Base Enclosure has an adjustable height range of 28 3/8 - 47 1/4 inches. When the worksurface is at the lowest stage - desk height, the space between underside of the worksurface and the top of the Base Enclosure is 1/2 inch.

### Dual Stage Mechanism With Base Enclosure

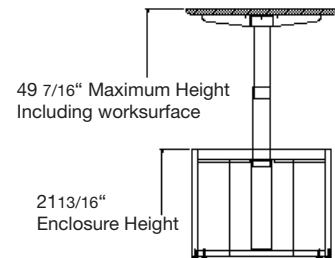
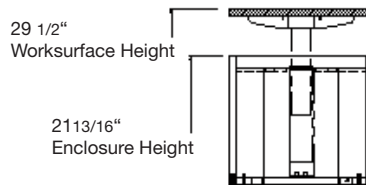
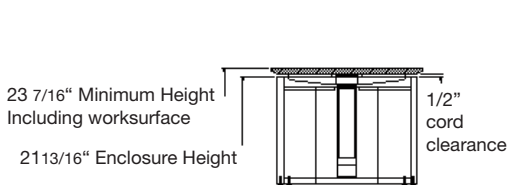

The Dual Stage mechanism with Base Enclosure has an adjustable height range of 23 7/16 - 49 7/16 inches. When the worksurface is at the standard desk height setting of 29 1/2", the space between underside of the worksurface and the top of the Base Enclosure is 6 inches. This allows for the full range of height adjustments.

Custom Base Enclosures for the Dual Stage are available decreasing the gap below the worksurface to 1/2 inch.

Caution: this eliminates the ability to use the lower stage settings.

Custom Base Enclosures to further lower the minimum worksurface height are also available, removing the inside enclosure floor completely and allowing a minimum desk height of 22 7/16". Contact customer service for a quote.

# LATITUDE | CREDENZAS

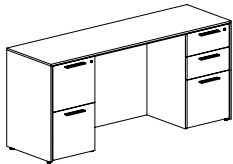

**CREDENZAS - Desk Height**

Latitude offers a wide variety of credenzas for use as stand alone storage pieces, part of a connected worksurface configuration, or behind a desk.

Choose from single or double pedestal options, with fixed or hinged modesty panel.

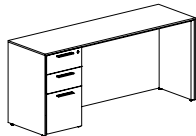

**Modesty Panels**

Credenzas with modesty panels have an added finished look, and all cases are available with a wiring grommet in a standard position for added cable management, please specify on your order. Credenzas with hinged modesty panels provide easy access to wall mounted electrical sources without wiring difficulties.



**Pedestals**

Latitude credenzas are available with single, lateral file, combination pedestals or bookcase pedestals. 3/4 height credenzas are available with box/lateral file, open/lateral file, bookcase, open/bookcase and/or open bookcase pedestals.

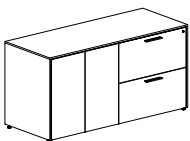

**Full Face Credenzas**

Full face credenzas are available in a variety of lateral file/bookcase & open bookcase combinations in 3/4 and full height cases.

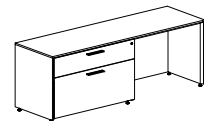

**Credenzas - 3/4 Height**

A large offering of Credenza sizes and configurations are available in single pedestal and full face versions.

## LINKING UNITS AND CORNER UNITS



**Linking Units**

Latitude linking units are available in a range of sizes for ease of use in configuring a connected worksurface.

Linking Units are for use between desks and credenzas in creating a U-shaped configuration, and must be supported at both ends. They are available with or without modesty panels.

**Linking Units, Tops and Returns**

It is important that the main units (desk, credenza) to which the linking unit or return is being attached be in their final position and leveled. Units are connected with mending plates under the worksurface from the modesty to the end panels. Attach the mending plates under the worksurface, ensure cases are level and if necessary adjust the glides to achieve flush and firm joints before completing installation of mending plates to the modesty and end panels.

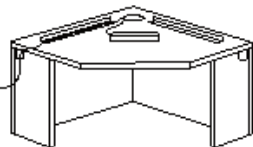

**Corner Units**

A corner unit can also be used on a U-shaped configuration, or it can be an integral part of a L-shaped work area with returns linked to either side.

Corner units have a standard grommet included in the back corner for ease of cable management, and have additional wire management access grommets in the half gables so that cable can be run to other areas of the connected worksurface. This can be assisted by a cut length of wire management cover.

# LATITUDE | HUTCHES, OVERHEADS, & TACKBOARDS



## Hutches and Overheads

Latitude offers hutch and overhead options for use in a work area configuration.

All hutches and overheads include L.E.D. tasklights that are factory installed and require no field adjustment.

Tasklights are mounted beneath the cabinet and hidden from view.

All hutches are available with Palette doors at no upcharge.

## Doors

Doors are equipped with fully adjustable European style hinges. Locks are optional and can be specified

at time of order for an **upcharge of \$152 per set** of (2) doors. If an uneven amount of doors require

locks, the lock on the single door is **also \$152**. Locks are not available on glass doors.

## Flip-Up Doors

Flip-up doors include standard European style hinges and an additional lift and stay mechanism.



## Hutch Power/ Data/ Voice Module

Access to power and data is made simple by using a hutch with a power/data/voice module built right

into the tackboard. The module is fully installed at the factory but can be removed to connect data links

on site. It features a flip door that retracts into the case of the unit when open.

## Tackboards

All hutches come standard with grade 1 tackboards. For other tackboard grade pricing, see chart on

page 557, please note, not all fabrics are suitable for tackboard application. Tackboard fabric selections

should be supplied with the order information.

Tackboards are not included with overheads, see page 555 for pricing. Overhead tackboards include wall mounting hardware and instructions.

Only hutches and overhead tackboards in Krug panel fabrics are available on *KrugExpress*.

## Wall Mounted Back-Painted Glass

Glass panels are 4mm tempered white back-painted glass with aluminum frame. Magnetic back-painted glass is also available.

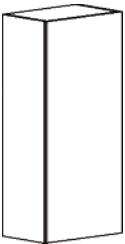

## Piers

Piers are used in conjunction with overhead/hutches, glass wall panels & tackboards

## L.E.D. Tasklights

Tasklights are included with hutches and overheads. On hutches, the tasklight cord is threaded behind the hutch through a standard access grommet on the upper right hand side of the back panel.

Tasklights are installed on the underside of overhead units. Cords run down the right hand side of the tasklight to the worksurface where they can be routed behind the worksurface top. The use of a wall mounted Overhead tackboard, back-painted glass wall panel or wood wall panel conceals the cord from view.

## Installation

Hutch and overhead installation instructions are included with every case.

# LATITUDE | FILING CONFIGURATIONS

Drawers will be offered for letter and legal size filing. All units are equipped with file bars that are fixed in place for shipping.



## DESK RUNOFFS & DESK PEDESTAL FILE DRAWERS

### Filing Capacity

- 15" drawers:
- 21" of letter filing front to back or
- 12" of legal filling side to side
- 22" pedestal drawer depths allow only one row of side to side files.

Weight capacity of pedestal file drawers is 100 lbs.

## CREENZA AND RETURN PEDESTAL FILE DRAWERS

### Filing Capacity

- 15" drawers:
- 15" of letter filing front to back or
- 12" of legal filling side to side
- 16" pedestal drawer depths allow only one row of side to side files.

Weight capacity of pedestal file drawers is 100 lbs.

## CREENZA, RETURN OR STORAGE LATERAL FILE DRAWERS

### Filing Capacity

- 30" wide drawers:
- 30" letter filing front to back, or
- 25" legal filing side to side
- 15" or legal filing front to back.

When filing front to back, 30" lateral file drawer widths allow two rows of letter filing, but only one row of legal file width.

### Filing capacity

- 36" wide drawers:
- 30" letter filing front to back, or
- 36" legal filing side to side, or
- 30" legal filing front to back.

Weight capacity of lateral file drawers is 130 lbs.

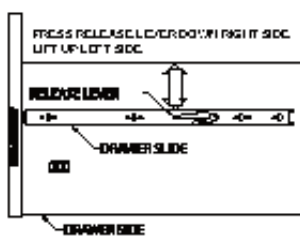

### Drawer Removal

Pull drawer and slide out to the full extension position. With index finger, lift up the release lever on the left and press down the release lever on the right side of the drawer (as shown).

Pull out the drawer with the attached drawer channel from the cabinet member.

To re-assemble, insert the drawer through the guide.

# LATITUDE | INSTALLATION

## Glide Adjustment

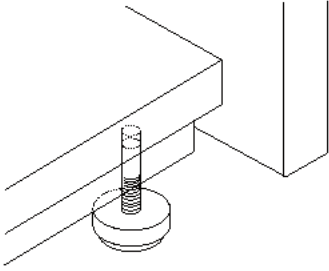

Raise one corner of the unit at a time and adjust the glide to the desired height by turning the glide to the hole. Make sure unit is level after adjusting the glides.

Please note that the maximum adjustment range of the glide is 1 1/4".

When moving units after glides have been inserted, dial the glides to the lowest position to prevent damage.

## Hutch Installation

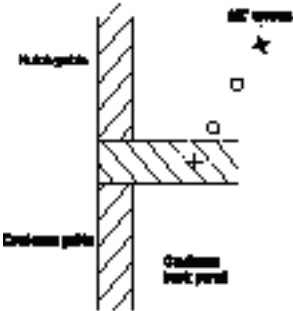

Before installing the hutch, insure that the worksurface has been placed in the final position and leveled. The worksurface should then be moved out a sufficient distance to allow access to the back. It is recommended that the minimum amount of movement be used with the leveling glides extended to prevent damage to the glides.

The hutch comes with self-adhesive foam strips that must be applied to the bottom edge prior to placing the hutch on the credenza. The foam is best applied with the hutch lying on its back. Do not leave any gaps in the foam strip, in order to prevent scratches to the credenza top while placing the hutch.

Place the hutch securely on the worksurface. Try to minimize any movement of the hutch to prevent scratching. Use of a blanket on the front portion of the credenza is recommended.

Using the supplied hardware, screw the flat bracket to the top of the credenza at each end, using the 3/4" screws provided. Swing the bracket up to approximately 60° and screw through the bracket into the hutch back with the 1/2" screws. Tighten all screws. Move combined hutch and credenza back to final location. Check for level again and adjust as required.

## Door Adjustments

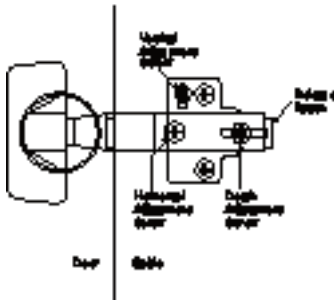

Hinges on all bookcase, overhead and hutch doors are designed to be adjusted for depth, horizontal and vertical alignment. This is easily done by adjusting the appropriate screw. See drawing.

To remove a door, push the release button and pull out the door, disconnecting hinges.

# LATITUDE | SAMPLE CONFIGURATIONS

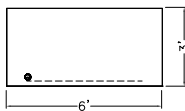
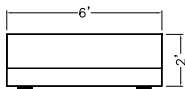
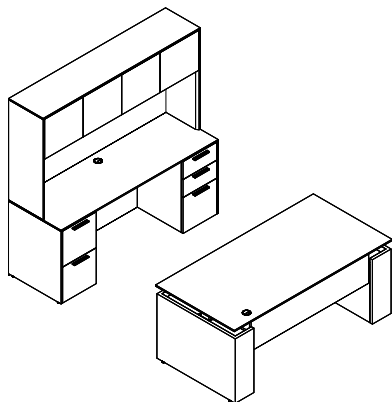

Model	Quarter Cut	
	Rift Oak	Cherry Maple Walnut*
Height Adj. Desk 65HA7236ETSGV21	6894	7239
Hutch 65HT721640	3733	3920
Credenza 65CY72244XLDRF	4592	4821
<b>TOTAL</b>	<b>15219</b>	<b>15980</b>

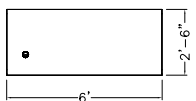
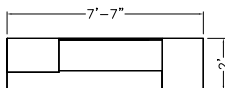
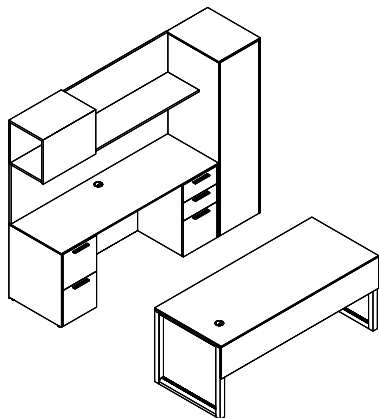

Model	Quarter Cut	
	Rift Oak	Cherry Maple Walnut*
Credenza 65CY72244XLDRF	4375	4821
Overhead 65OMW721718HD30	4630	5106
Tackboard 65TBOHW7224	562	591
Storage 65ST19247011R	3321	3662
Desk 65TD7230OBX21	5888	6182
<b>TOTAL</b>	<b>18776</b>	<b>20362</b>

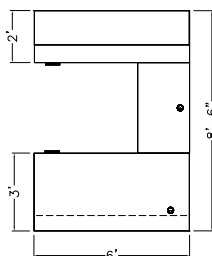
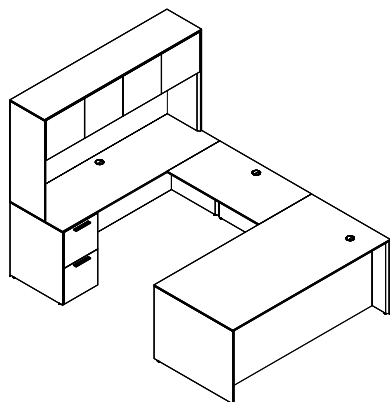

Model	Quarter Cut	
	Rift Oak	Cherry Maple Walnut*
Desk 65D72364L0RF	3771	3960
Link Unit 65LU4224HX41	1417	1487
Hutch 65HT721640	3555	3733
Credenza 65CY72244XLDR0	4067	4269
<b>TOTAL</b>	<b>12810</b>	<b>13449</b>

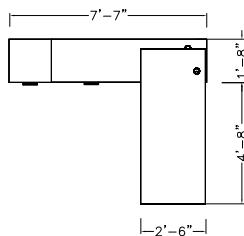
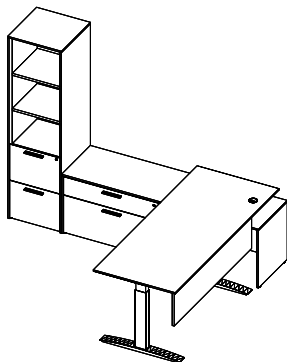



Model	Quarter Cut	
	Rift Oak	Cherry Maple Walnut*
Height Adj. Desk 65HA7230ETSO16V21	4125	4331
Storage 65ST19207090	3360	3530
Credenza 65CY72203XL3616R0	3555	3730
<b>TOTAL</b>	<b>11040</b>	<b>11591</b>

**ORDERING NOTES:**

\*To specify Anigre, Mozambique or Zebrano add 5% List. For Sycamore add 10% list to Walnut list price. Tops and modesty panels are wood veneer. Work surfaces are shown with grommets at no upcharge.

# LATITUDE | DESKS

Description	Model	Rift		W	D	H	KW	Shipping Weight	Cubic Feet	
		Oak	Walnut							
	Rectangular Desk, Double Pedestal	65D60304LDRF	4167	4373	59.75	30	29.5	27.5	218	39
		65D60304LFRD	4167	4373	59.75	30	29.5	27.5	218	39
		65D60304LFRF	4167	4373	59.75	30	29.5	27.5	218	39
		65D66304LDRF*	4194	4404	65.75	30	29.5	33.5	224	42.75
		65D66304LFRD	4194	4404	65.75	30	29.5	33.5	224	42.75
		65D66304LFRF	4194	4404	65.75	30	29.5	33.5	224	42.75
		65D66364LDRF	4217	4428	65.75	36	29.5	33.5	236	50
		65D66364LFRD	4217	4428	65.75	36	29.5	33.5	236	50
		65D66364LFRF	4217	4428	65.75	36	29.5	33.5	236	50
		65D72304LDRF	4231	4442	71.75	30	29.5	39.5	246	46.5
		65D72304LFRD	4231	4442	71.75	30	29.5	39.5	246	46.5
		65D72304LFRF	4231	4442	71.75	30	29.5	39.5	246	46.5
		65D72364LDRF	4277	4488	71.75	36	29.5	39.5	248	54.75
		65D72364LFRD	4277	4488	71.75	36	29.5	39.5	248	54.75
		65D72364LFRF	4277	4488	71.75	36	29.5	39.5	248	54.75
		65D78304LDRF	4297	4513	77.75	30	29.5	45.5	248	50
		65D78304LFRD	4297	4513	77.75	30	29.5	45.5	248	50
		65D78304LFRF	4297	4513	77.75	30	29.5	45.5	248	50
		65D78364LDRF	4323	4540	77.75	36	29.5	45.5	248	59
		65D78364LFRD	4323	4540	77.75	36	29.5	45.5	248	59
		65D78364LFRF	4323	4540	77.75	36	29.5	45.5	248	59
		65D84304LFRF	4428	4652	83.75	30	29.5	51.5	311	53.75
		65D84304LDRF	4428	4652	83.75	30	29.5	51.5	306	53.75
		65D84304LFRD	4428	4652	83.75	30	29.5	51.5	306	53.75
		65D84364LDRF	4455	4678	83.75	36	29.5	51.5	272	63
		65D84364LFRD	4455	4678	83.75	36	29.5	51.5	272	63
	65D84364LFRF	4455	4678	83.75	36	29.5	51.5	272	63	
	Rectangular Desk, Single Pedestal	65D60304LFR0	3646	3828	59.75	30	29.5	43	206	39
		65D60304LORF	3646	3828	59.75	30	29.5	43	206	39
		65D66304LFR0	3672	3856	65.75	30	29.5	49	212	42.75
		65D66304LORF*	3672	3856	65.75	30	29.5	49	212	42.75
		65D66364LFR0	3707	3891	65.75	36	29.5	49	224	50
		65D66364LORF	3707	3891	65.75	36	29.5	49	224	50
		65D72304LFR0	3709	3894	71.75	30	29.5	55	224	46.5
		65D72304LORF	3709	3894	71.75	30	29.5	55	224	46.5
		65D72364LFR0	3771	3960	71.75	36	29.5	55	236	54.75
		65D72364LORF	3771	3960	71.75	36	29.5	55	236	54.75
		65D78304LFR0	3792	3982	77.75	30	29.5	61	236	50
		65D78304LORF	3792	3982	77.75	30	29.5	61	236	50
		65D78364LFR0	3837	4028	77.75	36	29.5	61	242	59
		65D78364LORF	3837	4028	77.75	36	29.5	61	242	59
		65D84304LFR0	3907	4103	83.75	30	29.5	67	251	53.75
		65D84304LORF	3907	4103	83.75	30	29.5	67	251	53.75
		65D84364LFR0	3952	4147	83.75	36	29.5	67	260	63
		65D84364LORF	3952	4147	83.75	36	29.5	67	260	63

**ORDERING NOTES:**

Drawer fronts are available in pallet at an upcharge of **\$357 list** per unit, add P at the end of the model number.

**ORDERING PROCEDURE**

To order, please specify the following:

- 1) Krug product model number
- 2) Wood species and finish
- 3) Grommet location and style if applicable.

\* Indicates model illustrated by line drawing

**CODE DESCRIPTION**

- 4 - full height pedestal
- L - left hand position
- R - right hand position
- D - 2 file drawers
- F - 2 box, 1 file drawer
- 0 - no pedestal



**STANDARD FINISHES**

For a complete list of standard wood finishes, please see page 518.

**GROMMETS**

One grommet in a standard position is optional at no charge. See page 521 for more information.

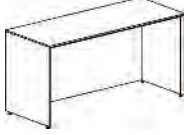
## LATITUDE | DESK SHELLS

Description	Model	Rift		W	D	H	KW	Shipping Weight	Cubic Feet
		Oak	Walnut						
	Rectangular Desk 65SD6030X41*	2581	2712	59.75	30	29.5	57.5	154	39
	Shell, Full Ht Modesty 65SD6630X41	2611	2742	65.75	30	29.5	63.5	198	42.75
	65SD6636X41	2640	2773	65.75	36	29.5	63.5	215	50
	65SD7230X41	2673	2807	71.75	30	29.5	69.5	210	46.5
	65SD7236X41	2701	2837	71.75	36	29.5	69.5	228	54.75
	65SD7830X41	2753	2891	77.75	36	29.5	75.5	241	59
	65SD7836X41	2769	2907	77.75	36	29.5	75.5	241	59
	65SD8430X41	2833	2977	83.75	36	29.5	81.5	254	63
	65SD8436X41	2852	2994	83.75	36	29.5	81.5	254	63
	Rectangular Desk 65SD6030X31	2531	2658	59.75	30	29.5	57.5	146	39
	Shell, 3/4 Ht Modesty 65SD6630X31*	2560	2688	65.75	30	29.5	63.5	198	42.75
	65SD6636X31	2587	2717	65.75	36	29.5	63.5	215	50
	65SD7230X31	2616	2747	71.75	30	29.5	69.5	210	46.5
	65SD7236X31	2646	2779	71.75	36	29.5	69.5	228	54.75
	65SD7830X31	2697	2832	77.75	36	29.5	75.5	228	54.75
	65SD7836X31	2717	2853	77.75	36	29.5	75.5	241	59
	65SD8430X31	2778	2917	83.75	36	29.5	81.5	254	63
	65SD8436X31	2798	2938	83.75	36	29.5	81.5	254	63
	Bow Top Option BT65D6030	441	464	59.75	-	-	-	-	-
	BT65D6630*	460	485	65.75	-	-	-	-	-
	BT65D6636	481	507	65.75	-	-	-	-	-
	BT65D7230	494	518	71.75	-	-	-	-	-
	BT65D7236	515	541	71.75	-	-	-	-	-
	BT65D7830	513	539	77.75	-	-	-	-	-
	BT65D7836	536	561	77.75	-	-	-	-	-
	BT65D8430	517	543	83.75	-	-	-	-	-
	BT65D8436	540	568	83.75	-	-	-	-	-

**DIMENSION KEY**

W – width  
D – depth  
H – height of worksurface  
KW – kneehole width

Dimensions are in inches and approximate.  
Contact Customer Service if dimensions are critical.

**CODE DESCRIPTION**



X41 - full height wood modesty  
X31 - 3/4 height wood modesty  
BT - bow top

**VENEER**

Latitude is available in Quarter Cut Walnut and Rift Cut Oak veneers, and each is priced in this price guide. Maple and Cherry are also available: for Flat Cut Maple or Cherry veneer, use Column 1 pricing; for Quarter Cut Maple or Cherry, use Column 2 pricing. Other veneers are also available on Latitude, please contact us for a quote.



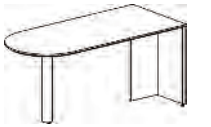

# LATITUDE | OPEN DESKS

Description	Model	Rift		W	D	H	KW	Shipping Weight	Cubic Feet
		Oak	Walnut						
 Rectangular Top, 4" Diameter Metal Leg	65DQ6030D8	2432	2553	59.75	30	29.5	42	117	39.25
	65DQ6630D8	2658	2790	65.75	30	29.5	48	126	42.75
	65DQ6636D8	2681	2815	65.75	36	29.5	48	146	50
	65DQ7230D8	2701	2837	71.75	30	29.5	54	132	46.5
	65DQ7236D8	2764	2903	71.75	36	29.5	54	155	54.75
	65DQ7830D8	2794	2934	77.75	30	29.5	60	141	50
	65DQ7836D8	2808	2949	77.75	36	29.5	60	163	59
	65DQ8430D8	2824	2965	83.75	30	29.5	66	154	53.75
	65DQ8436D8	2863	3008	83.75	36	29.5	66	178	63
 Arc End Top, 4" Diameter Metal Leg	65DA6030D8	2533	2660	59.75	30	29.5	42	117	39.25
	65DA6630D8	2768	2906	65.75	30	29.5	48	126	42.75
	65DA6636D8	2791	2932	65.75	36	29.5	48	146	50
	65DA7230D8	2816	2956	71.75	30	29.5	54	132	46.5
	65DA7236D8	2880	3024	71.75	36	29.5	54	155	54.75
	65DA7830D8	2910	3056	77.75	30	29.5	60	141	50
	65DA7836D8	2927	3073	77.75	36	29.5	60	163	59
	65DA8430D8	2942	3090	83.75	30	29.5	66	154	53.75
	65DA8436D8	2984	3133	83.75	36	29.5	66	178	63
 Bullet Top, 4" Diameter Metal Leg	65DB6030D8	2716	2852	59.75	30	29.5	42	117	39.25
	65DB6630D8	2768	2906	65.75	30	29.5	48	126	42.75
	65DB6636D8	2791	2932	65.75	36	29.5	54	146	50
	65DB7230D8	2816	2956	71.75	30	29.5	54	132	46.5
	65DB7236D8	2880	3024	71.75	36	29.5	60	155	54.75
	65DB7830D8	2910	3056	77.75	36	29.5	60	141	50
	65DB7836D8	2927	3073	77.75	30	29.5	66	163	59
	65DB8430D8	2942	3090	83.75	36	29.5	66	154	53.75
	65DB8436D8	3014	3164	83.75	30	29.5	66	178	63

**ORDERING NOTES:** Open Desks with 4" metal leg (D8) support are not stand alone cases. They must be used in conjunction with returns or linking units. To specify optional bases on Open Desks see option chart below, replace "D8" in the model number with suffix below and add list upcharge. See page 531 for Modesty Panel options. Left or right designation MUST be specified when specifying a modesty panel. Designate by adding left (L) or by adding right (R) after the item size in the item number. i.e. 65DQ6030D8LV21

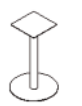
## OPEN DESK BASE OPTION UPCHARGES

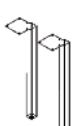
Description	Model	List	Added Weight	Description	Model	Rift		Added Weight
						Oak	Walnut	
 Disc Base	DB	189	30	Gable Base For Rectangular tops	GB	481	507	20
 Square Plate Base	SQ	226	30	O-Base For Rectangular tops	OB	643		18
 2 - 2" Square Metal Legs For Rectangular tops	M	565	19					

## ORDERING PROCEDURE

- To order, please specify the following:
- 1) Krug product model number
  - 2) Wood species and finish
  - 3) Grommet location and style if applicable.
  - 4) Base option if applicable.
  - 5) Modesty Panel option if applicable.

\*Indicates model illustrated by line drawing.

## CODE DESCRIPTION

- V21 - 1/2 height floating wood modesty
- V24 - 1/2 height floating back-painted glass modesty
- V29 - 1/2 height floating acrylic modesty





## STANDARD FINISHES

For a complete list of standard wood finishes, please see page 518.

## GROMMETS

One grommet in a standard position is optional at no charge. See page 521 for more information.

LATITUDE | OPEN DESK MODESTY PANELS

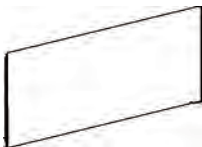
Description	Model	Rift		W	D	H	Shipping Weight
		Oak	Walnut				
1/2 Height Floating Wood Modesty 	V21-30	288	302	29.75	0.75	12	6
	V21-36	297	312	35.75	0.75	12	6
	V21-42	306	321	41.75	0.75	12	8
	V21-48	317	331	47.75	0.75	12	9
	V21-54	326	343	53.75	0.75	12	10
	V21-60	336	352	59.75	0.75	12	11
	V21-66	354	372	65.75	0.75	12	12
	V21-72	396	415	71.75	0.75	12	14
	V21-78	455	479	77.75	0.75	12	15
	V21-84	592	622	83.75	0.75	12	16
1/2 Height Floating Palette Modesty 	V22-30	288		29.75	0.75	12	6
	V22-36	297		35.75	0.75	12	6
	V22-42	306		41.75	0.75	12	8
	V22-48	317		47.75	0.75	12	9
	V22-54	326		53.75	0.75	12	10
	V22-60	336		59.75	0.75	12	11
	V22-66	354		65.75	0.75	12	12
	V22-72	396		71.75	0.75	12	14
	V22-78	455		77.75	0.75	12	15
	V22-84	592		83.75	0.75	12	16
1/2 Height Floating Back-painted Glass Modesty 	V24-30	919		29.75	0.75	12	10
	V24-36	948		35.75	0.75	12	11
	V24-42	977		41.75	0.75	12	12
	V24-48	1006		47.75	0.75	12	13
	V24-54	1038		53.75	0.75	12	14
	V24-60	1068		59.75	0.75	12	15
	V24-66	1116		65.75	0.75	12	16
	V24-72	1162		71.75	0.75	12	18
	V24-78	1205		77.75	0.75	12	19
	V24-84	1266		83.75	0.75	12	20
1/2 Height Floating Acrylic Modesty 	V29-30	542		29.75	0.75	12	4
	V29-36	560		35.75	0.75	12	5
	V29-42	577		41.75	0.75	12	6
	V29-48	596		47.75	0.75	12	7
	V29-54	614		53.75	0.75	12	8
	V29-60	633		59.75	0.75	12	9
	V29-66	664		65.75	0.75	12	10
	V29-72	694		71.75	0.75	12	12
	V29-78	723		77.75	0.75	12	13
	V29-84	768		83.75	0.75	12	14
Full Height Fixed Wood Modesty 	X41-42	612	642	41.75	0.75	12	10
	X41-48	630	662	47.75	0.75	12	15
	X41-54	648	681	53.75	0.75	12	18
	X41-60	670	703	59.75	0.75	29	20
	X41-66	708	744	65.75	0.75	29	24
	X41-72	791	832	71.75	0.75	29	26
	X41-78	910	956	77.75	0.75	29	30
	X41-84	1185	1245	83.75	0.75	29	36

**ORDERING NOTES:** Full height fixed wood modesty is available on Rectangular Open Desks with O-base.

**DIMENSION KEY**

- W – width
- D – depth
- H – height of worksurface
- KW – kneehole width

Dimensions are in inches and approximate. Contact Customer Service if dimensions are critical.



**CODE DESCRIPTION**

- V21 - 1/2 height floating wood modesty
- V22 - 1/2 height floating palette modesty
- V24 - 1/2 height floating back-painted glass modesty
- V29 - 1/2 height floating acrylic modesty
- X41 - full height fixed wood modesty





**VENEER**

Latitude is available in Quarter Cut Walnut and Rift Cut Oak veneers, and each is priced in this price guide. Maple and Cherry are also available: for Flat Cut Maple or Cherry veneer, use Column 1 pricing; for Quarter Cut Maple or Cherry, use Column 2 pricing. Other veneers are also available on Latitude, please contact us for a quote.

# LATITUDE | TABLE DESKS & MODESTY PANELS

Description	Model	Rift		W	D	H	KW	Shipping Weight	Cubic Feet
		Oak	Walnut						
 Table Desk with "O" Base	65TD6030OB	4772	5010	59.75	30	29.5	56	177	41
	65TD6036OB*	4895	5140	59.75	30	29.5	56	190	41
	65TD6630OB	4986	5235	65.75	30	29.5	64	198	45.75
	65TD6636OB	5308	5574	65.75	36	29.5	64	198	45.75
	65TD7230OB	5210	5470	71.75	30	29.5	70	228	54
	65TD7236OB	5536	5812	71.75	36	29.5	70	228	54
	65TD7830OB	5453	5726	77.75	30	29.5	76	241	58.5
	65TD7836OB	5785	6075	77.75	36	29.5	76	241	58.5
	65TD8430OB	5632	5913	83.75	30	29.5	82	254	63
	65TD8436OB	5972	6271	83.75	36	29.5	82	254	63
 Table Desk with Glass Top & "O" Base	65TDGP6030OB	7110		59.75	30	29.5	56	177	41
	65TDGP6036OB*	7656		59.75	36	29.5	56	190	41
	65TDGP6630OB	7534		65.75	30	29.5	64	198	45.75
	65TDGP6636OB	8325		65.75	36	29.5	64	198	45.75
	65TDGP7230OB	8012		71.75	30	29.5	70	228	54
	65TDGP7236OB	8845		71.75	36	29.5	70	228	54
	65TDGP7830OB	8470		77.75	30	29.5	76	211	58.5
	65TDGP7836OB	9351		77.75	36	29.5	76	211	58.5
	65TDGP8430OB	8864		83.75	30	29.5	82	254	63
	65TDGP8436OB	9791		83.75	36	29.5	82	254	63

**ORDERING NOTES:** To specify optional modesty panels on Table Desks see below, add the model suffix and list upcharge.

 1/2 Ht Fixed Wood Modesty	X21-60	336	352	59.75	0.75	12	17
	X21-66	354	372	65.75	0.75	12	19
	X21-72	396	415	71.75	0.75	12	21
	X21-78	455	479	77.75	0.75	12	23
	X21-84	592	622	83.75	0.75	12	24
 Full Ht Fixed Wood Modesty	X41-60	670	703	59.75	0.75	29	41
	X41-66	708	744	65.75	0.75	29	45
	X41-72	791	832	71.75	0.75	29	50
	X41-78	910	956	77.75	0.75	29	54
	X41-84	1185	1245	83.75	0.75	29	58
 1/2 Ht Fixed Glass Modesty	X24-60	1068		59.75	0.75	12	34
	X24-66	1116		65.75	0.75	12	38
	X24-72	1162		71.75	0.75	12	42
	X24-78	1205		77.75	0.75	12	46
	X24-84	1266		83.75	0.75	12	48
 Full Ht Fixed Glass Modesty	X44-60	2139		59.75	0.75	29	82
	X44-66	2230		65.75	0.75	29	90
	X44-72	2322		71.75	0.75	29	100
	X44-78	2410		77.75	0.75	29	108
	X44-84	2531		83.75	0.75	29	116

## ORDERING PROCEDURE

To order, please specify the following:

- 1) Krug product model number
- 2) Wood species and finish
- 3) Grommet location and style if applicable
- 4) Base option if applicable
- 5) Modesty Panel option if applicable

\* Indicates model illustrated by line drawing

## CODE DESCRIPTION

OB - O base  
 X21 - 1/2 height fixed wood modesty  
 X41 - full height fixed wood modesty  
 X24 - 1/2 height fixed glass Modesty  
 X44 - full height fixed glass modesty

## STANDARD FINISHES

For a complete list of standard wood finishes, please see page 518.

## GROMMETS

One grommet in a standard position is optional at no charge. See page 521 for more information.

# LATITUDE | TABLE DESKS & MODESTY PANELS

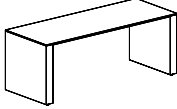
Description	Model	Rift		W	D	H	KW	Shipping Weight	Cubic Feet
		Oak	Walnut						
 Table Desk with 4" Rectangular Gables	65TD6030	2405	2524	59.75	30	29.5	56	177	41
	65TD6036	2883	3029	59.75	30	29.5	56	190	41
	65TD6630	2643	2778	65.75	30	29.5	64	198	45.75
	65TD6636	3172	3330	65.75	36	29.5	64	198	45.75
	65TD7230	2883	3029	71.75	30	29.5	70	228	54
	65TD7236	3371	3539	71.75	36	29.5	70	228	54
	65TD7830	3043	3194	77.75	30	29.5	76	241	58.5
	65TD7836	3428	3598	77.75	36	29.5	76	241	58.5
	65TD8430	3376	3543	83.75	30	29.5	82	254	63
	65TD8436	3487	3661	83.75	36	29.5	82	254	63

**ORDERING NOTES:** To specify optional modesty panels on Table Desks see below, add the model suffix and list upcharge.

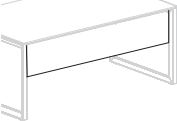
 1/2 Height Floating Wood Modesty	V21-60	336	352	59.75	0.75	12	11
	V21-66	354	372	65.75	0.75	12	12
	V21-72	396	415	71.75	0.75	12	14
	V21-78	455	479	77.75	0.75	12	15
	V21-84	592	622	83.75	0.75	12	16

 1/2 Height Floating Palette Modesty	V22-60	336		59.75	0.75	12	11
	V22-66	354		65.75	0.75	12	12
	V22-72	396		71.75	0.75	12	14
	V22-78	455		77.75	0.75	12	15
	V22-84	592		83.75	0.75	12	16

 1/2 Height Floating Back-painted Glass Modesty	V24-60	1068		59.75	0.75	12	15
	V24-66	1116		65.75	0.75	12	16
	V24-72	1162		71.75	0.75	12	18
	V24-78	1205		77.75	0.75	12	19
	V24-84	1266		83.75	0.75	12	20

 1/2 Height Floating Acrylic Modesty	V29-60	633		59.75	0.75	12	9
	V29-66	664		65.75	0.75	12	10
	V29-72	694		71.75	0.75	12	12
	V29-78	723		77.75	0.75	12	13
	V29-84	768		83.75	0.75	12	14

**DIMENSION KEY**

W — width  
 D — depth  
 H — height of worksurface  
 KW — kneehole width

Dimensions are in inches and approximate. Contact Customer Service if dimensions are critical.

**CODE DESCRIPTION**

V21 - 1/2 height floating wood modesty  
 V22 - 1/2 height floating palette modesty  
 V24 - 1/2 height floating back-painted glass modesty  
 V29 - 1/2 height floating acrylic modesty

**VENEER**

Latitude is available in Quarter Cut Walnut and Rift Cut Oak veneers, and each is priced in this price guide. Maple and Cherry are also available: for Flat Cut Maple or Cherry veneer, use Column 1 pricing; for Quarter Cut Maple or Cherry, use Column 2 pricing. Other veneers are also available on Latitude, please contact us for a quote.

# LATITUDE | TABLE DESKS & MODESTY PANELS

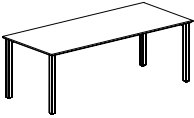
Description	Model	Rift		W	D	H	KW	Shipping Weight	Cubic Feet
		Oak	Walnut						
 Table Desk with 2" Square Metal Leg	65TD6030M	2170	2278	59.75	30	29.5	56	177	41
	65TD6036M	2605	2734	59.75	30	29.5	56	190	41
	65TD6630M	2387	2507	65.75	30	29.5	64	198	45.75
	65TD6636M	2865	3008	65.75	36	29.5	64	198	45.75
	65TD7230M	2605	2734	71.75	30	29.5	70	228	54
	65TD7236M	3054	3206	71.75	36	29.5	70	228	54
	65TD7830M	3041	3195	77.75	30	29.5	76	241	58.5
	65TD7836M	3109	3264	77.75	36	29.5	76	241	58.5
	65TD8430M	3094	3249	83.75	30	29.5	82	254	63
	65TD8436M	3162	3320	83.75	36	29.5	82	254	63

**ORDERING NOTES:** To specify optional modesty panels on Table Desks see below, add the model suffix and list upcharge.

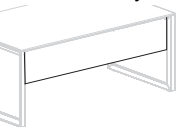
 1/2 Height Floating Wood Modesty	V21-60	336	352	59.75	0.75	12	11
	V21-66	354	372	65.75	0.75	12	12
	V21-72	396	415	71.75	0.75	12	14
	V21-78	455	479	77.75	0.75	12	15
	V21-84	592	622	83.75	0.75	12	16

 1/2 Height Floating Palette Modesty	V22-60	336		59.75	0.75	12	11
	V22-66	354		65.75	0.75	12	12
	V22-72	396		71.75	0.75	12	14
	V22-78	455		77.75	0.75	12	15
	V22-84	592		83.75	0.75	12	16

 1/2 Height Floating Back-painted Glass Modesty	V24-60	1068		59.75	0.75	12	15
	V24-66	1116		65.75	0.75	12	16
	V24-72	1162		71.75	0.75	12	18
	V24-78	1205		77.75	0.75	12	19
	V24-84	1266		83.75	0.75	12	20

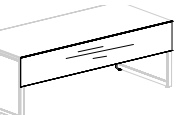
 1/2 Height Floating Acrylic Modesty	V29-60	633		59.75	0.75	12	9
	V29-66	664		65.75	0.75	12	10
	V29-72	694		71.75	0.75	12	12
	V29-78	723		77.75	0.75	12	13
	V29-84	768		83.75	0.75	12	14

## ORDERING PROCEDURE

To order, please specify the following:

- 1) Krug product model number
- 2) Wood species and finish
- 3) Grommet location and style if applicable.
- 4) Base option if applicable.
- 5) Modesty Panel option if applicable.

\* Indicates model illustrated by line drawing

## CODE DESCRIPTION

- V21 - 1/2 height floating wood modesty
- V22 - 1/2 height floating palette modesty
- V24 - 1/2 height floating back-painted glass modesty
- V29 - 1/2 height floating acrylic modesty

## STANDARD FINISHES

For a complete list of standard wood finishes, please see page 518.

## GROMMETS

One grommet in a standard position is optional at no charge. See page 521 for more information.

# LATITUDE | HEIGHT ADJUSTABLE DESK WORKSURFACES

Description	Model	Rift		W	D	H	KW	Shipping Weight	Cubic Feet
		Oak	Walnut						
Electronic Height Adjustable Worksurfaces T-Base 	65HA3024ETS	2978	3127	29.75	24	-	17	108.5	11.5
	65HA3624ETS	3059	3214	35.75	24	-	23	109	14
	65HA4224ETS	3118	3273	41.75	24	-	29	109	16.5
	65HA4824ETS	3184	3342	47.75	24	-	35	109.5	19
	65HA5424ETS	3224	3386	53.5	24	-	41	110	21.5
	65HA6024ETS	3313	3478	59.75	24	-	47	111	24
	65HA6624ETS	3546	3724	65.75	24	-	53	114	26.5
	65HA7224ETS	3714	3902	71.75	24	-	59	119.5	29
	65HA7824ETS	3840	4030	77.75	24	-	65	122.5	31.5
	65HA8424ETS	3914	4110	83.75	24	-	71	127	34
	65HA3030ETS	3115	3270	29.75	30	-	17	121.5	36.75
	65HA3630ETS	3192	3353	35.75	30	-	23	122	14.25
	65HA4230ETS	3246	3409	41.75	30	-	29	122	17.5
	65HA4830ETS	3315	3481	47.75	30	-	35	122.5	20.5
	65HA5430ETS	3379	3547	53.5	30	-	41	123	23.5
	65HA6030ETS*	3455	3627	59.75	30	-	47	124	26.5
	65HA6630ETS	3626	3809	65.75	30	-	53	131	29.75
	65HA7230ETS	3788	3978	71.75	30	-	59	132.5	32.75
	65HA7830ETS	3920	4116	77.75	30	-	65	142.5	35.75
	65HA8430ETS	3997	4197	83.75	30	-	71	143.5	38.75
	65HA3036ETS	3307	3472	29.75	36	-	17	121.5	42
	65HA3636ETS	3360	3530	35.75	36	-	23	122	45.5
	65HA4236ETS	3409	3580	41.75	36	-	29	122	17.25
	65HA4836ETS	3505	3680	47.75	36	-	35	122.5	20.75
	65HA5436ETS	3577	3756	53.5	36	-	41	123	24.5
	65HA6036ETS	3644	3827	59.75	36	-	47	124	28.25
	65HA6636ETS	3786	3975	65.75	36	-	53	134	32
	65HA7236ETS	3911	4108	71.75	36	-	59	151.5	35.5
65HA7836ETS	4219	4429	77.75	36	-	65	158.5	39.25	
65HA8436ETS	4311	4527	83.75	36	-	71	159.5	43	

**ORDERING NOTES:**

To order a Height Adjustable return or link unit worksurface (cross grain direction) add "RH" to the model number before the "ETS" e.g. 65HA8436RHETS

Height adjustable worksurfaces, 48" or longer, are available with an optional 16" overhang at one end, add "O16" after "ETS" in the model number. e.g. 65HA8436ETSO16

Standard base is a T-base. To order a C-base on worksurfaces, up to 30" deep only, replace "T" with "C" e.g. 65HA8430ECS

To specify optional modesty panels add the model suffix and list upcharge shown on page 532.

To order dual stage height adjustable base replace "ETS" with "ETD" and add **\$674 list**. e.g. 65HA8436ETD

Height Adjustable bases come standard with a Silver up/down button. Please contact customer service for alternate color availability. A 4 position programmable display is available, see page 557 for list price.

Single stage height adjustable range 27 1/2"-46 1/4"

Dual stage height adjustable range 22 1/2"-48 1/4"

Power cord is 10 feet long.

**DIMENSION KEY**

W — width  
 D — depth  
 H — height of worksurface  
 KW— kneehole width

Dimensions are in inches and approximate. Contact Customer Service if dimensions are critical.

**CODE DESCRIPTION**

E - electric  
 T - T-base  
 S - single stage  
 RH - return or link unit (cross grain top)  
 O16- 16" overhang  
 C - C-base  
 D - dual stage

**VENEER**

Latitude is available in Quarter Cut Walnut and Rift Cut Oak veneers, and each is priced in this price guide. Maple and Cherry are also available: for Flat Cut Maple or Cherry veneer, use Column 1 pricing; for Quarter Cut Maple or Cherry, use Column 2 pricing. Other veneers are also available on Latitude, please contact us for a quote.

# LATITUDE | HEIGHT ADJUSTABLE WORKSURFACES

Description	Model	Rift		W	D	H	KW	Shipping Weight	Cubic Feet
		Oak	Walnut						
Electronic Height Adjustable Worksurfaces, Base Enclosures 	65HA4224ETSG	5176	5436	41.75	24	-	24	154	16.5
	65HA4824ETSG	5244	5507	47.75	24	-	30	154.5	19
	65HA5424ETSG	5289	5556	53.5	24	-	36	155	21.5
	65HA6024ETSG	5378	5646	59.75	24	-	42	156	24
	65HA6624ETSG	5620	5903	65.75	24	-	48	159	26.5
	65HA7224ETSG	5792	6081	71.75	24	-	54	164.5	29
	65HA7824ETSG	5918	6214	77.75	24	-	60	167.5	31.5
	65HA8424ETSG	5998	6297	83.75	24	-	66	172	34
	65HA4230ETSG	5546	5823	41.75	30	-	24	177	17.5
	65HA4830ETSG	5616	5897	47.75	30	-	30	177.5	20.5
	65HA5430ETSG	5679	5964	53.5	30	-	36	178	23.5
	65HA6030ETSG	5757	6045	59.75	30	-	42	179	26.5
	65HA6630ETSG	5936	6232	65.75	30	-	48	186	29.75
	65HA7230ETSG	6102	6406	71.75	30	-	54	187.5	32.75
	65HA7830ETSG	6237	6548	77.75	30	-	60	197.5	35.75
	65HA8430ETSG	6544	6871	83.75	30	-	66	198.5	38.75
	65HA4236ETSG	5939	6235	41.75	36	-	24	187	17.25
	65HA4836ETSG	6035	6337	47.75	36	-	30	187.5	20.75
	65HA5436ETSG	6109	6416	53.5	36	-	36	188	24.5
	65HA6036ETSG	6181	6490	59.75	36	-	42	189	28.25
65HA6636ETSG	6328	6644	65.75	36	-	48	199	32	
65HA7236ETSG	6229	6541	71.75	36	-	54	216.5	35.5	
65HA7836ETSG	6772	7110	77.75	36	-	60	223.5	39.25	
65HA8436ETSG	6867	7210	83.75	36	-	66	224.5	43	

## ORDERING NOTES:

To order a Height Adjustable return or link unit work surface (cross grain direction) add "RH" to the model number before the "ETS" e.g. 65HA8436RHETSG

Height adjustable work surfaces, 48" or longer, are available with an optional 16" overhang at one end, add "O16" after "ETS" in the model number. e.g. 65HA8436ETSO16G

To order dual stage height adjustable base replace "ETS" with "ETD" and add **\$674 list**. e.g. 65HA8436ETDGG

To specify optional modesty panels add the model suffix and list upcharge shown on page 532. To allow clearance for Base Enclosures order modesty 3 sizes smaller. e.g. 72" work surface - order a 54" modesty.

Height Adjustable bases come standard with a Silver up/down button. Please contact customer service for alternate color availability. A 4 position programmable display is available, see page 557 for list price.

Single stage height adjustable range 28 3/8"-47 1/4"  
 Dual stage height adjustable range 23 7/16"-49 7/16"  
 Power cord is 10 feet long.

## ORDERING PROCEDURE

- To order, please specify the following:
- 1) Krug product model number
  - 2) Wood species and finish
  - 3) Grommet location and style if applicable.
  - 4) Base option if applicable.
  - 5) Modesty Panel option if applicable.

\* Indicates model illustrated by line drawing

## CODE DESCRIPTION

- E - electric
- T - T-base
- S - single stage
- G - base enclosure
- RH - return or link unit (cross grain top)
- O16 - 16" overhang
- C - C-base
- D - dual stage

## STANDARD FINISHES

For a complete list of standard wood finishes, please see page 518.

## GROMMETS

One grommet in a standard position is optional at no charge. See page 521 for more information.

# LATITUDE | HEIGHT ADJUSTABLE RETURN WORKSURFACES

Description	Model	Rift		W	D	H	KW	Shipping Weight	Cubic Feet
		Oak	Walnut						
Electronic Height	65HA4824RHETS	3184	3342	47.75	24	-	35	109.5	19
Adjustable Return	65HA5424RHETS	3224	3386	53.5	24	-	41	110	21.5
Worksurfaces T-Base 	65HA6024RHETS	3313	3478	59.75	24	-	47	111	24
	65HA6624RHETS	3546	3724	65.75	24	-	53	114	26.5
	65HA7224RHETS	3714	3902	71.75	24	-	59	119.5	29
	65HA7824RHETS	3840	4030	77.75	24	-	65	122.5	31.5
	65HA8424RHETS	3914	4110	83.75	24	-	71	127	34
	65HA4830RHETS	3315	3481	47.75	30	-	35	122.5	20.5
	65HA5430RHETS	3379	3547	53.5	30	-	41	123	23.5
	65HA6030RHETS*	3455	3627	59.75	30	-	47	124	26.5
	65HA6630RHETS	3626	3809	65.75	30	-	53	131	29.75
	65HA7230RHETS	3788	3978	71.75	30	-	59	132.5	32.75
	65HA7830RHETS	3920	4116	77.75	30	-	65	142.5	35.75
	65HA8430RHETS	3997	4197	83.75	30	-	71	143.5	38.75
	65HA4836RHETS	3505	3680	47.75	36	-	35	122.5	20.75
	65HA5436RHETS	3577	3756	53.5	36	-	41	123	24.5
	65HA6036RHETS	3644	3827	59.75	36	-	47	124	28.25
	65HA6636RHETS	3786	3975	65.75	36	-	53	134	32
65HA7236RHETS	3911	4108	71.75	36	-	59	151.5	35.5	
65HA7836RHETS	4219	4429	77.75	36	-	65	158.5	39.25	
65HA8436RHETS	4311	4527	83.75	36	-	71	159.5	43	

**ORDERING NOTES:**

To order a Height Adjustable return or link unit work surface (cross grain direction) add "RH" to the model number before the "ETS" e.g. 65HA8436RHETS

Height adjustable work surfaces, 48" or longer, are available with an optional 16" overhang at one end, add "O16" after "ETS" in the model number. e.g. 65HA8436ETSO16

Standard base is a T-base. To order a C-base on work surfaces, up to 30" deep only, replace "T" with "C" e.g. 65HA8430ECS

To specify optional modesty panels add the model suffix and list upcharge shown on page 532.

To order dual stage height adjustable base replace "ETS" with "ETD" and add **\$674 list**. e.g. 65HA8436ETD

Height Adjustable bases come standard with a Silver up/down button. Please contact customer service for alternate color availability. A 4 position programmable display is available, see page 557 for list price.

Single stage height adjustable range 27 1/2"-46 1/4"

Dual stage height adjustable range 22 1/2"-48 1/4"

Power cord is 10 feet long.

**DIMENSION KEY**

W — width  
 D — depth  
 H — height of work surface  
 KW— kneehole width

Dimensions are in inches and approximate.  
 Contact Customer Service if dimensions are critical.

**CODE DESCRIPTION**

RH - return (cross grain)  
 E - electric  
 T- T-base  
 S- single stage  
 O16 - 16" overhang  
 C - C-base  
 D - dual stage

**VENEER**

Latitude is available in Quarter Cut Walnut and Rift Cut Oak veneers, and each is priced in this price guide. Maple and Cherry are also available: for Flat Cut Maple or Cherry veneer, use Column 1 pricing; for Quarter Cut Maple or Cherry, use Column 2 pricing. Other veneers are also available on Latitude, please contact us for a quote.



# LATITUDE | HEIGHT ADJUSTABLE RETURN WORKSURFACES

Description	Model	Rift		W	D	H	KW	Shipping Weight	Cubic Feet
		Oak	Walnut						
Electronic Height Adjustable Return	65HA4824RHETSG	5244	5507	47.75	24	-	30	154.5	19
Worksurfaces, Base Enclosures	65HA5424RHETSG	5289	5556	53.5	24	-	36	155	21.5
	65HA6024RHETSG	5378	5646	59.75	24	-	42	156	24
	65HA6624RHETSG	5620	5903	65.75	24	-	48	159	26.5
	65HA7224RHETSG	5792	6081	71.75	24	-	54	164.5	29
	65HA7824RHETSG	5918	6214	77.75	24	-	60	167.5	31.5
	65HA8424RHETSG	5998	6297	83.75	24	-	66	172	34
	65HA4830RHETSG	5616	5897	47.75	30	-	30	177.5	20.5
	65HA5430RHETSG	5679	5964	53.5	30	-	36	178	23.5
	65HA6030RHETSG	5757	6045	59.75	30	-	42	179	26.5
	65HA6630RHETSG	5936	6232	65.75	30	-	48	186	29.75
	65HA7230RHETSG	6102	6406	71.75	30	-	54	187.5	32.75
	65HA7830RHETSG	6237	6548	77.75	30	-	60	197.5	35.75
	65HA8430RHETSG	6544	6871	83.75	30	-	66	198.5	38.75
	65HA4836RHETSG	6035	6337	47.75	36	-	30	187.5	20.75
	65HA5436RHETSG	6109	6416	53.5	36	-	36	188	24.5
	65HA6036RHETSG	6181	6490	59.75	36	-	42	189	28.25
65HA6636RHETSG	6328	6644	65.75	36	-	48	199	32	
65HA7236RHETSG	6229	6541	71.75	36	-	54	216.5	35.5	
65HA7836RHETSG	6772	7110	77.75	36	-	60	223.5	39.25	
65HA8436RHETSG	6867	7210	83.75	36	-	66	224.5	43	



## ORDERING NOTES:

To order a Height Adjustable return or link unit work surface (cross grain direction) add "RH" to the model number before the "ETS" e.g. 65HA8436RHETSG

Height adjustable work surfaces, 48" or longer, are available with an optional 16" overhang at one end, add "O16" after "ETS" in the model number. e.g. 65HA8436ETSO16G

To order dual stage height adjustable base replace "ETS" with "ETD" and add **\$674 list**. e.g. 65HA8436ETD

To specify optional modesty panels add the model suffix and list upcharge shown on page 532. To allow clearance for Base Enclosures order modesty 3 sizes smaller. e.g. 72" work surface - order a 54" modesty.

Height Adjustable bases come standard with a Silver up/down button. Please contact customer service for alternate color availability. A 4 position programmable display is available, see page 557 for list price.

Single stage height adjustable range 28 3/8"-47 1/4"

Dual stage height adjustable range 23 7/16"-49 7/16"

Power cord is 10 feet long.

## ORDERING PROCEDURE

To order, please specify the following:

- 1) Krug product model number
- 2) Wood species and finish
- 3) Grommet location and style if applicable.
- 4) Base option if applicable.
- 5) Modesty Panel option if applicable.

\* Indicates model illustrated by line drawing

## CODE DESCRIPTION

HA - height adjustable  
 RH - return (cross grain)  
 E - electric  
 T - T- base  
 C - C- base  
 S - single stage  
 D - dual stage





## STANDARD FINISHES

For a complete list of standard wood finishes, please see page 518.

## GROMMETS

One grommet in a standard position is optional at no charge. See page 521 for more information.

# LATITUDE | MODESTY PANELS FOR HEIGHT ADJUSTABLE WORKSURFACES WITH BASE ENCLOSURES

Description	Model	Rift		W	D	H	Shipping Weight
		Oak	Walnut				
1/2 Height Floating Wood Modesty 	V21-48	297	312	47.75	0.75	12	9
	V21-54	306	321	53.75	0.75	12	10
	V21-60	317	331	59.75	0.75	12	11
	V21-66	326	343	65.75	0.75	12	12
	V21-72	336	352	71.75	0.75	12	14
	V21-78	354	372	77.75	0.75	12	15
	V21-84	396	415	83.75	0.75	12	16
1/2 Height Floating Palette Modesty 	V22-48	297		47.75	0.75	12	9
	V22-54	306		53.75	0.75	12	10
	V22-60	317		59.75	0.75	12	11
	V22-66	326		65.75	0.75	12	12
	V22-72	336		71.75	0.75	12	14
	V22-78	354		77.75	0.75	12	15
	V22-84	396		83.75	0.75	12	16
1/2 Height Floating Back-painted Glass Modesty 	V24-48	948		47.75	0.75	12	13
	V24-54	977		53.75	0.75	12	14
	V24-60	1006		59.75	0.75	12	15
	V24-66	1038		65.75	0.75	12	16
	V24-72	1068		71.75	0.75	12	18
	V24-78	1116		77.75	0.75	12	19
	V24-84	1162		83.75	0.75	12	20
1/2 Height Floating Acrylic Modesty 	V29-48	560		47.75	0.75	12	7
	V29-54	577		53.75	0.75	12	8
	V29-60	596		59.75	0.75	12	9
	V29-66	614		65.75	0.75	12	10
	V29-72	633		71.75	0.75	12	12
	V29-78	664		77.75	0.75	12	13
	V29-84	694		83.75	0.75	12	14
Full Height Fixed Wood Modesty 	X41-48	592	622	47.75	0.75	12	15
	X41-54	612	642	53.75	0.75	12	18
	X41-60	630	662	59.75	0.75	29	20
	X41-66	648	681	65.75	0.75	29	24
	X41-72	670	703	71.75	0.75	29	26
	X41-78	708	744	77.75	0.75	29	30
	X41-84	791	832	83.75	0.75	29	36

**DIMENSION KEY**

W – width  
 D – depth  
 H – height of worksurface  
 KW – kneehole width

Dimensions are in inches and approximate. Contact Customer Service if dimensions are critical.

**CODE DESCRIPTION**

V21 - 1/2 height floating wood modesty  
 V22 - 1/2 height floating palette modesty  
 V24 - 1/2 height floating back-painted glass modesty  
 V29 - 1/2 height floating acrylic modesty  
 X41 - full height fixed wood modesty

**VENEER**

Latitude is available in Quarter Cut Walnut and Rift Cut Oak veneers, and each is priced in this price guide. Maple and Cherry are also available: for Flat Cut Maple or Cherry veneer, use Column 1 pricing; for Quarter Cut Maple or Cherry, use Column 2 pricing. Other veneers are also available on Latitude, please contact us for a quote.

# LATITUDE | DESK RUNOFFS

Description	Model	Rift		W	D	H	KW	Shipping Weight	Cubic Feet
		Oak	Walnut						
Rectangular Desk	65DR48304LD8	1734	1821	47.75	30	29.5	30.75	58	8.5
Runoffs, 4" Dia.	65DR48304RD8	1734	1821	47.75	30	29.5	30.75	58	8.5
Metal Leg	65DR48364LD8	1748	1835	47.75	36	29.5	27.75	66	9.5
	65DR48364RD8	1748	1835	47.75	36	29.5	27.75	66	9.5
	65DR54304LD8	1761	1852	53.75	30	29.5	36.75	63	9
	65DR54304RD8	1761	1852	53.75	30	29.5	36.75	63	9
	65DR54364LD8	1773	1861	53.75	36	29.5	33.75	71	10.5
	65DR54364RD8	1773	1861	53.75	36	29.5	33.75	71	10.5
	65DR60304LD8	1788	1878	59.75	30	29.5	42.75	68	10
	65DR60304RD8	1788	1878	59.75	30	29.5	42.75	68	10
	65DR60364LD8	1801	1890	59.75	36	29.5	39.75	77	11.5
	65DR60364RD8	1801	1890	59.75	36	29.5	39.75	77	11.5
	65DR66304LD8	1811	1902	65.75	30	29.5	48.75	99	10.75
	65DR66304RD8	1811	1902	65.75	30	29.5	48.75	99	10.75
	65DR66364LD8	1836	1928	65.75	36	29.5	45.75	88	12.5
	65DR66364RD8	1836	1928	65.75	36	29.5	45.75	88	12.5
	65DR72304LD8	1884	1979	71.75	30	29.5	54.75	104	11.5
	65DR72304RD8	1884	1979	71.75	30	29.5	54.75	104	11.5
	65DR72364LD8	1932	2029	71.75	36	29.5	51.75	95	13.5
	65DR72364RD8	1932	2029	71.75	36	29.5	51.75	95	13.5
	65DR78304LD8	1941	2037	77.75	30	29.5	56.75	58	8.5
	65DR78304RD8	1941	2037	77.75	30	29.5	56.75	58	8.5
	65DR78364LD8	1989	2088	77.75	36	29.5	56.75	66	9.5
	65DR78364RD8	1989	2088	77.75	36	29.5	56.75	66	9.5
	65DR84304LD8	1999	2100	83.75	30	29.5	66.75	114	13
	65DR84304RD8	1999	2100	83.75	30	29.5	66.75	114	13
	65DR84364LD8	2048	2149	83.75	36	29.5	63.75	108	15
	65DR84364RD8	2048	2149	83.75	36	29.5	63.75	108	15

**ORDERING NOTES:** To specify optional bases on desk Runoffs see option chart, replace "D8" in the model number with model suffix below and add list upcharge. When specifying a modesty panel add -20 before modesty panel suffix when runoff is to be used with a 20" deep credenza, add -24 when runoff is to be used with a 24" deep credenza. See page 531 for Modesty Panel options.

## DESK RUNOFF BASE OPTION UPCHARGES

Description	Model	List	Added Weight	Description	Model	Rift		Added Weight
						Oak	Walnut	
Disc Base	DB	189	30	BBF Pedestal	4F	1672	1757	83
Square Plate Base	SQ	226	30	FF Pedestal	4D	1449	1522	78
O-Base	OB	643	18	BF Pedestal	3F	1373	1440	54
2- 2" Square Metal Leg	M	565	19	Gable Base	GB	481	507	20
				4" Gable Base	4G	515	540	28

### ORDERING PROCEDURE

To order, please specify the following:

- 1) Krug product model number
- 2) Wood species and finish
- 3) Grommet location and style if applicable.
- 4) Base option if applicable.
- 5) Modesty Panel option if applicable.

### CODE DESCRIPTION

- 4 - Full Height
- L - left hand position
- R - right hand position

### STANDARD FINISHES

For a complete list of standard wood finishes, please see page 518.

### GROMMETS

One grommet in a standard position is optional at no charge. See page 539 for more information.

\* Indicates model illustrated by line drawing  
544 | GSA | CASEGOODS

# LATITUDE | DESK RUNOFFS

Description	Model	Rift		W	D	H	KW	Shipping Weight	Cubic Feet
		Oak	Walnut						
Arc End Desk	65DRA48304LD8	1734	1821	47.75	30	29.5	30.75	58	8.5
Runoffs, 4" Dia.	65DRA48304RD8	1734	1821	47.75	30	29.5	30.75	58	8.5
Metal Leg	65DRA48364LD8	1748	1835	47.75	36	29.5	27.75	66	9.5
	65DRA48364RD8	1748	1835	47.75	36	29.5	27.75	66	9.5
	65DRA54304LD8	1761	1852	53.75	30	29.5	36.75	63	9
	65DRA54304RD8	1761	1852	53.75	30	29.5	36.75	63	9
	65DRA54364LD8	1773	1861	53.75	36	29.5	33.75	71	10.5
	65DRA54364RD8	1773	1861	53.75	36	29.5	33.75	71	10.5
	65DRA60304LD8	1788	1878	59.75	30	29.5	42.75	68	10
	65DRA60304RD8	1788	1878	59.75	30	29.5	42.75	68	10
	65DRA60364LD8	1801	1890	59.75	36	29.5	39.75	77	11.5
	65DRA60364RD8	1801	1890	59.75	36	29.5	39.75	77	11.5
	65DRA66304LD8	1811	1902	65.75	30	29.5	48.75	99	10.75
	65DRA66304RD8	1811	1902	65.75	30	29.5	48.75	99	10.75
	65DRA66364LD8	1836	1928	65.75	36	29.5	45.75	88	12.5
	65DRA66364RD8	1836	1928	65.75	36	29.5	45.75	88	12.5
	65DRA72304LD8	1884	1979	71.75	30	29.5	54.75	104	11.5
	65DRA72304RD8	1884	1979	71.75	30	29.5	54.75	104	11.5
	65DRA72364LD8	1932	2029	71.75	36	29.5	51.75	95	13.5
	65DRA72364RD8	1932	2029	71.75	36	29.5	51.75	95	13.5
	65DRA78304LD8	1941	2037	77.75	30	29.5	56.75	58	8.5
	65DRA78304RD8	1941	2037	77.75	30	29.5	56.75	58	8.5
	65DRA78364LD8	1989	2088	77.75	36	29.5	56.75	66	9.5
	65DRA78364RD8	1989	2088	77.75	36	29.5	56.75	66	9.5
	65DRA84304LD8	1999	2100	83.75	30	29.5	66.75	114	13
	65DRA84304RD8	1999	2100	83.75	30	29.5	66.75	114	13
	65DRA84364LD8	2048	2149	83.75	36	29.5	63.75	108	15
	65DRA84364RD8	2048	2149	83.75	36	29.5	63.75	108	15



**ORDERING NOTES:** To specify optional Disc base on desk Runoffs see option chart below, replace "D8" in the model number with model suffix below and add list upcharge. When specifying a modesty panel add -20 before modesty panel suffix when runoff is to be used with a 20" deep credenza, add -24 when runoff is to be used with a 24" deep credenza. See page 531 for Modesty Panel options.

### OPEN DESK BASE OPTION UPCHARGES

Description	Model	List	Added Weight
Disc Base	DB	189	30



### DIMENSION KEY

W — width  
 D — depth  
 H — height of worksurface  
 KW— kneehole width

Dimensions are in inches and approximate. Contact Customer Service if dimensions are critical.

### CODE DESCRIPTION

4 - full Height  
 L - left hand position  
 R - right hand position

### VENEER

Latitude is available in Quarter Cut Walnut and Rift Cut Oak veneers, and each is priced in this price guide. Maple and Cherry are also available: for Flat Cut Maple or Cherry veneer, use Column 1 pricing; for Quarter Cut Maple or Cherry, use Column 2 pricing. Other veneers are also available on Latitude, please contact us for a quote.

# LATITUDE | DESK RUNOFFS

Description	Model	Rift		W	D	H	KW	Shipping Weight	Cubic Feet
		Oak	Walnut						
 Bullet Desk Runoffs, 4" Dia. Metal Leg	65DRB48304LD8	1734	1821	47.75	30	29.5	30.75	58	8.5
	65DRB48304RD8	1734	1821	47.75	30	29.5	30.75	58	8.5
	65DRB48364LD8	1748	1835	47.75	36	29.5	27.75	66	9.5
	65DRB48364RD8	1748	1835	47.75	36	29.5	27.75	66	9.5
	65DRB54304LD8	1761	1852	53.75	30	29.5	36.75	63	9
	65DRB54304RD8	1761	1852	53.75	30	29.5	36.75	63	9
	65DRB54364LD8	1773	1861	53.75	36	29.5	33.75	71	10.5
	65DRB54364RD8	1773	1861	53.75	36	29.5	33.75	71	10.5
	65DRB60304LD8	1788	1878	59.75	30	29.5	42.75	68	10
	65DRB60304RD8	1788	1878	59.75	30	29.5	42.75	68	10
	65DRB60364LD8	1801	1890	59.75	36	29.5	39.75	77	11.5
	65DRB60364RD8	1801	1890	59.75	36	29.5	39.75	77	11.5
	65DRB66304LD8	1811	1902	65.75	30	29.5	48.75	99	10.75
	65DRB66304RD8	1811	1902	65.75	30	29.5	48.75	99	10.75
	65DRB66364LD8	1836	1928	65.75	36	29.5	45.75	88	12.5
	65DRB66364RD8	1836	1928	65.75	36	29.5	45.75	88	12.5
	65DRB72304LD8	1884	1979	71.75	30	29.5	54.75	104	11.5
	65DRB72304RD8	1884	1979	71.75	30	29.5	54.75	104	11.5
	65DRB72364LD8	1932	2029	71.75	36	29.5	51.75	95	13.5
	65DRB72364RD8	1932	2029	71.75	36	29.5	51.75	95	13.5
	65DRB78304LD8	1941	2037	77.75	30	29.5	56.75	58	8.5
	65DRB78304RD8	1941	2037	77.75	30	29.5	56.75	58	8.5
	65DRB78364LD8	1989	2088	77.75	36	29.5	56.75	66	9.5
	65DRB78364RD8	1989	2088	77.75	36	29.5	56.75	66	9.5
	65DRB84304LD8	1999	2100	83.75	30	29.5	66.75	114	13
	65DRB84304RD8	1999	2100	83.75	30	29.5	66.75	114	13
	65DRB84364LD8	2048	2149	83.75	36	29.5	63.75	108	15
65DRB84364RD8	2048	2149	83.75	36	29.5	63.75	108	15	

**ORDERING NOTES:** To specify optional Disc base on desk Runoffs see option chart below, replace "D8" in the model number with model suffix below and add list upcharge. When specifying a modesty panel add -20 before modesty panel suffix when runoff is to be used with a 20" deep credenza, add -24 when runoff is to be used with a 24" deep credenza. See page 531 for Modesty Panel options.

## OPEN DESK BASE OPTION UPCHARGES

Description	Model	List	Added Weight
Disc Base	DB	189	30



### ORDERING PROCEDURE

- To order, please specify the following:
- 1) Krug product model number
  - 2) Wood species and finish
  - 3) Grommet location and style if applicable.
  - 4) Base option if applicable.
  - 5) Modesty Panel option if applicable.

\* Indicates model illustrated by line drawing

### CODE DESCRIPTION

- 4 - full Height
- L - left hand position
- R - right hand position

### STANDARD FINISHES

For a complete list of standard wood finishes, please see page 518.

### GROMMETS







One grommet in a standard position is optional at no charge. See page 521 for more information.

# LATITUDE | RECTANGULAR DESK RUNOFFS FOR 3/4 CREDENZAS

Description	Model	Rift		W	D	H	KW	Shipping Weight	Cubic Feet
		Oak	Walnut						
	65DR60303LD8	1817	1908	59.75	30	29.5	21.5	68	10
	65DR60303RD8	1817	1908	59.75	30	29.5	21.5	68	10
	65DR60363LD8	1832	1922	59.75	36	29.5	21.5	77	11.5
	65DR60363RD8	1832	1922	59.75	36	29.5	21.5	77	11.5
	65DR66303LD8	1845	1937	65.75	30	29.5	27.5	99	10.75
	65DR66303RD8	1845	1937	65.75	30	29.5	27.5	99	10.75
	65DR66363LD8	1886	1981	65.75	36	29.5	24.5	88	12.5
	65DR66363RD8	1886	1981	65.75	36	29.5	24.5	88	12.5
	65DR72303LD8	1921	2017	71.75	30	29.5	33	104	11.5
	65DR72303RD8	1921	2017	71.75	30	29.5	33	104	11.5
	65DR72363LD8	1945	2103	71.75	36	29.5	30	95	13.5
	65DR72363RD8	1945	2103	71.75	36	29.5	30	95	13.5
	65DR78303LD8	2024	2124	77.75	30	29.5	39	58	8.5
	65DR78303RD8	2024	2124	77.75	30	29.5	39	58	8.5
	65DR78363LD8	2337	2453	77.75	36	29.5	36	66	9.5
	65DR78363RD8	2337	2453	77.75	36	29.5	36	66	9.5
	65DR84303LD8	2682	2816	83.75	30	29.5	45	114	13
	65DR84303RD8	2682	2816	83.75	30	29.5	45	114	13
	65DR84363LD8	3242	3405	83.75	36	29.5	42	108	15
	65DR84363RD8	3242	3405	83.75	36	29.5	42	108	15

**ORDERING NOTES:** To specify optional bases on desk Runoffs see option chart below, replace “D8” in the model number with model suffix below and add list upcharge. When specifying a modesty panel add -20 before modesty panel suffix when runoff is to be used with a 20" deep credenza, add -24 when runoff is to be used with a 24" deep credenza. See page 531 for Modesty Panel options.

### DESK RUNOFF BASE OPTION UPCHARGES

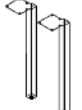
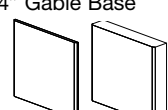
Description	Model	List	Added Weight	Description	Model	Rift Oak	Walnut	Added Weight
	DB	189	30		4F	1672	1757	83
	SQ	226	30		4D	1449	1522	78
	O-Base OB	643	18		3F	1373	1440	54
	2 - 2" Square Metal Leg M	565	19		GB 4G	481 515	507 540	20 28

#### DIMENSION KEY

W — width  
 D — depth  
 H — height of worksurface  
 KW— kneehole width

Dimensions are in inches and approximate. Contact Customer Service if dimensions are critical.

#### CODE DESCRIPTION

3 - 3/4 Height Pedestal  
 L - left hand position  
 R - right hand position

#### VENEER

Latitude is available in Quarter Cut Walnut and Rift Cut Oak veneers, and each is priced in this price guide. Maple and Cherry are also available: for Flat Cut Maple or Cherry veneer, use Column 1 pricing; for Quarter Cut Maple or Cherry, use Column 2 pricing. Other veneers are also available on Latitude, please contact us for a quote.

# LATITUDE | DESK RUNOFFS FOR 3/4 HEIGHT CREDENZAS

Description	Model	Rift		W	D	H	KW	Shipping Weight	Cubic Feet	
		Oak	Walnut							
Arc End Desk	65DRA60303LD8	1817	1908	59.75	30	29.5	21.5	68	10	
Runoffs, 4" Dia.	65DRA60303RD8	1817	1908	59.75	30	29.5	21.5	68	10	
Metal Leg	65DRA60363LD8	1832	1922	59.75	36	29.5	21.5	77	11.5	
	65DRA60363RD8	1832	1922	59.75	36	29.5	21.5	77	11.5	
	65DRA66303LD8	1845	1937	65.75	30	29.5	27.5	99	10.75	
	65DRA66303RD8	1845	1937	65.75	30	29.5	27.5	99	10.75	
	65DRA66363LD8	1886	1981	65.75	36	29.5	24.5	88	12.5	
	65DRA66363RD8	1886	1981	65.75	36	29.5	24.5	88	12.5	
	65DRA72303LD8	1921	2017	71.75	30	29.5	33	104	11.5	
	65DRA72303RD8	1921	2017	71.75	30	29.5	33	104	11.5	
	65DRA72363LD8	1945	2103	71.75	36	29.5	30	95	13.5	
	65DRA72363RD8	1945	2103	71.75	36	29.5	30	95	13.5	
	65DRA78303LD8	2024	2124	77.75	30	29.5	39	58	8.5	
	65DRA78303RD8	2024	2124	77.75	30	29.5	39	58	8.5	
	65DRA78363LD8	2337	2453	77.75	36	29.5	36	66	9.5	
	65DRA78363RD8	2337	2453	77.75	36	29.5	36	66	9.5	
	65DRA84303LD8	2682	2816	83.75	30	29.5	45	114	13	
	65DRA84303RD8	2682	2816	83.75	30	29.5	45	114	13	
	65DRA84363LD8	3242	3405	83.75	36	29.5	42	108	15	
	65DRA84363RD8	3242	3405	83.75	36	29.5	42	108	15	
<hr/>										
Bullet Desk	65DRB60303LD8	1817	1908	59.75	30	29.5	21.5	68	10	
Runoffs, 4" Dia.	65DRB60303RD8	1817	1908	59.75	30	29.5	21.5	68	10	
Metal Leg	65DRB60363LD8	1832	1922	59.75	36	29.5	21.5	77	11.5	
	65DRB60363RD8	1832	1922	59.75	36	29.5	21.5	77	11.5	
	65DRB66303LD8	1845	1937	65.75	30	29.5	27.5	99	10.75	
	65DRB66303RD8	1845	1937	65.75	30	29.5	27.5	99	10.75	
	65DRB66363LD8	1886	1981	65.75	36	29.5	24.5	88	12.5	
	65DRB66363RD8	1886	1981	65.75	36	29.5	24.5	88	12.5	
	65DRB72303LD8	1921	2017	71.75	30	29.5	33	104	11.5	
	65DRB72303RD8	1921	2017	71.75	30	29.5	33	104	11.5	
	65DRB72363LD8	1945	2103	71.75	36	29.5	30	95	13.5	
	65DRB72363RD8	1945	2103	71.75	36	29.5	30	95	13.5	
	65DRB78303LD8	2024	2124	77.75	30	29.5	39	58	8.5	
	65DRB78303RD8	2024	2124	77.75	30	29.5	39	58	8.5	
	65DRB78363LD8	2337	2453	77.75	36	29.5	36	66	9.5	
	65DRB78363RD8	2337	2453	77.75	36	29.5	36	66	9.5	
	65DRB84303LD8	2682	2816	83.75	30	29.5	45	114	13	
	65DRB84303RD8	2682	2816	83.75	30	29.5	45	114	13	
	65DRB84363LD8	3242	3405	83.75	36	29.5	42	108	15	
	65DRB84363RD8	3242	3405	83.75	36	29.5	42	108	15	

**ORDERING NOTES:** To specify optional Disc base on desk Runoffs see option chart below, replace "D8" in the model number with model suffix below and add list upcharge. When specifying a modesty panel add -20 before modesty panel suffix when runoff is to be used with a 20" deep credenza, add -24 when runoff is to be used with a 24" deep credenza. See page 531 for Modesty Panel options.

## OPEN DESK BASE OPTION UPCHARGES

Description	Model	List	Added Weight
Disc Base	DB	199	30



## ORDERING PROCEDURE

To order, please specify the following:

- 1) Krug product model number
- 2) Wood species and finish
- 3) Grommet location and style if applicable.

\* Indicates model illustrated by line drawing

## CODE DESCRIPTION

- 3 - 3/4 Height Pedestal
- L - left hand position
- R - right hand position

## STANDARD FINISHES

For a complete list of standard wood finishes, please see page 518.

## GROMMETS

One grommet in a standard position is optional at no charge. See page 521 for more information.

## MODESTY PANEL

For the hinged modesty panel option add Y after RH and add a 10% upcharge. e.g. 65RHY6024L4DX41.

LATITUDE | RETURNS

Description	Model	Rift		W	D	H	KW	Shipping Weight	Cubic Feet
		Oak	Walnut						
Return Shell, Fixed Full Ht Wood Modesty	65SRH3024LX41	1318	1386	29.75	24	29.5	29	72.5	18.25
	65SRH3024RX41*	1318	1386	29.75	24	29.5	29	72.5	18
	65SRH3624LX41	1408	1479	35.75	24	29.5	35	87	21.5
	65SRH3624RX41	1408	1479	35.75	24	29.5	35	87	21.5
	65SRH4224LX41	1570	1648	41.75	24	29.5	41	98	24.5
	65SRH4224RX41	1570	1648	41.75	24	29.5	41	98	24.5
	65SRH4824LX41	1582	1661	47.75	24	29.5	47	108	27.5
	65SRH4824RX41	1582	1661	47.75	24	29.5	47	108	27.5
	65SRH5424LX41	1632	1713	53.75	24	29.5	53	114.5	30.75
	65SRH5424RX41	1632	1713	53.75	24	29.5	53	114.5	30.75
	65SRH6024LX41	1676	1760	59.75	24	29.5	65	124	33.75
	65SRH6024RX41	1676	1760	59.75	24	29.5	65	124	33.75
	65SRH6624LX41	1727	1813	65.75	24	29.5	65	133	37
	65SRH6624RX41	1727	1813	65.75	24	29.5	65	133	37
	65SRH7224LX41	1778	1867	71.75	24	29.5	71	142	40
	65SRH7224RX41	1778	1867	71.75	24	29.5	71	142	40
Single Pedestal Return , Full Height Fixed Wood Modesty	65RH3620L4DX41	2182	2291	35.75	20	29.5	20	104	18.25
	65RH3620L4FX41*	2182	2291	35.75	20	29.5	20	104	18.25
	65RH3620R4DX41	2182	2291	35.75	20	29.5	20	108	18.25
	65RH3620R4FX41	2182	2291	35.75	20	29.5	20	108	18.25
	65RH3624L4DX41	2252	2364	35.75	24	29.5	20	115	21.5
	65RH3624L4FX41	2252	2364	35.75	24	29.5	20	115	21.5
	65RH3624R4DX41	2252	2364	35.75	24	29.5	20	119	21.5
	65RH3624R4FX41	2252	2364	35.75	24	29.5	20	119	21.5
	65RH4220L4DX41	2785	2924	41.75	20	29.5	26	100	21
	65RH4220L4FX41	2785	2924	41.75	20	29.5	26	100	21
	65RH4220R4DX41	2785	2924	41.75	20	29.5	26	100	21
	65RH4220R4FX41	2785	2924	41.75	20	29.5	26	100	21
	65RH4224L4DX41	2805	2946	41.75	24	29.5	26	104	24.5
	65RH4224L4FX41	2805	2946	41.75	24	29.5	26	104	24.5
	65RH4224R4DX41	2805	2946	41.75	24	29.5	26	104	24.5
	65RH4224R4FX41	2805	2946	41.75	24	29.5	26	104	24.5
	65RH4820L4DX41	2829	2970	48.75	20	29.5	32	104	23.75
	65RH4820L4FX41	2829	2970	48.75	20	29.5	32	104	23.75
	65RH4820R4DX41	2829	2970	48.75	20	29.5	32	104	23.75
	65RH4820R4FX41	2829	2970	48.75	20	29.5	32	104	23.75
	65RH4824L4DX41	2839	2983	48.75	24	29.5	32	108	27.5
	65RH4824L4FX41	2839	2983	48.75	24	29.5	32	108	27.5
	65RH4824R4DX41	2839	2983	48.75	24	29.5	32	108	27.5
	65RH4824R4FX41	2839	2983	48.75	24	29.5	32	108	27.5
	65RH5424L4DX41	2863	3008	53.75	24	29.5	38	138	30.75
	65RH5424L4FX41	2863	3008	53.75	24	29.5	38	138	30.75
	65RH5424R4DX41	2863	3008	53.75	24	29.5	38	142	30.75
	65RH5424R4FX41	2863	3008	53.75	24	29.5	38	142	30.75
	65RH6024L4DX41	2886	3031	59.75	24	29.5	38	146	33.75
	65RH6024L4FX41	2886	3031	59.75	24	29.5	38	146	33.75
	65RH6024R4DX41	2886	3031	59.75	24	29.5	38	150	33.75
	65RH6024R4FX41	2886	3031	59.75	24	29.5	38	150	33.75
65RH6624L4DX41	2972	3121	65.75	24	29.5	50	158	37	
65RH6624L4FX41	2972	3121	65.75	24	29.5	50	158	37	
65RH6624R4DX41	2972	3121	65.75	24	29.5	50	162	37	
65RH6624R4FX41	2972	3121	65.75	24	29.5	50	162	37	
65RH7224L4DX41	3066	3217	71.75	24	29.5	50	166	40	
65RH7224L4FX41	3066	3217	71.75	24	29.5	50	166	40	
65RH7224R4DX41	3066	3217	71.75	24	29.5	50	170	40	
65RH7224R4FX41	3066	3217	71.75	24	29.5	50	170	40	

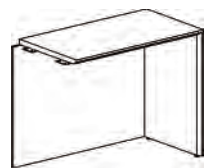

**DIMENSION KEY**

- W — width
- D — depth
- H — height of worksurface
- KW— kneehole width

Dimensions are in inches and approximate. Contact Customer Service if dimensions are critical.

**CODE DESCRIPTION**

- L - left hand position
- R - right hand position
- D - 2 file drawers
- F - 2 box, 1 file drawer
- X41- full height fixed wood modesty
- X21- 1/2 height fixed wood modesty

**VENEER**

Latitude is available in Quarter Cut Walnut and Rift Cut Oak veneers, and each is priced in this price guide. Maple and Cherry are also available: for Flat Cut Maple or Cherry veneer, use Column 1 pricing; for Quarter Cut Maple or Cherry, use Column 2 pricing. Other veneers are also available on Latitude, please contact us for a quote.



# LATITUDE | LINKING UNITS AND CORNER UNITS

Description	Model	Rift		W	D	H	KW	Shipping Weight	Cubic Feet
		Oak	Walnut						
 Single Pedestal Return for Table Desk, Full Height Fixed Wood Modesty	65RHTD4224L4DX41	2611	2742	42	24	29.5	26	61	24.5
	65RHTD4224L4FX41*	2611	2742	42	24	29.5	26	61	24.5
	65RHTD4224R4DX41	2611	2742	42	24	29.5	26	61	24.5
	65RHTD4224R4FX41	2611	2742	42	24	29.5	26	61	24.5
	65RHTD4824L4DX41	2638	2770	48	24	29.5	32	67	27.5
	65RHTD4824L4FX41	2638	2770	48	24	29.5	32	67	27.5
	65RHTD4824R4DX41	2638	2770	48	24	29.5	32	67	27.5
	65RHTD4824R4FX41	2638	2770	48	24	29.5	32	67	27.5
	65RHTD6024L4DX41	2665	2800	59.75	24	29.5	44	78	33.75
	65RHTD6024L4FX41	2665	2800	59.75	24	29.5	44	78	33.75
	65RHTD6024R4DX41	2665	2800	59.75	24	29.5	44	78	33.75
65RHTD6024R4FX41	2665	2800	59.75	24	29.5	44	78	33.75	

## ORDERING NOTES:

For the hinged modesty panel option add Y after RH and add a 10% upcharge. e.g. 65RHYTD6024L4DX41.

 Linking Top	65LU3024H	589	618	30	24	29.5		19.5	2
	65LU3620H	647	680	36	20	29.5		15	1.5
	65LU3624H	662	695	36	24	29.5		16	1.75
	65LU4220H	678	714	42	20	29.5		20	1.5
	65LU4224H	702	737	42	24	29.5		24	2
	65LU4820H	710	746	48	20	29.5		29	1.75
	65LU4824H	729	764	48	24	29.5		36	2
	65LU5424H	864	906	54	24	29.5		35	3.5
	65LU6024H	913	958	59.75	24	29.5		38.5	3.75
	65LU6624H	962	1012	65.75	24	29.5		42.5	4
	65LU7224H	1041	1093	71.75	24	29.5		46.5	4.5

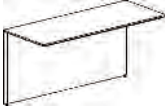
 Linking Unit with Fixed Modesty	65LU3024HX41	1140	1197	30	24	29.5		46	3
	65LU3620HX41	1290	1356	36	20	29.5		59	3
	65LU3624HX41	1348	1416	36	24	29.5		64	3
	65LU4220HX41	1393	1463	42	20	29.5		67	3.75
	65LU4224HX41	1417	1487	42	24	29.5		72	3.75
	65LU4820HX41	1453	1527	48	20	29.5		78	4
	65LU4824HX41	1543	1620	48	24	29.5		80	4
	65LU5424HX41	1638	1717	54	24	29.5		81	4.75
	65LU6024HX41	1728	1815	59.75	24	29.5		89	5
	65LU6624HX41	1818	1909	65.75	24	29.5		97	5.5
65LU7224HX41	1909	2004	71.75	24	29.5		105.5	6	

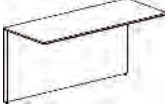
 Linking Units for Table Desks	65LUTD4220HLX41	1290	1356	42	20	29.5		67	20
	65LUTD4220HRX41	1290	1356	42	24	29.5		67	20
	65LUTD4224HLX41	1310	1376	48	20	29.5		71	23
	65LUTD4224HRX41	1310	1376	48	24	29.5		71	23
	65LUTD4820HLX41	1345	1412	42	20	29.5		78	22.5
	65LUTD4820HRX41	1345	1412	42	24	29.5		78	22.5
	65LUTD4824HLX41	1362	1431	48	20	29.5		79	26
	65LUTD4824HRX41	1362	1431	48	24	29.5		79	26

## ORDERING NOTES:

For the hinged modesty panel option on linking units add Y after LU and add a 10% upcharge. e.g. 65LUYTD4824HRX41

 Corner Unit	65CU363620	2570	2698	36	20	29.5	22.5	106	30.25
	65CU363624	2570	2698	36	24	29.5	17	106	30.25
	65CU424220	2824	2965	42	20	29.5	31	131	39.75
	65CU424224	2824	2965	42	24	29.5	25.25	131	39.75

## ORDERING PROCEDURE

To order, please specify the following:

- 1) Krug product model number
- 2) Wood species and finish
- 3) Grommet location and style if applicable.

\* Indicates model illustrated by line drawing

## CODE DESCRIPTION

- L - left hand position
- R - right hand position
- 4D - 2 file drawers
- 4F - 2 box, 1 file drawer
- X21 - 1/2 height fixed wood modesty
- X41 - full height wood modesty panel

## STANDARD FINISHES

For a complete list of standard wood finishes, please see page 518.



## GROMMETS

One grommet in a standard position is optional at no charge. See page 521 for more information.

## PALETTE FINISHES

Drawer fronts are available in pallet at an up-charge of **\$357 list** per unit, add P at the end of the model number.

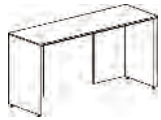
LATITUDE | CREDENZAS

Description	Model	Rift		W	D	H	KW	Shipping Weight	Cubic Feet
		Oak	Walnut						
	65SC5424	1962	2060	54	24	29.5	51.5	88	29
	65SC6024	2109	2215	59.75	24	29.5	57.5	109	27.75
	65SC6624	2257	2370	65.75	24	29.5	63.5	104	35
	65SC7224	2417	2538	71.75	24	29.5	69.5	112	38
	65SC7824	2557	2685	77.75	24	29.5	75.5	120	40
	65SC8424	2699	2835	83.75	24	29.5	81.5	128	44
	65SC9624	3088	3242	95.75	24	29.5	93.5	128	44
	65SC3624X41	1641	1723	36	24	29.5	39.5	84	20
	65SC4224X41	1774	1862	42	24	29.5	39.5	94	23
	65SC4824X41	1928	2026	48	24	29.5	45.5	106	26
	65SC5424X41	2080	2184	54	24	29.5	51.5	117	29
	65SC6024X41	2243	2356	59.75	24	29.5	57.5	116	27.75
	65SC6624X41	2396	2516	65.75	24	29.5	63.5	104	35
	65SC7224X41	2562	2690	71.75	24	29.5	69.5	112	38
	65SC7824X41	2714	2848	77.75	24	29.5	75.5	120	40
	65SC8424X41	2864	3009	83.75	24	29.5	81.5	128	44
65SC9624X41	3273	3437	95.75	24	29.5	93.5	128	44	
	65C60204XLDR0	3579	3759	59.75	20	29.5	43	120	27.75
	65C60204XLFR0	3579	3759	59.75	20	29.5	43	120	27.75
	65C60204XLORD	3579	3759	59.75	20	29.5	43	120	27.75
	65C60204XLORF	3579	3759	59.75	20	29.5	43	120	27.75
	65C60244XLDR0	3606	3787	59.75	24	29.5	43	128	32
	65C60244XLFR0	3606	3787	59.75	24	29.5	43	128	32
	65C60244XLORD	3606	3787	59.75	24	29.5	43	128	32
	65C60244XLORF	3606	3787	59.75	24	29.5	43	128	32
	65C66204XLDR0	3633	3815	65.75	20	29.5	49	136	30
	65C66204XLFR0*	3633	3815	65.75	20	29.5	49	136	30
	65C66204XLORD	3633	3815	65.75	20	29.5	49	136	30
	65C66204XLORF	3633	3815	65.75	20	29.5	49	136	30
	65C66244XLDR0	3648	3830	65.75	24	29.5	49	144	35
	65C66244XLFR0	3648	3830	65.75	24	29.5	49	144	35
	65C66244XLORD	3648	3830	65.75	24	29.5	49	144	35
	65C66244XLORF	3648	3830	65.75	24	29.5	49	144	35
	65C72204XLDR0	3665	3848	71.75	20	29.5	55	152	32.75
	65C72204XLFR0	3665	3848	71.75	20	29.5	55	152	32.75
	65C72204XLORD	3665	3848	71.75	20	29.5	55	152	32.75
	65C72204XLORF	3665	3848	71.75	20	29.5	55	152	32.75
	65C72244XLDR0	3697	3881	71.75	24	29.5	55	160	38
65C72244XLFR0	3697	3881	71.75	24	29.5	55	160	38	
65C72244XLORD	3697	3881	71.75	24	29.5	55	160	38	
65C72244XLORF	3697	3881	71.75	24	29.5	55	160	38	
65C78204XLDR0	3708	3892	77.75	20	29.5	61	168	35.5	
65C78204XLFR0	3708	3892	77.75	20	29.5	61	168	35.5	
65C78204XLORD	3708	3892	77.75	20	29.5	61	168	35.5	
65C78204XLORF	3708	3892	77.75	20	29.5	61	168	35.5	
65C78244XLDR0	3715	3903	77.75	24	29.5	61	172	41	
65C78244XLFR0	3715	3903	77.75	24	29.5	61	172	41	

**ORDERING NOTES:**

For the hinged modesty panel option add Y after C and add a 10% upcharge. e.g. 65CY60204XLDR0. Unsupported spans greater than 48" require a half gable support. See page 571. Drawer fronts are available in pallet at an upcharge of **\$357 list** per unit, add P at the end of the model number.

**DIMENSION KEY**

W – width  
 D – depth  
 H – height of worksurface  
 KW – kneehole width

Dimensions are in inches and approximate. Contact Customer Service if dimensions are critical.



**CODE DESCRIPTION**

X41 - full height fixed wood modesty  
 X - modesty panel  
 4 - full height pedestal  
 L - left hand position  
 R - right hand position  
 D - 2 file drawers  
 F - 2 box, 1 file drawer  
 0 - no pedestal

**VENEER**

Latitude is available in Quarter Cut Walnut and Rift Cut Oak veneers, and each is priced in this price guide. Maple and Cherry are also available: for Flat Cut Maple or Cherry veneer, use Column 1 pricing; for Quarter Cut Maple or Cherry, use Column 2 pricing. Other veneers are also available on Latitude, please contact us for a quote.

# LATITUDE | CREDENZAS

Description	Model	Rift		W	D	H	KW	Shipping Weight	Cubic Feet
		Oak	Walnut						
Single Pedestal	65C78244XLORD	3715	3903	77.75	24	29.5	61	172	41
Credenza, Fixed	65C78244XLORF	3715	3903	77.75	24	29.5	61	172	41
Wood Modesty	65C84204XLDR0	3721	3908	83.75	20	29.5	67	184	38
cont.	65C84204XLFR0	3721	3908	83.75	20	29.5	67	184	38
	65C84204XLORD	3721	3908	83.75	20	29.5	67	184	38
	65C84204XLORF	3721	3908	83.75	20	29.5	67	184	38
	65C84244XLDR0	3731	3917	83.75	24	29.5	67	192	44
	65C84244XLFR0	3731	3917	83.75	24	29.5	67	192	44
	65C84244XLORD	3731	3917	83.75	24	29.5	67	192	44
	65C84244XLORF	3731	3917	83.75	24	29.5	67	192	44
Single Lateral File or	65C6020XL3011R0	3215	3376	59.75	20	29.5	29	107	27.75
Bookcase Pedestal	65C6020XLOR3011	3215	3376	59.75	20	29.5	29	107	27.75
Credenza, Fixed	65C6020XL3001R0	3487	3661	59.75	20	29.5	29	140	27.75
Wood Modesty	65C6020XLOR3001	3487	3661	59.75	20	29.5	29	140	27.75
	65C6024XL3011R0	3334	3501	59.75	24	29.5	29	113	32
	65C6024XLOR3011	3334	3501	59.75	24	29.5	29	113	32
	65C6024XL3001R0	3608	3789	59.75	24	29.5	29	147	32
	65C6024XLOR3001	3608	3789	59.75	24	29.5	29	147	32
	65C6620XL3611R0	3353	3520	65.75	20	29.5	35	118	30
	65C6620XLOR3611	3353	3520	65.75	20	29.5	35	118	30
	65C6620XL3601R0	3626	3809	65.75	20	29.5	35	154	30
	65C6620XLOR3601	3626	3809	65.75	20	29.5	35	154	30
	65C6624XL3611R0	3369	3537	65.75	24	29.5	35	125	35
	65C6624XLOR3611	3369	3537	65.75	24	29.5	35	125	35
	65C6624XL3601R0	3642	3823	65.75	24	29.5	35	162	35
	65C6624XLOR3601	3642	3823	65.75	24	29.5	35	162	35
	65C7220XL3611R0	3411	3582	71.75	20	29.5	35	128	32.75
	65C7220XLOR3611	3411	3582	71.75	20	29.5	35	128	32.75
	65C7220XL3601R0	3854	4047	71.75	20	29.5	35	168	32.75
	65C7220XLOR3601	3854	4047	71.75	20	29.5	35	168	32.75
	65C7224XL3611R0	3538	3714	71.75	24	29.5	35	136	38
	65C7224XLOR3611	3538	3714	71.75	24	29.5	35	136	38
	65C7224XL3601R0	3919	4114	71.75	24	29.5	35	176	38
	65C7224XLOR3601	3919	4114	71.75	24	29.5	35	176	38
	65C7820XL3611R0	3553	3731	77.75	20	29.5	41	155	35.5
	65C7820XLOR3611	3553	3731	77.75	20	29.5	41	155	35.5
	65C7820XL3601R0	3981	4180	77.75	20	29.5	41	195	35.5
	65C7820XLOR3601	3981	4180	77.75	20	29.5	41	195	35.5
	65C7824XL3611R0	3565	3743	77.75	24	29.5	41	174	41
	65C7824XLOR3611	3565	3743	77.75	24	29.5	41	174	41
	65C7824XL3601R0	4063	4265	77.75	24	29.5	41	199	41
	65C7824XLOR3601	4063	4265	77.75	24	29.5	41	199	41
	65C8420XL3611R0	3580	3760	83.75	20	29.5	47	181	38
	65C8420XLOR3611	3580	3760	83.75	20	29.5	47	181	38
	65C8420XL3601R0	4110	4315	83.75	20	29.5	47	221	38
	65C8420XLOR3601	4110	4315	83.75	20	29.5	47	221	38
	65C8424XL3611R0	3592	3771	83.75	24	29.5	47	212	44
	65C8424XLOR3611	3592	3771	83.75	24	29.5	47	212	44
	65C8424XL3601R0	4207	4418	83.75	24	29.5	47	252	44
	65C8424XLOR3601	4207	4418	83.75	24	29.5	47	252	44

## ORDERING NOTES:

For the hinged modesty panel option add Y after C and add a 10% upcharge. e.g. 65C**Y**6020XL3011R0. Drawer fronts are available in pallet at an upcharge of **\$357 list** per unit, add P at the end of the model number.

## ORDERING PROCEDURE

To order, please specify the following:

- 1) Krug product model number
- 2) Wood species and finish
- 3) Grommet location and style if applicable.

\* Indicates model illustrated by line drawing

## CODE DESCRIPTION

- 4 - full height pedestal
- X - modesty panel
- L - left hand position
- R - right hand position
- D - 2 file drawers
- F - 2 box, 1 file drawer
- 0 - no pedestal
- 01 - lateral file
- 11 - closed bookcase

## STANDARD FINISHES

For a complete list of standard wood finishes, please see page 518.



## GROMMETS

One grommet in a standard position is optional at no charge. See page 521 for more information.

## PALETTE FINISH

Drawer fronts are available in Palette at an up-charge of **\$357 per unit**, add P at the end of the model number.

LATITUDE | CREDENZAS

Description	Model	Rift		W	D	H	KW	Shipping Weight	Cubic Feet
		Oak	Walnut						
Single 36" Combination Pedestal Credenza, Fixed Wood Modesty 	65C7220XL3602RO	3581	3761	71.75	20	29.5	35	168	32.75
	65C7220XLOR3604	3581	3761	71.75	20	29.5	35	168	32.75
	65C7224XL3602RO	3714	3902	71.75	24	29.5	35	165	38
	65C7224XLOR3604	3714	3902	71.75	24	29.5	35	165	38
	65C7820XL3602RO	3634	3816	77.75	20	29.5	41	174	35.5
	65C7820XLOR3604	3634	3816	77.75	20	29.5	41	174	35.5
	65C7824XL3602RO*	3744	3933	77.75	24	29.5	41	182	41
	65C7824XLOR3604	3744	3933	77.75	24	29.5	41	182	41
	65C8420XL3602RO	3686	3871	83.75	20	29.5	47	180	38
	65C8420XLOR3604	3686	3871	83.75	20	29.5	47	180	38
	65C8424XL3602RO	3774	3963	83.75	24	29.5	47	188	44
	65C8424XLOR3604	3774	3963	83.75	24	29.5	47	188	44
	Double Pedestal Credenza, Fixed Wood Modesty 	65C60204XLDRD	3846	4039	59.75	20	29.5	28.5	200
65C60204XLDRF		3846	4039	59.75	20	29.5	28.5	200	27.75
65C60204XLFRD		3846	4039	59.75	20	29.5	28.5	200	27.75
65C60204XLFRF		3846	4039	59.75	20	29.5	28.5	200	27.75
65C60244XLDRD		3874	4068	59.75	24	29.5	28.5	208	32
65C60244XLDRF		3874	4068	59.75	24	29.5	28.5	208	32
65C60244XLFRD		3874	4068	59.75	24	29.5	28.5	208	32
65C60244XLFRF		3874	4068	59.75	24	29.5	28.5	208	32
65C66204XLDRD		3907	4103	65.75	20	29.5	34.5	216	30
65C66204XLDRF*		3907	4103	65.75	20	29.5	34.5	216	30
65C66204XLFRD		3907	4103	65.75	20	29.5	34.5	216	30
65C66204XLFRF		3907	4103	65.75	20	29.5	34.5	216	30
65C66244XLDRD		3914	4110	65.75	24	29.5	34.5	224	35
65C66244XLDRF		3914	4110	65.75	24	29.5	34.5	224	35
65C66244XLFRD		3914	4110	65.75	24	29.5	34.5	224	35
65C66244XLFRF		3914	4110	65.75	24	29.5	34.5	224	35
65C72204XLDRD		3941	4140	71.75	20	29.5	40.5	232	32.75
65C72204XLDRF		3941	4140	71.75	20	29.5	40.5	232	32.75
65C72204XLFRD		3941	4140	71.75	20	29.5	40.5	232	32.75
65C72204XLFRF		3941	4140	71.75	20	29.5	40.5	232	32.75
65C72244XLDRD		3977	4173	71.75	24	29.5	40.5	240	38
65C72244XLDRF		3977	4173	71.75	24	29.5	40.5	240	38
65C72244XLFRD		3977	4173	71.75	24	29.5	40.5	240	38
65C72244XLFRF		3977	4173	71.75	24	29.5	40.5	240	38
65C78204XLDRD		3979	4177	77.75	20	29.5	46.5	248	35.5
65C78204XLDRF		3979	4177	77.75	20	29.5	46.5	248	35.5
65C78204XLFRD		3979	4177	77.75	20	29.5	46.5	248	35.5
65C78204XLFRF		3979	4177	77.75	20	29.5	46.5	248	35.5
65C78244XLDRD		3982	4182	77.75	24	29.5	46.5	256	41
65C78244XLDRF		3982	4182	77.75	24	29.5	46.5	256	41
65C78244XLFRD		3982	4182	77.75	24	29.5	46.5	256	41
65C78244XLFRF		3982	4182	77.75	24	29.5	46.5	256	41
65C84204XLDRD	3985	4186	83.75	20	29.5	52.5	264	38	
65C84204XLDRF	3985	4186	83.75	20	29.5	52.5	264	38	
65C84204XLFRD	3985	4186	83.75	20	29.5	52.5	264	38	
65C84204XLFRF	3985	4186	83.75	20	29.5	52.5	264	38	
65C84244XLDRD	4008	4208	83.75	24	29.5	52.5	272	44	
65C84244XLDRF	4008	4208	83.75	24	29.5	52.5	272	44	
65C84244XLFRD	4008	4208	83.75	24	29.5	52.5	272	44	
65C84244XLFRF	4008	4208	83.75	24	29.5	52.5	272	44	

**ORDERING NOTES:** For the hinged modesty panel option add Y after C and add a 10% upcharge. e.g. 65CY60204XLDRD.

**DIMENSION KEY**

W — width  
 D — depth  
 H — height of worksurface  
 KW — kneehole width

Dimensions are in inches and approximate. Contact Customer Service if dimensions are critical.



**CODE DESCRIPTION**

4 - full height pedestal  
 X - modesty panel  
 L - left hand position  
 R - right hand position  
 02 - 2 box on right, 1 file drawer left, lateral file  
 04 - 1 file drawer right, 2 box on left, lateral file  
 D - 2 file drawers  
 F - 2 box, 1 file drawer

**veneer**

Latitude is available in Quarter Cut Walnut and Rift Cut Oak veneers, and each is priced in this price guide. Maple and Cherry are also available: for Flat Cut Maple or Cherry veneer, use Column 1 pricing; for Quarter Cut Maple or Cherry, use Column 2 pricing. Other veneers are also available on Latitude, please contact us for a quote.

# LATITUDE | FULL FACE & 3/4 HEIGHT CREDENZAS

Description	Model	Rift		W	D	H	KW	Shipping Weight	Cubic Feet
		Oak	Walnut						
 Full Face Credenza	65C6020L3001R3001	4087	4291	59.75	20	29.5	-	176	28
	65C6020L3001R3011	3907	4103	59.75	20	29.5	-	192	28
	65C6020L3011R3001	3907	4103	59.75	20	29.5	-	192	28
	65C6020L3011R3011	3723	3909	59.75	20	29.5	-	208	28
	65C6024L3001R3001	4213	4423	59.75	24	29.5	-	192	33
	65C6024L3001R3011	3995	4194	59.75	24	29.5	-	210	33
	65C6024L3011R3001	3995	4194	59.75	24	29.5	-	210	33
	65C6024L3011R3011	3773	3962	59.75	24	29.5	-	230	33
	65C7220L3601R3601	5346	5614	71.75	20	29.5	-	208	32.75
	65C7220L3601R3611	4877	5121	71.75	20	29.5	-	228	32.75
	65C7220L3611R3601	4877	5121	71.75	20	29.5	-	228	32.75
	65C7220L3611R3611	4154	4362	71.75	20	29.5	-	248	32.75
	65C7224L3601R3601	5416	5686	71.75	24	29.5	-	224	38
	65C7224L3601R3611	4968	5216	71.75	24	29.5	-	236	38
	65C7224L3611R3601	4968	5216	71.75	24	29.5	-	236	38
	65C7224L3611R3611	4208	4420	71.75	24	29.5	-	256	38
	 Single Pedestal 3/4 Height Credenza	65C60203XL0R3011	3032	3185	59.75	20	23	28	191
65C60203XL0R3016		3103	3260	59.75	20	23	28	202	21
65C60203XL3011R0		3032	3185	59.75	20	23	28	191	21
65C60203XL3016R0		3103	3260	59.75	20	23	28	202	21
65C60243XL0R3011		3469	3642	59.75	24	23	28	204	25
65C60243XL0R3016		3553	3731	59.75	24	23	28	226	25
65C60243XL3011R0		3469	3642	59.75	24	23	28	191	25
65C60243XL3016R0		3553	3731	59.75	24	23	28	242	25
65C66203XL0R3611		3093	3247	59.75	20	23	28.5	191	21
65C66203XL0R3616		3164	3323	59.75	20	23	28.5	202	21
65C66203XL3611R0		3093	3247	59.75	20	23	28.5	191	21
65C66203XL3616R0		3164	3323	59.75	20	23	28.5	202	21
65C66243XL0R3611		3539	3715	59.75	24	23	28.5	204	25
65C66243XL0R3616		3622	3803	59.75	24	23	28.5	226	25
65C66243XL3611R0		3539	3715	59.75	24	23	28.5	191	25
65C66243XL3616R0		3622	3803	59.75	24	23	28.5	242	25
65C72203XL0R3611		3158	3315	71.75	20	23	34.5	191	25.5
65C72203XL0R3616		3231	3390	71.75	20	23	34.5	202	25.5
65C72203XL3611R0		3158	3315	71.75	20	23	34.5	191	25.5
65C72203XL3616R0		3231	3390	71.75	20	23	34.5	202	25.5
65C72243XL0R3611		3610	3792	71.75	24	23	34.5	204	30
65C72243XL0R3616		3697	3881	71.75	24	23	34.5	226	30
65C72243XL3611R0		3610	3792	71.75	24	23	34.5	191	30
65C72243XL3616R0		3697	3881	71.75	24	23	34.5	242	30
65C84203XL0R3611		3598	3780	83.75	20	23	46.5	191	29.5
65C84203XL0R3616		3670	3854	83.75	20	23	46.5	202	29.5
65C84203XL3611R0		3598	3780	83.75	20	23	46.5	191	29.5
65C84203XL3616R0		3670	3854	83.75	20	23	46.5	202	29.5
65C84243XL0R3611	4071	4277	83.75	24	23	46.5	204	35	
65C84243XL0R3616	4011	4213	83.75	24	23	46.5	226	35	
65C84243XL3611R0	4071	4277	83.75	24	23	46.5	191	35	
65C84243XL3616R0	4011	4213	83.75	24	23	46.5	242	35	
65C96243XL0R3611	4319	4536	95.5	24	23	58.5	254	40	
65C96243XL0R3616	4257	4468	95.5	24	23	58.5	240	40	
65C96243XL3611R0	4319	4536	95.5	24	23	58.5	240	40	
65C96243XL3616R0	4257	4468	95.5	24	23	58.5	254	40	

**ORDERING NOTES:** For the hinged modesty panel option add Y after RH and add a 10% upcharge. e.g. 65CY60203XL0R3011.

## ORDERING PROCEDURE

To order, please specify the following:

- 1) Krug product model number
- 2) Wood species and finish
- 3) Grommet location and style if applicable.

\* Indicates model illustrated by line drawing

## CODE DESCRIPTION

- 4 - full height pedestal
- 3 - 3/4 height pedestal
- X - modesty panel
- L - left hand position
- R - right hand position
- 01 - lateral file
- 11 - closed bookcase
- 16 - box, lateral file

## STANDARD FINISHES

For a complete list of standard wood finishes, please see page 518.

## PALETTE FINISH

Storage unit door fronts are available in Palette finish at no upcharge. Drawer fronts are also available in Palette at an upcharge of **\$357 list** per unit, add P at the end of the model number. See page 518 for color selection..

LATITUDE | 3/4 HEIGHT CREDENZAS

Description	Model	Rift		W	D	H	Shipping Weight	Cubic Feet
		Oak	Walnut					
	65C60203L3011R3011	4112	4317	59.75	20	23	186	21
	65C60203L3011R3016	4159	4368	59.75	20	23	191	21
	65C60203L3011R3017	3679	3862	59.75	20	23	171	21
	65C60203L3016R3011	4138	4343	59.75	24	23	191	21
	65C60203L3016R3016	4111	4316	59.75	20	23	202	21
	65C60203L3016R3017	4027	4229	59.75	20	23	179	21
	65C60203L3017R3011	3679	3862	59.75	20	23	171	21
	65C60203L3017R3016	4608	4838	59.75	20	23	179	21
	65C60203L3017R3017	3121	3278	59.75	20	23	156	21
	65C60243L3011R3011	4194	4404	59.75	24	23	193	25
	65C60243L3011R3016	4289	4504	59.75	24	23	204	25
	65C60243L3011R3017	3753	3939	59.75	24	23	178	25
	65C60243L3016R3011	4289	4504	59.75	24	23	204	25
	65C60243L3016R3016	4263	4477	59.75	24	23	226	25
	65C60243L3016R3017	4152	4360	59.75	24	23	216	25
	65C60243L3017R3011	3753	3939	59.75	24	23	178	25
	65C60243L3017R3016	4152	4360	59.75	24	23	216	25
	65C60243L3017R3017	3244	3406	59.75	24	23	163	25
	65C72203L3611R3611	4277	4488	71.5	24	23	197	25.5
	65C72203L3611R3616	4437	4659	71.75	20	23	213.5	25.5
	65C72203L3611R3617	3881	4077	71.5	20	23	182	25.5
	65C72203L3616R3611	4437	4659	71.75	20	23	213.5	25.5
	65C72203L3616R3616	4411	4632	71.75	20	23	218.5	25.5
	65C72203L3616R3617	4292	4507	71.75	20	23	218.5	25.5
	65C72203L3617R3611	3864	4057	71.5	20	23	182	25.5
	65C72203L3617R3616	4292	4507	71.75	20	23	199	25.5
	65C72203L3617R3617	3343	3510	71.5	20	23	167	25.5
	65C72243L3611R3611	4411	4632	71.5	24	23	200	30
	65C72243L3611R3616	4604	4835	71.75	24	23	240	30
	65C72243L3611R3617	3903	4098	71.5	24	23	185	30
65C72243L3616R3611	4604	4835	71.75	24	23	240	30	
65C72243L3616R3616	4574	4803	71.75	24	23	237	30	
65C72243L3616R3617	4452	4672	71.75	24	23	224.5	30	
65C72243L3617R3611	3903	4098	71.5	24	23	185	30	
65C72243L3617R3616	4452	4672	71.75	24	23	224.5	30	
65C72243L3617R3617	3442	3614	71.5	24	23	170	30	

**ORDERING NOTES:** The -15 open/lateral file module can be used in place of the -16 box/file at the same price. The -18 open/closed bookcase module can be used in place of the -11 closed module at the same price. If a runoff with power/data option is to be mounted onto a 3/4 height credenza please specify location ML -Mounted Left or MR-Mounted Right. This will ensure that access grommets will be drilled in the credenza top and back. Full Face ¾ height credenzas larger than 72" must be specified modularly, please see page 569.

**DIMENSION KEY**

- W — width
- D — depth
- H — height of worksurface
- KW— kneehole width

Dimensions are in inches and approximate. Contact Customer Service if dimensions are critical.

**CODE DESCRIPTION**

- 3 - 3/4 height pedestal
- L - left hand position
- R - right hand position
- 11 - closed bookcase
- 16 - box, lateral file
- 17 - open bookcase
- 15 - top open, lateral file
- 18 - top open, closed bookcase

**VENEER**

Latitude is available in Quarter Cut Walnut and Rift Cut Oak veneers, and each is priced in this price guide. Maple and Cherry are also available: for Flat Cut Maple or Cherry veneer, use Column 1 pricing; for Quarter Cut Maple or Cherry, use Column 2 pricing. Other veneers are also available on Latitude, please contact us for a quote.

# LATITUDE | CORNER CREDENZAS & OVERHEADS

Description	Model	Rift		W	D	H	KW	Shipping Weight	Cubic Feet
		Oak	Walnut						
Corner Credenza	65CC7224XL4D	3194	3355	71.75	24	29.5	32	192	38
Single Pedestal	65CC7224XL4F	3194	3355	71.75	24	29.5	32	192	38
Fixed Wood Modesty Panel	65CC7224XR4D	3194	3355	71.75	24	29.5	32	192	38
	65CC7224XR4F	3194	3355	71.75	24	29.5	32	192	38
	65CC7824XL4D	3227	3388	77.75	24	29.5	38	200	41
	65CC7824XL4F	3227	3388	77.75	24	29.5	38	200	41
	65CC7824XR4D	3227	3388	77.75	24	29.5	38	200	41
	65CC7824XR4F	3227	3388	77.75	24	29.5	38	200	41
	65CC8424XL4D	3261	3424	83.75	24	29.5	44	208	44
	65CC8424XL4F	3261	3424	83.75	24	29.5	44	208	44
	65CC8424XR4D	3261	3424	83.75	24	29.5	44	208	44
	65CC8424XR4F	3261	3424	83.75	24	29.5	44	208	44
Curved Corner Credenza Single Pedestal Fixed Wood Modesty Panel	65CCC7224XL4D	3260	3423	71.75	24	29.5	32	192	38
	65CCC7224XL4F	3260	3423	71.75	24	29.5	32	192	38
	65CCC7224XR4D	3260	3423	71.75	24	29.5	32	192	38
	65CCC7224XR4F	3260	3423	71.75	24	29.5	32	192	38
	65CCC7824XL4D	3294	3459	77.75	24	29.5	38	200	41
	65CCC7824XL4F	3294	3459	77.75	24	29.5	38	200	41
	65CCC7824XR4D	3294	3459	77.75	24	29.5	38	200	41
	65CCC7824XR4F	3294	3459	77.75	24	29.5	38	200	41
	65CCC8424XL4D	3327	3494	83.75	24	29.5	44	208	44
	65CCC8424XL4F	3327	3494	83.75	24	29.5	44	208	44
65CCC8424XR4D	3327	3494	83.75	24	29.5	44	208	44	
65CCC8424XR4F	3327	3494	83.75	24	29.5	44	208	44	
<b>Doors</b>									
Single Height Overhead, Wood Doors	65OHW361616	1231	1294	35.75	15.75	16	2	64	7
	65OHW421616	1290	1356	41.75	15.75	16	2	71	8.5
	65OHW481616	1389	1458	47.75	15.75	16	3	82	9
	65OHW541616	1437	1508	54	16	16	4	89.5	10.75
	65OHW601616	1484	1559	59.75	15.75	16	4	96	11.5
	65OHW661616	1565	1643	65.75	15.75	16	4	102	12.75
	65OHW721616	1645	1729	71.75	15.75	16	4	109	13.75
	65OHW781616	1729	1816	77.75	15.75	16	4	109	13.75
	65OHW841616	2587	2717	83.75	16	16	4	129	16.25
	65OHW901616	2154	2261	89.5	15.75	16	6	109	13.75
65OHW961616	2263	2376	95.5	16	16	6	129	16.25	
Single Height Overhead, Wood Flip Doors	65OHFW361616	1371	1439	35.75	15.75	16	1	64	7
	65OHFW421616	1429	1501	41.75	15.75	16	1	71	8.5
	65OHFW481616	1527	1603	47.75	15.75	16	1	82	9
	65OHFW541616	1713	1797	54	16	16	2	89.5	10.75
	65OHFW601616	1760	1849	59.75	15.75	16	2	96	11.5
	65OHFW661616	1840	1934	65.75	15.75	16	2	102	12.75
	65OHFW721616	1922	2018	71.75	15.75	16	2	109	13.75
	65OHFW781616	2004	2106	77.75	15.75	16	2	109	13.75
	65OHFW841616	2430	2551	83.75	16	16	2	129	16.25
	65OHFW901616	2538	2664	89.5	15.75	16	2	109	13.75
65OHFW961616	2863	3008	95.5	16	16	2	180	16.5	

**ORDERING NOTES:** Overheads and Hutches come standard with LED lights.

## ORDERING PROCEDURE

To order, please specify the following:

- 1) Krug product model number
- 2) Wood species and finish
- 3) Grommet location and style if applicable.

\* Indicates model illustrated by line drawing

## CODE DESCRIPTION

- 4 - full height pedestal  
 L - left hand position  
 R - right hand position

## STANDARD FINISHES

For a complete list of standard wood finishes, please see page 518.





## LOCKS

Locks are available at an upcharge of **\$152 list**. Locks not available on sliding hood over-heads.

## PALETTE FINISH

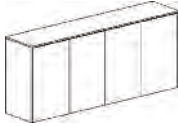
Door fronts are available in Palette at no upcharge, add P at the end of the model number.

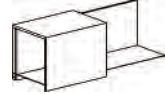
LATITUDE | OVERHEADS

Description	Model	Rift Oak	Walnut	W	D	H	Doors	Shipping Weight	Cubic Feet
 Double Height, Wood Doors	65OHW361630	1728	1815	35.75	15.75	16	2	64	7
	65OHW421630	1892	1987	41.75	15.75	16	2	71	8.5
	65OHW481630	2029	2131	47.75	15.75	16	3	82	9
	65OHW541630	2131	2237	53.75	15.75	16	4	89.5	10.75
	65OHW601630	2237	2347	59.75	15.75	16	4	96	11.5
	65OHW661630	2347	2464	65.75	15.75	16	4	102	12.75
	65OHW721630	2464	2587	71.75	15.75	16	4	109	13.75
	65OHW781630	2587	2717	83.75	15.75	16	4	129	16.25
	65OHW841630	2717	2853	71.75	15.75	16	6	109	13.75
	65OHW901630	2853	2996	83.75	15.75	16	6	129	16.25
65OHW961630	2996	3146							
 Double Height, Wood Flip Doors	65OHFFW361630	1865	1959	35.75	15.75	30	2	107	7
	65OHFFW421630	2030	2132	41.75	15.75	30	2	117	8.5
	65OHFFW481630	2166	2274	47.75	15.75	30	2	132	9
	65OHFFW541630	2406	2526	53.75	15.75	30	4	143	10.75
	65OHFFW601630	2511	2637	59.75	15.75	30	4	153	11.5
	65OHFFW661630	2623	2754	65.75	15.75	30	4	163	12.75
	65OHFFW721630	2741	2878	71.75	15.75	30	4	174	13.75
	65OHFFW781630	2863	3008	83.75	15.75	30	4	177	16.25
	65OHFFW841630	2992	3142	71.75	15.75	30	4	185	13.75
	65OHFFW901630	3131	3287	83.75	15.75	30	4	201	16.25
65OHFFW961630	3271	3435	95.75	1' 3/4"	30	4	209	17.75	
 Double Height, Wood Flip Doors/ Open	65OHFOW361630	2003	2105	35.75	15.75	16	1	64	7
	65OHFOW421630	2167	2277	41.75	15.75	16	1	71	8.5
	65OHFOW481630	2303	2419	47.75	15.75	16	1	82	9
	65OHFOW541630	2682	2816	53.75	15.75	16	2	89.5	10.75
	65OHFOW601630	2788	2927	59.75	15.75	16	2	96	11.5
	65OHFOW661630	2899	3043	65.75	15.75	16	2	102	12.75
	65OHFOW721630	3015	3165	71.75	15.75	16	2	109	13.75
	65OHFOW781630	3138	3295	83.75	15.75	16	2	129	16.25
	65OHFOW841630	3268	3432	71.75	15.75	16	2	109	13.75
	65OHFOW901630	3405	3577	83.75	15.75	16	2	129	16.25
65OHFOW961630	3547	3727	95.75	15.75	16	2	250	46	
 Single Height Over-head, Sliding 30" Hood, Metal Shelf	65OMW481718HD30*	4162	4371	47.75	17	18		95	10
	65OMW601718HD30	4407	4630	59.75	17	18		112	12
	65OMW661718HD30	4518	4744	65.75	17	18		121	13
	65OMW721718HD30	4630	4861	71.5	17	18		129	14.5
	65OMW781718HD30	4755	4992	77.5	17	18		148	15.5
	65OMW841718HD30	4846	5090	83.5	17	18		157	16.5
	65OMW901718HD30	4957	5205	89.5	17	18		166	17.5
	65OMW961718HD30	5040	5293	95.5	17	18		174	19
 Single Height Over-head, Sliding 36" Hood, Metal Shelf	65OMW481718HD36	4190	4399	47.75	17	18		95	10
	65OMW601718HD36	4433	4655	59.75	17	18		112	12
	65OMW661718HD36	4545	4772	65.75	17	18		121	13
	65OMW721718HD36	4655	4888	71.5	17	18		129	14.5
	65OMW781718HD36	4781	5020	77.5	17	18		148	15.5
	65OMW841718HD36	4874	5117	83.5	17	18		157	16.5
	65OMW901718HD36	4983	5233	89.5	17	18		166	17.5
	65OMW961718HD36*	5066	5320	95.5	17	18		174	19

**ORDERING NOTES:** Overheads come standard with LED lights. "90" and "96" Overheads are available with 2 hoods, add -2 to the end of the model number and **\$1778 list** for 30" and **\$1834 list** for 36".

**DIMENSION KEY**

W — width  
 D — depth  
 H — height of worksurface  
 KW — kneehole width

Dimensions are in inches and approximate. Contact Customer Service if dimensions are critical.

**CODE DESCRIPTION**





HD - sliding hood  
 FF - double flip doors  
 FO - flip doors upper, open lower

**VENEER**

Latitude is available in Quarter Cut Walnut and Rift Cut Oak veneers, and each is priced in this price guide. Maple and Cherry are also available: for Flat Cut Maple or Cherry veneer, use Column 1 pricing; for Quarter Cut Maple or Cherry, use Column 2 pricing. Other veneers are also available on Latitude, please contact us for a quote.





# LATITUDE | OVERHEADS

Description	Model	Rift		W	D	H	Shipping Weight	Cubic Feet
		Oak	Walnut					
Single Height Overhead, Open Metal Shelf 	65OMW481718	3161	3320	47.75	16	16	95	10
	65OMW601718	3374	3542	59.75	16	16	112	12
	65OMW661718	3497	3671	65.75	16	16	121	13
	65OMW721718	3596	3774	71.5	16	16	129	14.5
	65OMW781718	3710	3895	77.5	16	16	148	15.5
	65OMW841718	3786	3975	83.5	16	16	157	16.5
	65OMW901718	3882	4079	89.5	16	16	166	17.5
	65OMW961718	3969	4168	95.5	16	16	174	19
	<hr/>							
Double Height Overhead, Wood Sliding 30" Hood, Metal Shelf 	65OMW481731HD30	5365	5634	47.75	17	31	95	10
	65OMW601731HD30	5636	5917	59.75	17	31	112	12
	65OMW661731HD30	5738	6023	65.75	17	31	121	13
	65OMW721731HD30	5975	6273	71.5	17	31	129	14.5
	65OMW781731HD30	6002	6303	77.5	17	31	148	15.5
	65OMW841731HD30	6108	6414	83.5	17	31	157	16.5
	65OMW901731HD30	6230	6542	89.5	17	31	166	17.5
	65OMW961731HD30	6315	6630	95.5	17	31	174	19
	<hr/>							
Double Height Overhead, Wood Sliding 36" Hood, Metal Shelf 	65OMW481731HD36	5398	5668	47.75	17	31	95	10
	65OMW601731HD36	5671	5955	59.75	17	31	112	12
	65OMW661731HD36	5770	6059	65.75	17	31	121	13
	65OMW721731HD36	6009	6311	71.5	17	31	129	14.5
	65OMW781731HD36	6035	6337	77.5	17	31	148	15.5
	65OMW841731HD36	6141	6449	83.5	17	31	157	16.5
	65OMW901731HD36	6266	6579	89.5	17	31	166	17.5
	65OMW961731HD36	6348	6665	95.5	17	31	174	19
	<hr/>							
Double Height Overhead, Open Metal Shelf 	65OMW481731	4427	4649	47.75	16	30	95	10
	65OMW601731	4698	4932	59.75	16	30	112	12
	65OMW661731	4799	5038	65.75	16	30	121	13
	65OMW721731	5037	5289	71.5	16	30	129	14.5
	65OMW781731	5065	5319	77.5	16	30	148	15.5
	65OMW841731	5170	5429	83.5	16	30	157	16.5
	65OMW901731	5293	5558	89.5	16	30	166	17.5
	65OMW961731	5378	5646	95.5	16	30	174	19

**ORDERING NOTES:** Overheads come standard with LED lights. "90" and "96" Overheads are available with 2 hoods, add -2 to the end of the model number and **\$1778 list for 30"** and **\$1834 list for 36"**.

ORDERING PROCEDURE	CODE DESCRIPTION	STANDARD FINISHES
To order, please specify the following: 1) Krug product model number 2) Wood species and finish 3) Grommet location and style if applicable.	HD - sliding hood FF - double flip doors	For a complete list of standard wood finishes, please see page 518.
* Indicates model illustrated by line drawing		

# LATITUDE | TACKBOARDS FOR OVERHEADS

Description	Model	GRADES									W	H	COM	WT
		1	2	3	4	5	6	7	8	9				
Wall Mounted Tackboard 24" High 	65TBOHW3624	333	369	407	465	605	741	875	1018	1198	35.75	24	1.5	1.5
	65TBOHW4224	369	497	529	654	785	908	1038	1199	1421	41.75	24	1.5	1.75
	65TBOHW4824	411	512	536	673	807	924	1066	1228	1478	47.75	24	1.75	2
	65TBOHW5424	434	537	561	706	846	971	1120	1288	1551	53.75	24	2	2.25
	BOHW6024	468	624	655	816	982	1163	1345	1527	1815	59.75	24	2	2.5
	BOHW6624	513	697	746	909	1089	1295	1473	1683	2006	65.75	24	2	2.75
	BOHW7224	562	864	898	1192	1464	1483	1702	1942	2264	71.75	24	2.25	3
	BOHW7824	619	949	988	1311	1612	1633	1872	2135	2491	77.75	24	2.25	3.25
	BOHW8424	723	1109	1155	1534	1884	1908	2191	2500	2913	83.75	24	2.5	3.5
	BOHW9024	761	1165	1215	1611	1982	2004	2302	2629	3061	89.75	24	2.75	3.75
	BOHW9624	791	1212	1265	1676	2061	2087	2396	2736	3188	95.75	24	3	4
Wall Mounted Tackboard 30" High 	65TBOHW3630	399	444	488	559	727	888	1222	1222	1437	35.75	24	1.5	2
	65TBOHW4230	444	552	633	784	943	1088	1439	1439	1697	41.75	24	1.5	2.25
	65TBOHW4830	493	614	642	806	967	1108	1473	1473	1771	47.75	24	1.75	2.5
	65TBOHW5430	520	644	674	848	1016	1165	1547	1547	1860	53.75	24	2	2.75
	BOHW6030	561	749	784	979	1177	1394	1833	1833	2177	59.75	24	2	3
	BOHW6630	615	837	894	1090	1307	1555	2018	2018	2407	65.75	24	2	3.25
	BOHW7230	674	1033	1074	1428	1755	1778	2329	2329	2715	71.75	24	2.25	3.5
	BOHW7830	741	1138	1187	1572	1935	1957	2566	2566	2989	77.75	24	2.5	3.75
	BOHW8430	869	1331	1386	1841	2261	2287	2999	2999	3495	83.75	24	2.5	4
	BOHW9030	913	1398	1458	1934	2378	2407	3153	3153	3673	89.75	24	2.75	4.75
	BOHW9630	952	1456	1518	2014	2478	2506	3280	3280	3825	95.75	24	3	5

**DIMENSION KEY**

- W — width
- D — depth
- H — height of worksurface
- KW— kneehole width

Dimensions are in inches and approximate. Contact Customer Service if dimensions are critical.

**VENEER**

Latitude is available in Quarter Cut Walnut and Rift Cut Oak veneers, and each is priced in this price guide. Maple and Cherry are also available: for Flat Cut Maple or Cherry veneer, use Column 1 pricing; for Quarter Cut Maple or Cherry, use Column 2 pricing. Other veneers are also available on Latitude, please contact us for a quote.

# LATITUDE | HUTCHES

Description	Model	Rift		W	D	H	Doors	Shipping Weight	Cubic Feet
		Oak	Walnut						
5 Hi Hutch with Wood Doors 	65HT601640	2922	3069	59.75	15.75	40	4	117	23
	65HT661640	3112	3267	65.75	15.75	40	4	126	26
	65HT721640	3555	3733	71.75	15.75	40	4	135	28
	65HT781640	3831	4023	77.75	15.75	40	4	146	30
	65HT841640	4108	4313	83.75	15.75	40	4	154	32
	65HT961640	4173	4381	95.5	15.75	40	6	211	39
	65HT1021640	5106	5361	102	15.75	40	6	296	43
	65HT1081640	5302	5566	108	15.75	40	6	310	58.5

**ORDERING NOTES:** Hutches 102" and longer are 2 piece units.

5 Hi Hutch with Wood Flip Doors 	65HTF601640	3197	3357	59.75	15.75	40	2	117	23
	65HTF661640	3386	3557	65.75	15.75	40	2	126	26
	65HTF721640	3830	4022	71.75	15.75	40	2	135	28
	65HTF781640	4108	4313	77.75	15.75	40	2	146	30
	65HTF841640	4382	4603	83.75	15.75	40	2	154	32
	65HTF961640	4449	4670	95.5	15.75	40	2	211	39

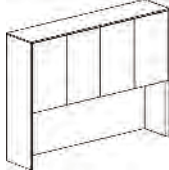
6 Hi Hutch with Wood Doors 	65HT601653	3012	3162	59.75	15.75	53.5	4	249	34.5
	65HT661653	3269	3433	65.75	15.75	53.5	4	269	37.75
	65HT721653	3714	3902	71.75	15.75	53.5	4	289	41
	65HT781653	4016	4217	77.75	15.75	53.5	4	298	44.5
	65HT841653	4315	4531	83.75	15.75	53.5	4	328	47.75
	65HT961653	4498	4721	95.5	15.75	53.5	6	358	52.5

6 Hi Hutch with Wood Flip Doors 	65HTFF601653	3289	3453	59.75	15.75	53.5	4	249	34.5
	65HTFF661653	3545	3723	65.75	15.75	53.5	4	269	37.75
	65HTFF721653	3991	4190	71.75	15.75	53.5	4	289	41
	65HTFF781653	4292	4507	77.75	15.75	53.5	4	298	44.5
	65HTFF841653	4590	4819	83.75	15.75	53.5	4	328	47.75
	65HTFF961653	4772	5010	95.5	15.75	53.5	4	358	52.5

6 Hi Hutch with Wood Flip Doors/Open 	65HTFO601653	3563	3741	59.75	15.75	53.5	2	249	35.5
	65HTFO661653	3820	4013	65.75	15.75	53.5	2	269	37.75
	65HTFO721653	4266	4481	71.75	15.75	53.5	2	289	41
	65HTFO781653	4567	4796	77.75	15.75	53.5	2	298	44.5
	65HTFO841653	4866	5110	83.75	15.75	53.5	2	328	47.75
	65HTFO961653	5049	5300	95.5	15.75	53.5	2	358	52.5

**ORDERING NOTES:** Hutches come standard with LED lights. To specify a Voice/Power/Data module with any hutch, please add "W" at the end of the model number and a **\$252 list** upcharge. Locks are available at an upcharge of **\$152 list**.

## ORDERING PROCEDURE

- To order, please specify the following:
- 1) Krug product model number
  - 2) Wood species and finish
  - 3) Grommet location and style if applicable.

\* Indicates model illustrated by line drawing

## CODE DESCRIPTION

- F - flip doors  
 FF - double flip doors  
 FO - flip doors upper, open lower

## STANDARD FINISHES

For a complete list of standard wood finishes, please see page 518.

## KRUG TEXTILES

For a Krug Panel Fabric program, please see page 4.

# LATITUDE | PIERS, ACCESSORIES & TACKBOARD FABRIC UPGRADE

Description	Model	Rift		W	D	H	Shipping Weight	Cubic Feet
		Oak	Walnut					
 Pier Closed, Hinged Wood Door	65PR24164011L	1227	1289	24	15.75	40	123	11.25
	65PR24164011R	1227	1289	24	15.75	40	123	11.25
	65PR24164611L	1285	1349	24	15.75	46	134	12.75
	65PR24164611R	1285	1349	24	15.75	46	134	12.75
	65PR24165311L	1345	1412	24	15.75	53	148	14.75
	65PR24165311R	1345	1412	24	15.75	53	148	14.75
	65PR24165911L	1403	1474	24	15.75	59	159	16.5
	65PR24165911R	1403	1474	24	15.75	59	159	16.5

Keyboard Tray for Standard Units	65KBAMT1912	411		28	-	8.25	20	
	65KBAMT1912S	483		28	-	8.25	20	



Keyboard Tray for Angled & Curved Units	65KBAMT1912X	428		28	-	8.25	20	
---	--------------	-----	--	----	---	------	----	--



Pencil Drawer	65PD2119	345		21	19	2	2	1
	65PD2119S	381		21	19	2	2	1



Pencil Cup	65APH	193					1	0.25
------------	-------	-----	--	--	--	--	---	------



Height Adjustable Table Programmable Display- 4 Position Memory	88HAPD	376			-	-	-	-	-
---	--------	-----	--	--	---	---	---	---	---

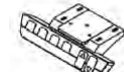

Description	Model	GRADES								
		2	3	4	5	6	7	8	9	COM
Tackboard Fabric	60	143	309	468	633	799	962	1131	1327	2
Upcharges for Hutches	66	165	359	521	697	869	1021	1199	1487	2
	72	199	426	622	837	1036	1236	1437	1727	2.25
	78	234	500	735	974	1206	1443	1677	2003	2.5
	84	278	580	859	1136	1414	1690	1965	2322	2.5
	90	287	601	894	1179	1467	1755	2043	2415	2.75
	96	299	626	930	1228	1528	1827	2126	2634	3
	102	331	714	1048	1403	1743	2070	2433	2988	3
	108	363	781	1149	1536	1909	2271	2638	3273	3



**DIMENSION KEY**

- W — width
- D — depth
- H — height of worksurface
- KW— kneehole width

Dimensions are in inches and approximate. Contact Customer Service if dimensions are critical.

**CODE DESCRIPTION**

- 11 - closed bookcase
- L - left hand position
- R - right hand position

**VENEER**

Latitude is available in Quarter Cut Walnut and Rift Cut Oak veneers, and each is priced in this price guide. Maple and Cherry are also available: for Flat Cut Maple or Cherry veneer, use Column 1 pricing; for Quarter Cut Maple or Cherry, use Column 2 pricing. Other veneers are also available on Latitude, please contact us for a quote.

# LATITUDE | WALL MOUNTED BACK-PAINTED GLASS

Description	Model	Price	W	D	H	Shipping Weight	Cubic Feet
Wall Mounted	65GPW3624	1765	35.75	-	23.5	48	1.5
Back-painted	65GPW4224	1852	41.75	-	23.5	56	1.75
Glass 23.5"	65GPW4824	1936	47.75	-	23.5	64	2
	65GPW5424	2023	53.75	-	23.5	72	2.25
	65GPW6024	2136	59.75	-	23.5	80	2.5
	65GPW6624	2295	65.75	-	23.5	88	2.75
	65GPW7224	2452	71.5	-	23.5	96	3
	65GPW7824	2638	77.5	-	23.5	104	3.25
	65GPW8424	2810	83.5	-	23.5	112	3.5
	65GPW9024	3255	89.5	-	23.5	120	3.75
	65GPW9624	3384	95.5	-	23.5	128	4

**ORDERING NOTES:** Use between wall mounted overheads and full height credenzas. Wall mounted Back-Painted glass panels 90" and longer are 2-pieces. Standard finish is white

Wall Mounted	65GPW3630	2108	35.75	-	30	60	2
Back-painted	65GPW4230	2221	41.75	-	30	70	2.25
Glass 30"	65GPW4830	2323	47.75	-	30	80	2.5
	65GPW5430	2410	53.75	-	30	90	2.75
	65GPW6030	2567	59.75	-	30	100	3.25
	65GPW6630	2768	65.75	-	30	110	3.5
	65GPW7230	2984	71.5	-	30	120	3.75
	65GPW7830	3184	77.5	-	30	130	4
	65GPW8430	3428	83.5	-	30	140	4.25
	65GPW9030	3628	89.5	-	30	150	4.75
	65GPW9630	3798	95.5	-	30	160	5

**ORDERING NOTES:** Use between wall mounted overheads and 3/4 height credenzas. Wall mounted Back-Painted glass panels 90" and longer are 2-pieces. Standard finish is white

Wall Mounted Mag-	65GPW3624M	1936	35.75	-	23.5	48	1.5
netic Back-painted	65GPW4224M	2053	41.75	-	23.5	56	1.75
Glass 23.5"	65GPW4824M	2166	47.75	-	23.5	64	2
	65GPW5424M	2280	53.75	-	23.5	72	2.25
	65GPW6024M	2422	59.75	-	23.5	80	2.5
	65GPW6624M	2625	65.75	-	23.5	88	2.75
	65GPW7224M	2824	71.5	-	23.5	96	3
	65GPW7824M	3055	77.5	-	23.5	104	3.25
	65GPW8424M	3269	83.5	-	23.5	112	3.5
	65GPW9024M	3757	89.5	-	23.5	120	3.75
	65GPW9624M	3930	95.5	-	23.5	128	4

**ORDERING NOTES:** Use between wall mounted overheads and full height credenzas. Strong magnets (not supplied) are recommended. Wall mounted Back-Painted glass panels 90" and longer are 2-pieces. Standard finish is white.

Wall Mounted Mag-	65GPW3630M	2323	35.75	-	30	60	2
netic Back-painted	65GPW4230M	2465	41.75	-	30	70	2.25
Glass 30"	65GPW4830M	2595	47.75	-	30	80	2.5
	65GPW5430M	2723	53.75	-	30	90	2.75
	65GPW6030M	2911	59.75	-	30	100	3.25
	65GPW6630M	3156	65.75	-	30	110	3.5
	65GPW7230M	3412	71.5	-	30	120	3.75
	65GPW7830M	3656	77.5	-	30	130	4
	65GPW8430M	3941	83.5	-	30	140	4.25
	65GPW9030M	4186	89.5	-	30	150	4.75
	65GPW9630M	4401	95.5	-	30	160	5

**ORDERING NOTES:** Use between wall mounted overheads and 3/4 height credenzas. Strong magnets (not supplied) are recommended. Wall mounted Back-Painted glass panels 90" and longer are 2-pieces. Standard finish is white.

## ORDERING PROCEDURE

To order, please specify the following:  
 1) Krug product model number  
 2) Wood species and finish  
 3) Grommet location and style if applicable.

\* Indicates model illustrated by line drawing

## CODE DESCRIPTION

M - Magnetic

## STANDARD FINISHES

For a complete list of standard wood finishes, please see page 518.

# POWERPORTS

Description	Model	Price	W	D	H	Shipping Weight	Cubic Feet
PowerPort 1 - 2 RJ45s (Category 5/6)	PORT1	278	8	4	-	-	-

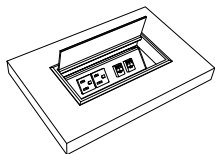

**Port Includes:** 2 accessible power outlets & 1 side utility outlet powered by a 10' plug-in cord; 2 RJ45 (category 5/6) each with hard wired 10' data cords; 2 velcro wire managers and metal PowerPort shroud. PortPort lid is Silver Metallic.  
**NOTE:** RJ45 jacks with hard wired data cords included here must be within 10' of building utilities source to be functional.

PowerPort 2 - USB-A & USB-C	PORT2	280	8	4	-	-	-
--------------------------------	-------	-----	---	---	---	---	---

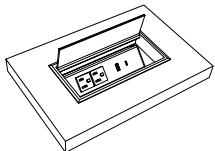

**Port Includes:** 2 accessible power outlets & 1 side utility outlet; 1 USB-A & 1 USB-C charging ports all powered by a 10' plug-in cord; 2 velcro wire managers and metal PowerPort shroud. PortPort lid is Silver Metallic.

PowerPort 3 - RJ11 & RJ45	PORT3	269	8	4	-	-	-
------------------------------	-------	-----	---	---	---	---	---

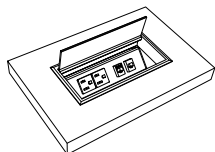

**Port Includes:** 2 accessible power outlets & 1 side utility outlet; 1 RJ11 & 1 RJ45 (Category 5/6); 2 Velcro wire managers & PowerPort Shroud; 1 x 10 Foot Data Cords (T568A) & 1 x 14 Foot RJ11 (Telecomm); powered by a 10' plug-in cord. PortPort lid is Silver Metallic.  
**NOTE:** RJ45 & RJ11 jacks with hard wired data cords included here must be within 10' of building utilities source to be functional.

PowerPort 4 - 2 USB-A	PORT4	286	8	4	-	-	-
--------------------------	-------	-----	---	---	---	---	---

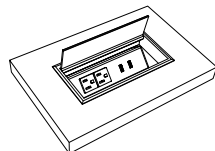

**Port Includes:** 2 accessible power outlets & 1 side utility outlet; 2- USB-A charging ports all powered by a 10' plug-in cord; 2 velcro wire managers and metal PortPort shroud. PortPort lid is Silver Metallic.

PowerPort 5 - 4 Receptacles	PORT5	280	8	4	-	-	-
--------------------------------	-------	-----	---	---	---	---	---

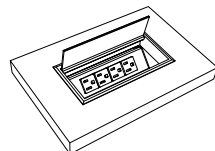

**Port Includes:** 4 accessible power outlets & 1 side utility outlet powered by a 10' plug-in cord; 2 velcro wire managers and metal power port shroud. PortPort lid is Silver Metallic.

PowerPort 6 - USB-A, USB-C & RJ45	PORT6	406	8	4	-	-	-
--------------------------------------	-------	-----	---	---	---	---	---

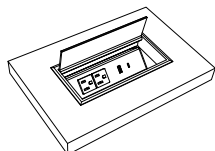

Top View

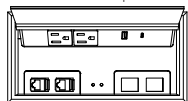

**Port Includes:** 2 accessible power outlets & 1 side utility outlet 1 USB-A, 1 USB-C charging ports all powered by a 10' plug-in power cord. Includes 2 velcro wire managers and metal PortPort shroud with 2 data plate knock outs, 1 #M02 plate insert & 2 #S01W RJ45 female input, punch down terminal output snap in jacks. 2nd data plate knock out is blank for future use. PortPort lid is Silver Metallic.

# POWERPORTS

Description	Model	Price	W	D	H	Shipping Weight	Cubic Feet
Port - no Powerbar	Port0	137	8	4	-	-	-

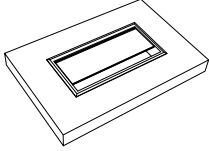

**Port Includes:** Port lid & Shroud only.

**ORDERING NOTE:** Velcro wire managers not included, see below for pricing. Port lid is Silver Metallic.

PowerPort Shroud with 2 Data Plate Knock-outs	SHROUD2KO	Must be requested - no upcharge	-	-	-	-	-
---	-----------	------------------------------------	---	---	---	---	---

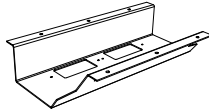

Angled PowerPort Shroud Includes: shroud with 2 data plate knock-outs in the bottom.

**ORDERING NOTE:** Please refer to data plate, data and AV integration options on page XX.

Velcro Wire Manager (qty 1)	WM-4	26	2	4.5	0.5	-	-
-----------------------------	------	----	---	-----	-----	---	---

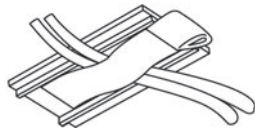

2 velcro wire managers are included with Ports 1-5.

Wire Management Trough	WM-72	182	72	3	1	-	-
------------------------	-------	-----	----	---	---	---	---



Wire Management Trough is standard in a 72" length & can be cut to specific length; double-sided tape installation.

4-Channel Wire Management	CM-72	231	72	3	1	-	-
---------------------------	-------	-----	----	---	---	---	---

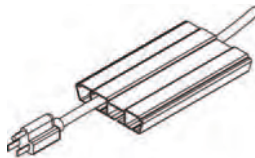



4-Channel Wire Management is standard in a 72" length & can be cut to specific length; double-sided tape installation.

Round Grommet	Round Grommet - Silver Metallic	152	-	-	-	-	-
	Round Grommet - Black	152	-	-	-	-	-

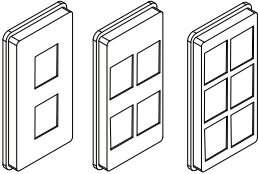

One 60mm Grommet in a standard position is available at no charge per table.

## POWER/DATA

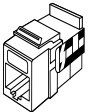
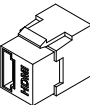
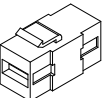
SNAP IN PORTS	Reference Code	Description	List Price
<b>ADAPTOR PLATES</b>			
	<b>M02</b>	<b>Adaptor Plate (2)</b> - accepts two snap in data ports	38
	<b>M04</b>	<b>Adaptor Plate (4)</b> - accepts four snap in data ports	38
	<b>M06</b>	<b>Adaptor Plate (6)</b> - accepts six snap in data ports	38
<b>ORDERING NOTES:</b> Blank covers are required when port is not in use, please see page 55.			
		<b>RJ-45</b> - Category 6 data connection. This connector is also downwards compatible with Category 5 cabling. Connector is a female input with a #110 punch-down terminal block output (back side of Console interface) for on-site hard wire connection.	47
	<b>S01W</b>	RJ45-CAT6 (White)	
	<b>S01B</b>	RJ45-CAT6 (Blue)	
	<b>S01R</b>	RJ45-CAT6 (Red)	
		<b>RJ11</b> - Telephone type connection. Connector is a female input with a #110 punch-down terminal block output (back side of Console interface) for on-site hard wire connection.	32
	<b>S02W</b>	RJ11 (White)	
	<b>S02B</b>	RJ11-B (Black)	
	<b>S02G</b>	RJ11-G (Green)	
	<b>S02R</b>	RJ11-R (Red)	
	<b>S02Y</b>	RJ11-Y (Yellow)	
	<b>S04</b>	<b>HDMI</b> - High Definition Multimedia Interface connection. Connector carries both HD audio and video data. Connector is a female-to-female pass through.	173
	<b>S08</b>	<b>USB-A</b> - Full size USB "A" style connection. Connector is a female-to-female pass through.	61



# LATITUDE | POWER & CABLE MANAGEMENT

Description	Model	Price	W	D	H	Shipping Weight	Cubic Feet
	65CT36	59	30	2	-	.25	-
	65CT42	74	36	2	-	.25	-
	65CT48	91	36	2	-	.25	-
	65CT54	105	48	2	-	.5	-
	65CT60	121	48	2	-	.5	-
	65CT66	137	52	2	-	.5	-
	65CT72	152	60	2	-	.75	-
	65CT84	168	60	2	-	.75	-

**NOTE:** For Desk Runoffs only.

Height Adjustable Work Surface Cable Manager	65HACM	89	4	3	21.5	5	.25
--	--------	----	---	---	------	---	-----

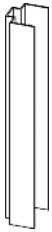

Power, Data, Voice Module	65PDVM	226	-	-	-	-	-
---------------------------	--------	-----	---	---	---	---	---



Height Adjustable Table Programmable Display- 4 Position Memory	88HAPD	376	-	-	-	-	-
---	--------	-----	---	---	---	---	---



## ORDERING PROCEDURE

To order, please specify the following:





- 1) Krug product model number
- 2) Wood species and finish
- 3) Grommet location and style if applicable.

\* Indicates model illustrated by line drawing

## STANDARD FINISHES

For a complete list of standard wood finishes, please see page 518.

# LATITUDE | PEDESTALS FOR SHELLS

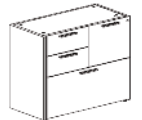
Description	Model	Rift		W	D	H	Shipping Weight	Cubic Feet
		Oak	Walnut					
Pedestal Box/Box/File	65P16184F*	1378	1447	15.75	18	28.5	61	6.5
	65P16284F	1592	1671	15.75	27.5	28.5	66	9
								
Pedestal File/File	65P16184D*	1272	1335	15.75	18	28.5	61	6.5
	65P16284D	1484	1559	15.75	27.5	28.5	66	9
								
Pedestal Bookcase	65P301811*	1477	1551	30	18	28.5	104	11.5
	65P361811	1653	1735	36	18	28.5	112	13.5
								
Pedestal Lateral File	65P301801*	1695	1780	30	18	28.5	104	11.5
	65P361801	1899	1995	36	18	28.5	112	13.5
								
Pedestal 36" File/2 Box, Lateral File Combination	65P361802	1866	1960	36	18	28.5	112	13.5
	65P361804*	1866	1960	36	18	28.5	112	13.5
								

**ORDERING NOTES:** When specifying modular pedestals please state left, center or right. For a pedestal in the left position add L to the end of the model number, for a pedestal in the center position add C to the end of the model number and for a pedestal in the right position add R to the end of the model number.

**DIMENSION KEY**

W – width  
 D – depth  
 H – height of worksurface  
 KW – kneehole width

Dimensions are in inches and approximate.  
 Contact Customer Service if dimensions are critical.

**CODE DESCRIPTION**

4 - full height pedestal  
 D - 2 file drawers  
 F - 2 box, 1 file drawer  
 11 - closed bookcase  
 01 - lateral file  
 02 - 2 box on right, 1 file drawer left, lateral file  
 04 - 1 file drawer right, 2 box on left, lateral file  
 L - left hand position  
 R - right hand position  
 C - center position

**VENEER**

Latitude is available in Quarter Cut Walnut and Rift Cut Oak veneers, and each is priced in this price guide. Maple and Cherry are also available; for Flat Cut Maple or Cherry veneer, use Column 1 pricing; for Quarter Cut Maple or Cherry, use Column 2 pricing. Other veneers are also available on Latitude, please contact us for a quote.

# LATITUDE | BOOKCASES

Description	Model	Rift		W	D	H	Shipping Weight	Cubic Feet
		Oak	Walnut					
2 Hi Open Bookcase	65BC301629	1715	1801	30	16	29	48	10
	65BC361629	1761	1852	36	16	29	56	12



3 Hi Bookcase, Open	65BC361643	2085	2190	36	16	42.75	72	21.75
---------------------	------------	------	------	----	----	-------	----	-------



4 Hi Bookcase, Open	65BC301656	2122	2229	30	16	56	64	18
	65BC361656	2170	2280	36	16	56	120	20.75



5 Hi Bookcase, Open	65BC301670	2301	2415	30	16	69.5	100	22.5
	65BC361670	2347	2464	36	16	69.5	112	27



6 Hi Bookcase, Open	65BC301683	2699	2835	30	16	83	163	28.25
	65BC361683	2765	2904	36	16	83	178	33



## ORDERING NOTES:

Bookcases must be fastened to the wall. Hardware is not supplied.

### ORDERING PROCEDURE

To order, please specify the following:

- 1) Krug product model number
- 2) Wood species and finish
- 3) Grommet location and style if applicable.

\* Indicates model illustrated by line drawing

### STANDARD FINISHES

For a complete list of standard wood finishes, please see page 518.

**LATITUDE | STORAGE**

Description	Model	Rift		W	D	H	Shipping Weight	Cubic Feet
		Oak	Walnut					
1.5 Hi Storage, Closed Bookcase	65ST30242311	2149	2255	30	24	23	96	11
	65ST36242311	2318	2433	36	24	23	98	13



1.5 Hi Storage, Box/Lateral File	65ST30242316	2510	2636	30	24	23	159	11
	65ST36242316*	2684	2820	36	24	23	165	13



1.5 Hi Storage, Open	65ST30242317	1927	2024	30	24	23	100	11
	65ST36242317	2084	2189	36	24	23	112	13



2 Hi Storage Unit Closed Bookcase	65ST36202911	2231	2341	36	20	29	163	13.75
	65ST36242911	2417	2538	36	24	29	175	16.25

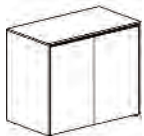

2 Hi Storage Unit Lateral File	65ST30202901	2605	2736	30	20	29	112	11.5
	65ST30242901	2733	2869	30	24	29	116	13.75
	65ST36202901*	2940	3087	36	20	29	116	13.75
	65ST36242901	2982	3131	36	24	29	120	16.75



3 Hi Storage, Lateral Files	65ST36204301	3921	4117	36	20	42.75	175	19.75
	65ST36244301	4176	4385	36	24	42.75	187	23.5



**DIMENSION KEY**

W – width  
 D – depth  
 H – height of worksurface  
 KW – kneehole width

Dimensions are in inches and approximate. Contact Customer Service if dimensions are critical.

**CODE DESCRIPTION**

11 - closed bookcase  
 16 - box, lateral file  
 01 - lateral file

**VENEER**

Latitude is available in Quarter Cut Walnut and Rift Cut Oak veneers, and each is priced in this price guide. Maple and Cherry are also available: for Flat Cut Maple or Cherry veneer, use Column 1 pricing; for Quarter Cut Maple or Cherry, use Column 2 pricing. Other veneers are also available on Latitude, please contact us for a quote.

# LATITUDE | STORAGE

Description	Model	Rift		W	D	H	Shipping Weight	Cubic Feet
		Oak	Walnut					
4 Hi Storage, Lateral Files	65ST30205601	3418	3589	30	20	56	151	21.75
	65ST36205601	3845	4037	36	20	56	176	25.75
	65ST36245601	4088	4292	36	24	56	196	30.75



5 Hi 19" Storage Closed Shelves	65ST19247011L	3321	3487	19	24	69.5	132	20
	65ST19247011R	3321	3487	19	24	69.5	132	20



5 Hi 19" Storage, 2 File, 3 Open Shelves	65ST19247090	3360	3530	19	24	69.5	132	20
--	--------------	------	------	----	----	------	-----	----



5 Hi 19" Storage, 2 File, 3 Closed Shelves	65ST19247091L	3604	3785	19	24	69.5	132	21.75
	65ST19247091R	3604	3785	19	24	69.5	132	21.75



## ORDERING PROCEDURE

To order, please specify the following:

- 1) Krug product model number
- 2) Wood species and finish
- 3) Grommet location and style if applicable.

\* Indicates model illustrated by line drawing

## CODE DESCRIPTION

- L - left hand position
- R - right hand position
- 01 - lateral file

## STANDARD FINISHES

For a complete list of standard wood finishes, please see page 518.

## PALETTE FINISH

Storage full fronts are available in Palette finish.

Door fronts only at no upcharge. Drawer fronts or combination Drawer/Door fronts at **\$357 list** per unit.

Add a "P" to the end of the model number and include color selection. See Page 518 for standard colors.

# LATITUDE | STORAGE

Description	Model	Rift		W	D	H	Shipping Weight	Cubic Feet
		Oak	Walnut					
5 Hi Storage, 2 Lateral File, 3 Open Shelves	65ST36207003	4192	4401	36	20	69.5	180	33.5
	65ST36247003	4239	4454	36	24	69.5	188	39.75



5 Hi Storage, 2 Lateral File, 3 Closed Shelves	65ST30247004	4042	4245	30	24	69.5	240	31.25
	65ST36207004	4678	4912	36	20	69.5	192	33.5
	65ST36247004	4733	4970	36	24	69.5	200	39.75



5 Hi Storage, 2 Closed, 3 Open Shelves	65ST36207013	3353	3520	36	20	69.5	192	33.5
	65ST36247013	3390	3561	36	24	69.5	200	39.75



5 Hi Storage, 3 Lateral file, 2 Closed Shelves	65ST36247008	4817	5059	36	24	69.5	192	39.75
--	--------------	------	------	----	----	------	-----	-------



**DIMENSION KEY**

- W – width
- D – depth
- H – height of worksurface
- KW – kneehole width

Dimensions are in inches and approximate. Contact Customer Service if dimensions are critical.

**VENEER**

Latitude is available in Quarter Cut Walnut and Rift Cut Oak veneers, and each is priced in this price guide. Maple and Cherry are also available: for Flat Cut Maple or Cherry veneer, use Column 1 pricing; for Quarter Cut Maple or Cherry, use Column 2 pricing. Other veneers are also available on Latitude, please contact us for a quote.

# LATITUDE | STORAGE

Description	Model	Rift		W	D	H	Shipping Weight	Cubic Feet
		Oak	Walnut					
6 Hi Storage, Closed Shelves	65ST19248311L	3626	3809	19	24	83	160	26
	65ST19248311R	3626	3809	19	24	83	160	26



6 Hi Storage, 2 File, 4 Open Shelves	65ST19248390	3664	3847	19	24	83	160	26
--------------------------------------	--------------	------	------	----	----	----	-----	----



6 Hi Storage, 2 File, 4 Closed Shelves	65ST19248391L	3920	4116	19	24	83	160	26
	65ST19248391R	3920	4116	19	24	83	160	26



6 Hi Storage, 2 Lateral File, 4 Open Shelves	65ST36208303	4287	4500	36	20	83	216	40
	65ST36248303	4355	4573	36	24	83	224	47.5



## ORDERING PROCEDURE

To order, please specify the following:

- 1) Krug product model number
- 2) Wood species and finish
- 3) Grommet location and style if applicable.

\* Indicates model illustrated by line drawing

## CODE DESCRIPTION

- L - left hand position
- R - right hand position

## STANDARD FINISHES

For a complete list of standard wood finishes, please see page 518.

## LOCKS

Locks are available for an upcharge of **\$152 list**

## PALETTE FINISH

Storage full fronts are available in Palette finish. Door fronts only at no upcharge. Drawer fronts or combination Drawer/Door fronts at **\$357 list** per unit.

Add a "P" to the end of the model number and include color selection. See Page 518 for standard colors.

# LATITUDE | STORAGE & WARDROBES

Description	Model	Rift		W	D	H	Shipping Weight	Cubic Feet
		Oak	Walnut					
6 Hi Storage, 2 Lateral File, 4 Closed Shelves	65ST30248304	4268	4483	30	24	83	279	37.5
	65ST36208304	4706	4942	36	20	83	220	40
	65ST36248304	4758	4996	36	24	83	228	47.5

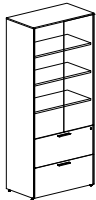

6 Hi Storage, 2 Closed, 4 Open Shelves	65ST36208313	3507	3682	36	20	83	200	40
	65ST36248313	3547	3727	36	24	83	208	40



6 Hi Storage, 3 Lateral File, 3 Closed Shelves	65ST36248308	4998	5247	36	20	83	220	40
--	--------------	------	------	----	----	----	-----	----



5 Hi Wardrobe	65WR19247002L	2756	2893	19	24	69.5	172	20
	65WR19247002R	2756	2893	19	24	69.5	172	20



5 Hi Wardrobe, 2 Files 3 Closed Shelves with Wood Door	65WR24247014	4093	4297	24	24	69.5	260	25.25
	65WR24247015	4093	4297	24	24	69.5	260	25.25
	65WR30247014	4437	4659	30	24	69.5	266	31.25
	65WR30247015*	4437	4659	30	24	69.5	266	31.25
	65WR36247014	4580	4810	36	24	69.5	272	39.75
	65WR36247015	4580	4810	36	24	69.5	272	39.75

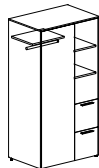

**ORDERING NOTES:** Center hinged storage units require 2 locks.

### DIMENSION KEY

- W — width
- D — depth
- H — height of worksurface
- KW— kneehole width

Dimensions are in inches and approximate. Contact Customer Service if dimensions are critical.

### CODE DESCRIPTION





- L - left hand position
- R - right hand position
- 14 - left closed shelves, 2 file drawers & right closed wardrobe. Hinged center.
- 15 - right closed shelves, 2 file drawers & left closed wardrobe. Hinged center.

### VENEER

Latitude is available in Quarter Cut Walnut and Rift Cut Oak veneers, and each is priced in this price guide. Maple and Cherry are also available: for Flat Cut Maple or Cherry veneer, use Column 1 pricing; for Quarter Cut Maple or Cherry, use Column 2 pricing. Other veneers are also available on Latitude, please contact us for a quote.



# LATITUDE | WARDROBES

Description	Model	Rift		W	D	H	Shipping Weight	Cubic Feet
		Oak	Walnut					
5 Hi Wardrobe with Closed Shelves 	65WR30247001	3160	3319	30	24	69.5	240	31.25
	65WR30247003*	3160	3319	30	24	69.5	240	31.25
	65WR36247001	3514	3688	36	24	69.5	164	39.75
	65WR36247003	3514	3688	36	24	69.5	164	39.75
5 Hi Full Width Wardrobe 	65WR36247002	2936	3083	36	24	69.5	135	39.75
6 Hi Wardrobe 	65WR19248302L 65WR19248302R	2921 2921	3068 3068	19	24	83	172	23.75
6 Hi Wardrobe with Closed Shelves 	65WR30248301*	4407	4630	30	24	83	286	37.5
	65WR30248303	4407	4630	30	24	83	286	37.5
	65WR36248301	4677	4911	36	24	83	272	44.5
	65WR36248303	4677	4911	36	24	83	272	44.5
6 Hi Wardrobe, 2 Files 4 Closed Shelves with Wood Door 	65WR24248314	4474	4697	24	24	83	280	35
	65WR24248315	4474	4697	24	24	83	280	35
	65WR30248314	4603	4834	30	24	83	286	37.5
	65WR30248315*	4603	4834	30	24	83	286	37.5
	65WR36248314	4741	4979	36	24	83	292	44.5
	65WR36248315	4741	4979	36	24	83	292	44.5

**ORDERING NOTES:** Center hinged storage units require 2 locks.

## ORDERING PROCEDURE

To order, please specify the following:

- 1) Krug product model number
- 2) Wood species and finish
- 3) Grommet location and style if applicable.

\* Indicates model illustrated by line drawing

## CODE DESCRIPTION

- 01 - left shelves, right wardrobe
- 03 - right shelves, left wardrobe
- 14 - left closed shelves, 2 file drawers & right closed wardrobe. Hinged center.
- 15 - right closed shelves, 2 file drawers & left closed wardrobe. Hinged center.



## STANDARD FINISHES

For a complete list of standard wood finishes, please see page 518.

## LOCKS

Locks are available on all wood doors at **\$152 list** per lock. 24", 30" & 36" wardrobes require 2 locks.

# LATITUDE | MODULAR COMPONENTS - TOPS

Description	Model	Rift		W	D	H	Shipping Weight	Cubic Feet
		Oak	Walnut					
	650536	1482	1557	36	36	1.13	50	5.75
	650542	1728	1815	42	42	1.13	62	7.5
	650548	1886	1981	48	48	1.13	80	9.5
	650554	2051	2152	54	54	1.13	98	11.5
<hr/>								
	65TP3624	751	786	35.75	24	1.13	47	3
	65TP3630	844	887	35.75	30	1.13	57	3.75
	65TP3636	1014	1064	35.75	36	1.13	57	3.75
	65TP4224	789	829	41.75	24	1.13	47	3
	65TP4230	883	928	41.75	30	1.13	57	3.75
	65TP4236	1061	1113	41.75	36	1.13	57	3.75
	65TP4824	827	869	47.75	24	1.13	47	3
	65TP4830	928	974	47.75	30	1.13	57	3.75
	65TP4836	1114	1169	47.75	36	1.13	57	3.75
	65TP5424	869	913	53.75	24	1.13	47	3
	65TP5430	983	1033	53.75	30	1.13	57	3.75
	65TP5436	1180	1240	53.75	36	1.13	57	3.75
	65TP6020	889	933	59.75	20	1.13	40	3.25
	65TP6024	952	997	59.75	24	1.13	47	3.75
	65TP6030	1038	1090	59.75	30	1.13	57	4.5
	65TP6036	1246	1309	59.75	36	1.13	57	3.75
	65TP6620	1131	1187	65.75	20	1.13	43	3.5
	65TP6624	1169	1227	65.75	24	1.13	50	4
	65TP6630	1210	1271	65.75	30	1.13	64	4.75
	65TP6636	1372	1440	65.75	36	1.13	77	5.5
	65TP7220	1290	1356	71.75	20	1.13	44	3.75
	65TP7224	1335	1402	71.75	24	1.13	55	4.25
	65TP7230	1373	1441	71.75	30	1.13	65	5.25
	65TP7236	1494	1568	71.75	36	1.13	84	6
	65TP7820	1412	1482	77.75	20	1.13	46	4
	65TP7824	1453	1527	77.75	24	1.13	58	4.75
	65TP7830	1497	1570	77.75	30	1.13	75	5.5
	65TP7836	1798	1887	77.75	36	1.13	91	6.5
	65TP8420	1483	1558	83.75	20	1.13	53.5	4.25
	65TP8424	1524	1598	83.75	24	1.13	62.5	5
	65TP8430	1567	1645	83.75	30	1.13	76	6
	65TP8436	1882	1976	83.75	36	1.13	76	5
65TP9024	1632	1714	89.75	24	1.13	47	3	
65TP9030	1683	1767	89.75	30	1.13	57	3.75	
65TP9036	2017	2117	89.75	36	1.13	57	3.75	
65TP9620	1704	1790	95.75	20	1.13	60	5	
65TP9624	1751	1839	95.75	24	1.13	75	5.75	
65TP9630	1803	1893	95.75	30	1.13	85.5	6.75	
65TP9636	2163	2269	95.75	36	1.13	85.5	7	

**DIMENSION KEY**

W — width  
 D — depth  
 H — height of worksurface  
 KW— kneehole width

Dimensions are in inches and approximate.  
 Contact Customer Service if dimensions are critical.

**VENEER**

Latitude is available in Quarter Cut Walnut and Rift Cut Oak veneers, and each is priced in this price guide. Maple and Cherry are also available: for Flat Cut Maple or Cherry veneer, use Column 1 pricing; for Quarter Cut Maple or Cherry, use Column 2 pricing. Other veneers are also available on Latitude, please contact us for a quote.

# LATITUDE | MODULAR COMPONENTS - TOPS

Description	Model	Rift		W	D	H	Shipping Weight	Cubic Feet
		Oak	Walnut					
Modular Return	65TPR3624L	751	786	35.75	24	1.13	43	2.75
Tops	65TPR3624R	751	786	35.75	24	1.13	43	2.75
	65TPR3630L	844	887	35.75	30	1.13	43	2.75
	65TPR3630R	844	887	35.75	30	1.13	43	2.75
	65TPR3636L	1014	1064	35.75	36	1.13	43	2.75
	65TPR3636R	1014	1064	35.75	36	1.13	43	2.75
	65TPR4220L	689	723	41.75	20	1.13	28	1.75
	65TPR4220R	689	723	41.75	20	1.13	28	1.75
	65TPR4224L	789	829	41.75	24	1.13	33	2.25
	65TPR4224R	789	829	41.75	24	1.13	33	2.25
	65TPR4230L	883	928	41.75	30	1.13	43	2.75
	65TPR4230R	883	928	41.75	30	1.13	43	2.75
	65TPR4236L	1061	1113	41.75	36	1.13	43	2.75
	65TPR4236R	1061	1113	41.75	36	1.13	43	2.75
	65TPR4820L	714	749	47.75	20	1.13	31	2
	65TPR4820R	714	749	47.75	20	1.13	31	2
	65TPR4824L	827	869	47.75	24	1.13	36	2.5
	65TPR4824R	827	869	47.75	24	1.13	36	2.5
	65TPR4830L	928	974	47.75	30	1.13	43	2.75
	65TPR4830R	928	974	47.75	30	1.13	43	2.75
	65TPR4836L	1114	1169	47.75	36	1.13	43	2.75
	65TPR4836R	1114	1169	47.75	36	1.13	43	2.75
	65TPR5424L	869	913	53.75	24	1.13	43	2.75
	65TPR5424R	869	913	53.75	24	1.13	43	2.75
	65TPR5430L	983	1033	53.75	30	1.13	43	2.75
	65TPR5430R	983	1033	53.75	30	1.13	43	2.75
	65TPR5436L	1180	1240	53.75	36	1.13	43	2.75
	65TPR5436R	1180	1240	53.75	36	1.13	43	2.75
	65TPR6024L	952	997	59.75	24	1.13	47	3
65TPR6024R	952	997	59.75	24	1.13	47	3	
65TPR6030L	1038	1090	59.75	30	1.13	47	3	
65TPR6030R	1038	1090	59.75	30	1.13	47	3	
65TPR6036L	1246	1309	59.75	36	1.13	47	3	
65TPR6036R	1246	1309	59.75	36	1.13	47	3	
65TPR6624L	1169	1227	65.75	24	1.13	50	3.25	
65TPR6624R	1169	1227	65.75	24	1.13	50	3.25	
65TPR6630L	1210	1271	65.75	30	1.13	50	3.25	
65TPR6630R	1210	1271	65.75	30	1.13	50	3.25	
65TPR6636L	1372	1440	65.75	36	1.13	50	3.25	
65TPR6636R	1372	1440	65.75	36	1.13	50	3.25	
65TPR7224L	1335	1402	71.75	24	1.13	55	3.5	
65TPR7224R	1335	1402	71.75	24	1.13	55	3.5	
65TPR7230L	1373	1441	71.75	30	1.13	55	3.5	
65TPR7230R	1373	1441	71.75	30	1.13	55	3.5	
65TPR7236L	1494	1568	71.75	36	1.13	55	3.5	
65TPR7236R	1494	1568	71.75	36	1.13	55	3.5	
65TPR8424L	1524	1598	83.75	24	1.13	65.5	4.25	
65TPR8424R	1524	1598	83.75	24	1.13	65.5	4.25	
65TPR8430L	1567	1645	83.75	30	1.13	65.5	4.25	
65TPR8430R	1567	1645	83.75	30	1.13	65.5	4.25	
65TPR8436L	1882	1976	83.75	36	1.13	65.5	4.25	
65TPR8436R	1882	1976	83.75	36	1.13	65.5	4.25	

## ORDERING PROCEDURE

To order, please specify the following:

- 1) Krug product model number
- 2) Wood species and finish
- 3) Grommet location and style if applicable.

\* Indicates model illustrated by line drawing







## CODE DESCRIPTION

- L - left hand position
- R - right hand position

## STANDARD FINISHES

For a complete list of standard wood finishes, please see page 518.

# LATITUDE | MODULAR COMPONENTS - SUPPORT

Description	Model	Rift		W	D	H	Shipping Weight	Cubic Feet
		Oak	Walnut					
Half Gable, Desk Height, used with Modesty Panel 	65HG0829	369	388	8	1.12	29	4	1.5
	65HG1229	408	429	12	1.12	29	4	1.5
	Without modesty panel 65HG1029NMP	527	553	10	1.12	29	4	1.5
L Support 	65LB2029L	703	739	17	20	29.5	55	2
	65LB2029R	703	739	17	20	29.5	55	2
	65LB2429L	744	782	17	24	29.5	60	3
	65LB2429R	744	782	17	24	29.5	60	3
	65LB3029L	789	829	17	30	29.5	70	3.5
	65LB3029R	789	829	17	30	29.5	70	3.5
	65LB3629L	833	873	17	36	29.5	76	4
	65LB3629R	833	873	17	36	29.5	76	4
Wood Modesty Panel 	65MP60X41	670	703	28	0.75	28.5	22	1.5
	65MP66X41	708	744	34	0.75	28.5	26	4.5
	65MP72X41	791	832	40	0.75	28.5	30	5
	65MP78X41	910	956	46	0.75	28.5	30	5
	65MP84X41	1185	1245	52	0.75	28.5	28.5	3.25
	65MP90X41	1222	1283	58	0.75	28.5	29	3.75
	65MP96X41	1258	1320	64	0.75	28.5	32	4
	Pedestal with Finished Back 	65PFB16204D*	1538	1615	15.75	20	28.5	59
65PFB16204F		1747	1834	15.75	20	28.5	61	6.5
65PFB16244D		1648	1732	15.75	24	28.5	70	6.5
65PFB16244F		1872	1967	15.75	24	28.5	72	6.5
65PFB16304D		1988	2087	15.75	30	28.5	78	9.5
65PFB16304F		1988	2087	15.75	30	28.5	83	9.5
Pedestal with Finished Back, 2 Lateral File 		65PFB30202801*	2023	2122	29.75	20	28	187
	65PFB30242801	2070	2173	29.75	24	28	190	13.5
	65PFB36202801	2160	2266	35.75	20	28	187	11.25
	65PFB36242801	2197	2308	35.75	24	28	190	13.5
	Pedestal with Finished Back Closed Bookcase 	65PFB30202811*	1780	1870	29.75	20	28	172
65PFB30242811		1841	1935	29.75	24	28	174	13.5
65PFB36202811		1887	1984	35.75	20	28	172	11.25
65PFB36242811		1901	1997	35.75	24	28	174	13.5
Combination Pedestal with Finished Back 		65PFB36202802	2377	2495	29.75	20	28	178
	65PFB36242802	2419	2541	29.75	24	28	178	13.5
	65PFB36202804*	2377	2495	35.75	20	28	162	11.25
	65PFB36242804	2419	2541	35.75	24	28	162	13.5

**ORDERING NOTES:** When specifying modular pedestals please state left, center or right. For a pedestal in the left position add L to the end of the model number, for a pedestal in the center position add C to the end of the model number and for a pedestal in the right position add R to the end of the model number. ie. 65PFB36202811L

**DIMENSION KEY**

W – width  
 D – depth  
 H – height of worksurface  
 KW – kneehole width

Dimensions are in inches and approximate. Contact Customer Service if dimensions are critical.







**CODE DESCRIPTION**

L - left hand position  
 R - right hand position  
 4 - full height pedestal  
 C - center position  
 01 - lateral file  
 11 - closed bookcase  
 02 - 2 box on right, 1 file drawer left, lateral file  
 04 - 1 file drawer right, 2 box on left, lateral file

**VENEER**

Latitude is available in Quarter Cut Walnut and Rift Cut Oak veneers, and each is priced in this price guide. Maple and Cherry are also available: for Flat Cut Maple or Cherry veneer, use Column 1 pricing; for Quarter Cut Maple or Cherry, use Column 2 pricing. Other veneers are also available on Latitude, please contact us for a quote.

# LATITUDE | MODULAR COMPONENTS - 3/4 HEIGHT SUPPORT

Description	Model	Rift		W	D	H	Shipping Weight	Cubic Feet
		Oak	Walnut					
 L Support 3/4 Height	65LB2023L	636	667	16	20	23	55	2
	65LB2023R	636	667	16	20	23	55	2
	65LB2423L	696	731	16	24	23	60	3
	65LB2423R	696	731	16	24	23	60	3
	65LB3023L	603	634	16	30	23	70	3.5
	65LB3023R	603	634	16	30	23	70	3.5
	65LB3623L	640	670	16	36	23	76	4
	65LB3623R	640	670	16	36	23	76	4
 Wood Modesty Panel 3/4 Height	65MP60	656	689	60	1.16	23	22	1.5
	65MP66	695	730	66	1.16	23	26	4.5
	65MP72	778	815	72	1.16	23	30	5
	65MP78	892	935	78	1.16	23	30	5
	65MP84	1163	1221	84	1.16	23	28.5	3.25
	65MP90	1197	1256	90	1.16	23	29	3.75
	65MP96	1232	1295	96	1.16	23	32	4
	 3/4 Height Pedestals Finished Back Box/ Lateral File	65PFB24242316	2657	2789	24	24	23	148
65PFB30202316		2740	2877	30	20	23	154	9.25
65PFB30242316		2829	2970	30	24	23	185	11
65PFB36202316		2844	2985	36	20	23	185	11
65PFB36242316		2934	3080	36	24	23	222	13
 3/4 Height Pedestals Finished Back Open/ Lateral File	65PFB24202315	2577	2705	24	20	23	136	7
	65PFB24242315	2657	2789	24	24	23	142	9
	65PFB30202315	2740	2877	30	20	23	148	9.25
	65PFB30242315	2829	2970	30	24	23	179	11
	65PFB36202315	2844	2985	36	20	23	179	11
	65PFB36242315	2934	3080	36	24	23	216	13
 3/4 Height Pedestals Finished Back Bookcase	65PFB24202311	1558	1638	24	20	23	142	7
	65PFB24242311	1603	1683	24	24	23	146	9
	65PFB30202311	1673	1758	30	20	23	152	9.25
	65PFB30242311	1691	1776	30	24	23	183	11
	65PFB36202311	1728	1815	36	20	23	183	11
	65PFB36242311	1780	1870	36	24	23	219	13
 3/4 Height Pedestals Finished Back Open/ Bookcase	65PFB24202318	1558	1638	24	20	23	133	7
	65PFB24242318	1603	1683	24	24	23	139	9
	65PFB30202318	1673	1758	30	20	23	145	9.25
	65PFB30242318	1691	1776	30	24	23	176	11
	65PFB36202318	1728	1815	36	20	23	176	11
	65PFB36242318	1780	1870	36	24	23	213	13

**ORDERING NOTES:** When specifying modular pedestals please state left, center or right. For a pedestal in the left position add L to the end of the model number, for a pedestal in the center position add C to the end of the model number and for a pedestal in the right position add R to the end of the model number. ie. 65PFB36202811L

## ORDERING PROCEDURE

To order, please specify the following:

- 1) Krug product model number
- 2) Wood species and finish
- 3) Grommet location and style if applicable.

\* Indicates model illustrated by line drawing

## CODE DESCRIPTION

- L - left hand position
- R - right hand position
- C - center position
- 16 - box, lateral file
- 15 - top open, lateral file
- 11 - closed bookcase
- 18 - top open, closed bookcase

## STANDARD FINISHES

For a complete list of standard wood finishes, please see page 518.

## PALETTE FINISH

Storage unit door fronts are available in Palette finish at no upcharge. Drawer fronts are also available in Palette at an upcharge of **\$357 list** per unit, add P at the end of the model number. See page 518 for color selection.

# LATITUDE | MODULAR COMPONENTS - BASES

Description	Model	Rift			W	D	H	Shipping Weight	Cubic Feet
		Oak	Walnut						
3/4 Height Pedestals w/ Finished Back Open Bookcase 	65PFB24202317	1495	1569		24	20	23	128	7
	65PFB24242317	1538	1615		24	24	23	130	9
	65PFB30202317	1609	1688		30	20	23	136	9.25
	65PFB30242317	1623	1705		30	24	23	167	11
	65PFB36202317	1660	1743		36	20	23	167	11
	65PFB36242317	1709	1795		36	24	23	204	13

**ORDERING NOTES:** When specifying modular pedestals please state left, center or right. For a pedestal in the left position add L to the end of the model number, for a pedestal in the center position add C to the end of the model number and for a pedestal in the right position add R to the end of the model number. ie. 65PFB36202811L

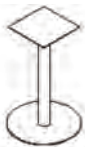
Description	Model	Rift			W	D	H	Shipping Weight	Cubic Feet
		Oak	Walnut						
Disc Base 	65141828		313		18D	-	28	25	7.5
	65142428		334		\$&D	-	28	11.5	11.5
	65142828		483		\$*D	-	28	40	14.5

Description	Model	Rift			W	D	H	Shipping Weight	Cubic Feet
		Oak	Walnut						
Square Plate Base 	65SQ1828		362		18	18	28	25	7.5
	65SQ2428		424		24	24	28	35	11.5

Description	Model	Rift			W	D	H	Shipping Weight	Cubic Feet
		Oak	Walnut						
Drum Base 	65101829		805	844	18	18	28.5	97	7
	65101829WMD		1146	1203	#*	#*	28.5	97	7
	65102429		1245	1307	\$&	\$&	28.5	#&"	12
	65102429WMD		1922	2018	24	24	28.5	#&"	12

Description	Model	Rift			W	D	H	Shipping Weight	Cubic Feet
		Oak	Walnut						
Mobile Pedestal 	65MP161927F	1433	1505		15.75	19.75	28	61	7
	65MP161927D	1487	1562		15.75	19.75	28	61	7
	65MP162827F	1717	1803		15.75	28.5	28	) (	8
	65MP162827D	1797	1886		15.75	28.5	28	) (	*

**DIMENSION KEY**

- W – width
- D – depth
- H – height of worksurface
- KW – kneehole width

Dimensions are in inches and approximate. Contact Customer Service if dimensions are critical.

**STANDARD FINISHES**

For a complete list of standard wood finishes, please see page 518.

**GROMMETS**

One grommet in a standard position is optional at no charge. See page 518 for more information.

# STRATFORD | TABLE OF CONTENTS

578	Environmental Summary
579	General Product Specification
580	Finishes
580	Edge Detail Profile
581	Profiles & Overhang
584	Drawer Pulls & Lock
585	Grommets
586	Laminate Worksurfaces
587	Non-Standard Product Guidelines for Pricing
588	Desk Specification
588	Credenza Specification
589	Overhead & Hutch Specification
590	Installation
591	Sample Configuration
592	Desks
596	Returns
598	Linking Units
598	Corner Units
599	Credenzas
603	Overheads
604	Hutches
607	Keyboard Tray & Cable Management
608	Modular Components
618	Bookcases
619	Storage
623	Reception

# STRATFORD CASEGOODS | ENVIRONMENTAL SUMMARY

## LEED CERTIFICATION



MATERIAL CONTENT:

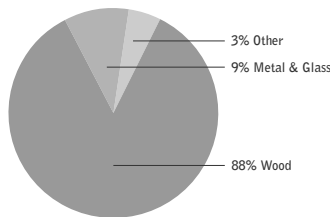

PRE-CONSUMER RECYCLED CONTENT - 77%  
 POST-CONSUMER RECYCLED CONTENT - 2.5%

		CONTRIBUTES TO
Credit 2.1 - 2.2	Construction Waste Management	1-
Credit 3.3	Resource Reuse	1 point
Credit 4.1	Recycled Content	1 point
Credit 4.2	Recycled Content	1 point
Credit 4.5	Low Emitting Materials, (MUST BE REQUESTED ) Composite Wood & Laminate Adhesives	1 point
Credit 5.1	Regional Materials*	1 point
Credit 6	Rapidly Renewable Materials (MUST BE REQUESTED )	1 point
Credit 7	Certified Wood (MUST BE REQUESTED )	1 point

\*This credit is only applicable if in total 20% of the combined value of the procurement of construction materials and in the furniture are manufactured within a radius of 500 miles. This credit will apply if the installation of the finished product occurs within 500 miles of Kitchener, Ontario.

### level® CERTIFICATION



BIFMA's e3 Furniture Sustainability Standard is a voluntary, multi-attribute standard that measures the degree of sustainability of furniture. This standard evaluates product and company environmental attributes and compliance systems in a wide range of elements which include Materials, Energy & Atmosphere, Human & Ecosystem Health and Social Responsibility. Stratford products have earned level®, BIFMA's sustainability certification program for furniture, certification through third-party verification against the e3 standard. All Stratford products can be supplied with level® certification. In order to accomplish this, the product must also be ordered with the air-emissions-certification option. Contact customer service for information and upcharges.

### AIR-EMISSIONS

All Stratford products can be supplied with air-emissions-certified materials. Contact customer service for information and upcharges.



FSC®  
 www.fsc.org  
 FSC® C021699

the mark of responsible forest

### FSC®

FSC® In 2005, Krug received Forest Stewardship Council® (FSC®) Chain-of-Custody certification for our manufacturing facilities. The FSC® Chain-of-Custody tracks certified wood from seedling to final sale. It verifies that the material for our FSC® certified products only come from well-managed, FSC®-certified forests and other controlled sources. FSC® is dedicated to the promotion of responsible forest management worldwide helping to take care of forests for future generations. Stratford and other Krug products can be specified with FSC® Certification. Contact customer service for further information, pricing and lead times.

In addition, architects, designers, and building professionals can specify FSC®-certified products in order to achieve a point from the US. Green Building Council's Leadership in Energy and Environmental Design (LEED) Rating System.





# STRATFORD | GENERAL PRODUCT SPECIFICATIONS

## WORKSURFACES

Tops are made of 1 1/4" - 42 lbs. per cubic foot density particle board core with face and back veneers. All edges have 1 1/8" wide 1" thick solid Cherry or Walnut headers.

## DRAWER FRONTS AND DOORS

48 lbs. per cubic foot density Medium Density Fiberboard with face and back veneer.

## GABLES

Gables are 3/4" or 1 1/8" thick - 45 lbs. per cubic foot density particleboard core, 3 ply. Edges are banded with veneer. Bottom edges of 1 1/8" gables are banded with polyvinyl chloride edge banding.

## VENEER

External face veneers are flat sliced Black Walnut or Cherry bookmatched and of uniform color and grain pattern.

## SOLIDS

All solids used shall be American Black Walnut or Cherry kiln-dried by the manufacturer to a 6% moisture content

## FINISH

All surfaces to be finished are well sanded before applying finish materials. The procedure begins with the application of a base color via a Non-Grain Raising stain. Next a wash coat is applied to seal the NGR stain and ensure an even colored finish. The a filler coat is applied and hand wiped to fill the open pores in the wood surface and further enhance the depth color. A sealer is applied and scuff sanded to prepare the surfaces for the top coat (finish). The final procedure is to apply a coat of 52° sheen catalyzed varnish to protect the surfaces and add luster.

## LOCKS

Locks are standard on all pedestals and storage unit lateral file drawers.  
Locks are optional on door fronts and must be specified at time of order.  
Locks are not available on glass doors.

## DRAWERS

Box drawers have ball bearing movement, full extension slides with urethane cushioned stops and hold-in catch. Box drawers have a load bearing capacity of 100 lbs. per drawer. File drawers have progressive action ball bearing full-extension slides with urethane cushioned stops and hold-in catch. File drawers have a load bearing capacity of 100 lbs. per drawer. Lateral file drawers have full-extension slides with over-travel ball movement slides with urethane cushioned stops. Lateral file drawers have a load bearing capacity of 150 lbs. per drawer. All drawer slides allow for easy removal of the drawers. All drawer interiors are birch veneer. All file drawers are equipped for letter and legal filing. All desks with the center drawer option include a matching pencil tray in the center drawer. All standard desks with 2 box 1 file pedestals are specified without a center drawer option include one matching pencil tray.

## BASE MOLDING

The base moldings are made of profiled solid Black Walnut or Cherry.

## GLIDES

Glides are provided for every case and allow for 1 1/2" of adjustment.

## HINGES

Doors have European style hinges with a 95° opening.

## PULLS

Three pull options are available, please specify at time of order.

## TESTING INFORMATION

Stratford desks, credenzas, hutches, link units, and returns meet or exceed the testing requirements of ANSI/BIFMA X5.5-2014 and/or X5.9 - 2012.



# STRATFORD | FINISHES

**WOOD FINISHES**

Standard wood finishes are:

SPECIES	FINISH
Cherry	Light Cherry
	Natural Cherry
	American Cherry
	Medium Cherry
	Standard Cherry
	Imperial Cherry
	Appalachian Cherry
Sable Cherry	
Walnut	Natural Walnut
	Regular Walnut
	Mahogany on Walnut
	Dark Walnut
	Cordovan Walnut

**NATURAL CHARACTERISTICS OF WOOD**

Wood is a natural product with inherent color variations that will never be fully mitigated by the finishing process. Please anticipate variation in colors within a single unit, from piece to piece, and from Krug wood finish samples. If a very close match is required, a sample must be provided with the order and an upcharge will apply. Exact color matches are not possible.

**CUSTOM WOOD FINISHES**

Add 10% net to your order for special finishes, minimum charge is **\$567 list** per finish per order. (For example, on all orders up to \$5250 list, an **upcharge of \$567** will apply, on orders \$5250 and up add 10% net to your order.)

For orders with special finishes, a sample that is a minimum 3” by 3” must be received with the order. Special finishes may add additional lead time to production schedules.

Since wood is a natural product, some variations in grain, color, and stain acceptance will occur. In our finishing processes, we try to minimize variations, but some variation between samples and finished goods should be anticipated.

**DUAL FINISH**

Add 10% net per item if specifying dual finish.

**WOOD FINISHES TO MATCH STANDARD LAMINATES**

- Copper on Cherry
- Shiraz Cherry
- Park Avenue Walnut
- Chocolate on Walnut
- Nutmeg on Walnut
- Dark Walnut

# STRATFORD | EDGE PROFILES



**PROFILE - STANDARD**

The standard edge detail is included on the following Stratford products:

- desks
- linking units
- credenzas
- returns
- corner units
- 30” high and 57” high bookcases
- modular TP and TPR tops
- 30” high freestanding storage
- occasional tables
- conference tables



**PROFILE - INVERTED**

The inverted edge detail is included on the following Stratford products:

- hutches
- wall mounted overheads
- 71” high bookcase
- modular TPI tops
- 71” high and 84” high freestanding storage
- visual boards

# STRATFORD | PROFILES & OVERHANGS

Please use the following summary of products to determine the profile direction and overhang dimensions for all Stratford products.

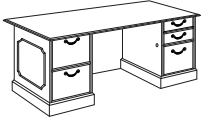

## DESKS 30" DEEP

Profile Location: profile on all four sides  
 Profile Direction: standard  
 Overhang: left 1 1/2"  
 right 1 1/2"  
 user 3/4"  
 guest 1 1/2"

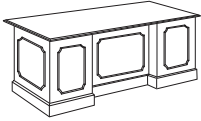

Picture Frame: on end panels, modesty panel and pedestal backs

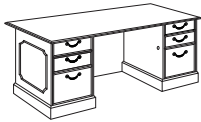

## DESKS 36" DEEP

Profile Location: profile on all four sides  
 Profile Direction: standard  
 Overhang: left 1 1/2"  
 right 1 1/2"  
 user 3/4"  
 guest 7 1/2"

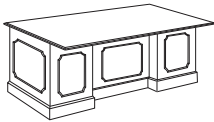

Picture Frame: on end panels, modesty panel and pedestal backs



## TABLE DESKS

Profile Location: profile on all four sides  
 Profile Direction: standard  
 Overhang: left 1 1/2"  
 right 1 1/2"  
 user 3/4"  
 guest 1 1/2"

Picture Frame: none

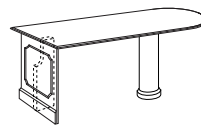

## BULLET AND P DESKS

Profile Location: profile on all sides  
 Profile Direction: standard  
 Overhang: end panel 1 1/2"  
 Picture Frame: on end panel

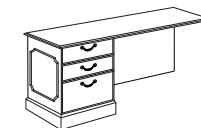

## RETURNS

Profile Location: profile on all four sides, coved  
 Profile Direction: standard  
 Overhang: end panel 1 1/2"  
 user 3/4"  
 guest 1 1/2"

Picture Frame: on end panel, modesty panel and pedestal back

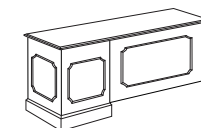

# STRATFORD | PROFILES & OVERHANGS

Please use the following summary of products to determine the profile direction and overhang dimensions for all Stratford products.

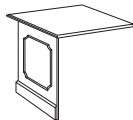

## LINK UNITS AND LINK TOPS

Profile Location: profile on guest and user sides, cover on connecting ends  
 Profile Direction: standard  
 Overhang: guest 1 1/2"  
 Picture Frame: on modesty panel

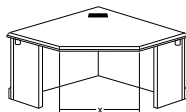

## CORNER UNITS

Profile Location: profile on outside and user sides, covered on connecting ends  
 Profile Direction: standard  
 Overhang: guest 1 1/2"  
 Picture Frame: on both outside panels

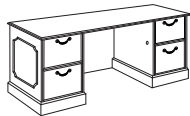

## CREDENZAS

Profile Location: profile on left, right and user side, flush on back edge  
 Profile Direction: standard  
 Overhang: left 1 1/2"  
                   right 1 1/2"  
                   user 3/4"  
                   back 1/8"  
 Picture Frame: on left and right panels

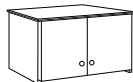

## OVERHEADS

Profile Location: inverted profile left, right, and user side, flush on back edge  
 Profile Direction: inverted  
 Overhang: left 1"  
                   right 1"  
                   user 3/4"  
                   back flush  
 Picture Frame: none

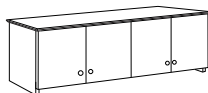

Please specify if flush sides are necessary for the purpose of ganging overheads at time of order. Upcharge for this option is **\$228 list**.

# STRATFORD | PROFILES & OVERHANGS

Please use the following summary of products to determine the profile direction and overhang dimensions for all Stratford products.

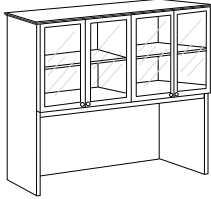

## HUTCHES

Profile Location: inverted profile on left, right, and user side, flush on back edge  
 Profile Direction: inverted  
 Overhang: left 1"  
 right 1"  
 user 3/4"  
 back flush  
 Picture Frame: none

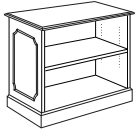
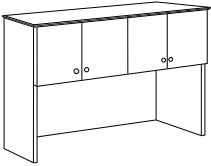

## BOOKCASES AND FREESTANDING STORAGE (30" HIGH ONLY)

Profile Location: profile on left, right, and user side, flush on back edge  
 Profile Direction: standard  
 Overhang: left 1 1/2"  
 right 1 1/2"  
 user 3/4" (if unit has doors or drawers)  
 1 1/2" (if unit is open)  
 back flush  
 Picture Frame: on left and right panels

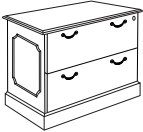

Bookcases have non-shown wood backs, finished color.  
 Freestanding and modular storage have non-shown wood veneer, finished and top coated backs.

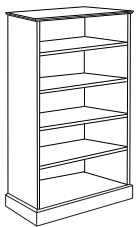

## BOOKCASES AND FREESTANDING STORAGE (57", 71" AND 84" HIGH)

Profile Location: profile on left, right, and user side, flush on back edge  
 Profile Direction: inverted  
 Overhang: left 1"  
 right 1"  
 user 3/4" (if unit has doors or drawers)  
 1 1/2" (if unit is open)  
 back flush  
 Picture Frame: none

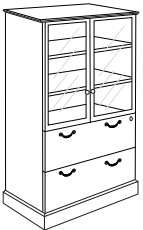

Bookcases have non-shown wood backs, finished color.  
 Freestanding and modular storage have non-shown wood veneer, finished and top coated backs.

## STRATFORD | DRAWER PULLS & LOCKS

Stratford traditional series offers a choice of three pull combinations as described below.

Please indicate a pull designation for every Stratford product on your order. There is no default selection and orders will not be processed until a pull selection is received.

### DEVON

Drawers are furnished with an arced Devon bail finished in antiqued brass and mounted with rosettes. Bookcase doors and hutch doors are provided with an antiqued brushed brass knob.



### CANTERBURY

Drawers are furnished with a Canterbury bail finished in antiqued brass and mounted with rosettes. Bookcase doors and hutch doors are provided with an antiqued brushed brass knob.



### AVON

All drawers, bookcase doors and hutch doors are provided with an antiqued brushed brass knob.



### LOCKS

Locks are provided as a standard features on all pedestal drawers, including those in desks, credenzas and freestanding or modular storage units. All lock plugs have an antiqued brass finish.

Optional locks are available on bookcase, hutch and overhead doors at an upcharge of **\$152 list per set** of (2) doors. Please specify at time of order. If a hutch or overhead has an uneven amount of doors the single lock required is also **\$152**.

### LOCK LOCATIONS

**Desk Pedestals:** Lock plugs are located in the kneespace of all desks, with the exception of desks with the center drawer option where the central locking system lock plug is located on the center of the drawer front.

**Hutches and Overheads:** Lock plugs are located on the lower inside corner of the doors.

**Bookcase Doors:** Lock plugs are located on the top inside corner of the door.

Suites can be keyed alike at no upcharge, please specify on your purchase order.

# STRATFORD | GROMMETS

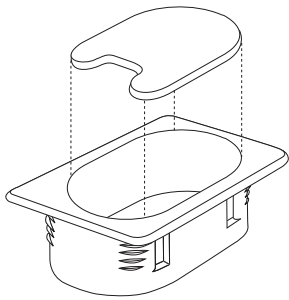

## GROMMETS

All products may be specified with either one black grommet or one brass grommet in a standard position at no upcharge. A **\$152 list upcharge** will apply to additional grommets in standard positions and for grommets in non-standard positions a **\$152 list upcharge** will apply.

The grommet position must be indicated for each case on the purchase order.

Standard Grommet  
Black, rectangular, 4 1/8" x 2 11/16"

Antiqued Brass Grommet  
2 5/8" x 1 1/2"

Grommets can also be field installed with power drill, 2 1/4 hole saw and rasp or saber saw. Template for drilling is available.

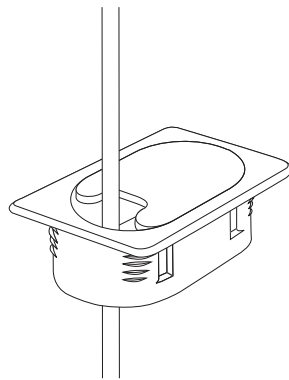

## STANDARD GROMMET POSITIONS

### Desks

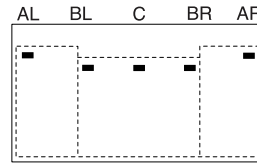
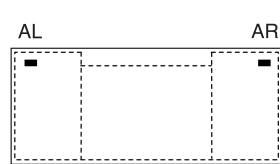

### 30" and 36" Deep Desks:

Position Code:  
AL - left corner  
BL - left end beside pedestal gable  
C - center  
BR - right end beside pedestal gable  
AR - right corner

### 42" Deep Desks:

Position Code:  
AL - left corner  
BL - left end beside pedestal gable  
C - center  
BR - right end beside pedestal gable  
AR - right corner

### Curvilinear Tops

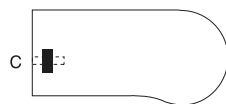

Position Code:  
C - center

This key applies to all bullet and P shaped tops. The support panel is notched out to accommodate cable management and also allows the installation of a pop-up power grommet.

### Linking Units, Credenzas & Returns

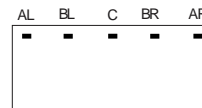

Grommets cannot be located over pedestals on 20" or 24" units

**NOTE:** 'BL' and "BR" are only available on 42" on longer.

## STRATFORD | GROMMETS & LAMINATE WORKSURFACES

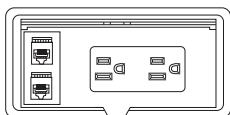

mounted in a hutch back panel



used as a surface grommet

### POWER / DATA / VOICE GROMMET

This unit is supplied in the wired hutches or can be ordered a surface mount power/data/voice option as a 98PDVM.

Black, rectangular with recessed cover.  
Includes two power outlets, one voice port, and one data port.

**POWER DETAILS:**  
two Simplex outlets  
15 Amp, 10 ft. cord

**COMMUNICATION DETAILS:**  
one RJ11 phone line coupler  
one RJ45 data coupler

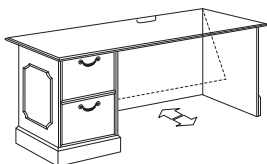

### WIRE MANAGEMENT CUT-OUT AND HINGED MODESTY PANELS

Returns, link units and credenzas with fixed modesty panels can be specified with an 8" x 1 1/2" wire management cut-out. All hinged modesty panels feature a cut-out as a standard.

The discreet cut-out allows for clean and easy access to power, data and communication sources.

## STRATFORD | LAMINATE WORKSURFACES

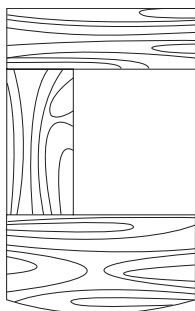

### LAMINATE WORKSURFACES

Laminate worksurfaces are available at an upcharge of 10% (a higher upcharge may apply to specially priced plastic laminates).

Where there are wood profile edges on worksurface tops, they will remain as wood profiles on laminate tops.

Where there are flush edges, as in the backs of link units, there will be laminate self edges. Please reference the illustration.

Krug will order and procure laminates. Purchase orders with a plastic laminate option must include laminate name.

When specifying laminate worksurfaces, the grain direction is such that the grain pattern runs the length of each surface, as shown in the diagram on the left.

Please contact Krug Customer Service for questions pertaining to laminate grain direction.



# STRATFORD | NON-STANDARD PRODUCT GUIDELINES FOR PRICING

## PRICING METHOD

Custom widths: Apply the price of the same unit in the price list that is one standard size larger than the desired case size (but same depth).  
For example: The required custom dimension is 74" x 24". The first standard size above this is 78" x 24", so in this case, you would apply the price of the 78" x 24" unit.

Custom depths: Apply the price for the same unit one size deeper (but same width).  
For example: The required custom dimension is 72" x 26". The first standard size above this is 72" x 30", so in this case, you would apply the price of the 72" x 30" unit.

Custom width & depths: Apply the price for the same unit both one size wider and one size deeper.  
For example: The required custom dimension is 74" x 26". The first standard size above this is 84" x 30", so in this case, you would apply the price of the 84" x 30" unit.

Custom height of desk height cases: Add 18%. (31-32" HI)

## OTHER PRICING METHODS

cases where tops are flush left/right or both, <b>add:</b>	\$120 list
Grommets in non-standard positions, <b>add:</b>	\$152 list
To remove hutch or overhead doors, <b>deduct:</b>	4% list
convert 5-hi hutch to 6-hi hutch, <b>add:</b>	20% list
Bookcases with optional pull out printer shelf at standard shelf height, <b>add:</b>	\$238 list
Bookcases with optional vent in back (includes 2 vents and 1 grommet), <b>add:</b>	\$320 list
storage units flush, <b>add:</b>	\$199 list
2 lateral file and 3 or 4 closed shelves - convert to half open, half closed shelves, <b>add:</b>	15% list
2 lateral file and 3 or 4 closed shelves - convert to half open, half wardrobe, <b>add:</b>	15% list
To remove storage doors for open shelves, <b>deduct:</b>	4% list

## EXCEPTIONS TO THE PRICING METHODS ABOVE

- Sizes larger than the largest shown Price List.
- Non-standard extension on drawer slides.
- Non-standard drawer depths in standard depth pedestals.
- Glass door - any style.
- Glass - face mounted modesty panels.
- Perforated modesty panels.
- Cases with curvilinear tops where the radius becomes non-standard.
- A/V cabinets.
- Any case with flipper doors.

Please contact Specials Coordinator or Krug Customer Service at 1.888.578.KRUG if you require assistance.

**PLEASE NOTE:** Cases with non-standard features do not apply to the rules above.  
Contact Krug Customer Service if you require assistance.

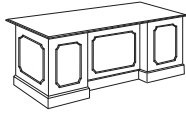

**Breakfront Modesty Panel**

All single pedestal and double pedestal desks have a breakfront modesty panel on the guest side of the desk. The dimension of recess is 4 1/2”.

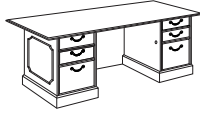

**Oversized Top Option**

The oversized top option increases the overhang on the left and right sides of desks to 4 1/2” on each end, the guest and user side overhang remain unchanged.



**Center Drawer Option**

Desks specified with the optional locking center drawer include the following features:

- center drawer lined with burgundy felt and a pencil tray.
- a pull out dictation slide in each pedestal
- a central locking system activated by a single lock located on the center drawer front

Recent modifications:

- dictation slides are flush with drawer fronts and feature molding detail
- center drawer extends to underside of top with the lock on the drawer front

**Chassis Dimensions**

Please use the reference chart below to determine chassis dimensions, top dimensions, and overhang dimensions for all desk sizes:

Desk	Chassis dimension	Left overhang	Right overhang	Guest overhang	User overhang
60” x 30”	57” x 27”	1 1/2”	1 1/2”	1 1/2”	3/4”
66” x 30”	63” x 27”	1 1/2”	1 1/2”	1 1/2”	3/4”
66” x 36”	63” x 27”	1 1/2”	1 1/2”	7 1/2”	3/4”
72” x 36” (oversized top)	63” x 27”	4 1/2”	4 1/2”	7 1/2”	3/4”
72” x 36”	69” x 27”	1 1/2”	1 1/2”	7 1/2”	3/4”
78” x 36” (oversized top)	69” x 27”	4 1/2”	4 1/2”	7 1/2”	3/4”
78” x 42”	75” x 33”	1 1/2”	1 1/2”	7 1/2”	3/4”
84” x 42” (oversized top)	75” x 33”	4 1/2”	4 1/2”	7 1/2”	3/4”
84” x 42”	81” x 33”	1 1/2”	1 1/2”	7 1/2”	3/4”

Dimensions have been rounded to the nearest 1/4”, please contact Customer Service for exact measurements.

**STRATFORD | CREDENZAS**

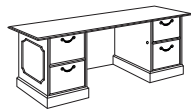

**Oversized Top Option**

The oversized top option increases the overhang on the left and right sides of credenzas to 4 1/2” on each side, the guest and user side overhang remain unchanged. When using a hutch and credenza combination, we do not recommend specifying a hutch greater in size than the standard chassis size of the credenza. The left/right extensions on the oversized top should not be used for the support of a hutch.

**Chassis Dimensions**

Please use the reference chart below to determine chassis dimensions, top dimensions, and overhang dimensions for all desk sizes:

	Credenza dimension	Chassis overhang	Left overhang	Right overhang	Guest User overhang
66” x 20”	63” x 18 1/4”	1 1/2”	1 1/2”	3/4”	1/8”
72” x 20” (oversized top)	63” x 18 1/4”	4 1/2”	4 1/2”	3/4”	1/8”
66” x 24”	63” x 22 1/4”	1 1/2”	1 1/2”	3/4”	1/8”
72” x 24” (oversized top)	63” x 22 1/4”	4 1/2”	4 1/2”	3/4”	1/8”
72” x 20”	69” x 18 1/4”	1 1/2”	1 1/2”	3/4”	1/8”
78” x 20” (oversized top)	69” x 18 1/4”	4 1/2”	4 1/2”	3/4”	1/8”
72” x 24”	69” x 22 1/4”	1 1/2”	1 1/2”	3/4”	1/8”
78” x 24” (oversized top)	69” x 22 1/4”	4 1/2”	4 1/2”	3/4”	1/8”
78” x 20”	75” x 18 1/4”	1 1/2”	1 1/2”	3/4”	1/8”
84” x 20” (oversized top)	75” x 18 1/4”	4 1/2”	4 1/2”	3/4”	1/8”
78” x 24”	75” x 22 1/4”	1 1/2”	1 1/2”	3/4”	1/8”
84” x 24” (oversized top)	75” x 22 1/4”	4 1/2”	4 1/2”	3/4”	1/8”
84” x 20”	81” x 18 1/4”	1 1/2”	1 1/2”	3/4”	1/8”
84” x 24”	81” x 18 1/4”	1 1/2”	1 1/2”	3/4”	1/8”

Dimensions have been rounded to the nearest 1/4”, please contact Customer Service for exact measurements.

# STRATFORD | OVERHEADS & HUTCHES

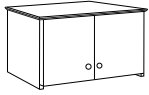

## OVERHEADS

Overheads include tasklights that are factory installed and require no field adjustment. Tasklights are mounted beneath the cabinet and hidden from view. Cords run down the right hand side of the tasklight to the worksurface where they can be routed behind the worksurface top. The use of a wall mounted tackboard conceals the cord from view.

Tackboards must be ordered separately and can be specified in any fabric grade (1-9). Wall mounted tackboards for overheads are supplied with all necessary hardware for installation.

Locks are optional on overheads and can be specified at time of order for an upcharge of **\$152 list per set** of (2) doors.

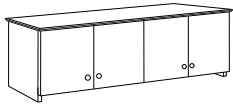

## HUTCHES

Hutches include tasklights that are factory installed and require no field adjustment. Tasklights are mounted beneath the cabinet and hidden from view.

A tackboard in grade 1 fabric is included with most hutches, see the hutch product section for specific products. Upcharges for higher graded fabrics are listed on page 603. Tackboard fabric selections should be supplied with the order information, fabric options are listed on page 4 of this price guide.

Tackboards for hutches are installed at the factory and require no additional set up on site.

## POWER/DATA/VOICE GROMMET

Access to power and data is made simple by using a hutch with a power/data/voice module built right into the tackboard. The module is fully installed at the factory but can be removed to connect data links on site. It features a flip door that retracts into the case of the unit when open.

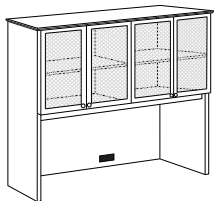

## INSTALLATION

Hutch and overhead installation instructions are included with every case, but basic installation instructions can be found in this guide on page 586. All required mounting hardware is included with all hutches.

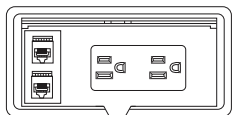

# STRATFORD | INSTALLATION

## CONNECTING WORKSURFACES

It is important that the product is in its final position and the primary work surface is leveled before connecting other joining pieces.

Detailed installation instructions are included with each unit, or available from Krug Customer Service.

Units are connected with mending plates under worksurfaces, and linking brackets on modesty and end panels. Locate connections and attach the mending plate under the work surface. Level pieces if necessary by adjusting the glides to achieve flush and firm joints before completing installation of all hardware.

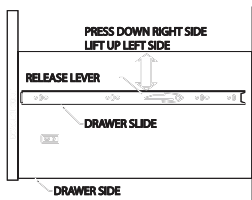

## DRAWER REMOVAL

To remove pedestal drawers, open to the extended position, press down on the right side nylon release lever and pull the drawers up on left side lever at the same time. Continue pulling the drawer out of the case.

## GLIDE ADJUSTMENTS

Raise one corner of the unit at a time and adjust the glide to the desired height by turning the glide in the hole. Make sure unit is level after adjusting the glides.

Please note that the maximum adjustment range of the glides is 1/2".

When moving units after glides have been inserted, dial the glides to the lowest position to prevent damage to the case.

## BOOKCASE OR HUTCH DOOR ADJUSTMENT

Hinges on all hutch and bookcase doors are designed to be adjusted for depth, horizontal and vertical adjustment by means of screws into the hinge mounting plates.

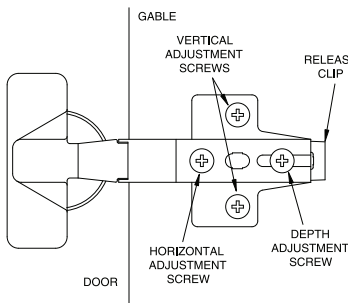

To remove a door, pull the release clip away from the case, disconnecting the hinges.

## OVERHEAD INSTALLATION

The wall mounted overhead storage units must be installed on wall studs. The first step for installation is to locate the studs in the wall where the overhead is to be mounted. Measure the stud center line location and use this measurement to mark the hole locations on the mounting rail and the overhead back. Drill clearance holes at the hole locations. Hole requirements will depend on the fasteners chosen by the installer. 2 1/2" x #10 wood screws are adequate if going into wood studs. If studs cannot be accessed, then appropriate drywall plugs or butterfly bolts should be used. We recommend 2 fasteners per stud.

Fasten the mounting rail to the wall ensuring that it is level. Hang the overhead on the mounting rail and then fasten it to the wall. This prevents accidental removal and also allows for some leveling adjustment.

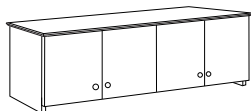

# STRATFORD | SAMPLE CONFIGURATIONS

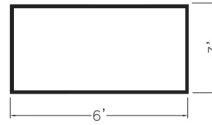
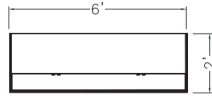
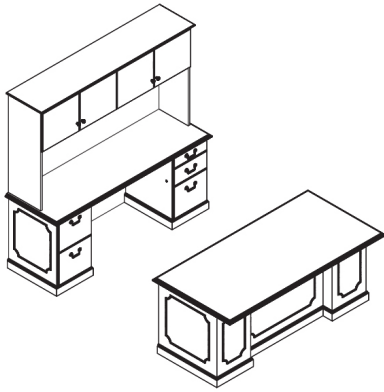

	Model	Cherry Walnut
Desk	98D72364LORF	4587
Hutch	98HT721640	4748
Credenza	98C72244LDRF	5065
<b>TOTAL</b>		<b>14,400</b>

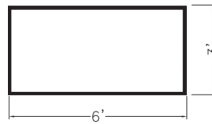
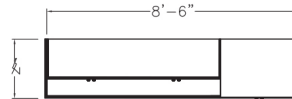
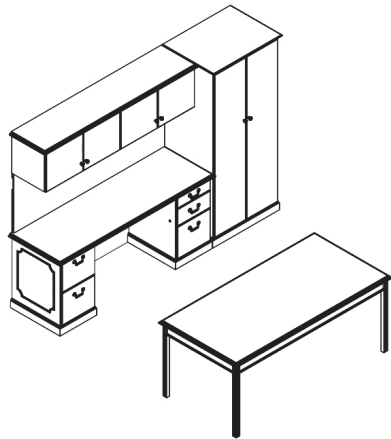

	Model	Cherry Walnut
Desk	98TD7236	4540
Overhead	98OH7216	2638
Tackboard	98TBOH72	476
Credenza	98C72244LDRF	5065
Flush Left	option	120
Storage	98WR30247101	4515
<b>TOTAL</b>		<b>17,354</b>

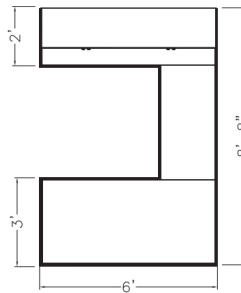
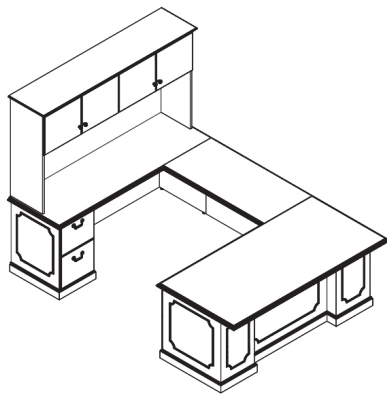

	Model	Cherry Walnut
Desk	98D72364LORF	4587
Link Unit	98LU4224H	1809
Hutch	98HT721640	4748
Credenza	98C72244LDR0	4710
<b>TOTAL</b>		<b>15,854</b>

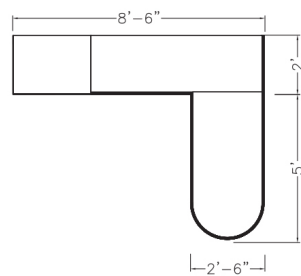
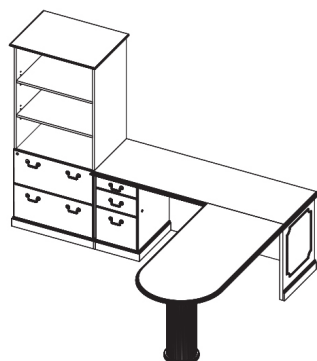

	Model	Cherry Walnut
Return	98BR6030	1998
Credenza	98C7220LFR0	4414
Flush Right	option	120
Storage	98ST30207103	5204
<b>TOTAL</b>		<b>11,736</b>

# STRATFORD | DESKS

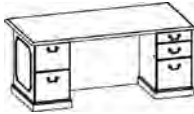
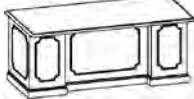
Description	Model	Cherry Walnut	W	D	H	KW	Shipping Weight	Cubic Feet
Double Pedestal Desk	98D60304LDRD	5891	59.75	29.75	30.5	25.5	273	42
	98D60304LDRF	5891	59.75	29.75	30.5	25.5	273	42
	98D60304LFRD	5891	59.75	29.75	30.5	25.5	273	42
	98D60304LFRF	5891	59.75	29.75	30.5	25.5	273	42
 guest side of a 36" deep desk**	98D66304LDRD	5924	65.75	29.75	30.5	31.5	280	46
	98D66304LDRF	5924	65.75	29.75	30.5	31.5	280	46
	98D66304LFRD	5924	65.75	29.75	30.5	31.5	280	46
	98D66304LFRF	5924	65.75	29.75	30.5	31.5	280	46
	98D66364LDRD	5954	65.75	35.75	30.5	31.5	295	55
	98D66364LDRF	5954	65.75	35.75	30.5	31.5	295	55
	98D66364LFRD	5954	65.75	35.75	30.5	31.5	295	55
	98D66364LFRF	5954	65.75	35.75	30.5	31.5	295	55
	98D72364LDRD	6039	71.75	35.75	30.5	37.5	310	60
	98D72364LDRF*	6039	71.75	35.75	30.5	37.5	310	60
	98D72364LFRD	6039	71.75	35.75	30.5	37.5	310	60
	98D72364LFRF	6039	71.75	35.75	30.5	37.5	310	60
	98D78424LDRD	6179	77.75	41.75	30.5	43.5	327	72
	98D78424LDRF	6179	77.75	41.75	30.5	43.5	327	72
	98D78424LFRD	6179	77.75	41.75	30.5	43.5	327	72
	98D78424LFRF	6179	77.75	41.75	30.5	43.5	327	72
98D84424LDRD	6316	83.75	41.75	30.5	49.5	337	78	
98D84424LDRF	6316	83.75	41.75	30.5	49.5	337	78	
98D84424LFRD	6316	83.75	41.75	30.5	49.5	337	78	
98D84424LFRF	6316	83.75	41.75	30.5	49.5	337	78	

**ORDERING NOTES:**

Laminate worksurfaces are available at a 10% upcharge. 30" deep Stratford desks have a 1-1/2" overhang on the guest side. 36" deep Stratford desks have a 7 1/2" overhang on the guest side. See page 578 for more information on the desks overhang and chassis dimensions. A burled walnut top option is available at a 20% upcharge.

Double Pedestal Desk with Center Drawer Option	98D60304LFCDRF	6258	59.75	29.75	30.5	25.5	303	42
	98D66304LFCDRF	6313	65.75	29.75	30.5	31.5	310	46
	98D66364LFCDRF	6358	65.75	35.75	30.5	31.5	325	55
	98D72364LFCDRF*	6465	71.75	35.75	30.5	37.5	340	60
	98D78424LFCDRF	6621	77.75	41.75	30.5	43.5	357	72
	98D84424LFCDRF	6779	83.75	41.75	30.5	49.5	367	78

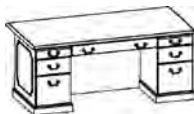

**ORDERING NOTES:**

The center drawer option includes:  
 - a felt-lined drawer with pencil tray  
 - two pull-out dictation slides on the user side of the desk.  
 - a central locking system activating center drawer and both pedestals with a single lock located on the left pedestal inside gable.  
 Laminate worksurfaces are available at a 10% upcharge. A burled walnut top option is available at a 20% upcharge.

DIMENSION KEY	CODE DESCRIPTION	STANDARD FINISHES
W — width	0 - no pedestal	For a complete list of standard wood finishes please see page 577.
D — depth	4 - full height pedestals	
H — height of worksurface	D - 2 file drawer	<b>WIRING GROMMET</b> One rectangular black or one antique brass grommet in a standard position is optional at no charge. Please note grommet choice clearly on order form. Additional grommets are available at an upcharge of <b>\$152 list</b> .
KW— kneehole width	F - 2 box, 1 file drawe	
Dimensions are in inches and approximate. Contact Customer Service if dimensions are critical.	L - left hand support position	
*See page 5 for KrugExpress program.	R - right hand support position	
	CD - center drawer	
	OT - oversized top option	
	BT - bow top option	
	CC - corner credenza	

# STRATFORD | DESKS

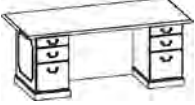
Description	Model	Cherry		W	D	H	Shipping Weight	Cubic Feet
		Walnut						
	OT98D66364	308		71.75	35.75	-	15	-
	OT98D72364*	308		77.75	35.75	-	15	-
	OT98D78424	308		83.75	41.75	-	15	-

### ORDERING NOTES:

The oversized top option is only available on stand-alone double pedestal desks and cannot be used in conjunction with any other run-off or connecting worksurfaces. Specifying the oversized top option increases the top width, increasing the left and right overhang measurement to 4-1/2". The guest side remains 7-1/2" (as is standard for 36" and 42" deep desks). Laminate worksurfaces are available at a 10% upcharge.

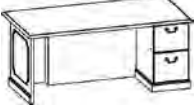
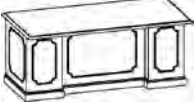
Description	Model	Cherry		W	D	H	Shipping Weight	Cubic Feet	
		Walnut							
    guest side of a 36" deep desk**	98D60304LDR0	4063		59.75	29.75	30.5	40.5	215	42
	98D60304LFR0	4063		59.75	29.75	30.5	40.5	215	42
	98D60304LORD	4063		59.75	29.75	30.5	40.5	215	42
	98D60304LORF	4063		59.75	29.75	30.5	40.5	215	42
	98D66304LDR0	4095		65.75	29.75	30.5	46.5	222	46
	98D66304LFR0	4095		65.75	29.75	30.5	46.5	222	46
	98D66304LORD	4095		65.75	29.75	30.5	46.5	222	46
	98D66304LORF	4095		65.75	29.75	30.5	46.5	222	46
	98D66364LDR0	4119		65.75	35.75	30.5	46.5	237	55
	98D66364LFR0	4119		65.75	35.75	30.5	46.5	237	55
	98D66364LORD	4119		65.75	35.75	30.5	46.5	237	55
	98D66364LORF	4119		65.75	35.75	30.5	46.5	237	55
	98D72364LDR0	4587		71.75	35.75	30.5	52.5	252	60
	98D72364LFR0	4587		71.75	35.75	30.5	52.5	252	60
	98D72364LORD*	4587		71.75	35.75	30.5	52.5	252	60
	98D72364LORF	4587		71.75	35.75	30.5	52.5	252	60
	98D78424LDR0	5038		77.75	41.75	30.5	58.5	269	72
	98D78424LFR0	5038		77.75	41.75	30.5	58.5	269	72
	98D78424LORD	5038		77.75	41.75	30.5	58.5	269	72
	98D78424LORF	5038		77.75	41.75	30.5	58.5	269	72
98D84424LDR0	5504		83.75	41.75	30.5	64.5	279	78	
98D84424LFR0	5504		83.75	41.75	30.5	64.5	279	78	
98D84424LORD	5504		83.75	41.75	30.5	64.5	279	78	
98D84424LORF	5504		83.75	41.75	30.5	64.5	279	78	

### ORDERING NOTES:

The oversized top option is only available on stand-alone double pedestal desks and cannot be used in conjunction with any other run-off or connecting worksurfaces. Specifying the oversized top option increases the top width, increasing the left and right overhang measurement to 4-1/2". The guest side remains 7-1/2" (as is standard for 36" and 42" deep desks). Laminate worksurfaces are available at a 10% upcharge.

### ORDERING PROCEDURES

To order, please specify the following:

- 1) Krug product model number
- 2) Wood species and finish, see page 577
- 4) Pull style and finish, see page 581
- 5) Grommet location and style if applicable

\* Indicates model illustrated by line drawing

### CODE DESCRIPTION

0 - no pedestal  
 4 - full height pedestals  
 D - 2 file drawer  
 F - 2 box, 1 file drawer  
 L - left hand support position  
 R - right hand support position  
 CD - center drawer  
 OT - oversized top option  
 BT - bow top option  
 CC - corner credenza

### STANDARD FINISHES

For a complete list of standard wood finishes please see page 577.

# STRATFORD | DESKS

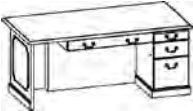
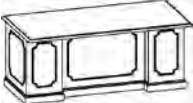
Description	Model	Cherry		W	D	H	KW	Shipping	
		Walnut						Weight	Cubic Feet
 	Single Pedestal Desk with Center Drawer Option	98D66304LOCDRF	4372	65.75	29.75	30.5	46.5	252	46
	98D66304LFCDR0	4372	65.75	29.75	30.5	46.5	252	46	
	98D66364LOCDRF	4418	65.75	35.75	30.5	46.5	267	55	
	98D66364LFCDR0	4418	65.75	35.75	30.5	46.5	267	55	
	98D72364LOCDRF*	4903	71.75	35.75	30.5	52.5	282	60	
	98D72364LFCDR0	4903	71.75	35.75	30.5	52.5	282	60	
	98D78424LOCDRF	5391	77.75	41.75	30.5	58.5	299	72	
	98D78424LFCDR0	5391	77.75	41.75	30.5	58.5	299	72	
	98D84424LOCDRF	5873	83.75	41.75	30.5	64.5	309	78	
	98D84424LFCDR0	5873	83.75	41.75	30.5	64.5	309	78	

**ORDERING NOTES:**

guest side of a 36" deep desk\*\*

The center drawer option includes:  
 - a felt-lined drawer with pencil tray  
 - a central locking system activating center drawer and pedestal with a single lock located on the inside pedestal gable.  
 - pull-out dictation slide on the user side of the desk.  
 The space left between the pencil drawer and the open end of the desk allows for a 24" run off. Laminate worksurfaces are available at a 10% upcharge. A burled walnut top option is available at a 20% upcharge.

Description	Model	Cherry		W	D	H	KW	Shipping	
		Walnut						Weight	Cubic Feet
	Desk Shells	98S6636LOR0*	2744	65.75	35.75	30.5	60.5	121	55
	98S7236LOR0	3047	71.75	35.75	30.5	66.5	137	60	
	98S7836LOR0	3382	77.75	35.75	30.5	72.5	153	64	

Description	Model	Cherry		W	D	H	KW	Shipping	
		Walnut						Weight	Cubic Feet
	Bow Top Option	98D6636BT	626	-	-	-	-	-	-
	Upcharge	98D7236BT*	674	-	-	-	-	-	-
	98D7842BT	693	-	-	-	-	-	-	
	98D8442BT	701	-	-	-	-	-	-	

**ORDERING NOTES:**

The bow top option is available on all the desk sizes listed above. Please add "BT" to the model number of the desk and add the upcharge shown above. The bowtop option tapers the overhang back on the left and right sides, the depth of the overhang at the widest point is 7 1/2". Laminate worksurfaces are available at a 10% upcharge.

**DIMENSION KEY**

W — width  
 D — depth  
 H — height of work surface  
 KW— kneehole width

Dimensions are in inches and approximate. Contact Customer Service if dimensions are critical.

\*See page 5 for KrugExpress program.

**CODE DESCRIPTION**

0 - no pedestal  
 4 - full height pedestals  
 D - 2 file drawer  
 F - 2 box, 1 file drawer  
 L - left hand support position  
 R - right hand support position  
 CD - center drawer  
 OT - oversized top option  
 BT - bow top option  
 CC - corner credenza

**STANDARD FINISHES**

For a complete list of standard wood finishes please see page 577.

**WIRING GROMMET**

One rectangular black or one antique brass grommet in a standard position is optional at no charge. Please note grommet choice clearly on order form. Additional grommets are available at an upcharge of **\$152 list**.



# STRATFORD | DESKS

Description	Model	Cherry		W	D	H	KW	Shipping Weight	Cubic Feet
		Walnut							
Queen Ann Table Desk	98TDQ7236	4978		83.75	35.75	30.5	65.75	150	60



**ORDERING NOTES:**

Optional lock: Please add **\$152 list** and specify lock option in the product description. This item is NOT available on KrugExpress. Laminate worksurfaces are available at a 10% upcharge. Please note that pedestals can not be used with table desks.

Table Desk	98TD7236*	4529		71.75	35.75	30.5	66.5	131	12
	98TD7842	5028		77.75	41.75	30.5	72.5	148	14



**ORDERING NOTES:**

Table desk includes a felt-liner center drawer with pencil tray. To add lock, please specify lock option and add **\$143 list**. The lock plug is located above the center drawer in the rail. The table desk is shipped knocked down. This table desk is NOT available on KrugExpress. Laminate worksurfaces are available at a 10% upcharge.

Bullet Desk, Post Leg	98BD6030	2874		59.75	29.75	30.5	140	36	
	98BD6630	2928		65.75	29.75	30.5	154	40	
	98BD7230	2986		71.75	29.75	30.5	170	47	
	98BD6636	2959		65.75	35.75	30.5	184	43	
	98BD7236*	3047		71.75	35.75	30.5	200	51	

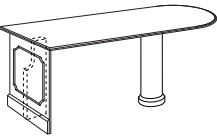

"P" Desk, Post Leg	98PD7230L	3745		71.75	35.75	30.5		189	43
	98PD7230R	3745		71.75	35.75	30.5		189	43
	98PD7236L	3825		71.75	41.75	30.5		205	51
	98PD7236R*	3825		71.75	41.75	30.5		205	51
	98PD7830L	3896		77.75	35.75	30.5		219	47
	98PD7830R	3896		77.75	35.75	30.5		219	47
	98PD7836R	3969		77.75	41.75	30.5		233	56
	98PD7836R	3969		77.75	41.75	30.5		233	56
	98PD8430L	4089		83.75	35.75	30.5		247	50
	98PD8430R	4089		83.75	35.75	30.5		247	50
	98PD8436L	4193		83.75	41.75	30.5		260	60
	98PD8436R	4193		83.75	41.75	30.5		260	60

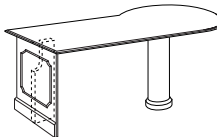

**ORDERING NOTES:**

"P" desk/return legs are 10.5 in diameter. Laminate worksurfaces are available at a 10% upcharge.

**ORDERING PROCEDURES**

To order, please specify the following:

- 1) Krug product model number
- 2) Wood species and finish, see page 577
- 4) Pull style and finish, see page 581
- 5) Grommet location and style if applicable

\* Indicates model illustrated by line drawing

**CODE DESCRIPTION**

- 0 - no pedestal
- 4 - full height pedestals
- D - 2 file drawer
- F - 2 box, 1 file drawer
- L - left hand support position
- R - right hand support position
- CD - center drawer
- OT - oversized top option
- BT - bow top option
- CC - corner credenza

**STANDARD FINISHES**

For a complete list of standard wood finishes please see page 577.

**LOCKS**

Locks are standard on all lateral file drawers. Optional locks on bookcase doors are available at a **\$152 list** upcharge. Please specify at time of order.

# STRATFORD | RETURNS

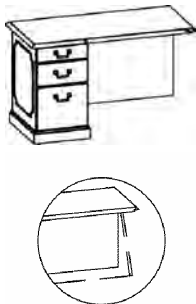
Description	Model	Cherry Walnut	W	D	H	KW	Shipping Weight	Cubic Feet
	98RH4220L4D	3553	41.75	20.5	30.5	23	114	22
	98RH4220L4F	3553	41.75	20.5	30.5	23	114	22
	98RH4220R4D	3553	41.75	20.5	30.5	23	114	22
	98RH4220R4F	3553	41.75	20.5	30.5	23	118	22
	98RH4224L4D	3602	41.75	23.75	30.5	23	118	26
	98RH4224L4F	3602	41.75	23.75	30.5	23	114	26
	98RH4224R4D	3602	41.75	23.75	30.5	23	114	26
	98RH4224R4F	3602	41.75	23.75	30.5	23	114	26
	98RH4820L4D	3633	47.75	20.5	30.5	27	118	25
	98RH4820L4F	3633	47.75	20.5	30.5	27	118	25
	98RH4820R4D	3633	47.75	20.5	30.5	27	118	25
	98RH4820R4F	3633	47.75	20.5	30.5	27	122	25
	98RH4824L4D	3647	47.75	23.75	30.5	27	122	29
	98RH4824L4F*	3647	47.75	23.75	30.5	27	118	29
	98RH4824R4D	3647	47.75	23.75	30.5	27	118	29
	98RH4824R4F	3647	47.75	23.75	30.5	27	118	29
	98RH5420L4D	3679	53.75	20.5	30.5	35	122	28
	98RH5420L4F	3679	53.75	20.5	30.5	35	122	28
	98RH5420R4D	3679	53.75	20.5	30.5	35	122	28
	98RH5420R4F	3679	53.75	20.5	30.5	35	126	28
	98RH5424L4D	3720	53.75	23.75	30.5	35	126	32
	98RH5424L4F	3720	53.75	23.75	30.5	35	122	32
	98RH5424R4D	3720	53.75	23.75	30.5	35	122	32
	98RH5424R4F	3720	53.75	23.75	30.5	35	122	32
	98RH6020L4D	3798	59.75	20.5	30.5	41	126	31
	98RH6020L4F	3798	59.75	20.5	30.5	41	126	31
	98RH6020R4D	3798	59.75	20.5	30.5	41	126	31
	98RH6020R4F	3798	59.75	20.5	30.5	41	130	31
	98RH6024L4D	3870	59.75	23.75	30.5	41	130	36
	98RH6024L4F	3870	59.75	23.75	30.5	41	126	36
	98RH6024R4D	3870	59.75	23.75	30.5	41	126	36
	98RH6024R4F	3870	59.75	23.75	30.5	41	126	36
98RH6620L4D	4063	65.75	20.5	30.5	47	130	33	
98RH6620L4F	4063	65.75	20.5	30.5	47	130	33	
98RH6620R4D	4063	65.75	20.5	30.5	47	130	33	
98RH6620R4F	4063	65.75	20.5	30.5	47	165	33	
98RH6624L4D	4108	65.75	23.75	30.5	47	165	39	
98RH6624L4F	4108	65.75	23.75	30.5	47	130	39	
98RH6624R4D	4108	65.75	23.75	30.5	47	130	39	
98RH6624R4F	4108	65.75	23.75	30.5	47	130	39	

**ORDERING NOTES:**

Modesty panels on returns are raised above the base mounding. Laminate worksurfaces are available at a 10% upcharge. For wire management cut out option on modesty panel add **\$194 list upcharge**. For hinged modesty panel upcharge insert Y after the C in the model number. e.g. 98CY7224LORF

**DIMENSION KEY**

W — width  
 D — depth  
 H — height of worksurface  
 KW— kneehole width

Dimensions are in inches and approximate. Contact Customer Service if dimensions are critical.

\*See page 5 for KrugExpress program.

**CODE DESCRIPTION**

0 - no pedestal  
 4 - full height pedestals  
 D - 2 file drawer  
 F - 2 box, 1 file drawer  
 L - left hand support position  
 R - right hand support position  
 CD - center drawer  
 OT - oversized top option  
 BT - bow top option  
 CC - corner credenza

**STANDARD FINISHES**

For a complete list of standard wood finishes please see page 577.

**WIRING GROMMET**

One rectangular black or one antique brass grommet in a standard position is optional at no charge. Please note grommet choice clearly on order form. Additional grommets are available at an upcharge of **\$152 list**.

# STRATFORD | RETURNS

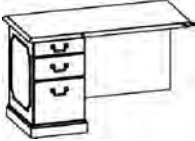
Description	Model	Cherry		W	D	H	KW	Shipping Weight	Cubic Feet
		Walnut							
 Single Pedestal Return, Continued	98RH7220L4D	4168		71.75	20.5	30.5	53	165	36
	98RH7220L4F*	4168		71.75	20.5	30.5	53	165	36
	98RH7220R4D	4168		71.75	20.5	30.5	53	165	36
	98RH7220R4F	4168		71.75	20.5	30.5	53	170	36
	98RH7224L4D	4244		71.75	23.75	30.5	53	170	42
	98RH7224L4F	4244		71.75	23.75	30.5	53	165	42
	98RH7224R4D	4244		71.75	23.75	30.5	53	165	42
	98RH7224R4F	4244		71.75	23.75	30.5	53	165	42

### ORDERING NOTES:

Modesty panels on returns are raised above the base mounding. Laminate worksurfaces are available at a 10% upcharge. For wire management cut out option on modesty panel add **\$194 list** upcharge. For hinged modesty panel upcharge insert Y after the C in the model number. e.g. 98CY7224LORF

Return Shells	Model	Cherry		W	D	H	KW	Shipping Weight	Cubic Feet
		Walnut							
	98RH4224L0*	2140		41.75	23.75	30.5	39.25	68	26
	98RH4224R0	2140		41.75	23.75	30.5	39.25	68	26
	98RH4824L0	2168		47.75	23.75	30.5	45.25	72	29
	98RH4824R0	2168		47.75	23.75	30.5	45.25	72	29

Bullet Return, Post Leg	Model	Cherry		W	D	H	KW	Shipping Weight	Cubic Feet
		Walnut							
	98BR6030	1998		59.75	29.75	30.5		66	3
	98BR6630	2024		65.75	29.75	30.5		81	4
	98BR6636	2053		65.75	35.75	30.5		101	4
	98BR7230	2089		71.75	29.75	30.5		106	4
	98BR7236*	2158		71.75	35.75	30.5		116	5

### ORDERING NOTES:

Bullet desk/return legs are 10.5 in diameter. Bullet desks are available in 72" lengths only for KrugExpress. Laminate worksurfaces are available at a 10% upcharge.

"P" Return, Post Leg	Model	Cherry		W	D	H	KW	Shipping Weight	Cubic Feet
		Walnut							
	98PR7230L	3195		71.75	35.75	30.5		112	43
	98PR7230R	3195		71.75	35.75	30.5		112	43
	98PR7236L	3336		71.75	41.75	30.5		128	51
	98PR7236R*	3336		71.75	41.75	30.5		128	51
	98PR7836L	3408		77.75	41.75	30.5		128	47
	98PR8430L	3408		83.75	35.75	30.5		128	47
	98PR8430R	3522		83.75	35.75	30.5		128	56
	98PR8436L	3522		83.75	41.75	30.5		128	56
	98PR8436R	3620		83.75	41.75	30.5		128	50
	98PR7836R	3620		77.75	41.75	30.5		128	50
	98PR7830L	3723		77.75	35.75	30.5		142	60
	98PR7830R	3723		77.75	35.75	30.5		142	60

### ORDERING PROCEDURES

To order, please specify the following:

- 1) Krug product model number
- 2) Wood species and finish, see page 577
- 4) Pull style and finish, see page 581
- 5) Grommet location and style if applicable

\* Indicates model illustrated by line drawing

### CODE DESCRIPTION

- 0 - no pedestal
- 4 - full height pedestals
- D - 2 file drawer
- F - 2 box, 1 file drawer
- L - left hand support position
- R - right hand support position
- CD - center drawer
- OT - oversized top option
- BT - bow top option
- CC - corner credenza

### STANDARD FINISHES

For a complete list of standard wood finishes please see page 577.

### WIRING GROMMET

One rectangular black or one antique brass grommet in a standard position is optional at no charge. Please note grommet choice clearly on order form. Additional grommets are available at an upcharge of **\$152 list**.

# STRATFORD | LINKING UNITS & CORNER UNITS

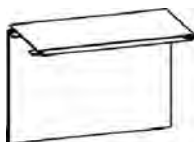
Description	Model	Cherry Walnut				KW	Shipping Weight	Cubic Feet
			W	D	H			
	98LU3620H	1673	34.75	19.75	30.5		15	3
	98LU3624H	1728	34.75	23.75	30.5		16	3
	98LU4220H	1749	38.75	19.75	30.5		20	4
	98LU4224H*	1809	38.75	23.75	30.5		24	4
	98LU4820H	1844	44.75	19.75	30.5		29	4
	98LU4824H	1883	44.75	23.75	30.5		36	4

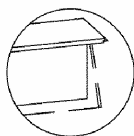

**ORDERING NOTES:**

Please note on order if picture frame molding is required on hinged modesty panel. Laminate worksurfaces are available at a 10% upcharge.

For wire management cut out option on modesty panel add **\$94 list upcharge**.

For hinged modesty panel upcharge add 10% and insert Y after the LU in the model number. e.g. 98LUY4224H

Linking Tops	Model	Cherry Walnut				KW	Shipping Weight	Cubic Feet
			W	D	H			
	98LT3620H	830	34.75	19.75	1.25		15	2
	98LT3624H	840	34.75	23.75	1.25		16	2
	98LT4220H	864	38.75	19.75	1.25		20	2
	98LT4224H*	889	38.75	23.75	1.25		24	2
	98LT4820H	909	44.75	19.75	1.25		29	2
	98LT4824H	929	44.75	23.75	1.25		36	3

**ORDERING NOTES:**

Laminate worksurfaces are available at a 10% upcharge.

Corner Units	Model	Cherry Walnut				KW	Shipping Weight	Cubic Feet
			W	D	H			
			98CU363620	3277	35.75			
98CU363624*	3277	35.75	35.75	30.5	17	106	33	
98CU424224	3602	41.75	41.75	30.5	25.5	131	41	

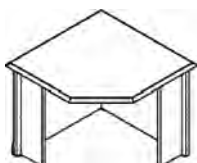

**ORDERING NOTES:**

Laminate worksurfaces are available at a 10% upcharge. The x dimension on the 98CU363624 corner unit does not allow for an undersurface mounted keyboard or pencil drawer. Please specify a 98KBAC2110 with an extended mechanism if keyboard is required. See page 604.

**DIMENSION KEY**

- W – width
- D – depth
- H – height of worksurface
- KW – kneehole width

Dimensions are in inches and approximate. Contact Customer Service if dimensions are critical.

\*See page 5 for KrugExpress program.

**CODE DESCRIPTION**

- 4 - full height pedestals
- D - 2 file drawer
- F - 2 box, 1 file drawer
- L - left hand support position
- R - right hand support position
- CU - corner unit
- LT - linking top
- Lu - linking unit

**STANDARD FINISHES**

For a complete list of standard wood finishes please see page 577.

**WIRING GROMMET**

One rectangular black or one antique brass grommet in a standard position is optional at no charge. Please note grommet choice clearly on order form. Additional grommets are available at an upcharge of **\$152 list**.

# STRATFORD | CREDENZAS

Description	Model	Cherry Walnut	W	D	H	Shipping Weight	Cubic Feet
 Credenza Shells	98S6624LOR0*	2650	65.75	23.75	30.5	121	32
	98S7224LOR0	2890	71.75	23.75	30.5	137	35
	98S7824LOR0	3141	77.75	23.75	30.5	153	38

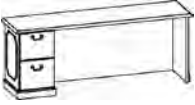
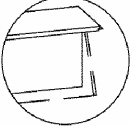
Description	Model	Cherry Walnut	W	D	H	Shipping Weight	Cubic Feet	
  Single Pedestal Credenza	98C66204LDR0	4636	65.75	19.75	30.5	46.5	163	33
	98C66204LFR0	4636	65.75	19.75	30.5	46.5	163	33
	98C66204LORD	4636	65.75	19.75	30.5	46.5	163	33
	98C66204LORF	4636	65.75	19.75	30.5	46.5	163	33
	98C66244LDR0	4637	65.75	23.75	30.5	46.5	171	38
	98C66244LFR0	4637	65.75	23.75	30.5	46.5	171	38
	98C66244LORD	4637	65.75	23.75	30.5	46.5	171	38
	98C66244LORF	4637	65.75	23.75	30.5	46.5	171	38
	98C72204LDR0	4675	71.75	19.75	30.5	52.5	179	36
	98C72204LFR0	4675	71.75	19.75	30.5	52.5	179	36
	98C72204LORD	4675	71.75	19.75	30.5	52.5	179	36
	98C72204LORF	4675	71.75	19.75	30.5	52.5	179	36
	98C72244LDR0	4710	71.75	23.75	30.5	52.5	187	41
	98C72244LFR0	4710	71.75	23.75	30.5	52.5	187	41
	98C72244LORD	4710	71.75	23.75	30.5	52.5	187	41
	98C72244LORF	4710	71.75	23.75	30.5	52.5	187	41
	98C78204LDR0*	4689	77.75	19.75	30.5	58.5	195	38
	98C78204LFR0	4689	77.75	19.75	30.5	58.5	195	38
	98C78204LORD	4689	77.75	19.75	30.5	58.5	195	38
	98C78204LORF	4689	77.75	19.75	30.5	58.5	195	38
	98C78244LDR0	4689	77.75	23.75	30.5	58.5	203	44
	98C78244LFR0	4689	77.75	23.75	30.5	58.5	203	44
	98C78244LORD	4689	77.75	23.75	30.5	58.5	203	44
	98C78244LORF	4689	77.75	23.75	30.5	58.5	203	44
	98C84204LDR0	4713	83.75	19.75	30.5	64.5	211	41
	98C84204LFR0	4713	83.75	19.75	30.5	64.5	211	41
	98C84204LORD	4713	83.75	19.75	30.5	64.5	211	41
	98C84204LORF	4713	83.75	19.75	30.5	64.5	211	41
98C84244LDR0	4735	83.75	23.75	30.5	64.5	219	48	
98C84244LFR0	4735	83.75	23.75	30.5	64.5	219	48	
98C84244LORD	4735	83.75	23.75	30.5	64.5	219	48	
98C84244LORF	4735	83.75	23.75	30.5	64.5	219	48	

### ORDERING NOTES:

Please note on order if picture frame molding is required on hinged modesty panel. Laminate worksurfaces are available at a 10% upcharge. For wire management cut out option on modesty panel add **\$194 list** upcharge. For hinged modesty panel add a 10% upcharge and insert Y after the C in the model number. e.g. 98CY72244LORF

### ORDERING PROCEDURES

To order, please specify the following:

- 1) Krug product model number
- 2) Wood species and finish, see page 577
- 4) Pull style and finish, see page 581
- 5) Grommet location and style if applicable

\* Indicates model illustrated by line drawing

### CODE DESCRIPTION

0 - no pedestal  
 4 - full height pedestals  
 D - 2 file drawer  
 F - 2 box, 1 file drawer  
 L - left hand support position  
 R - right hand support position  
 CD - center drawer  
 OT - oversized top option  
 BT - bow top option  
 CC - corner credenza

### STANDARD FINISHES

For a complete list of standard wood finishes please see page 577.

### WIRING GROMMET

One rectangular black or one antique brass grommet in a standard position is optional at no charge. Please note grommet choice clearly on order form. Additional grommets are available at an upcharge of **\$152 list**.

**STRATFORD | CREDENZAS**

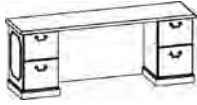
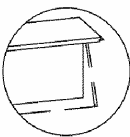
Description	Model	Cherry Walnut	W	D	H	KW	Shipping Weight	Cubic Feet
Double Pedestal Credenza	98C66204LDRD	4978	65.75	19.75	30.5	31.5	198	33
	98C66204LDRF	4978	65.75	19.75	30.5	31.5	198	33
	98C66204LFRD	4978	65.75	19.75	30.5	31.5	198	33
	98C66204LFRF	4978	65.75	19.75	30.5	31.5	198	33
	98C66244LDRD	4988	65.75	23.75	30.5	31.5	211	38
	98C66244LDRF	4988	65.75	23.75	30.5	31.5	211	38
	98C66244LFRD	4988	65.75	23.75	30.5	31.5	211	38
	98C66244LFRF	4988	65.75	23.75	30.5	31.5	211	38
	98C72204LDRD	5031	71.75	19.75	30.5	37.5	214	36
	98C72204LDRF	5031	71.75	19.75	30.5	37.5	214	36
	98C72204LFRD	5031	71.75	19.75	30.5	37.5	214	36
	98C72204LFRF	5031	71.75	19.75	30.5	37.5	214	36
	98C72244LDRD	5065	71.75	23.75	30.5	37.5	227	41
	98C72244LDRF	5065	71.75	23.75	30.5	37.5	227	41
	98C72244LFRD	5065	71.75	23.75	30.5	37.5	227	41
	98C72244LFRF	5065	71.75	23.75	30.5	37.5	227	41
	98C78204LDRD*	5111	77.75	19.75	30.5	43.5	230	38
	98C78204LDRF	5111	77.75	19.75	30.5	43.5	230	38
	98C78204LFRD	5111	77.75	19.75	30.5	43.5	230	38
	98C78204LFRF	5111	77.75	19.75	30.5	43.5	230	38
	98C78244LDRD	5157	77.75	23.75	30.5	43.5	243	44
	98C78244LDRF	5157	77.75	23.75	30.5	43.5	243	44
	98C78244LFRD	5157	77.75	23.75	30.5	43.5	243	44
	98C78244LFRF	5157	77.75	23.75	30.5	43.5	243	44
	98C84204LDRD	5166	83.75	19.75	30.5	49.5	246	41
	98C84204LDRF	5166	83.75	19.75	30.5	49.5	246	41
	98C84204LFRD	5166	83.75	19.75	30.5	49.5	246	41
	98C84204LFRF	5166	83.75	19.75	30.5	49.5	246	41
	98C84244LDRD	5179	83.75	23.75	30.5	49.5	259	48
	98C84244LDRF	5179	83.75	23.75	30.5	49.5	259	48
	98C84244LFRD	5179	83.75	23.75	30.5	49.5	259	48
	98C84244LFRF	5179	83.75	23.75	30.5	49.5	259	48

**ORDERING NOTES:**

Please note on order if picture frame molding is required on hinged modesty panel. Laminate worksurfaces are available at a 10% upcharge.

For wire management cut out option on modesty panel add **\$194 list upcharge**.

For hinged modesty panel add a 10% upcharge and insert Y after the C in the model number. e.g. 98CY7224LFRF

**DIMENSION KEY**

W — width  
 D — depth  
 H — height of worksurface  
 KW— kneehole width

Dimensions are in inches and approximate. Contact Customer Service if dimensions are critical.

\*See page 5 for KrugExpress program.

**CODE DESCRIPTION**

0 - no pedestal  
 4 - full height pedestals  
 D - 2 file drawer  
 F - 2 box, 1 file drawer  
 L - left hand support position  
 R - right hand support position  
 CD - center drawer  
 OT - oversized top option  
 BT - bow top option  
 CC - corner credenza

**STANDARD FINISHES**

For a complete list of standard wood finishes please see page 577.

**WIRING GROMMET**

One rectangular black or one antique brass grommet in a standard position is optional at no charge. Please note grommet choice clearly on order form. Additional grommets are available at an upcharge of **\$152 list**.

# STRATFORD | CREDENZAS

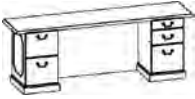
Description	Model	Cherry		W	D	H	Shipping Weight	Cubic Feet
		Walnut						
	OT98C6620	308		71.75	19.75	-	15	-
	OT98C6624	308		71.75	23.75	-	15	-
	OT98C7220	308		77.75	19.75	-	15	-
	OT98C7224	308		77.75	23.75	-	15	-
	OT98C7820*	308		83.75	19.75	-	15	-
	OT98C7824	308		83.75	23.75	-	15	-

### ORDERING NOTES:

In the 20" deep knee hole credenzas and/or shells the pencil drawer cannot be used. The oversized top option is only available on stand-alone double pedestal credenzas and cannot be used in conjunction with any other run-off connecting worksurfaces. Specifying the oversized top option increases the top width, increasing the left and right overhang measurement to 4 1/2". The front and rear overhang remains unchanged. Laminate worksurfaces are available at a 10% upcharge.

Description	Model		Cherry		W	D	H	Shipping Weight	Cubic Feet
			Walnut						
	98C6620LBR0	4233		65.75	19.75	30.5	25.75	204	33
	98C6620LFR0	4233		65.75	19.75	30.5	25.75	212	33
	98C6620LORB	4233		65.75	19.75	30.5	25.75	204	33
	98C6620LORF	4233		65.75	19.75	30.5	25.75	212	33
	98C6624LBR0	4316		65.75	23.75	30.5	25.75	211	38
	98C6624LFR0	4316		65.75	23.75	30.5	25.75	227	38
	98C6624LORB	4316		65.75	23.75	30.5	25.75	211	38
	98C6624LORF	4316		65.75	23.75	30.5	25.75	227	38
	98C7220LBR0	4414		71.75	19.75	30.5	31.75	228	36
	98C7220LFR0	4414		71.75	19.75	30.5	31.75	236	36
	98C7220LORB	4414		71.75	19.75	30.5	31.75	228	36
	98C7220LORF	4414		71.75	19.75	30.5	31.75	236	36
	98C7224LBR0	4509		71.75	23.75	30.5	31.75	235	41
	98C7224LFR0	4509		71.75	23.75	30.5	31.75	243	41
	98C7224LORB	4509		71.75	23.75	30.5	31.75	235	41
	98C7224LORF	4509		71.75	23.75	30.5	31.75	243	41
	98C8420LBR0	4635		83.75	19.75	30.5	43.75	256	41
	98C8420LFR0	4635		83.75	19.75	30.5	43.75	268	41
	98C8420LORB	4635		83.75	19.75	30.5	43.75	256	41
	98C8420LORF	4635		83.75	19.75	30.5	43.75	268	41
	98C8424LBR0	4732		83.75	23.75	30.5	43.75	267	48
	98C8424LFR0	4732		83.75	23.75	30.5	43.75	275	48
	98C8424LORB	4732		83.75	23.75	30.5	43.75	267	48
	98C8424LORF*	4732		83.75	23.75	30.5	43.75	275	48

### ORDERING NOTES:

Please note on order if picture frame molding is required on hinged modesty panel. Laminate worksurfaces are available at a 10% upcharge. Bookcase pedestals include one adjustable shelf. For hinged modesty panel add a 10% upcharge and insert Y after the C in the model number. e.g. 98CY7224LORF

### ORDERING PROCEDURES

To order, please specify the following:

- 1) Krug product model number
- 2) Wood species and finish, see page 577
- 4) Pull style and finish, see page 581
- 5) Grommet location and style if applicable

\* Indicates model illustrated by line drawing

### CODE DESCRIPTION

- 0 - no pedestal
- 4 - full height pedestals
- D - 2 file drawer
- F - 2 box, 1 file drawer
- L - left hand support position
- R - right hand support position
- CD - center drawer
- OT - oversized top option
- BT - bow top option
- CC - corner credenza

### STANDARD FINISHES

For a complete list of standard wood finishes please see page 577.

### WIRING GROMMET

One rectangular black or one antique brass grommet in a standard position is optional at no charge. Please note grommet choice clearly on order form. Additional grommets are available at an upcharge of **\$152 list**.

**STRATFORD | CREDENZAS**

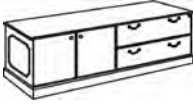
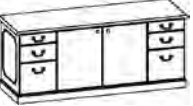
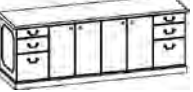
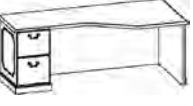
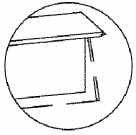
Description	Model	Cherry Walnut	W	D	H	KW	Shipping Weight	Cubic Feet
	98C6320LFRF	6079	62.5	19.75	30.5		304	27
	98C6324LFRF	6108	62.5	23.75	30.5		316	27
	98C7220LBRF	6214	71.75	19.75	30.5		320	29
	98C7220LFRB	6214	71.75	19.75	30.5		320	29
	98C7224LBRF*	6334	71.75	23.75	30.5		331	35
	98C7224LFRB	6334	71.75	23.75	30.5		331	35
	98C7520LFRF	6953	74.5	19.75	30.5		334	37
	98C7524LFRF	7016	74.5	23.75	30.5		347	37
 	98C66204FBCF	5713	65.75	19.75	30.5	25.75	250	33
	98C66204DBCD	5713	65.75	19.75	30.5	25.75	246	33
	98C66244FBCF	5807	65.75	23.75	30.5	25.75	263	38
	98C66244DBCD	5807	65.75	23.75	30.5	25.75	259	38
	98C72204FBCF	5980	71.75	19.75	30.5	25.75	266	36
	98C72204DBCD	5980	71.75	19.75	30.5	25.75	262	36
	98C72244FBCF*	6153	71.75	23.75	30.5	25.75	279	41
	98C72244DBCD	6153	71.75	23.75	30.5	25.75	275	41
	98C84204FBCF	6328	83.75	19.75	30.5	31.75	298	41
	98C84204DBCD	6328	83.75	19.75	30.5	31.75	294	41
	98C84244FBCF**	6498	83.75	23.75	30.5	31.75	311	48
	98C84244DBCD	6498	83.75	23.75	30.5	31.75	307	48
 	98CC6624L4D	3978	65.75	35.75	30.5	37.5	184	55
	98CC6624R4D	3978	65.75	35.75	30.5	20.5	184	55
	98CC6624L4F	3978	65.75	35.75	30.5	20.5	184	55
	98CC6624R4F	3978	65.75	35.75	30.5	20.5	184	55
	98CC7224L4D*	4071	71.75	35.75	30.5	20.5	202	60
	98CC7224R4D	4071	71.75	35.75	30.5	20.5	202	60
	98CC7224L4F	4071	71.75	35.75	30.5	20.5	202	60
	98CC7224R4F	4071	71.75	35.75	30.5	20.5	202	60
	98CC7824L4D	4118	77.75	35.75	30.5	20.5	210	64
	98CC7824R4D	4118	77.75	35.75	30.5	20.5	210	64
	98CC7824L4F	4118	77.75	35.75	30.5	20.5	210	64
	98CC7824R4F	4118	77.75	35.75	30.5	20.5	210	64
	98CC8424L4D	4162	83.75	35.75	30.5	20.5	218	69
	98CC8424R4D	4162	83.75	35.75	30.5	20.5	218	69
	98CC8424L4F	4162	83.75	35.75	30.5	20.5	218	69
	98CC8424R4F	4162	83.75	35.75	30.5	20.5	218	69

**ORDERING NOTES:**

Corner credenzas allow for a 24" deep unit at the connecting end. Laminate worksurfaces are available at a 10% upcharge. For wire management cut out option on modesty panel add **\$194 list** upcharge. For hinged modesty panel add a 10% upcharge and insert Y after the C in the model number. e.g. 98CY7224LORF

**DIMENSION KEY**

W — width  
 D — depth  
 H — height of worksurface  
 KW— kneehole width

Dimensions are in inches and approximate.  
 Contact Customer Service if dimensions are critical.

\*See page 5 for KrugExpress program.

**CODE DESCRIPTION**

0 - no pedestal  
 4 - full height pedestals  
 D - 2 file drawer  
 F - 2 box, 1 file drawer  
 L - left hand support position  
 R - right hand support position  
 CD - center drawer  
 OT - oversized top option  
 BT - bow top option  
 CC - corner credenza

**STANDARD FINISHES**

For a complete list of standard wood finishes please see page 577.

**WIRING GROMMET**

One rectangular black or one antique brass grommet in a standard position is optional at no charge. Please note grommet choice clearly on order form. Additional grommets are available at an upcharge of **\$152 list**.



# STRATFORD | OVERHEADS

Description	Model	Cherry Walnut	W	D	H	Doors	Shipping	
							Weight	Cubic Feet
Overheads with Wood Doors   *	98OH3616*	1844	35.75	16	16	2	53	8
	98OH4216	1960	41.75	16	16	2	57	9
	98OH4816	2037	47.75	16	16	3	77	10
	98OH5416	2205	53.75	16	16	4	81	11
	98OH6016	2377	59.75	16	16	4	88	12
	98OH6616**	2506	65.75	16	16	4	94	13
	98OH7216	2638	71.75	16	16	4	99	14

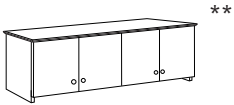

## Tackboards Grades

Description	Model	1	2	3	4	5	6	7	8	9	W	H	COM	WT
Tackboards for use with Overheads  	98TBOH36	302	330	359	408	537	656	779	904	1179	34	26	1.5	11
	98TBOH42	313	339	368	412	537	651	766	886	1149	41.75	26	1.5	12
	98TBOH48	346	431	453	567	679	780	898	1033	1297	47.75	26	1.75	13
	TBOH54	358	468	512	652	763	873	1006	1137	1396	55.75	26	1.75	14
	TBOH60	391	522	552	688	822	978	1127	1285	1547	61.75	26	2	15
	TBOH66	433	586	580	805	962	1149	1305	1487	1767	67.75	26	2	16
	TBOH72	476	725	756	1002	1231	1245	1431	1636	1896	74.75	26	2.25	19

### ORDERING PROCEDURES

To order, please specify the following:

- 1) Krug product model number
- 2) Wood species and finish, see page 577
- 4) Pull style and finish, see page 581
- 5) Grommet location and style if applicable

\* Indicates model illustrated by line drawing

### CODE DESCRIPTION

OH - overhead unit  
W - includes power/data/voice grommet  
G - includes glass doors  
Z - includes grill doors  
PM - paper manager  
TBOH- tackboard for overhead

### STANDARD FINISHES

For a complete list of standard wood finishes please see page 577.

### OVERHEADS

All overheads include installed tasklights and mounting hardware. Contact customer service for information about flush units. Tackboards must be ordered separately.

# STRATFORD | HUTCHES

Description	Model	Cherry Walnut	W	D	H	KW	Shipping Weight	Cubic Feet
5-Hi Hutch with Wood Doors 	98HT601640	3698	59.75	16	40	23.5	150	26
	98HT661640*	4044	65.75	16	40	23.5	162	28
	98HT721640	4748	71.75	16	40	23.5	174	31
	98HT781640	5033	77.75	16	40	23.5	186	33
	98HT841640	5316	83.75	16	40	23.5	200	36

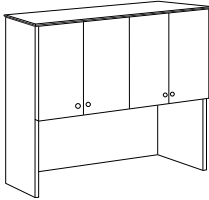
6-Hi Hutch with Wood Doors 	98HT601653	4498	59.75	16	53	23.5	200	34
	98HT661653*	4994	65.75	16	53	23.5	212	37
	98HT721653	5718	71.75	16	53	23.5	224	41
	98HT781653	6153	77.75	16	53	23.5	236	44
	98HT841653	6590	83.75	16	53	23.5	250	47

**ORDERING NOTES:**

Hutches are inset 1-1/2" on each side when sitting on the worksurface. Locks are available on wood door hutches and overheads at **\$152 list** per set of (2) doors.

6-Hi Hutch with Glass Doors 	98HT601653G	4764	59.75	16	53	23.5	117	34
	98HT661653G*	5292	65.75	16	53	23.5	126	37
	98HT721653G	6057	71.75	16	53	23.5	135	41
	98HT781653G	6522	77.75	16	53	23.5	146	44
	98HT841653G	6983	83.75	16	53	23.5	154	47

**ORDERING NOTES:**

All shelves in glass door hutches are 1/4" thick glass. Hutches are inset 1-1/2" on each side when sitting on the worksurface.

6-Hi Hutch with Grill Doors 	98HT601653Z	5421	59.75	16	53	23.5	150	34
	98HT661653Z*	5919	65.75	16	53	23.5	162	37
	98HT721653Z	6644	71.75	16	53	23.5	174	41
	98HT781653Z	7074	77.75	16	53	23.5	186	44
	98HT841653Z	7513	83.75	16	53	23.5	200	47

**ORDERING NOTES:**

All shelves in grill door hutches are 1/4" thick glass. This Hutch includes a factory installed tasklight and a tackboard in Grade 1 fabric. Grill doors are NOT available on KrugExpress. Hutches are inset 1-1/2" on each side when sitting on the worksurface.

**DIMENSION KEY**

W — width  
 D — depth  
 H — height of worksurface  
 KW— kneehole width

Dimensions are in inches and approximate. Contact Customer Service if dimensions are critical.

\*See page 5 for KrugExpress program.

**CODE DESCRIPTION**

OH - overhead unit  
 W - includes power/data/voice grommet  
 G - includes glass doors  
 Z - includes grill doors  
 PM - paper manager  
 TBOH- tackboard for overhead

**STANDARD FINISHES**

For a complete list of standard wood finishes please see page 577.

**HUTCHES**

Hutches include tasklights and a tackboard in grade 1 fabric. See page 603 for upcharges for grades 2-9.

# STRATFORD | HUTCHES

Description	Model	Cherry Walnut				Shipping Weight	Cubic Feet
			W	D	H		
6-Hi Full Height Hutch with Clear Glass Doors	98HT60165301G	5242	59.75	16	53	200	34
	98HT66165301G*	5821	65.75	16	53	212	37
	98HT72165301G	6663	71.75	16	53	224	41
	98HT78165301G	7174	77.75	16	53	232	44
	98HT84165301G	7682	83.75	16	53	250	47

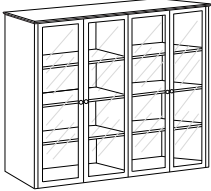

**ORDERING NOTES:**

All shelves in glass door hutches are 1/4" thick glass. Hutches are inset 1-1/2" on each side when sitting on the worksurface.

6-Hi Full Height Hutch with Grill Doors	98HT60165301Z	6146	59.75	16	53	190	34
	98HT66165301Z*	6510	65.75	16	53	202	37
	98HT72165301Z	7305	71.75	16	53	212	41
	98HT78165301Z	7785	77.75	16	53	222	44
	98HT84165301Z	8262	83.75	16	53	240	47

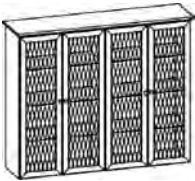

**ORDERING NOTES:**

All shelves in grill door hutches are 1/4" thick glass. Grill doors are NOT available on KrugExpress. Hutches are inset 1-1/2" on each side when sitting on the worksurface.

Paper Managers	98PM18132001	1786	16.5	13	19.5	15	4
----------------	--------------	------	------	----	------	----	---



**ORDERING PROCEDURES**

To order, please specify the following:

- 1) Krug product model number
- 2) Wood species and finish, see page 577
- 4) Pull style and finish, see page 581
- 5) Grommet location and style if applicable

\* Indicates model illustrated by line drawing

**CODE DESCRIPTION**

OH - overhead unit  
 W - includes power/data/voice grommet  
 G - includes glass doors  
 Z - includes grill doors  
 PM - paper manager  
 TBOH- tackboard for overhead

**STANDARD FINISHES**

For a complete list of standard wood finishes please see page 577.

**HUTCHES**

Hutches include tasklights and a tackboard in grade 1 fabric. See page 603 for upcharges for grades 2-9.

# STRATFORD | HUTCHES

**Hutch tackboard upgrade chart**

Use this chart to find the upcharge for tackboard fabrics graded 2-9 and add it to the cost of the hutch. Fabric grades can be referenced on page 4.

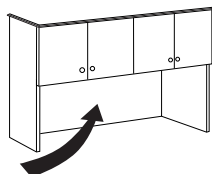

Pot light option for Hutches

	FABRIC GRADES									COM
	2	3	4	5	6	7	8	9		
65" hutch tackboard	137	294	426	568	705	842	981	1282	2	
71" hutch tackboard	154	333	485	643	803	955	1107	1332	2.25	
78" hutch tackboard	183	391	580	777	957	1141	1279	1634	2.5	
84" hutch tackboard	220	464	729	959	1199	1403	1508	1813	2.5	
91" hutch tackboard	259	537	794	1053	1306	1402	1818	2126	2.75	
Pot Light	567	Per hutch (includes two lights)								

**ORDERING NOTES :**

The factory installed pot light option is available on any glass door or grill door hutch. The two lights are mounted through the hutch top and activated by a switch located on the light inside the case. Please add the upcharge shown above to hutch price and specify pot light option on your order. This item is not available on KrugExpress.

On single piece hutches, the yardage requirement for two tackboards is the same as for one tackboard. Please keep this in mind when ordering more than one tackboard. For example, if the number of tackboards required is 7 and the COM requirement for 1 tackboard is 1.5 yards, the calculation for COM yardage is as follows: 4.5 yards are required for 6 tackboards + 1.5 yards for the 7th tackboard for a total of 6 yards. In the case of an even number of tackboards, divide the number of tackboards required by 2 and multiply that number by the COM requirement on the chart. The fabric must be at least 54" wide in order to qualify for this procedure. If the fabric is less than 54" wide, the COM yardage listed on the chart is the amount required for each tackboard.

**COM yardage Calculation Chart of Tackboards**

Quantity of Tackboards Required (example: 60")	Number of yards Required per Tackboard (example: 60")	Number of yards Required in Total (example: 60")
one	2 yards	2
two	2 yards	2
three	2 yards	4
four	2 yards	4
fiv	2 yards	6
six	2 yards	6
seven	2 yards	8
eight	2 yards	8
nine	2 yards	10
ten	2 yards	10

**DIMENSION KEY**

- W — width
- D — depth
- H — height of worksurface
- KW— kneehole width

Dimensions are in inches and approximate. Contact Customer Service if dimensions are critical.

\*See page 5 for KrugExpress program.

**CODE DESCRIPTION**

PM — paper manager

# STRATFORD | KEYBOARDS & PENCIL DRAWERS

Description	Model	Cherry Walnut	W	D	H	Shipping Weight	Cubic Feet
Articulating Keyboard Tray with Palm Rest and Mouse Tray/Extended Mechanism	98KBAMT1912	694	-	-	-	20	2

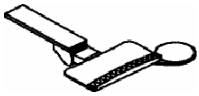

**ORDERING NOTES:**

This unit comes with a lever free arm keyboard support. This unit is a granite color.

Pencil Drawer	98PD2116	589	-	-	-	2	1
---------------	----------	-----	---	---	---	---	---



Wire Management Cover	98WM72	157	-	-	-	3	7
-----------------------	--------	-----	---	---	---	---	---



Velcro Wire Management	98WM4	33	-	-	-	1	1
------------------------	-------	----	---	---	---	---	---



Power Data Module	98PDVM	252	-	-	-	1	1
-------------------	--------	-----	---	---	---	---	---



**ORDERING NOTES:**

This grommet is only available in black.

**ORDERING PROCEDURES**

To order, please specify the following:

- 1) Krug product model number
- 2) Wood species and finish, see page 577
- 4) Pull style and finish, see page 581
- 5) Grommet location and style if applicable

\* Indicates model illustrated by line drawing

**CODE DESCRIPTION**

PD - pencil drawer  
 WM - wire management  
 PDVM - power/data/voice grommet

**STANDARD FINISHES**

For a complete list of standard wood finishes please see page 577.

**BRASS FINISH**

Standard grommets and pop-up grommets are available in black or brass finishes.

# STRATFORD | MODULAR COMPONENTS

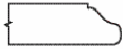
Description	Model	Cherry		W	D	H	Shipping Weight	Cubic Feet
		Walnut						
Tops for 2-Hi Modular Storage  	98TP6020	1178		59.75	19.75	29.25	45	2
	98TP6024	1244		59.75	23.75	1.25	52	2
	98TP6320	1270		62.75	19.75	1.25	48	2
	98TP6324	1286		62.75	23.75	1.25	51	3
	98TP6620*	1305		65.75	19.75	1.25	53	3
	98TP6624	1363		65.75	23.75	1.25	61	3
	98TP6920	1386		68.75	19.75	1.25	57	3
	98TP6924	1412		68.75	23.75	1.25	61	3
	98TP7220	1425		71.75	19.75	1.25	63	3
	98TP7224	1479		71.75	23.75	1.25	65	3
	98TP7520	1488		74.75	19.75	1.25	67	3
	98TP7524	1524		74.75	23.75	1.25	70	3
	98TP7820	1537		77.75	19.75	1.25	71	3
	98TP7824	1592		77.75	23.75	1.25	73	3
	98TP8420	1642		83.75	19.75	1.25	76	3
	98TP8424	1691		83.75	23.75	1.25	78	4
	98TP9020	1741		89.75	19.75	1.25	81	3
	98TP9024	1789		89.75	23.75	1.25	86	4
	98TP9220	1803		91.75	19.75	1.25	85	3
	98TP9224	1828		91.75	23.75	1.25	89	4
98TP9620	1835		95.75	19.75	1.25	88	4	
98TP9624	1887		95.75	23.75	1.25	92	4	

**ORDERING NOTES:**

A half gable is required on any open span greater than 48" that does not have a modesty panel. Standard 98TP tops have profile on the ee sides. They are designed to be flush on the back edge

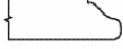

Description	Model	Cherry	Walnut	W	D	H	Shipping Weight	Cubic Feet
 	98TPR6020L	1178		59.75	19.75	1.25	45	2
	98TPR6020R	1178		59.75	19.75	1.25	45	2
	98TPR6024L	1244		59.75	23.75	1.25	52	3
	98TPR6024R	1244		59.75	23.75	1.25	52	3
	98TPR6620L	1305		65.75	19.75	1.25	53	3
	98TPR6620R*	1305		65.75	19.75	1.25	53	3
	98TPR6624L	1363		65.75	23.75	1.25	61	3
	98TPR6624R	1363		65.75	23.75	1.25	61	3
	98TPR7220L	1425		71.75	19.75	1.25	63	3
	98TPR7220R	1425		71.75	19.75	1.25	63	3
	98TPR7224L	1479		71.75	23.75	1.25	65	3
	98TPR7224R	1479		71.75	23.75	1.25	65	3

**ORDERING NOTES:**

A half gable is required on any open span greater than 48" that does not have a modesty panel. Standard 98TP tops have profile on the ee sides. They are designed to be flush on the back edge

<p><b>DIMENSION KEY</b></p> <p>W — width                  D — depth                  H — height of worksurface                  KW— kneehole width</p> <p>Dimensions are in inches and approximate. Contact Customer Service if dimensions are critical.                  *See page 5 for KrugExpress program.</p>	<p><b>CODE DESCRIPTION</b></p> <p>TP - modular top with standard profile                  TPR - modular top for run-offs with one coved connecting end                  TPI - modular top with inverted profile                  ST - freestanding storage                  STM - modular storage                  WRM - modular wardrobe                  G - includes glass doors                  D - 2 file drawer                  F - 2 box, 1 file drawer</p>	<p><b>OPEN SPANS</b></p> <p>It is not recommended that modular units be combined together to create open spans greater than 60".</p> <p><b>STORAGE</b></p> <p>Freestanding storage has finished, profiled tops and base molding on three sides. Modular storage does not have finished tops (they must be ordered separately) and base molding is only across the front.</p>
--	--	--

# STRATFORD | MODULAR COMPONENTS

Description	Model	Cherry		W	D	H	Shipping Weight	Cubic Feet
		Walnut						
Tops with one Coved End, Continued	98TPR7820L	1537		77.75	19.75	1.25	71	3
	98TPR7820R	1537		77.75	19.75	1.25	71	3
	98TPR7824L	1592		77.75	23.75	1.25	73	3
	98TPR7824R	1592		77.75	23.75	1.25	73	3
	98TPR8420L	1642		83.75	19.75	1.25	76	3
	98TPR8420R	1642		83.75	19.75	1.25	76	3
	98TPR8424L*	1691		83.75	23.75	1.25	78	4
	98TPR8424R	1691		83.75	23.75	1.25	78	4
	98TPR9020L	1741		89.75	19.75	1.25	81	3
	98TPR9020R	1741		89.75	19.75	1.25	86	3
	98TPR9024L	1789		89.75	23.75	1.25	86	4
	98TPR9024R	1789		89.75	23.75	1.25	86	4
	98TPR9620L	1835		95.75	19.75	1.25	88	4
	98TPR9620R	1835		95.75	19.75	1.25	88	4
	98TPR9624L	1887		95.75	23.75	1.25	92	4
	98TPR9624R	1887		95.75	23.75	1.25	92	4

### ORDERING NOTES:

A half gable is required on any open span greater than 48" that does not have a modesty panel. Standard 98TP tops have profile on the e sides. They are designed to be flush on the back edge

Modular Pedestal								
	98P1620304D**	1834		15.75	19.75	29.25	68	6
	98P1624304D	1974		15.75	23.75	29.25	73	8
	98P1620304F*	1966		15.75	19.75	29.25	70	6
	98P1624304F	2106		15.75	23.75	29.25	75	8

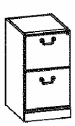
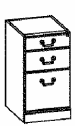

### ORDERING NOTES:

Modular storage units do not have finished tops and are intended to be combined with 98TP tops. Modular storage unit backs are finished. It is not recommended that modular units be combined together to create open spans greater than 60".

### ORDERING PROCEDURES

To order, please specify the following:

- 1) Krug product model number
- 2) Wood species and finish, see page 577
- 4) Pull style and finish, see page 581
- 5) Grommet location and style if applicable

\* Indicates model illustrated by line drawing

### CODE DESCRIPTION

TP - modular top with standard profile  
 TPR - modular top for run-offs with one coved connecting end  
 TPI - modular top with inverted profile  
 ST - freestanding storage  
 STM - modular storage  
 WRM - modular wardrobe  
 G - includes glass doors  
 D - 2 file drawer  
 F - 2 box, 1 file drawer

### STANDARD FINISHES

For a complete list of standard wood finishes please see page 577.

### STORAGE

Freestanding storage has finished, profiled tops and base molding on three sides. Modular storage does not have finished tops (they must be ordered separately) and base molding is only across the front.

# STRATFORD | MODULAR COMPONENTS

Description	Model	Cherry Walnut	W	D	H	Shipping Weight	Cubic Feet
Modular Bookcase	98STM30203011	2096	29.75	19.75	29.25	105	13
Pedestal	98STM36203011	2232	35.75	19.75	29.25	109	15
	98STM30243011*	2163	29.75	19.75	29.25	113	15
	98STM36243011	2304	35.75	19.75	29.25	117	18

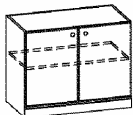

**ORDERING NOTES:**

Modular storage units do not have finished tops and are intended to be combined with 98TP tops. Modular storage unit backs are finished. Locks may be added to the bookcase doors at a **\$152 list upcharge**.

Modular Lateral File	98STM30203001	2504	29.75	19.75	29.25	113	13
Pedestal	98STM36203001	2642	35.75	19.75	29.25	117	15
	98STM30243001*	2576	29.75	19.75	29.25	121	15
	98STM36243001	2718	35.75	19.75	29.25	129	18



**ORDERING NOTES:**

Modular storage units do not have finished tops and are intended to be combined with 98TP tops. Modular storage unit backs are finished.

Half Gable	98HG2710	443	10	27	27	11	1
	98HG2716	507	16	27	27	16	1

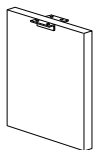

**ORDERING NOTES:**

This unit should be ordered to center-support open spans greater than 60". Use 98HG2710 with 20" & 24" deep cases and 98HG2716 with 30" deep cases.

Modular End Panel Support	98LB2030L	827	12	19.75	29.25	35	2
	98LB2430L*	869	12	23.75	29.25	37	2
	98LB2030R	827	12	19.75	29.25	35	2
	98LB2430R	869	12	23.75	29.25	37	2



Modular Hinged Modesty Panel	98MPY72	837	37.5	-	30.5	42	3
	98MPY78*	871	43.5	-	30.5	50	3
	98MPY84	898	49.5	-	30.5	60	3

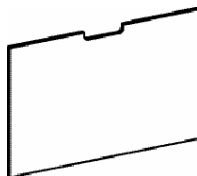

**DIMENSION KEY**

W — width  
 D — depth  
 H — height of worksurface  
 KW— kneehole width

Dimensions are in inches and approximate. Contact Customer Service if dimensions are critical.

\*See page 5 for KrugExpress program.

**CODE DESCRIPTION**

TP - modular top with standard profile  
 TPR - modular top for run-offs with one coved connecting end  
 TPI - modular top with inverted profile  
 ST - freestanding storage  
 STM - modular storage  
 WRM - modular wardrobe  
 G - includes glass doors  
 D - 2 file drawer  
 F - 2 box, 1 file drawer

**STANDARD FINISHES**

For a complete list of standard wood finishes please see page 577.

**STORAGE**

Freestanding storage has finished, profiled tops and base molding on three sides. Modular storage does not have finished tops (they must be ordered separately) and base molding is only across the front.



# STRATFORD | MODULAR COMPONENTS

## Ordering modular storage with 98TP tops

30" high modular storage units are created by combining 98TP modular tops and modular bases. The top profile on a 98TP matches that of all other 30" high Stratford products including desks and credenzas. For example:

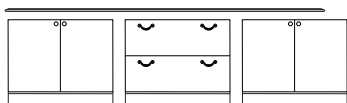

One 98TP-9224 modular top.  
Two 98STM-302430-11 modular bookcase pedestals.  
One 98STM-302430-01 modular lateral file pedestal

The modular components can be used together to create a variety of custom storage.

## Ordering modular storage with 98TPR tops

30" high modular run-off units are created by combining 98TPR modular tops and modular bases. For example:



One 98TPR-6624 modular top.  
One 98STM-302430-01 modular lateral file pedestal. One 98P-162430-4F modular B/B/F pedestal.

The modular components can be used together to create a variety of custom run-off units.

## Modular Top and Storage Flush Combinations

Use this guide of recommendations to create flush units with modular tops and storage

TOP SIZE	PEDESTAL COMBINATIONS THAT FIT FLUSH	LEFT/RIGHT OVERHANG
----------	--------------------------------------	---------------------

### 2-hi modular storage

98TP-63	(2) 30" wide pedestals	1 1/2"
98TP-69	(1) 30" wide pedestal and (1) 36" wide	1 1/2"
98TP-75	pedestal (2) 36" wide pedestals	1 1/2"
98TP-92	(3) 30" wide pedestals	1 1/2"

## ORDERING PROCEDURES

To order, please specify the following:

- 1) Krug product model number
- 2) Wood species and finish, see page 577
- 4) Pull style and finish, see page 581
- 5) Grommet location and style if applicable

\* Indicates model illustrated by line drawing

# STRATFORD | MODULAR COMPONENTS

Description	Model	Cherry Walnut	W	D	H	Shipping Weight	Cubic Feet
Top for 2-Hi Modular Bookcases	98TP7516	1193	74.75	16	1.25	55	2

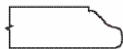

2-Hi Modular Bookcase	98BCM361630	1579	35.75	16	29.25	91	12
-----------------------	-------------	------	-------	----	-------	----	----



**ORDERING NOTES:**

Modular bookcases do not have finished tops and are intended to be combined with 98TP tops.

Ordering modular bookcases with 98TP tops  
30" high modular bookcases can be created by combining modular tops and bookcase units.

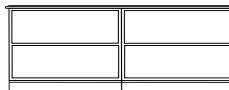

One 98TP-7516 modular top.  
Two 98BCM-3616-30 modular bookcases.

The modular components can be used together to create custom storage.

**DIMENSION KEY**

W — width  
D — depth  
H — height of worksurface  
KW— kneehole width

Dimensions are in inches and approximate.  
Contact Customer Service if dimensions are critical.

\*See page 5 for KrugExpress program.

**CODE DESCRIPTION**

G - includes glass doors  
BC - bookcase  
BCM- modular bookcase  
TPI- modular bookcase top

**STANDARD FINISHES**

For a complete list of standard wood finishes please see page 577.

# STRATFORD | MODULAR COMPONENTS

Description	Model	Cherry Walnut				Shipping Weight	Cubic Feet
			W	D	H		
 3-Hi Modular Bookcase Tops	98TPI6216-3HI	1181	59.75	15.75	1.25	43	3
	98TPI7416-3HI	1193	72.75	15.75	1.25	51	3
	98TPI9216-3HI*	1199	89.75	15.75	1.25	79	4
	98TPI9716-3HI	1210	95.75	15.75	1.25	92	4

 3-Hi Modular Bookcase Tops	98PRM301640	1746	29.5	15.75	39.25	120	22
	98PRM361640	1789	35.75	15.75	39.25	135	26

 3-Hi Modular Closed Bookcase Pier, No Base	98PRM30164011	2096	29.5	15.75	39.25	135	22
	98PRM36164011	2172	35.75	15.75	39.25	150	26

## ORDERING PROCEDURES

To order, please specify the following:

- 1) Krug product model number
- 2) Wood species and finish, see page 577
- 4) Pull style and finish, see page 581
- 5) Grommet location and style if applicable

\* Indicates model illustrated by line drawing

## CODE DESCRIPTION

0 - no pedestal  
 4 - full height pedestals  
 D - 2 file drawer  
 F - 2 box, 1 file drawer  
 L - left hand support position  
 R - right hand support position  
 CD - center drawer  
 OT - oversized top option  
 BT - bow top option  
 CC - corner credenza

## STANDARD FINISHES

For a complete list of standard wood finishes please see page 577.

## STORAGE

Freestanding storage has finished, profiled tops and base molding on three sides. Modular storage does not have finished tops (they must be ordered separately) and base molding is only across the front.

# STRATFORD | MODULAR COMPONENTS

Description	Model	Cherry Walnut	W	D	H	Shipping Weight	Cubic Feet
Top for 5-Hi Modular Bookcases	98TPI7416	1193	73.75	16	1.25	55	2



**ORDERING NOTES:**

This bookcase has a 1" overhang on the left and right sides. There is no overhang on the back edge. Profile of 98TPI tops are inverted.

5-Hi Modular Bookcase	98BCM361671	2168	35.75	16	69.75	158	27
-----------------------	-------------	------	-------	----	-------	-----	----

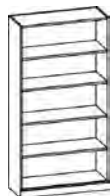

**ORDERING NOTES:**

Modular bookcases do not have finished tops and are intended to be combined with 98TP tops.

Ordering modular bookcases with 98TPI tops  
 71" high modular bookcases can be created by combining modular tops and bookcase units.

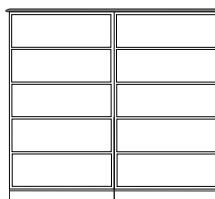
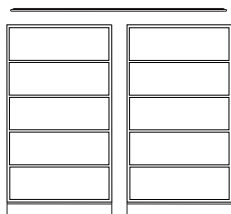

One 98TPI-7416 modular top.  
 Two 98BCM-3616-71 modular bookcases.

The modular components can be used together to create custom storage.

**DIMENSION KEY**

- W — width
- D — depth
- H — height of worksurface
- KW— kneehole width

Dimensions are in inches and approximate. Contact Customer Service if dimensions are critical.

\*See page 5 for KrugExpress program.

**CODE DESCRIPTION**

- G - includes glass doors
- BC - bookcase
- BCM- modular bookcase
- TPI- modular bookcase top

**STANDARD FINISHES**

For a complete list of standard wood finishes please see page 577.

**WIRING GROMMET**

One rectangular grommet in a standard position is optional at no charge. Additional rectangular grommets are available at an upcharge of **\$152 list**.

# STRATFORD | MODULAR COMPONENTS

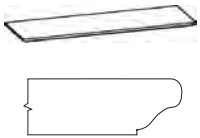
Description	Model	Cherry		W	D	H	Shipping Weight	Cubic Feet
		Walnut						
	98TPI6220	1178		61.75	19.75	1.25	45	2
	98TPI6224	1244		61.75	23.75	1.25	52	2
	98TPI6820	1305		67.75	19.75	1.25	53	3
	98TPI6824	1363		67.75	23.75	1.25	61	3
	98TPI7420*	1425		73.75	19.75	1.25	63	3
	98TPI7424	1479		73.75	23.75	1.25	65	3
	98TPI9220	1741		91.75	19.75	1.25	71	3
	98TPI9224	1789		91.75	23.75	1.25	73	3

### ORDERING NOTES:

Profile of 98TPI tops are inverted.

### Ordering modular storage with 98TPI tops

71 high modular storage units are created by combining 98TPI modular tops and modular bases.

The top profile on a 98TPI matches that of all other 71 high Stratford products including hutches and freestanding storage. For example:



One 98TPI-7424 modular top.  
One 98STM-362471-04G modular storage. One 98STM-362471-04 modular storage.

The modular components can be used together to create a variety of custom storage.

### Modular Top and Storage Flush Combinations

Use this guide of recommendations to create flush units with modular tops and storage.

TOP SIZE	PEDESTAL COMBINATIONS THAT FIT FLUSH	LEFT/RIGHT OVERHANG
5-hi modular storage		
98TPI-62	(2) 30 wide pedestals	1
98TPI-68	(2) 30 wide pedestals and (1) 36 wide pedestal	1
98TPI-74	(2) 36 wide pedestals	1
98TPI-92	(3) 30 wide pedestals	1

### Pot light option for modular storage

**Upcharge 689**

The factory installed pot light option is available on any glass door or grill door modular storage unit at an upcharge of **\$689**.

The light is mounted through the top of the storage unit and the modular top and activated by a switch located on the light inside the case.

Please add the upcharge shown to storage price and specify pot light option on your order.

A drawing showing assembled configuration of all modular storage must be provided when ordering the pot light option to accurately determine grommet locations.

### ORDERING PROCEDURES

To order, please specify the following:

- 1) Krug product model number
- 2) Wood species and finish, see page 577
- 4) Pull style and finish, see page 581
- 5) Grommet location and style if applicable

\* Indicates model illustrated by line drawing

### CODE DESCRIPTION

TP - modular top with standard profile  
TPR - modular top for run-offs with one coved connecting end  
TPI - modular top with inverted profile  
ST - freestanding storage  
STM - modular storage  
WRM - modular wardrobe  
G - includes glass doors  
D - 2 file drawer  
F - 2 box, 1 file drawer

### STANDARD FINISHES

For a complete list of standard wood finishes please see page 577.

### STORAGE

Freestanding storage has finished, profiled tops and base molding on three sides. Modular storage does not have finished tops (they must be ordered separately) and base molding is only across the front.

# STRATFORD | MODULAR COMPONENTS

Description	Model	Cherry		W	D	H	Shipping Weight	Cubic Feet
		Walnut						
2 Lateral Files, 3 Open Shelves	98STM30207103	4527		29.75	19.75	70.5	198	28
	98STM36207103	4638		35.75	19.75	70.5	208	34
	98STM30247103*	4584		29.75	23.75	70.5	208	34
	98STM36247103	4698		35.75	23.75	70.5	218	40



**ORDERING NOTES:**

Modular storage units do not have finished tops and are intended to be combined with 98TP tops. Modular storage unit backs are finished

2 Lateral File, 3 Closed Shelves	98STM30207104	5064		29.75	19.75	70.5	206	28
	98STM36207104	5181		35.75	19.75	70.5	216	34
	98STM30247104*	5117		29.75	23.75	70.5	216	34
	98STM36247104	5241		35.75	23.75	70.5	226	40



**ORDERING NOTES:**

Modular storage units do not have finished tops and are intended to be combined with 98TP tops. Modular storage unit backs are finished

2 Lateral Files, 3 Closed Clear Glass Doors	98STM30207104G	5343		29.75	19.75	70.5	216	28
	98STM36207104G	5457		35.75	19.75	70.5	226	34
	98STM30247104G*	5394		29.75	23.75	70.5	226	34
	98STM36247104G	5518		35.75	23.75	70.5	236	40

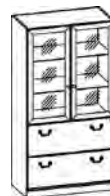

**ORDERING NOTES:**

All shelves in glass door bookcases are 1/4" thick glass. Modular pedestals do not have finished tops and are intended to be combined with 98TP tops. Modular pedestal backs are finished. This item is NOT available on KrugExpress.

**DIMENSION KEY**

W — width  
 D — depth  
 H — height of worksurface  
 KW— kneehole width

Dimensions are in inches and approximate. Contact Customer Service if dimensions are critical.

\*See page 5 for KrugExpress program.

**CODE DESCRIPTION**

TP - modular top with standard profile  
 TPR - modular top for run-offs with one coved connecting end  
 TPI - modular top with inverted profile  
 ST - freestanding storage  
 STM - modular storage  
 WRM - modular wardrobe  
 G - includes glass doors  
 D - 2 file drawer  
 F - 2 box, 1 file drawer

**STANDARD FINISHES**

For a complete list of standard wood finishes please see page 577.

**STORAGE**

Freestanding storage has finished, profiled tops and base molding on three sides. Modular storage does not have finished tops (they must be ordered separately) and base molding is only across the front.

# STRATFORD | MODULAR COMPONENTS

Description	Model	Cherry		W	D	H	Shipping Weight	Cubic Feet
		Walnut						
2 Lateral Files, 3 Closed Grill Doors	98STM30207104Z	6268		29.75	19.75	70.5	206	28
	98STM36207104Z	6385		35.75	19.75	70.5	216	34
	98STM30247104Z*	6319		29.75	23.75	70.5	216	34
	98STM36247104Z	6441		35.75	23.75	70.5	226	40

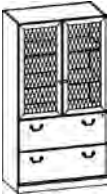

### ORDERING NOTES:

All shelves in glass door bookcases are 1/4" thick glass. Modular pedestals do not have finished tops and are intended to be combined with 98TP tops. Modular pedestal backs are finished. This item is NOT available on KrugExpress.

5 Closed Shelves	98STM30207111	4242		29.75	19.75	70.5	225	28
	98STM30247111	4224		29.75	19.75	70.5	235	34
	98STM36207111*	4287		35.75	23.75	70.5	245	34
	98STM36247111	4341		35.75	23.75	70.5	255	40



### ORDERING NOTES:

Modular storage units do not have finished tops and are intended to be combined with 98TP tops. Modular storage unit backs are finished

5 Closed Shelves Left, Closed Wardrobe Right	98WRM30247101	3931		29.75	19.75	70.5	225	34
	98WRM36247101*	4086		35.75	23.75	70.5	245	40

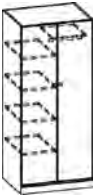

### ORDERING NOTES:

Modular storage units do not have finished tops and are intended to be combined with 98TP tops. Modular storage unit backs are finished

### ORDERING PROCEDURES

To order, please specify the following:

- 1) Krug product model number
- 2) Wood species and finish, see page 577
- 4) Pull style and finish, see page 581
- 5) Grommet location and style if applicable

\* Indicates model illustrated by line drawing

### CODE DESCRIPTION

TP - modular top with standard profile  
 TPR - modular top for run-offs with one coved connecting end  
 TPI - modular top with inverted profile  
 ST - freestanding storage  
 STM - modular storage  
 WRM - modular wardrobe  
 G - includes glass doors  
 D - 2 file drawer  
 F - 2 box, 1 file drawer

### STANDARD FINISHES

For a complete list of standard wood finishes please see page 577.

### STORAGE

Freestanding storage has finished, profiled tops and base molding on three sides. Modular storage does not have finished tops (they must be ordered separately) and base molding is only across the front.

# STRATFORD | BOOKCASES

Description	Model	Cherry Walnut	W	D	H	Shipping Weight	Cubic Feet
2-Hi Open	98BC361630	1967	35.75	16	30.5	91	12

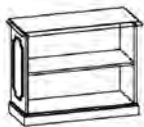

**ORDERING NOTES:**

This 30.25" high bookcase has a 1-1/2" overhang on the left and right sides. There is no overhang on the back edge.

2-Hi with Clear Glass Doors	98BC36163011G	2085	35.75	16	30.5	101	12
-----------------------------	---------------	------	-------	----	------	-----	----



**ORDERING NOTES:**

This 30.25" high bookcase has a 1-1/2" overhang on the left and right sides. There is no overhang on the back edge. The glass shelf is 1/4" thick and adjustable. This item is NOT available on KrugExpress.

Open Bookcase	98BC361657	2497	35.75	16	57	115	22
	98BC361671*	2707	35.75	16	70.5	166	27



**ORDERING NOTES:**

This bookcase has a 1" overhang on the left and right sides. There is no overhang on the back edge.

Computer Stand	98TH3624	2763	35.75	23.75	30.5	61	22
	98TH4824*	3038	47.75	23.75	30.5	82	28

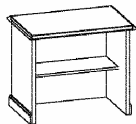

**ORDERING NOTES:**

The computer stand includes a grommet in the back panel.

**DIMENSION KEY**

- W — width
- D — depth
- H — height of worksurface
- KW— kneehole width

Dimensions are in inches and approximate. Contact Customer Service if dimensions are critical.

\*See page 5 for KrugExpress program.

**CODE DESCRIPTION**

- G - includes glass doors
- BC - bookcase
- BCM- modular bookcase
- TPI- modular bookcase top

**STANDARD FINISHES**

For a complete list of standard wood finishes please see page 577.

**WIRING GROMMET**

One rectangular black or one antique brass grommet in a standard position is optional at no charge. Please note grommet choice clearly on order form. Additional grommets are available at an upcharge of **\$152 list**.



# STRATFORD | FREESTANDING STORAGE

Description	Model	Cherry Walnut	W	D	H	Shipping Weight	Cubic Feet
2 Lateral Files	98ST30203001*	3433	29.75	19.75	30.5	140	13
	98ST36203001	3562	35.75	19.75	30.5	145	15
	98ST30243001	3476	29.75	19.75	30.5	145	15
	98ST36243001	3614	35.75	19.75	30.5	150	18



2 Closed Shelves	98ST30203011*	2625	29.75	19.75	30.5	100	13
	98ST36203011	2710	35.75	19.75	30.5	130	15
	98ST30243011	2668	29.75	19.75	30.5	130	15
	98ST36243011	2760	35.75	19.75	30.5	135	18

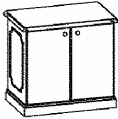

### ORDERING NOTES:

Locks may be added to bookcase or wardrobe doors at a **\$152 list** upcharge.

4 Lateral Files	98ST30205701*	4889	29.75	19.75	57	186	28
	98ST36205701	5205	35.75	19.75	57	211	34
	98ST30245701	5007	29.75	23.75	57	211	34
	98ST36245701	5318	35.75	23.75	57	236	40



2 Lateral Files, 3 Open Shelves	98ST30207103*	5204	29.75	19.75	70.5	220	28
	98ST36207103	5336	35.75	19.75	70.5	230	34
	98ST30247103	5272	29.75	23.75	70.5	230	34
	98ST36247103	5406	35.75	23.75	70.5	240	40



### ORDERING PROCEDURES

To order, please specify the following:

- 1) Krug product model number
- 2) Wood species and finish, see page 577
- 4) Pull style and finish, see page 581
- 5) Grommet location and style if applicable

\* Indicates model illustrated by line drawing

### CODE DESCRIPTION

TP - modular top with standard profile  
 TPR - modular top for run-offs with one coved connecting end  
 TPI - modular top with inverted profile  
 ST - freestanding storage  
 STM - modular storage  
 WRM - modular wardrobe  
 G - includes glass doors  
 D - 2 file drawer  
 F - 2 box, 1 file drawer

### STANDARD FINISHES

For a complete list of standard wood finishes please see page 577.

### STORAGE

Freestanding storage has finished, profiled tops and base molding on three sides. Modular storage does not have finished tops (they must be ordered separately) and base molding is only across the front.

# STRATFORD | FREESTANDING STORAGE

Description	Model	Cherry Walnut	W	D	H	Shipping Weight	Cubic Feet
2 Lateral File, 3 Closed Shelves	98ST30207104*	5827	29.75	19.75	70.5	240	28
	98ST36207104	5959	35.75	19.75	70.5	250	34
	98ST30247104	5888	29.75	23.75	70.5	250	34
	98ST36247104	6029	35.75	23.75	70.5	260	40

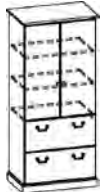

**ORDERING NOTES:**

Locks are available on all wood doors at **\$152 list per lock**. 24",30" & 36" wardrobes require 2 locks.

2 Lateral Files, 3 Closed Clear Glass Doors	98ST30207104G*	6103	29.75	19.75	70.5	250	28
	98ST36207104G	6235	35.75	19.75	70.5	260	34
	98ST30247104G	6163	29.75	23.75	70.5	260	34
	98ST36247104G	6306	35.75	23.75	70.5	270	40



**ORDERING NOTES:**

All shelves in glass door bookcases are 1/4" thick glass. This item is NOT available on KrugExpress.

2 Lateral Files, 3 Closed Grill Doors	98ST30207104Z*	6750	29.75	19.75	70.5	240	28
	98ST36207104Z	6884	35.75	19.75	70.5	250	34
	98ST30247104Z	6809	29.75	23.75	70.5	250	34
	98ST36247104Z	6953	35.75	23.75	70.5	260	40

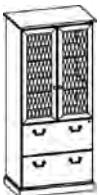

**ORDERING NOTES:**

All shelves in glass door bookcases are 1/4" thick glass. This item is NOT available on KrugExpress.

**DIMENSION KEY**

W — width  
 D — depth  
 H — height of worksurface  
 KW— kneehole width

Dimensions are in inches and approximate. Contact Customer Service if dimensions are critical.

\*See page 5 for KrugExpress program.

**CODE DESCRIPTION**

TP - modular top with standard profile  
 TPR - modular top for run-offs with one coved connecting end  
 TPI - modular top with inverted profile  
 ST - freestanding storage  
 STM - modular storage  
 WRM - modular wardrobe  
 G - includes glass doors  
 D - 2 file drawer  
 F - 2 box, 1 file drawer



**STANDARD FINISHES**

For a complete list of standard wood finishes please see page 577.

**STORAGE**

Freestanding storage has finished, profiled tops and base molding on three sides. Modular storage does not have finished tops (they must be ordered separately) and base molding is only across the front.

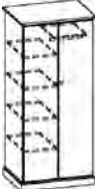
# STRATFORD | FREESTANDING STORAGE

Description	Model	Cherry Walnut	W	D	H	Shipping Weight	Cubic Feet
 5 Closed Shelves	98ST30207111	4796	29.75	19.75	70.5	230	28
	98ST36207111	4929	35.75	19.75	70.5	240	34
	98ST30247111*	4860	29.75	23.75	70.5	240	34
	98ST36247111	4993	35.75	23.75	70.5	250	40
 5 Closed Shelves, Closed Wardrobe	98WR30247101*	4515	29.75	23.75	70.5	245	34
	98WR36247101	4698	35.75	23.75	70.5	265	40
	98WR30247103	4515					
	98WR36247103	4698					
 2 Lateral Files, 4 Open Shelves	98ST30208403	5959	29.75	19.75	83.5	260	33
	98ST36208403	6017	35.75	19.75	83.5	270	40
	98ST30248403*	6044	29.75	23.75	83.5	270	40
	98ST36248403	6108	35.75	23.75	83.5	290	47
 2 Lateral File, 4 Closed Shelves	98ST30208404	6183	29.75	19.75	83.5	285	33
	98ST36208404	6237	35.75	19.75	83.5	295	40
	98ST30248404*	6268	29.75	23.75	83.5	295	40
	98ST36248404	6337	35.75	23.75	83.5	315	47

### ORDERING NOTES:

Locks are available on all wood doors at **\$152 list** per lock. 24", 30" & 36" wardrobes require 2 locks.

### ORDERING PROCEDURES

To order, please specify the following:

- 1) Krug product model number
- 2) Wood species and finish, see page 577
- 4) Pull style and finish, see page 581
- 5) Grommet location and style if applicable

\* Indicates model illustrated by line drawing

### CODE DESCRIPTION

TP - modular top with standard profile  
 TPR - modular top for run-offs with one coved connecting end  
 TPI - modular top with inverted profile  
 ST - freestanding storage  
 STM - modular storage  
 WRM - modular wardrobe  
 G - includes glass doors  
 D - 2 file drawer  
 F - 2 box, 1 file drawer

### STANDARD FINISHES

For a complete list of standard wood finishes please see page 577.

### STORAGE

Freestanding storage has finished, profiled tops and base molding on three sides. Modular storage does not have finished tops (they must be ordered separately) and base molding is only across the front.

# STRATFORD | FREESTANDING STORAGE

Description	Model	Cherry Walnut	W	D	H	Shipping Weight	Cubic Feet
2 Lateral Files, 4 Closed Clear Glass Doors 	98ST30208404G	6463	29.75	19.75	83.5	295	33
	98ST36208404G	6519	35.75	19.75	83.5	205	40
	98ST30248404G*	6542	29.75	23.75	83.5	205	40
	98ST36248404G	6612	35.75	23.75	83.5	325	47

**ORDERING NOTES:**

All shelves in glass door bookcases are 1/4" thick glass. This item is NOT available on KrugExpress.

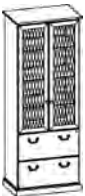
2 Lateral Files, 4 Closed Grill Doors 	98ST30208404Z	7107	29.75	19.75	83.5	285	33
	98ST36208404Z	7162	35.75	19.75	83.5	295	40
	98ST30248404Z*	7191	29.75	23.75	83.5	295	40
	98ST36248404Z	7260	35.75	23.75	83.5	315	47

**ORDERING NOTES:**

All shelves in glass door bookcases are 1/4" thick glass. This item is NOT available on KrugExpress.

6 Closed Shelves 	98ST30208411	867	29.75	19.75	83.5	250	33
	98ST36208411	5424	35.75	19.75	83.5	260	40
	98ST30248411*	5347	29.75	23.75	83.5	260	40
	98ST36248411	5493	35.75	23.75	83.5	270	47

**ORDERING NOTES:**

Locks are available on all wood doors at **\$152 list** per lock. 24", 30" & 36" wardrobes require 2 locks.

Mobile Pedestals  *	98MP1620294D*	2113	15.75	20	29	78	6
	98MP1620294F**	2244	15.75	20	29	80	6



**DIMENSION KEY**

W – width  
 D – depth  
 H – height of worksurface  
 KW – kneehole width

Dimensions are in inches and approximate. Contact Customer Service if dimensions are critical.

\*See page 5 for KrugExpress program.

**CODE DESCRIPTION**

TP - modular top with standard profile  
 TPR - modular top for run-offs with one coved connecting end  
 TPI - modular top with inverted profile  
 ST - freestanding storage  
 STM - modular storage  
 WRM - modular wardrobe  
 G - includes glass doors  
 D - 2 file drawer  
 F - 2 box, 1 file drawer

**STANDARD FINISHES**

For a complete list of standard wood finishes please see page 577.

**STORAGE**

Freestanding storage has finished, profiled tops and base molding on three sides. Modular storage does not have finished tops (they must be ordered separately) and base molding is only across the front.

# STRATFORD | RECEPTION

Description	Model	Cherry Walnut				Shipping Weight	Cubic Feet
			W	D	H		
Gallery Reception Desk	98GD72304LFR0	6886	73.5	30.5	43	325	66
	98GD72304LORF	6886	73.5	30.5	43	325	66

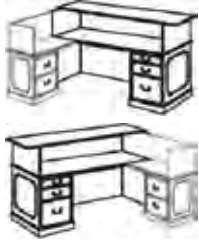

**ORDERING NOTES:**

Laminate worksurfaces are available at a 10% upcharge. 30" deep Stratford desks have a 1-1/2" overhang on the guest side. 36" deep Stratford desks have a 7 1/2" overhang on the guest side. See page 578 for more information on the desks overhang and chassis dimensions. A burled walnut top option is available at a 20% upcharge.

Reception Return	98GRH4824L4D	3555	47.75	23.75	41.75	28.5	250	38
	98GRH4824R4D	3555	47.75	23.75	41.75	28.5	250	38

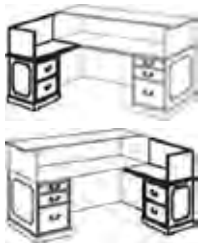

**ORDERING NOTES:**

Laminate worksurfaces are available at a 10% upcharge. 30" deep Stratford desks have a 1-1/2" overhang on the guest side. 36" deep Stratford desks have a 7 1/2" overhang on the guest side. See page 578 for more information on the desks overhang and chassis dimensions. A burled walnut top option is available at a 20% upcharge.

Gallery Reception Linking Units	98GLU4224H	1915	41.75	23.75	41.75		105	34
---------------------------------	------------	------	-------	-------	-------	--	-----	----



**ORDERING NOTES:**

Linking unit is used to connect Gallery Desk and Credenza to form a 'U' station.

Reception Credenzas	98GC7224L4D	5870	71.75	23.75	41.75		320	57
	98GC7224L4F	5870	71.75	23.75	41.75		320	57
	98GC7224R4D	5870	71.75	23.75	41.75		320	57
	98GC7224R4F	5870	71.75	23.75	41.75		320	57
	98GC7824L4D	6498	77.75	23.75	41.75		355	60
	98GC7824L4F*	6498	77.75	23.75	41.75		355	60
	98GC7824R4D	6498	77.75	23.75	41.75		355	60
	98GC7824R4F	6498	77.75	23.75	41.75		355	60

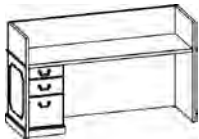

Transaction Top	98GRT66	1357	66.75	12	1.25		48	2
-----------------	---------	------	-------	----	------	--	----	---



**ORDERING NOTES**

Laminate worksurfaces are available at a 10% upcharge. 30" deep Stratford desks have a 1-1/2" overhang on the guest side. 36" deep Stratford desks have a 7 1/2" overhang on the guest side. See page 578 for more information on the desks overhang and chassis dimensions. A burled walnut top option is available at a 20% upcharge.

**ORDERING PROCEDURES**

To order, please specify the following:

- 1) Krug product model number
- 2) Wood species and finish, see page 577
- 4) Pull style and finish, see page 581
- 5) Grommet location and style if applicable

\* Indicates model illustrated by line drawing

**CODE DESCRIPTION**

- 0 - no pedestal
- 4 - full height pedestals
- D - 2 file drawer
- F - 2 box, 1 file drawer
- L - left hand support position
- R - right hand support position
- CD - center drawer
- OT - oversized top option
- BT - bow top option
- CC - corner credenza

**STANDARD FINISHES**

For a complete list of standard wood finishes please see page 577.

**WIRING GROMMET**

One rectangular black or one antique brass grommet in a standard position is optional at no charge. Please note grommet choice clearly on order form. Additional grommets are available at an upcharge of **\$152 list**.

## GENERAL INFORMATION

### Terms and Conditions

Net 30 days on approved credit. A late payment charge of 1% per month will be applied on overdue invoices. This charge will be pro-rated to the number of days past 30 days that the invoice is overdue. All applicable sales taxes are extra. Distribution of this price list does not in itself constitute an offer to sell. Orders can be received only from authorized Krug dealers. Acceptance of any order and terms of sale may be established at the discretion of Krug. Deposits are required on orders received from new accounts as well as on large or special orders. Krug reserves the right to discontinue designs, or to change designs, construction, prices, or materials without notice.

### Contact Information

Phone: 1.888.578.KRUG (5784) | Fax: 1.519.748.5177  
 Purchase Order Fax: 1.888.236.4783  
 Purchase Order E-mail: orders@krug.ca  
 Web: www.krug.ca E-mail: solutions@krug.ca

### Customer Service Hours

Please note customer service hours are:  
 8:30 am to 5:00 pm est

### Customer Satisfaction

It is the primary goal of Krug and our staff to ensure the complete satisfaction of our customers with our products and performance. If a problem arises with a Krug product after the expiration of the limited warranty period, Krug will exercise its best efforts to achieve the satisfaction of the customer in a manner that is fair to all concerned.

### Order Acknowledgments

Each order will be acknowledged via e-mail or fax. This acknowledgment is the final agreement between Krug and the customer, superseding all previous communications regarding the purchase order. Where there is a discrepancy on a purchase order between a product code and a description, Krug will make every effort to resolve the discrepancy, but will be ruled by the product code ordered. Please check all acknowledgments for accuracy, and advise Krug of any discrepancies with a purchase order.

### Order Cancellation

Krug reserves the right to not accept or allow cancellation of orders. All products are manufactured on a custom-made, make-to-order basis, and the purchasing, engineering and production of orders begins shortly after order placement - and the customer purchase order is a contract that authorizes Krug to manufacture the products. Acceptance of order cancellation (or partial cancellation) is solely at the discretion of Krug, and is dependent on the extent to which engineering, purchasing and manufacturing has been initiated by the time cancellation is requested. No order cancellations (partial or otherwise) are allowable more than 4 weeks from date of order placement (as order production is unable to be terminated by that point), and full payment of the acknowledged order value is required for any orders cancelled after 4 weeks. Cancellations may be allowable in less than 4 weeks after order placement, depending on the extent to which manufacturing has been initiated. An acceptance of order cancellation requires that the purchaser agrees to make payment for all costs incurred to the point of acceptance of cancellation. Cancellation charges include all costs for purchase of dedicated material and components, engineering costs for non-standard products, and all costs for manufacturing completed to that point, as well as a \$350 net charge for processing of the original order and for processing of cancellation invoicing.

### Pricing

Krug endeavors to ensure that all prices in this price list reflect accurately our current prices. However, errors do occur and will be rectified through notices to the field. Krug reserves the right to acknowledge pricing that may be different from the price list.

### Warranty

Krug warrants the construction and the finish of all our products to be free from defects in materials and workmanship for a period of 10 years from the date of purchase. This warranty is applicable to products in use by their original purchaser. This warranty does not apply to components not manufactured by Krug including textiles, which are subject to the specific warranties of those manufacturers,

if any. Textiles (fabric, leather, vinyl, or any other covering material) suppliers do not guarantee their products for durability and color fastness, and nor does Krug. Casters, mechanical and electrical components have a warranty of five years from the date of purchase. The Krug warranty does not apply to COM-specified materials, damage caused by a carrier other than Krug, or variation in wood finishes due to natural wood color variation. Krug cannot be held responsible for variations in fabric dye lots from order to order. All fabric is carefully inspected when it is received, but a degree of variation in color should be expected. Repairs or replacement of any defect covered under this warranty by Krug will be made, at our option and method, at no charge to the original purchaser during the warranty period. Krug's judgement is final and binding with respect to the nature or cause of defects or damage, and the necessity or manner of repair or replacement.

This warranty does not apply to defects or damage resulting from:

- normal wear and tear occurring with the use of the product
- negligence, misuse, excessive use, alteration, improper cleaning or repair
- substitution or use of incorrect or unauthorized components or material
- handling or installation that is incorrect, or that causes damage or defect
- damage incurred by a freight carrier other than Krug
- wearing of finishes and fabrics, and normal variations in material (including dye lot variations)
- properties of natural materials, including wood and leather
- exposure to environments with uncontrolled temperature and humidity (products must be transported, stored and used in climate-controlled conditions)

Note, specific warranties for components and materials not manufactured by Krug:

### Height Adjustable Mechanism Warranty

Krug warrants to the original consumer purchaser its Height Adjustable Mechanism that it will be free from defects in material and workmanship. This limited warranty covers material and manufacturing defects, which cause a non-conformance in the function of a table base and is limited to the following products and warranty term determined from their dates of purchase:

- a) Electronic components such as control boxes, hand switches and motors – two (2) years
- b) Mechanical components such as crank drives, spindles – five (5) years
- c) Structural components such as J-channels, feet and top supports – ten (10) years

The start of the warranty period is the documented date of your purchase of the product. The warranty herein is made to and for the benefit of the original consumer purchaser of the product and is non-transferable. If you discover a defect in material or workmanship during the warranty period, and Krug agrees that the defect exists, Krug will, at its option, repair or replace the Product at no charge to you, provided it is returned during the warranty period. In the unlikely event that your product should require repair or replacement during the warranty period, please contact Krug to obtain warranty service. The warranty period on replacement products is the remainder of the warranty on the original product or 30 days, whichever is longer.

### Testing

All Krug Conference products meet or exceed the testing requirements of ANSI/BIFMA X5.5-2014 or X5.9-2012.



### Dimensions

Dimensions are in inches and approximate, and subject to change without notice. Contact Customer Service if dimensions are critical.

### Installation Support

For assistance please contact Technical Support at 1-888-578-5784 x216 or e-mail installationhelp@krug.ca and you will be directed to the appropriate installation support person.

## Storage Charges

Krug reserves the right to assess a nominal storage charge if a customer does not accept shipment of an order within a week of the ship date.

## Export Packaging

Krug is pleased to provide the option for export packaging on all our products, to provide additional protection from damage. For shipments overseas, a quote for export packaging can be provided, based on the products to be ordered and the delivery destination - please contact Customer Service or Bids & Specification Support for more information and a quotation. KRUG is not responsible for shipment damage occurring on overseas shipments

Export Packaging is **STRONGLY RECOMMENDED** for:

- (A) all shipments outside of the lower 48 states and Canada
  - (B) all shipments that will be held in storage for an extended period prior to installation. Important: Please note that Krug will not be responsible for damage claims on product shipped or stored in the above conditions where export packaging has not been utilized.
- Please contact Customer Service for specifications or any other assistance regarding export packaging.

## Freight Terms and Conditions

1. All product is shipped FOB the Krug factory. Freight is either pre-paid to the destination or not pre-paid, depending on established customer specific freight terms.
2. Docks at the selected delivery location must be equipped to handle a 53' trailer. If a dock is inadequate for delivery by Krug, Krug will re-deliver to another local location and any additional costs will be charged to the customer.
3. For all deliveries, it is understood that Krug or its agent is making a dock delivery only (equipped to handle a 53' trailer), and any further work of truck unloading, delivery beyond the dock, installation, and removal of packaging is not authorized or paid for by Krug.
4. Drop shipments to the installation site, and timed deliveries, are available on larger shipments (full truckloads or slightly less) at no additional charge. Drop shipments or timed deliveries for smaller shipments may not be available, or if available will require a surcharge. Deliveries on an after hours basis, or on weekends, or any other special requirements, may be subject to a surcharge. Location and contact information, and the requested time of delivery, is required at least one week prior to the acknowledged shipment date. If this information is not provided one week in advance, or if the location or time of the drop shipment is changed less than one week in advance, a surcharge may be applied, and/or the drop shipment may not be scheduled.
5. For all deliveries - whether to the Customer location or drop shipment - any circumstances that result in the delay of our carrier (including unsuitable receiving facilities, or facilities not open or available), service charges will be applied at the rate of \$125/hour. Where re-delivery is necessary because of these circumstances, the full cost of re-delivery will be charged. If Less Than Truck Load is delivering, one hour is allocated to unload. Any additional time required to unload after the first hour is \$125/hour. If a Truck Load is delivering the order, three hours is allocated to unload. Any additional time required to unload is \$125/hour. Direct deliveries to site for net orders are possible, must exceed \$60,000 net, and accommodate 48-53' trailers. Krug is responsible for delivery to the approved delivery address. If an address change is required, this must be authorized by Krug 5 business days prior to ship date. Any additional delivery costs incurred after this time will be charged to the customer. Additional costs for partial shipment of orders are the responsibility of the customer, and will be added to invoices. This includes any part shipment costs due to delays from textile suppliers. Additional costs for partial order shipments will normally not be assessed if there is a delay caused by Krug.

## Damaged Shipments

All Krug product is well engineered, carefully inspected, and expertly loaded onto our trucks at our Distribution Center. If you receive any damaged freight, we ask that you do not refuse the shipment. Krug is not responsible for damage to goods that occurs in transit or storage. It is the purchaser and/or receiver's responsibility to examine the goods upon receipt and to notify Krug of any damages, overages or shortages. Any discrepancies should be noted on the Bill of Lading. The delivering carrier will not accept responsibility for shortages or damages if signed "clear". Notification of concealed damage claims must be made to Krug Distribution within 5 days of delivery, along with digital pictures if available. All product and

packaging must be available for inspection. Krug liability ceases after 5 business days and Krug will not be responsible for concealed damages if shipments are left unopened. Krug is not responsible for the condition of product that is stored or installed in an environment where temperature and humidity are not controlled.

## Field Product Report Authorization

Krug's written authorization, in the form of an FPR number, must be obtained prior to incurring charges of any kind if Krug is expected to pay these charges. This includes authorization for returns, field repairs and replacements, post field repairs, installation and delivery charges. Krug reserves the right to have its representative inspect product related to any request for such authorizations, prior to that authorization being provided. Deductions from invoices paid for any charges to Krug, without prior written authorization in the form of an FPR, will not be accepted. Digital photographs may be required to complete the FPR process.

## Care and Maintenance

**Wood Finishes** - Although Krug's extensive finishing process ensures a durable finish on all our products, there are several steps that can be taken to protect and prolong the life and beauty of the finish. Protect the top by placing felt pads on the bottom of any accessories and mechanical equipment. Rubber and oil will permanently mark surfaces. Use a desk pad to prevent possible damage and imprinting caused by writing instruments and sharp objects. Dust only with a clean, dry cloth, going with the grain. Clean any marks with a damp cloth, using a small quantity of mild soap or detergent. Do not use any wax-based polish, spray or silicone. Eventually, a film will build up and discolor the top. Do not place your furniture in a position of permanent exposure to direct sunlight.

**Plastic Laminates** - Clean plastic laminates with mild soap and warm water. Do not use steel wool, hot water, or any abrasive cleaning product.

## Custom Capabilities

Over 15% of our orders involve some type of custom work, and we invite our customers to make use of our extensive capabilities. These include:

- 1) Dimensional customization of standard size products
  - 2) Custom wood finishes
  - 3) For larger orders, completely custom-designed products, as well as non-standard wood species can be specified.
- Custom orders may require additional production lead times. Contact Customer Service for more information.

## Krug Panel Fabric Program

Tackboards can be upholstered in COM material supplied by the customer, and in a selection of stocked tackboard fabrics supplied by Momentum. The Momentum Panel fabrics are available on Krug Express. They are 100% polyester. For additional information and color selections, please refer to our Panel Fabrics card and Krug's website. [www.krug.ca](http://www.krug.ca) The Momentum panel fabrics pass ASTM-E84-87 Fire Codes. If memo samples are required please call Momentum at 1-800-366-6839.

## Program Details

*KrugExpress* orders are ready to ship by the date acknowledged. Delivery and shipping schedules may result in actual shipping of orders at a later date. Statutory holidays and scheduled factory vacations may add to acknowledged lead times of *KrugExpress* orders. Unless otherwise specified on the order, the customer's standard method of shipping Krug products will be utilized. Available factory capacity for *KrugExpress* is filled by orders received on a "first come, first serve" basis. If the normal *KrugExpress* lead time is not available for your order because available capacity has been filled, you will be immediately advised of the earliest available ready-to-ship date. Please consult your Customer Service representative in advance if you wish to confirm the specific lead time availability for a *KrugExpress* order. Orders must be received by midnight of a given day for that day to be considered the official day the order is received. Order lead times are acknowledged from the date the order is received, but not including the date the order is received. *KrugExpress* orders must be "clean" when received in order to be considered officially received on a given day, and lead times will be acknowledged from the date orders are determined to be "clean". Changes to *KrugExpress* orders are not allowed under any circumstances. Orders for product on *KrugExpress* must clearly state: "*KrugExpress*".



**Krug Textiles - Leather Program**

**Grade 8**

Black	K13.1000	Graphite	K13.4000
Stone	K13.3000	Espresso	K13.8000
Sand	K13.5000	White	K13.9000

Please contact Customer Service for specific information on leathers, available colors and lead times.

**Krug Textiles - Faux Leather Program**

**Grade 2**

White	Taupe	Bisque	Wine	Sprig	Lagoon
Cream	Mocha	Chocolate	Garnet	Chinchilla	Pacific Blue
Parchment	Tan	Black	Rust	Steel	Navy
Sandstone	Chestnut	Earth	Citron	Grey	Plum
Vanilla		Brick			

**GRADED-IN UPHOLSTERY PROGRAMS**

Krug has partnered with several textile brands to grade in their offerings, designed to provide a wide range of upholstery selections for our seating products.

Upholstery pricing and availability is subject to change without notice. We grade this upholstery according to the pricing of the fabric suppliers - when their pricing changes, the Krug grade may change. When placing an order, a Krug customer must specify the complete upholstery number, along with the appropriate Krug model number and finish. Krug will supply the complete product at the prices listed. Orders specifying graded-in upholstery cannot be cancelled once the upholstery has been ordered.

**Upholstery Grades**

To determine the price of a product for graded-in upholstery, use the reference lists located on Krug’s website under - Products - Textiles, to view the upholstery grade (1-9). Krug is not responsible for the discontinuation of this upholstery. Please contact Customer Service for information on upholstery not listed.

When two upholstery selections are specified for use on seating, the higher grade upholstery price will apply to the order.

High Performance upholstery; Polyurethane, Vinyl or Crypton, is particularly suitable for healthcare and other intensive-use environments.

**Upholstery Samples**

If you require additional samples or memos for presentation, please contact fabric supplier directly.

**Flammability Standards**

- Tunnel Test Surface Ratings Class A rating
- Class 1 UFAC
- Passes State of California Technical Bulletin CAL 117-2013

Please contact fabric supplier directly for further flammability information pertaining to specific upholstery.

**Special Conditions**

Acknowledgements will give the estimated delivery date of the finished product. Some upholstery is imported, and availability may affect estimated delivery time. For large projects, please contact fabric supplier directly for availability of yardage.

**TACKBOARD FABRICS**

**KRUG PANEL FABRIC PROGRAM**

Tackboards can be upholstered in COM material supplied by the customer, and in a selection of stocked tackboard fabrics supplied by Momentum. The in-stock Momentum fabrics are priced at Grade 1 and are available on Krug Express. They are 100% polyester. For additional information and color selections, please refer to our Panel Fabrics card and Krug’s website. www.krug.ca If memo samples are required please call Momentum at 1-800-366-6839. The Momentum panel fabrics pass ASTM-E84-87 Fire Codes.

**PROGRAM DETAILS**

KrugExpress orders are ready to ship by the date acknowledged. Delivery and shipping schedules may result in actual shipping of orders at a later date. Statutory holidays and scheduled factory vacations may add to acknowledged lead times of KrugExpress orders. Unless otherwise specified on the order, the customer’s standard method of shipping Krug products will be utilized. Available factory capacity for KrugExpress is filled by orders received on a “first come, first serve” basis. If the normal KrugExpress lead time is not available for your order because available capacity has been filled, you will be immediately advised of the earliest available ready-to-ship date. Please consult your Customer Service representative in advance if you wish to confirm the specific lead time availability for a KrugExpress order. Orders must be received by midnight of a given day for that day to be considered the official day the order is received. Order lead times are acknowledged from the date the order is received, but not including the date the order is received. KrugExpress orders must be “clean” when received in order to be considered officially received on a given day, and lead times will be acknowledged from the date orders are determined to be “clean”. Changes to KrugExpress orders are not allowed under any

**KRUGEXPRESS**

circumstances. Orders for product on KrugExpress must clearly state: “KrugExpress”. \*Some conditions apply. Please note PALETTE finishes are not available on KrugExpress.

**CASEGOODS PROGRAM**

Orders for casegood products on the KrugExpress program may be subject to quantity maximums. Please contact Krug Customer Service for more information. Quantity maximums are dependent upon available capacity, in order to insure that we ship all orders on time. Only actual casegood pieces and conference tables tops and bases are considered “units”. Items such as tasklights, tackboards, keyboard trays and drawers, electrical and wire management components, etc., are not considered under the quantity restrictions. For example, a typical office configuration that includes a desk, linking unit, credenza and hutch/overhead, equals a total of four units for the purposes of the quantity maximum. Only Krug In-stock panel fabric is available on the KrugExpress program. Only standard wood finishes are available for KrugExpress orders. Grommets can be specified in standard positions only. KrugExpress also includes all Krug seating and occasional tables as well as Krug conference products to complement this casegoods offering.

CASEGOODS | GSA | 629



# CUSTOMER’S OWN MATERIAL - C.O.M.

## Customer’s Own Material (COM)

**COM must be received three weeks prior to the acknowledged ship date. Orders with COM not received by the required deadline will be delayed.**

A description of the fabric, including supplier name, fabric name and color number must be included with the purchase order. When the COM fabric is received at Krug, it must be clearly identified with the fabric name and color, and tagged with name of the Krug customer and purchase order number. Krug will inspect all COM fabric when received to determine if it will be suitable for upholstery. Where Krug feels that the fabric or leather specified will compromise the quality or integrity of our products, customers will be contacted to direct these concerns. Further, Krug reserves the right to refuse to accept and use any COM fabrics or leathers that will compromise our products in any way that is unacceptable to Krug. Krug cannot assume responsibility for the durability or tailoring quality of customer’s own material.

Yardage specified in this price guide is approximate. In the case of multiple product orders, multiply the number of items by the COM yardage specified to determine fabric required, unless otherwise indicated. Additional yardage may be needed if the material is less than 54” wide, or patterned or striped and requires matching. As fabric is applied horizontally, non-directional fabrics are recommended. COM fabrics are applied as they come off the roll unless otherwise specified. All striped fabrics will be applied vertically unless otherwise stated by the customer and after approval by Krug. It is the customer’s responsibility to advise Krug if the upholstery is to be applied otherwise, and to advise Krug of any special upholstery instructions. Special instructions should be sent to Krug Customer Service, including a sample (or photocopy) of the fabric. Krug is not responsible for instructions sent with the fabric rolls, or for the method of upholstery if no instructions have been provided. COM fabrics for tackboards may be specified in either Maharam or Momentum panel fabrics. Krug is not responsible for determining if a fabric is not ideal for tackboard application.

Please contact Maharam at 1-800-645-3943 or Momentum at

## COM Shipping Procedures

**For tackboard COM fabrics, please send fabrics to:**

**Krug Inc.**

**111 Ahrens Street**

**Kitchener, Ontario**

**Canada N2H 4C2**

**Attention: RECEIVER**

All packages must be clearly marked “For Customs Clearance by Willson International Custom Brokers”. According to the North American Free Trade Agreement (NAFTA), goods shipped between the United States and Canada can qualify for exemption from all duties, or for a reduction in duties, if the goods can be proven to originate in either the United States, Canada or Mexico.

Canada Customs requires that a NAFTA Certificate of Origin and Commercial Invoice be completed and sent with the fabric shipment. The Commercial Invoice must clearly state the description of the fabric, the selling price, the make-up or content, and the purchaser. The absence of these two documents will delay the shipments at the U.S./Canada border, thereby potentially delaying the customer order. If the total value of the shipment is less than \$1200 U.S., Customs will accept a Low Value Statement of Origin in place of the NAFTA Certificate of Origin. The Low Value Statement must be signed by a representative of the exporting company. This statement may either be included on the commercial invoice or attached to the invoice.

Krug is happy to answer any questions or concerns about COM shipping procedures and the required documents. Please contact our Customs Specialist at 1.888.578.5784.

# LAMINATES

## LAMINATES

Krug’s in-stock Laminates are available in 17 different laminate selections. Please note that 4 of the colors (Gingerbread, Portobello, Ash and Willow) have textured finishes and may not be appropriate for use in patient areas due to infection control concerns. Minimum order quantities and extended lead times may apply for exotic laminate colors, please check with customer service. Polymer Edge will be selected to match the worksurface. Krug’s previous laminate in-stock program will be phased out as in-stock supply depletes. Please contact customer service for availability.

## IN-STOCK LAMINATES

Wood Grain Laminates	High Pressure Laminate Supplier	Textured Wood Grain Laminates	High Pressure Laminate Supplier
Champagne	Tafisa T492CR	Gingerbread	Tafisa T556UR
Hardrock Maple	Formica 86992-58	Portobello	Tafisa T557UR
Dune	Tafisa T491CR	Ash	Tafisa T535AT
Copper	Tafisa T521CR	Willow	Tafisa T543AT
Shiraz Cherry	Tafisa T472CR	<b>Solid Laminates</b>	
Park Avenue Walnut	Wilsonart 7984-38	Designer White	Wilsonart D354-60
Chocolate	Tafisa T498CR	Platinum	Tafisa T202CR
Nutmeg	Tafisa T477CR	Earth	Tafisa T767CR
Dark Walnut	Tafisa T469CR	Charcoal	Tafisa T228CR

## PHASE OUT LAMINATES

Almond - Black- Shadows - Edgewood Sycamore - Gunstock Walnut

Non-Stocked Laminates

For specific lead time and application questions, please contact Krug Customer Service for your requirement. Upcharges will be applicable for non-stocked laminates, depending on their cost. Non-stock laminates may require a minimum order quantity, please contact customer service. Stocked polymer edges only can be specified for use with non-stocked laminates or tops will be self-edged.



The mark of responsible forestry

All products are air emissions certified and are available as FSC® certified

# krug