

CONFERENCE
Price and Specification Guide
CANADA



krug

Advancing Design Through Innovation

TABLE OF CONTENTS

PRICING & SPECIFICATIONS

2	Nuvo
84	V2
119	Ando
127	Revo
162	Chit Chat
170	Millennium
196	Stratford
220	Virtu

General Information

349	Terms & Conditions
349	Warranty
350	<i>KrugExpress</i> Program
351	Wood Finishes
351	Laminate Program
352	Solid Surface

NUVO | TABLE OF CONTENTS

NUVO

3	Nuvo Environmental Summary
4	Features & Options
6	Power Management
8	Sample Configurations
9	Rectangular Wood Tops
10	Arc End Wood Conference Tops
11	Racetrack Wood Conference Tops
12	Boat Shaped & Visio Wood Conference Tops
13	Oval, Arced Square & Round Wood Conference Tops
14	Console Planning For Wood Tops
15	Console Size & Location For Wood Tops
25	Console Size & Location For Laminate Tops
35	Consoles for Wood & Laminate Tops
36	Back-Painted Glass Rectangular Conference Tops
37	Back-Painted Glass Arc End Conference Tops
38	Back-Painted Glass Boat Shaped & Visio Conference Tops
39	Back-Painted Glass Oval, Arced Square & Round Conference Tops
40	Console Planning for Back-Painted Glass Tops
41	Console Size & Location For Back-Painted Glass Tops
48	Consoles for Back-Painted Glass Tops & Console Power/Data Modules
49	Standard Console Power/Data Media Modules
53	Console Power Modules for Custom Configurations
54	Console Data/Media Options
59	Bases
60	Base Requirements Chart

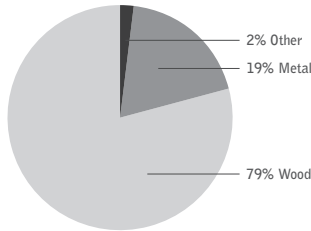
MEDIA AND STORAGE

68	LEED Credit Summary, Substantiality & Environmental
69	Features & Options
72	Credenzas
76	Buffets
82	Hospitality Carts
83	Lecterns & Media

LEED CERTIFICATION



MATERIAL CONTENT:

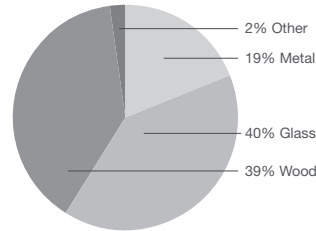


PRE-CONSUMER RECYCLED CONTENT - 82%

POST-CONSUMER RECYCLED CONTENT - 2.5%



MATERIAL CONTENT:



PRE-CONSUMER RECYCLED CONTENT - 72%

POST-CONSUMER RECYCLED CONTENT - 2.5%

		CONTRIBUTES TO
Credit 2.1 - 2.2	Construction Waste Management	1-2 point(s)
Credit 4.1	Recycled Content	1 point
Credit 4.2	Recycled Content	1 point
Credit 4.5	Low Emitting Materials, (MUST BE REQUESTED)	
	Composite Wood & Laminate Adhesives	1 point
Credit 5.1	Regional Materials*	1 point
Credit 6	Rapidly Renewable Materials (MUST BE REQUESTED)	1 point
Credit 7	Certified Wood (MUST BE REQUESTED)	1 point

*This credit is only applicable if in total 20% of the combined value of the procurement of construction materials and in the furniture are manufactured within a radius of 500 miles. This credit will apply if the installation of the finished product occurs within 500 miles of Kitchener, Ontario.



level® CERTIFICATION

BIFMA's e3 Furniture Sustainability Standard is a voluntary, multi-attribute standard that measures the degree of sustainability of furniture. This standard evaluates product and company environmental attributes and compliance systems in a wide range of elements which include Materials, Energy & Atmosphere, Human & Ecosystem Health and Social Responsibility. Nuvo products have earned level®, BIFMA's sustainability certification program for furniture, certification through third-party verification against the e3 standard. All Nuvo products can be supplied with level® certification. In order to accomplish this, the product must also be ordered with the air-emissions-certification option. Contact customer service for information and upcharges.



the mark of responsible forest®

AIR-EMISSIONS

All Nuvo products can be supplied with air-emissions-certified materials. Contact customer service for information and upcharges.

FSC®

FSC® In 2005, Krug received Forest Stewardship Council® (FSC®) Chain-of-Custody certification for our manufacturing facilities. The FSC® Chain-of-Custody tracks certified wood from seedling to final sale. It verifies that the material for our FSC® certified products only come from well-managed, FSC®-certified forests and other controlled sources. FSC® is dedicated to the promotion of responsible forest management worldwide helping to take care of forests for future generations. Nuvo and other Krug products can be specified with FSC® Certification. Contact customer service for further information, pricing and lead times..

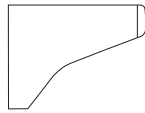


In addition, architects, designers, and building professionals can specify FSC®-certified products in order to achieve a point from the US. Green Building Council's Leadership in Energy and Environmental Design (LEED) Rating System.

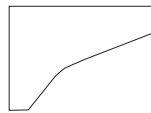
NUVO | FEATURES & OPTIONS

TOPS

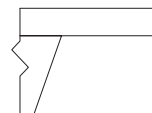
Nuvo Conference products offers 8 table top shapes in 6 veneer species in addition to 13 wood grain, 4 solid laminate selections. Veneered tops are 1 1/2" thick veneered fiberboard MDF core and backer material, with a 1/8" wood edge. Laminate tops are 1 1/2" thick with fiberboard MDF core and backer material, with a PVC edge. Conference tops are available with these profiles.



Edge profile for wood tops
Knife Edge



Edge profile for laminate tops



Edge profile for glass tops

BASES

All bases are shipped separately and require assembly to support beams and/or tops.

All wood bases, with the exception of panel bases, offer large interior cavities for cable routing and allow for total concealment of wiring when floor monuments are located underneath. Bases are equipped with removable panels which make access to the interior quick and easy.

Refer to the base requirements chart on page 60 to select the appropriate bases and sizes for conference tables.

Formed Metal Bases are available in Matte Chrome finish.

Base plates are available in a choice of Wood, Palette, Laminate or Gloss Aluminum finish.

CONSOLES

Consoles are available in 14", 27", 36", 42" and 50" lengths, and can be located within a top section or across a seam. Consoles located within a table section will be factory installed. Consoles located across the seam are ordered by a separate model number and will be shipped as a separate item for field installation. The console access cover allows wiring to pass through to the console module from all sides. The console access cover can be operated from either side of the table for easy access to the console module and opens to a 95° angle from the top of the table. Console access covers are available in Gloss Aluminum with Polished Chrome end bezels.

CONSOLE POWER/DATA/MEDIA MODULES

Console power/data/media modules are available in 18 preconfigured options or can be customized by adding plate-mounted or snap-in data ports to any of the 4 standard power modules. The number of console modules per console is dependent on the console size; 1 unit in 14" lengths, 2 units in 27" and 36" lengths, and 3 units in 42" and 50" lengths. Console power modules are available in three cord lengths (6', 16' and 25'). A utility outlet is available in some console module models for connecting power within a table. Up to 10 duplex receptacles can be connected to one electrical circuit. Faceplates, duplex receptacles and data components are white.

SUPPORT BEAMS

Aluminum support beams provide strength and support to the conference tops. Support beams are field installed onto the bases allowing for top-on-last installation for all base styles except the formed metal base. Powder coated steel trough pans located between the support beams accommodate under-surface cable management and runs cables to interior base cavities to access floor monuments.

SEATING CAPACITY

To establish seating capacity, an outside chair dimension of 24" has been used for this price guide, plus an allowance of 5" between chairs, for a total of 29". This is an approximation only. When using another chair, particularly seating with a 5 prong caster base, be sure to adjust the approximate seating capacity accordingly. Since not all manufacturers use the same formula, when seating capacity is in question, please contact Krug Customer Service to review the specific seating that is being used with Nuvo Conference Tables.

VENEER

Veneers available are Rift White Oak, Quarter Cut Maple, Cherry, Walnut.

FINISH

A five step catalyzed varnish finish that when dry has a sheen value of 32°, is applied to all tables, bases and cases. A lower sheen topcoat, 20°, can also be specified, at standard pricing. All purchase orders must clearly note "lower sheen finish" in order to receive this optional selection. All finished surfaces are well sanded before applying finishing materials. The procedure begins by applying a base color via an NGR stain. A wash coat follows to further enhance the color. Next is the glazing process, which provides the 3rd color step and fills the pores of the wood. A sealer coat is then applied, twice to the horizontal worksurfaces to enhance the finish. The product is then scuff sanded to prepare for the top coat. The top coat is a catalyzed varnish that when dry has a sheen value of 32°. Krug's catalyzed varnish has been tested to be one of the industry's most durable and long lasting. Custom finishes are available at an upcharge of 10% list per unit.

GLASS SURFACES

Nuvo conference tops are available in white back-painted 10mm tempered glass. Please contact customer service for additional color selections available at no upcharge. Color options also on website.

SOLID SURFACES

Solid Surface tops are available on conference tops. The solid surface standard top option is white, with additional colors available upon request. Solid surfaces are composed of minerals, acrylic resins that are non-porous and stain, scratch and dent resistant. Color is throughout the material, so surface scratches are not as visible. Please contact customer service with specifications for a quote.

GLIDES

Wood bases feature adjustable glides 1 1/2" long and allow for a range of adjustment of 3/4". Metal bases have 1/2" glides.

MICROPHONE CUT OUTS

Microphone cut outs are available for **\$344 list** per table for up to 7 microphone cutouts. For Back-Painted Glass tops add an additional **\$115 list** per cut-out.

HOW TO SPECIFY NUVO

- 1) Specify table top shape, size, model number and top material. For wood and laminate tops see page 9, for Back-Painted Glass see page 36.
- 2) Select base shape, size and model number using Base Requirements chart on page 60.
- 3) Specify console location (end sections, middle sections or across the seam) and size option. For wood top see page 15, for Back-Painted Glass see page 40.
- 4) Cross seam console model number, where applicable. For wood top see page 15 for Back-Painted Glass see page 41.
Please note: Across seam consoles are field installed and have a separate model number.
- 5) Specify Console Power module options. Preconfigured Console Modules, see page 49. Custom Console Modules, see page 53.
- 6) Add plate-mounted data or snap-in data options to custom module, see port options on page 49.

Purchase orders must include:

- Wood Species and Finish
- Base Plates - Gloss Aluminum, Palette, Laminate or Wood

LAMINATE WORKSURFACES

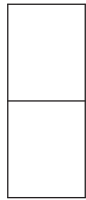
Laminate is available on all Nuvo Conference Tops; refer to Krug's standard laminate program on page 347. Krug will order and procure laminates. Purchase orders with a plastic laminate option must include Laminate Name.

Krug reserves the right to decline a laminate that may not be suitable for the application. Krug assumes no responsibility for durability or consistent color. The number of sections on 48" wide Laminate tops, on some table sizes, are different than the same size wood top. This is due to the size of laminates available. See table sections column on pages 25. Please note the grain direction of wood grain laminates will run lengthwise on 1 piece tops and crosswise on multiple piece tables. The grain direction of wood grain laminate will run horizontal on the backs of credenzas and buffets.

CUSTOM SIZING

Custom sizing and additional customization is available on Nuvo Conference Tables. Tops may be ordered with a reduced number of sections at an upcharge. For more information or to obtain quotations, please contact Customer Service.

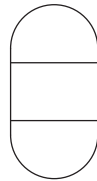
STANDARD TABLE SHAPES



Rectangular
Model Number: 5161
Glass Top 5161GP



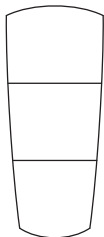
Arc End
Model Number: 5166
Glass Top 5166GP



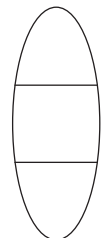
Racetrack
Model Number: 5102
Glass Top 5102GP



Boat Shaped-Arc Ends
Model Number: 5164
Glass Top 5164GP



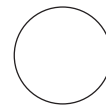
Visio-Arc Ends
Model Number: 5168
Glass Top 5168GP



Oval
Model Number: 5159
Glass Top 5159GP



Arced Square
Model Number: 5166
Glass Top 5166GP



Round
Model Number: 5105
Glass Top 5105GP

SQUARE CORNER TOPS

Nuvo conference tables may be specified with Square Corners in all shapes with rounded corners. To order these additional configurations, please replace the standard model number with the number listed: Rectangular = 5101, Arc End = 5106, Boat Shape-Straight End = 5104, Boat Shape-Arc End = 5154, Visio-Straight End = 5108, Visio-Arc End = 5158, Arc Square = 5156. Pricing for tops with square corners is the same as standard tops.

TESTING

All products have been tested in accordance with ANSI/BIFMA X5.5-2014 or X5.9-2012.



NUVO | POWER MANAGEMENT

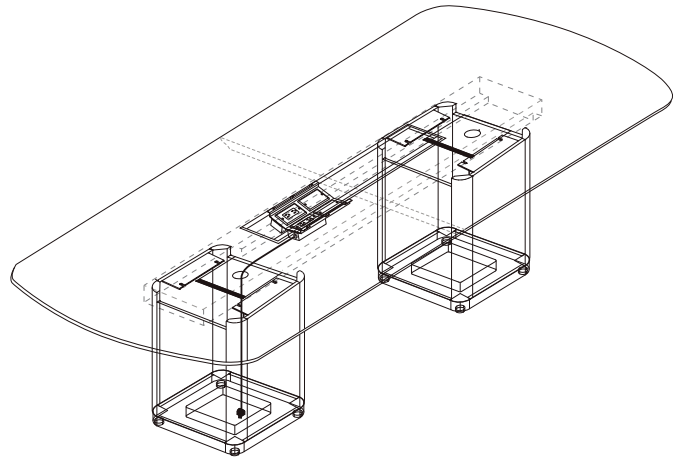
All Nuvo Conference tables feature cable management capabilities for routing cables between the floor monuments and the consoles that provide voice/power/data/media connections.

Support beams connect the bases and provide additional support for the conference top. Support beams enable top-on-last assembly of the tables - this shortens the installation time, requires fewer installers, and helps to prevent damage to table tops. Data cables can be connected to the power/data modules and dropped into the base and connected to the source prior to the installation of the top. After the top is installed, the power modules are bolted into the threaded inserts in the top. Cable troughs located between the support beams offer generous space for cable management and are supplied with grommets to allow for cables to pass through to the base interior cavities.

Bases feature sizable cutouts at the bottom, providing access to floor monuments. With the exception of Panel and Formed Metal Bases, bases allow for total concealment of wiring when floor monuments are located underneath. Access doors are provided on the inward-facing vertical side of the bases, providing quick access to cabling in the interior. Formed Metal bases are available with an external cable management system and cables are run to the floor using a Metal Cable Manager or Spine Cable Manager.

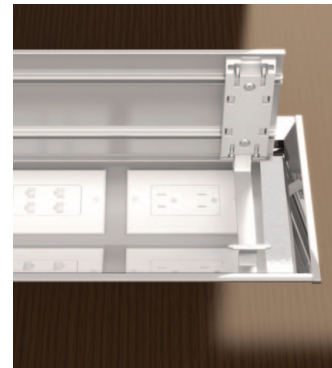
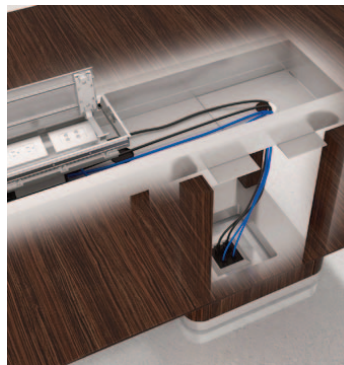
The Console modules are housed within the support beam and provide power and communications connectivity. Console modules utilize UL standard receptacle outlets. Console modules are available in 18 pre-configured configurations, or can be custom-configured in unique configurations - or alternatively can be specified with blank ports, so customers can purchase and insert their own outlets. Console modules also can be designed and built specifically to meet your connectivity needs by using the Snap-in or Plate mounted port options. Console modules are available with three electrical cord lengths (6', 16', and 25'). Console modules with a utility outlet will allow units to be linked together to a maximum of 10 duplex receptacles per circuit. The number of console modules is dependent on the console size; 1 unit in 14" lengths, 2 units in 27" and 36" lengths, and 3 units in 42" and 50" lengths.

Consoles are available in 14", 27", 36", 42" and 50" lengths, and can be located within a top section, or can span top section seams. The console access cover allows wiring to pass through to the console module from all sides. Console access covers are operated from either side of the table for easy access to the console module and open to a 95° angle from the top of the table. Console access covers are available in a Gloss Aluminum finish with polished chrome end bezel. There are some limitations in glass, please see page 41.

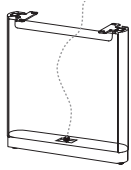


SUPPORT BEAMS & CABLE TROUGH

CONSOLE MODULE



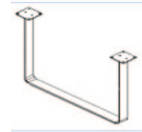
Panel Base



Base Size	Base Floor Monument Cut Out Dimension
Note: Panel bases will not completely conceal floor monuments.	
Panel bases have 2 cable access panels	

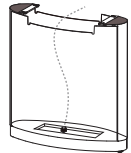
21" x 3"	4" X 1.5"
25" x 3"	4" X 1.5"
31" x 3"	4" X 1.5"

Formed Metal Base



NOTE: Formed Metal bases do not feature an interior cavity. Formed Metal bases have external cable management systems allowing cables to run to the floor monument. See page 60 for model numbers and cable management options. Overall table height is 29.5"

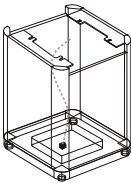
Oval Base



Oval bases have 2 cable access panels 16" x 16"

21" x 8"	12" X 5"
25" x 10"	12" X 6.5"
31" x 12"	12" X 9.5"

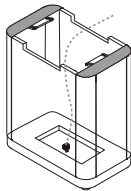
Square Base



Square bases have 1 cable access panel

16"x16"	6.25" X 6.25"
20" x 20"	9.5" X 9.5"
24" x 24"	14.5" X 14.5"
30" x 30"	20.5" X 20.5"

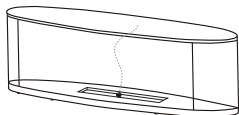
Rectangular Base



Rectangular bases have 1 cable access panel

21" x 12"	15" X 6"
25" x 12"	19" X 6"
31" x 12"	25" X 6"

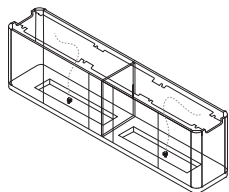
Oval Island Base



Oval Island bases have 2 cable access panels

18" x 47"	10" X 20"
18" x 71"	(2) 6 X 11 (1) 6 X 15
24" x 71"	13 X 33
24" x 95"	(2) 13 X 12 (1) 13 X 26
24" x 107"	(2) 13 X 17 (1) 13 X 33

Rectangular Island Base

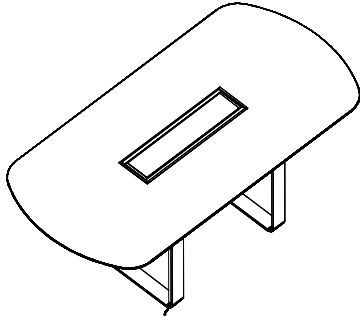


Rectangular Island bases have 1, 2 or 3 cable access panels depending on base size

18" x 27"	9" X 9"
18" x 39"	9" X 22"
18" x 63"	9" X 29"
18" x 99"	(2) 9" X 33"
18" x 123"	(2) 9" X 43"
18" x 171"	(4) 8" X 34"
24" x 63"	11" X 29"
24" x 99"	(2) 11" X 33"
24" x 123"	(2) 11" X 43"
24" x 171"	(4) 11" X 34"
24" x 219"	(3) 11" X 40"

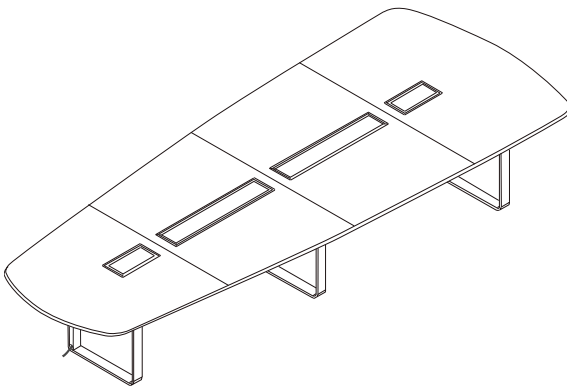
NUVO | SAMPLE CONFIGURATIONS

SAMPLE CONFIGURATIONS - EXAMPLE ONE



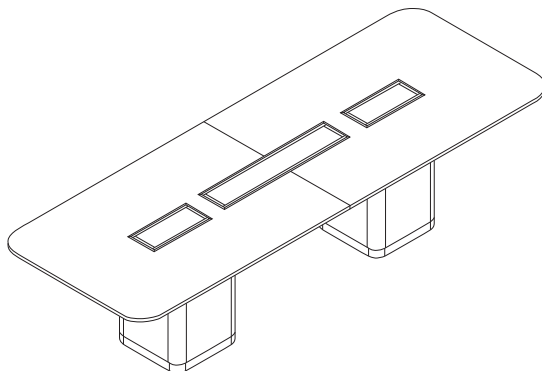
Description	Model Number	Laminate, Oak	
		Maple, Cherry	Walnut
(1) Arc End Top 72x36	51667236	3095	3404
(1) Formed Metal Base w/ Metal Cable Manager	514124328CMI	1356	1356
(1) Formed Metal Base	514124328	1173	1173
(1) Console Access Port within top section	AM27	295	295
(1) Console Power Module for Custom Configurations	51PMA06	483	483
Console Data/Media Options			
Position 3 -(1) - DVI-D Dual (Digital)	P03	137	137
Position 4 -(1) - Adaptor Plate	M04	38	38
-(2) - RJ45-CAT6 White	S01W	47	47
		47	47
-(1) - RJ11-Telephone White	S02W	32	32
-(1) - HDMI	S04	173	173
TOTAL LIST		\$6,876	\$7,185

SAMPLE CONFIGURATIONS - EXAMPLE TWO




Description	Model Number	Laminate, Oak	
		Maple, Cherry	Walnut
(1) Visio Top 168x66/42	51681686642	13909	15297
(1) Formed Metal Base w/ Metal Cable Manager	514124328CM1	1356	1356
(1) Formed Metal Base	514136328	1311	1311
(1) Formed Metal Base	514148328	1446	1446
(4) Console Access Ports within top section	AI14	265	265
	BM36	333	333
	CM36	333	333
	DI14	265	265
(3) Basic Data with 2 Duplex Receptacles & Utility Outlet	51PDCD01-06	559	559
		559	559
		559	559
(1) Basic Data with 2 Duplex Receptacles	51PDAD01-06	508	508
TOTAL LIST		\$21,403	\$22,791

SAMPLE CONFIGURATIONS - EXAMPLE THREE



Description	Model Number	Laminate, Oak	
		Maple, Cherry	Walnut
(1) Rectangular Top 120x48	516112048	5946	6541
(2) 20" Square Bases	5143202025	1236	1358
		1236	1358
(2) Console Access Port within top section	AM14	265	265
	BM14	265	265
(1) Console Access Port across a seam	51CONSOLE-X27 (ABX27)	295	295
(2) Basic Data with 2 Duplex Receptacles & Utility Outlet	51PDCD01-06	559	559
		559	559
(1) Basic Data with 2 Duplex Receptacles	51PDAD01-06	508	508
TOTAL LIST		\$10,869	\$11,708

NUVO | RECTANGULAR CONFERENCE TOPS

Description	Model	Laminate		L	W	Table Sections	Approximate Seating	Shipping Weight	Cubic Feet
		Oak, Maple, Cherry	Walnut						
Rectangular- Rounded Corners	51616036	2787	3066	60	36	1	4	95	5
	51616042	2936	3231	60	42	1	4	110	6
	51616048	3088	3396	60	48	1	4	125	6
	51617236	2983	3279	72	36	1	6	113	6
	51617242	3133	3445	72	42	1	6	131	7
	51617248	3283	3609	72	48	1	6	148	8
	51617836	3238	3561	78	36	1	6	122	6
	51617842	3418	3760	78	42	1	6	142	7
	51617848	3599	3958	78	48	1	6	161	8
	51618436	3462	3811	84	36	1	6	131	7
	51618442	3688	4059	84	42	1	6	152	8
	51618448	3915	4308	84	48	1	6	172	9
	51619636	3613	3975	96	36	1	8	150	8
	51619642	4215	4637	96	42	2	8	175	9
	51619648	4817	5299	96	48	2	8	198	10
	516110842	4366	4802	108	42	2 (3)	8	195	10
	516110848	5043	5547	108	48	2 (3)	8	222	11
	516110854	5796	6375	108	54	3	8	250	13
	516112042	5269	5796	120	42	2 (3)	8	216	11
	516112048*	5946	6541	120	48	2 (3)	10	247	12
	516112054	6624	7287	120	54	3	10	278	14
	516112060	7375	8116	120	60	3	10	307	15
	516114448	6773	7452	144	48	2 (3)	10	297	15
	516114454	7603	8364	144	54	3	12	333	17
	516114460	8506	9357	144	60	3	12	369	18
	516115654	8280	9109	156	54	3 (4)	12	362	18
	516115660	9334	10266	156	60	3 (4)	12	401	20
516116848	8957	9853	168	48	3 (4)	12	347	17	
516116854	10086	11095	168	54	4	12	390	19	
516116860	11366	12502	168	60	4	12	431	21	
516119248	10463	11510	192	48	3 (4)	14	397	20	
516119254	11741	12915	192	54	4	14	445	22	
516119260	13172	14488	192	60	4	14	492	24	
516121654	12946	14240	216	54	5	16	501	24	
516121660	14526	15978	216	60	5	16	554	27	
516124060	16408	18048	240	60	5	18	617	30	
516126460	18592	20447	264	60	6	20	680	33	
516128860	20997	23096	288	60	6	22	740	36	

NOTE: Support Beams are included in top price. An additional line item for the support beam will be included on the order acknowledgment at no charge.

RECTANGULAR - SQUARE CORNER TOPS:

Rectangular tops with square corners are available. Replace the model prefix with **5101**. e.g. **516114448** becomes **510114448** Pricing is the same as standard tops.

LAMINATE TABLE SECTIONS:

The number in brackets under table sections, refers to the number of sections when ordering laminate tops, if different than the number of sections for the same size wood top. Please note the grain direction of wood grain laminates will run lengthwise on 1 piece tops and crosswise on multiple piece table tops.

ORDERING PROCEDURES

- To order, please specify the following:
- 1) Table top shape, size, model number and wood species
 - 2) Base model number
 - 3) Console location and size option
 - 4) Cross seam console model number, where applicable
 - 5) Console power module and data options

DIMENSION KEY

L - length
W - Width
Dimensions are in inches and approximate.
Contact Customer Service if dimensions are critical.

STANDARD FINISHES

For a complete list of standard wood finishes, please see page 347

BASE REQUIREMENTS

See page 60 for base requirements

CONSOLE SIZE & LOCATIONS

For information on Console locations and size options, see page 15 for wood and page 25 for laminate.

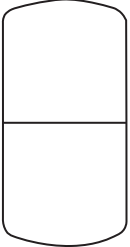
CONSOLE POWER/DATA MODULE OPTIONS

See page 49 for Console Module Options

TABLE SECTION SIZE

Section sizes can be calculated by dividing the table length by the # of sections

NUVO | ARC END CONFERENCE TOPS

Description	Model	Laminate		L	W	Table Sections	Approximate Seating	Shipping Weight	Cubic Feet
		Oak, Maple, Cherry	Walnut						
Arc End Table - Rounded Corners	51666036	2898	3188	60	36	1	4	89	5
	51666042	3088	3396	60	42	1	4	103	5
	51666048	3274	3604	60	48	1	4	117	6
	51667236	3095	3404	72	36	1	6	107	5
	51667242	3283	3609	72	42	1	6	123	6
	51667248	3470	3818	72	48	1	6	140	7
	51667836	3349	3685	78	36	1	6	116	6
	51667842	3567	3924	78	42	1	6	134	7
	51667848	3787	4167	78	48	1	6	153	8
	51668436	3577	3934	84	36	1	6	125	7
	51668442	3841	4222	84	42	1	6	144	7
	51668448	4103	4512	84	48	1	6	164	9
	51669636	3727	4099	96	36	1	8	144	7
	51669642	4366	4802	96	42	2	8	167	9
	51669648*	5006	5507	96	48	2	8	190	10
	516610842	4515	4968	108	42	2 (3)	8	188	10
	516610848	5232	5756	108	48	2 (3)	8	214	11
	516610854	6021	6624	108	54	3	8	240	12
	516612042	5420	5962	120	42	2 (3)	10 (8)	211	11
	516612048	6136	6749	120	48	2 (3)	10	239	12
	516612054	6850	7534	120	54	3	10	268	14
	516612060	7641	8405	120	60	3	10	297	15
	516614448	6962	7658	144	48	2 (3)	10	289	15
	516614454	7829	8611	144	54	3	12	324	16
	516614460	8768	9646	144	60	3	12	359	18
	516615654	8506	9357	156	54	3 (4)	12 (10)	353	18
	516615660	9597	10557	156	60	3 (4)	12	390	20
516616848	9145	10061	168	48	3 (4)	12	338	17	
516616854	10312	11344	168	54	4	12	380	19	
516616860	11628	12792	168	60	4	12	421	21	
516619248	10651	11715	192	48	3 (4)	14	388	20	
516619254	11967	13164	192	54	4	14	435	22	
516619260	13434	14780	192	60	4	14	482	24	
516621654	13172	14488	216	54	5	16	491	25	
516621660	14789	16268	216	60	5	16	544	27	
516624060	16671	18339	240	60	5	20 (18)	606	30	
516626460	18854	20739	264	60	6	20	668	33	
516628860	21262	23388	288	60	6	22	729	36	

NOTE: Support Beams are included in top price. An additional line item for the support beam will be included on the order acknowledgment at no charge.

ARC END TABLE - SQUARE CORNERS:

Arc End tops are available with square corners. Replace the model number prefix with **5106**. e.g. **516612042** becomes **510612042**. Pricing is the same as standard tops.

LAMINATE TABLE SECTIONS:

The number in brackets under table sections, refers to the number of sections when ordering laminate tops, if different than the number of sections for the same size wood top. Please note the grain direction of wood grain laminates will run lengthwise on 1 piece tops and crosswise on multiple piece table tops.

SEATING CAPACITY:

The number in brackets is the seating capacity when formed metal legs are used if different than the seating capacity when other bases are used.

ORDERING PROCEDURES

- To order, please specify the following:
- 1) Table top shape, size, model number and wood species
 - 2) Base model number
 - 3) Console location and size option
 - 4) Cross seam console model number, where applicable
 - 5) Console power module and data options

DIMENSION KEY

L - Length
W - Width
Dimensions are in inches and approximate.
Contact Customer Service if dimensions are critical.

STANDARD FINISHES

For a complete list of standard wood finishes, please see page 347

BASE REQUIREMENTS

See page 60 for base requirements

CONSOLE SIZE & LOCATIONS

For information on Console locations and size options, see page 15 for wood and page 25 for laminate.

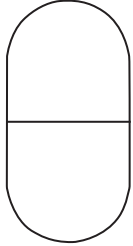
CONSOLE POWER/DATA MODULE OPTIONS

See page 49 for Console Module Options

TABLE SECTION SIZE

Section sizes can be calculated by dividing the table length by the # of sections

NUVO | RACETRACK CONFERENCE TOPS

Description	Model	Laminate		L	W	Table Sections	Approximate Seating	Shipping Weight	Cubic Feet
		Oak, Maple, Cherry	Walnut						
	51026036	2936	3231	60	36	1	4	83	5
	51026042	3088	3396	60	42	1	4	94	5
	51026048	3251	3578	60	48	1	4	104	6
	51027236	3133	3445	72	36	1	6	101	6
	51027242	3297	3627	72	42	1	6	115	6
	51027248	3449	3792	72	48	1	6	127	7
	51027836	3403	3742	78	36	1	6	110	6
	51027842	3599	3958	78	42	1	6	126	7
	51027848	3781	4156	78	48	1	6	140	8
	51028436	3643	4007	84	36	1	6	119	7
	51028442	3885	4272	84	42	1	6	136	7
	51028448	4111	4521	84	48	1	6	152	9
	51029636	3793	4173	96	36	1	8	138	7
	51029642	4426	4868	96	42	2	8	159	9
	51029648	5059	5563	96	48	2	8	178	10
	510210842	4592	5052	108	42	2 (3)	8	180	10
	510210848*	5299	5830	108	48	2 (3)	8	202	11
	510210854	6098	6708	108	54	3	10 (8)	226	12
	510212042	5539	6093	120	42	2 (3)	8	202	11
	510212048	6247	6871	120	48	2 (3)	10	227	12
	510212054	6956	7651	120	54	3	10	251	14
	510212060	7755	8528	120	60	3	10 (8)	275	15
	510214448	7122	7834	144	48	2 (3)	12 (10)	277	15
	510214454	7994	8791	144	54	3	12 (10)	307	16
	510214460	8941	9836	144	60	3	12 (10)	337	16
	510215654	8700	9563	156	54	3 (4)	14 (12)	336	18
	510215660	9800	10779	156	60	3 (4)	14 (12)	369	20
	510216848	9410	10349	168	48	3 (4)	12	326	17
	510216854	10597	11657	168	54	4	14 (12)	364	19
	510216860	11939	13132	168	60	4	14 (12)	399	21
510219248	10989	12089	192	48	3 (4)	14	376	20	
510219254	12330	13561	192	54	4	16 (14)	418	22	
510219260	13833	15216	192	60	4	16 (14)	460	24	
510221654	13594	14954	216	54	5	18 (16)	475	25	
510221660	15264	16791	216	60	5	18 (16)	522	27	
510224060	17236	18958	240	60	5	18 (16)	584	30	
510226460	19523	21473	264	60	6	20 (18)	647	33	
510228860	22052	24257	288	60	6	22 (20)	707	36	

NOTE: Support Beams are included in top price. An additional line item for the support beam will be included on the order acknowledgment at no charge.

LAMINATE TABLE SECTIONS:

The number in brackets under table sections, refers to the number of sections when ordering laminate tops, if different than the number of sections for the same size wood top. Please note the grain direction of wood grain laminates will run lengthwise on 1 piece tops and crosswise on multiple piece table tops.

SEATING CAPACITY:

The number in brackets is the seating capacity when formed metal legs are used if different than the seating capacity when other bases are used.

ORDERING PROCEDURES

To order, please specify the following:

- 1) Table top shape, size, model number and wood species
- 2) Base model number
- 3) Console location and size option
- 4) Cross seam console model number, where applicable
- 5) Console power module and data options

DIMENSION KEY

L - length
W - Width

Dimensions are in inches and approximate.

Contact Customer Service if dimensions are critical.

STANDARD FINISHES

For a complete list of standard wood finishes, please see page 347

BASE REQUIREMENTS

See page 60 for base requirements

CONSOLE SIZE & LOCATIONS

For information on Console locations and size options, see page 15 for wood and page 25 for laminate.

CONSOLE POWER/DATA MODULE OPTIONS

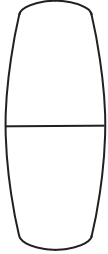
See page 49 for Console Module Options

TABLE SECTION SIZE

Section sizes can be calculated by dividing the table length by the # of sections

NUVO | BOAT SHAPED & VISIO CONFERENCE TOPS

Description	Model	Laminate		L	W	Table Sections	Approximate Seating	Shipping Weight	Cubic Feet
		Oak, Maple, Cherry	Walnut						
Boat-Shaped - Arc End	5164964842	5210	5729	96	48/42	2	8	181	10
	5164965442*	6109	6718	96	54/42	2	8	204	11
Rounded Corners	51641204842	6430	7071	120	48/42	2 (3)	8	229	12
	51641205442	7164	7882	120	54/42	3	10 (8)	257	14
	51641444842	7316	8046	144	48/42	2 (3)	10	276	15
	51641445442	8220	9041	144	54/42	3	12	311	15
	51641685442	10900	11987	168	54/42	4	12	366	19
	51641925442	12691	13960	192	54/42	4	14	419	22
	51642166048	15702	17270	216	60/48	5	16	526	27
	51642406048	17733	19505	240	60/48	5	18 (16)	585	30
	51642646048	20081	22089	264	60/48	6	20	646	33
	51642886048	22684	24953	288	60/48	6	22	704	36



NOTE: Support Beams are included in top price. An additional line item for the support beam will be included on the order acknowledgment at no charge.

BOAT SHAPE - ARC END, SQUARE CORNERS:

Boat Shape tops are available with Arc ends and Square corners. For Arc End, Square Corner tops replace model suffix with **5154**. e.g. **51641204842** becomes **51541204842**. Pricing is the same as standard tops.

BOAT SHAPE - STRAIGHT END, SQUARE CORNERS:

Boat Shape tops are available with Straight ends and square corners. For Straight End, Square Corner tops replace model suffix with **5104**. e.g. **51641204842** becomes **51041204842**. Pricing is the same as standard tops.

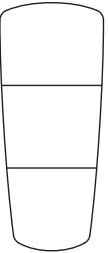
LAMINATE TABLE SECTIONS:

The number in brackets under table sections, refers to the number of sections when ordering laminate tops, if different than the number of sections for the same size wood top. Please note the grain direction of wood grain laminates will run lengthwise on 1 piece tops and crosswise on multiple piece table tops.

SEATING CAPACITY:

The number in brackets is the seating capacity when formed metal legs are used if different than the seating capacity when other bases are used.

Visio - Arc End Rounded Corners	51681206042	9560	10514	120	60/42	3	8	268	15
	51681446042*	13083	14389	144	60/42	3	10	323	18
	51681686642	13909	15297	168	66/42	4	13	407	23
	51681926942	14994	16494	192	69/42	4	15	482	27
	51682167342	16333	17966	216	73/42	5	17	567	32
	51682407642	17508	19259	240	76/42	5	19	651	38



NOTE: Support Beams are included in top price. An additional line item for the support beam will be included on the order acknowledgment at no charge.

VISIO - ARC END, SQUARE CORNERS:

Visio Shape Tops with Arc Ends are available with square corners. For Arc End-Square corners, replace the model suffix with **5158**. e.g. **51681446042** becomes **51581446042**. Pricing is the same as standard tops.

VISIO - STRAIGHT END, SQUARE CORNERS:

Visio Shape Tops with Straight Ends are available with square corners. For Arc Straight End-Square corners, replace the model suffix with **5108**. e.g. **51681446042** becomes **51081446042**. Pricing is the same as standard tops.

ORDERING PROCEDURES

To order, please specify the following:

- 1) Table top shape, size, model number and wood species
- 2) Base model number
- 3) Console location and size option
- 4) Cross seam console model number, where applicable
- 5) Console power module and data options

DIMENSION KEY

L - Length

W - Width

Dimensions are in inches and approximate.

Contact Customer Service if dimensions are critical.

12 | CANADA | CONFERENCE | 2025

STANDARD FINISHES

For a complete list of standard wood finishes, please see page 347

BASE REQUIREMENTS

See page 60 for base requirements

CONSOLE SIZE & LOCATIONS

For information on Console locations and size options, see page 15 for wood and page 25 for laminate.

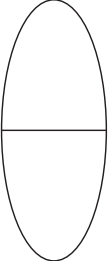
CONSOLE POWER/DATA MODULE OPTIONS

See page 49 for Console Module Options

TABLE SECTION SIZE

Section sizes can be calculated by dividing the table length by the # of sections


NUVO | OVAL, ARCED SQUARE & ROUND CONFERENCE TOPS

Description	Model	Laminate		L	W	Table Sections	Approximate Seating	Shipping Weight	Cubic Feet
		Oak, Maple, Cherry	Walnut						
	51598448	4503	4951	84	48	1	6	136	9
	51599648	5751	6325	96	48	2	8	157	10
	51599654	6232	6857	96	54	2	8	176	11
	515912048*	6850	7534	120	48	2 (3)	8	196	12
	515912060	7422	8163	120	60	3	10	243	15
	515914454	8537	9388	144	54	3	10	264	16
	515914460	8957	9853	144	60	3	12	292	18
	515916860	10206	11228	168	60	4	12	341	21

NOTE: Support Beams are included in top price. An additional line item for the support beam will be included on the order acknowledgment at no charge.

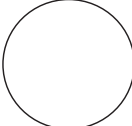
LAMINATE TABLE SECTIONS:

The number in brackets under table sections, refers to the number of sections when ordering laminate tops, if different than the number of sections for the same size wood top.

Arced Square Top									
	51663636	2033	2237	36	36	1	4	59	3
	51664242	2243	2466	42	42	1	4	79	4
	51664848	2530	2781	48	48	1	4	101	5
	51665454	2860	3146	54	54	1	4	127	7
	51666060	3706	4072	60	60	1	4	155	8

ARC SQUARE TOP - SQUARE CORNERS:

Arc Square tops are available with square corners. For Square Corner tops replace model suffix with **5156**. e.g. **51664242** becomes **51564242**. Pricing is the same as standard tops.

Round Top									
	510536	1988	2188	36 Dia.		1	3	47	3
	510542	2197	2418	42 Dia.		1	3	63	4
	510548	2470	2716	48 Dia.		1	4	80	5
	510554	3192	3512	54 Dia.		1	5	100	7
	510560	3718	4090	60 Dia.		1	5	123	8

ORDERING PROCEDURES

To order, please specify the following:

- 1) Table top shape, size, model number and wood species
- 2) Base model number
- 3) Console location and size option
- 4) Cross seam console model number, where applicable
- 5) Console power module and data options

DIMENSION KEY

- L - Length
 - W - Width
 - D - Depth
 - H - Height
- Dimensions are in inches and approximate.
Contact Customer Service if dimensions are critical.

STANDARD FINISHES

For a complete list of standard wood finishes, please see page 347

BASE REQUIREMENTS

See page 60 for base requirements

CONSOLE SIZE & LOCATIONS

For information on Console locations and size options, see page 15 for wood and page 25 for laminate.

CONSOLE POWER/DATA MODULE OPTIONS

See page 49 for Console Module Options

TABLE SECTION SIZE

Section sizes can be calculated by dividing the table length by the # of sections

NUVO | CONSOLE PLANNING FOR WOOD TOPS

CONSOLE ORDERING CODE (WITHIN THE TABLE SECTION - 4 CHARACTER CODE)

1st character specifies top sections from left to right on table: A, B, C, D, E, F

2nd character specifies console location within top section: M, I, L, R

M- Middle of top on one piece table

M- Middle of top section on multi section table

I - Inset 3" from seam on end sections

L- Left side of a one piece top

R- Right side of a one piece top

3rd and 4th characters specify console size: 14, 27, 36, 42, 50

Examples:

Table Size: 96" x 36"

AM42

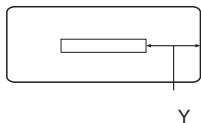


Table Size: 168" x 48"

AM14

BM50

CM14

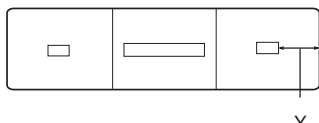


Table Size: 96 "x 36"

AL14

AR14

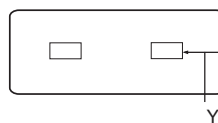
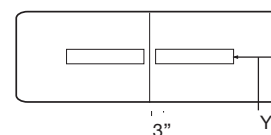


Table Size: 144" x 48"

AI42

BI42



Y= Dimension from end of table to end of console
18" or greater, cannot be less than 18"

CONSOLE ORDERING CODE (ACROSS SEAM - 5 CHARACTER CODE)

1st and 2nd character specifies section from left to right on table: AB, BC, CD, DE, EF

3rd character specifies console location across the seam: X

4th and 5th characters specify console size: 14, 27, 36, 42, 50

Examples:

Table Size: 288" x 60"

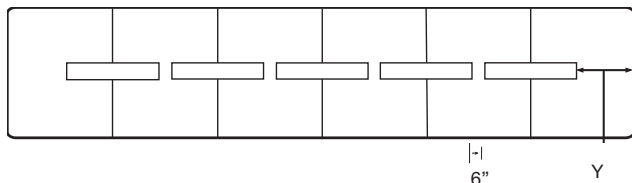
ABX42

BCX42

CDX42

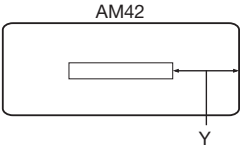
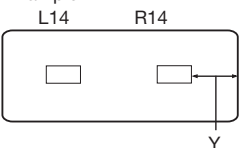
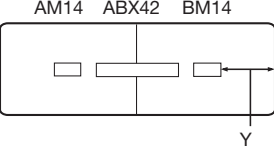
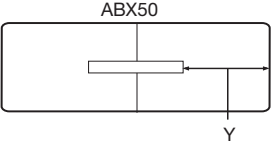
DEX42

EFX42



Y= Dimension from end of table to end of console

NUVO | CONSOLE SIZE & LOCATION - RECTANGULAR, ARC END, RACETRACK

Wood Top Console Options	Top Length	Console Options Top End Section	Console Options Within Top Center Section	Console Options Across Seam	Y
WIDTHS 36" - 48"	60	M14			23
60" - 84" X 36", 42", 48"	72	M14			29
96" X 36"		M27			22.5
Example	78	M14			32
		M27			25.5
		M36			21
		M42			18
	84	M14			35
		M27			28.5
		M36			24
		M42			21
	96	M14			41
		M27			34.5
		M36			30
		M42			27
		M50			23
78" - 84" X 36", 42", 48"	78	L14 / R14			18
96" X 36"	84	L14 / R14			18
Example	96	L14 / R14			18
					
96" - 144" X 42", 48"	96	M14			18
Example	108	M14		X27	20
		M14		X27	23
		M14		X27	29
		M27		X27 X36 X42	22.5
	144	M14		X27	29
		M27		X27	22.5
96" - 144" X 42", 48"	96			X27	34.5
				X36	30
Example				X42	27
				X50	23
	108			X27	40.5
				X36	36
				X42	33
				X50	29
		120			X36
				X42	39
				X50	35
	144			X50	47

CODE KEY

M - Console location, middle of top section
 I - Console location, Inset 3" from seam on end sections
 X - Console location, across a seam of two top sections
 L - Console location, left side of a one piece top
 R - Console location, right side of a one piece top
 Y - Dimension from end of table to end of Console

Caution: Y greater than 30" makes access to Console Power/Data difficult from the end of the table

CONSOLE SIZE & LOCATIONS

See page 15 for information on console locations and size options for wood tops, and page 25 for laminate tops locations and sizes

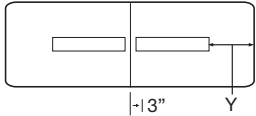
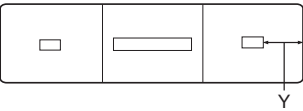
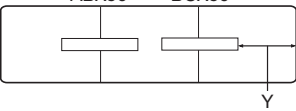
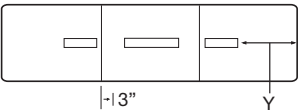
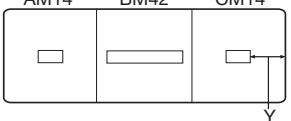
CONSOLE MODULE OPTIONS

See page 49 for power / data options

ORDERING NOTES

Tops may be specified with fewer consoles and configurations other than shown. Consoles can be different sizes within the same top. Dimension from end of cut-out to table end cannot be less than 18".

NUVO | CONSOLE SIZE & LOCATION - RECTANGULAR, ARC END, RACETRACK

Wood Top Console Options	Top Length	Console Options Top End Section	Console Options Within Top Center Section	Console Options Across Seam	Y
WIDTHS 36" - 48"	96	I27			18
96" - 144" X 42", 48"	108	I27			24
Example	120	I27			30
	144	I36			21
		I27			42
		I36			33
		I42			27
		I50			19
168" - 192" X 48"	168	M14	M14 M27 M36 M42 M50		21
		I27	M14 M27 M36 M42 M50		26
Example	192	M14	M14 M27 M36 M42 M50		25
		I27	M14 M27 M36 M42 M50		34
		I36	M14 M27 M36 M42 M50		25
168" - 192" X 48"	168			X14	49
				X27	42.5
Example				X36	38
				X42	35
	192			X50	31
				X36	46
				X42	43
				X50	39
168" - 192" X 48"	168	M14	M14 M27 M36 M42		21
		I27	M14 M27 M36 M42		26
Example	192	M14	M14 M27 M36 M42 M50		25
		I27	M14 M27 M36 M42 M50		34
WIDTHS 54" OR GREATER	108	I14	M14 M27		19
108" - 156" X 54", 60"	120	I14	M14 M27		23
Example	144	M14	M14 M27 M36 M42		18
		I14	M14 M27 M36 M42		31
		I27	M14 M27 M36 M42		18
	156	M14	M14 M27 M36 M42		19
		I14	M14 M27 M36 M42		35
		I27	M14 M27 M36 M42		22

CODE KEY

- M - Console location, middle of top section
- I - Console location, Inset 3" from seam on end sections
- X - Console location, across a seam of two top sections
- L - Console location, left side of a one piece top
- R - Console location, right side of a one piece top
- Y - Dimension from end of table to end of Console

Caution: Y greater than 30" makes access to Console Power/Data difficult from the end of the table

CONSOLE SIZE & LOCATIONS

See page 15 for information on console locations and size options for wood tops, and page 25 for laminate tops locations and sizes

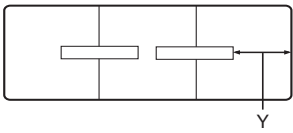
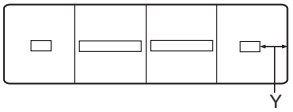
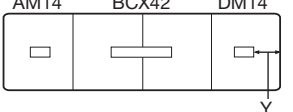
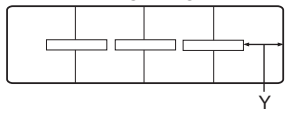
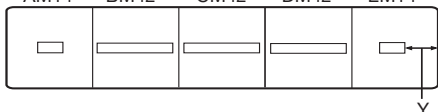
CONSOLE MODULE OPTIONS

See page 49 for power / data options

ORDERING NOTES

Tops may be specified with fewer consoles and configurations other than shown. Consoles can be different sizes within the same top. Dimension from end of cut-out to table end cannot be less than 18".

NUVO | CONSOLE SIZE & LOCATION - RECTANGULAR, ARC END, RACETRACK

Wood Top Console Options	Top Length	Console Options Top End Section	Console Options Within Top Center Section	Console Options Across Seam	Y
WIDTHS 54" OR GREATER	108			X27	22.5
108" - 156" X 54", 60"	120			X27	26.5
Example	144			X36 X42	30 27
	156			X36 X42	34 31
168"-192" X 54", 60"	168	I14	M14 M27 M36		25
Example	192	M14 I14 I27	M14 M27 M36 M42 M14 M27 M36 M42 M14 M27 M36 M42		18 31 18
	168" - 192" X 54", 60"	I14		X27 X36 X42	25
Example	192	M14 I14 I27		X36 X42 X36 X42 X36 X42	18 31 18
	168" - 192" x 54", 60"			X27 X36	28.5 24
Example	192			X27 X36 X42	34.5 30 27
	216"- 240" X 54", 60"	I14	M14 M27 M36		26
Example	240	M14 14 I27	M14 M27 M36 M42 M14 M27 M36 M42 M14 M27 M36 M42		18 31 18
					

CODE KEY

- M - Console location, middle of top section
- I - Console location, Inset 3" from seam on end sections
- X - Console location, across a seam of two top sections
- L - Console location, left side of a one piece top
- R - Console location, right side of a one piece top
- Y- Dimension from end of table to end of Console

Caution: Y greater than 30" makes access to Console Power/Data difficult from the end of the table

CONSOLE SIZE & LOCATIONS

See page 15 for information on console locations and size options for wood tops, and page 25 for laminate tops locations and sizes

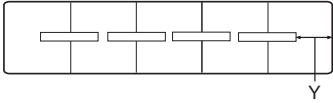
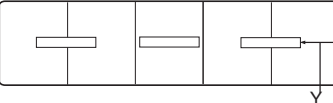
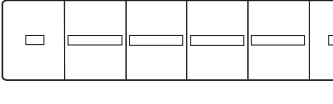
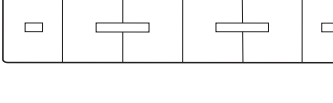
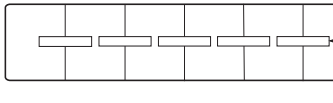
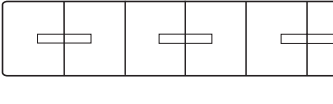
CONSOLE MODULE OPTIONS

See page 49 for power / data options

ORDERING NOTES

Tops may be specified with fewer consoles and configurations other than shown. Consoles can be different sizes within the same top. Dimension from end of cut-out to table end cannot be less than 18".

NUVO | CONSOLE SIZE & LOCATION - RECTANGULAR, ARC END, RACETRACK

Wood Top Console Options	Top Length	Console Options Top End Section	Console Options Within Top Center Section	Console Options Across Seam	Y
WIDTHS 54" OR GREATER	216			X27 X36	29.5 25
216" - 240" X 54", 60"					
Example	240			X27 X36 X42	34.5 30 27
ABX42 BCX42 CDX42 DEX42					
					
216" - 240" X 54", 60"	216		M14 M27 M36	X27 X36 X42	29.5 25 22
Example	240		M14 M27 M36 M42	X27 X36 X42 X50	34.5 30 27 23
ABX42 CM42 DEX42					
					
264" - 288" X 60"	264	M14 I14	M14 M27 M36		18 27
Example	288	M14 I14 I27	M14 M27 M36 M42		18 31 18
AM14 BM42 CM42 DM42 EM42 FM14					
					
264" - 288" X 60"	264	M14 I14		X36 X42 X50	18 27
Example	288	M14 I14 I27		X36 X42 X50	18 31 18
AM14 BCX42 DEX42 FM14					
					
264" - 288" X 60"	264			X27 X36	30.5 26
Example	288			X27 X36 X42	34.5 30 27
ABX42 BCX42 CDX42 DEX42 EFX42					
					
264" - 288" X 60"	264			X27 X36 X42	30.5 26 23
Example	288			X27 X36 X42 X50	34.5 30 27 23
ABX42 CDX42 EFX42					
					

CODE KEY

M - Console location, middle of top section
 I - Console location, Inset 3" from seam on end sections
 X - Console location, across a seam of two top sections
 L - Console location, left side of a one piece top
 R - Console location, right side of a one piece top
 Y- Dimension from end of table to end of Console

Caution: Y greater than 30" makes access to Console Power/Data difficult from the end of the table

CONSOLE SIZE & LOCATIONS

See page 15 for information on console locations and size options for wood tops, and page 25 for laminate tops locations and sizes

CONSOLE MODULE OPTIONS

See page 49 for power / data options

ORDERING NOTES

Tops may be specified with fewer consoles and configurations other than shown. Consoles can be different sizes within the same top. Dimension from end of cut-out to table end cannot be less than 18".

NUVO | CONSOLE SIZE & LOCATION - BOAT SHAPED

Wood Top Console Options	Top Length	Console Options Top End Section	Console Options Within Top Center Section	Console Options Across Seam	Y
96" - 144" X 48"/42" 96" X 54"/42"	96	M14			18
Example	120	M14		X27	23
AM14 ABX42 BM14	144	M14 M27		X27 X36 X42	29 22.5
96" - 144" X 48"/42" 96" X 54"/42"	96			X27	34.5
Example	120			X36	30
ABX50	144			X42	27
				X50	23
96" - 144" X 48"/42" 96" X 54"/42"	96	I27			18
Example	120	I27			30
AI42 BI42	144	I36			21
		I27			42
		I36			33
		I42			27
		I50			19
120" - 144" x 54"/42"	120	I14	M14 M27		23
Example	144	M14	M14 M27 M36 M42		18
AM14 BM42 CM14		I14	M14 M27 M36 M42		31
		I27	M14 M27 M36 M42		18
120" - 144" x 54"/42"	120			X27	26.5
Example	144			X36	30
ABX42 BCX42				X42	27
168" - 192" X 54"/42"	168	I14	M14 M27 M36		25
Example	192	M14	M14 M27 M36 M42		18
AM14 BM42 CM42 DM14		I14	M14 M27 M36 M42		31
		I27	M14 M27 M36 M42		18

CODE KEY

M - Console location, middle of top section
 I - Console location, Inset 3" from seam on end sections
 X - Console location, across a seam of two top sections
 L - Console location, left side of a one piece top
 R - Console location, right side of a one piece top
 Y - Dimension from end of table to end of Console

Caution: Y greater than 30" makes access to Console Power/Data difficult from the end of the table

CONSOLE SIZE & LOCATIONS

See page 15 for information on console locations and size options for wood tops, and page 25 for laminate tops locations and sizes

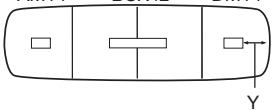
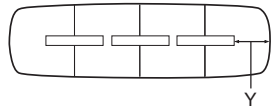
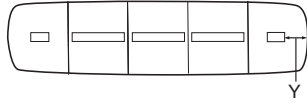
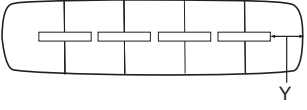
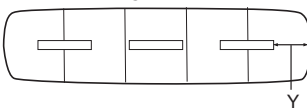
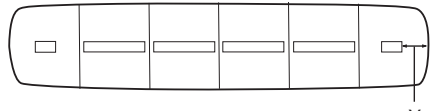
CONSOLE MODULE OPTIONS

See page 49 for power / data options

ORDERING NOTES

Tops may be specified with fewer consoles and configurations other than shown. Consoles can be different sizes within the same top. Dimension from end of cut-out to table end cannot be less than 18".

NUVO | CONSOLE SIZE & LOCATION - BOAT SHAPED

Wood Top Console Options	Top Length	Console Options Top End Section	Console Options Within Top Center Section	Console Options Across Seam	Y
168" - 192" X 54"/42"	168	I14		X27 X36 X42	25
Example	192	M14		X36 X42	18
AM14 BCX42 DM14		I14		X36 X42	31
		I27		X36 X42	18
168" - 192" X 54"/42"	168			X27 X36	28.5
Example	192			X27 X36 X42	24
ABX42 BCX42 CDX42				X27 X36 X42	34.5
				X27 X36 X42	30
				X42	27
216" - 240" X 60"/48"	216	I14	M14 M27 M36		26
Example	240	M14	M14 M27 M36 M42		18
AM14 BM42 CM42 DM42 EM14		I14	M14 M27 M36 M42		31
		I27	M14 M27 M36 M42		18
					31
					18
216" - 240" X 60"/48"	216			X27 X36	29.5
Example	240			X27 X36 X42	24
ABX42 BCX42 CDX42 DEX42				X27 X36 X42	34.5
				X27 X36 X42	30
				X42	27
216" - 240" X 60"/48"	216		M14 M27 M36	X27 X36	29.5
Example	240		M14 M27 M36	X36 X42	25
ABX42 CM42 DEX42			M14 M27 M36 M42	X42	22
			M14 M27 M36 M42	X27 X36 X42	34.5
			M14 M27 M36 M42	X36 X42	30
			M14 M27 M36 M42	X42	27
			M14 M27 M36 M42	X50	23
264" - 288" X 60"/48"	264	M14	M14 M36		18
Example	288	I14	M14 M36		27
AM14 BM42 CM42 DM42 EM42 FM14		M14	M14 M36 M42		18
		I14	M14 M36 M42		31
		I27	M14 M36 M42		18

CODE KEY

- M - Console location, middle of top section
- I - Console location, Inset 3" from seam on end sections
- X - Console location, across a seam of two top sections
- L - Console location, left side of a one piece top
- R - Console location, right side of a one piece top
- Y - Dimension from end of table to end of Console

Caution: Y greater than 30" makes access to Console Power/Data difficult from the end of the table

CONSOLE SIZE & LOCATIONS

See page 15 for information on console locations and size options for wood tops, and page 25 for laminate tops locations and sizes

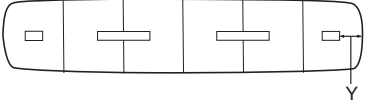
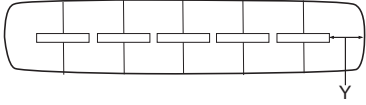
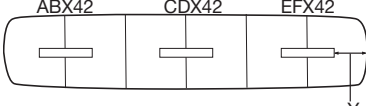
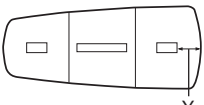
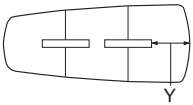
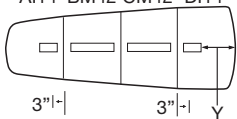
CONSOLE MODULE OPTIONS

See page 49 for power / data options

ORDERING NOTES

Tops may be specified with fewer consoles and configurations other than shown. Consoles can be different sizes within the same top. Dimension from end of cut-out to table end cannot be less than 18".

NUVO | CONSOLE SIZE & LOCATION - BOAT SHAPED & VISIO

Wood Top Console Options	Top Length	Console Options Top End Section	Console Options Within Top Center Section	Console Options Across Seam	Y
264" - 288" X 60"/48"	264	M14 I14		X36 X42 X50	18 27
Example					
AM14 BCX42 DEX42 FM14	288	M14 I14 I27		X36 X42 X50	18 31 18
					
264" - 288" X 60"/48"	264			X27 X36	30.5 26
Example	288			X27 X36 X42	34.5 30 27
					
264" - 288" X 60"/48"	264			X27 X36 X42	30.5 26 23
Example	288			X27 X36 X42 X50	34.5 30 27 23
					
120" - 144" X 60"/42"	120	I14	M14 M27		23
Example					
AM14 BM42 CM14	144	M14 I27	M14 M27 M36 M42 M14 M27 M36 M42		18 18
					
120" - 144" X 60/42	120			X27	26.5
Example					
ABX42 BCX42	144			X36 X42	30 27
					
168" X 66/42" 192" X 69/42"	168	I14	M14 M27 M36		25
Example					
AI14 BM42 CM42 DI14	192	M14 I27	M14 M27 M36 M42 M14 M27 M36 M42		18 18
					

CODE KEY

M - Console location, middle of top section
 I - Console location, Inset 3" from seam on end sections
 X - Console location, across a seam of two top sections
 L - Console location, left side of a one piece top
 R - Console location, right side of a one piece top
 Y - Dimension from end of table to end of Console

Caution: Y greater than 30" makes access to Console Power/Data difficult from the end of the table

CONSOLE SIZE & LOCATIONS

See page 15 for information on console locations and size options for wood tops, and page 25 for laminate tops locations and sizes

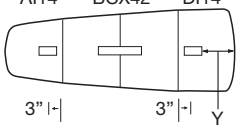
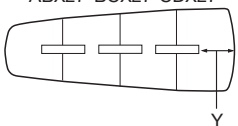
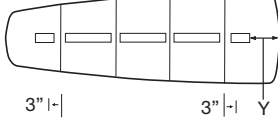
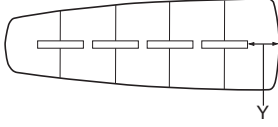
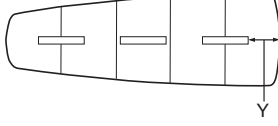
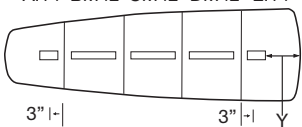
CONSOLE MODULE OPTIONS

See page 49 for power / data options

ORDERING NOTES

Tops may be specified with fewer consoles and configurations other than shown. Consoles can be different sizes within the same top. Dimension from end of cut-out to table end cannot be less than 18".

NUVO | CONSOLE SIZE & LOCATION - VISIO

Wood Top Console Options	Top Length	Console Options		Console Options				Y
		Top End Section	Top Center Section	Within Top Center Section		Across Seam		
168" X 66/42"	168	I14					X27 X36 X42 X50	25
192" X 69/42" AI14 BCX42 DI14	192	M14 I27					X27 X36 X42 X50 X27 X36 X42 X50	18 18
								
168" X 66/42" 192" X 69/42"	168						X27	28.5
Example ABX27 BCX27 CDX27	192						X27	28.5
								
216" X 73"/42"	216	I14	M14 M27 M36					26
Example AI14 BM36 CM36 DM36 EI14								
								
216" X 73"/42"	216						X27 X36	25.5 25
Example ABX36 BCX36 CDX36 DEX36								
								
216" X 73"/42"	216		M14 M27 M36				X27 X36 X42	30 25 22
Example ABX36 CM36 DEX36								
								
240" X 76"/42"	240	M14 I14 I27	M14 M27 M36 M42 M14 M27 M36 M42 M14 M27 M36 M42					18 31 18
Example AI14 BM42 CM42 DM42 EI14								
								

CODE KEY

M - Console location, middle of top section
 I - Console location, Inset 3" from seam on end sections
 X - Console location, across a seam of two top sections
 L - Console location, left side of a one piece top
 R - Console location, right side of a one piece top
 Y - Dimension from end of table to end of Console

Caution: Y greater than 30" makes access to Console Power/Data difficult from the end of the table

CONSOLE SIZE & LOCATIONS

See page 15 for information on console locations and size options for wood tops, and page 25 for laminate tops locations and sizes

CONSOLE MODULE OPTIONS

See page 49 for power / data options

ORDERING NOTES

Tops may be specified with fewer consoles and configurations other than shown. Consoles can be different sizes within the same top. Dimension from end of cut-out to table end cannot be less than 18".

NUVO | CONSOLE SIZE & LOCATION - VISIO & OVAL

Wood Top Console Options	Top Length	Console Options Top End Section	Console Options Within Top Center Section	Console Options Across Seam	Y
240" X 76"/42" Example ABX42 BCX42 CDX42 DEX42	240			X27 X36 X42	34.5 30 27
84" x 48" Example AM42	84	M14 M27 M36 M42			35 28.5 24 21
84" x 48" Example AL14 AR14	84	L14/R14			18
96" - 120" X 48" 96" X 54" AM14 ABX27 BM14	96 120	M14 M14		X27	18 23
96" - 120" X 48" 96" X 54" Example ABX42	96 120			X27 X36 X42 X50 X36 X42 X50	34.5 30 27 23 42 39 35
96" - 120" X 48" 96" X 54" AI36 BI36	96 120	I27 I27 I36			18 30 21

CODE KEY

M - Console location, middle of top section
 I - Console location, Inset 3" from seam on end sections
 X - Console location, across a seam of two top sections
 L - Console location, left side of a one piece top
 R - Console location, right side of a one piece top
 Y - Dimension from end of table to end of Console

Caution: Y greater than 30" makes access to Console Power/Data difficult from the end of the table

CONSOLE SIZE & LOCATIONS

See page 15 for information on console locations and size options for wood tops, and page 25 for laminate tops locations and sizes

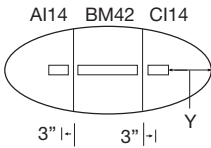
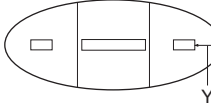
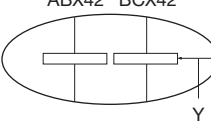
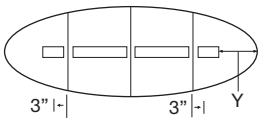
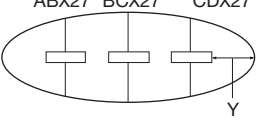
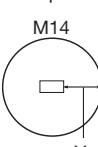
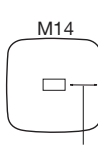
CONSOLE MODULE OPTIONS

See page 49 for power / data options

ORDERING NOTES

Tops may be specified with fewer consoles and configurations other than shown. Consoles can be different sizes within the same top. Dimension from end of cut-out to table end cannot be less than 18".

NUVO | CONSOLE SIZE & LOCATION - OVAL, ROUND, ARCED SQUARE

Wood Top Console Options	Top Length	Console Options Top End Section	Console Options Within Top Center Section	Console Options Across Seam	Y
144" X 54"	144	M14 I14 I27	M14 M27 M36 M42 M14 M27 M36 M42 M14 M27 M36 M42		18 31 18
Example AI14 BM42 CI14 					
120" - 144" X 60"	120	I14	M14 M27		23
Example AM14 BM42 CM14 	144	M14 I14 I27	M14 M27 M36 M42 M14 M27 M36 M42 M14 M27 M36 M42		18 31 18
120" - 144" X 60" 144" X 54"	120			X27	26.5
Example ABX42 BCX42 	144			X36 X42	30 27
168" X 60"	168	I14	M14 M27 M36		25
Example AI14 BM36 CM36 DI14 					
168" X 60"	168			X27 X36	28.5 24
Example ABX27 BCX27 CDX27 					
36" - 60"	36	M14			11
Examples M14 	42	M14			14
M14 	48	M14			17
	54	M14			20
	60	M14			23

CODE KEY

M - Console location, middle of top section
 I - Console location, Inset 3" from seam on end sections
 X - Console location, across a seam of two top sections
 L - Console location, left side of a one piece top
 R - Console location, right side of a one piece top
 Y - Dimension from end of table to end of Console

Caution: Y greater than 30" makes access to Console Power/Data difficult from the end of the table

CONSOLE SIZE & LOCATIONS

See page 15 for information on console locations and size options for wood tops, and page 25 for laminate tops locations and sizes

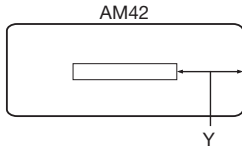
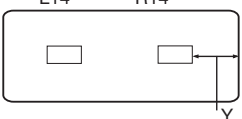
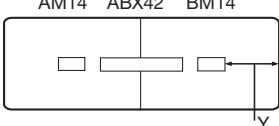
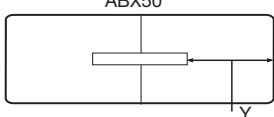
CONSOLE MODULE OPTIONS

See page 49 for power / data options

ORDERING NOTES

Tops may be specified with fewer consoles and configurations other than shown. Consoles can be different sizes within the same top. Dimension from end of cut-out to table end cannot be less than 18".

NUVO | CONSOLE SIZE & LOCATION - RECTANGULAR, ARC END, RACETRACK

Laminate Top Console Options	Top Length	Console Options Top End Section	Console Options Within Top Center Section	Console Options Across Seam	Y	
WIDTHS 36" - 48"	60	M14			23	
60" - 84" X 36", 42", 48"	72	M14			29	
96" X 36"		M27			22.5	
Example	78	M14			32	
		M27			25.5	
		M36			21	
		M42			18	
	84	M14			35	
		M27			28.5	
		M36			24	
		M42			21	
	96	M14			41	
		M27			34.5	
		M36			30	
		M42			27	
		M50			23	
<hr/>						
78" - 84" X 36", 42", 48"	78	L14 / R14			18	
96" X 36"	84	L14 / R14			18	
Example	96	L14 / R14			18	
						
<hr/>						
96" X 42", 48"	96	M14			18	
Example						
						
<hr/>						
96" X 42", 48"	96					
Example						
						
				X27	34.5	
				X36	30	
				X42	27	
			X50	23		

CODE KEY

M - Console location, middle of top section
 I - Console location, Inset 3" from seam on end sections
 X - Console location, across a seam of two top sections
 L - Console location, left side of a one piece top
 R - Console location, right side of a one piece top
 Y - Dimension from end of table to end of Console

Caution: Y greater than 30" makes access to Console Power/Data difficult from the end of the table

CONSOLE SIZE & LOCATIONS

See page 15 for information on console locations and size options for wood tops, and page 25 for laminate tops locations and sizes

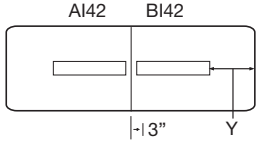
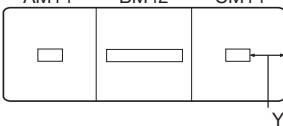
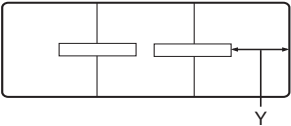
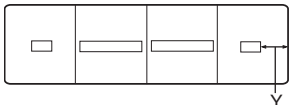
CONSOLE MODULE OPTIONS

See page 49 for power / data options

ORDERING NOTES

Tops may be specified with fewer consoles and configurations other than shown. Consoles can be different sizes within the same top. Dimension from end of cut-out to table end cannot be less than 18".

NUVO | CONSOLE SIZE & LOCATION - RECTANGULAR, ARC END, RACETRACK

Laminate Top Console Options	Top Length	Console Options Top End Section	Console Options Within Top Center Section	Console Options Across Seam	Y
WIDTHS 42" - 60"	96	I27			18
96" X 42", 48"					
Example					
					
108"-144" X 42", 48", 54", 60"	108	I14	M14 M27	19	
Example	120	M14 I14	M14 M27 M14 M27		23
	144	M14 I14 I27	M14 M27 M36 M42 M14 M27 M36 M42 M14 M27 M36 M42		18 31 18
108"-144" X 42", 48", 54", 60"	108			X27	22.5
Example	120			X27	26.5
	144			X36 X42	30 27
156"-192" X 48", 54", 60"	156	I14	M14 M27		22
Example	168	I14	M14 M27 M36		25
	192	M14 I14 I27	M14 M27 M36 M42 M14 M27 M36 M42 M14 M27 M36 M42		18 31 18

CODE KEY

M - Console location, middle of top section
 I - Console location, Inset 3" from seam on end sections
 X - Console location, across a seam of two top sections
 L - Console location, left side of a one piece top
 R - Console location, right side of a one piece top
 Y - Dimension from end of table to end of Console

Caution: Y greater than 30" makes access to Console Power/Data difficult from the end of the table

CONSOLE SIZE & LOCATIONS

See page 15 for information on console locations and size options for wood tops, and page 25 for laminate tops locations and sizes

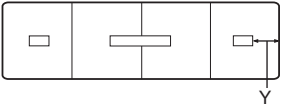
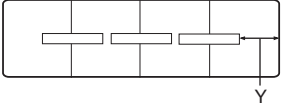
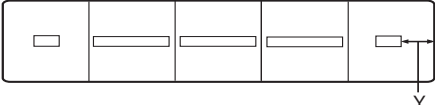
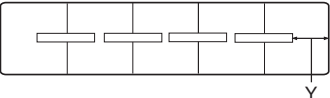
CONSOLE MODULE OPTIONS

See page 49 for power / data options

ORDERING NOTES

Tops may be specified with fewer consoles and configurations other than shown. Consoles can be different sizes within the same top. Dimension from end of cut-out to table end cannot be less than 18".

NUVO | CONSOLE SIZE & LOCATION - RECTANGULAR, ARC END, RACETRACK

Laminate Top Console Options	Top Length	Console Options Top End Section	Console Options Within Top Center Section	Console Options Across Seam	Y
WIDTHS 54" OR GREATER					
156" - 192" X 48" 54", 60"	156	I14		X27 X36 X42	22
Example	168	I14		X27 X36	25
AM14 BCX42 DM14	192	M14 I14 I27		X36 X42 X36 X42 X36 X42	18 31 18
					
<hr/>					
156" - 192" x 48" 54", 60"	156			X27 X36	25.5 21
Example	168			X27 X36	28.5 24
ABX42 BCX42 CDX42	192			X27 X36 X42	34.5 30 27
					
<hr/>					
216" - 240" X 54", 60"	216	I14	M14 M27 M36		26
	240	M14 14 I27	M14 M27 M36 M42 M14 M27 M36 M42 M14 M27 M36 M42		18 31 18
Example					
AM14 BM42 CM42 DM42 EM14					
					
<hr/>					
216" - 240" X 54", 60"	216			X27 X36	29.5 25
Example	240			X27 X36 X42	34.5 30 27
ABX42 BCX42 CDX42 DEX42					
					

CODE KEY

M - Console location, middle of top section
 I - Console location, Inset 3" from seam on end sections
 X - Console location, across a seam of two top sections
 L - Console location, left side of a one piece top
 R - Console location, right side of a one piece top
 Y - Dimension from end of table to end of Console

Caution: Y greater than 30" makes access to Console Power/Data difficult from the end of the table

CONSOLE SIZE & LOCATIONS

See page 15 for information on console locations and size options for wood tops, and page 25 for laminate tops locations and sizes

CONSOLE MODULE OPTIONS

See page 49 for power / data options

ORDERING NOTES

Tops may be specified with fewer consoles and configurations other than shown. Consoles can be different sizes within the same top. Dimension from end of cut-out to table end cannot be less than 18".

NUVO | CONSOLE SIZE & LOCATION - RECTANGULAR, ARC END, RACETRACK

Laminate Top Console Options	Top Length	Console Options Top End Section	Console Options Within Top Center Section	Console Options Across Seam	Y
WIDTHS 54" OR GREATER	216		M14 M27 M36	X27	29.5
216" - 240" X 54", 60"			M14 M27 M36	X36	25
			M14 M27 M36	X42	22
Example	240		M14 M27 M36 M42	X27	34.5
ABX42 CM42 DEX42			M14 M27 M36 M42	X36	30
			M14 M27 M36 M42	X42	27
			M14 M27 M36 M42	X50	23
<hr/>					
264" - 288" X 60"	264	M14			18
		I14	M14 M27 M36		27
Example					
AM14 BM42 CM42 DM42 EM42 FM14	288	M14	M14 M27 M36 M42		18
		I14	M14 M27 M36 M42		31
		I27	M14 M27 M36 M42		18
<hr/>					
264" - 288" X 60"	264	M14			18
		I14		X36 X42 X50	27
Example					
AM14 BCX42 DEX42 FM14	288	M14		X36 X42 X50	18
		I14		X36 X42 X50	31
		I27		X36 X42 X50	18
<hr/>					
264" - 288" X 60"	264			X27	30.5
				X36	26
Example					
ABX42 BCX42 CDX42 DEX42 EFX42	288			X27	34.5
				X36	30
				X42	27
<hr/>					
264" - 288" X 60"	264			X27	30.5
				X36	26
Example				X42	23
ABX42 CDX42 EFX42	288			X27	34.5
				X36	30
				X42	27
				X50	23

CODE KEY

M - Console location, middle of top section
 I - Console location, Inset 3" from seam on end sections
 X - Console location, across a seam of two top sections
 L - Console location, left side of a one piece top
 R - Console location, right side of a one piece top
 Y - Dimension from end of table to end of Console

Caution: Y greater than 30" makes access to Console Power/Data difficult from the end of the table

CONSOLE SIZE & LOCATIONS

See page 15 for information on console locations and size options for wood tops, and page 29 for laminate tops locations and sizes

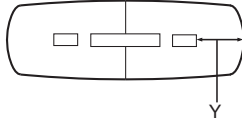
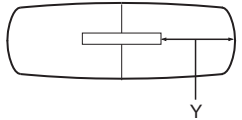
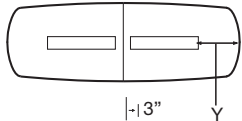
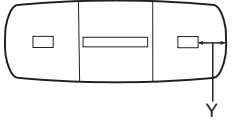
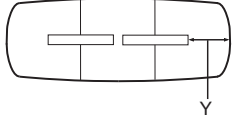
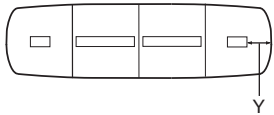
CONSOLE MODULE OPTIONS

See page 49 for power / data options

ORDERING NOTES

Tops may be specified with fewer consoles and configurations other than shown. Consoles can be different sizes within the same top. Dimension from end of cut-out to table end cannot be less than 18".

NUVO | CONSOLE SIZE & LOCATION - BOAT SHAPED

Laminate Top Console Options	Top Length	Console Options Top End Section	Console Options Within Top Center Section	Console Options Across Seam	Y
96" - 144" X 48"/42" 96" X 54"/42"	96	M14			18
Example AM14 ABX42 BM14					
					
96" - 144" X 48"/42" 96" X 54"/42"	96			X27 X36 X42 X50	34.5 30 27 23
Example ABX50					
					
96" - 144" X 48"/42" 96" X 54"/42"	96	I27			18
Example AI42 BI42					
					
120" - 144" x 54"/42"	120	I14	M14 M27		23
Example AM14 BM42 CM14	144	M14 I14 I27	M14 M27 M36 M42 M14 M27 M36 M42 M14 M27 M36 M42		18 31 18
					
120" - 144" x 54"/42"	120			X27 X36 X42	26.5 30 27
Example ABX42 BCX42	144				
					
168" - 192" X 54"/42"	168	I14	M14 M27 M36		25
Example AM14 BM42 CM42 DM14	192	M14 I14 I27	M14 M27 M36 M42 M14 M27 M36 M42 M14 M27 M36 M42		18 31 18
					

CODE KEY

M - Console location, middle of top section
 I - Console location, Inset 3" from seam on end sections
 X - Console location, across a seam of two top sections
 L - Console location, left side of a one piece top
 R - Console location, right side of a one piece top
 Y - Dimension from end of table to end of Console

Caution: Y greater than 30" makes access to Console Power/Data difficult from the end of the table

CONSOLE SIZE & LOCATIONS

See page 15 for information on console locations and size options for wood tops, and page 25 for laminate tops locations and sizes

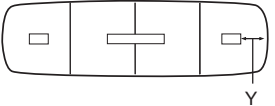
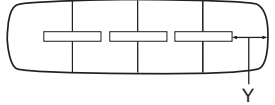
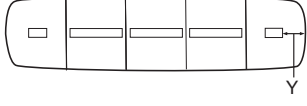
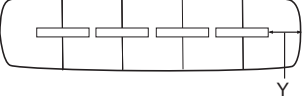
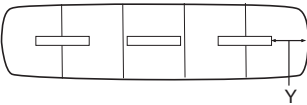
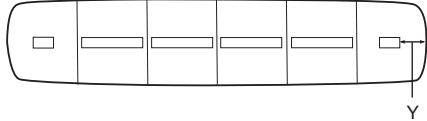
CONSOLE MODULE OPTIONS

See page 49 for power / data options

ORDERING NOTES

Tops may be specified with fewer consoles and configurations other than shown. Consoles can be different sizes within the same top. Dimension from end of cut-out to table end cannot be less than 18".

NUVO | CONSOLE SIZE & LOCATION - BOAT SHAPED

Laminate Top Console Options	Top Length	Console Options Top End Section		Console Options Within Top Center Section				Console Options Across Seam			Y
168" - 192" X 54"/42"	168	I14						X27	X36	X42	25
Example	192	M14						X36	X42		18
AM14 BCX42 DM14		I14						X36	X42		31
		I27						X36	X42		18
168" - 192" X 54"/42"	168							X27			28.5
Example	192							X36			24
ABX42 BCX42 CDX42								X27			34.5
								X36			30
								X42			27
216" - 240" X 60"/48"	216	I14	M14	M27	M36						26
Example	240	M14	M14	M27	M36	M42					18
AM14 BM42 CM42 DM42 EM14		I14	M14	M27	M36	M42					31
		I27	M14	M27	M36	M42					18
216" - 240" X 60"/48"	216							X27			29.5
Example	240							X36			24
ABX42 BCX42 CDX42 DEX42								X27			34.5
								X36			30
								X42			27
216" - 240" X 60"/48"	216		M14	M27	M36		X27				29.5
Example	240		M14	M27	M36		X36				25
ABX42 CM42 DEX42			M14	M27	M36		X42				22
			M14	M27	M36	M42	X27				34.5
			M14	M27	M36	M42	X36				30
			M14	M27	M36	M42	X42				27
			M14	M27	M36	M42	X50				23
264" - 288" X 60"/48"	264	M14									18
Example	288	I14	M14	M36							27
AM14 BM42 CM42 DM42 EM42 FM14		M14	M14	M36	M42						18
		I14	M14	M36	M42						31
		I27	M14	M36	M42						18

CODE KEY

- M - Console location, middle of top section
- I - Console location, Inset 3" from seam on end sections
- X - Console location, across a seam of two top sections
- L - Console location, left side of a one piece top
- R - Console location, right side of a one piece top
- Y - Dimension from end of table to end of Console

Caution: Y greater than 30" makes access to Console Power/Data difficult from the end of the table

CONSOLE SIZE & LOCATIONS

See page 15 for information on console locations and size options for wood tops, and page 25 for laminate tops locations and sizes

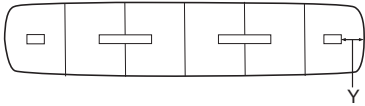
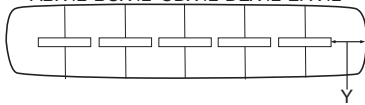
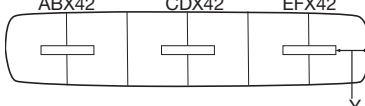
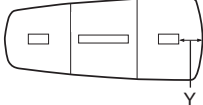
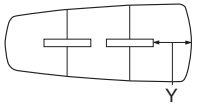
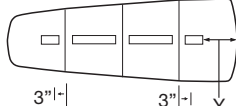
CONSOLE MODULE OPTIONS

See page 49 for power / data options

ORDERING NOTES

Tops may be specified with fewer consoles and configurations other than shown. Consoles can be different sizes within the same top. Dimension from end of cut-out to table end cannot be less than 18".

NUVO | CONSOLE SIZE & LOCATION - BOAT SHAPED & VISIO

Laminate Top Console Options	Top Length	Console Options Top End Section	Console Options Within Top Center Section	Console Options Across Seam	Y
264" - 288" X 60"/48"	264	M14 I14		X36 X42 X50	18 27
Example AM14 BCX42 DEX42 FM14	288	M14 I14 I27		X36 X42 X50 X36 X42 X50	18 31 18
					
264" - 288" X 60"/48"	264			X27 X36	30.5 26
Example ABX42 BCX42 CDX42 DEX42 EFX42	288			X27 X36 X42	34.5 30 27
					
264" - 288" X 60"/48"	264			X27 X36 X42	30.5 26 23
Example ABX42 CDX42 EFX42	288			X27 X36 X42 X50	34.5 30 27 23
					
120" - 144" X 60"/42"	120	I14	M14 M27		23
Example AM14 BM42 CM14	144	M14 I27	M14 M27 M36 M42 M14 M27 M36 M42		18 18
					
120" - 144" X 60/42	120			X27	26.5
Example ABX42 BCX42	144			X36 X42	30 27
					
168" X 66/42" 192" X 69/42"	168	I14	M14 M27 M36		25
AI14 BM42 CM42 DI14	192	M14 I27	M14 M27 M36 M42 M14 M27 M36 M42		18 18
					

CODE KEY

M - Console location, middle of top section
 I - Console location, Inset 3" from seam on end sections
 X - Console location, across a seam of two top sections
 L - Console location, left side of a one piece top
 R - Console location, right side of a one piece top
 Y - Dimension from end of table to end of Console

Caution: Y greater than 30" makes access to Console Power/Data difficult from the end of the table

CONSOLE SIZE & LOCATIONS

See page 15 for information on console locations and size options for wood tops, and page 25 for laminate tops locations and sizes

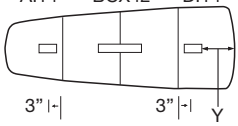
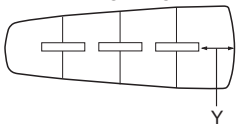
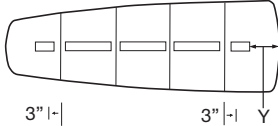
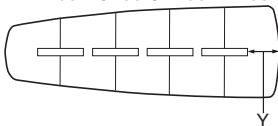
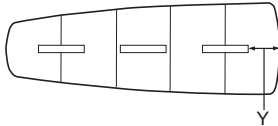
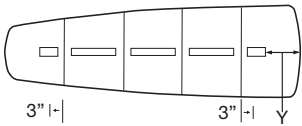
CONSOLE MODULE OPTIONS

See page 49 for power / data options

ORDERING NOTES

Tops may be specified with fewer consoles and configurations other than shown. Consoles can be different sizes within the same top. Dimension from end of cut-out to table end cannot be less than 18".

NUVO | CONSOLE SIZE & LOCATION - VISIO

Laminate Top Console Options	Top Length	Console Options Top End Section	Console Options Within Top Center Section	Console Options Across Seam	Y
168" X 66/42"	168	I14		X27 X36 X42 X50	25
192" X 69/42"	192	M14 I27		X27 X36 X42 X50	18 18
					
168" X 66/42" 192" X 69/42"	168			X27	28.5
Example ABX27 BCX27 CDX27	192			X27	28.5
					
216" X 73"/42"	216	I14	M14 M27 M36		26
Example AI14 BM36 CM36 DM36 EI14					
					
216" X 73"/42"	216			X27 X36	25.5 25
					
216" X 73"/42"	216		M14 M27 M36 M14 M27 M36 M14 M27 M36	X27 X36 X42	30 25 22
Example ABX36 CM36 DEX36					
					
240" X 76"/42"	240	M14 I14 I27	M14 M27 M36 M42 M14 M27 M36 M42 M14 M27 M36 M42		18 31 18
Example AI14 BM42 CM42 DM42 EI14					
					

CODE KEY

- M - Console location, middle of top section
- I - Console location, Inset 3" from seam on end sections
- X - Console location, across a seam of two top sections
- L - Console location, left side of a one piece top
- R - Console location, right side of a one piece top
- Y - Dimension from end of table to end of Console

Caution: Y greater than 30" makes access to Console Power/Data difficult from the end of the table

CONSOLE SIZE & LOCATIONS

See page 15 for information on console locations and size options for wood tops, and page 25 for laminate tops locations and sizes

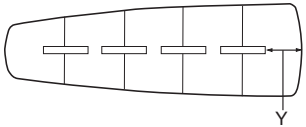
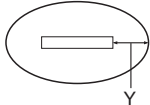
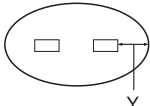
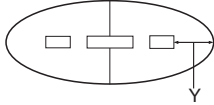
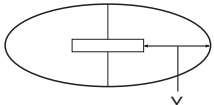
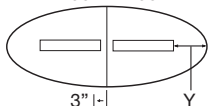
CONSOLE MODULE OPTIONS

See page 49 for power / data options

ORDERING NOTES

Tops may be specified with fewer consoles and configurations other than shown. Consoles can be different sizes within the same top. Dimension from end of cut-out to table end cannot be less than 18".

NUVO | CONSOLE SIZE & LOCATION - VISIO & OVAL

Laminate Top Console Options	Top Length	Console Options Top End Section	Console Options Within Top Center Section	Console Options Across Seam	Y
240" X 76"/42" Example ABX42 BCX42 CDX42 DEX42	240			X27 X36 X42	34.5 30 27
					
84" x 48" Example AM42	84	M14 M27 M36 M42			35 28.5 24 21
					
84" x 48" Example AL14 AR14	84	L14/R14			18
					
96" - 120" X 48" 96" X 54" AM14 ABX27 BM14	96 120	M14 M14		X27	18 23
					
96" - 120" X 48" 96" X 54" Example ABX42	96 120			X27 X36 X42 X50 X36 X42 X50	34.5 30 27 23 42 39 35
					
96" - 120" X 48" 96" X 54" AI36 BI36	96 120	I27 I36			18 30 21
					

CODE KEY

M - Console location, middle of top section
 I - Console location, Inset 3" from seam on end sections
 X - Console location, across a seam of two top sections
 L - Console location, left side of a one piece top
 R - Console location, right side of a one piece top
 Y- Dimension from end of table to end of Console

Caution: Y greater than 30" makes access to Console Power/Data difficult from the end of the table

CONSOLE SIZE & LOCATIONS

See page 15 for information on console locations and size options for wood tops, and page 25 for laminate tops locations and sizes

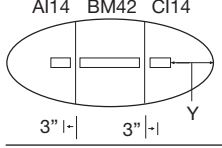
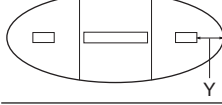
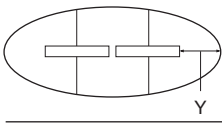
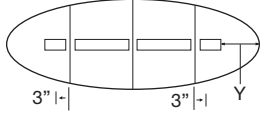
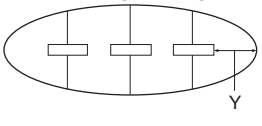
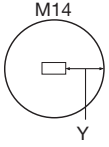
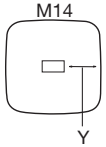
CONSOLE MODULE OPTIONS

See page 49 for power / data options

ORDERING NOTES

Tops may be specified with fewer consoles and configurations other than shown. Consoles can be different sizes within the same top. Dimension from end of cut-out to table end cannot be less than 18".

NUVO | CONSOLE SIZE & LOCATION - OVAL, ROUND, ARCED SQUARE

Laminate Top Console Options	Top Length	Console Options Top End Section	Console Options Within Top Center Section	Console Options Across Seam	Y
144" X 54"	144	M14 I14 I27	M14 M27 M36 M42 M14 M27 M36 M42 M14 M27 M36 M42		18 31 18
Example AI14 BM42 CI14					
					
120" - 144" X 60"	120	I14	M14 M27		23
Example	144	M14 I14 I27	M14 M27 M36 M42 M14 M27 M36 M42 M14 M27 M36 M42		18 31 18
Example AM14 BM42 CM14					
					
120" - 144" X 60" 144" X 54"	120			X27	26.5
Example	144			X36 X42	30 27
Example ABX42 BCX42					
					
168" X 60"	168	I14	M14 M27 M36		25
Example					
Example AI14 BM36 CM36 DI14					
					
168" X 60"	168			X27 X36	28.5 24
Example					
Example ABX27 BCX27 CDX27					
					
36" - 60"	36	M14			11
Examples	42	M14			14
	48	M14			17
	54	M14			20
	60	M14			23

CODE KEY

M - Console location, middle of top section
 I - Console location, Inset 3" from seam on end sections
 X - Console location, across a seam of two top sections
 L - Console location, left side of a one piece top
 R - Console location, right side of a one piece top
 Y - Dimension from end of table to end of Console

Caution: Y greater than 30" makes access to Console Power/Data difficult from the end of the table

CONSOLE SIZE & LOCATIONS

See page 15 for information on console locations and size options for wood tops, and page 25 for laminate tops locations and sizes

CONSOLE MODULE OPTIONS

See page 49 for power / data options


ORDERING NOTES

Tops may be specified with fewer consoles and configurations other than shown. Consoles can be different sizes within the same top. Dimension from end of cut-out to table end cannot be less than 18".

NUVO | CONSOLES FOR WOOD & LAMINATE TOPS

CONSOLE - WITHIN A TOP SECTION


Consoles located within a top section are factory installed. The model numbers are determined by the location within each section and the size. For example, when ordering a rectangular top 96" x 54" a console M14 can be specified in both the A and/or B section of the table. When ordering, simply add AM14 and BM14 to your purchase order and add the list price for each console to your order.

Description	Model	Console size	Price	Weights	Cubes
	M14, I14, L14,R14	14	265	3	.25
	M27, I27	27	295	4	.25
	M36, I36	36	333	5	.25
	M42, I42	42	363	5.5	0.5
	M50, I50	50	402	6	0.5

Consoles are available in 5 standard lengths.

CONSOLE - ACROSS SEAMS

Consoles located across the seam are field installed and have separate model numbers that need to be included on your purchase order along with the desired console position. For example, when ordering a rectangular top 120" x 54" with a console across the seam, purchase orders need to specify the model number for the console (51CONSOLEX27) and the location ABX27.

Description	Model	Console size	Price	Weights	Cubes
	51CONSOLE-X14	14	265	3	0.25
	51CONSOLE-X27	27	295	4	0.25
	51CONSOLE-X36	36	333	5	0.25
	51CONSOLE-X42	42	363	5.5	0.5
	51CONSOLE-X50	50	402	6	0.5

Consoles are available in 5 standard lengths.

Note: 50" Consoles have 3 lid supports, while all other sized have 2.

CONSOLE POWER/DATA MODULES

Console modules provide an extensive range of power, data and audio-visual solutions for today's conferencing environments. Console modules are available in 18 preconfigured data and power options, or alternatively console modules with just electrical ports can be selected allowing units to be designed and built specifically to meet your connectivity needs by using the Snap-in or Plate mounted port options.

Consoles are available with 3 power options in both preconfigured & custom console modules.

Power Module A (PMA) consists of 2 duplex receptacles with 3 cord lengths 6', 16' & 25'.

Power Module B (PMB) consists of 1 duplex receptacle with 3 cord lengths 6', 16' & 25'.

Power Module C (PMC) consists of 2 duplex receptacles with a utility outlet & circuit breaker with 2 cord lengths 6' & 16'.

The utility outlet in Module C allows another power module within the table to be plugged into it resulting in 1 cord going to the power source for both modules, as well as circuit protection for both modules. This also means shorter cord lengths can be specified resulting in a more cost effective power solution. Krug recommends the use of Module C's on the Console at the end of the table or location in the table nearest the power source.

Examples:

120" table with 2 consoles & the power source at right end.

Use a PMC06 in the 1st console from the right & the cord goes to power source.

Use a PMA06 in the 2nd console from the right & the cord goes to the utility outlet of the first console module.

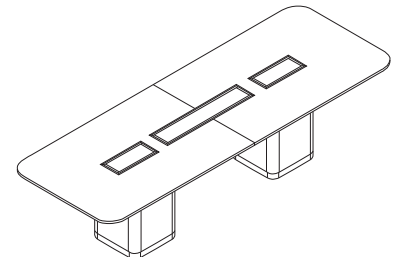
168" table with 4 consoles & power source at right hand end.

Use a PMC06 in the 1st console from the right & the cord goes to power source.

Use a PMC06 in the 2nd console from the right & the cord goes to power source.

Use a PMA06 in the 3rd console from the right & the cord goes to utility the outlet in the 1st console module.

Use a PMA06 in the 4th console from the right & the cord goes to utility the outlet in the 2nd console module.



CODE KEY

M - Console location, middle of top section

I - Console location, Inset 3" from seam on end sections

X - Console location, across a seam of two top sections

L - Console location, left side of a one piece top

R - Console location, right side of a one piece top

Y - Dimension from end of table to end of Console

Caution: Y greater than 30" makes access to Console Power/Data difficult from the end of the table

CONSOLE SIZE & LOCATIONS

See page 15 for information on console locations and size options for wood tops, and page 25 for laminate tops locations and sizes


CONSOLE MODULE OPTIONS

See page 49 for power / data options

ORDERING NOTES

Tops may be specified with fewer consoles and configurations other than shown. Consoles can be different sizes within the same top. Dimension from end of cut-out to table end cannot be less than 18".

NUVO | BACK-PAINTED GLASS RECTANGULAR CONFERENCE TOPS

Description	Model	Glass	L	W	Table Sections	Approximate Seating	Shipping Weight	Cubic Feet
Rectangular- Rounded Corners	5161GP6036	5667	60	36	1	4	190	42
	5161GP6042	6612	60	42	1	4	220	49
	5161GP6048	7556	60	48	1	4	250	53
	5161GP7236	6802	72	36	1	6	226	50
	5161GP7242	7935	72	42	1	6	262	58
	5161GP7248	9067	72	48	1	6	296	66
	5161GP7836	7369	78	36	1	6	244	55
	5161GP7842	8596	78	42	1	6	284	63
	5161GP7848	9817	78	48	1	6	322	72
	5161GP8436	7935	84	36	1	6	262	59
	5161GP8442	9258	84	42	1	6	304	68
	5161GP8448	10571	84	48	1	6	346	77
	5161GP9636	9067	96	36	1	8	300	67
	5161GP9642	10578	96	42	2	8	350	39
	5161GP9648	12018	96	48	2	8	396	45
5161GP10842	11949	108	42	2	8	390	44	
5161GP10848	13641	108	48	2	8	444	50	
5161GP12042	14119	120	42	2	8	432	49	
5161GP12048*	16086	120	48	2	10	494	56	
5161GP12054	18154	120	54	3	10	556	40	
5161GP12060	20170	120	60	3	10	614	47	
5161GP14448	19365	144	48	2	10	594	66	
5161GP14454	21785	144	54	3	12	666	50	
5161GP14460	24203	144	60	3	12	738	56	
5161GP15654	23599	156	54	3	12	724	54	
5161GP15660	26221	156	60	3	12	802	60	
5161GP16848	22590	168	48	3	12	694	52	
5161GP16854	25414	168	54	4	12	780	44	
5161GP16860	28238	168	60	4	12	862	49	
5161GP19248	25818	192	48	3	14	794	59	
5161GP19254	29046	192	54	4	14	890	50	
5161GP19260	32272	192	60	4	14	984	56	

NOTE: Support Beams are included in top price. An additional line item for the support beam will be included on the order acknowledgment at no charge.

RECTANGULAR - SQUARE CORNER TOPS:

Rectangular tops with square corners are available. Replace the model prefix with **5101GP**. e.g. **5161GP14448** becomes **5101GP14448**. Pricing is the same as standard tops.

ORDERING PROCEDURES

To order, please specify the following:

- 1) Table top shape, size, model number, glass color
- 2) Base model number
- 3) Console location and size option
- 4) Cross seam console model number, where applicable
- 5) Console power module and data options

DIMENSION KEY

L - length

W - Width

Dimensions are in inches and approximate.

Contact Customer Service if dimensions are critical.

BASE REQUIREMENTS

See page 60 for base requirements

CONSOLE SIZE & LOCATIONS

See page 41 for information on Console locations and size options


CONSOLE POWER/DATA MODULE OPTIONS

See page 49 for Console Module Options

TABLE SECTION SIZE

Section sizes can be calculated by dividing the table length by the # of sections

NUVO | BACK-PAINTED GLASS ARC END CONFERENCE TOPS

Description	Model	Glass	L	W	Table Sections	Approximate Seating	Shipping Weight	Cubic Feet
Arc End Table - Rounded Corners	5166GP6036	5758	60	36	1	4	178	42
	5166GP6042	6717	60	42	1	4	206	49
	5166GP6048	7679	60	48	1	4	234	53
	5166GP7236	6911	72	36	1	6	214	50
	5166GP7242	8061	72	42	1	6	246	58
	5166GP7248	9213	72	48	1	6	280	66
	5166GP7836	8061	78	36	1	6	232	55
	5166GP7842	8709	78	42	1	6	268	63
	5166GP7848	10096	78	48	1	6	306	72
	5166GP8436	8149	84	36	1	6	250	59
	5166GP8442	9516	84	42	1	6	288	68
	5166GP8448	10874	84	48	1	6	328	77
	5166GP9636	9322	96	36	1	8	288	67
	5166GP9642	10874	96	42	2	8	334	39
	5166GP9648*	12428	96	48	2	8	380	45
	5166GP10842	12233	108	42	2	8	376	44
	5166GP10848	13982	108	48	2	8	428	50
	5166GP12042	15231	120	42	2	10 (8)	422	49
5166GP12048	16096	120	48	2	10	478	56	
5166GP12054	18154	120	54	3	10	536	40	
5166GP12060	20170	120	60	3	10	594	47	
5166GP14448	19365	144	48	2	10	578	66	
5166GP14454	21785	144	54	3	12	648	50	
5166GP14460	24203	144	60	3	12	718	56	
5166GP15654	23599	156	54	3	12 (10)	706	54	
5166GP15660	26221	156	60	3	12	780	60	
5166GP16848	22590	168	48	3	12	676	52	
5166GP16854	25414	168	54	4	12	760	44	
5166GP16860	28238	168	60	4	12	842	49	
5166GP19248	25818	192	48	3	14	776	59	
5166GP19254	29046	192	54	4	14	870	50	
5166GP19260	32272	192	60	4	14	964	56	

NOTE: Support Beams are included in top price. An additional line item for the support beam will be included on the order acknowledgment at no charge.

ARC END TABLE - SQUARE CORNERS:

Arc End tops are available with square corners. Replace the model number prefix with **5106GP**. e.g. **5166GP12042** becomes **5106GP12042**. Pricing is the same as standard tops.

SEATING CAPACITY:

The number in brackets is the seating capacity when formed metal legs are used if different than the seating capacity when other bases are used.

ORDERING PROCEDURES

To order, please specify the following:

- 1) Table top shape, size, model number, glass color
- 2) Base model number
- 3) Console location and size option
- 4) Cross seam console model number, where applicable
- 5) Console power module and data options

DIMENSION KEY

L - Length

W - Width

Dimensions are in inches and approximate.

Contact Customer Service if dimensions are critical.

BASE REQUIREMENTS

See page 60 for base requirements

CONSOLE SIZE & LOCATIONS

See page 45 for information on Console locations and size options

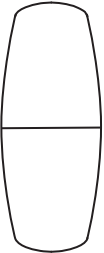
CONSOLE POWER/DATA MODULE OPTIONS

See page 49 for Console Module Options

TABLE SECTION SIZE

Section sizes can be calculated by dividing the table length by the # of sections

NUVO | BACK-PAINTED GLASS BOAT SHAPED & VISIO CONFERENCE TOPS

Description	Model	Glass	L	W	Table Sections	Approximate Seating	Shipping Weight	Cubic Feet
Boat-Shaped - Arc End Rounded Corners 	5164GP964842	12675	96	48/42	2	8	362	45
	5164GP965442*	14262	96	54/42	2	8	408	50
	5164GP1204842	16417	120	48/42	2	8	458	56
	5164GP1205442	18517	120	54/42	3	10 (8)	514	40
	5164GP1444842	19752	144	48/42	2	10	552	66
	5164GP1445442	22219	144	54/42	3	12	622	50
	5164GP1685442	25923	168	54/42	4	12	732	44
	5164GP1925442	29625	192	54/42	4	14	838	50

NOTE: Support Beams are included in top price. An additional line item for the support beam will be included on the order acknowledgment at no charge.

BOAT SHAPE - ARC END, SQUARE CORNERS:

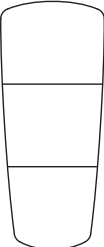
Boat Shape tops are available with Arc ends and Square corners. For Arc End, Square Corner tops replace model suffix with **5154GP**. e.g. **5164GP1204842** becomes **5154GP1204842**. Pricing is the same as standard tops.

BOAT SHAPE - STRAIGHT END, SQUARE CORNERS:

Boat Shape tops are available with Straight ends and square corners. For Straight End, Square Corner tops replace model suffix with **5104GP**. e.g. **5164GP1204842** becomes **5104GP1204842**. Pricing is the same as standard tops.

SEATING CAPACITY:

The number in brackets is the seating capacity when formed metal legs are used if different than the seating capacity when other bases are used.

Visio - Arc End Rounded Corners 	5168GP1206042	20314	120	60/42	3	8	536	47
	5168GP1446042*	22002	144	60/42	3	10	646	56
	5168GP1686642	31295	168	66/42	4	13	814	62
	5168GP1926942	37391	192	69/42	4	15	964	73

NOTE: Support Beams are included in top price. An additional line item for the support beam will be included on the order acknowledgment at no charge.

VISIO - ARC END, SQUARE CORNERS:

Visio Shape Tops with Arc Ends are available with square corners. For Arc End-Square corners, replace the model suffix with **5158GP**. e.g. **5168GP1446042** becomes **5158GP1446042**. Pricing is the same as standard tops.

VISIO - STRAIGHT END, SQUARE CORNERS:

Visio Shape Tops with Straight Ends are available with square corners. For Arc Straight End-Square corners, replace the model suffix with **5108GP**. e.g. **5168GP1446042** becomes **5108GP1446042**. Pricing is the same as standard tops.

ORDERING PROCEDURES

To order, please specify the following:

- 1) Table top shape, size, model number, glass color
- 2) Base model number
- 3) Console location and size option
- 4) Cross seam console model number, where applicable
- 5) Console power module and data options

DIMENSION KEY

L - Length

W - Width

Dimensions are in inches and approximate.

Contact Customer Service if dimensions are critical.

BASE REQUIREMENTS

See page 60 for base requirements

CONSOLE SIZE & LOCATIONS

See page 41 for information on Console locations and size options

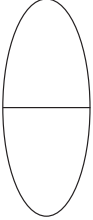
CONSOLE POWER/DATA MODULE OPTIONS

See page 49 for Console Module Options

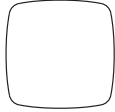
TABLE SECTION SIZE

Section sizes can be calculated by dividing the table length by the # of sections

NUVO | BACK-PAINTED GLASS OVAL, ARCED SQUARE & ROUND CONFERENCE TOPS

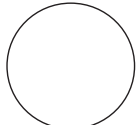
Description	Model	Glass	L	W	Table Sections	Approximate Seating	Shipping Weight	Cubic Feet	
	Oval Top	5159GP8448	11118	84	48	1	6	272	77
		5159GP9648	11967	96	48	2	8	314	45
		5159GP9654	14679	96	54	2	8	352	50
		5159GP12048*	16258	120	48	2	8	392	56
		5159GP12060	20314	120	60	3	10	486	40
		5159GP14454	21947	144	54	3	10	528	50
		5159GP14460	22002	144	60	3	12	584	56
		5159GP16860	28448	168	60	4	12	682	49

NOTE: Support Beams are included in top price. An additional line item for the support beam will be included on the order acknowledgment at no charge.

	Arced Square Top	5166GP3636	3456	36	36	1	4	118	31
		5166GP4242	4705	42	42	1	4	158	41
		5166GP4848	6141	48	48	1	4	202	52
		5166GP5454	7865	54	54	1	4	254	64

ARC SQUARE TOP - SQUARE CORNERS

Arc Square tops are available with square corners. For Square Corner tops replace model suffix with **5156GP**. e.g. **5166GP4242** becomes **5156GP4242**. Pricing is the same as standard tops.

	Round Top	5105GP36	3523	36 Dia.		1	3	94	31
		5105GP42	4795	42 Dia.		1	3	126	41
		5105GP48	6266	48 Dia.		1	4	160	52
		5105GP54	8024	54 Dia.		1	5	200	64

ORDERING PROCEDURES

To order, please specify the following:

- 1) Table top shape, size, model number, glass color
- 2) Base model number
- 3) Console location and size option
- 4) Cross seam console model number, where applicable
- 5) Console power module and data options

DIMENSION KEY

L - Length

W - Width

Dimensions are in inches and approximate.

Contact Customer Service if dimensions are critical.

BASE REQUIREMENTS

See page 60 for base requirements

CONSOLE SIZE & LOCATIONS

See page 41 for information on Console locations and size options

CONSOLE POWER/DATA MODULE OPTIONS

See page 49 for Console Module Options

TABLE SECTION SIZE

Section sizes can be calculated by dividing the table length by the # of sections

NUVO | CONSOLE PLANNING FOR BACK-PAINTED GLASS TOPS

CONSOLE ORDERING CODE (WITHIN THE TABLE SECTION - 4 CHARACTER CODE)

1st character specifies top sections from left to right on table: A, B, C, D

2nd character specifies console location within top section: M, L, R

M- Middle of top on one piece table

M- Middle of top section on multi section table

L- Left side of a one piece top

R- Right side of a one piece top

3rd and 4th characters specify console size: 14, 27, 36,

Examples:

Table Size: 96" x 36"

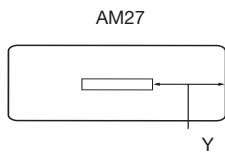


Table Size: 168" x 48"

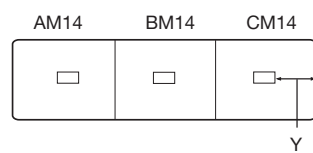


Table Size: 96 "x 36"

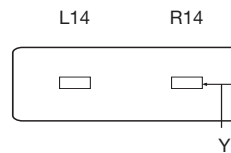
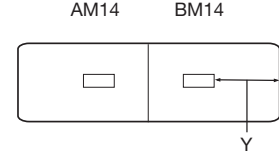


Table Size: 144" x 48"



Y= Dimension from end of table to end of console

CONSOLE ORDERING CODE (ACROSS SEAM - 5 CHARACTER CODE)

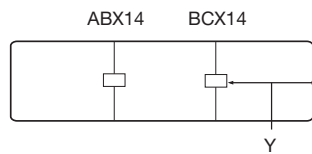
1st and 2nd character specifies section from left to right on table: AB, BC, CD

3rd character specifies console location across the seam: X

4th and 5th characters specify console size: 14, 27, 36,

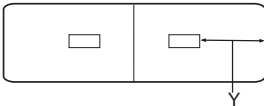
Example:

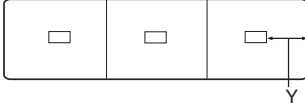
Table Size 168" - 192" X 48"



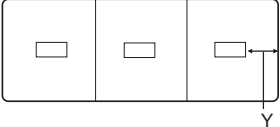
Y= Dimension from end of table to end of console

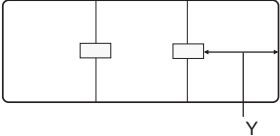
NUVO | CONSOLE SIZE & LOCATION - RECTANGULAR, ARC END, RACETRACK & BOAT SHAPED

Back-Painted Glass Console Options	Top Length	Console Options Top End Section	Console Options Within Top Center Section	Console Options Across Seam	Y
96" - 144" X 42", 48"	96	*M14			18
Example	108	M14			20
AM14 BM14	120	M14			23
	144	M14			29
*The "M" position of these consoles is not exactly in the center of the section.					

168" - 192" X 48"	168	M14	M14		21
Example	192	M14	M14		25
AM14 BM14 CM14					

168" - 192" X 48"	168			X14	49
Example	192			X14	57
ABX14 BCX14					

GLASS TOP WIDTHS 54" OR GREATER	Top Length	Console Options Top End Section	Console Options Within Top Center Section	Console Options Across Seam	Y
120" - 156" X 54", 60"	120	*M14	M14		18
Example	144	*M14	M14		18
AM14 BM14 CM14	156	M14	M14		19
*The "M" position of these consoles is not exactly in the center of the section.					
					

120" - 156" X 54", 60"	120			X14	33
Example	144			X14	41
ABX14 BCX14	156			X14	45
					

CODE KEY
M - Console location, middle of top section
X - Console location, across a seam of two top sections
L - Console location, left side of a one piece top
R - Console location, right side of a one piece top
Y - Dimension from end of table to end of Console
Caution: Y greater than 30" makes access to Console Power/Data difficult from the end of the table

CONSOLE POWER/DATA MODULE OPTIONS
See page 49 for Console Module Options

ORDERING NOTES
Tops may be specified with fewer consoles and configurations other than shown. Consoles can be different sizes within the same top. Dimension from end of cut-out to table end cannot be less than 18".

NUVO | CONSOLE SIZE & LOCATION - RECTANGULAR, ARC END, RACETRACK & BOAT SHAPED

Back-Painted Glass Console Options	Top Length	Console Options Top End Section	Console Options Within Top Center Section	Console Options Across Seam	Y
168"-192" X 54", 60"	168	*M14	M14		18
Example	192	M14	M14		18
AM14 BM14 CM14 DM14					
		*The "M" position of these consoles is not exactly in the center of the section.			
168" - 192" X 54", 60"	168	*M14		X14 X27	18
Example	192	M14		X14 X27	18 18
AM14 BCX14 DM14					
		*The "M" position of these consoles is not exactly in the center of the section.			
96" - 144" X 48"/42" 96" X 54"/42"	96	*M14			18
Example	120	M14		X14	23
AM14 ABX14 BM14	144	M14		X14	29
		*The "M" position of these consoles is not exactly in the center of the section.			
96" - 144" X 48"/42" 96" X 54"/42"	96			X14 X27	41 34.5
Example	120			X14 X36 X27	53 42 46.5
ABX36	144			X14 X27 X36	65 58.5 54
		*The "M" position of these consoles is not exactly in the center of the section.			
96" - 144" X 48"/42" 96" X 54"/42"	96	*M14			18
Example	120	M14			23
AM14 BM14	144	M14			29
		*The "M" position of these consoles is not exactly in the center of the section.			

CODE KEY

M - Console location, middle of top section
 X - Console location, across a seam of two top sections
 L - Console location, left side of a one piece top
 R - Console location, right side of a one piece top
 Y- Dimension from end of table to end of Console

Caution: Y greater than 30" makes access to Console Power/Data difficult from the end of the table.

CONSOLE POWER/DATA MODULE OPTIONS

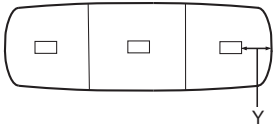
See page 49 for Console Module Options

ORDERING NOTES

Tops may be specified with fewer consoles and configurations other than shown. Consoles can be different sizes within the same top. Dimension from end of cut-out to table end cannot be less than 18".

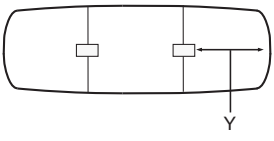
NUVO | CONSOLE SIZE & LOCATION - BOAT SHAPED

Back-Painted Glass Top Console Options	Top Length	Console Options Top End Section	Console Options Within Top Center Section	Console Options Across Seam	Y
120" - 144" x 54"/42"	120	*M14	M14		18
Example AM14 BM14 CM14	144	*M14	M14		18

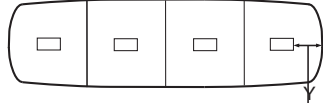


*The "M" position of these consoles is not exactly in the center of the section.

120" - 144" x 54"/42"	120			X14	33
Example ABX14 BCX14	144			X14	41

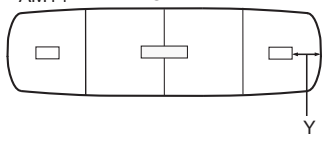


168" - 192" X 54"/42"	168	*M14	M14		18
Example AM14 BM14 CM14 DM14	192	M14	M14		18



*The "M" position of these consoles is not exactly in the center of the section.

168" - 192" X 54"/42"	168	*M14		X14 X27	18
Example AM14 BCX27 DM14	192	*M14		X14 X27	18



*The "M" position of these consoles is not exactly in the center of the section.

CODE KEY

M - Console location, middle of top section
 X - Console location, across a seam of two top sections
 L - Console location, left side of a one piece top
 R - Console location, right side of a one piece top
 Y - Dimension from end of table to end of Console

Caution: Y greater than 30" makes access to Console Power/Data difficult from the end of the table

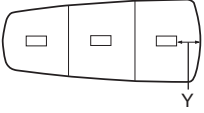
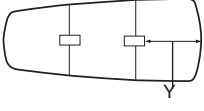
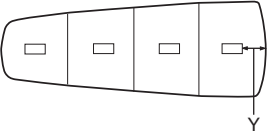
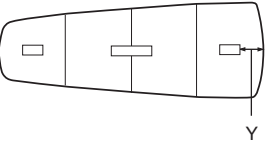
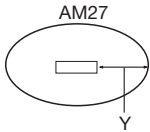
CONSOLE POWER/DATA MODULE OPTIONS

See page 49 for Console Module Options

ORDERING NOTES

Tops may be specified with fewer consoles and configurations other than shown. Consoles can be different sizes within the same top. Dimension from end of cut-out to table end cannot be less than 18".

NUVO | CONSOLE SIZE & LOCATION - VISIO & OVAL

Back-Painted Glass Top Console Options	Top Length	Console Options Top End Section	Console Options Within Top Center Section	Console Options Across Seam	Y
120" - 144" X 60"/42"	120	*M14	M14		18
Example AM14 BM14 CM14	144	M14	M14		18
					
		*The "M" position of these consoles is not exactly in the center of the section.			
120" - 144" X 60/42	120			X14	33
Example ABX14 BCX14	144			X14	41
					
168" X 66/42" 192" X 69/42"	168	*M14	M14		18
AM14 BM14 CM14 DM14	192	M14			18
					
		*The "M" position of these consoles is not exactly in the center of the section.			
168" X 66/42" 192" X 69/42"	168	*M14		X14 X27	18
AM14 BCX27 DM14	192	*M14		X14 X27	18
					
		*The "M" position of these consoles is not exactly in the center of the section.			
84" x 48"	84	M14 M27			35 28.5
Example AM27					
					

CODE KEY

M - Console location, middle of top section
 X - Console location, across a seam of two top sections
 L - Console location, left side of a one piece top
 R - Console location, right side of a one piece top
 Y - Dimension from end of table to end of Console

Caution: Y greater than 30" makes access to Console Power/Data difficult from the end of the table

CONSOLE POWER/DATA MODULE OPTIONS

See page 49 for Console Module Options

ORDERING NOTES

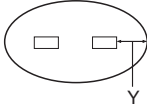
Tops may be specified with fewer consoles and configurations other than shown. Consoles can be different sizes within the same top. Dimension from end of cut-out to table end cannot be less than 18".

NUVO | CONSOLE SIZE & LOCATION - OVAL

Back-Painted Glass Top Console Options	Top Length	Console Options Top End Section	Console Options Within Top Center Section	Console Options Across Seam	Y
84" x 48"	84	L14/R14			18

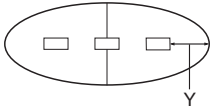
Example

AL14 AR14



96" - 120" X 48" 96" X 54"	96	*M14			18
-------------------------------	----	------	--	--	----

AM14 ABX14 BM14

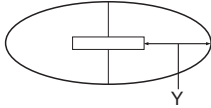


*The "M" position of these consoles is not exactly in the center of the section.

96" - 120" X 48" 96" X 54"	96			X27	34.5
				X14	41

Example

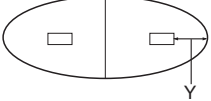
ABX36



120			X36	42
			X27	46.5
			X14	53

96" - 120" X 48" 96" X 54"	96	*M14			18
-------------------------------	----	------	--	--	----

AM14 BM14

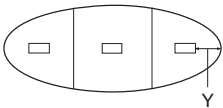


*The "M" position of these consoles is not exactly in the center of the section.

144" X 54"	144	*M14	M14		18
------------	-----	------	-----	--	----

Example

AM14 BM14 CM14



*The "M" position of these consoles is not exactly in the center of the section.

CODE KEY

- M - Console location, middle of top section
- X - Console location, across a seam of two top sections
- L - Console location, left side of a one piece top
- R - Console location, right side of a one piece top
- Y - Dimension from end of table to end of Console

Caution: Y greater than 30" makes access to Console Power/Data difficult from the end of the table

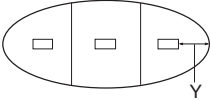
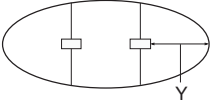
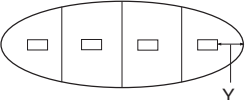
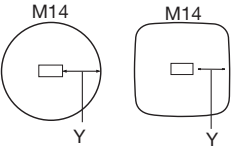
CONSOLE POWER/DATA MODULE OPTIONS

See page 49 for Console Module Options

ORDERING NOTES

Tops may be specified with fewer consoles and configurations other than shown. Consoles can be different sizes within the same top. Dimension from end of cut-out to table end cannot be less than 18".

NUVO | CONSOLE SIZE & LOCATION - OVAL, ROUND, ARCED SQUARE

Back-Painted Glass Top Console Options	Top Length	Console Options Top End Section	Console Options Within Top Center Section	Console Options Across Seam	Y
120" - 144" X 60"	120	*M14	M14		18
Example AM14 BM14 CM14	144	M14	M14		18
 <p>*The "M" position of these consoles is not exactly in the center of the section.</p>					
120" - 144" X 60" 144" X 54"	120			X14	33
Example ABX14 BCX14	144			X14	41
					
168" X 60"	168	M14	M14		18
Example AM14 BM14 CM14 DM14					
					
36" - 60"	36	M14			11
Examples	42	M14			14
M14	48	M14			17
M14	54	M14			20
					

CODE KEY

M - Console location, middle of top section
 X - Console location, across a seam of two top sections
 L - Console location, left side of a one piece top
 R - Console location, right side of a one piece top
 Y - Dimension from end of table to end of Console

Caution: Y greater than 30" makes access to Console Power/Data difficult from the end of the table

CONSOLE POWER/DATA MODULE OPTIONS

See page 49 for Console Module Options

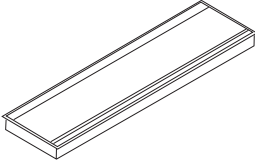
ORDERING NOTES

Tops may be specified with fewer consoles and configurations other than shown. Consoles can be different sizes within the same top. Dimension from end of cut-out to table end cannot be less than 18".

NUVO | CONSOLES FOR BACK-PAINTED GLASS TOPS

CONSOLE - WITHIN A TOP SECTION

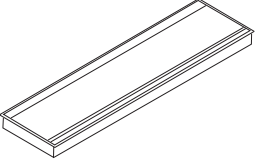
Consoles located within a top section are factory installed. The model numbers are determined by the location within each section and the size. For example, when ordering a rectangular top 96" x 54" a console M14 can be specified in both the A and/or B section of the table. When ordering, simply add AM14 and BM14 to your purchase order and add the list price for each console to your order.

Description	Model	Console Size	Price	Weights	Cubes
	M14, L14,R14	14	265	.25	
	M27	27	295	4	.25

Consoles are available in 2 standard lengths.

CONSOLE - ACROSS SEAMS

Consoles located across the seam are field installed and have separate model numbers that need to be included on your purchase order along with the desired console position. For example, when ordering a rectangular top 120" x 54" with a console across the seam, purchase orders need to specify the model number for the console (51CONSOLEX-14) and the location ABX14.

Description	Model	Console Size	Price	Weights	Cubes
	51CONSOLE-X14	14	265	3	0.25
	51CONSOLE-X27	27	295	4	0.25
	51CONSOLE-X36	36	333	5	0.25

CONSOLE POWER/DATA MODULES

Console modules provide an extensive range of power, data and audio-visual solutions for today's conferencing environments. Console modules are available in 18 preconfigured data and power options, or alternatively console modules with just electrical ports can be selected allowing units to be designed and built specifically to meet your connectivity needs by using the Snap-in or Plate mounted port options. Consoles are available with 3 power options in both preconfigured & custom console modules.

Power Module A (PMA) consists of 2 duplex receptacles with 3 cord lengths 6', 16' & 25'.

Power Module B (PMB) consists of 1 duplex receptacle with 3 cord lengths 6', 16' & 25'.

Power Module C (PMC) consists of 2 duplex receptacles with a utility outlet & circuit breaker with 2 cord lengths 6' & 16'. The utility outlet in Module C allows another power module within the table to be plugged into it resulting in 1 cord going to the power source for both modules, as well as circuit protection for both modules. This also means shorter cord lengths can be specified resulting in a more cost effective power solution. Krug recommends the use of Module C's on the Console at the end of the table or location in the table nearest the power source.

Examples:

120" table with 2 consoles & the power source at right end.

Use a PMC06 in the 1st console from the right & the cord goes to power source.

Use a PMA06 in the 2nd console from the right & the cord goes to the utility outlet of the first console module.

168" table with 4 consoles & power source at right hand end.

Use a PMC06 in the 1st console from the right & the cord goes to power source.

Use a PMC06 in the 2nd console from the right & the cord goes to power source.

Use a PMA06 in the 3rd console from the right & the cord goes to utility the outlet in the 1st console module.

Use a PMA06 in the 4th console from the right & the cord goes to utility the outlet in the 2nd console module.

CODE KEY

M - Console location, middle of top section

X - Console location, across a seam of two top sections

L - Console location, left side of a one piece top

R - Console location, right side of a one piece top

Y - Dimension from end of table to end of Console

Caution: Y greater than 30" makes access to Console Power/Data difficult from the end of the table

CONSOLE POWER/DATA MODULE OPTIONS

See page 49 for Console Module Options

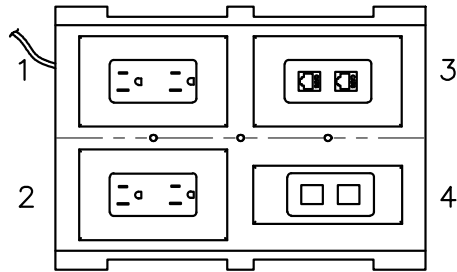
ORDERING NOTES

Tops may be specified with fewer consoles and configurations other than shown. Consoles can be different sizes within the same top. Dimension from end of cut-out to table end cannot be less than 18".

NUVO | STANDARD CONSOLE POWER/DATA/MEDIA CONFIGURATIONS

There are 3 versions of console power/data module: A, B, C. Version C has an utility outlet, this also allows another power module to be plugged into it allowing a shorter cord to be used.

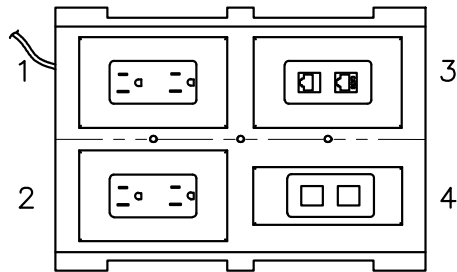
POWER MODULE A PRECONFIGURED



PORT OPTIONS	MODEL #	CORD LENGTH	LIST PRICE
--------------	---------	-------------	------------

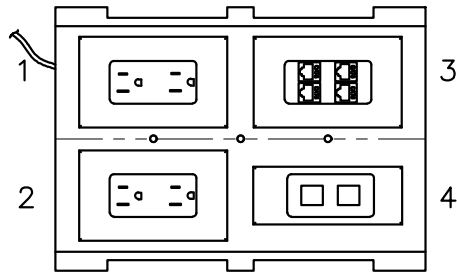
BASIC DATA

① (1) Duplex Receptacle	51PDAD01-06	6'	508
	51PDAD01-16	16'	596
② (1) Duplex Receptacle	51PDAD01-25	25'	670
③ (2) RJ45 Port (Cat 6)			
④ (2) Blank Ports (for future use)			



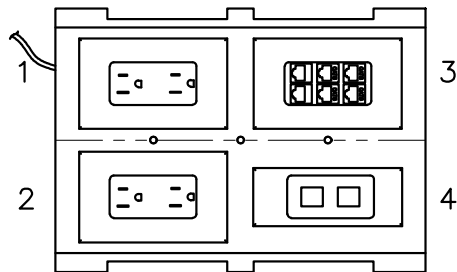
BASIC VOICE DATA

① (1) Duplex Receptacle	51PDAD02-06	6'	483
	51PDAD02-16	16'	571
② (1) Duplex Receptacle	51PDAD02-25	25'	648
③ (1) RJ45 Port (Cat 6)			
③ (1) RJ11 (Voice) Port			
④ (2) Blank Ports (for future use)			



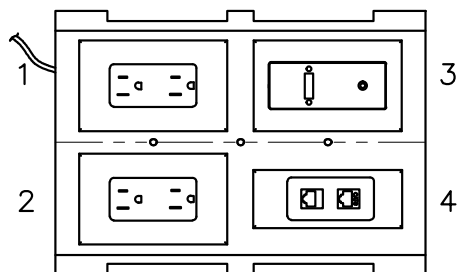
EXPANDED DATA

① (1) Duplex Receptacle	51PDAD03-06	6'	589
	51PDAD03-16	16'	678
② (1) Duplex Receptacle	51PDAD03-25	25'	753
③ (4) RJ45 Port (Cat 6)			
④ (2) Blank Ports (for future use)			



EXPANDED VOICE DATA

① (1) Duplex Receptacle	51PDAD04-06	6'	626
	51PDAD04-16	16'	716
② (1) Duplex Receptacle	51PDAD04-25	25'	791
③ (4) RJ45 Port (Cat 6)			
③ (2) RJ11 (Voice) Port			
④ (2) Blank Ports (for future use)			



BASIC MULTIMEDIA

① (1) Duplex Receptacle	51PDAD05-06	6'	633
	51PDAD05-16	16'	723
② (1) Duplex Receptacle	51PDAD05-25	25'	799
③ (1) Stereo 3.5 Mini			
③ (1) VGA Type 15 pin HD			
④ (1) RJ45 Port (Cat 6)			
④ (1) RJ11 (Voice) Port			

NUVO | CONSOLE POWER MODULES FOR CUSTOM CONFIGURATIONS

	PORT OPTIONS	MODEL #	CORD LENGTH	LIST PRICE
POWER MODULE A				
	① (1) Duplex Receptacle	51PMA06	6'	483
	② (1) Duplex Receptacle	51PMA16	16'	565
	③ (1) Open for data	51PMA25	25'	641
	④ (1) Open for data			
POWER MODULE B				
	① (1) Duplex Receptacle	51PMB06	6'	363
	② (1) Open for data	51PMB16	16'	446
	③ (1) Open for data	51PMB25	25'	530
	④ (1) Open for data			
POWER MODULE C WITH UTILITY OUTLET				
	① (1) Duplex Receptacle w/ 15 amp circuit breaker	51PMC06 51PMC16	6' 16'	508 582
	② (1) Duplex Receptacle with Utility Outlet			
	③ (1) Open for data			
	④ (1) Open for data			
DATA MODULE D				
	① (1) Open for data	51PMD		128
	② (1) Open for data			
	③ (1) Open for data			
	④ (1) Open for data			
<p>This open module can also be used if hard wiring power is required. Electrical boxes and receptacles can be installed in open spaces and a Decora face plate is mounted on top. All components would be provided by a qualified electrician.</p>				
POWER MODULE E WITH UTILITY OUTLET				
	① (1) Duplex Receptacle w/15 amp circuit breaker	51PME06		764
	② (1) Simplex Receptacle/ 2 USB Charging Port with Utility Outlet	51PME16		865
	③ (1) open for data			
	④ (1) open for data			
POWER MODULE A - HARD WIRED				
	① (1) Duplex Receptacle	51PMA16HW	16'	648
	② (1) Duplex Receptacle			
	③ (1) Open for data			
	④ (1) Open for data			

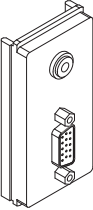
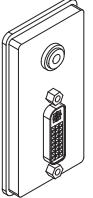
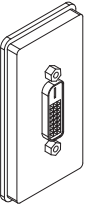
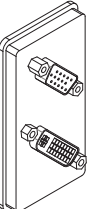
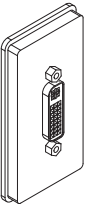
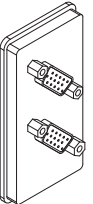
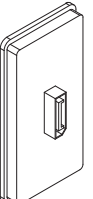
NOTE: Open positions will accept 1 Plate Mounted Data Option or up to 6 Snap-In Data Options. Please order a blank port when an odd number of snap-in ports are specified.

When specifying data within the power console module, please provide reference code and port position (1, 2, 3 or 4).


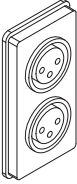
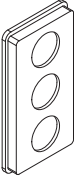
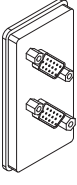
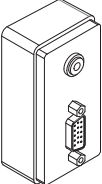

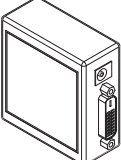
PLATE MOUNTED DATA OPTIONS
See page 54 for Plate Mounted Data Options

SNAP-IN DATA OPTIONS
See page 56 for Snap-In Data Options

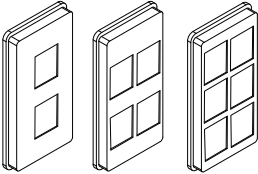

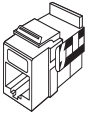

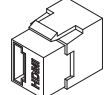



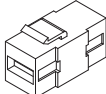
NUVO | CONSOLE DATA/MEDIA OPTIONS

PLATE MOUNTED PORTS	Reference Code	Description	List Price
	P01	VGA & 3.5 STEREO MINI - Use for VGA (DB15) connections and for 3.5mm stereo connections. VGA connectors is a female-to-female pass through and the 3.5 Mini is a female-to-female pass through.	143
	P02	DVI-I DUAL (DIGITAL/ANALOG) & 3.5 STEREO MINI - Use for DVI Integrated - Digital and Analog connections and for 3.5mm stereo connection. The DVI connector is a Dual Link. DVI-I connector is a female-to-female pass through and the 3.5 Mini is a female input with screw terminal output (back side of Console interface).	212
	P03	DVI-D DUAL (DIGITAL) - Use for DVI-D Digital only connection. The connector is a Dual Link. Connector is a female-to-female pass through.	137
	P04	DVI-I DUAL (DIGITAL/ANALOG) & VGA - Use for DVI Integrated - Digital and Analog and for VGA (DB15) connections. The DVI connector is a Dual Link. Both connectors are female-to-female pass through.	271
	P05	DVI-I DUAL (DIGITAL/ANALOG) - Use for DVI Integrated -Digital and Analog connections. DVI connector is a Dual Link. Connector is a female-to-female pass through.	173
	P06	VGA-2 - Use for two VGA (DB15) connections. Both connectors are female-to-female pass through.	168
	P07	DISPLAYPORT - Use for DisplayPort connection. This connector is primarily used to connect a video source to a display device and also carries audio signals, Connector is a female input to a 3' corded output (back side of Console interface) with a male Display Port termination.	168

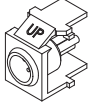
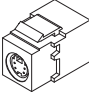
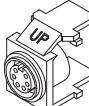

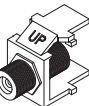
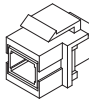
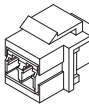
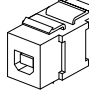
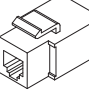

NUVO | CONSOLE DATA/MEDIA OPTIONS

PLATE MOUNTED PORTS	Reference Code	Description	List Price
	P08	MICROPHONE XLR STANDARD - Use for standard size XLR microphone connection. Connector is a female input with a 3 pin screw terminal output (back side of Console interface).	228
	P09	MICROPHONE STANDARD XLR -2 - Use for two standard size XLR microphone connections. Each connector is a female input with a 3 pin screw terminal output (back side of Console interface).	333
	P10	3 HOLE CABLE PASS THROUGH - Use for running loose cables from the under side of the table up into the Console interface cavity. Often used with running wires for PolyCom™ devices.	54
	P11	VGA-to-BNCx2 - Use for two VGA (DB15) connections that are input female pass through and are terminated on the output (back side of Console interface) with 5 BNC female pigtail connections, for each VGA connector.	542
	P12	INPUT VGA & 3.5 Stereo (POWERED) - VGA + Audio Line Driver designed for VGA (DB15) connections and for 3.5mm stereo connections. This unit provides a method of transmitting signals to a remote display and audio receiver or amplifier. VGA connector is a female input and comes with cabling for either VGA output, or 5 BNC output and the 3.5 Mini is a female input with screw terminal output (back side of Console interface). A 9 volt DC 500mA power supply is required to power this unit.	1327
	P13	BLANK DECORA ADAPTER - Use for covering a full Decora sides blank opening.	38
	DVIR	DVI-REPEATER - Is a cable equalizer that automatically compensates for long DVI cable runs. This unit extends the usable cable distance up to 130 ft depending on the quality of the cable and the resolution of the video signal. Additionally, it is capable of extending dual link signals allowing for much greater resolutions and refresh rates. This unit comes with a power supply and is generally mounted underneath a table.	1046

NUVO | CONSOLE DATA/MEDIA OPTIONS

SNAP IN PORTS	Reference Code	Description	List Price
ADAPTOR PLATES			
	M02	Adaptor Plate (2) - accepts two snap in data ports	38
	M04	Adaptor Plate (4) - accepts four snap in data ports	38
	M06	Adaptor Plate (6) - accepts six snap in data ports	38
ORDERING NOTES: Blank covers are required when port is not in use, please see page 55.			
	S01W	RJ45-CAT6 (White)	47
	S01B	RJ45-CAT6 (Blue)	
	S01R	RJ45-CAT6 (Red)	
	S02W	RJ11 (White)	32
	S02B	RJ11-B (Black)	
	S02G	RJ11-G (Green)	
	S02R	RJ11-R (Red)	
	S02Y	RJ11-Y (Yellow)	
	S03	3.5 STEREO MINI - 3.5mm stereo connection. Connector is a female input with screw terminal output (back side of Console interface).	92
	S04	HDMI - High Definition Multimedia Interface connection. Connector carries both HD audio and video data. Connector is a female-to-female pass through.	173
	S05	RCA-LEFT - RCA left audio channel connection. Color coded with black. Connector is a female-to-female pass through.	38
	S06	RCA-RIGHT - RCA right audio channel connection. Color coded with red. Connector is a female-to-female pass through.	38
	S07	RCA- VIDEO - RCA video channel connection. Color coded with yellow. Connector is a female-to-female pass through.	38
	S08	USB-A - Full size USB "A" style connection. Connector is a female-to-female pass through.	61

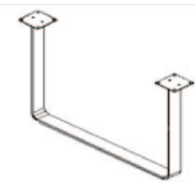
NUVO | CONSOLE DATA/MEDIA OPTIONS

SNAP IN PORTS	Reference Code	Description	List Price
	S09	3 PIN MINI XLR - 3 Pin Mini XLR microphone connection. Connector is a female input to a 6' corded output (back side of Console interface) with a 3 Pin Mini XLR male termination.	739
	S10	S-VIDEO - S-Video connection. Connector is a female-to-female pass through.	68
	S11	PS/2 (6 PIN MINI DIN) - PS/2 (mouse, keyboard, other input devices) connections. Connector is a female-to-female pass through.	85
	S12	BNC - BNC style data connection for use with co-axial cable. Connector is a female-to-female pass through.	47
	S13	F-TYPE - F-Type (DSL, Cable) connections, generally for high speed Internet or video applications. Connector is a female-to-female threaded pass through.	38
	S14	FIBER OPTIC SC - Fibre Optic SC Simplex connection. Connector is a female-to-female pass through. Please note that two of these connectors are required to complete the data transmissions to and from the source and destination units.	47
	S15	FIBER OPTIC LC - Fibre Optic LC Duplex connection. Connector is a female-to-female pass through. One connector only is required to complete the data transmissions to and from source and destination units.	92
	S16	USB-B - USB "B" type connection. Connector is a female "B" input to a female "A" output (back side of Console interface). This connector is reversible.	137
	S17	RJ12 (White) - RJ12 style PolyCom™ connection. Connector is a female input with a 6' corded output (back side) of Console interface) with a male RJ12 termination.	295
	S00	BLANK COVER - Blank covers are required when port is not in use.	16

NOTE: Up to 6 snap-in data ports can be ordered for open data positions. Snap-in adaptors can accept 2, 4 or 6 snap-in data ports. Please order a blank port when an odd number of snap-in ports are specified.

NUVO | BASES

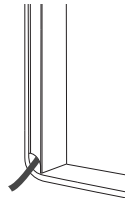
Description	Model	Price	W	D	H	Shipping Weight	Cubic Feet
-------------	-------	-------	---	---	---	-----------------	------------



Formed Metal Base	514124328	1173	24	3	28	29	2.75
	514136328	1311	36	3	28	31	3.75
	514148328	1446	47	3	28	37	4.5

ORDERING NOTE: Formed Metal bases are available in Matte Chrome. There are two cable management options available for Formed Metal bases – Metal Cable Manager or Spine Cable Manager. To order either of these options, please add the cable manager suffix to the end of the model number and add the upcharge listed below. For Example: To add the Metal Cable Manager to the Formed Metal base, please add **CM1** to the end of the base model number. e.g. 514124328 changes to 514124328**CM1** & add the upcharge from below. To add the Spine Cable Manager to the table, please add **CM2** to the end of the Formed Metal base model number. e.g. 514124328 changes to 514124328 **CM2** & add the upcharge from below.

Formed Metal Base Cable Management



Metal Cable Manager	182
CM1	

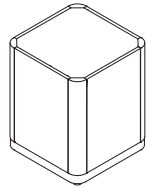
NOTE: Metal Cable Manager attaches to the Formed Metal Base magnetically.



Spine Cable Manager	212
CM2	

Description	Model	Laminate Oak, Maple Cherry Palette	Walnut	W	D	H	Shipping Weight	Cubic Feet
-------------	-------	---	--------	---	---	---	-----------------	------------

Square Base for Arc Square and Round Tops	5142161628	1064	1194	16	16	28	136	7.25
	5142202028	1192	1309	20	20	28	160	12.5

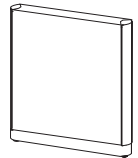


ORDERING NOTES: Bases are available in Oak, Maple, Cherry, Walnut, Palette finishes and Laminate. Base plates are available in Gloss Aluminum, Palette, Laminate or Wood, please specify requirement on order.

BASE SIZES FOR ARCED SQUARE TABLES AND FOR ROUND TABLES							
Top Size Arc Square	Top Size Round Tops	Quantity	W	D	H		
36-36	36 Dia.	1	16	16	28		
42-42	42 Dia.	1	16	16	28		
48-48	48 Dia.	1	20	20	28		
54-54	54 Dia.	1	20	20	28		
60-60	60 Dia.	1	20	20	28		

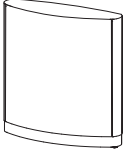
These bases include a weighted ballast to provide stability.

Panel Base

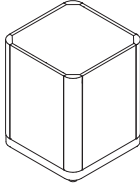


513921325	882	971	20.5	3	25	30	2
513925325	957	1054	24.5	3	25	33	2.25
513931325	1017	1119	30.5	3	25	38	2.5

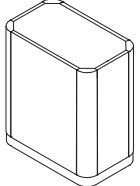
ORDERING NOTE: Base plates are available in Gloss Aluminum, Palette, Laminate or Wood, please specify requirement on order.

Description	Model	Laminate	Walnut	W	D	H	Shipping Weight	Cubic Feet
		Oak, Maple, Cherry, Palette						
	514521825	994	1093	21	8	25	28	3.5
	5145251025	1068	1177	25	10	25	33	5.75
	5145311225	1162	1275	31	12	25	38	7.75

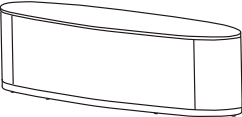
ORDERING NOTE: Base plates are available in Gloss Aluminum, Palette, Laminate or Wood, please specify requirement on order.

Description	Model	Laminate	Walnut	W	D	H	Shipping Weight	Cubic Feet
		Oak, Maple, Cherry, Palette						
	5143161625	1173	1292	16	16	25	60	7.25
	5143202025	1236	1358	20	20	25	75	8.5
	5143242425	1282	1409	24	24	25	88	12
	5143303025	1416	1558	30	30	25	95	14

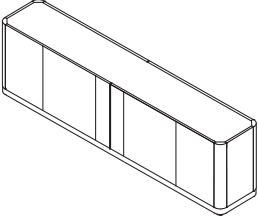
ORDERING NOTE: Base plates are available in Gloss Aluminum, Palette, Laminate or Wood, please specify requirement on order.

Description	Model	Laminate	Walnut	W	D	H	Shipping Weight	Cubic Feet
		Oak, Maple, Cherry, Palette						
	5144211225	1039	1142	21.5	12	25	55	7
	5144251225	1173	1292	25	12	25	61	8
	5144311225	1311	1441	31	12	25	69	9.5

ORDERING NOTE: Base plates are available in Gloss Aluminum, Palette, Laminate or Wood, please specify requirement on order.

Description	Model	Laminate	Walnut	W	D	H	Shipping Weight	Cubic Feet
		Oak, Maple, Cherry, Palette						
	5146184725	2500	2747	18	47	25	118	19
	5146187125	3208	3529	18	71	25	175	28
	5146247125	4185	4604	24	71	25	270	41
	5146249525	5345	5878	24	95	25	308	46.5
	51462410725	6308	6938	24	107	25	346	52

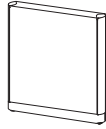
ORDERING NOTE: Base plates are available in Gloss Aluminum, Palette, Laminate or Wood, please specify requirement on order.

Description	Model	Laminate	Walnut	W	D	H	Shipping Weight	Cubic Feet
		Oak, Maple, Cherry, Palette						
	5147182725	1192	1309	18	27	25	46	11.5
	5147183925	1612	1773	18	39	25	65	16
	5147186325	2168	2385	18	63	25	102	25
	5147189925	2996	3294	18	99	25	157	38
	51471812325	3706	4072	18	123	25	193	47
	51471817125	4998	5498	18	171	25	267	65
	5147246325	2576	2831	24	63	25	134	31.5
	5147249925	3088	3396	24	99	25	207	48.5
	51472412325	4366	4802	24	123	25	256	60
	51472417125	5766	6343	24	171	25	351	82.5
	51472421925	6504	7154	24	219	25	451	105

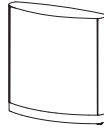
ORDERING NOTE: Base plates are available in Gloss Aluminum, Palette, Laminate or Wood, please specify requirement on order. Rectangular island bases greater than 99" are constructed in two pieces requiring assembly in the field.

NUVO | BASE REQUIREMENTS CHART

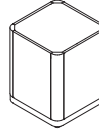
Panel Base
5139



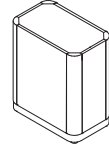
Oval Base
5145



Square Base
5143



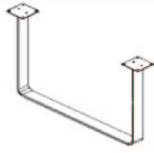
Rectangular Base
5144



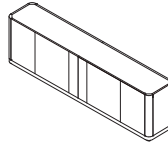
Model#	Quantity	Size	Quantity	Size	Quantity	Size	Quantity	Size
BASE REQUIREMENTS FOR RECTANGULAR (5161) & ARC END (5166) TOPS								
60-36	2	21	2	21				
60-42	2	21	2	21				
60-48	2	21	2	21				
72-36	2	21	2	21				
72-42	2	21	2	21				
72-48	2	21	2	21				
78-36	2	21	2	21			2	21
78-42	2	21	2	21			2	21
78-48	2	21	2	21			2	21
84-36	2	21	2	21			2	21
84-42	2	21	2	21			2	21
84-48	2	21	2	21			2	21
96-36	2	21	2	21	2	16	2	21
96-42	2	21	2	21	2	16	2	21
96-48	2	21	2	21	2	20	2	21
108-42	2	21	2	21	2	16	2	21
108-48	2	21	2	21	2	20	2	21
108-54	2	25	2	25	2	24	2	25
120-42	2	21	2	21	2	16	2	21
120-48	2	21	2	21	2	20	2	21
120-54	2	25	2	25	2	24	2	25
120-60	2	25	2	25	2	24	2	25
144-48	3	21	3	21	2	20	3	21
144-54	3	25	3	25	2	24	3	25
144-60	3	25	3	25	2	24	3	25
156-54	3	25	3	25	2	24	3	25
156-60	3	25	3	25	2	24	3	25
168-48	3	21	3	21	3	20	3	21
168-54	3	25	3	25	3	24	3	25
168-60	3	25	3	25	3	24	3	25
192-48	3	21	3	21	3	20	3	21
192-54	3	25	3	25	3	24	3	25
192-60	3	25	3	25	3	24	3	25
216-54	4	25	4	25	3	24	4	25
216-60	4	25	4	25	3	24	4	25
240-60	4	25	4	25	3	24	4	25
264-60	4	25	4	25	3	24	4	25
288-60	5	25	5	25	4	24	5	25

NUVO | BASE REQUIREMENTS CHART

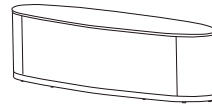
Formed Metal Base
5141



Rectangular Island Base
5147



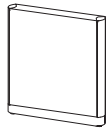
Oval Island Base
5146



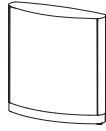
Model#	Quantity	Size	Quantity	Size	Quantity	Size
BASE REQUIREMENTS FOR RECTANGULAR (5161) & ARC END (5166) TOPS						
60-36	2	24				
60-42	2	24				
60-48	2	36	1	18x27		
72-36	2	24				
72-42	2	24				
72-48	2	36	1	18x27		
78-36	2	24				
78-42	2	24				
78-48	2	36	1	18x39		
84-36	2	24				
84-42	2	24				
84-48	2	36	1	18x39		
96-36	2	24				
96-42	2	24				
96-48	2	36	1	18x39		
108-42	2	24				
108-48	2	36	1	18x63		
108-54	2	36	1	24x63		
120-42	2	24				
120-48	2	36	1	18x63		
120-54	2	36	1	24x63		
120-60	2	48	1	24x63		
144-48	3	36	1	18x99		
144-54	3	36	1	24x99		
144-60	3	48	1	24x99		
156-54	3	36	1	24x99		
156-60	3	48	1	24x99		
168-48	3	36	1	18x123		
168-54	3	36	1	24x123		
168-60	3	48	1	24x123		
192-48	3	36	1	18x123		
192-54	3	36	1	24x123		
192-60	3	48	1	24x123		
216-54	4	36	1	24x171		
216-60	4	48	1	24x171		
240-60	4	48	1	24x171		
264-60	4	48	1	24x219		
288-60	5	48	1	24x219		

NUVO | BASE REQUIREMENTS CHART

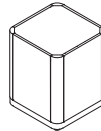
Panel Base
5139



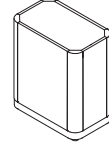
Oval Base
5145



Square Base
5143



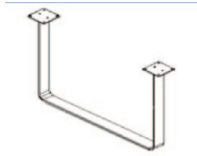
Rectangular Base
5144



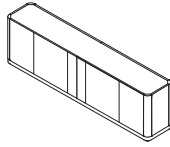
Model#	Quantity	Size	Quantity	Size	Quantity	Size	Quantity	Size
BASE REQUIREMENTS FOR RACETRACK TOPS - (5102)								
60-36	2	21	2	21				
60-42	2	21	2	21				
60-48	2	21	2	21				
72-36	2	21	2	21				
72-42	2	21	2	21				
72-48	2	21	2	21				
78-36	2	21	2	21			2	21
78-42	2	21	2	21			2	21
78-48	2	21	2	21			2	21
84-36	2	21	2	21			2	21
84-42	2	21	2	21			2	21
84-48	2	21	2	21			2	21
96-36	2	21	2	21	2	16	2	21
96-42	2	21	2	21	2	16	2	21
96-48	2	21	2	21	2	20	2	21
108-42	2	21	2	21	2	16	2	21
108-48	2	21	2	21	2	20	2	21
108-54	2	21	2	21	2	20	2	21
120-42	2	21	2	21	2	16	2	21
120-48	2	21	2	21	2	20	2	21
120-54	2	21	2	21	2	20	2	21
120-60	2	25	2	25	2	24	2	25
144-48	3	21	3	21	2	20	3	21
144-54	3	21	3	21	2	20	3	21
144-60	3	25	3	25	2	24	3	25
156-54	3	21	3	21	2	20	3	21
156-60	3	25	3	25	2	24	3	25
168-48	3	21	3	21	3	20	3	21
168-54	3	21	3	21	3	20	3	21
168-60	3	25	3	25	3	24	3	25
192-48	3	21	3	21	3	20	3	21
192-54	3	21	3	21	3	20	3	21
192-60	3	25	3	25	3	24	3	25
216-54	4	21	4	21	3	20	4	21
216-60	4	25	4	25	3	24	4	25
240-60	4	25	4	25	3	24	4	25
264-60	4	25	4	25	3	24	4	25
288-60	5	25	5	25	4	24	5	25

NUVO | BASE REQUIREMENTS CHART

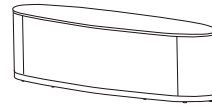
Formed Metal Base
5141



Rectangular Island Base
5147



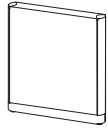
Oval Island Base
5146



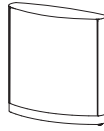
Model#	Quantity	Size	Quantity	Size	Quantity	Size
BASE REQUIREMENTS FOR RACETRACK TOPS - (5102)						
60-36	2	24				
60-42	2	24				
60-48	2	36	1	18x27		
72-36	2	24				
72-42	2	24				
72-48	2	36	1	18x27		
78-36	2	24				
78-42	2	24				
78-48	2	36	1	18x39		
84-36	2	24				
84-42	2	24				
84-48	2	36	1	18x39		
96-36	2	24				
96-42	2	24				
96-48	2	36	1	18x39		
108-42	2	24				
108-48	2	36	1	18x63		
108-54	2	36	1	18x63		
120-42	2	24				
120-48	2	36	1	18x63		
120-54	2	36	1	18x63		
120-60	2	48	1	24x63		
144-48	3	36	1	18x99		
144-54	3	36	1	18x99		
144-60	3	48	1	24x99		
156-54	3	36	1	18x99		
156-60	3	48	1	24x99		
168-48	3	36	1	18x123		
168-54	3	36	1	18x123		
168-60	3	48	1	24x123		
192-48	3	36	1	18x123		
192-54	3	36	1	18x123		
192-60	3	48	1	24x123		
216-54	4	36	1	18x171		
216-60	4	48	1	24x171		
240-60	4	48	1	24x171		
264-60	4	48	1	24x219		
288-60	5	48	1	24x219		

NUVO | BASE REQUIREMENTS CHART

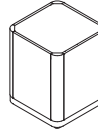
Panel Base
5139



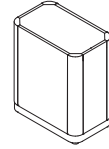
Oval Base
5145



Square Base
5143



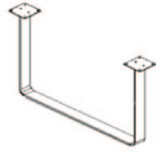
Rectangular Base
5144



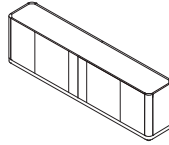
Model#	Quantity	Size	Quantity	Size	Quantity	Size	Quantity	Size
BASE REQUIREMENTS FOR BOAT-SHAPED TOPS - (5164)								
96-48-42	2	21	2	21	2	20	2	21
96-54-42	2	21	2	21	2	20	2	21
120-48-42	2	21	2	21	2	20	2	21
120-54-42	2	21	2	21	2	20	2	21
144-48-42	3	21	3	21	2	20	3	21
144-54-42	2	21	2	21	2	20	2	21
	1	25	1	25			1	25
168-54-42	2	21	2	21	2	20	2	21
	1	25	1	25	1	24	1	25
192-54-42	2	21	2	21	2	20	2	21
	1	25	1	25	1	24	1	25
216-60-48	2	21	2	21	2	20	2	21
	2	25	2	25	1	24	2	25
240-60-48	2	21	2	21	2	20	2	21
	2	25	2	25	1	24	2	25
264-60-48	2	21	2	21	2	20	2	21
	2	25	2	25	2	24	2	25
288-60-48	4	21	4	21	2	20	4	21
	1	25	1	25	2	24	1	25
BASE REQUIREMENTS FOR VISIO TOPS - (5168)								
120-60-42	2	21	2	21	2	20	2	21
144-60-42	3	21	3	21	2	20	3	21
168-66-42	2	21	2	21	2	20	2	21
	1	31	1	31	1	30	1	31
192-69-42	2	21	2	21	2	20	2	21
	1	31	1	31	1	30	1	31
216-73-42	2	21	2	21	2	20	2	21
	2	31	2	31	1	30	2	31
240-76-42	2	21	2	21	2	20	2	21
	2	31	2	31	1	30	2	31

NUVO | BASE REQUIREMENTS CHART

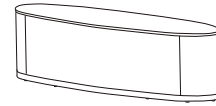
Formed Metal Base
5141



Rectangular Island Base
5147



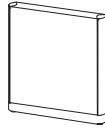
Oval Island Base
5146



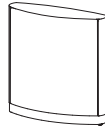
Model#	Quantity	Size	Quantity	Size	Quantity	Size
BASE REQUIREMENTS FOR BOAT-SHAPED TOPS - (5164)						
96-48-42	2	36				
96-54-42	2	36				
120-48-42	2	24				
120-54-42	2	36				
144-48-42	2	24				
	1	36				
144-54-42	3	36				
168-54-42	3	36				
192-54-42	3	36				
216-60-48	2	36				
	2	48				
240-60-48	2	36				
	2	48				
264-60-48	2	36				
	2	48				
288-60-48	4	36				
	1	48				
BASE REQUIREMENTS FOR VISIO TOPS - (5168)						
120-60-42	1	36				
	1	48				
144-60-42	1	24				
	1	36				
	1	48				
168-66-42	1	24				
	1	36				
	1	48				
192-69-42	1	24				
	1	36				
	1	48				
216-73-42	1	24				
	1	36				
	2	48				
240-76-42	1	24				
	1	36				
	2	48				

NUVO | BASE REQUIREMENTS CHART

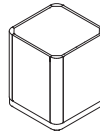
Panel Base
5139



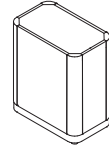
Oval Base
5145



Square Base
5143



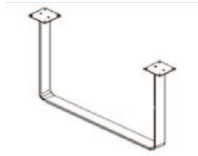
Rectangular Base
5144



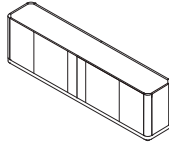
Model#	Quantity	Size	Quantity	Size	Quantity	Size	Quantity	Size
BASE REQUIREMENTS FOR OVAL TOPS - (5159)								
84-48	2	21	2	21				
96-48	2	21	2	21				
96-54	2	21	2	21				
120-48	2	21	2	21				
120-60	2	21	2	21				
144-54	3	21	3	21				
144-60	2	21	2	21				
	1	25	1	25				
168-60	2	21	2	21				
	1	25	1	25				

NUVO | BASE REQUIREMENTS CHART

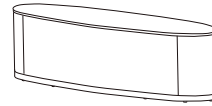
Formed Metal Base
5141



Rectangular Island Base
5147



Oval Island Base
5146



Model#	Quantity	Size	Quantity	Size	Quantity	Size
BASE REQUIREMENTS FOR OVAL TOPS - (5159)						
84-48	2	24			1	18x47
96-48	2	24			1	18x47
96-54	2	36			1	18x47
120-48	2	24			1	18x71
120-60	2	36			1	24x71
144-54	1	36			1	24x95
	2	24				
144-60	1	48			1	24x95
	2	24				
168-60	1	48			1	24x107
	2	24				

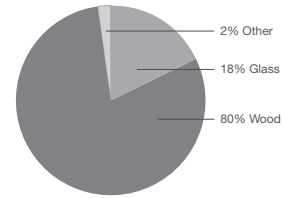
NUVO | LEED CI CREDIT SUMMARY

LEED CI - Credit Summary

NUVO CONFERENCE



MATERIAL CONTENT



PRE-CONSUMER RECYCLED CONTENT - 81%

POST-CONSUMER RECYCLE CONTENT - 3%

CONTRIBUTES TO

CREDIT 2.1 - 2.2	Construction Waste Management	1-2 point(s)
CREDIT 4.1	Recycled Content	1 point
CREDIT 4.2	Recycled Content	1 point
CREDIT 4.5	Low Emitting Materials, (MUST BE REQUESTED)	
	Composite Wood & Laminate Adhesives	1 point
CREDIT 5.1	Regional Materials*	1 point
CREDIT 6	Rapidly Renewable Materials (MUST BE REQUESTED)	1 point
CREDIT 7	Certified Wood (MUST BE REQUESTED)	1 point

* This credit is only applicable if in total 20% of the combined value of the procurement of construction materials and in the furniture are manufactured within a radius of 500 miles. This credit will apply if the installation of the finished product occurs within 500 miles of Kitchener, Ontario.

Nuvo Media & Storage products compliment Nuvo Conference with 6 veneer species selections. Veneered tops are 1 1/2" thick veneered particle board core and backer material, with a 1/8" wood edge. Laminate tops are 1 1/2" thick with particle board core and backer material, with a matching laminate edge. Glass tops are back painted tempered glass with an 1 1/8" medium density fiberboard painted sub top with bevelled edge. Tops are available with these profiles.



Edge profile for wood & laminate tops



Edge profile for glass tops

SURFACES

Buffet and Credenza tops are 1 1/2" thick 45lbs per cubic feet particle board core, 3 ply. Gables are 3/4" thick 45lbs per cubic feet particle board core, 3 ply.

VENEER

Veneers available are Rift White Oak, Quarter Cut Maple, Quarter Cut Cherry, Quarter Cut Walnut

LAMINATE

Please note the grain direction of wood grain laminate will run horizontal on the backs of credenzas and buffets. Laminate tops are 1 1/2" thick with particle board core and backer material, with a matching laminate edge.

FINISH

A five step catalyzed varnish finish that when dry has a sheen value of 32°, is applied to all tables, bases and cases. A lower sheen topcoat, 20°, can also be specified, at standard pricing. All purchase orders must clearly note "lower sheen finish" in order to receive this optional selection.

All finished surfaces are well sanded before applying finishing materials. The procedure begins by applying a base color via an NGR stain. A wash coat follows to further enhance the color. Next is the glazing process, which provides the 3rd color step and fills the pores of the wood. A sealer coat is then applied, twice to the horizontal worksurfaces to enhance the finish. The product is then scuff sanded to prepare for the top coat. The top coat is a catalyzed varnish that when dry has a sheen value of 32°. Krug's catalyzed varnish has been tested to be one of the industry's most durable and long lasting. Custom finishes are available

GLIDES

Credenzas and Buffets feature adjustable glides 1 1/2" long and allow for a range of adjustment of 3/4".

GLASS SURFACE

Nuvo Casegood tops are available in white back-painted 10mm tempered glass. Please contact customer service, for additional color selections available at no upcharge.

TESTING

All products have been tested in accordance with ANSI/BIFMA X5.5-2014 or X5.9-2012.

DRAWERS

Desk box drawers have full progressive full extension slides and are load rated at 100lbs. per drawer. All drawer interiors are veneer on plywood, and include a push to open drawer mechanism.

LATCHES

Doors open with a touch latch. There are no pulls on Nuvo Media & Storage.

HINGES

Nuvo Media & Storage utilize European style satin chrome hinges with 3-way adjustment & quick release feature. Hinge opening is 95 degrees.

CASTERS

Locking casters are standard on the Hospitality Cart and lectern.

SLIDING DOORS

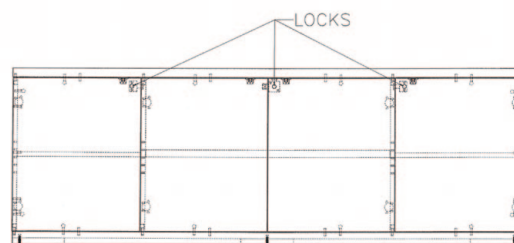
Sliding Doors include a single roller track system.

BACK-PAINTED GLASS DOORS

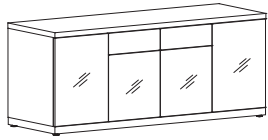
Nuvo glass doors have Back-Painted glass with a satin aluminum frame.

LOCKS

Locks are optional on hinged wood doors at an upcharge of **\$152 list** per set of 2 doors and **\$152 list** per single door. Buffets and Credenzas with 2 outside doors require 3 locks.

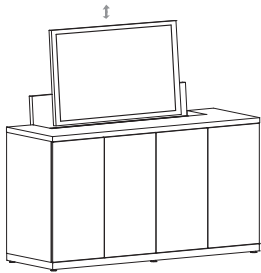
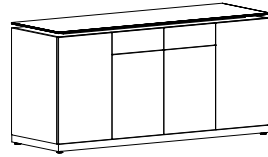


NUVO | FEATURES & OPTIONS



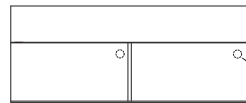
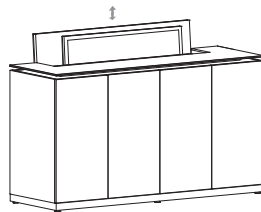
CREDENZAS AND BUFFETS

- 2 styles of cabinet tops are available: wood top and Back-Painted glass tops.
- Doors are available in Back-Painted glass & wood veneer.
- Storage sections feature one wooden shelf which is height adjustable in increments of 1 1/4".
- Buffets with wood drawers can include an optional cutlery insert.
- Buffet may be specified with optional Recycle/Waste bin.
- Buffet may be specified with optional Mini Refrigerator on 24" deep Buffets at a price of **\$2513 list**.
- Mini refrigerator features volume of 1.1 cu. ft., 2 inner door racks, automatic defrost, and lock.
- Credenzas and Buffets with glass tops are shipped with tops assembled to case.



TV CABINET WITH LIFT

- Accommodate flat screen televisions up to 130lbs with dimensions no greater than 51 1/4"W x 4 3/4"D x 30"H
- Cabinet is standard with 4 shelves 12 1/2" deep.
- Includes a remote control to raise and lower the television. Remote has a radio frequency control with 15 ft. operating distance
- 2 styles of cabinet tops are available: wood top and Back-Painted glass tops.
- Cable access in shelves and partition



Grommet in each shelf & partition for cord pass through

GROMMET IN EACH SHELF FOR CORD PASS THROUGH

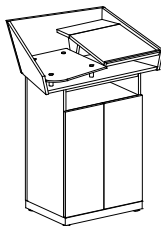
HOSPITALITY CARTS

- The cart is mounted on heavy-duty locking casters.
- A handle on each end facilitates movement of the cart. Handles are available in a satin aluminum finish.
- The cart features a stainless steel container with removable plastic garbage & recycling bins. A cutlery tray is included.
- 2 styles of cabinet tops are available: wood top and Back-Painted glass tops.
- 2 adjustable shelves behind large door



LECTERNS

- Glass shelf version has a wood upper flat shelf which provides a place for pens, pencils or a glass of water, and optional reference light at a price of **\$443 list**. It will also accommodate a user-specified microphone.
- Angled wood shelf has a bottom lip to hold papers in place. The shelf lifts to reveal an optional power and data interface point
- Back-Painted glass shelf provides more surface area for equipment such as a laptop. A presenter's open laptop is not visible to the seated audience.
- Cables from the interface point, (or user supplied cables) are routed down through grommeted holes to the bottom of the unit and are accessible via doors on the users side. Optional power bar at a price of **\$208 list**.
- Full width shelf version is available.
- Mobile versions are available.
- Glass shelf is shipped installed.



NUVO | FEATURES & OPTIONS



BASE PLATES

- Available in a choice of Wood, Laminate, or Gloss Aluminum finish.



RECYCLE/WASTE BIN

- Stainless Steel sliding bin containing 2 x 14 L plastic bins for recycling and waste. Opens with the door.
- Approximate dimensions 14.25 x 17.33 x 16.53



BACK-PAINTED GLASS TOPS

- Back-Painted glass tops are 10mm thick and available as an option.



CUTLERY TRAY

- Surface silver grained
- Impact-resistant polystyrene
- Environmentally friendly, fully recyclable
- Antistatic, easy to clean

ALTINEX BOX

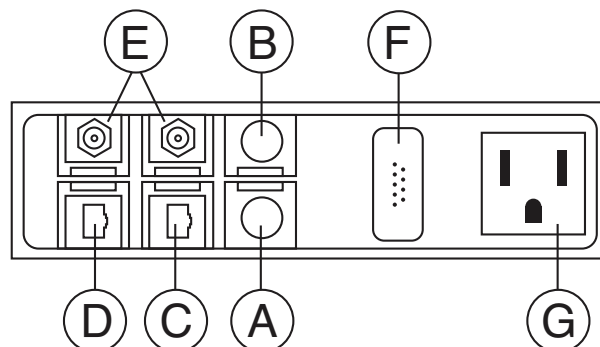
The Altinex box offers an ideal solution for the power and data requirements of a speaker using the NUVO Lectern.

Altinex features the following power/data connectors:

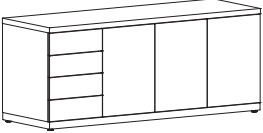
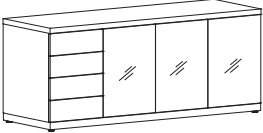
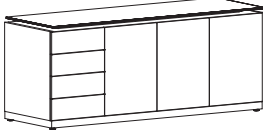
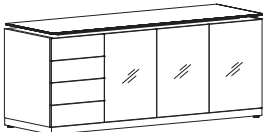
A	(1) Stereo Mini	3.5 mm Mini pass-through connector from computer sound card to amplified sound system
B	(1) BNC port	High quality pass-through connector from broadcast video or computer video to video display monitor
C	(1) RJ11 port	Connection for Telephone / Modem
D	(1) RJ45 port	Connection for Network Connector
E	(2) RCA ports	Female RCA type pass-through (Left - Black, Right - Red) cable connectors from stereo audio source to audio system
F	(1) 15 Pin HD port	VGA type 15 pin pass-through connector from computer video to display monitor
G	(1) Simplex Power port	Power Input

For more information or questions regarding the Altinex Box, please contact Krug Customer Service or Altinex Technical Support at 1-800-258-4623.

This option is available on NUVO lecterns at an upcharge of **\$1273 list**.



NUVO | CREDENZAS

Description	Model	Oak	Cherry	Maple	W	D	H	Weight	Cube
		Laminate	Walnut						
 3 Hinged Doors, 4 Drawers	51C72202907	5955	6550		71.5	20	29.9	309	31
	51C72242907	6237	6861		71.5	24	29.9	321	36
	51C84202907	6846	7532		83.5	20	29.9	360	36
	51C84242907	7173	7889		83.5	24	29.9	374	42
 Back-Painted Glass Doors, 4 Drawers	51C72202907Z	7498	8249		71.5	20	29.9	323	31
	51C72242907Z	7781	8559		71.5	24	29.9	383	36
	51C84202907Z	8622	9486		83.5	20	29.9	376	36
	51C84242907Z	8947	9841		83.5	24	29.9	446	42
 3 Hinged Doors, 4 Drawers, Back-Painted Glass Top	51CGP72202907	8856	9739		71.5	20	29.9	349	31
	51CGP72242907	9719	10691		71.5	24	29.9	369	36
	51CGP84202907	10182	11199		83.5	20	29.9	406	36
	51CGP84242907	11174	12291		83.5	24	29.9	429	42
 Back-Painted Glass Doors, 4 Drawers, Back-Painted Glass Top	51CGP72202907Z	10399	11438		71.5	20	29.9	363	31
	51CGP72242907Z	11262	12388		71.5	24	29.9	383	36
	51CGP84202907Z	11958	13153		83.5	20	29.9	423	36
	51CGP84242907Z	12951	14246		83.5	24	29.9	446	42

ORDERING NOTES: An optional Recycle/Waste bin, located behind the right door, is available at an upcharge of **\$571 list**, add W - Waste Bin to the model number. An optional Cutlery Tray is available at an upcharge of **\$61 list**. An optional mini fridge, located behind the right door, is available on 24" deep units at an upcharge of **\$2638 list**, add F - fridge to model number.

ORDERING PROCEDURE

To order, please specify the following:

- 1) Krug product model number
- 2) Wood species and finish

CODE DESCRIPTION

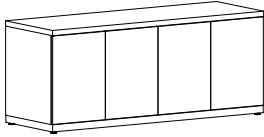
- GP - Back-Painted Glass Top
Z - Back-Painted Glass Doors

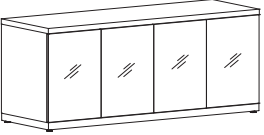
STANDARD FINISHES

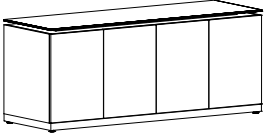
For a complete list of standard wood finishes, please see page 347

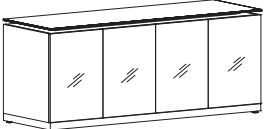
BASE PLATES

Base plates are available in Gloss Aluminum, Laminate or Wood, please specify requirement on order.

Description	Model	Oak Cherry Maple Laminate		W	D	H	Weight	Cube
		Walnut						
 4 Hinged Doors	51C72202911	4967	5464	71.5	20	29.9	265	31
	51C72242911	5248	5775	71.5	24	29.9	277	36
	51C84202911	5713	6284	83.5	20	29.9	309	36
	51C84242911	6036	6641	83.5	24	29.9	323	42

 4 Hinged Back-Painted Glass Doors	51C72202911Z	7024	7730	71.5	20	29.9	283	31
	51C72242911Z	7310	8040	71.5	24	29.9	295	36
	51C84202911Z	8079	8888	83.5	20	29.9	330	36
	51C84242911Z	8405	9245	83.5	24	29.9	344	42

 4 Hinged Doors, Back- Painted Glass Top	51CGP72202911	7866	8654	71.5	20	29.9	305	31
	51CGP72242911	8731	9604	71.5	24	29.9	325	36
	51CGP84202911	9048	9952	83.5	20	29.9	355	36
	51CGP84242911	10042	11044	83.5	24	29.9	379	42

 4 Hinged Back-Painted Glass Doors, Back-Painted Glass Top	51CGP72202911Z	9928	10918	71.5	20	29.9	323	31
	51CGP72242911Z	10790	11870	71.5	24	29.9	343	36
	51CGP84202911Z	11415	12556	83.5	20	29.9	376	36
	51CGP84242911Z	12408	13648	83.5	24	29.9	400	42

ORDERING NOTES: An optional Recycle/Waste bin is available at an upcharge of **\$571 list**, add WL - Waste Bin Left or WR - Waste Bin Right to the model number.

An optional mini fridge is available on 24" deep units, at an upcharge of **\$2638**, add FL fridge left or FR fridge right to model number.

DIMENSION KEY

W - width
D - depth
H - height

CODE DESCRIPTION

GP - Back-Painted Glass Top
Z - Back-Painted Glass Doors

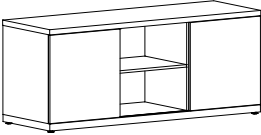
STANDARD FINISHES

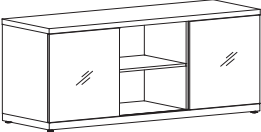
For a complete list of standard wood finishes, please see page 347

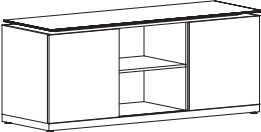
BASE PLATES

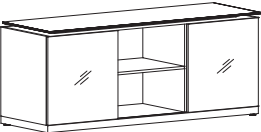
Base plates are available in Gloss Aluminum, Laminate or Wood, please specify requirement on order.

NUVO | CREDENZAS

Description	Model	Oak Cherry Maple Laminate			W	D	H	Weight	Cube
		Walnut							
	51CS72202911	5488	6036	71.5	20	29.9	246	31	
	51CS72242911	5769	6347	71.5	24	29.9	258	36	
	51CS84202911	6312	6941	83.5	20	29.9	287	36	
	51CS84242911	6634	7298	83.5	24	29.9	301	42	

	51CS72202911Z	6863	7549	71.5	20	29.9	259	31
	51CS72242911Z	7147	7862	71.5	24	29.9	271	36
	51CS84202911Z	7893	8681	83.5	20	29.9	302	36
	51CS84242911Z	8219	9040	83.5	24	29.9	316	42

	51CSGP72202911	8389	9225	71.5	20	29.9	286	31
	51CSGP72242911	9252	10177	71.5	24	29.9	306	36
	51CSGP84202911	9646	10612	83.5	20	29.9	333	36
	51CSGP84242911	10638	11704	83.5	24	29.9	356	42

	51CSGP72202911Z	9763	10741	71.5	20	29.9	299	31
	51CSGP72242911Z	10629	11691	71.5	24	29.9	319	36
	51CSGP84202911Z	11379	12518	83.5	20	29.9	348	36
	51CSGP84242911Z	12222	13445	83.5	24	29.9	372	42

ORDERING NOTES: An optional mini fridge is available on 24" deep units, at an upcharge of **\$2638**, add FL fridge left or FR fridge right to model number.

ORDERING PROCEDURE

To order, please specify the following:
 1) Krug product model number
 2) Wood species and finish

CODE DESCRIPTION

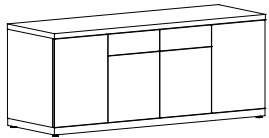
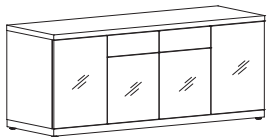
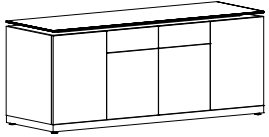
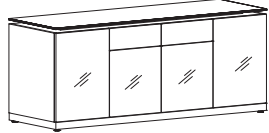
GP - Back-Painted Glass Top
 Z - Back-Painted Glass Doors

STANDARD FINISHES

For a complete list of standard wood finishes, please see page 347.

BASE PLATES

Base plates are available in Gloss Aluminum, Laminate or Wood, please specify requirement on order.

Description	Model	Finish			W	D	H	Weight	Cube
		Oak Cherry Maple Laminate	Walnut						
 Door, Drawer/Door, Drawer/Door, Door	51C72202914	6044	6647	71.5	20	29.9	277	31	
	51C72242914	6325	6959	71.5	24	29.9	289	36	
	51C84202914	6948	7645	83.5	20	29.9	323	36	
	51C84242914	7273	8002	83.5	24	29.9	337	42	
 Back-Painted Glass Door, Drawer/Door, Drawer/Door, Door	51C72202914Z	7934	8727	71.5	20	29.9	295	31	
	51C72242914Z	8217	9038	71.5	24	29.9	317	36	
	51C84202914Z	9123	10035	83.5	20	29.9	344	36	
	51C84242914Z	9447	10392	83.5	24	29.9	369	42	
 Door, Drawer/Door, Drawer/Door, Door, Back-Painted Glass Top	51CGP72202914	8942	9838	71.5	20	29.9	317	31	
	51CGP72242914	9808	10787	71.5	24	29.9	337	36	
	51CGP84202914	10285	11313	83.5	20	29.9	369	36	
	51CGP84242914	11279	12405	83.5	24	29.9	393	42	
 Back-Painted Glass Door, Drawer/Door, Drawer/Door, Door, Back-Painted Glass Top	51CGP72202914Z	10834	11917	71.5	20	29.9	335	31	
	51CGP72242914Z	11699	12866	71.5	24	29.9	365	36	
	51CGP84202914Z	12460	13707	83.5	20	29.9	390	36	
	51CGP84242914Z	13454	14798	83.5	24	29.9	425	42	

ORDERING NOTES: An optional Recycle/Waste bin is available at an upcharge of **\$571 list**, add WL - Waste Bin Left or WR - Waste Bin Right to the model number. An optional Cutlery Tray is available at an upcharge of **\$61 list**. Mini fridge is not available in this configuration.

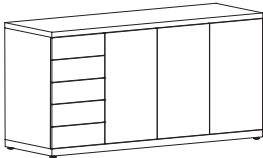
DIMENSION KEY
 W - width
 D - depth
 H - height

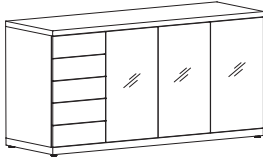
CODE DESCRIPTION
 GP - Back-Painted Glass Top
 Z - Back-Painted Glass Doors

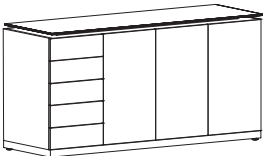
STANDARD FINISHES
 For a complete list of standard wood finishes, please see page 347.

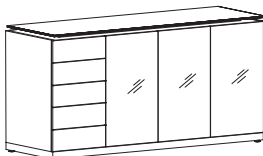
BASE PLATES
 Base plates are available in Gloss Aluminum, Laminate or Wood, please specify requirement on order.

NUVO | BUFFETS

Description	Model	Oak Cherry Maple Laminate			W	D	H	Weight	Cube
		Walnut							
	51BU72203507	6367	7005	71.5	20	35	330	36	
	51BU72243507	6652	7316	71.5	24	35	343	42	
	51BU84203507	7323	8057	83.5	20	35	384	42	
	51BU84243507	7649	8413	83.5	24	35	400	49	

	51BU72203507Z	7911	8703	71.5	20	35	345	36
	51BU72243507Z	8195	9013	71.5	24	35	358	42
	51BU84203507Z	9097	10007	83.5	20	35	402	42
	51BU84243507Z	9423	10367	83.5	24	35	417	49

	51BUGP72203507	9269	10196	71.5	20	35	370	36
	51BUGP72243507	10132	11144	71.5	24	35	391	42
	51BUGP84203507	10659	11724	83.5	20	35	431	42
	51BUGP84243507	11653	12818	83.5	24	35	455	49

	51BUGP72203507Z	10812	11893	71.5	20	35	385	36
	51BUGP72243507Z	11676	12845	71.5	24	35	406	42
	51BUGP84203507Z	12433	13676	83.5	20	35	448	42
	51BUGP84243507Z	13430	14771	83.5	24	35	473	49

ORDERING NOTES: An optional Recycle/Waste bin, located behind the right door, is available at an upcharge of **\$571 list**, add W - Waste Bin to the model number. An optional Cutlery Tray is available at an upcharge of **\$61 list**. An optional mini fridge, located behind the right door, is available on 24" deep units at an upcharge of **\$2638**, add F - fridge to model number.

ORDERING PROCEDURE

To order, please specify the following:
 1) Krug product model number
 2) Wood species and finish

CODE DESCRIPTION

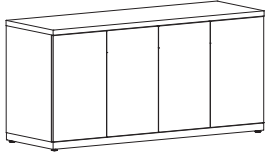
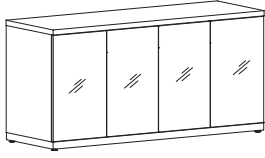
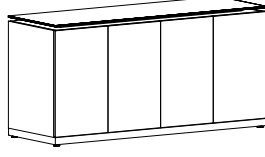
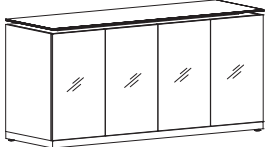
GP - Back-Painted Glass Top
 Z - Back-Painted Glass Doors

STANDARD FINISHES

For a complete list of standard wood finishes, please see page 347.

BASE PLATES

Base plates are available in Gloss Aluminum, Laminate or Wood, please specify requirement on order.

Description	Model	Oak Cherry Maple Laminate		W	D	H	Weight	Cube
		Walnut						
4 Hinged Doors 	51BU72203511	5137	5649	71.5	20	35	266	36
	51BU72243511	5419	5961	71.5	24	35	279	42
	51BU84203511	5905	6496	83.5	20	35	310	42
	51BU84243511	6230	6855	83.5	24	35	325	49
4 Hinged Back-Painted Glass Doors 	51BU72203511Z	7193	7913	71.5	20	35	286	36
	51BU72243511Z	7478	8225	71.5	24	35	299	42
	51BU84203511Z	8275	9100	83.5	20	35	333	42
	51BU84243511Z	8597	9459	83.5	24	35	348	49
4 Hinged Doors, Back- Painted Glass Top 	51BUGP72203511	8037	8839	71.5	20	35	306	36
	51BUGP72243511	8899	9790	71.5	24	35	327	42
	51BUGP84203511	9241	10167	83.5	20	35	356	42
	51BUGP84243511	10235	11259	83.5	24	35	381	49
4 Hinged Back-Painted Glass Doors, Back-Painted Glass Top 	51BUGP72203511Z	10094	11110	71.5	20	35	326	36
	51BUGP72243511Z	10959	12056	71.5	24	35	347	42
	51BUGP84203511Z	11610	12771	83.5	20	35	380	42
	51BUGP84243511Z	12604	13861	83.5	24	35	404	49

ORDERING NOTES: An optional Recycle/Waste bin, located behind the right door, is available at an upcharge of **\$571 list**, add W - Waste Bin to the model number. An optional Cutlery Tray is available at an upcharge of **\$61 list**. An optional mini fridge, located behind the right door, is available on 24" deep units at an upcharge of **\$2638**, add F - fridge to model number.

DIMENSION KEY

W - width
D - depth
H - height

CODE DESCRIPTION

GP - Back-Painted Glass Top
Z - Back-Painted Glass Doors

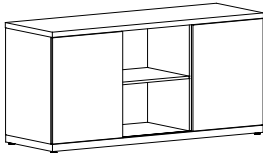
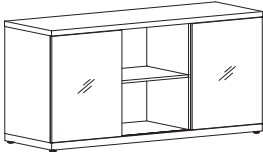
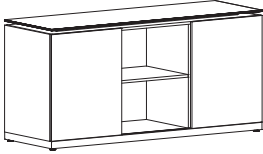

STANDARD FINISHES

For a complete list of standard wood finishes, please see page 347.

BASE PLATES

Base plates are available in Gloss Aluminum, Laminate or Wood, please specify requirement on order.

NUVO | BUFFETS

Description	Model	Oak	Cherry	Walnut	W	D	H	Weight	Cube
		Maple	Laminate						
	51BUS72203511	5657	6222	71.5	20	35	252	36	
	51BUS72243511	5939	6534	71.5	24	35	265	42	
	51BUS84203511	6505	7155	83.5	20	35	294	42	
	51BUS84243511	6831	7513	83.5	24	35	309	49	
	51BUS72203511Z	7199	7920	71.5	20	35	267	36	
	51BUS72243511Z	7484	8232	71.5	24	35	280	42	
	51BUS84203511Z	8280	9109	83.5	20	35	311	42	
	51BUS84243511Z	8607	9467	83.5	24	35	326	49	
	51BUSGP72203511	8556	9412	71.5	20	35	292	36	
	51BUSGP72243511	9419	10363	71.5	24	35	313	42	
	51BUSGP84203511	9840	10826	83.5	20	35	340	42	
	51BUSGP84243511	10834	11917	83.5	24	35	365	49	
	51BUSGP72203511Z	10101	11110	71.5	20	35	307	36	
	51BUSGP72243511Z	10964	12062	71.5	24	35	328	42	
	51BUSGP84203511Z	11617	12778	83.5	20	35	358	42	
	51BUSGP84243511Z	12610	13873	83.5	24	35	382	49	

ORDERING NOTES: An optional mini fridge is available on 24" deep units at an upcharge of **\$2638**, add FL fridge left or FR fridge right to model number.

ORDERING PROCEDURE

To order, please specify the following:
 1) Krug product model number
 2) Wood species and finish

CODE DESCRIPTION

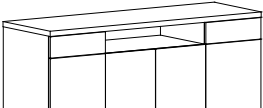
GP - Back-Painted Glass Top
 Z - Back-Painted Glass Doors

STANDARD FINISHES

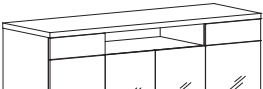
For a complete list of standard wood finishes, please see page 347.

BASE PLATES

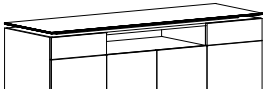
Base plates are available in Gloss Aluminum, Laminate or Wood, please specify requirement on order.

Description	Model	Oak	Cherry	Walnut	W	D	H	Weight	Cube
		Maple	Laminate						
 Drawer/Door, Open/ 2 Doors, Drawer/Door	51BU72203513	6211	6833	6833	71.5	20	35	294	36
	51BU72243513	6495	7145	7145	71.5	24	35	307	42
	51BU84203513	7145	7860	7860	83.5	20	35	342	42
	51BU84243513	7467	8215	8215	83.5	24	35	358	49

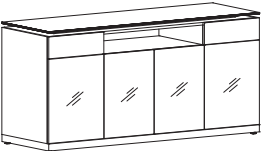
NOTE: For Media Buffet version with vents & cable access add M to model number and **\$505 list.**

 Back-Painted Glass Drawer/Door, Open/2 Doors, Drawer/Door	51BU72203513Z	8269	9096	9096	71.5	20	35	313	36
	51BU72243513Z	8553	9410	9410	71.5	24	35	326	42
	51BU84203513Z	9511	10463	10463	83.5	20	35	365	42
	51BU84243513Z	9836	10818	10818	83.5	24	35	380	49

NOTE: For Media Buffet version with vents & cable access add M to model number and **\$505 list.**

 Drawer/Door, Open/ 2 Doors, Drawer/Door, Back-Painted Glass Top	51BUGP72203513	9114	10022	10022	71.5	20	35	334	36
	51BUGP72243513	9975	10975	10975	71.5	24	35	355	42
	51BUGP84203513	10481	11527	11527	83.5	20	35	389	42
	51BUGP84243513	11472	12618	12618	83.5	24	35	413	49

NOTE: For Media Buffet version with vents & cable access add M to model number and **\$505 list.**

 Back-Painted Glass Drawer/Door, Open/2 Doors, Drawer/Door, Back-Painted Glass Top	51BUGP72203513Z	11170	12287	12287	71.5	20	35	353	36
	51BUGP72243513Z	12035	13240	13240	71.5	24	35	374	42
	51BUGP84203513Z	12846	14130	14130	83.5	20	35	411	42
	51BUGP84243513Z	13842	15222	15222	83.5	24	35	436	49

NOTE: For Media Buffet version with vents & cable access add M to model number and **\$505 list.**

ORDERING NOTES: An optional Recycle/Waste bin, located behind the right door, is available at an upcharge of **\$571 list**, add W - Waste Bin to the model number. An optional Cutlery Tray is available at an upcharge of **\$61 list**. An optional mini fridge, located behind the right door, is available on 24" deep units at an upcharge of **\$2638**, add F - fridge to model number.

DIMENSION KEY

W - width
D - depth
H - height

CODE DESCRIPTION

GP - Back-Painted Glass Top
Z - Back-Painted Glass Doors

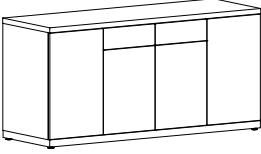
STANDARD FINISHES

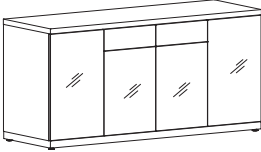
For a complete list of standard wood finishes, please see page 347.

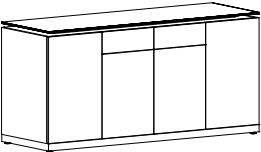
BASE PLATES

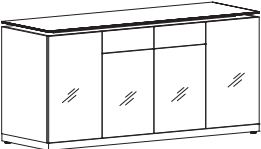
Base plates are available in Gloss Aluminum, Laminate or Wood, please specify requirement on order.

NUVO | BUFFETS

Description	Model	Oak Cherry Maple Laminate	Walnut	W	D	H	Weight	Cube
 Door, Drawer/Door, Drawer/Door, Door	51BU72203514	6211	6833	71.5	20	35	298	36
	51BU72243514	6495	7145	71.5	24	35	311	42
	51BU84203514	7145	7860	83.5	20	35	347	42
	51BU84243514	7467	8215	83.5	24	35	362	49

 Back-Painted Glass Door, Drawer/Door, Drawer/Door, Door	51BU72203514Z	8529	9383	71.5	20	35	308	36
	51BU72243514Z	8812	9693	71.5	24	35	331	42
	51BU84203514Z	9809	10790	83.5	20	35	359	42
	51BU84243514Z	10133	11145	83.5	24	35	385	49

 Door, Drawer/Door, Drawer/Door, Door, Back-Painted Glass Top	51BUGP72203514	9114	10022	71.5	20	35	338	36
	51BUGP72243514	9975	10975	71.5	24	35	359	42
	51BUGP84203514	10481	11527	83.5	20	35	394	42
	51BUGP84243514	11472	12618	83.5	24	35	418	49

 Back-Painted Glass Door, Drawer/Door, Drawer/Door, Door, Back-Painted Glass Top	51BUGP72203514Z	11281	12407	71.5	20	35	348	36
	51BUGP72243514Z	12035	13240	71.5	24	35	379	42
	51BUGP84203514Z	12971	14269	83.5	20	35	405	42
	51BUGP84243514Z	13842	15222	83.5	24	35	441	49

ORDERING NOTES: An optional Recycle/Waste bin, located behind the right door, is available at an upcharge of **\$571 list**, add W - Waste Bin to the model number. An optional Cutlery Tray is available at an upcharge of **\$61 list**. An optional mini fridge, located behind the right door, is available on 24" deep units at an upcharge of **\$2638**, add F - fridge to model number.

ORDERING PROCEDURE

To order, please specify the following:
1) Krug product model number
2) Wood species and finish

CODE DESCRIPTION

GP - Back-Painted Glass Top
Z - Back-Painted Glass Doors

STANDARD FINISHES

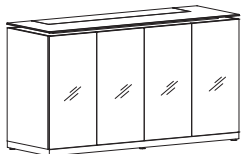
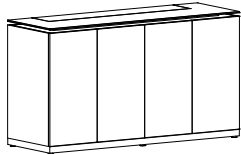
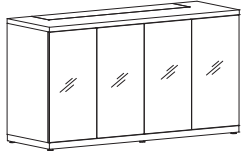
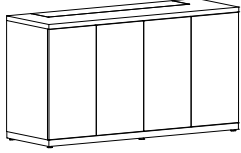
For a complete list of standard wood finishes, please see page 347.

BASE PLATES

Base plates are available in Gloss Aluminum, Laminate or Wood, please specify requirement on order.

NUVO | BUFFETS WITH TV LIFT

Description	Model	Oak	Cherry	Walnut	W	D	H	Weight	Cube
		Maple	Laminate						
4 Doors with TV Lift	51TV722439	12791		14070	71.5	24	39	345	49
	51TV842439	14711		16180	83.5	24	39	402	57
4 Back-Painted Glass Doors with TV Lift	51TV722439Z	16794		18474	71.5	24	39	368	49
	51TV842439Z	19313		21245	83.5	24	39	429	57
4 Doors with TV Lift, Back-Painted Glass Top	51TVGP722439	14334		15767	71.5	24	39	372	49
	51TVGP842439	16483		18132	83.5	24	39	433	57
4 Back-Painted Glass Doors with TV Lift, Back-Painted Glass Top	51TVGP722439Z	18339		20171	71.5	24	39	395	49
	51TVGP842439Z	21090		23198	83.5	24	39	460	57



ORDERING NOTE: Cabinet is standard with 4 shelves 12 1/2" deep.

DIMENSION KEY

W - width
D - depth
H - height

CODE DESCRIPTION

GP - Back-Painted Glass Top
Z - Back-Painted Glass Doors

STANDARD FINISHES

For a complete list of standard wood finishes, please see page 347.

BASE PLATES

Base plates are available in Gloss Aluminum, Laminate or Wood, please specify requirement on order.

NUVO | HOSPITALITY CARTS

Description	Model	Laminate			W	D	H	Weight	Cube
		Oak Cherry Maple	Walnut						
Hospitality Cart	51MSC422035	4928	5420		42	20	35	213	22



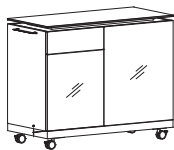
Hospitality Cart - Back-Painted Glass Doors	51MSC422035Z	6144	6760		42	20	35	227	22
---	--------------	------	------	--	----	----	----	-----	----



Hospitality Cart, Back-Painted Glass Top	51MSCGP422035	6784	7463		42	20	35	240	22
--	---------------	------	------	--	----	----	----	-----	----



Hospitality Cart - Back-Painted Glass Doors, Back-Painted Glass Top	51MSCGP422035Z	8002	8803		42	20	35	275	22
---	----------------	------	------	--	----	----	----	-----	----



ORDERING NOTES:

Hospitality Cart is standard with Cutlery Tray & Recycle/Waste bin on the left and two adjustable shelves on the right.

ORDERING PROCEDURE

To order, please specify the following:

- 1) Krug product model number
- 2) Wood species and finish

CODE DESCRIPTION

- GP - Back-Painted Glass Top
Z - Back-Painted Glass Doors

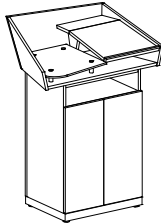
STANDARD FINISHES

For a complete list of standard wood finishes, please see page 347.

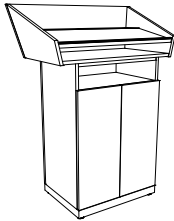
BASE PLATES

Base plates are available in Gloss Aluminum, Laminate or Wood, please specify requirement on order.

Description	Model	Oak Cherry Maple			W	D	H	Weight	Cube
		Laminate	Walnut						
Lectern with Glass Shelf & Closed Lower Storage	51LN372250-11	6827	7759		37	22	50	234	30



Lectern Full Width & Closed Lower Storage	51LN372250-11	5953	6544		37	22	50	230	30
---	---------------	------	------	--	----	----	----	-----	----

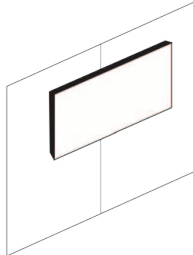


ORDERING NOTES: Lecterns feature grommets for cable management. Lecterns are available with casters, add M to the model # and an upcharge of **\$152**. All hinged doors on Lecterns feature standard locks.

Lectern options:

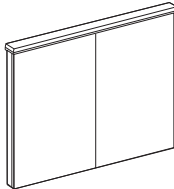
Altinex Box : **\$1273 list.**
 Power Bar : **\$208 list**
 Reference Light : **\$443 list**

Media Wall	51MW8483	3538	3892		84	4	83	115	16
------------	----------	------	------	--	----	---	----	-----	----



NOTES: Media Wall features a T.V. mounting bracket and cable channel for cords to exit at the floor. Media wall can be mounted without a credenza or buffet if no equipment other than the TV is required. Please include TV size on each purchase order, since machining required is dependent on the TV size.

Sliding Door Media Board	51VBS4848	4399	4841		48	-	48	120	16
--------------------------	-----------	------	------	--	----	---	----	-----	----



NOTE: Sliding Door Media Board includes white board, eraser and four dry erase makers. For laminate orders marker tray is Black Palette. Sliding Doors slide open and closed independently of each other.

DIMENSION KEY
 W - width
 D - depth
 H - height

CODE DESCRIPTION
 X - Full Width
 11 - Closed Shelves Below

STANDARD FINISHES
 For a complete list of standard wood finishes, please see page 347.

BASE PLATES
 Base plates are available in Gloss Aluminum, Laminate or Wood, please specify requirement on order.

V2 MODULAR | TABLE OF CONTENTS

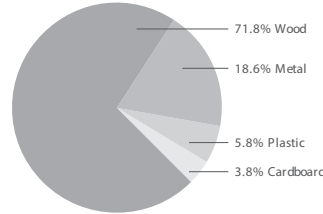
V2 MODULAR

85	Environmental Summary
86	Features & Options
90	Power Options
95	Modular Configurations
96	Seating Capacities
98	Sample Configurations
100	Rectangular & Arc Tables
101	Wave Tables
102	Curve Tables
103	Swept Tables
104	Trapezoid & Curved Trapezoid Tables
105	Visio Tables
106	Square & Round Tables
108	Connecting Tops
109	Modesty Panels
111	Legs & Power
112	PowerPorts
116	Media

LEED CERTIFICATION



MATERIAL CONTENT:



PRE-CONSUMER RECYCLED CONTENT - 78.9%

POST-CONSUMER RECYCLED CONTENT - 21.1%

Credit	Description	CONTRIBUTES To
Credit 2.1 - 2.2	Construction Waste Management	1-2 point(s)
Credit 3.3	Resource Reuse	1 point
Credit 4.1	Recycled Content	1 point
Credit 4.2	Recycled Content	1 point
Credit 4.5	Low Emitting Materials, (MUST BE REQUESTED) Composite Wood & Laminate Adhesives	1 point
Credit 5.1	Regional Materials*	1 point
Credit 6	Rapidly Renewable Materials (MUST BE REQUESTED)	1 point
Credit 7	Certified Wood (MUST BE REQUESTED)	1 point

*This credit is only applicable if in total 20% of the combined value of the procurement of construction materials and in the furniture are manufactured within a radius of 500 miles. This credit will apply if the installation of the finished product occurs within 500 miles of Kitchener, Ontario.



level® CERTIFICATION

BIFMA's e3 Furniture Sustainability Standard is a voluntary, multi-attribute standard that measures the degree of sustainability of furniture. This standard evaluates product and company environmental attributes and compliance systems in a wide range of elements which include Materials, Energy & Atmosphere, Human & Ecosystem Health and Social Responsibility. V2 products have earned level®, BIFMA's sustainability certification program for furniture, certification through third-party verification against the e3 standard. All V2 products can be supplied with level® certification. In order to accomplish this, the product must also be ordered with the air-emissions-certification option. Contact customer service for information and upcharges.



FSC
www.fsc.org
FSC® C021899

the mark of responsible forests

AIR-EMISSIONS

All V2 products can be supplied with air-emissions-certified materials. Contact customer service for information and upcharges.

FSC®

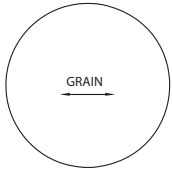
FSC® In 2005, Krug received Forest Stewardship Council® (FSC®) Chain-of-Custody certification for our manufacturing facilities. The FSC® Chain-of-Custody tracks certified wood from seedling to final sale. It verifies that the material for our FSC® certified products only come from well-managed, FSC®-certified forests and other controlled sources. FSC® is dedicated to the promotion of responsible forest management worldwide helping to take care of forests for future generations. V2 and other Krug products can be specified with FSC® Certification. Contact customer service for further information, pricing and lead times..



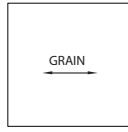
In addition, architects, designers, and building professionals can specify FSC®-certified products in order to achieve a point from the U.S. Green Building Council's Leadership in Energy and Environmental Design (LEED) Rating System.

V2 MODULAR | FEATURES & OPTIONS

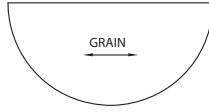
MODULAR TOP SHAPES



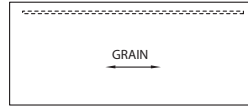
Round



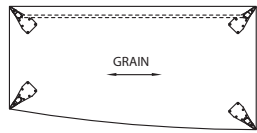
Square



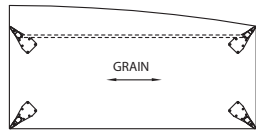
Half Round



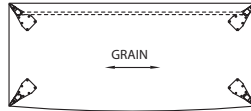
Rectangular



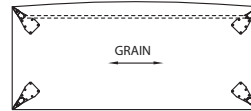
Swept (Left shown)



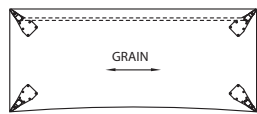
Curve (Left shown)



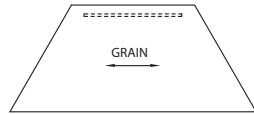
Wave



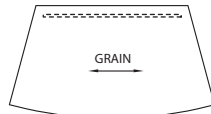
Arc



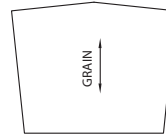
Wave Inverted



Trapezoid



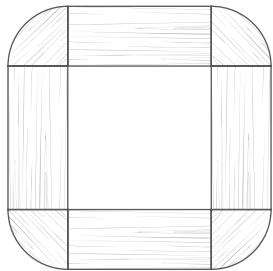
Curved Trapezoid



Visio End

Dotted line depicts which side modesty panel is available on. Round, Curved Trapezoid and Visio End are not available with modesty panels. Grommets, Surface Modules, PowerPorts and Ports when specified are positioned on the same side as the modesty panel. Please note on the Curve tables that the back leg on the longer edge is set back 6" from the back edge.

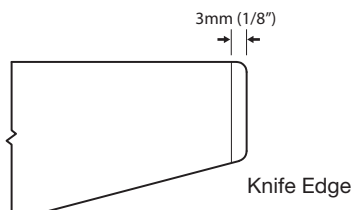
GRAIN DIRECTION - WOOD VENEER AND WOOD GRAIN LAMINATE



Please note: On V2 corner CONNECTOR TABLES, the grain runs at 45° angle. For all other V2 Modular Meeting Tables, the grain runs lengthwise, except for Curved Trapezoid, and Visio End where the grain runs up and down. For wood modesty panels the grain runs vertically.

EDGE OPTIONS - MODULAR TABLES

V2 product offers 12 table tops in Wood or Laminate with a distinct Knife edge profile.



Top thickness - 1 1/8"

V2 MODULAR | FEATURES & OPTIONS

WOOD FINISH

A five step catalyzed varnish finish that when dry has a sheen value of 32° is applied to all V2 Modular table tops.

METAL FINISH

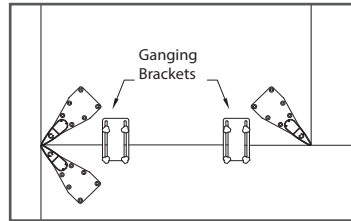
V2 components are comprised of satin anodized and powder coated Silver Metallic finishes.

GANGING MODULE

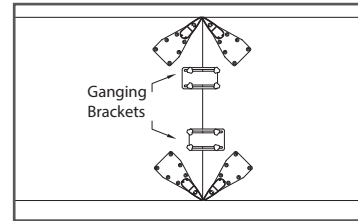
Ganging Modules are recommended when 2 or more tables are being joined to one another. These ganging modules should be ordered along with the tables as a separate line item on the order. All tables come pre-drilled for ganging capabilities. Please note corner connector tops without legs are supplied with an alternative mounting plate. Corner connector tops with legs require ganging modules. The Ganging Modules can be used to prevent movement of the tables, enhance stability and keep the legs perfectly aligned. It is recommended to use 2 brackets per seam.



BACK TO END CONNECTION

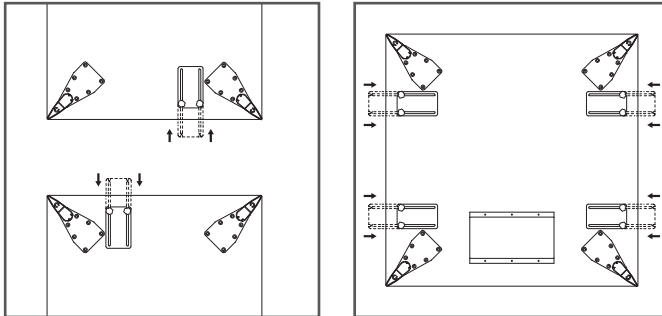


END TO END CONNECTION



SELF STORING

The Ganging Module can be neatly tucked underneath the table and re-fastened when not being used, to join to another table in the future. This allows the flexibility and reconfigurability of the V2 Modular line when wanting to add or subtract tables from existing table configurations.



PACKAGING

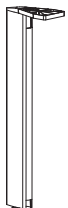
V2 packaging features recycled and recyclable cardboard. The product is shipped as separate components - legs are cartoned separate from table top.

However, the electrical is shipped already installed on table top. Table legs have to be attached to table top surface after delivery.

LEG OPTIONS

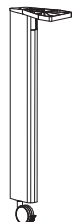
The V2 aluminum leg fastens to a die cast mounting plate. The mounting plate has a polished surface and is attached to the underside of the table using machine bolts. The mounting plate is 9 3/8" deep and tapers from 4" wide to 1/4" diameter and is 9/16" thick.

See Page 94 for wire management feature.



V2 LEGS WITH GLIDES

The V2 Modular legs come with the adjustable glides. There is 2 1/4" of height adjustment and these glides can be adjusted with 5/8" wrench.



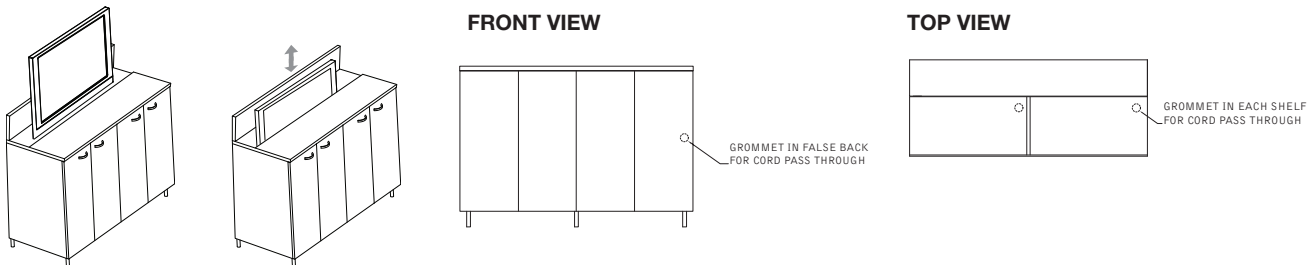
V2 LEGS WITH CASTERS

The V2 Modular legs come with 2" casters in a Silver Metallic finish. They have the ability to lock with a foot release lever located at the base of the wheel.

V2 MODULAR | FEATURES & OPTIONS

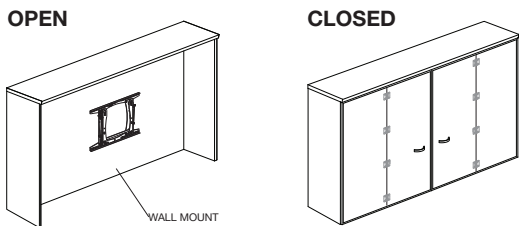
PLASMA SCREEN CABINETS

- 72" cabinets accommodate flat screen televisions up to 130lbs with dimensions no greater than 51 1/4" x 4 3/4" x 30"
- The 20" deep units do not come with storage shelves
- 24" deep units come with 4 shelves that measure 34 1/2" wide x 12 7/16" deep
- Grommet cut-outs are on each shelf for cord pass through
- Grommet cut-out is on center partition for cord pass through
- Comes with remote control to raise and lower television
- The remote has a radio frequency with 15 ft. operating distance



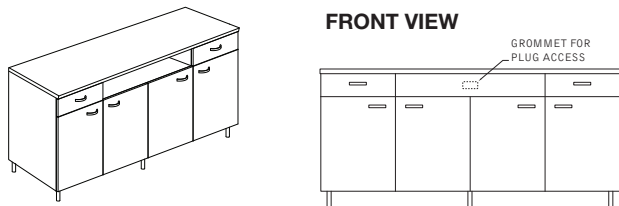
MEDIA HUTCHES

- 75" media hutches accommodate flat screen televisions up to 200lbs with dimensions no greater than 65" x 9" x 40"
- Media Hutches come standard with television wall mount
- The teardrop holes in the mount allow for quick connect/disconnect of the screen, thus simplifying installation and maintenance processes
- This display can be pulled and tilted by hand into any position from 0° to 15° tilt range and/or remain stationary



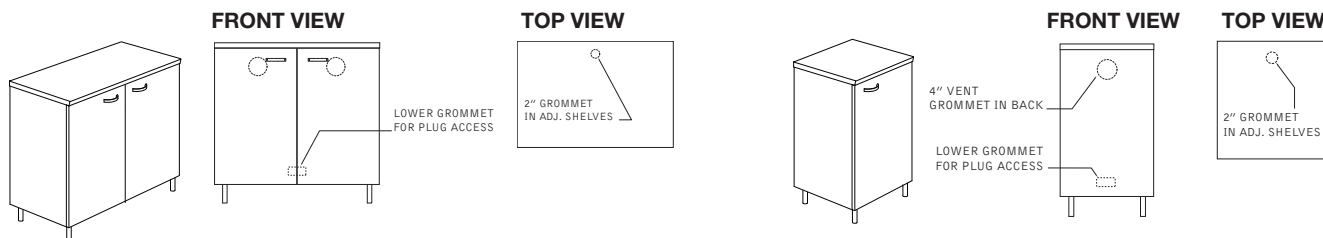
MEDIA BUFFETS

- Come with option of locks for an upcharge of **\$152 list**
- Opening on media buffet (space between drawers) measures 37 5/16" wide, 5 13/16" high
- Media buffets have an adjustable shelf that comes standard when ordered. Adjustable shelves are shipped in the middle position and are 1 3/16" thick.
- A grommet cut-out comes standard in the center of the media buffet opening
- Drawer depths measure 2.5" in depth, 15 3/16" wide



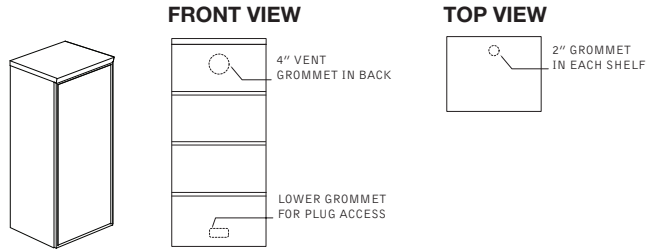
MEDIA PEDESTALS

- Grommet cut-outs are on each shelf
- Grommet cut-outs are on the top of the back and lower bottom of the back for wire pass through and plug access
- Come standard with two storage shelves



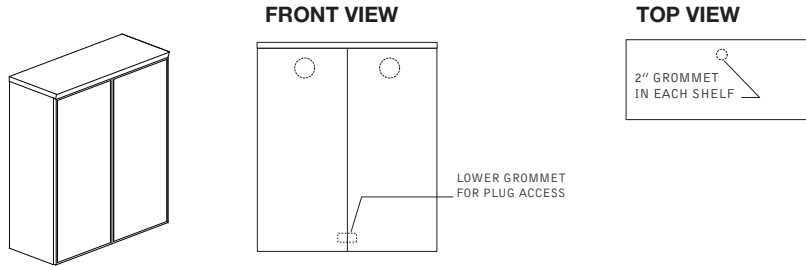
MEDIA PIERS - SINGLE

- Single 19" storage unit stacks on top of the work surface
- Media Piers should be used in conjunction with media pedestals
- Come standard with touch latch doors
- Grommet cut-outs are on every shelf in media piers at the back of each shelf
- Grommet cut-outs are on the top of the back and the lower back for plug and wire access



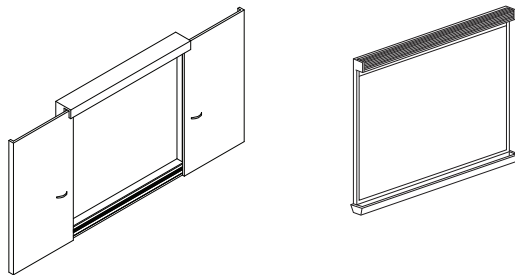
MEDIA PIERS - DOUBLE

- Double media piers are 36" wide with wood doors
- Come standard with touch latch doors
- Grommet cut-outs are on every shelf in media piers and at the back of each shelf
- Grommet cut-outs are on the top of the back and lower back for plug and wire access



VISUAL BOARDS & WHITE BOARD

- Includes white board and four dry erase markers.
- Doors slide straight out to the side
- Wall mountable that includes a roll-out presentation screen.



EDGE PROFILES - CONFERENCE ROOM CASEGOODS

V2 Conference Room Casework worksurfaces feature the Fino profile at 1 1/8" thickness.



DRAWER PULL

Four drawer pull styles are available on V2 Conference Room Casework Visual Boards, Plasma Screen Cabinet, Media Hutch with doors, Media Buffet and Media Pedestals: Como, Mira, Sono and Massa. The four drawer pull styles are only available in a satin metallic finish. Please note pull selection on Purchase Order. Orders will not be entered until a pull is specified.

SONO

MIRA

COMO

MASSA



V2 MODULAR | POWER OPTIONS



POWERPORT

The V2 Modular PowerPort made from aluminum and featuring a hinged lid, provides a functional and attractive solution for connectivity. The PowerPort comes standard 2 accessible power outlets & 1 side utility outlet powered by a 10' plug-in cord; 2 RJ45 (category 5/6) each with hard wired 10' data cords; 2 velcro wire managers and metal PowerPort shroud.

The PowerPort is a UL/CSA-approved power/data power bar, (Port) which includes three 115-volt electrical convenience outlets, and two RJ45 communication ports - all easily accessed just under the worksurface. The PowerPort is Category 5/6 compatible.

The PowerPort can be specified without the power bar (Port), to serve as a grommet for wire management, or to enable future power-up of the tables. It is 7.5" wide by 4" long, and features an aluminum hinged lid that is designed to be in the closed position when cables pass through to the plug-in. The PowerPort can accommodate multiple cables at once, as well as transformer plugs, through the worksurface.

Power cord is 10 ft. long, data cable is 14 ft. long.

PowerPorts can be specified in 3 different locations (left, right or center) depending on the size of the meeting table surface. On surfaces that are smaller than 60", PowerPorts are available only in the center position.

See Page xx for options and location codes for selecting the PowerPort location for each table top.



SURFACE MODULE

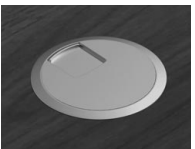
The V2 Surface Module is a lower cost alternative to the PowerPort. It is compact and convenient and positions the plug-in on the worksurface itself, instead of underneath it.

A Surface Module comes with two power receptacles above the work surface and one power receptacle below the work surface, which allows you to connect power to additional tables or configurations. In addition the Surface Module also comes with one USB Port - one USB printer port, one RJ11 and one RJ45. Each receptacle has a 12 Amp, 120 Volt, 60Hz capacity and comes standard with a 10' heavy duty power cord with a right angle plug.

The Surface Module has an angled face, that's easy to see and operate. The RJ45 Port allows connection to High Speed DSL or Internet and provides access to cable modem, network or internet router. In addition, a power plug exists for cell phone and laptop. There are two USB Ports - one for input and one for output to accommodate almost any electrical needs. The surface module is available in a black finish only.

Surface Modules can be specified in 3 different locations (Left, Right or Center) depending on the size of the meeting table surface. On surfaces that are smaller than 60", Surface Modules are available only in the center position.

See Page 90 for options and location codes for selecting the Surface Module location for each table top.



ROUND GROMMET

A round grommet with an open and shut mousehole serves to provide cable passage for areas not requiring a large opening.

Round grommet Silver Metallic, 60 mm dia. (2 3/8" approx.)

Round grommets do not provide electrical service.

Grommets can be specified in 3 different locations (left, right or center) depending on the size of the meeting table surface. On surfaces that are smaller than 60", grommets are available only in the center position.

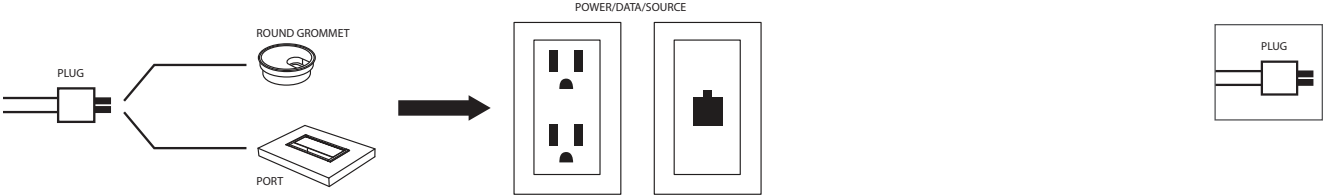
One round grommet per table is provided at no charge, additional round grommets are available for an upcharge of **\$152 list** per grommet.

See Page 90 for options and location codes for selecting the Grommet location for each table top.

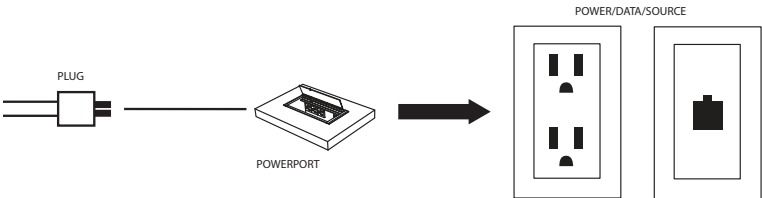
V2 MODULAR | POWER OPTIONS

SCENARIO 1

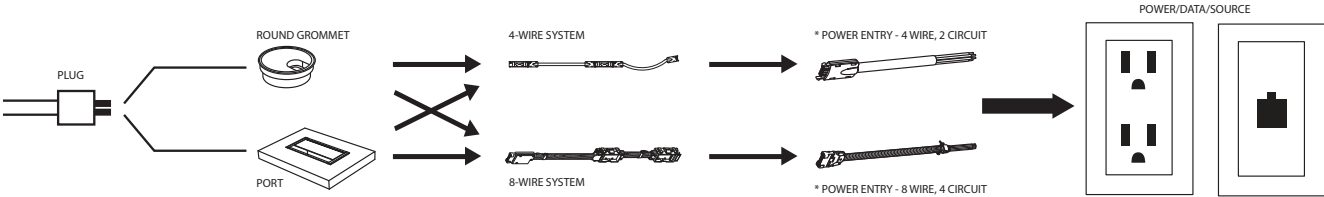
This symbol refers to: Electrical, Fax, Modem, Telephone, and Network Data



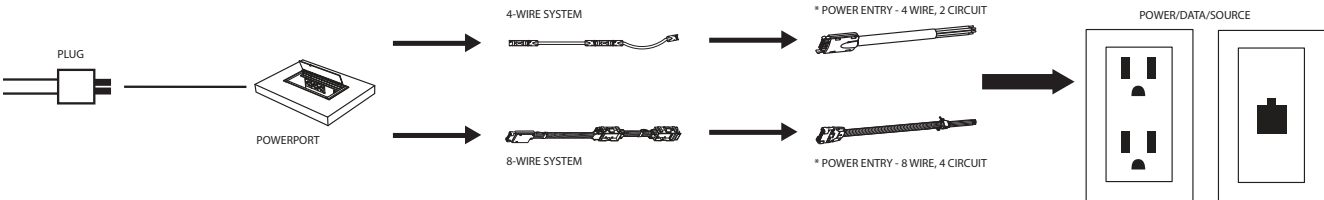
SCENARIO 2



SCENARIO 3



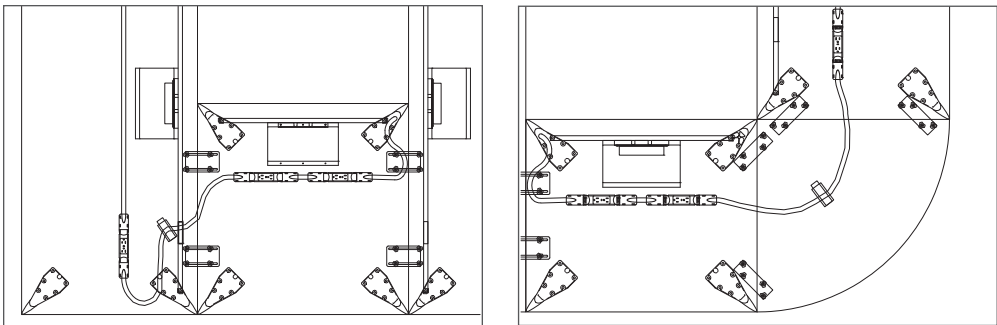
SCENARIO 4



*Power Entry (4 wire, 2 circuit and 8 wire, 4 circuit) are hard wired to power source in the wall or floor.

WIRING SOLUTIONS AND TABLE CONFIGURATIONS

Below are 2 configurations which demonstrate the 4-Wire System, where the 42" Jumper is required on the underside of the table. Same layout applies to the 8-Wire System.

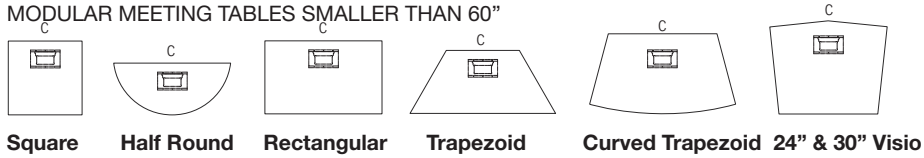


V2 MODULAR | POWER OPTIONS

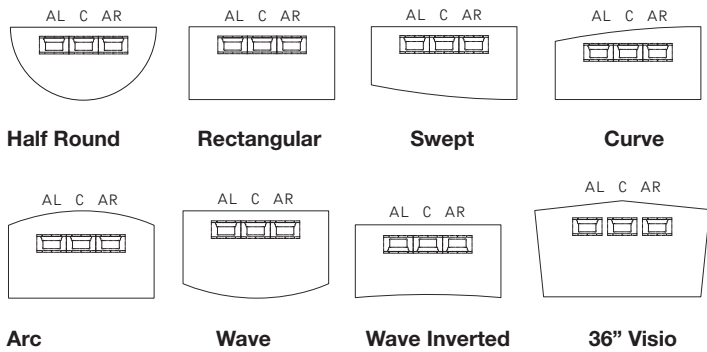
Non-standard locations can be specified, although there are restrictions due to leg positions, and modesty panel positions. An upcharge of **\$152 list** per non-standard grommet is applicable, contact Customer Service for assistance. Modular Table Tops smaller than 60" have the power access available only in the 'C' position. Table tops greater than 60" can have the power access specified in as many as three locations (AR, AL and C). The only exception to this rule is the 36" visio tables which can be specified with three power access positions, AR- right corner, AL- left corner, and C- center.

POWERPORT/PORT POSITIONS -Modesty Panels are shown on the same side as the PowerPort/Ports.

MODULAR MEETING TABLES SMALLER THAN 60"

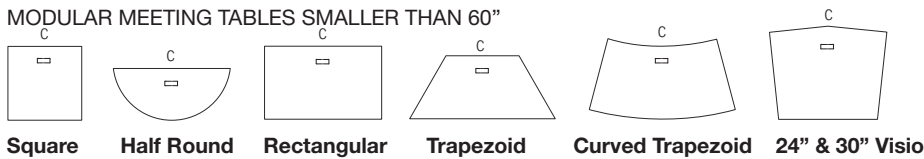


MODULAR MEETING TABLES 60" OR LARGER

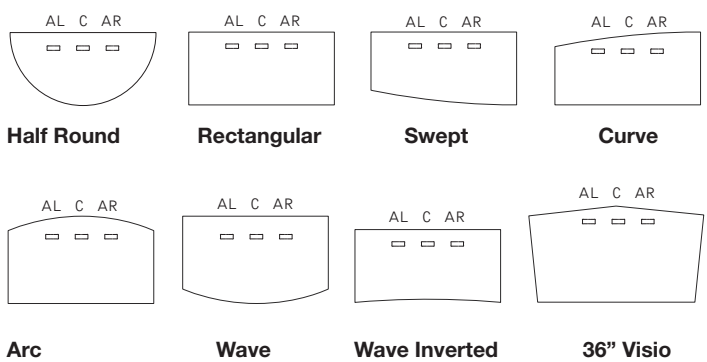


SURFACE MODULE/GROMMET POSITIONS - Modesty Panels are shown on the same side as the Surface Modules.

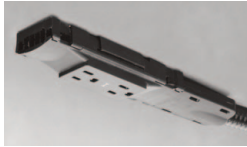
MODULAR MEETING TABLES SMALLER THAN 60"



MODULAR MEETING TABLES 60" OR LARGER



Modesty Panels are shown on the same side as the Round Grommets. One round grommet per table is provided at no charge, additional round grommets are available for an upcharge of **\$152 list** per grommet in standard positions.



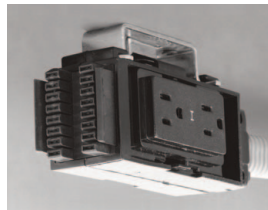
4-WIRE SYSTEM

The 4-Wire System is a economical power distribution solution that is easy to specify, install, and re-configure.

Features:

- 4-wires, 2 circuits, 20 Amps each
- 13 - duplex receptacles per circuit, 26 - 15 Amp duplex receptacles per power infeed maximum
- Easy to specify
- Easy to install and reconfigure
- Requires less space
- UL Listed as a Manufactured Wiring System
- More economical than 8-wire system
- RoHS Compliancy available upon request; Cradle to Cradle

- 61EC4-30 - 4 wire, 2 circuit system, 30" table
- 61EC4-36 - 4 wire, 2 circuit system, 36" table
- 61EC4-42 - 4 wire, 2 circuit system, 42" table
- 61EC4-48 - 4 wire, 2 circuit system, 48" table
- 61EC4-54 - 4 wire, 2 circuit system, 54" table
- 61EC4-60 - 4 wire, 2 circuit system, 60" table
- 61EC4-66 - 4 wire, 2 circuit system, 66" table
- 61EC4-72 - 4 wire, 2 circuit system, 72" table



8-WIRE SYSTEM

The 8-Wire System offers a high quality, cost effective answer to your power distribution needs. The modular system is adaptable to all architectural elements. The modularity of the System makes it simple to specify, order and install.

Features:

- UL recognized & listed
- Approved for use in New York City
- RoHS compliancy available upon request; cradle to cradle
- 20 Amp system available in 4 circuit configurations
- Allows for up to 52 duplex receptacles or desktop accessories using Interconnect.

Can be used independently with grommet or PORT0.

- 61EC8-30 - 8 wire, 4 circuit system, 30" table
- 61EC8-36 - 8 wire, 4 circuit system, 36" table
- 61EC8-42 - 8 wire, 4 circuit system, 42" table
- 61EC8-48 - 8 wire, 4 circuit system, 48" table
- 61EC8-54 - 8 wire, 4 circuit system, 54" table
- 61EC8-60 - 8 wire, 4 circuit system, 60" table
- 61EC8-66 - 8 wire, 4 circuit system, 66" table
- 61EC8-72 - 8 wire, 4 circuit system, 72" table

All Krug's power access options can be used with or without the 4-Wire or 8-Wire System. These components can be ordered together, or at a later date as your power requirements change.

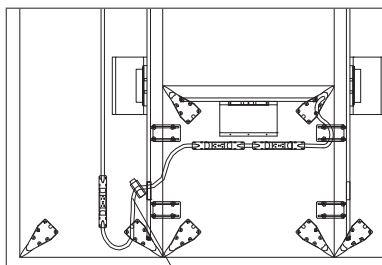
4-WIRE AND 8-WIRE - 42" JUMPERS

These longer jumper cables are required when connecting one table from the back to the end of another table using either the 4-Wire or 8-Wire System. These jumper cables allow you to daisychain each wired table to the next.

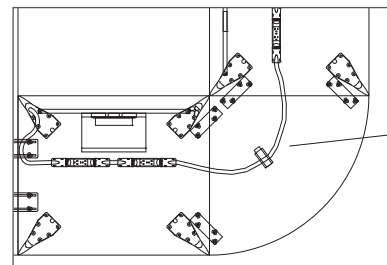


4-Wire Power Entry

8-Wire Power Entry



42" Jumper

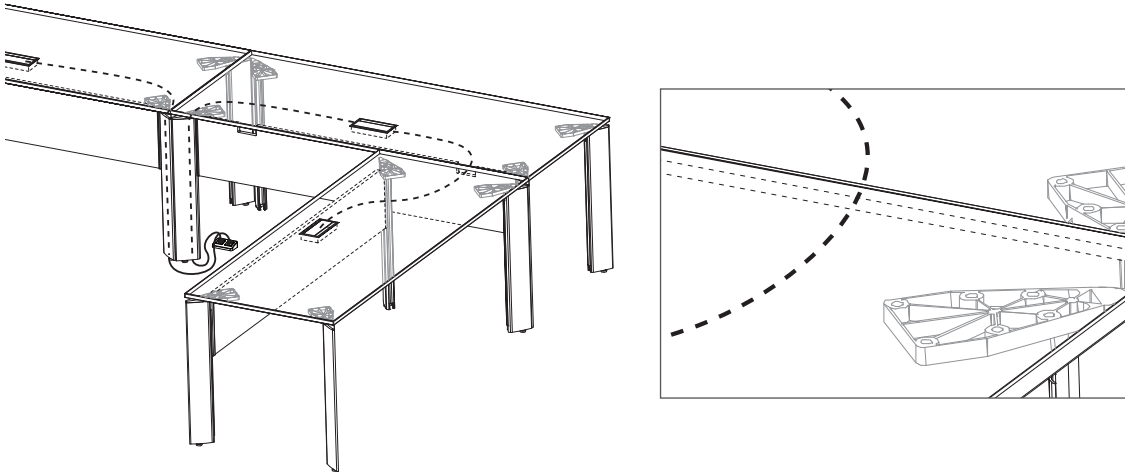


42" Jumper

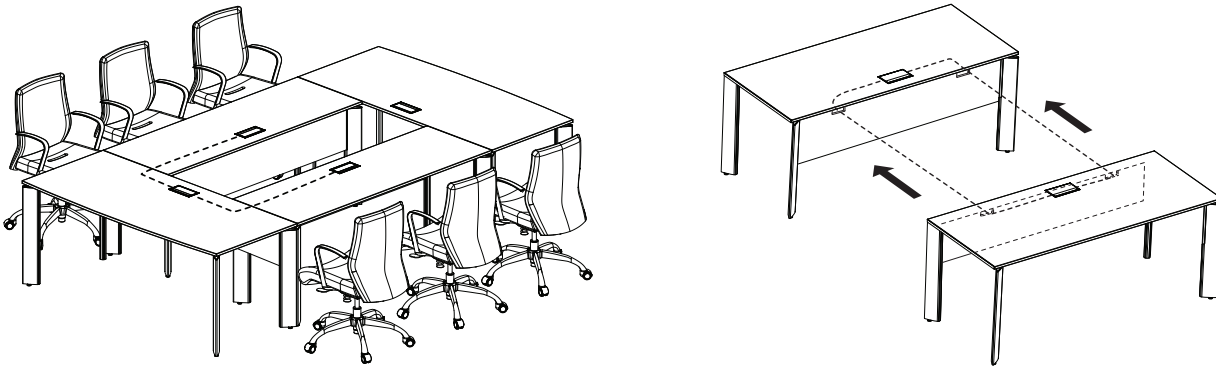
V2 MODULAR | POWER OPTIONS

Modesty panels are available with or without grommets.

Grommets on modesty panels are required for electrified tables that are positioned such that modesty panels are overlapping, so that cabling can pass through the overlapping modesty panels. Wiring either at 90° corners (when corner connector tables aren't used) or tables that are face-to-face adjoining require modesty panels to be ordered with grommets. Below is an example showing wiring passing through one table to another via a modesty panel with grommets.



Typical layouts when modesty panels with grommets are required below.



Typical layout when modesty panels without grommets can be used below.

WIRE MANAGEMENT

Wires are channeled through the leg and concealed with a snap-on cover which allows cord access to the top and bottom when required.

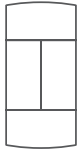
There is 2.2 in² of wire management capacity in the interior of the leg. Available with glides or casters.



V2 MODULAR | MODULAR CONFIGURATIONS

This is a sampling of some of the possible configurations in the V2 Modular Meeting Line

WAVE WITH RECTANGULAR TABLES



Model Number Qty.
61THW-7236 2
61THRT-7236 2

WAVE WITH RECTANGULAR TABLES



Model Number Qty.
61THW-7236 2
61THRT-7224 2

WAVE WITH RECTANGULAR TABLES



Model Number Qty.
61THRT-7236 4
61THW-7236 2

WAVE WITH WAVE INVERTED TABLES



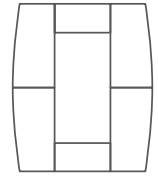
Model Number Qty.
61THW-7236 2
61THWI-7236 2

WAVE WITH SWEPT TABLES



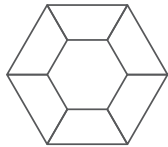
Model Number Qty.
61THW-6030 1
61THS-7236R 1
61THS-7236L 1

SWEPT WITH RECTANGULAR TABLES



Model Number Qty.
61THS-7236R 2
61THS-7236L 2
61THRT-4824 2

TRAPEZOID TABLES



Model Number Qty.
61THTZ-72-3636 6

TRAPEZOID TABLES



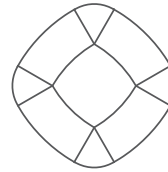
Model Number Qty.
61THTZ60-3030 2

60° CORNER CONNECTOR TOP WITH TRAPEZOID TABLES



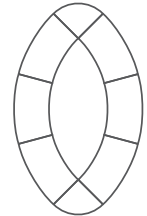
Model Number Qty.
61TC-3030-60 2
61THTZ60-3030 4

60° CORNER CONNECTOR TABLES WITH CURVED TRAPEZOID TABLES



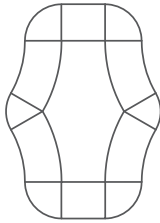
Model Number Qty.
61TC-3030-60 4
61TH30CT-30 4

90° CORNER CONNECTOR TABLES WITH CURVED TRAPEZOID TABLES



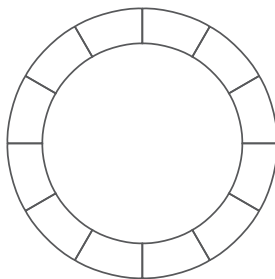
Model Number Qty.
61TC3030-90 2
61TH30CT-3060 6

90° AND 60° CORNER CONNECTOR TOPS WITH SQUARE AND CURVED TRAPEZOID TABLES



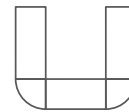
Model Number Qty.
61TC-3030-60 2
61TH30CT-3060 4
61THSQ-3030 2
61TC-3030-90 4

CURVED TRAPEZOID



Model Number Qty.
61TH30CT-3060 12

90° CORNER CONNECTOR TABLES WITH RECTANGULAR TABLES



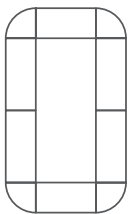
Model Number Qty.
61THRT-6030 1
61THRT-7230 2
61TC-3030-90 2

90° CORNER CONNECTOR TABLES WITH RECTANGULAR TABLES



Model Number Qty.
61TC-3636-90 1
61THRT-7236 2

90° CORNER CONNECTOR TABLES WITH RECTANGULAR TABLES



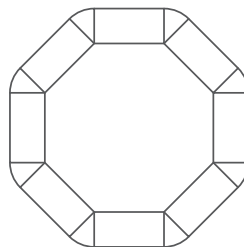
Model Number Qty.
61THRT-7236 4
61TC-3636-90 4

VISIO END WITH RECTANGULAR TABLES



Model Number Qty.
61THV-24 1
61THRT-7224 4

45° CORNER CONNECTOR TOP WITH RECTANGULAR TABLES



Model Number Qty.
61TC-2424-45 8
61THRT-4824 8

HALF ROUND WITH RECTANGULAR TABLES




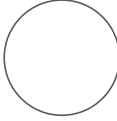



Model Number Qty.
61THDH-6030 2
61THRT-6030 2

HALF ROUND TABLES



Model Number Qty.
61THDH-6030 2









V2 MODULAR | SEATING CAPACITIES

Description	Top Size		Approx. Seating for long side Without modesty panel	Approx. Seating for End	Approx. Seating for Total Stand Alone
	Length	Width			
Square 	30	30	1	1	4
	36	36	1	1	4
	42	42	1	1	4
	48	48	1	1	4
Round 	36 DIA	N/A	1	1	4
	42 DIA	N/A	1	1	4
	48 DIA	N/A	1	1	4
	54 DIA	N/A	1	1	4
Half Round 	48	24	2	1	3
	60	30	2	2	4
Rectangular 	48	24	1	0	2
	54	24	1	0	2
	60	24	2	0	4
	66	24	2	0	4
	72	24	2	0	4
	48	30	1	1	4
	54	30	1	1	4
	60	30	2	1	6
	66	30	2	1	6
	72	30	2	1	6
	54	36	1	1	4
	60	36	2	1	6
66	36	2	1	6	
72	36	2	1	6	
Arc 	60	30-36	2	1	6
	72	30-36	2	1	6
	60	36-42	2	1	6
	72	36-42	2	1	6

ORDERING NOTES

If a modesty panel is used, there is no seating capacity on that side of the table. To establish seating capacities, an outside chair dimension of 24" has been used, plus an allowance of 5" between chairs, for a total of 29". This is an approximation and based on seating with 5 prong bases. When using chairs with different specifications be sure to adjust the approximate seating capacity accordingly. Since not all manufacturers use this same seating formula, when a seating capacity is in question, please contact Krug Customer Service to review the specific seating that is being used with Krug V2 Modular product.

V2 MODULAR | SEATING CAPACITIES

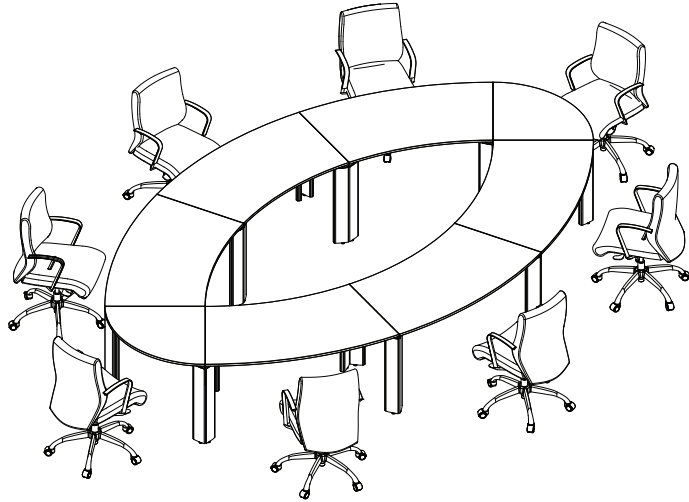
Description	Top Size		Approx. Seating for long side Without modesty panel	Approx. Seating for End	Approx. Seating for Total Stand Alone	
	Length	Width				
Swept 	60	36-30	2	1	6	
	72	36-30	2	1	6	
Curve 						
Wave 	60	30-31.5	2	1	6	
	72	30-31.5	2	1	6	
Wave Inverted 	60	30-28.5	2	1	6	
	72	30-28.5	2	1	6	
Trapezoid 	48	24	1	1	4	
	60	24	1	1	4	
	48	30	1	1	4	
	60	30	1	1	4	
	72	36	1	1	4	
Curved Trapezoid 	60	30	2	1	5	
Visio End 	24	N/A	1	1	5	
	30	N/A	1	1	5	
	36	N/A	2	1	6	
Corner Connecting Top 	45°	24	24	1	0	N/A
		30	30	1	0	N/A
		36	36	1	0	N/A
	60°	24	24	1	0	N/A
		30	30	1	0	N/A
		36	36	1	0	N/A
	90° (with or without legs)	24	24	1	0	N/A
		30	30	1	0	N/A
		36	36	1	0	N/A

ORDERING NOTES

If a modesty panel is used, there is no seating capacity on that side of the table. To establish seating capacities, an outside chair dimension of 24" has been used, plus an allowance of 5" between chairs, for a total of 29". This is an approximation and based on seating with 5 prong bases. When using chairs with different specifications be sure to adjust the approximate seating capacity accordingly. Since not all manufacturers use this same seating formula, when a seating capacity is in question, please contact Krug Customer Service to review the specific seating that is being used with Krug V2 Modular product.

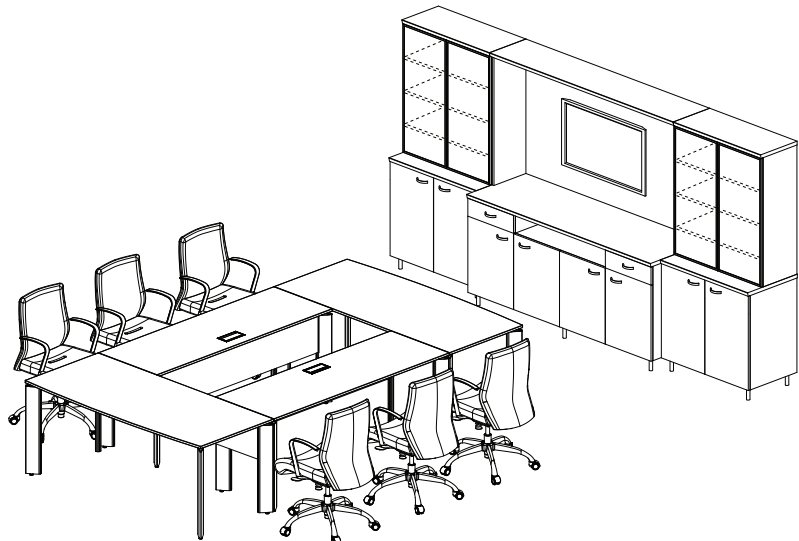
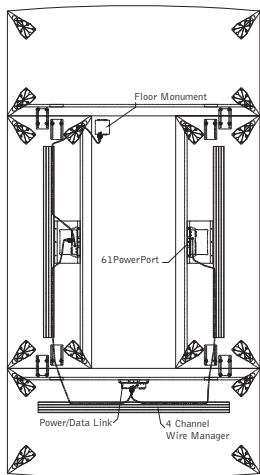
V2 MODULAR | SAMPLE CONFIGURATIONS

Model	QTY	Laminate with PVC Edge	Laminate with Wood Edge	Rift Oak, Cherry, Maple, Walnut	Anigre
61TC-3030-90-Q2	2	1168	1283	1283	1478
61TH30CT-3060	6	2023	2221	2221	2555
TABLE CONFIGURATION TOTAL		14474	15892	15892	18286



Model	QTY	Laminate w/ PVC Edge	Laminate w/ Wood Edge	Rift Oak, Cherry, Maple, Walnut	Anigre
61THW-7236-X21	(2)	2513	2847	2847	3206
PowerData/Link in Position "C"	1	348	348	348	348
61THRT-7224-X21	(2)	2214	2515	2515	2822
PowerPort in a "C" position	(2)	952	70	952	952
TABLE TOTAL LIST		11706	11212	12976	14308

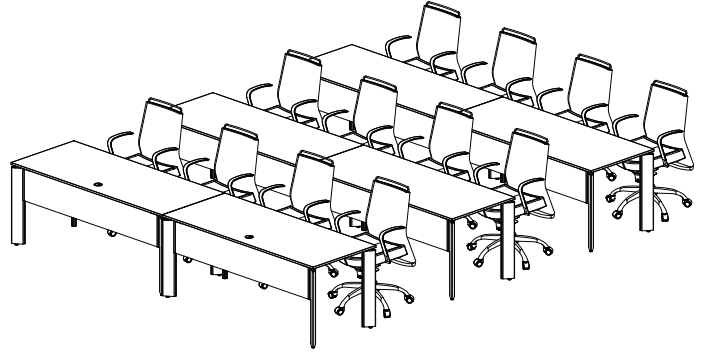
62CMBU-752435-13	1	N/A	N/A	7806	8936
62CMHTO-751541	1	N/A	N/A	4718	5425
62CMP-362035-11	(2)	N/A	N/A	3788	8709
62CMPR-361541G	(2)	N/A	N/A	4084	6410
TABLE CONFIGURATION TOTAL				28268	44599



V2 MODULAR | SAMPLE CONFIGURATIONS

Model	QTY	Laminate w/ PVC Edge	Laminate w/ Wood Edge	Rift Oak, Cherry, Maple, Walnut	Anigre
61THRT-7224-X29	6	2105	2405	2405	2713
Grommet in "C" Position	*	0	0	0	0
TABLE CONFIGURATION TOTAL		12630	14430	14430	16278

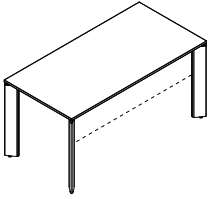
* One Grommet position comes standard at no charge per table.



Model	QTY	Laminate with PVC Edge	Laminate with Wood Edge	Rift Oak, Cherry, Maple, Walnut	Anigre
61THS-7236R	2	2055	2387	2387	2745
61THS-7236L	2	2055	2387	2387	2745
TABLE CONFIGURATION TOTAL		8220	9548	9548	10980

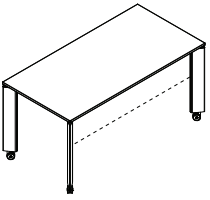


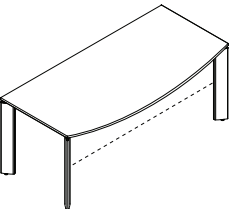
V2 MODULAR | RECTANGULAR & ARC TABLES

Description	Model	Laminate W/ PVC Edge	Laminate W/ Wood Edge	Rift Oak, Cherry, Walnut, Maple	Anigre	W	D	H	KW	Shipping Weight	Cubic Feet
 Rectangular Table with Glides	61THRT-4824	1468	1611	1611	1854	47.75	23.75	29.25	40.5	60	7.5
	61THRT-5424	1558	1825	1825	2100	53.75	23.75	29.25	46.5	64	8
	61THRT-6024	1607	1883	1883	2166	59.75	23.75	29.25	52.25	68	9
	61THRT-6624	1702	1941	1941	2232	65.75	23.75	29.25	58.5	72	9.5
	61THRT-7224	1755	2056	2056	2362	71.75	23.75	29.25	64.25	88	10
	61THRT-4830	1514	1662	1662	1911	47.75	29.75	29.25	40.5	68	8.5
	61THRT-5430	1584	1929	1929	2219	53.75	29.75	29.25	46.5	73	9.5
	61THRT-6030	1654	1985	1985	2281	59.75	29.75	29.25	52.25	78	10
	61THRT-6630	1752	2028	2028	2329	65.75	29.75	29.25	58.5	88	11
	61THRT-7230	1808	2118	2118	2436	71.75	29.75	29.25	64.25	93	11.5
	61THRT-6036	1833	2195	2195	2526	59.75	35.75	29.25	52.25	99	12.5
	61THRT-7236	1913	2297	2297	2639	71.75	35.75	29.25	64.25	105	13

ORDERING NOTES

Rectangular tables are available with a modesty panel that runs with the grain on one side only. Please see page 109 for options and upcharges.

 Rectangular Table with Casters	61THRT-4824-M	1570	1713	1713	1968	47.75	23.75	29.25	40.5	60	7.5
	61THRT-5424-M	1661	1927	1927	2217	53.75	23.75	29.25	46.5	64	8
	61THRT-6024-M	1708	1985	1985	2281	59.75	23.75	29.25	52.25	68	9
	61THRT-6624-M	1803	2040	2040	2347	65.75	23.75	29.25	58.5	72	9.5
	61THRT-7224-M	1856	2158	2158	2481	71.75	23.75	29.25	64.25	88	10
	61THRT-4830-M	1617	2032	2032	2337	47.75	29.75	29.25	40.5	68	8.5
	61THRT-5430-M	1685	2086	2086	2397	53.75	29.75	29.25	46.5	73	9.5
	61THRT-6030-M	1755	2107	2107	2422	59.75	29.75	29.25	52.25	78	10
	61THRT-6630-M	1854	2130	2130	2448	65.75	29.75	29.25	58.5	88	11
	61THRT-7230-M	1909	2219	2219	2554	71.75	29.75	29.25	64.25	93	11.5
	61THRT-6036-M	1932	2298	2298	2640	59.75	35.75	29.25	52.25	99	12.5
	61THRT-7236-M	2016	2396	2396	2756	71.75	35.75	29.25	64.25	105	13

 Arc Table with Glides	61THA-4824	1584	1743	1743	2002	47.75	29.75	29.25	40.5	63	8.5
	61THA-5424	1795	1971	1971	2269	53.75	29.75	29.25	46.5	68	9.5
	61THA-6024	1853	2033	2033	2340	59.75	29.75	29.25	52.25	73	10
	61THA-6624	1908	2094	2094	2410	65.75	29.75	29.25	58.5	83	11
	61THA-7224	2020	2219	2219	2554	71.75	29.75	29.25	64.25	88	11.5
	61THA-4830	1633	1792	1792	2062	47.75	35.75	29.25	40.5	71	10
	61THA-5430	1897	2086	2086	2396	53.75	35.75	29.25	46.5	77	10.5
	61THA-6030	1949	2143	2143	2464	59.75	35.75	29.25	52.25	83	11.5
	61THA-6630	1991	2191	2191	2517	65.75	35.75	29.25	58.5	94	12.5
	61THA-7230	2084	2286	2286	2632	71.75	35.75	29.25	64.25	100	13

DIMENSION KEY

W - width
 D - depth
 H - height of worksurface
 KW - kneehole width
 Dimensions are in inches and are plus or minus 1/8".
 Contact Customer Service if dimensions are critical.

See page 346 for Krug Express program.

STANDARD FINISHES

For a complete list of standard wood finishes please see page 347.

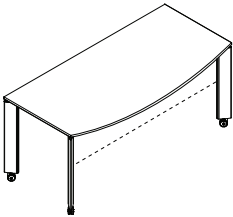
MODESTY PANELS

Please see page 109 for options and upcharges.

VENEER TOPS

Please note when ordering wood veneer tables, these tables can only be ordered with a wood edge.

V2 MODULAR | ARC & WAVE TABLES

Description	Model	Laminate W/ PVC Edge	Laminate W/ Wood Edge	Rift Oak, Cherry, Walnut, Maple	Anigre	W	D	H	KW	Shipping Weight	Cubic Feet	
	Arc Table with Casters	61THA-4824-M	1676	1841	1841	2117	47.75	29.75	29.25	40.5	63	8.5
	61THA-5424-M	1885	2072	2072	2385	53.75	29.75	29.25	46.5	68	9.5	
	61THA-6024-M	1944	2134	2134	2457	59.75	29.75	29.25	52.25	73	10	
	61THA-6624-M	1999	2195	2195	2527	65.75	29.75	29.25	58.5	83	11	
	61THA-7224-M	2112	2321	2321	2669	71.75	29.75	29.25	64.25	88	11.5	
	61THA-4830-M	1724	1894	1894	2177	47.75	35.75	29.25	40.5	71	10	
	61THA-5430-M	1989	2188	2188	2515	53.75	35.75	29.25	46.5	77	10.5	
	61THA-6030-M	2042	2242	2242	2580	59.75	35.75	29.25	52.25	83	11.5	
	61THA-6630-M	2085	2293	2293	2635	65.75	35.75	29.25	58.5	94	12.5	
	61THA-7230-M	2174	2390	2390	2747	71.75	35.75	29.25	64.25	100	13	

ORDERING NOTES

Arc tables are available with a modesty panel that runs with the grain on the bow side.

Please see page 26 for options and upcharges. The modesty panel is on the curved section of the bow top and is constructed to have seating on the straight section.

	Wave Table with Glides	61THW-6030	1964	2283	2283	2628	59.75	31.25	29.25	52.25	85	11
	61THW-7230	2055	2387	2387	2745	71.75	31.25	29.25	64.25	96	12	

ORDERING NOTES

Wave tables are available with a modesty panel on the long straight side only.

Please see page 26 for options and upcharges.

	Wave Table with Casters	61THW-6030-M	2053	2386	2386	2743	59.75	31.25	29.25	52.25	85	11
	61THW-7230-M	2140	2488	2488	2861	71.75	31.25	29.25	64.25	96	12	

ORDERING NOTES

Wave tables are available with a modesty panel on the long straight side only.

Please see page 26 for options and upcharges.

DIMENSION KEY

W - width
D - depth
H - height of worksurface
KW - kneehole width

Dimensions are in inches and are plus or minus 1/8".
Contact Customer Service if dimensions are critical.

See page 346 for Krug Express program.

STANDARD FINISHES

For a complete list of standard wood finishes please see page 347.

MODESTY PANELS

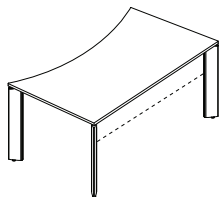
Please see page 109 for options and upcharges.

VENEER TOPS

Please note when ordering wood veneer tables, these tables can only be ordered with a wood edge.

V2 MODULAR | WAVE & CURVE TABLES

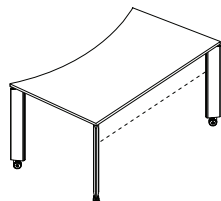
Description	Model	Laminate W/ PVC Edge	Laminate W/ Wood Edge	Rift Oak, Cherry, Walnut, Maple	Anigre	W	D	H	KW	Shipping Weight	Cubic Feet
Wave Inverted Table with Glides	61THWI-6036 61THWI-7236	1964 2055	2283 2387	2283 2387	2628 2745	59.75 71.75	29.75/28.5 29.75/28.5	29.25 29.25	52.25 64.25	78 93	10.5 11.5



ORDERING NOTES

Wave Inverted tables are available with a modesty panel on the long straight side only.

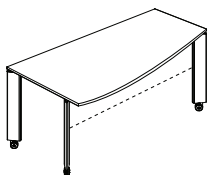
Wave Inverted Table with Casters	61THW1-6036-M 61THW1-7236-M	2053 2140	2386 2488	2386 2488	2743 2861	59.75 71.75	29.75/28.5 29.75/28.5	29.25 29.25	52.25 64.25	78 93	10.5 11.5
-------------------------------------	--------------------------------	--------------	--------------	--------------	--------------	----------------	--------------------------	----------------	----------------	----------	--------------



ORDERING NOTES

Wave Inverted tables are available with a modesty panel on the long straight side only.

Curve Table with Glides	61THC-6036R	1991	2191	2191	2517	59.75	35.75/29.75	29.25	52.25	75	12.5
	61THC-6036L	1991	2191	2191	2517	59.75	35.75/29.75	29.25	52.25	75	12.5
	61THC-7236R	2084	2286	2286	2632	71.75	35.75/29.75	29.25	64.25	90	13
	61THC-7236L	2084	2286	2286	2632	71.75	35.75/29.75	29.25	64.25	90	13



ORDERING NOTES

Curve tables are available with a modesty panel on the curved side only.

DIMENSION KEY

W - width
D - depth
H - height of worksurface
KW - knee-hole width

Dimensions are in inches and are plus or minus 1/8".
Contact Customer Service if dimensions are critical.

See page 346 for Krug Express program.

STANDARD FINISHES

For a complete list of standard wood finishes please see page 347.

MODESTY PANELS

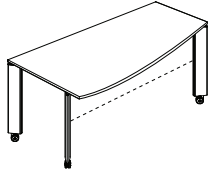
Please see page 109 for options and upcharges.

VENEER TOPS

Please note when ordering wood veneer tables, these tables can only be ordered with a wood edge.

V2 MODULAR | CURVE & SWEEP TABLES

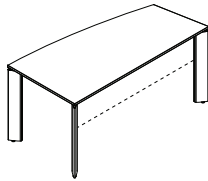
Description	Model	Laminate W/ PVC Edge	Laminate W/ Wood Edge	Rift Oak, Cherry, Walnut, Maple		Anigre	W	D	H	KW	Shipping Weight	Cubic Feet
Curve Table with Casters	61THC-6036R-M	2085	2293	2293	2635	59.75	35.75/29.75	29.25	52.25	75	12.5	
	61THC-6036L-M	2085	2293	2293	2635	59.75	35.75/29.75	29.25	52.25	75	12.5	
	61THC-7236R-M	2174	2390	2390	2747	71.75	35.75/29.75	29.25	64.25	90	13	
	61THC-7236L-M	2174	2390	2390	2747	71.75	35.75/29.75	29.25	64.25	90	13	



ORDERING NOTES

Curve tables are available with a modesty panel on the curved side only.

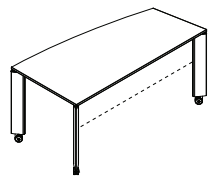
Description	Model	Laminate W/ PVC Edge	Laminate W/ Wood Edge	Rift Oak, Cherry, Walnut, Maple		Anigre	W	D	H	KW	Shipping Weight	Cubic Feet
Swept Table with Glides	61THS-6036R	1964	2283	2283	2628	59.75	35.75/29.75	29.25	52.25	75	12.5	
	61THS-6036L	1964	2283	2283	2628	59.75	35.75/29.75	29.25	52.25	75	12.5	
	61THS-7236R	2055	2387	2387	2745	71.75	35.75/29.75	29.25	64.25	90	13	
	61THS-7236L	2055	2387	2387	2745	71.75	35.75/29.75	29.25	64.25	90	13	



ORDERING NOTES

Swept tables are available with a modesty panel on the long straight side only.

Description	Model	Laminate W/ PVC Edge	Laminate W/ Wood Edge	Rift Oak, Cherry, Walnut, Maple		Anigre	W	D	H	KW	Shipping Weight	Cubic Feet
Swept Table with Casters	61THS-6036R-M	2053	2386	2386	2743	59.75	35.75/29.75	29.25	52.25	75	12.5	
	61THS-6036L-M	2053	2386	2386	2743	59.75	35.75/29.75	29.25	52.25	75	12.5	
	61THS-7236R-M	2140	2488	2488	2861	71.75	35.75/29.75	29.25	64.25	90	13	
	61THS-7236L-M	2140	2488	2488	2861	71.75	35.75/29.75	29.25	64.25	90	13	



ORDERING NOTES

Swept tables are available with a modesty panel on the long straight side only.

DIMENSION KEY

W - WIDTH
D - depth
H - height of worksurface
KW - kneehole width

Dimensions are in inches and approximate.
Contact Customer Service if dimensions are critical.

See page 346 for Krug Express program.

STANDARD FINISHES

For a complete list of standard wood finishes please see page 347.

MODESTY PANELS

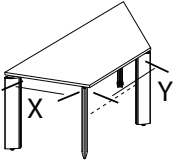
Please see page 109 for options and upcharges.

VENEER TOPS

Please note when ordering wood veneer tables, these tables can only be ordered with a wood edge.

V2 MODULAR | TRAPEZOID & CURVED TRAPEZOID TABLES

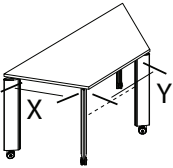
Description	Model	Laminate W/ PVC Edge	Laminate W/ Wood Edge	Rift Oak, Cherry, Walnut,		W	D	H	Shipping		Cubic Feet	Y	X
				Maple	Anigre				KW	Weight			
Trapezoid Table with Glides	61THTZ48-2424	1760	1934	1934	2221	47.75	20.75	29.25	40.25	53	7.5	23.75	23.75
	61THTZ60-2424	2058	2257	2257	2601	59.75	20.75	29.25	52	61	9	35.75	23.75
	61THTZ48-3030	1815	1991	1991	2293	47.75	25.75	29.25	40.25	61	8.5	18	29.75
	61THTZ60-3030	2166	2382	2382	2740	59.75	25.75	29.25	52	71	10	29.75	29.75
	61THTZ72-3636	2505	2754	2754	3166	71.75	30.75	29.25	64	86	13	35.75	35.75



ORDERING NOTES

Trapezoid tables are available with a modesty panel on the short side only. Please note that on the trapezoid table the knife edge profile is not present on the angled sides of the table.

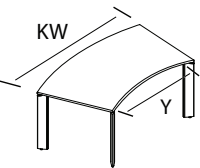
Trapezoid Table with Casters	61THTZ48-2424-M	1861	2034	2034	2341	47.75	20.75	29.25	40.25	53	7.5	23.75	23.75
	61THTZ60-2424-M	2160	2360	2360	2715	59.75	20.75	29.25	52	61	9	35.75	23.75
	61THTZ48-3030-M	1914	2092	2092	2408	47.75	25.75	29.25	40.25	61	8.5	18	29.75
	61THTZ60-3030-M	2268	2483	2483	2854	59.75	25.75	29.25	52	71	10	29.75	29.75
	61THTZ72-3636-M	2609	2854	2854	3285	71.75	30.75	29.25	64	86	13	35.75	35.75



ORDERING NOTES

Trapezoid tables are available with a modesty panel on the short side only. Please note that on the trapezoid table the knife edge profile is not present on the angled sides of the table.

Curved Trapezoid Table with Glides	61TH30CT-3060	2023	2221	2221	2555	32.75	59.5	29.25	51.25	83	8.5	38.5	
	61TH30CT-3066	2065	2271	2271	2610	33	65.75	29.25	57.25	89	10.5	44.5	
	61TH30CT-3072	2161	2374	2374	2728	38.75	71.75	29.25	57.25	99	11.75	41.5	
	61TH30CT-3666	2239	2460	2460	2828	33.5	65.75	29.25	63	95	11.25	50.5	
	61TH30CT-3672	2341	2570	2570	2957	39.25	71.75	29.25	63	106	12.5	47.5	



ORDERING NOTES

Curved Trapezoid tables are not available with a modesty panel option.

DIMENSION KEY

W - width
D - depth
H - height of worksurface
KW - kneehole width

Dimensions are in inches and are plus or minus 1/8".
Contact Customer Service if dimensions are critical.

See page 346 for Krug Express program.

STANDARD FINISHES

For a complete list of standard wood finishes please see page 347.

MODESTY PANELS

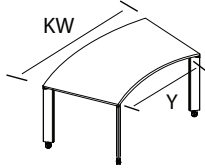
Please see page 109 for options and upcharges.

VENEER TOPS

Please note when ordering wood veneer tables, these tables can only be ordered with a wood edge.

V2 MODULAR | CURVED TRAPEZOID & VISIO TABLES

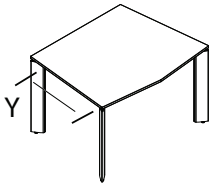
Description	Model	Laminate W/ PVC Edge	Laminate W/ Wood Edge	Rift Oak, Cherry, Walnut, Maple		W	D	H	KW	Shipping Weight	Cubic Feet	Y
				Anigre								
Curved Trapezoid Table with Casters	61TH30CT-3060-M	2124	2324	2324	2671	32.75	59.5	29.25	51.25	83	8.5	38.5
	61TH30CT-3066-M	2160	2373	2373	2727	33	65.75	29.25	57.25	89	10.5	44.5
	61TH30CT-3072-M	2252	2473	2473	2847	38.75	71.75	29.25	57.25	99	11.75	41.5
	61TH30CT-3666-M	2329	2562	2562	2946	33.5	65.75	29.25	63	95	11.25	50.5
	61TH30CT-3672-M	2432	2671	2671	3073	39.25	71.75	29.25	63	106	12.5	47.5



ORDERING NOTES

Curved Trapezoid tables are not available with a modesty panel option.

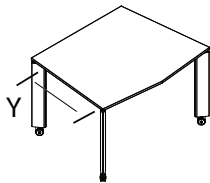
Visio End Table with Glides	61THV-473824	1712	1880	1880	2161	38	47.5	29.25	33.5	79	10.5	28.75
	61THV-593930	2003	2201	2201	2531	38.75	59.25	29.25	45.25	98	12	28.75
	61THV-713936	2298	2526	2526	2904	39.25	71.25	29.25	57	112	14	28.75



ORDERING NOTES

Visio End tables are not available with a modesty panel.

Visio End Table with Casters	61THV-473824-M	1811	1980	1980	2278	38	47.5	29.25	33.5	79	10.5	28.75
	61THV-593930-M	2105	2302	2302	2646	38.75	59.25	29.25	45.25	98	12	28.75
	61THV-713936-M	2397	2628	2628	3021	39.25	71.25	29.25	57	112	14	28.75



ORDERING NOTES

Visio End tables are not available with a modesty panel.

DIMENSION KEY

W - width
D - depth
H - height of work surface
KW - kneehole width

Dimensions are in inches and are plus or minus 1/8".
Contact Customer Service if dimensions are critical.

See page 346 for Krug Express program.

STANDARD FINISHES

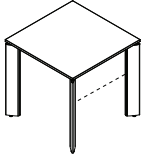
For a complete list of standard wood finishes please see page 347.

VENEER TOPS

Please note when ordering wood veneer tables, these tables can only be ordered with a wood edge.

V2 MODULAR | SQUARE & ROUND TABLES

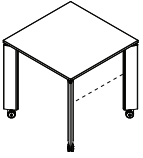
Description	Model	Rift Oak, Laminate				Anigre	W	D	H	KW	Shipping Weight	Cubic Feet
		W/ PVC Edge	Laminate W/ Wood Edge	Cherry, Walnut, Maple								
Square Table with Glides	61THSQ-3030	1416	1555	1555	1786	29.75	29.75	29.25	22.5	53	6.5	
	61THSQ-3636	1530	1667	1667	1915	35.75	35.75	29.25	28.5	64	8	
	61THSQ-4242	1617	1789	1789	2058	41.75	41.75	29.25	34.5	77	10.5	
	61THSQ-4848	1713	1907	1907	2192	47.75	47.75	29.25	40.5	92	12	



ORDERING NOTES

The Square tables are available with a modesty panel that runs with the grain on one side only.

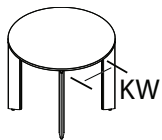
Square Table with Casters	61THSQ-3030-M	1515	1654	1654	1902	29.75	29.75	29.25	22.5	53	6.5
	61THSQ-3636-M	1633	1769	1769	2033	35.75	35.75	29.25	28.5	64	8
	61THSQ-4242-M	1716	1887	1887	2172	41.75	41.75	29.25	34.5	77	10.5
	61THSQ-4848-M	1815	2006	2006	2307	47.75	47.75	29.25	40.5	92	12



ORDERING NOTES

The Square tables are available with a modesty panel that runs with the grain on one side only.

Round Table with Glides	61THD-36	1724	1914	1914	2202	35.75	35.75	29.25	18.25	57	8
	61THD-42	1855	2066	2066	2378	41.75	41.75	29.25	22.5	68	10.5
	61THD-48	1962	2192	2192	2520	47.75	47.75	29.25	26.75	85	12
	61THD-54	2096	2228	2228	2562	53.75	53.75	29.25	30.75	97	14.5



ORDERING NOTES

Round tables are not available with a modesty panel option.

DIMENSION KEY

- W - width
- D - depth
- H - height of worksurface
- KW - kneehole width
- Y - dimensions as indicated on line drawing
- X - dimensions as indicated on line drawing

Dimensions are in inches and are plus or minus 1/8".
Contact Customer Service if dimensions are critical.

See page 346 for Krug Express program.

STANDARD FINISHES

For a complete list of standard wood finishes please see page 347.

MODESTY PANELS

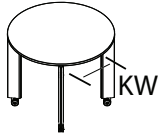
Please see page 109 for options and upcharges.

VENEER TOPS

Please note when ordering wood veneer tables, these tables can only be ordered with a wood edge.

V2 MODULAR | ROUND TABLES

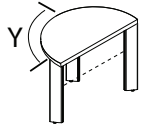
Description	Model	Laminate W/ PVC Edge	Laminate W/ Wood Edge	Rift Oak, Cherry, Walnut, Maple		Anigre	W	D	H	KW	Shipping Weight	Cubic Feet	Y
Round Table with Casters	61THD-36-M	1823	2017	2017	2318	35.75	35.75	29.25	18.25	57	8	-	
	61THD-42-M	1956	2169	2169	2495	41.75	41.75	29.25	22.5	68	10.5	-	
	61THD-48-M	2063	2294	2294	2637	47.75	47.75	29.25	26.75	85	12	-	
	61THD-54-M	2196	2328	2328	2680	53.75	53.75	29.25	30.75	97	14.5	-	



ORDERING NOTES

Round tables are not available with a modesty panel option.

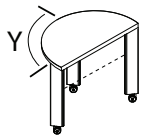
Half Round Table with Glides	61THDH-4824	1503	1644	1644	1892	47.75	23.75	29.25	40.75	50	8	25.75
	61THDH-6030	1688	1885	1885	2169	59.75	29.75	29.25	52.75	64	10	34



ORDERING NOTES

Half Round meeting tables are available with modesty panel on the straight side only.

Half Round Table with Casters	61THDH-4824-M	1604	1746	1746	2007	47.75	23.75	29.25	40.75	50	8	25.75
	61THDH-6030-M	1789	1988	1988	2285	59.75	29.75	29.25	52.75	64	10	34



ORDERING NOTES

Half Round meeting tables are available with modesty panel on the straight side only.

DIMENSION KEY

W – width
D – depth
H – height of worksurface
KW – kneehole width
Y – dimensions as indicated on line drawing

Dimensions are in inches and are plus or minus 1/8".
Contact Customer Service if dimensions are critical.

See page 346 for Krug Express program.

STANDARD FINISHES

For a complete list of standard wood finishes please see page 347.






MODESTY PANELS

Please see page 109 for options and upcharges.

VENEER TOPS

Please note when ordering wood veneer tables, these tables can only be ordered with a wood edge.

V2 MODULAR | CONNECTING TOPS

Description	Model	Laminate W/ PVC Edge	Laminate W/ Wood Edge	Rift Oak, Cherry, Walnut, Maple		W	D	H	KW	Shipping Cubic	
				Anigre						Weight	Feet
45° Corner Connecting Top 	61TC-2424-45	415	456	456	522	18.25	23.75	-	18.25	21	2.5
	61TC-3030-45	438	483	483	557	22.75	29.75	-	22.75	27	3.5
	61TC-3636-45	470	515	515	592	27.25	35.75	-	27.25	36	4.5
60° Corner Connecting Top 	61TC-2424-60	470	515	515	592	23.75	23.75	-	23.75	27	3
	61TC-3030-60	497	546	546	630	29.75	29.75	-	29.75	36	4
	61TC-3636-60	532	586	586	673	35.75	35.75	-	35.75	44	5.5
90° Corner Connecting Top 	61TC-2424-90	555	606	606	699	33.75	23.75	-	33.75	36	2.5
	61TC-3030-90	586	644	644	740	42.75	29.75	-	42	44	5.5
	61TC-3636-90	627	689	689	791	50.5	35.75	-	50.5	61	8
90° Corner Connecting Top with 2 Legs (Glides) 	61TC-2424-90-Q2	1128	1241	1241	1429	33.75	23.75	29.25	24.25	47	4.7
	61TC-3030-90-Q2	1168	1283	1283	1478	42.75	29.75	29.25	32.75	55	7.7
	61TC-3636-90-Q2	1210	1332	1332	1530	50.5	35.75	29.25	41.25	72	10.2
90° Corner Connecting Top with 2 Legs (Casters) 	61TC-2424-90-Q2-M	1230	1342	1342	1543	33.75	23.75	29.25	24.25	47	4.7
	61TC-3030-90-Q2-M	1268	1384	1384	1590	42.75	29.75	29.25	32.75	55	7.7
	61TC-3636-90-Q2-M	1312	1433	1433	1646	50.5	35.75	29.25	41.25	72	10.2

NOTE
Connecting tops ship complete with ganging brackets.

DIMENSION KEY

W - width
D - depth
H - height of worksurface
KW - kneehole width
Y - dimensions as indicated on line drawing

Dimensions are in inches and are plus or minus 1/8".
Contact Customer Service if dimensions are critical.

See page 346 for Krug Express program.

STANDARD FINISHES

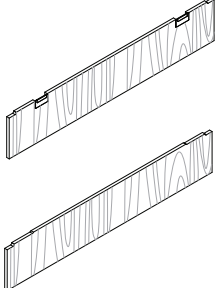
For a complete list of standard wood finishes please see page 347.

VENEER TOPS

Please note when ordering wood veneer tables, these tables can only be ordered with a wood edge.

V2 MODULAR | MODESTY PANELS

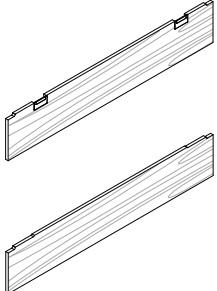
Description	Model	Size	Rift Oak, Cherry, Walnut, Maple	Anigre	Rift Oak Cherry Walnut Maple w/Grommets	Anigre w/Grommets	Shipping Weight	Cubic Feet
Modesty Panels - wood	X21	30"	410	476	481	543	5	1
		36"	410	476	481	543	6.4	1.25
		42"	410	476	481	543	7.8	1.25
		48"	418	483	491	557	9.1	1.5
		54"	433	497	509	571	10.5	1.75
		60"	433	497	509	571	11.8	2
		66"	446	514	521	590	13.2	2.25
		72"	458	531	538	610	14.6	2.25
		11" - 48X30 Trapezoid	399	458	466	529	2.5	0.5
		17" - 48X24 Trapezoid	399	458	466	529	3.9	0.75
		23" - 60X30 Trapezoid	410	476	481	543	5.2	1
		29" - 60X24 Trapezoid	410	476	481	543	6.6	1.25
		29" - 72X36 Trapezoid	410	476	481	543	6.6	1.25



ORDERING NOTES

With wood veneer modesty panels, the grain runs vertically. To specify fixed wood modesty panels apply above pricing for the specific modesty panel and add (X21) to the end of the model number 61THRT-4824-X21.

Description	Model	Size	Laminate W/ PVC	Laminate W/ w/Grommets	Shipping Weight	Cubic Feet
Modesty Panels - plastic laminate	X23	30"	353	424	5	1
		36"	353	424	6.4	1.25
		42"	353	424	7.8	1.25
		48"	362	434	9.1	1.5
		54"	372	448	10.5	1.75
		60"	372	448	11.8	2
		66"	384	460	13.2	2.25
		72"	397	477	14.6	2.25
		11" - 48X30 Trapezoid	344	411	2.5	0.5
		17" - 48X24 Trapezoid	344	411	3.9	0.75
		23" - 60X30 Trapezoid	353	424	5.2	1
		29" - 60X24 Trapezoid	353	424	6.6	1.25
		29" - 72X36 Trapezoid	353	424	6.6	1.25



ORDERING NOTES

With wood grain laminate modesty panels, the grain runs lengthwise. To specify laminate modesty panels apply above pricing for the specific modesty panel and add (X23) to the end of the model number 61THRT-4824-X23.

DIMENSION KEY

W - width
D - depth
H - height of worksurface
KW - kneehole width

Dimensions are in inches and are plus or minus 1/8".
Contact Customer Service if dimensions are critical.

See page 346 for Krug Express program.

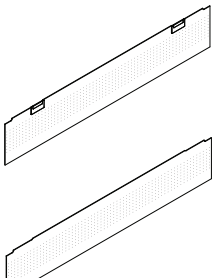
STANDARD FINISHES

For a complete list of standard wood finishes please see page 347.

GROMMETS

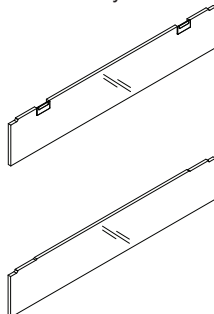
To order a modesty panel with grommets please specify when ordering and apply the appropriate pricing from above.

V2 MODULAR | MODESTY PANELS

Description	Model	Size	Upcharge	W/Grommets	Shipping Weight	Cubic Feet
Modesty Panels perforated metal 	X28	30"	382	453	3.3	1
		36"	382	453	4.2	1.25
		42"	382	453	5.1	1.25
		48"	389	463	6	1.5
		54"	404	478	6.9	1.75
		60"	404	478	7.8	2
		66"	415	491	8.7	2.25
		72"	428	509	9.6	2.25
		11" - 48X30 Trapezoid	371	437	1.7	0.5
		17" - 48X24 Trapezoid	371	437	2.6	0.75
		23" - 60X30 Trapezoid	382	453	3.4	1
		29" - 60X24 Trapezoid	382	453	4.3	1.25
		29" - 72X36 Trapezoid	382	453	4.3	1.25

ORDERING NOTES

To specify fixed perforated metal modesty panels apply above pricing for the specific modesty panel and add (X28) to the end of the model number 61THRT-4824-X28. Perforated metal modesty panels come powder coated in Silver Metallic.

Modesty Panels - frosted acrylic 	X29	30"	310	382	1.2	1
		36"	310	382	1.6	1.25
		42"	310	382	1.9	1.25
		48"	319	389	2.2	1.5
		54"	328	404	2.5	1.75
		60"	328	404	2.9	2
		66"	338	415	3.2	2.25
		72"	348	428	3.5	2.25
		11" - 48X30 Trapezoid	303	371	.6	0.5
		17" - 48X24 Trapezoid	303	371	1	0.75
		23" - 60X30 Trapezoid	310	382	1.3	1
		29" - 60X24 Trapezoid	310	382	1.6	1.25
		29" - 72X36 Trapezoid	310	382	1.6	1.25

ORDERING NOTES

To specify frosted acrylic modesty panels apply above pricing for the specific modesty panel and add (X29) to the end of the model number 61THRT-4824-X29.

DIMENSION KEY

W - width
D - depth
H - height of worksurface
KW - kneehole width

Dimensions are in inches and are plus or minus 1/8".
Contact Customer Service if dimensions are critical.

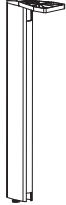
See page 346 for Krug Express program.

GROMMETS

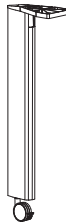
To order a modesty panel with grommets please specify when ordering and apply the appropriate pricing from above.

V2 MODULAR | LEGS & POWER

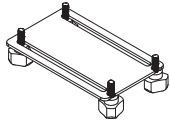
Description	Model	Price	W	D	H	Shipping Weight	Cubic Feet
V2 Leg with Glides	61LEG	199	4	9.25	29.25	5.1	2.2



V2 Leg with Casters	61LEGM	238	4	9.25	29.25	5.1	2.2
---------------------	--------	-----	---	------	-------	-----	-----



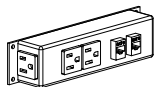
Ganging Module	61GANG	48	-	-	-	1	0.5
----------------	--------	----	---	---	---	---	-----



ORDERING NOTES

It is recommended to use 2 brackets per seam.

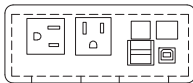
Power/Data/Link	61POWER/DATALINK	348	-	-	-	-	-
-----------------	------------------	-----	---	---	---	---	---



ORDERING NOTES

Power/data/link comes with 3 receptacles and 2 RJ45's.
Power cord is 10 ft. long.
Data cords are 14 ft. long.

Surface Module	61SURFACEMODULE	199	8	4	-	-	-
----------------	-----------------	-----	---	---	---	---	---



ORDERING NOTES

Surface module comes with 3 receptacles - 2 above the worksurface and 1 below, 1 USB port, 1 USB printer port, 1 RJ45 and 1 RJ11. The USB ports in this device do not charge unless connected to a transformer or another power supply device.

DIMENSION KEY

- W - width
- D - depth
- H - height of worksurface
- KW - kneehole width
- Y - dimensions as indicated on line drawing

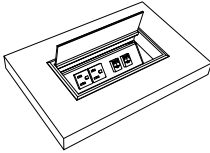
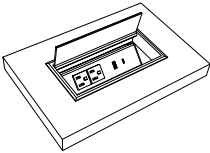
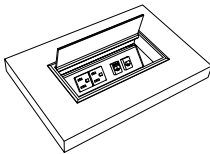
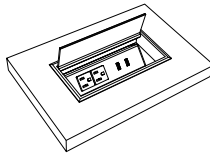
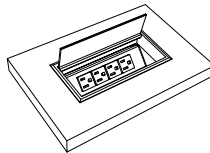
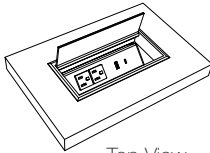

Dimensions are in inches and are plus or minus 1/8".
Contact Customer Service if dimensions are critical.

See page 346 for Krug Express program.

STANDARD FINISHES

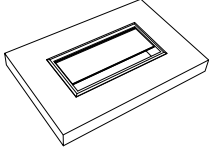
V2 metal finishes are Silver Metallic.

POWERPORTS

Description	Model	Price	W	D	H	Shipping Weight	Cubic Feet
PowerPort 1 - 2 RJ45s (Category 5/6)	PORT1	278	8	4	-	-	-
	Port Includes: 2 accessible power outlets & 1 side utility outlet powered by a 10' plug-in cord; 2 RJ45 (category 5/6) each with hard wired 10' data cords; 2 velcro wire managers and metal PowerPort shroud. PortPort lid is Silver Metallic. NOTE: RJ45 jacks with hard wired data cords included here must be within 10' of building utilities source to be functional.						
PowerPort 2 - USB-A & USB-C	PORT2	280	8	4	-	-	-
	Port Includes: 2 accessible power outlets & 1 side utility outlet; 1 USB-A & 1 USB-C charging ports all powered by a 10' plug-in cord; 2 velcro wire managers and metal PowerPort shroud. PortPort lid is Silver Metallic.						
PowerPort 3 - RJ11 & RJ45	PORT3	269	8	4	-	-	-
	Port Includes: 2 accessible power outlets & 1 side utility outlet; 1 RJ11 & 1 RJ45 (Category 5/6); 2 Velcro wire managers & PowerPort Shroud; 1 x 10 Foot Data Cords (T568A) & 1 x 14 Foot RJ11 (Telecomm); powered by a 10' plug-in cord. PortPort lid is Silver Metallic. NOTE: RJ45 & RJ11 jacks with hard wired data cords included here must be within 10' of building utilities source to be functional.						
PowerPort 4 - 2 USB-A	PORT4	286	8	4	-	-	-
	Port Includes: 2 accessible power outlets & 1 side utility outlet; 2- USB-A charging ports all powered by a 10' plug-in cord; 2 velcro wire managers and metal PortPort shroud. PortPort lid is Silver Metallic.						
PowerPort 5 - 4 Receptacles	PORT5	280	8	4	-	-	-
	Port Includes: 4 accessible power outlets & 1 side utility outlet powered by a 10' plug-in cord; 2 velcro wire managers and metal power port shroud. PortPort lid is Silver Metallic.						
PowerPort 6 - USB-A, USB-C & RJ45	PORT6	406	8	4	-	-	-
	Port Includes: 2 accessible power outlets & 1 side utility outlet 1 USB-A, 1 USB-C charging ports all powered by a 10' plug-in power cord. Includes 2 velcro wire managers and metal PortPort shroud with 2 data plate knock outs, 1 #M02 plate insert & 2 #S01W RJ45 female input, punch down terminal output snap in jacks. 2nd data plate knock out is blank for future use. PortPort lid is Silver Metallic.						
							

POWERPORTS

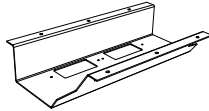
Description	Model	Price	W	D	H	Shipping Weight	Cubic Feet
Port - no Powerbar	Port0	137	8	4	-	-	-



Port Includes: Lid & Shroud only.

ORDERING NOTE: Velcro wire managers not included, see below for pricing. Port lid is Silver Metallic.

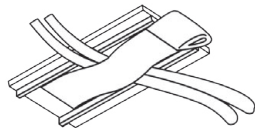
PowerPort Shroud with 2 Data Plate Knock-outs	SHROUD2KO	Must be requested - no upcharge	-	-	-	-	-
---	-----------	---------------------------------	---	---	---	---	---



Angled PowerPort Shroud Includes: shroud with 2 data plate knock-outs in the bottom.

ORDERING NOTE: Please refer to data plate, data and AV integration options on page XX.

Velcro Wire Manager (qty 1)	WM-4	26	2	4.5	0.5	-	-
-----------------------------	------	----	---	-----	-----	---	---



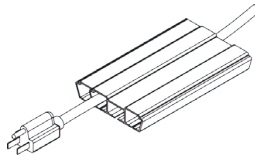
2 velcro wire managers are included with Ports 1-5.

Wire Management Trough	WM-72	182	72	3	1	-	-
------------------------	-------	-----	----	---	---	---	---



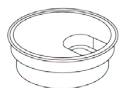
Wire Management Trough is standard in a 72" length & can be cut to specific length; double-sided tape installation.

4-Channel Wire Management	CM-72	231	72	3	1	-	-
---------------------------	-------	-----	----	---	---	---	---



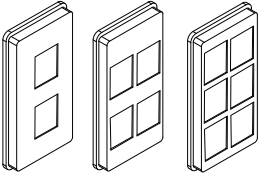

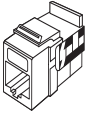
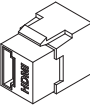
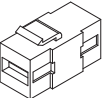
4-Channel Wire Management is standard in a 72" length & can be cut to specific length; double-sided tape installation.

Round Grommet	Round Grommet - Silver Metallic	152	-	-	-	-	-
	Round Grommet - Black	152	-	-	-	-	-

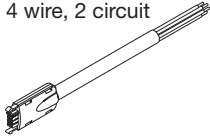
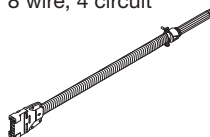
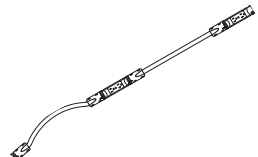
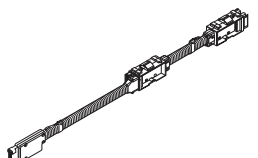




One 60mm Grommet in a standard position is available at no charge per table.

POWER/DATA

SNAP IN PORTS	Reference Code	Description	List Price
ADAPTOR PLATES			
	M02	Adaptor Plate (2) - accepts two snap in data ports	38
	M04	Adaptor Plate (4) - accepts four snap in data ports	38
	M06	Adaptor Plate (6) - accepts six snap in data ports	38
ORDERING NOTES: Blank covers are required when port is not in use, please see page 55.			
		RJ-45 - Category 6 data connection. This connector is also downwards compatible with Category 5 cabling. Connector is a female input with a #110 punch-down terminal block output (back side of Console interface) for on-site hard wire connection.	47
	S01W	RJ45-CAT6 (White)	
	S01B	RJ45-CAT6 (Blue)	
	S01R	RJ45-CAT6 (Red)	
		RJ11 - Telephone type connection. Connector is a female input with a #110 punch-down terminal block output (back side of Console interface) for on-site hard wire connection.	32
	S02W	RJ11 (White)	
	S02B	RJ11-B (Black)	
	S02G	RJ11-G (Green)	
	S02R	RJ11-R (Red)	
	S02Y	RJ11-Y (Yellow)	
	S04	HDMI - High Definition Multimedia Interface connection. Connector carries both HD audio and video data. Connector is a female-to-female pass through.	173
	S08	USB-A - Full size USB "A" style connection. Connector is a female-to-female pass through.	61

V2 MODULAR | WIRE SYSTEMS

Description	Model	Price	W	D	H	Shipping Weight	Cubic Feet
Power Entry - 4 wire, 2 circuit 	61EC4PE	120	-	-	-	1	.25
ORDERING NOTES Please note when ordering the 4-Wire or 8-Wire Power Entry components, you must also order either the 4-Wire or 8-Wire System, to work in conjunction.							
Power Entry - 8 wire, 4 circuit 	61EC8PE	159	-	-	-	1	.25
ORDERING NOTES Please note when ordering the 4-Wire and 8-Wire Power Entry components, you must also order either the 4-Wire or 8-Wire System, to work in conjunction.							
4-Wire System 	61EC4-30	173	-	-	-	2	.25
	61EC4-36	173	-	-	-	2	.25
	61EC4-42	173	-	-	-	2	.25
	61EC4-48	183	-	-	-	2	.25
	61EC4-54	183	-	-	-	2	.25
	61EC4-60	190	-	-	-	2	.25
	61EC4-66	199	-	-	-	2	.25
	61EC4-72	205	-	-	-	2	.25
ORDERING NOTES Please note when ordering the 4-Wire or 8-Wire System, you must also order either the 4 wire or 8 wire Power Entry in conjunction to work together. Each model comes standard with an 18" Jumper.							
8-Wire System 	61EC8-30	238	-	-	-	2	.25
	61EC8-36	255	-	-	-	2	.25
	61EC8-42	261	-	-	-	2	.25
	61EC8-48	269	-	-	-	2	.25
	61EC8-54	278	-	-	-	2	.25
	61EC8-60	284	-	-	-	2	.25
	61EC8-66	301	-	-	-	2	.25
	61EC8-72	309	-	-	-	2	.25
ORDERING NOTES Please note when ordering the 4-Wire or 8-Wire System, you must also order either the 4 wire or 8 wire Power Entry in conjunction to work together. Each model comes standard with an 18" Jumper.							
4-Wire 42" Jumper 	61EC4JUMP-42	80	-	-	-	1	0.25
ORDERING NOTES This longer jumper cable is required when connecting one table off the edge to the end of another table using the 4-Wire System. Jumper cables allow you to daisychain each wired table to the next. Please refer to page 93 for further explanation.							
8-Wire 42" Jumper 	61EC8JUMP-42	127	-	-	-	1	0.25
ORDERING NOTES This longer jumper cable is required when connecting one table off the edge to the end of another table using the 8-Wire System. Jumper cables allow you to daisychain each wired table to the next. Please refer to page 93 for further explanation.							

DIMENSION KEY

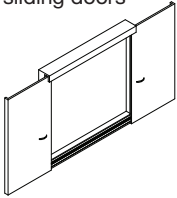
W - width
D - depth
H - height of worksurface
KW - kneehole width

Dimensions are in inches and are plus or minus 1/8".
Contact Customer Service if dimensions are critical.

See page 346 for Krug Express program.

V2 MODULAR | MEDIA

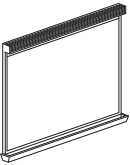
Description	Model	Rift Oak, Cherry, Walnut, Maple			W	D	H	Shipping Weight	Cubic Feet
		Anigre							
Visual Board with sliding doors	62VBS-4848	5889	6770	47.75	47.75	6.5	120	16	



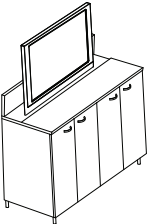
ORDERING NOTES

Please note projection screen can not be ordered with the visual board with sliding doors.

White Board with Projection Screen	62WB-4848	2356	2712	47.75	47.75	4.75	90	16
	62WB-5454	2419	2781	53.75	53.75	4.75	115	17.5



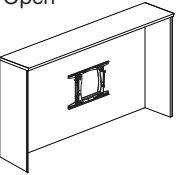
Plasma Screen Cabinet	62CMBUPS-722041	8456	9726	71.75	20	41.25	263	45.5
	62CMBUPS-722441	9031	10386	71.75	24	41.25	329	53
	62CMBUPS-722441G	9935	11425	71.75	24	41.25	329	53



ORDERING NOTES

Glass doors are available with Como pulls only

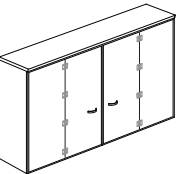
Media Hutches - Open	62CMHTO-751541	4718	5425	74.75	15	41.5	167	33
-------------------------	----------------	------	------	-------	----	------	-----	----



ORDERING NOTES

Media Hutch comes with the wall mount bracket.

Media Hutches - with Doors	62CMHT-751541	5733	6590	74.75	15	41.5	172	33
-------------------------------	---------------	------	------	-------	----	------	-----	----



ORDERING NOTES

Please note that the Media Hutch with doors comes with two bifold doors that open away from the center.
Media Hutch comes with the wall mount bracket.

DIMENSION KEY

W - width
D - depth
H - height of worksurface

Dimensions are in inches and are plus or minus 1/8".
Contact Customer Service if dimensions are critical.

See page 346 for Krug Express program.

CODE DESCRIPTION

VBS - visual board with sliding doors
WB - white board
CM - conference media
BU - buffet
PS - plasma lift
HTO - open hutch
HT - hutch
G - glass

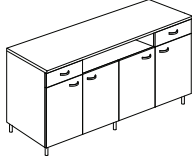
STANDARD FINISHES

For a complete list of standard wood finishes please see page 347.

NON-STANDARD GROMMETS

Grommets in non-standard positions are available at **\$152 list** per grommet.

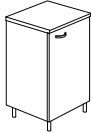
Description	Model	Rift Oak, Cherry, Walnut, Maple			W	D	H	Shipping Weight	Cubic Feet
		Anigre							
Media Buffet - with Equipment Shelf	62CMBU-752035-13	7921	9110	74.75	20.25	34.5	245	43.5	
	62CMBU-752435-13	8081	9293	74.75	24.25	34.5	295	3.5	



ORDERING NOTES

Media buffets are available with optional locks for an upcharge of **\$152 list** per lock.

Description	Model	Rift Oak, Cherry, Walnut, Maple			W	D	H	Shipping Weight	Cubic Feet
		Anigre							
Media Pedestals	62CMP-192035-11	3175	3651	18.75	19.75	34.5	62	10.5	
	62CMP-192435-11	3490	4013	18.75	23.75	34.5	74	12.5	
	62CMP-192035-11G	3239	3723	18.75	19.75	34.5	62	10.5	
	62CMP-192435-11G	3563	4098	18.75	23.75	34.5	74	12.5	



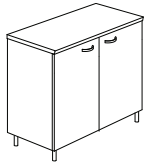
ORDERING NOTES

When ordering media pedestals, please add an "L" or "R" to model number to denote a right or left hinged door.

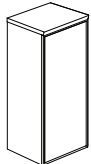
Media pedestals are available with optional locks for an upcharge of **\$152 list** per lock.

Glass doors are available with Como pulls only

Description	Model	Rift Oak, Cherry, Walnut, Maple			W	D	H	Shipping Weight	Cubic Feet
		Anigre							
Media Pedestals	62CMP-362035-11	3788	4354	35.75	19.75	34.5	117	18.5	
	62CMP-362435-11	4168	4792	35.75	23.75	34.5	140	22	
	62CMP-362035-11G	3873	4456	35.75	19.75	34.5	117	18.5	
	62CMP-362435-11G	4260	4899	35.75	23.75	34.5	140	22	



Description	Model	Rift Oak, Cherry, Walnut, Maple			W	D	H	Shipping Weight	Cubic Feet
		Anigre							
Media Piers - Single	62CMPR-191541	3266	3754	18.75	15	41.5	61	9	
	62CMPR-191541G	3592	4131	18.75	15	41.5	61	9	



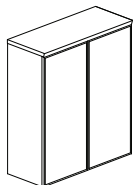
ORDERING NOTES

Media piers must be ordered in conjunction with Media Pedestals.

When ordering media piers, please add an "L" or "R" to model number to denote a right or left hinged door.

Media piers are available with optional locks for an upcharge of **\$152 list** per lock.

Description	Model	Rift Oak, Cherry, Walnut, Maple			W	D	H	Shipping Weight	Cubic Feet
		Anigre							
Media Piers - Double	62CMPR-361541	3712	4268	35.75	15	41.5	85	16	
	62CMPR-361541G	4084	4693	35.75	15	41.5	85	166	



ORDERING NOTES

Media piers are available with optional locks for an upcharge of **\$152 list** per lock.

DIMENSION KEY

W - width
D - depth
H - height of worksurface

Dimensions are in inches and are plus or minus 1/8".
Contact Customer Service if dimensions are critical.

See page 346 for Krug Express program.

CODE DESCRIPTION

CM - conference media
BU - buffet
P - pedestal
PR - pier
G - glass door
L - door hinged left
R - door hinged right

STANDARD FINISHES

For a complete list of standard wood finishes please see page 347.

ORDERING NOTES

Media piers must be ordered in conjunction with Media Pedestals.

NON-STANDARD GROMMETS

Grommets in non-standard positions are available at **\$152 list** per grommet.

ANDO | TABLE OF CONTENTS

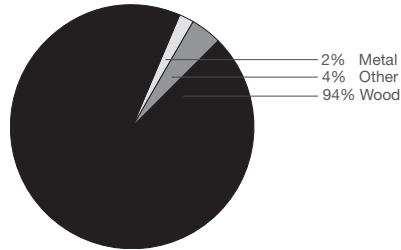
ANDO

119	Environmental Summary
120	Product Features
121	Powerport Location, Suggested Seating & Sample Configuration
122	Ando Tables Pricing
123	Power/Data & Cable Management

LEED CI CREDITS



MATERIAL CONTENT:



PRE-CONSUMER
RECYCLED CONTENT = 8%

POST-CONSUMER
RECYCLED CONTENT = 2%

		CONTRIBUTES TO
Credit 2.1 - 2.2	Construction Waste Management	1-2 point(s)
Credit 3.3	Resource Reuse	1 point
Credit 4.1	Recycled Content	1 point
Credit 4.5	Low Emitting Materials, (MUST BE REQUESTED) Systems Furniture & Seating	1 point
Credit 5.1	Regional Materials*	1 point
Credit 7	Certified Wood (please enquire)	1 point(s)

*This credit is only applicable if in total 20% of the combined value of the procurement of construction materials and in the furniture are manufactured within a radius of 500 miles. This credit will apply if the installation of the finished product occurs within 500 miles of Kitchener, Ontario.



level® CERTIFICATION

BIFMA's e3 Furniture Sustainability Standard is a voluntary, multi-attribute standard that measures the degree of sustainability of furniture. This standard evaluates product and company environmental attributes and compliance systems in a wide range of elements which include Materials, Energy & Atmosphere, Human & Ecosystem Health and Social Responsibility. Ando products have earned level®, BIFMA's sustainability certification program for furniture, certification through third-party verification against the e3 standard. All Ando products can be supplied with level® certification. In order to accomplish this, the product must also be ordered with the air-emissions-certification option. Contact customer service for information and upcharges.



FSC
www.fsc.org
FSC® C021699

the mark of responsible forest

AIR-EMISSIONS

All Ando products can be supplied with air-emissions-certified materials. Contact customer service for information and upcharges.

FSC®

FSC® In 2005, Krug received Forest Stewardship Council® (FSC®) Chain-of-Custody certification for our manufacturing facilities. The FSC® Chain-of-Custody tracks certified wood from seedling to final sale. It verifies that the material for our FSC® certified products only come from well-managed, FSC®-certified forests and other controlled sources. FSC® is dedicated to the promotion of responsible forest management worldwide helping to take care of forests for future generations. Ando and other Krug products can be specified with FSC® Certification. Contact customer service for further information, pricing and lead times..



In addition, architects, designers, and building professionals can specify FSC®-certified products in order to achieve a point from the US. Green Building Council's Leadership in Energy and Environmental Design (LEED) Rating System.

ANDO | PRODUCT FEATURES



TABLES

Tops and gables are 2.5" thick plywood core with face, back and edge veneer. Plastic Laminate tables are self edged. Standard laminates will show a visible dark line where the laminate edges meet, to avoid this line color-core laminates can be specified. Please contact customer service for a quote.

SUPPORT

Construction integrates an internal support system that eliminates the need for any visible support under the table top.



MITERED CORNER

The Ando table worksurface is joined to the side panel legs with a 45° angle miter joint indicative of the highest level of craftsmanship.

VENEER

Ando table veneers are quarter cut, except for White Oak, which is rift cut - both quarter cut and rift cut veneers provide a straight grain appearance.



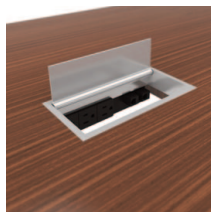
FINISH

A five step catalyzed varnish finish that when dry has a sheen value of 32°, is applied to all finished cases. A lower sheen topcoat, 20°, can also be specified at standard pricing. All purchase orders must clearly note "lower sheen finish" in order to receive the optional selection.



GLIDES

Adjustable glides are 1 1/2" long and allow for a range of adjustment of 1". Glides are installed at the factory.

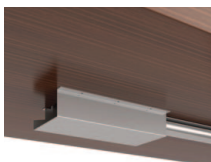


POWERPORT

A PowerPort is a unique worksurface mounted module that can be specified to a location that best serves the user's needs. It includes a UL approved electrical, power bar, containing two 115 - volt electrical simplex outlets which are accessible from the work surface, plus a utility outlet at the end for daisy chaining purposes. 3 data versions are available and can be custom configured.

PORT

A service module having no power bar will serve as a large grommet. A hinged lid easily enables the passage of several cables and devices.



HORIZONTAL CABLE MANAGEMENT

This includes a Protective Electrical Cover that covers the power/data module. A grey plastic cable manager carries the cords to the Vertical Cable Manager on the gable.



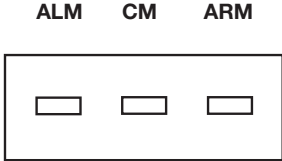
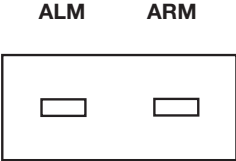
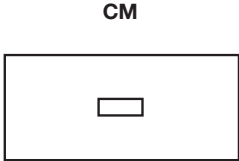
VERTICAL CABLE MANAGEMENT

This cable manager is clear satin anodized aluminum extrusion with clip attachment that carries from the underside of the top to the floor.

ANDO | POWERPORT LOCATION, SUGGESTED SEATING, SAMPLE CONFIGURATION

STANDARD POWERPORT LOCATIONS

MIDDLE POSITION

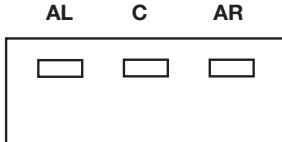
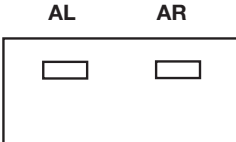
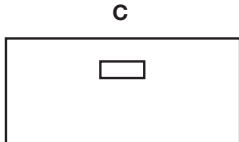


For 60", 66", 72" & 84" tables

For 96" tables only

NOTE: Workspace clearance of Middle positions:
 24" depth - 10" from powerport to table edge
 30" depth - 13" from powerport to table edge
 36" depth - 16" from powerport to table edge
 42" depth - 19" from powerport to table edge

OFFSET POSITION



For 60", 66", 72" & 84" tables

For 96" tables only

NOTE: Workspace clearance of Offset positions:
 All depths - Non-user side - 7" from powerport to table edge
 24" depth - User side - 13" from powerport to table edge
 30" depth - User side - 19" from powerport to table edge
 36" depth - User side - 25" from powerport to table edge
 42" depth - User side - 31" from powerport to table edge

SUGGESTED SEATING BY TABLE SIZE

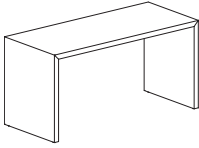
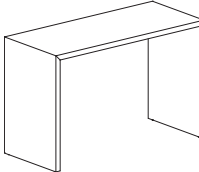
- 60" - 2 per side
- 66" - 2 per side
- 72" - 2 per side
- 84" - 2 per side
- 96" - 3 per side

SAMPLE CONFIGURATION

Description	Model	Oak Cherry Maple	Anigre Sycamore Walnut	Laminate
Ando table	54TB963042	6317	6948	5742
PowerPort	54POWERPORT1	397	397	397
Cable Manager	54CM1TB	229	229	229
Total		6943	7574	6368



ANDO | TABLES

Description	Model	Oak, Cherry, Maple	Walnut, Anigre	Laminate	W	D	H	Shipping KW	Cubic Weight	Feet
 Rectangular Table, Desk Height	54TH602430	4539	4994	4128	59.75	24	29.5	55	176	34
	54TH603030	4637	5099	4215	59.75	30	29.5	55	169	41
	54TH603630	5124	5636	4658	59.75	36	29.5	55	207	48
	54TH604230	5631	6191	5116	59.75	42	29.5	55	230	55.25
	54TH662430	4603	5063	4184	65.75	24	29.5	61	185	37.25
	54TH663030	4781	5258	4347	65.75	30	29.5	61	185	44.75
	54TH663630	5236	5760	4759	65.75	36	29.5	61	220	52.5
	54TH664230	5741	6315	5218	65.75	42	29.5	61	245	60.25
	54TH722430	4693	5164	4267	71.75	24	29.5	67	194	40.5
	54TH723030	4927	5420	4480	71.75	30	29.5	67	191	48.75
	54TH723630	5339	5871	4855	71.75	36	29.5	67	233	57
	54TH724230	6480	7129	5891	71.75	42	29.5	67	260	65.5
	54TH842430	5204	5722	4730	83.75	24	29.5	79	217	46.75
	54TH843030	5466	6012	4968	83.75	30	29.5	79	217	56.25
	54TH843630	5897	6489	5363	83.75	36	29.5	79	265	66
	54TH844230	7080	7788	6436	83.75	42	29.5	79	295	75.75
	54TH962430	5748	6323	5227	95.75	24	29.5	91	236	53.25
	54TH963030	6080	6688	5528	95.75	30	29.5	91	239	64
	54TH963630	6466	7111	5878	95.75	36	29.5	91	292	75
	54TH964230	7829	8611	7117	95.75	42	29.5	91	325	86
 Rectangular Table, Bar Height	54TB602442	4749	5221	4317	59.75	24	41.75	55	203	47.25
	54TB603042	4847	5334	4407	59.75	30	41.75	55	220	56.75
	54TB603642	5361	5895	4870	59.75	36	41.75	55	250	66.5
	54TB604242	5888	6475	5352	59.75	42	41.75	55	266	76.5
	54TB662442	4815	5296	4378	65.75	24	41.75	61	212	51.5
	54TB663042	5002	5502	4546	65.75	30	41.75	61	230	62
	54TB663642	5477	6024	4979	65.75	36	41.75	61	263	72.75
	54TB664242	6004	6605	5457	65.75	42	41.75	61	281	83.5
	54TB722442	4908	5398	4462	71.75	24	41.75	67	221	56
	54TB723042	5153	5667	4684	71.75	30	41.75	67	241	67.25
	54TB723642	5586	6144	5079	71.75	36	41.75	67	276	79
	54TB724242	6779	7459	6162	71.75	42	41.75	67	297	90.5
	54TB842442	5442	5989	4948	83.75	24	41.75	79	245	64.75
	54TB843042	5717	6289	5196	83.75	30	41.75	79	268	78
	54TB843642	6170	6788	5611	83.75	36	41.75	79	303	91.25
	54TB844242	7403	8144	6732	83.75	42	41.75	79	332	104.75
	54TB962442	6014	6612	5468	95.75	24	41.75	91	263	73.5
	54TB963042	6317	6948	5742	95.75	30	41.75	91	290	88.5
	54TB963642	6764	7441	6149	95.75	36	41.75	91	329	104
	54TB964242	8190	9009	7445	95.75	42	41.75	91	362	119.25

CAUTION: Ando tables are shipped in one piece and are large & heavy. Please ensure consideration is taken regarding widths of entrances, aisles and stairways for maneuvering tables into office areas. If packing pallets need to be removed prior to the table getting into the office please ensure the bubble wrap material is left on the table to prevent damage during the move-in process.

ORDERING PROCEDURE

To order, please specify the following:

- 1) Krug product model number
- 2) Wood species and finish
- 3) Grommet location and style if applicable

*indicates model illustrated by line drawing.

STANDARD FINISHES

For a complete list of standard wood finishes please see page 347.

GROMMETS

One grommets in standard position are available at no additional charge.

POWERPORTS

Description	Model	Price	W	D	H	Shipping Weight	Cubic Feet
-------------	-------	-------	---	---	---	-----------------	------------

PowerPort 1
- 2 RJ45s (Category 5/6)

PORT1

278

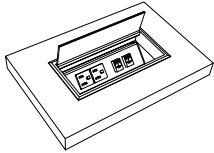
8

4

-

-

-



Port Includes: 2 accessible power outlets & 1 side utility outlet powered by a 10' plug-in cord; 2 RJ45 (category 5/6) each with hard wired 10' data cords; 2 velcro wire managers and metal PowerPort shroud. PortPort lid is Silver Metallic.
NOTE: RJ45 jacks with hard wired data cords included here must be within 10' of building utilities source to be functional.

PowerPort 2
- USB-A & USB-C

PORT2

280

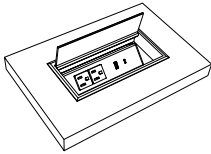
8

4

-

-

-



Port Includes: 2 accessible power outlets & 1 side utility outlet; 1 USB-A & 1 USB-C charging ports all powered by a 10' plug-in cord; 2 velcro wire managers and metal PowerPort shroud. PortPort lid is Silver Metallic.

PowerPort 3
- RJ11 & RJ45

PORT3

269

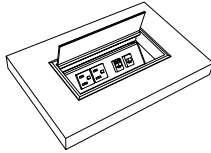
8

4

-

-

-



Port Includes: 2 accessible power outlets & 1 side utility outlet; 1 RJ11 & 1 RJ45 (Category 5/6); 2 Velcro wire managers & PowerPort Shroud; 1 x 10 Foot Data Cords (T568A) & 1 x 14 Foot RJ11 (Telecomm); powered by a 10' plug-in cord. PortPort lid is Silver Metallic.

NOTE: RJ45 & RJ11 jacks with hard wired data cords included here must be within 10' of building utilities source to be functional.

PowerPort 4
- 2 USB-A

PORT4

286

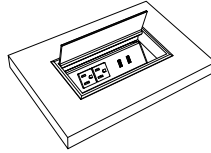
8

4

-

-

-



Port Includes: 2 accessible power outlets & 1 side utility outlet; 2- USB-A charging ports all powered by a 10' plug-in cord; 2 velcro wire managers and metal PortPort shroud. PortPort lid is Silver Metallic.

PowerPort 5
- 4 Receptacles

PORT5

280

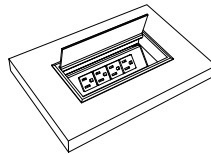
8

4

-

-

-



Port Includes: 4 accessible power outlets & 1 side utility outlet powered by a 10' plug-in cord; 2 velcro wire managers and metal power port shroud. PortPort lid is Silver Metallic.

PowerPort 6
- USB-A, USB-C & RJ45

PORT6

406

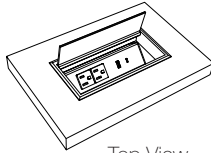
8

4

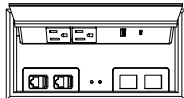
-

-

-



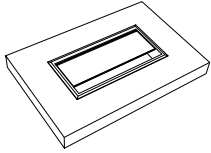
Top View



Port Includes: 2 accessible power outlets & 1 side utility outlet 1 USB-A, 1 USB-C charging ports all powered by a 10' plug-in power cord. Includes 2 velcro wire managers and metal PortPort shroud with 2 data plate knock outs, 1 #M02 plate insert & 2 #S01W RJ45 female input, punch down terminal output snap in jacks. 2nd data plate knock out is blank for future use. PortPort lid is Silver Metallic.

ACCESSORIES & WIRE MANAGEMENT

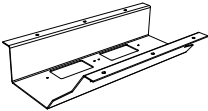
Description	Model	Price	W	D	H	Shipping Weight	Cubic Feet
Port - no Powerbar	Port0	137	8	4	-	-	-



Port Includes: Lid & Shroud only.

ORDERING NOTE: Velcro wire managers not included, see below for pricing. Port lid is Silver Metallic.

PowerPort Shroud with 2 Data Plate Knock-outs	SHROUD2KO	Must be requested - no upcharge	-	-	-	-	-
---	-----------	------------------------------------	---	---	---	---	---



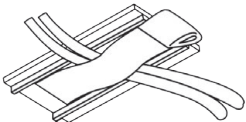
Angled PowerPort Shroud Includes: shroud with 2 data plate knock-outs in the bottom.

ORDERING NOTE: Please refer to data plate, data and AV integration options on page XX.

Cable Manager	METAL - 54CM1TH	187	2.5	-	25	-	-
	54CM1TB	229	2.5	-	36.5	-	-
	WOOD - 54CM1TH1	408	2.5	-	25	-	-
	- 54CM1TB1	451	2.5	-	36.5	-	-



Velcro Wire Manager (qty 1)	WM-4	26	2	4.5	0.5	-	-
-----------------------------	------	----	---	-----	-----	---	---



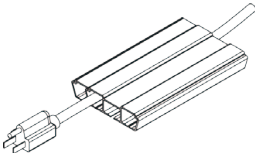
2 velcro wire managers are included with Ports 1-5.

Wire Management Trough	WM-72	182	72	3	1	-	-
------------------------	-------	-----	----	---	---	---	---



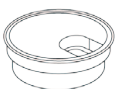
Wire Management Trough is standard in a 72" length & can be cut to specific length; double-sided tape installation.

4-Channel Wire Management	CM-72	231	72	3	1	-	-
---------------------------	-------	-----	----	---	---	---	---

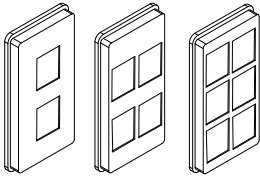

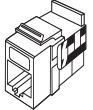
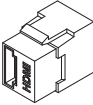
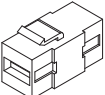


4-Channel Wire Management is standard in a 72" length & can be cut to specific length; double-sided tape installation.

Round Grommet	Round Grommet - Silver Metallic	152	-	-	-	-	-
	Round Grommet - Black	152	-	-	-	-	-



One 60mm Grommet in a standard position is available at no charge per table.

SNAP IN PORTS	Reference Code	Description	List Price
ADAPTOR PLATES			
	M02	Adaptor Plate (2) - accepts two snap in data ports	38
	M04	Adaptor Plate (4) - accepts four snap in data ports	38
	M06	Adaptor Plate (6) - accepts six snap in data ports	38
ORDERING NOTES: Blank covers are required when port is not in use, please see page 55.			
		RJ-45 - Category 6 data connection. This connector is also downwards compatible with Category 5 cabling. Connector is a female input with a #110 punch-down terminal block output (back side of Console interface) for on-site hard wire connection.	47
	S01W	RJ45-CAT6 (White)	
	S01B	RJ45-CAT6 (Blue)	
	S01R	RJ45-CAT6 (Red)	
		RJ11 - Telephone type connection. Connector is a female input with a #110 punch-down terminal block output (back side of Console interface) for on-site hard wire connection.	32
	S02W	RJ11 (White)	
	S02B	RJ11-B (Black)	
	S02G	RJ11-G (Green)	
	S02R	RJ11-R (Red)	
	S02Y	RJ11-Y (Yellow)	
	S04	HDMI - High Definition Multimedia Interface connection. Connector carries both HD audio and video data. Connector is a female-to-female pass through.	173
	S08	USB-A - Full size USB "A" style connection. Connector is a female-to-female pass through.	61

REVO | TABLE OF CONTENTS

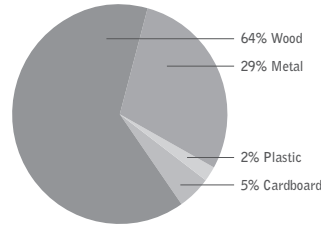
REVO

127	Environmental Summary
128	Features & Options
132	Power Options
138	Seating Capacities
139	Example Configurations
140	Tables Fixed C & T Base
144	Nesting Tables C & T Base
147	Connecting Tops
148	Rectangular Folding Tables C & T Base
149	Modesty Panels
155	PowerPorts
156	Power Accessories

LEED CERTIFICATION



MATERIAL CONTENT:



PRE-CONSUMER
RECYCLED CONTENT - 77%

POST-CONSUMER
RECYCLED CONTENT - 9%

		CONTRIBUTES To
Credit 2.1 - 2.2	Construction Waste Management	1-2 point(s)
Credit 3.3	Resource Reuse	1 point
Credit 4.1	Recycled Content	1 point
Credit 4.2	Recycled Content	1 point
Credit 4.5	Low Emitting Materials, (MUST BE REQUESTED) Composite Wood & Laminate Adhesives	1 point
Credit 5.1	Regional Materials*	1 point
Credit 6	Rapidly Renewable Materials (MUST BE REQUESTED)	1 point
Credit 7	Certified Wood (MUST BE REQUESTED)	1 point

*This credit is only applicable if in total 20% of the combined value of the procurement of construction materials and in the furniture are manufactured within a radius of 500 miles. This credit will apply if the installation of the finished product occurs within 500 miles of Kitchener, Ontario.



level® CERTIFICATION

BIFMA's e3 Furniture Sustainability Standard is a voluntary, multi-attribute standard that measures the degree of sustainability of furniture. This standard evaluates product and company environmental attributes and compliance systems in a wide range of elements which include Materials, Energy & Atmosphere, Human & Ecosystem Health and Social Responsibility. Revo products have earned level®, BIFMA's sustainability certification program for furniture, certification through third-party verification against the e3 standard. All Revo products can be supplied with level® certification. In order to accomplish this, the product must also be ordered with the air-emissions-certification option. Contact customer service for information and upcharges.



the mark of responsible forests

AIR-EMISSIONS

All Revo products can be supplied with air-emissions-certified materials. Contact customer service for information and upcharges.

FSC®

FSC® In 2005, Krug received Forest Stewardship Council® (FSC®) Chain-of-Custody certification for our manufacturing facilities. The FSC® Chain-of-Custody tracks certified wood from seedling to final sale. It verifies that the material for our FSC® certified products only come from well-managed, FSC®-certified forests and other controlled sources. FSC® is dedicated to the promotion of responsible forest management worldwide helping to take care of forests for future generations. Revo and other Krug products can be specified with FSC® Certification. Contact customer service for further information, pricing and lead times...

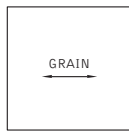


In addition, architects, designers, and building professionals can specify FSC®-certified products in order to achieve a point from the U.S. Green Building Council's Leadership in Energy and Environmental Design (LEED) Rating System.

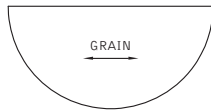
REVO | FEATURES & OPTIONS

TRAINING TABLE TOP SHAPES

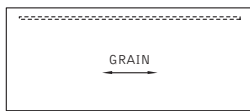
Revo Training are available in 5 table top shapes.



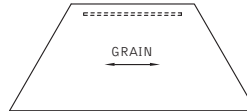
Square



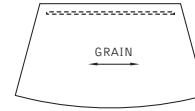
Half Round



Rectangular



Trapezoid



Arched Trapezoid

Dotted line depicts which side a modesty panel is available on. 1/2 Round and Square tops not available with modesty panels. Grommets, Surface Modules, PowerPorts and Ports when specified are positioned on the same side as the modesty panel.

WORKSURFACES

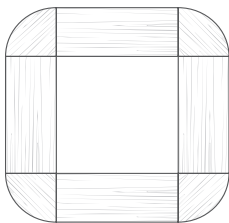
Worksurfaces with Knife (K) edge profile - Tops are 1 1/8" thick veneered, laminated - 45 lb. fibreboard MDF core and backer material.

Worksurfaces with T-Edge profile - Tops are 1 1/8" thick veneered, laminated -42 lbs. particleboard core with backer material.

Worksurfaces with D-Edge profile - Tops are 1 1/8" thick veneered, laminated -42 lbs. particleboard core with backer material.

All worksurfaces have a profiled edges on all sides. Corner Connecting tops have a profile on the curved edge only.

GRAIN DIRECTION - WOOD VENEER AND WOOD GRAIN LAMINATE

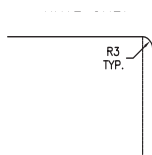


Please note: On Revo corner CONNECTOR TOPS, the grain runs on a 45° angle. For all other Revo Training tables, the grain runs lengthwise. For wood modesty panels the grain runs vertically. For laminate modesty panels, the grain runs horizontally.

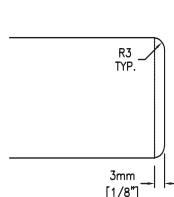
EDGE OPTIONS – TRAINING TABLES

Revo training product offers 3 edge profiles.

D-Edge

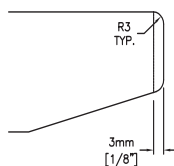


T-Edge



"D" edge profile and "T" edge profile are available on Wood and Laminate worksurfaces.

Knife Edge



Knife Edge is optional on Wood and Laminate worksurfaces for a upcharge of **\$157 list** per table.

WOOD FINISH

A five step catalyzed varnish finish that when dry has a sheen value of 32° is applied to all Revo Training table tops.

METAL FINISH

Revo components have a powder coated Silver Metallic finish.

LEGS

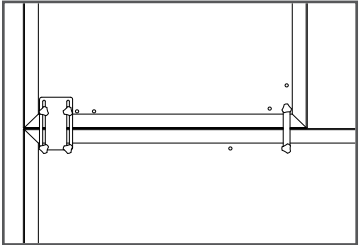
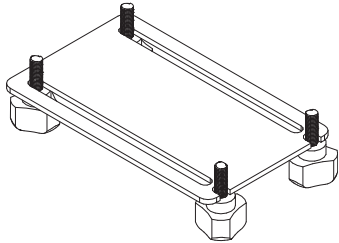
Revo "T" and "C" style legs are available in fixed, folding and nesting versions. All legs are available with casters or glides. Revo legs with casters come with a 2" caster in Silver Metallic finish. They have the ability to lock with a foot release lever located at the base of the wheel. Revo legs with glides have 1 1/4" of height adjustment, longer glides are available upon request for very uneven floors. Revo legs allow for cables to be channeled through the leg and concealed with a snap-on cover which allows cord access to the top and bottom when required.

MODESTY PANELS

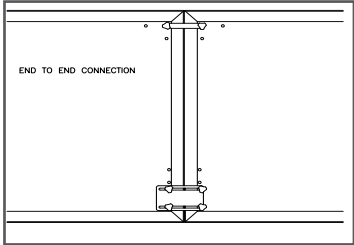
Revo modesty panels are available in wood, laminate and aluminum in both fixed and flip versions. Fixed modesty panels are available with no cable management trough, with cable management trough or cable management for power and data. The flip version is equipped for power and data with access from either side.

GANGING BRACKETS

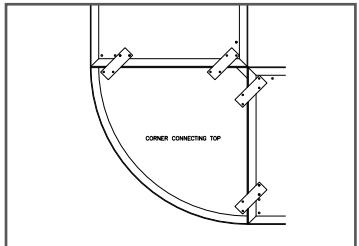
A set of ganging brackets are recommended when 2 or more tables are being joined to one another. These ganging brackets should be ordered along with the tables as a separate line item on the order. All tables come pre-drilled for ganging capabilities. Please note corner connector tops are supplied with an alternative mounting plate. The Ganging Brackets are used to prevent separation of the tables when configured in a layout.



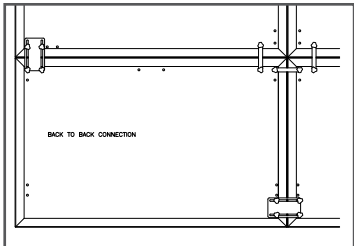
BACK TO END CONNECTION



END TO END CONNECTION



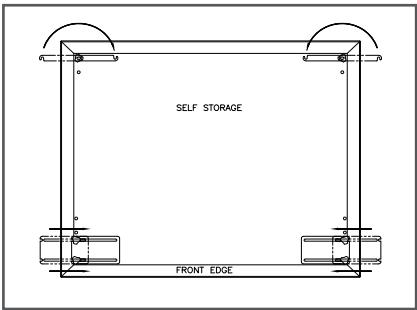
CORNER TOP CONNECTION



BACK TO BACK CONNECTION

SELF STORING

The Ganging Brackets can be neatly tucked underneath the table when not being used to join to another table. This allows the Revo Training Tables to be easily reconfigured when wanting to add or subtract tables from existing configurations.



PACKAGING

Revo packaging features recycled and recyclable cardboard and bubble wrap. The product is shipped as separate components. Bases and modesty panels have to be attached to table top surface after delivery.

REVO | FEATURES & OPTIONS

REVO TRAINING BASES

All Revo Training C bases are available in 16" and 20" widths, with standard (W1) and high capacity (W2) cable managers. All Revo Training T bases are available in 20" width, with standard (W1) and high capacity (W2) cable managers.

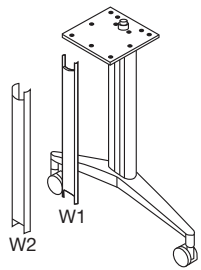
BASE SIZES

16" C Bases are used on Revo Training Tables that are 20" in depth.

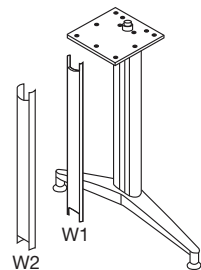
20" C Bases are used on Revo Training Tables that are 24" and 30" in depth.

20" T Bases are used on Revo Training Tables that are 24", 30" and 36" in depth.

Fixed T Base

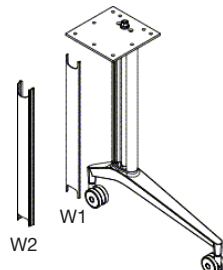


With Casters

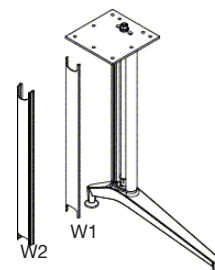


With Glides

Fixed C Base

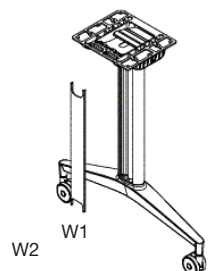


With Casters

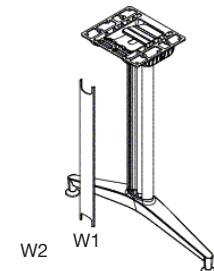


With Glides

Folding T Base

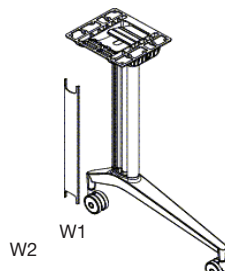


With Casters

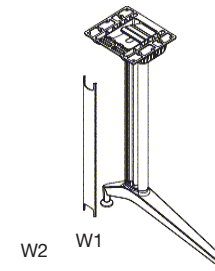


With Glides

Folding C Base

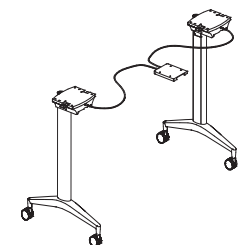


With Casters

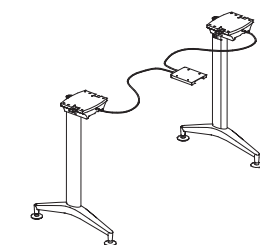


With Glides

Nesting T Base

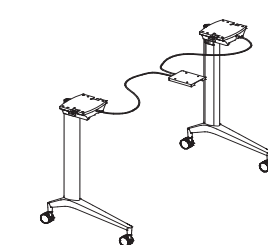


With Casters

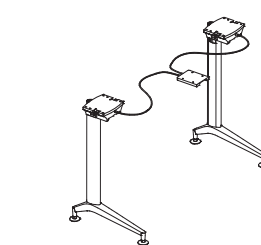


With Glides

Nesting C Base



With Casters

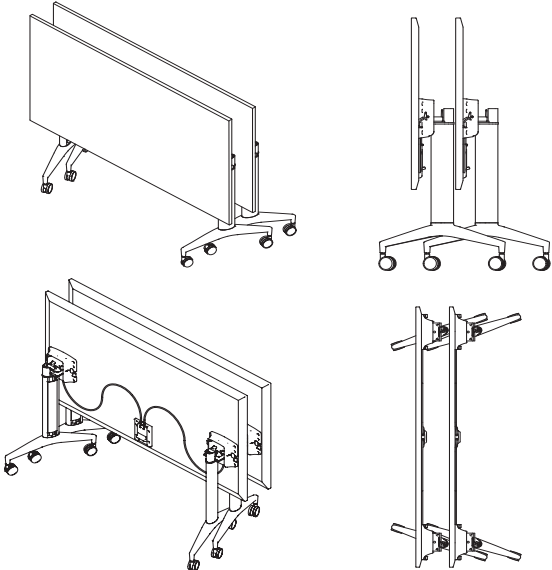


With Glides

REVO TRAINING | FEATURES & OPTIONS

REVO NESTING TABLES

With innovative design and clever construction, the Revo Nesting table is an ideal solution for training rooms, classrooms or meeting rooms. A simple and easy to operate one handed release handle allows the table top to rotate downwards 90 degrees for ease of storage or quick room configuration. In addition, the wheeled legs rotate 20 degrees for compact nested storage, resulting in an efficient use of space.



Nested Table Dimensions:

- 20" D table = 16 1/8"
- 24" D table = 19 7/8"
- 30" D table = 19 7/8"
- 36" D table = 32 1/8"

Add 7.5"D for each additional nested tables or add 12" if modesty panels are attached.

For Example: A 20" D table in a nested position is 16 1/8" D. Add 9 additional nesting tables (9 x 7.5"=67.5"D). Therefore, the depth requirement for nested tables is 83.75"D.

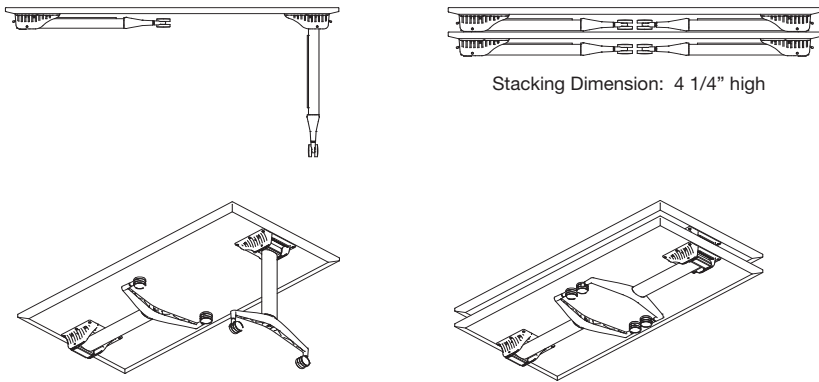
Total space required to nest 10 table without modesty panels is 83.75" x the length of the table.

Table Height of nested tables:

24" deep - T Base	41.75"	20" deep - C Base	37.25"
30" deep - T Base	44.75"	24" deep - C Base	37.25"
36" deep - T Base	47.5"	30" deep - C Base	40.25"
36" deep - T Base	47.5"		

REVO FOLDING TABLES

The Revo Folding Legs features our easy to use release lever that when activated retracts the legs parallel to be underside of the tabletop, allowing tables to be stacked vertically or horizontally. This feature can be used anywhere but is particularly beneficial in settings which need to be reconfigured quickly or frequently. The flattened table maximizes storage space. The optional storage cart, which holds up to 5 tables vertically, makes movement of the folded tables safe and easy. Folding tables cannot accommodate powerports or surface modules.



Stacking Dimension: 4 1/4" high



REVO | POWER OPTIONS



POWERPORT

The Revo Training PowerPort made from aluminum and featuring a hinged lid, provides a functional and attractive solution for connectivity. The PowerPort comes standard with 2 accessible power outlets & 1 side utility outlet powered by a 10' plug-in cord; 2 RJ45 (category 5/6) each with hard wired 10' data cords; 2 velcro wire managers and metal PowerPort shroud. PortPort lid is Silver Metallic.

The PowerPort is a UL/CSA-approved power/data power bar, (Port) which includes three 115-volt electrical convenience outlets, and two RJ45 communication ports - all easily accessed just under the worksurface. The PowerPort is Category 5/6 compatible. Folding tables cannot accommodate powerports or surface modules.

PORT

The Port alone (without the powerbar) serves as a large grommet for cable management, or to enable future power-up of the tables. It is 7.5" wide by 4" long, and features an aluminum hinged lid that is designed to be in the closed position when cables pass through to the plug-in. The Port can accommodate multiple cables at once, as well as transformer plugs, through the worksurface.

PowerPorts and Ports can be specified in 3 different locations (left, right or center) depending on the size of the training table surface. On surfaces that are smaller than 60", PowerPorts and Ports are available only in the center position.

See page xx for options and location codes for selecting the PowerPort and Port location for each table top.



SURFACE MODULE

The Surface Module is a lower cost alternative to the PowerPort. It is compact and convenient and positions the plug-in on the work surface itself, instead of underneath it.

A Surface Module comes with two power receptacles above the work surface and one power receptacle below the work surface, which allows you to connect power to additional tables or configurations. In addition, the Surface Module also comes with two USB Ports -- one USB printer port, one RJ11 and one RJ45. Each receptacle has a 12 Amp, 120 Volt, 60 Hz capacity and comes standard with a 10' heavy duty power cord with a right angle plug. Folding tables cannot accommodate powerports or surface modules.

The Surface Module has an angled face that is easy to see and operate. The RJ45 Port allows connection to high speed DSL or Internet and provides access to cable modem, network or Internet router. In addition, a power plug exists for cell phone and laptop. There are two USB ports -- one for input and one for output to accommodate almost any electrical needs. The Surface Module is available in black finish only.

Surface Modules can be specified in three (3) different locations (Left, Right and Center) depending on the size of the meeting table surface. On surfaces that are smaller than 60", Surface Modules are available only in the centre position.

See page 130 for options and location codes for selecting the Surface Module location for each table top.



ROUND GROMMET

A round grommet with an open and shut mousehole serves to provide cable passage for areas not requiring a large opening.

Round grommet Silver Metallic, 60 mm diameter. (2 3/8" approx.)

Round grommets do not provide electrical service.

Grommets can be specified in 3 different locations (left, right or center) depending on the size of the meeting table surface.

On surfaces that are smaller than 60", grommets are available only in the center position.

One round grommet per table is provided at no charge, additional round grommets are available for an upcharge of **\$152 list** per grommet.

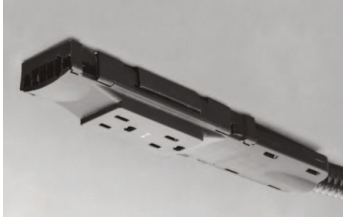


4-WIRE SYSTEM

The 4-wire System is a economical power distribution solution that is easy to specify, install, and re-configure.

Features:

- 4-wires, 2 circuits, 20 amps each
- 10 - duplex receptacles per circuit, 20 - 15 Amp receptacles per power infeed maximum
- Requires less space
- UL Listed as a Manufactured Wiring System
- More economical than 8-wire system
- RoHS Compliancy available upon request; Cradle to Cradle
- Can be used independently with grommet or PORT0.



Model Numbers for 4-wire System

Circuit 1	Circuit 2	Description
59EC4-30-1	59EC4-30-2	4 wire, 2 circuit system for 30" table
59EC4-36-1	59EC4-36-2	4 wire, 2 circuit system for 36" table
59EC4-42-1	59EC4-42-2	4 wire, 2 circuit system for 42" table
59EC4-48-1	59EC4-48-2	4 wire, 2 circuit system for 48" table
59EC4-54-1	59EC4-54-2	4 wire, 2 circuit system for 54" table
59EC4-60-1	59EC4-60-2	4 wire, 2 circuit system for 60" table
59EC4-66-1	59EC4-66-2	4 wire, 2 circuit system for 66" table
59EC4-72-1	59EC4-72-2	4 wire, 2 circuit system for 72" table
59EC4-78-1	59EC4-78-2	4 wire, 2 circuit system for 78" table
59EC4-84-1	59EC4-84-2	4 wire, 2 circuit system for 84" table

4-WIRE SYSTEM

The 4-wire system can power a maximum of 10 duplex receptacles per circuit, 20 duplex receptacles total. With 2 duplex receptacles per table, this means that no more than 5 tables can be connected to one circuit (10 tables per 4-wire system). Once you have more than 10 tables powered with the 4-Trac® system, you must order another Power Entry (59EC4PE) and the related 4-wire harnesses to access a new circuit. Duplex receptacles are marked as circuit 1 or circuit 2. Unless specified, Krug will package as close as possible equal quantities of circuit 1 and 2 wiring harnesses.

All Krug's power access options can be used with or without the 4-wire Wire System. These components can be ordered together, or at a later date as your power requirements change.

Example 1: If you have a connected group of 7 (48" length) tables with a grommet in each, using the 4-wire system, you would order:

- One 4 wire, 2 circuit power entry (59EC4PE).
- Four tables will use circuit 1 harnesses (59EC4-48-1), which has two duplex receptacles per harness for a total of 8 duplex receptacles.
- Three tables will use circuit 2 harnesses (59EC-48-2), which has two duplex receptacles per harness for a total of 6 duplex receptacles.

Example 2: If you have a connected group of 11 (48" length) tables with a grommet in each, using the 4-wire system, you would order:

- Two 4 wire, 2 circuit power entry (59EC4PE).
For the 1st power entry:
- Three tables will use circuit 1 harnesses (59EC4-48-1), which has two duplex receptacles per harness for a total of 6 duplex receptacles.
- Three tables will use circuit 2 harnesses (59EC-48-2), which has two duplex receptacles per harness for a total of 6 duplex receptacles.

For the 2nd power entry:

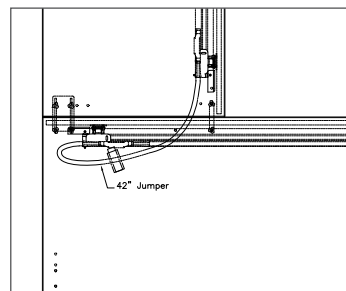
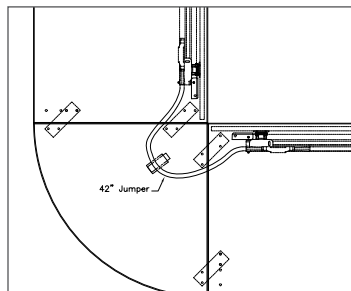
- Three tables will use circuit 1 harnesses (59EC4-48-1), which has two duplex receptacles per harness for a total of 6 duplex receptacles.
- Two tables will use circuit 2 harnesses (59EC-48-2), which has two duplex receptacles per harness for a total of 4 duplex receptacles.

4-WIRE - 42" JUMPERS

These longer jumper cables are required when connecting one table from the back to the end of another table using the 4-wire system. These jumper cables allow you to daisy chain each wired table to the next.



4-Wire Power Entry



REVO | POWER OPTIONS

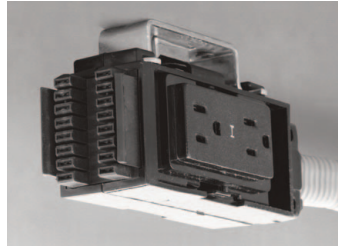


8-WIRE SYSTEM

The 8-wire Power System offers a high quality, cost effective answer to your power distribution needs. The modular system is adaptable to all architectural elements. The modularity of the System makes it simple to specify, order and install.

Features:

- UL recognized & listed
- Approved for use in New York City
- RoHS compliancy available upon request; cradle to cradle
- 20 Amp system available in 4 circuit configurations
- Allows for up to 40 duplex receptacles.
- Can be used independently with grommet or PORT0.



Model Numbers for 8-wire System

Circuit 1	Circuit 2	Circuit 3	Circuit 4	Description
59EC8-30-1	59EC8-30-2	59EC8-30-3	59EC8-30-4	8 wire, 4 circuit system for 30" table
59EC8-36-1	59EC8-36-2	59EC8-36-3	59EC8-36-4	8 wire, 4 circuit system for 36" table
59EC8-42-1	59EC8-42-2	59EC8-42-3	59EC8-42-4	8 wire, 4 circuit system for 42" table
59EC8-48-1	59EC8-48-2	59EC8-48-3	59EC8-48-4	8 wire, 4 circuit system for 48" table
59EC8-54-1	59EC8-54-2	59EC8-54-3	59EC8-54-4	8 wire, 4 circuit system for 54" table
59EC8-60-1	59EC8-60-2	59EC8-60-3	59EC8-60-4	8 wire, 4 circuit system for 60" table
59EC8-66-1	59EC8-66-2	59EC8-66-3	59EC8-66-4	8 wire, 4 circuit system for 66" table
59EC8-72-1	59EC8-72-2	59EC8-72-3	59EC8-72-4	8 wire, 4 circuit system for 72" table
59EC8-78-1	59EC8-78-2	59EC8-78-3	59EC8-78-4	8 wire, 4 circuit system for 48" table
59EC8-84-1	59EC8-84-2	59EC8-84-3	59EC8-84-4	8 wire, 4 circuit system for 84" table

8-WIRE SYSTEM

The 8-wire system can power a maximum of 10 duplex receptacles per circuit, 40 duplex receptacles total. With 2 duplex receptacles per table, this means that no more than 5 tables can be connected to one circuit (20 tables per 8-wire system). Once you have more than 20 tables powered with the 8-wire system, you must order another Power Entry (59EC8PE) and the related 8-wire harnesses to access a new circuit. Duplex receptacles are marked as circuit 1, 2, 3, or 4. Unless specified, as close as possible Krug will package equal quantities of Circuit 1, 2, 3, and 4 wiring harnesses.

All Krug's power access options can be used with or without the 8-wire Wire System. These components can be ordered together, or at a later date as your power requirements change.

For Example: If you have group of 16 (48" length) tables, using the 8-wire system, you would order: One 8 wire, 4 circuit power entry (59EC8PE).

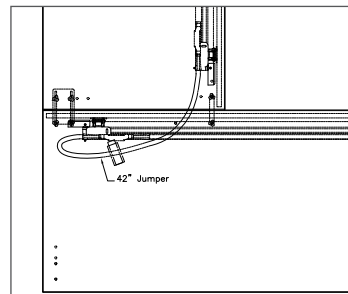
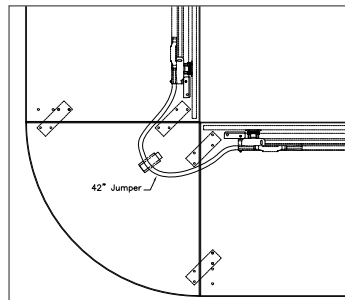
- Four tables will use circuit 1 harnesses (59EC8-48-1), which has two duplex receptacles per harness for a total of 8 duplex receptacles.
- Four tables will use circuit 2 harnesses (59EC8-48-2), which has two duplex receptacles per harness for a total of 8 duplex receptacles.
- Four tables will use circuit 3 harnesses (59EC8-48-3), which has two duplex receptacles per harness for a total of 8 duplex receptacles.
- Four tables will use circuit 4 harnesses (59EC8-48-4), which has two duplex receptacles per harness for a total of 8 duplex receptacles.

8-WIRE - 42" JUMPERS

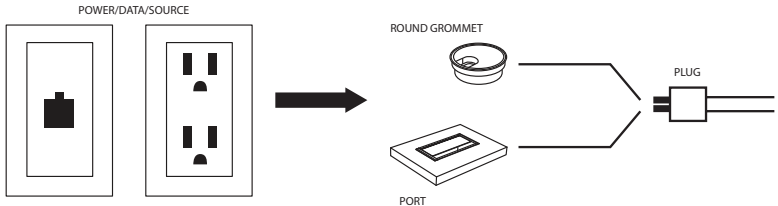
These longer jumper cables are required when connecting one table from the back to the end of another table using the 8-wire system. These jumper cables allow you to daisy chain each wired table to the next.



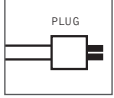
8-wire Power Entry



SCENARIO 1

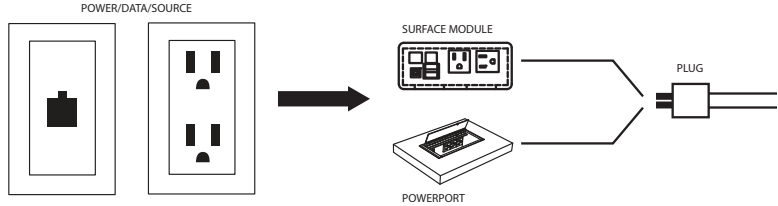


This symbol refers to: Electrical, Fax, Modem, Telephone, and Network Data



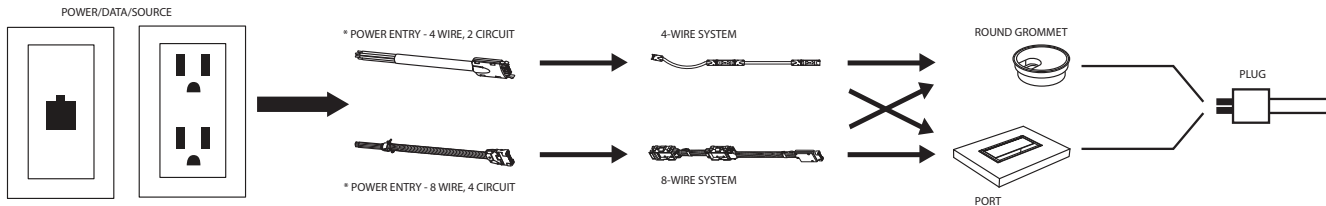
Scenario 1 is the simplest of connectivity solutions. You simply run your electrical and data cables down through the round grommet or port and plug directly into the power source.

SCENARIO 2



Scenario 2 demonstrates when powerports and surface modules are specified in the worksurfaces. Your electrical and data cables are plugged directly into these units. Both of these power options have 10' electrical cords and 14' data cables, that can be channelled through the cable management cavity in the leg and then plugged into the power source. Up to 10 powerports or surface modules can be daisy chained together from one power circuit, when the 14' data cables are not enough to reach the power source, data cables can be linked together with the use of a data hub. Please check local electrical regulations before linking these units.

SCENARIO 3

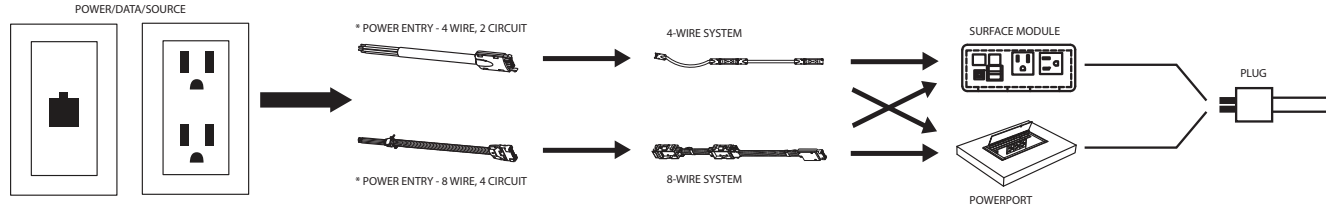


Scenario 3 illustrates the use of the 4-wire and 8-wire system. Your electrical and data cables are passed through the worksurface via the round grommet or port. The electrical equipment is plugged into the duplex receptacles located in the trac system.

The 4 trac system uses 2 circuits allowing 10 receptacles on the same circuit to be daisy chained together. Each trac system contains two duplex receptacles and can be specified with either circuit one or circuit two or both. Therefore, a maximum of 20 duplex receptacles can be used on two circuits. The 8 trac system works in the same manner, but uses 4 circuits instead of 2, allowing a maximum of 40 duplex receptacles to be used at one time.

*Power Entry is hardwired into the building source and can be channelled up the cable management cavity in the leg. The data cables run directly to the data source or linked together using a data hub.

SCENARIO 4



Scenario 4 demonstrates the use of the powerport or surface modules with the 4-wire and 8-wire system. Your electrical and data cables are plugged directly into either the powerport or surface module. The 10' power cord from these units are plugged into the duplex receptacles located in the trac system.

The 4 trac system uses 2 circuits allowing 10 receptacles on the same circuit to be daisy chained together. Each trac system contains two duplex receptacles and can be specified with either circuit one or circuit two or both. Therefore, a maximum of 20 duplex receptacles can be used on two circuits. The 8 trac system works in the same manner, but uses 4 circuits instead of 2, allowing a maximum of 40 duplex receptacles to be used at one time. When ordering powerports or surface modules on the worksurfaces, the duplex receptacles in these units need to be included in the receptacle count per circuit, otherwise the circuits will become overloaded.

*Power Entry is hardwired into the building source and can be channelled up the cable management cavity in the leg. The data cables run directly to the data source or linked together using a data hub.

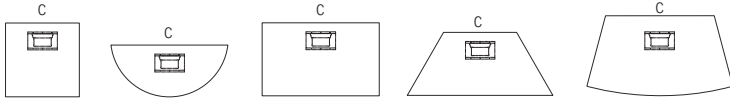
REVO | POWER OPTIONS

Non-standard locations can be specified, although there are restrictions due to leg positions, and modesty panel positions. An upcharge of **\$152 list** per non-standard grommet is applicable. Contact Customer Service for assistance. Table Tops smaller than 60" have the power access available only in the "C" position. Table tops greater than 60" can have the power access specified in as many as three locations (AR, AL and C).

Position Code:
AL – left corner
AR – right corner
C – center

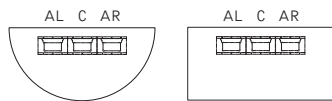
POWERPORT/PORT POSITIONS

REVO TRAINING TABLES SMALLER THAN 60"



Square Half Round Rectangular Trapezoid Arc Trapezoid

REVO TRAINING TABLES 60" OR LARGER

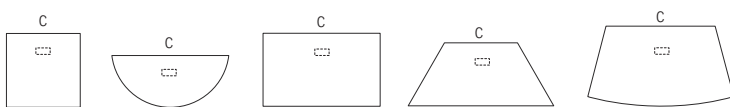


Half Round Rectangular

Modesty Panels are located on the same side as the PowerPort/Ports/Surface Modules. Modesty Panels are not available on 1/2 round and square tables. Folding tables cannot accommodate powerports.

SURFACE MODULE POSITIONS

REVO TRAINING TABLES SMALLER THAN 60"



Square Half Round Rectangular Trapezoid Arc Trapezoid

REVO TRAINING TABLES 60" OR LARGER

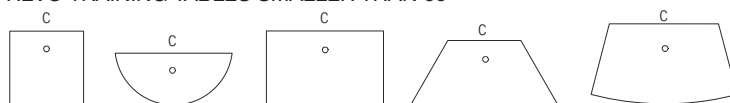


Half Round Rectangular

Modesty Panels are located on the same side as the PowerPort/Ports/Surface Modules. Modesty Panels are not available on 1/2 round and square tables. Folding tables cannot accommodate surface modules.

STANDARD GROMMET POSITIONS

REVO TRAINING TABLES SMALLER THAN 60"



Square Half Round Rectangular Trapezoid Arc Trapezoid

REVO TRAINING TABLES 60" OR LARGER

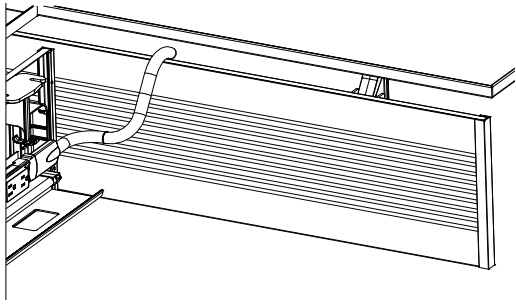


Half Round Rectangular

Modesty Panels are shown on the same side as the Round Grommets. One round grommet per table is provided at no charge, additional round grommets are available for an upcharge of **\$152 list** per grommet in standard positions. Modesty Panels are not available on 1/2 round and square tables.

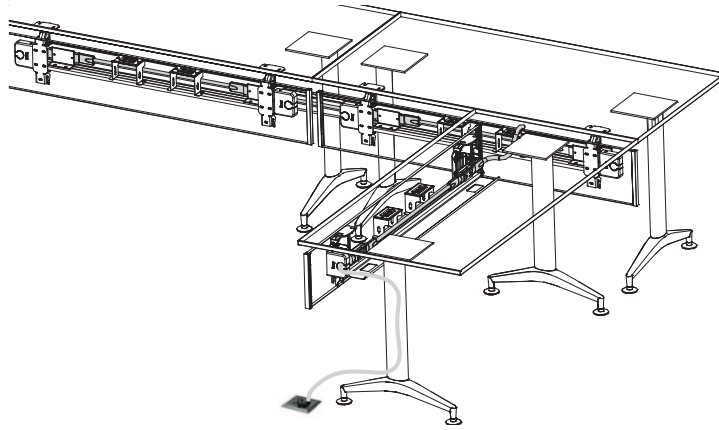
REVO | MODESTY PANEL & CABLE OPTIONS

MODESTY PANELS

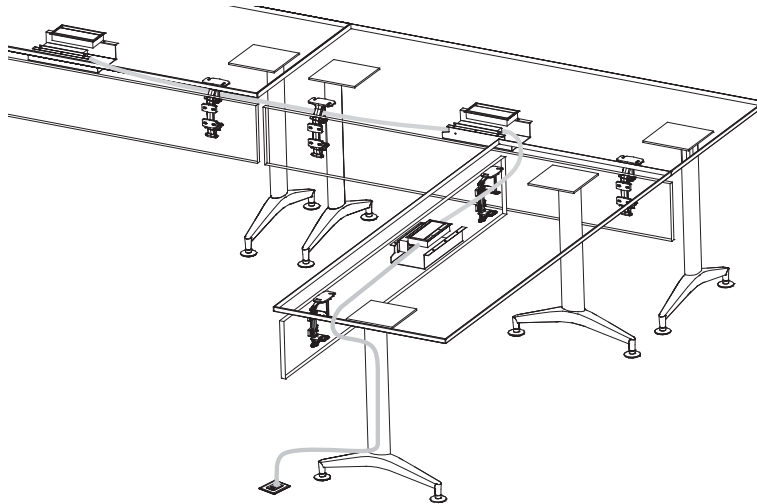


Track System, Modesty Panels for Power and Data Trough

Revo training tables have been designed with a 1-1/4" (32mm) space between the underside of the worksurface and the top edge of the modesty panel, eliminating the need for grommets in the modesty panels. This space makes it easy to pass cables from one table to another where modesty panels overlap at 90° corners, or where tables are positioned face to face. See typical examples below of cable management with different power options.



Power Ports & Modesty Panels with no Cable Management Trough



CABLE MANAGEMENT



REVO leg
Snap on Cover









Cable management

Cables are channeled through the leg and concealed with a snap-on cover which allows cord access to the top and bottom when required.

Legs are available in two cable management sizes, standard and high capacity, determined by the users' requirements.

Standard cable managers have 1.5 in² of cable management capacity. High capacity cable managers have 2.4 in² of cable management capacity.

REVO | SEATING CAPACITIES

DESCRIPTION	TOP SIZE		APPROX. SEATING FOR LONG SIDE	APPROX.	
	LENGTH	WIDTH		TOTAL SEATING FOR STAND ALONE WITHOUT MODESTY	
Half Round 	48	24	2	2	
	60	30	2	2	
	72	36	2	2	
Square 	30	30	1	2	
	36	36	1	2	
Rectangular 	48	20	1	2	
	54	20	1	2	
	60	20	2	4	
	66	20	2	4	
	72	20	2	4	
	78	20	2	4	
	84	20	3	6	
	48	24	1	2	
	54	24	1	2	
	60	24	2	4	
	66	24	2	4	
	72	24	2	4	
	78	24	2	4	
	84	24	3	6	
	48	30/36	1	2	
	54	30/36	1	2	
	60	30/36	2	4	
66	30/36	2	4		
72	30/36	2	4		
78	30/36	2	4		
84	30/36	3	6		
Trapezoid 	48	24	1	2	
	60	30	1	2	
	72	36	1	2	
Arc Trapezoid 	48	24	1	2	
	60	24	2	2	
	72	24	2	2	
	60	30	2	2	
	72	30	2	2	
	60	36	2	2	
	72	36	2	2	
Corner	45°	24	24	1	N/A
Connecting Top 		30	30	1	N/A
		36	36	1	N/A
	60°	24	24	1	N/A
		30	30	1	N/A
		36	36	1	N/A
	90°	24	24	1	N/A
		30	30	1	N/A
		36	36	1	N/A

ORDERING NOTES

If a modesty panel is used, there is no seating capacity on that side of the table. There is no seating on the ends due to base locations. Seating on the ends of a 84" tables is possible since the bases are inset 15" from the ends. To establish seating capacities, an outside chair dimension of 24" has been used, plus an allowance of 5" between chairs, for a total of 29". This is an approximation and based on seating with 5 prong bases. When using chairs with different specifications be sure to adjust the approximate seating capacity accordingly. Since not all manufacturers use this same seating formula, when a seating capacity is in question, please contact Krug Customer Service to review the specific seating that is being used with Krug Revo Training product.

REVO | EXAMPLE TABLE CONFIGURATIONS

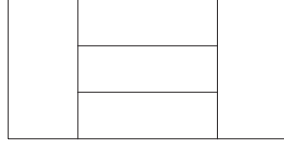
This is a sampling of some of the possible configurations in the REVO Training Table Line

RECTANGULAR TABLES



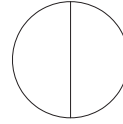
Model Number Qty.
59THRT7236 4

RECTANGULAR TABLES



Model Number Qty.
59THRT7236 2
59THRT7224 2

HALF ROUND TABLES



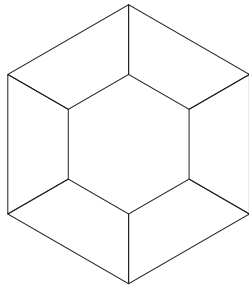
Model Number Qty.
59THDH6030 2

HALF ROUND WITH RECTANGULAR TABLES



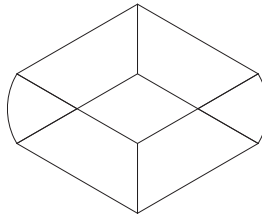
Model Number Qty.
59THDH6030 2
59THRT6030 2

TRAPEZOID TABLES



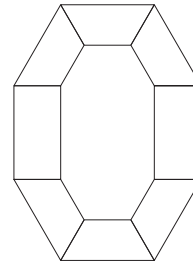
Model Number Qty.
59THTZ7236 6

60° CORNER CONNECTOR TOPS WITH TRAPEZOID TABLES



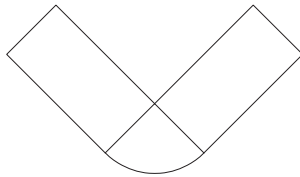
Model Number Qty.
59TC303060 2
59THTZ6030 4

TRAPEZOID TABLES WITH RECTANGULAR TABLES



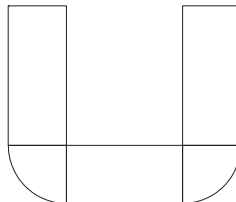
Model Number Qty.
59THTZ6030 6
59THRT6030 2

90° CORNER CONNECTOR TOP WITH RECTANGULAR TABLES



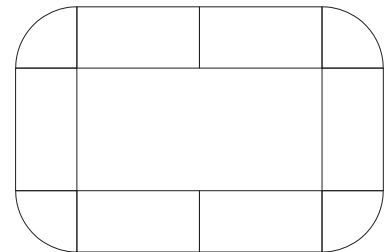
Model Number Qty.
59TC363690 1
59THRT7236 2

90° CORNER CONNECTOR TOPS WITH RECTANGULAR TABLES



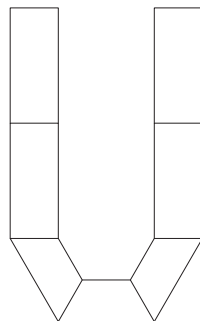
Model Number Qty.
59TC303090 2
59THRT6030 1
59THRT7230 2

90° CORNER CONNECTOR TOPS WITH RECTANGULAR TABLES



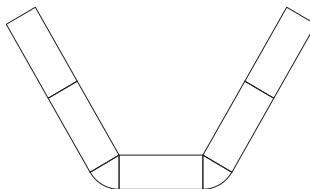
Model Number Qty.
59TC363690 4
59THRT7236 6

TRAPEZOID TABLES WITH RECTANGULAR TABLES



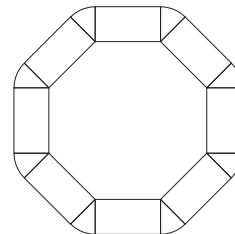
Model Number Qty.
59THTZ6030 3
59THRT6030 4

60° CORNER CONNECTOR TOPS WITH RECTANGULAR TABLES



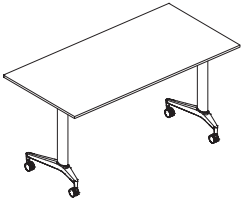
Model Number Qty.
59TC242460 2
59THRT6024 5

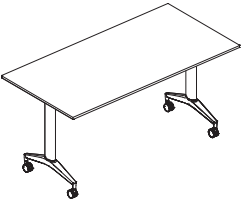
45° CORNER CONNECTOR TOPS WITH RECTANGULAR TABLES



Model Number Qty.
59TC242445 8
59THRT4824 8

REVO | RECTANGULAR TABLES W/ FIXED C & T BASES

Description	Model	Laminate W/ PVC Edge	Rift Oak, Cherry, Walnut, Maple	W	D	H	KW	Shipping Weight	Cubic Feet
 <p>C-base inset from ends: 72" tables & smaller - 3" 78" tables - inset 6" 84" tables - inset 15"</p>	59THRT4820CB_W_	1363	1789	47.75	19.75	29.25	36.5	62	5
	59THRT5420CB_W_	1394	1823	53.75	19.75	29.25	42.5	65	5.5
	59THRT6020CB_W_	1423	1860	59.75	19.75	29.25	48.5	69	5.5
	59THRT6620CB_W_	1527	1974	65.75	19.75	29.25	54.5	76	6
	59THRT7220CB_W_	1583	2048	71.75	19.75	29.25	60.5	82	6
	59THRT7820CB_W_	1645	2130	77.75	19.75	29.25	60.5	83	6.5
	59THRT8420CB_W_	1708	2210	83.75	19.75	29.25	48.5	84	7
	59THRT4824CB_W_	1415	1845	47.75	23.75	29.25	36.5	68	5.5
	59THRT5424CB_W_	1449	1886	53.75	23.75	29.25	42.5	73	6
	59THRT6024CB_W_	1482	1928	59.75	23.75	29.25	48.5	77	6
	59THRT6624CB_W_	1597	2042	65.75	23.75	29.25	54.5	80	6.5
	59THRT7224CB_W_	1666	2109	71.75	23.75	29.25	60.5	91	6.5
	59THRT7824CB_W_	1730	2191	77.75	23.75	29.25	60.5	92	7
	59THRT8424CB_W_	1795	2278	83.75	23.75	29.75	48.5	93	7.5
	59THRT4830CB_W_	1508	1915	47.75	29.75	29.25	36.5	77	6
	59THRT5430CB_W_	1533	1967	53.75	29.75	29.25	42.5	81	6.5
	59THRT6030CB_W_	1558	2017	59.75	29.75	29.25	48.5	88	6.5
	59THRT6630CB_W_	1668	2139	65.75	29.75	29.25	54.5	90	7
	59THRT7230CB_W_	1732	2217	71.75	29.75	29.25	60.5	104	7.5
	59THRT7830CB_W_	1798	2295	77.75	29.75	29.25	60.5	107	8
59THRT8430CB_W_	1862	2373	83.75	29.75	29.25	48.5	109	8	

 <p>T-base inset from ends: 72" tables & smaller - 3" 78" tables - inset 6" 84" tables - inset 15"</p>	59THRT4824TB_W_	1415	1845	47.75	23.75	29.25	36.5	68	5.5
	59THRT5424TB_W_	1449	1886	53.75	23.75	29.25	42.5	73	6
	59THRT6024TB_W_	1482	1928	59.75	23.75	29.25	48.5	77	6
	59THRT6624TB_W_	1597	2042	65.75	23.75	29.25	54.5	80	6.5
	59THRT7224TB_W_	1666	2109	71.75	23.75	29.25	60.5	91	6.5
	59THRT7824TB_W_	1730	2191	77.75	23.75	29.25	60.5	92	7
	59THRT8424TB_W_	1795	2278	77.75	23.75	29.25	48.5	93	7.5
	59THRT4830TB_W_	1508	1915	47.75	29.75	29.25	36.5	77	6
	59THRT5430TB_W_	1533	1967	53.75	29.75	29.25	42.5	81	6.5
	59THRT6030TB_W_	1558	2017	59.75	29.75	29.25	48.5	88	6.5
	59THRT6630TB_W_	1668	2139	65.75	29.75	29.25	54.5	90	7
	59THRT7230TB_W_	1732	2217	71.75	29.75	29.25	60.5	104	7.5
	59THRT7830TB_W_	1798	2295	77.75	29.75	29.25	60.5	107	8
	59THRT8430TB_W_	1862	2373	83.75	29.75	29.25	48.5	109	8
	59THRT4836TB_W_	1609	2069	47.75	35.75	29.25	36.5	91	8
	59THRT5436TB_W_	1661	2130	53.75	35.75	29.25	42.5	98	8.5
	59THRT6036TB_W_	1709	2188	59.75	35.75	29.25	48.5	104	9
	59THRT6636TB_W_	1821	2316	65.75	35.75	29.25	54.5	113	9.5
	59THRT7236TB_W_	1886	2401	71.75	35.75	29.25	60.5	122	9.5
	59THRT7836TB_W_	1955	2485	77.75	35.75	29.25	60.5	126	10
59THRT8436TB_W_	2019	2562	83.75	35.75	29.25	48.5	130	10	

ORDERING NOTES:

To order bases with glides, replace the 1st underscore in the model number with the letter "G"; e.g. "59THRT7224CBGW".

To order bases with casters, replace the 1st underscore in the model number with the letter "C"; e.g. "59THRT7224CBCW".

To order the standard cable manager replace the 2nd underscore in the model number with the number "1"; e.g. "59THRT7224CBGW1".

To order the high capacity base cable manager replace the 2nd underscore in the model number with the number "2". e.g. "59THRT7224CBCW2".

ORDERING PROCEDURE

To order, please specify the following:

- 1) Krug product model number
- 2) Wood species and finish or Laminate
- 3) Grommet location and style if applicable
- 4) Edge profile - D or T
(Knife Edge is optional on Wood and Laminate work-surfaces for a upcharge of \$150 list per table.
- 5) Modesty Panel if applicable (see page 147)

*indicates model illustrated by line drawing.

KRUG EXPRESS

See page 346 for Krug Express program.

STANDARD FINISHES

For a complete list of standard finishes, please see page 347 for Standard Wood Finishes or In-Stock Laminates.

MODESTY PANELS

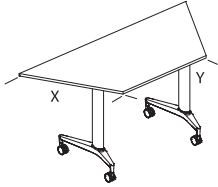
Please see page 147 for options and upcharges.

VENEER TOPS

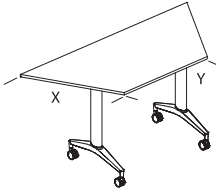
Please note when ordering wood veneer tables, these tables can only be ordered with a wood edge.

REVO | TRAPEZOID TABLES W/ FIXED C & T BASES

Description	Model	Laminate W/ PVC Edge	Rift Oak, Cherry, Walnut, Maple	W	D	H	KW	Shipping Cubic			
								Weight	Feet	X	Y
Trapezoid Table w/ Fixed C - Base. Casters or Glides - No Modesty Panel	59THTZ4824CB_W_	1504	1927	47.75	20.75	29.25	21.5	56	5.5	23.75	23.75
	59THTZ6030CB_W_	1644	2065	59.75	25.75	29.25	27.75	69	6.5	29.75	29.75
	59THTZ7236CB_W_	1909	2394	71.75	31	29.25	35.75	84	7.5	35.75	35.75



Trapezoid Table w/ Fixed T - Base. Casters or Glides - No Modesty Panel	59THTZ6030TB_W_	1644	2065	59.75	25.75	29.25	27.75	69	6.5	29.75	29.75
	59THTZ7236TB_W_	1909	2394	71.75	31	29.25	35.75	84	7.5	35.75	35.75



ORDERING NOTES:

To order bases with glides, replace the 1st underscore in the model number with the letter “G”; e.g. 59THRT7224CBGW_.

To order bases with casters, replace the 1st underscore in the model number with the letter “C”; e.g. 59THRT7224CBCW_.

To order the standard cable manager replace the 2nd underscore in the model number with the number “1”; e.g. 59THRT7224CBGW1.

To order the high capacity base cable manager replace the 2nd underscore in the model number with the number “2”; e.g. 59THRT7224CBCW2.

ORDERING PROCEDURE

To order, please specify the following:

- 1) Krug product model number
- 2) Wood species and finish or Laminate
- 3) Grommet location and style if applicable
- 4) Edge profile - D or T
(Knife Edge is optional on Wood and Laminate work-surfaces for a upcharge of **150 list** per table.
- 5) Modesty Panel if applicable (see page 147)

*indicates model illustrated by line drawing.

KRUG EXPRESS

See page 346 for Krug Express program.

STANDARD FINISHES

For a complete list of standard finishes, please see page 347 for Standard Wood Finishes or In-Stock Laminates.

MODESTY PANELS

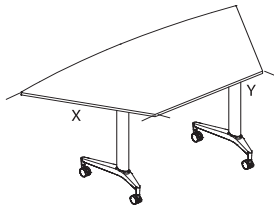
Please see page 147 for options and upcharges.

VENEER TOPS

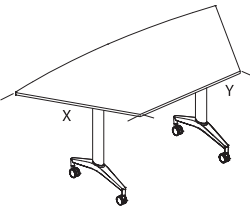
Please note when ordering wood veneer tables, these tables can only be ordered with a wood edge.

REVO | ARCED TRAPEZOID TABLES W/ FIXED C & T BASES

Description	Model	Laminate W/ PVC Edge	Rift Oak, Cherry, Walnut, Maple	W	D	H	KW	Shipping Cubic			
								Weight	Feet	X	Y
Arced Trapezoid Table w/ Fixed C - Base. Casters or Glides - No Modesty Panel	59THAZ4824CB_W_	1565	1977	47.75	23.5	29.25	20.5	59	5.5	23.75	23.75
	59THAZ6024CB_W_	1633	2064	59.75	23.5	29.25	32.25	67	6	23.75	35.75
	59THAZ7224CB_W_	1788	2280	71.75	23.5	29.25	44.25	75	6.5	23.75	47.75
	59THAZ6030CB_W_	1644	2107	59.75	28.5	29.25	29.25	72	6.5	29.75	29.75
	59THAZ7230CB_W_	1855	2340	71.75	28.5	29.25	41.25	82	7	29.75	41.75



Arced Trapezoid Table w/ Fixed T - Base. Casters or Glides - No Modesty Panel	59THAZ4824TB_W_	1565	1977	47.75	23.5	29.25	20.5	59	5.5	23.75	23.75
	59THAZ6024TB_W_	1633	2064	59.75	23.5	29.25	32.25	67	6	23.75	35.75
	59THAZ7224TB_W_	1788	2280	71.75	23.5	29.25	44.25	75	6.5	23.75	47.75
	59THAZ6030TB_W_	1644	2107	59.75	28.5	29.25	29.25	72	6.5	29.75	29.75
	59THAZ7230TB_W_	1855	2340	71.75	28.5	29.25	41.25	82	7	29.75	41.75
	59THAZ6036TB_W_	1756	2196	59.75	33.75	29.25	26	76	7	35.75	23.75
	59THAZ7236TB_W_	1947	2434	71.75	33.75	29.25	37.75	88	7.5	35.75	35.75



ORDERING NOTES: To order bases with glides, replace the 1st underscore in the model number with the letter “G”; e.g. “59THZ6030CBGW”.

To order bases with casters, replace the 1st underscore in the model number with the letter “C”; e.g. “59THZ6030CBCW”.

To order the standard cable manager replace the 2nd underscore in the model number with the number “1”; e.g. “59THZ6030CBGW1”.

To order the high capacity base cable manager replace the 2nd underscore in the model number with the number “2”; e.g. “59THZ6030CBCW2”.

DIMENSION KEY

W – width
D – depth
H – height of worksurface
KW – kneehole width
X & Y – dimensions as indicated on line drawing

Dimensions are in inches and approximate.
Contact Customer Service if dimensions are critical.

KRUG EXPRESS

See page 346 for Krug Express program.

STANDARD FINISHES

For a complete list of standard finishes, please see page 347 for Standard Wood Finishes or In-Stock Laminates.

MODESTY PANELS

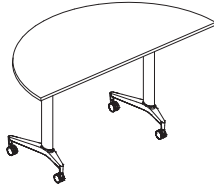
Please see page 147 for options and upcharges.

VENEER TOPS

Please note when ordering wood veneer tables, these tables can only be ordered with a wood edge.

REVO | HALF ROUND TABLES W/ FIXED C & T BASES SQUARE TABLES W/ FIXED T BASE

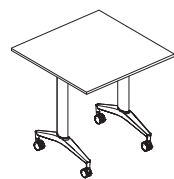
Description	Model	Laminate W/ PVC Edge	Rift Oak, Cherry, Walnut, Maple	W	D	H	KW	Shipping Cubic			
								Weight	Feet	X	Y
Half Round Table w/ Fixed C - Base. Casters or Glides - No Modesty Panel	59THDH4824CB_W_ 59THDH6030CB_W_ 59THDH7236CB_W_	1447 1673 1863	1880 2059 2386	47.75 59.75 71.75	23.75 29.75 35.75	29.25 29.25 29.25	30 33.25 45.25	60 76 95	5 6.5 8	- - -	- - -



Half Round Table w/ Fixed T - Base. Casters or Glides - No Modesty Panel	59THDH6030TB_W_ 59THDH7236TB_W_	1673 1863	2059 2386	59.75 71.75	29.75 35.75	29.25 29.25	33.25 45.25	76 95	6.5 8	- -	- -
---	------------------------------------	--------------	--------------	----------------	----------------	----------------	----------------	----------	----------	--------	--------



Square Table w/ Fixed T - Base. Casters or Glides - No Modesty Panel	59THSQ3030TB_W_ 59THSQ3636TB_W_	1512 1533	1898 1968	29.75 35.75	29.75 35.75	29.25 29.25	24.5 24.5	59 71	4 4.5	- -	- -
---	------------------------------------	--------------	--------------	----------------	----------------	----------------	--------------	----------	----------	--------	--------



ORDERING NOTES: To order bases with glides, replace the 1st underscore in the model number with the letter “G”; e.g. “59THRT7224CBGW_”.

To order bases with casters, replace the 1st underscore in the model number with the letter “C”; e.g. “59THRT7224CBCW_”.

To order the standard cable manager replace the 2nd underscore in the model number with the number “1”; e.g. “59THRT7224CBGW1”.

To order the high capacity base cable manager replace the 2nd underscore in the model number with the number “2”; e.g. “59THRT7224CBCW2”.

DIMENSION KEY

W – width
D – depth
H – height of worksurface
KW – knee-hole width
X & Y – dimensions as indicated on line drawing

Dimensions are in inches and approximate.
Contact Customer Service if dimensions are critical.

KRUG EXPRESS

See page 346 for Krug Express program.

STANDARD FINISHES

For a complete list of standard finishes, please see page 347 for Standard Wood Finishes or In-Stock Laminates.

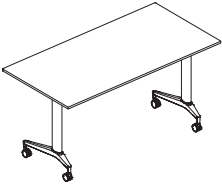
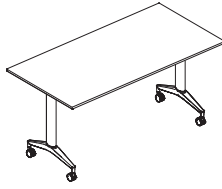
MODESTY PANELS

Modesty panels are not available on half round and square tables.

VENEER TOPS

Please note when ordering wood veneer tables, these tables can only be ordered with a wood edge.

REVO | RECTANGULAR NESTING TABLES W/ C & T BASES

Description	Model	Laminate W/ PVC Edge	Rift Oak, Cherry, Walnut, Maple	W	D	H	KW	Shipping Weight	Cubic Feet	X	Y	
	Rectangular Nesting Table w/ C - Base.	59THRT4820CBFP_W_	1861	2283	47.75	19.75	29.25	36.5	62	5	-	-
		59THRT5420CBFP_W_	1892	2321	53.75	19.75	29.25	42.5	65	5.5	-	-
		59THRT6020CBFP_W_	1922	2356	59.75	19.75	29.25	48.5	69	5.5	-	-
		59THRT6620CBFP_W_	2236	2673	65.75	19.75	29.25	54.5	76	6	-	-
		59THRT7220CBFP_W_	2286	2736	71.75	19.75	29.25	60.5	82	6	-	-
		59THRT7820CBFP_W_	2348	2808	77.75	19.75	29.25	72.5	83	6.5	-	-
		59THRT8420CBFP_W_	2415	2888	83.75	29.75	29.25	48.5	84	7	-	-
		59THRT4824CBFP_W_	1914	2346	47.75	23.75	29.25	36.5	68	5.5	-	-
		59THRT5424CBFP_W_	1949	2388	53.75	23.75	29.25	42.5	73	6	-	-
		59THRT6024CBFP_W_	1984	2431	59.75	23.75	29.25	48.5	77	6	-	-
		59THRT6624CBFP_W_	2308	2754	65.75	23.75	29.25	54.5	80	6.5	-	-
		59THRT7224CBFP_W_	2374	2818	71.75	23.75	29.25	60.5	91	6.5	-	-
		59THRT7824CBFP_W_	2436	2881	77.75	23.75	29.25	72.5	92	7	-	-
		59THRT8424CBFP_W_	2500	2944	83.75	23.75	29.25	48.5	93	7.5	-	-
		59THRT4830CBFP_W_	2007	2418	47.75	29.75	29.25	36.5	77	6	-	-
		59THRT5430CBFP_W_	2033	2466	53.75	29.75	29.25	42.5	81	6.5	-	-
		59THRT6030CBFP_W_	2059	2517	59.75	29.75	29.25	48.5	88	6.5	-	-
		59THRT6630CBFP_W_	2381	2851	65.75	29.75	29.25	54.5	90	7	-	-
	C-base inset from ends: 72" tables & smaller - 3"	59THRT7230CBFP_W_	2441	2926	71.75	29.75	29.25	60.5	104	7.5	-	-
	78" tables - inset 6"	59THRT7830CBFP_W_	2503	2998	77.75	29.75	29.25	60.5	107	8	-	-
84" tables - inset 15"	59THRT8430CBFP_W_	2668	3105	83.75	29.75	29.25	48.5	109	8	-	-	
	Rectangular Nesting Table w/ T- Base.	59THRT4824TBFP_W_	1914	2346	47.75	23.75	29.25	36.5	68	5.5	-	-
		59THRT5424TBFP_W_	1949	2388	53.75	23.75	29.25	42.5	73	6	-	-
		59THRT6024TBFP_W_	1984	2431	59.75	23.75	29.25	48.5	77	6	-	-
		59THRT6624TBFP_W_	2308	2754	65.75	23.75	29.25	54.5	80	6.5	-	-
		59THRT7224TBFP_W_	2374	2818	71.75	23.75	29.25	60.5	91	6.5	-	-
		59THRT7824TBFP_W_	2436	2881	77.75	23.75	29.25	60.5	92	7	-	-
		59THRT8424TBFP_W_	2500	2944	83.75	23.75	29.25	48.5	93	7.5	-	-
		59THRT4830TBFP_W_	2007	2418	47.75	29.75	29.25	36.5	77	6	-	-
		59THRT5430TBFP_W_	2033	2466	53.75	29.75	29.25	42.5	81	6.5	-	-
		59THRT6030TBFP_W_	2059	2517	59.75	29.75	29.25	48.5	88	6.5	-	-
		59THRT6630TBFP_W_	2381	2851	65.75	29.75	29.25	54.5	90	7	-	-
		59THRT7230TBFP_W_	2441	2926	71.75	29.75	29.25	60.5	104	7.5	-	-
		59THRT7830TBFP_W_	2606	3042	77.75	29.75	29.25	60.5	107	8	-	-
		59THRT8430TBFP_W_	2668	3105	83.75	29.75	29.25	48.5	109	8	-	-
		59THRT4836TBFP_W_	2090	2552	47.75	35.75	29.25	36.5	91	8	-	-
		59THRT5436TBFP_W_	2140	2610	53.75	35.75	29.25	42.5	98	8.5	-	-
		59THRT6036TBFP_W_	2192	2669	59.75	35.75	29.25	48.5	104	9	-	-
	T-base inset from ends: 72" tables & smaller - 3"	59THRT6636TBFP_W_	2515	3009	65.75	35.75	29.25	54.5	113	9.5	-	-
	78" tables - inset 6"	59THRT7236TBFP_W_	2577	3090	71.75	35.75	29.25	60.5	122	9.5	-	-
	84" tables - inset 15"	59THRT7836TBFP_W_	2639	3169	77.75	35.75	29.25	60.5	126	10	-	-
	59THRT8436TBFP_W_	2703	3248	83.75	35.75	29.25	48.5	130	10	-	-	

ORDERING NOTES: To order bases with glides, replace the 1st underscore in the model number with the letter "G"; e.g. "59THRT7224CBFPGW_".

To order bases with casters, replace the 1st underscore in the model number with the letter "C"; e.g. "59THRT7224CBFPCW_".

To order the standard cable manager replace the 2nd underscore in the model number with the number "1";

e.g. "59THRT7224CBFPGW1".

DIMENSION KEY

W - width
D - depth
H - height of worksurface
KW - kneehole width
X & Y - dimensions as indicated on line drawing

Dimensions are in inches and approximate.
Contact Customer Service if dimensions are critical.

KRUG EXPRESS

See page 346 for Krug Express program.

STANDARD FINISHES

For a complete list of standard finishes, please see page 347 for Standard Wood Finishes or In-Stock Laminates.

MODESTY PANELS

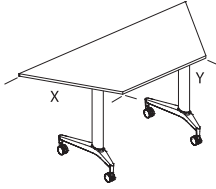
Please see page 147 for options and upcharges.

VENEER TOPS

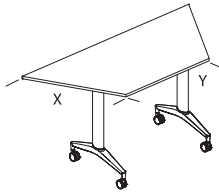
Please note when ordering wood veneer tables, these tables can only be ordered with a wood edge.

REVO | TRAPEZOID NESTING TABLES W/ C & T BASES

Description	Model	Laminate W/ PVC Edge	Rift Oak, Cherry, Walnut, Maple	W	D	H	KW	Shipping Cubic			
								Weight	Feet	X	Y
Trapezoid Nesting Table w/ C - Base. Casters or Glides - No Modesty Panel	59THTZ4824CBFP_W_ 59THTZ6030CBFP_W_ 59THTZ7236CBFP_W_	2001 2145 2472	2422 2567 2959	47.75 59.75 71.75	20.75 20.75 31	29.25 29.25 29.25	18.25 24.5 32.5	56 69 84	5.5 6.5 7.5	23.75 29.75 35.75	23.75 29.75 35.75



Trapezoid Nesting Table w/ T - Base. Casters or Glides - No Modesty Panel	59THZ6030TBFP_W_ 59THZ7236TBFP_W_	2145 2472	2567 2959	59.75 71.75	20.75 31	29.25 29.25	27.5 35.75	69 84	6.5 7.5	29.75 35.75	29.75 35.75
--	--------------------------------------	--------------	--------------	----------------	-------------	----------------	---------------	----------	------------	----------------	----------------



ORDERING NOTES: To order bases with glides, replace the 1st underscore in the model number with the letter “G”; e.g. “59THRT7224CBFPGW”.

To order bases with casters, replace the 1st underscore in the model number with the letter “C”; e.g. “59THRT7224CBFCW”.

To order the standard cable manager replace the 2nd underscore in the model number with the number “1”; e.g. “59THRT7224CBFP-W1”.

To order the high capacity base cable manager replace the 2nd underscore in the model number with the number “2”; e.g. “59THRT7224CBFCW2”.

DIMENSION KEY

W – width
D – depth
H – height of worksurface
KW – kneehole width
X & Y – dimensions as indicated on line drawing

Dimensions are in inches and approximate.
Contact Customer Service if dimensions are critical.

KRUG EXPRESS

See page 346 for Krug Express program.

STANDARD FINISHES

For a complete list of standard finishes, please see page 347 for Standard Wood Finishes or In-Stock Laminates.

MODESTY PANELS

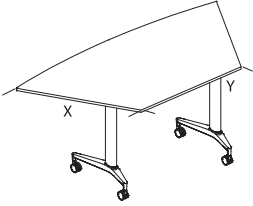
Please see page 147 for options and upcharges.

VENEER TOPS

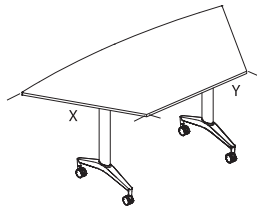
Please note when ordering wood veneer tables, these tables can only be ordered with a wood edge.

REVO | ARCED TRAPEZOID NESTING TABLES W/ C & T BASES

Description	Model	Laminate W/ PVC Edge	Rift Oak, Cherry, Walnut, Maple	W	D	H	KW	Shipping Cubic			
								Weight	Feet	X	Y
Arced Trapezoid Nesting Table w/ C - Base.	59THAZ4824CBFP_W_	2065	2479	47.75	23.5	29.25	17.25	59	5.5	23.75	23.75
Casters or Glides - No Modesty Panel	59THAZ6024CBFP_W_	2133	2566	59.75	23.5	29.25	29	67	6	23.75	35.75
	59THAZ7224CBFP_W_	2286	2780	71.75	23.5	29.25	41	75	6.5	23.75	47.75
	59THAZ6030CBFP_W_	2145	2608	59.75	28.5	29.25	26	72	6.5	29.75	29.75
	59THAZ7230CBFP_W_	2355	2839	71.75	28.5	29.25	38	82	7	29.75	41.75



Arced Trapezoid Nesting Table w/ T - Base. Casters or Glides - No Modesty Panel	59THAZ4824TBFP_W_	2065	2479	47.75	23.5	29.25	20.5	59	5.5	23.75	23.75
	59THAZ6024TBFP_W_	2133	2566	59.75	23.5	29.25	32.25	67	6	23.75	35.75
	59THAZ7224TBFP_W_	2286	2780	71.75	23.5	29.25	44.25	75	6.5	23.75	47.75
	59THAZ6030TBFP_W_	2145	2608	59.75	28.5	29.25	29.25	72	6.5	29.75	29.75
	59THAZ7230TBFP_W_	2355	2839	71.75	28.5	29.25	41.25	82	7	29.75	41.75
	59THAZ6036TBFP_W_	2256	2698	59.75	33.75	29.25	26	76	7	35.75	23.75
	59THAZ7236TBFP_W_	2449	2935	71.75	33.75	29.25	37.75	88	7.5	35.75	35.75



ORDERING NOTES: To order bases with glides, replace the 1st underscore in the model number with the letter “G”;

e.g. “59THZ6030CBFPGW_”.

To order bases with casters, replace the 1st underscore in the model number with the letter “C”; e.g. “59THZ6030CBFPCW_”.

To order the standard cable manager replace the 2nd underscore in the model number with the number “1”; e.g. “59THZ6030CBFPGW1”.

To order the high capacity base cable manager replace the 2nd underscore in the model number with the number “2”;

e.g. “59THZ6030CBFPCW2”.

DIMENSION KEY

W – width
D – depth
H – height of worksurface
KW – kneehole width
X & Y – dimensions as indicated on line drawing

Dimensions are in inches and approximate.
Contact Customer Service if dimensions are critical.

KRUG EXPRESS

See page 346 for Krug Express program.

STANDARD FINISHES

For a complete list of standard finishes, please see page 347 for Standard Wood Finishes or In-Stock Laminates.

MODESTY PANELS

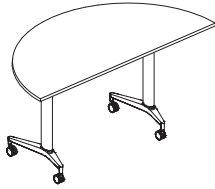
Please see page 147 for options and upcharges.

VENEER TOPS

Please note when ordering wood veneer tables, these tables can only be ordered with a wood edge.

REVO | HALF ROUND NESTING TABLES W/ C & T BASES CORNER CONNECTING TOPS

Description	Model	Laminate W/ PVC Edge	Rift Oak, Cherry, Walnut, Maple	W	D	H	KW	Shipping Cubic			
								Weight	Feet	X Y	
Half Round Nesting Table w/C - Base. Casters or Glides - No Modesty Panel	59THDH4824CBFP_W_	1944	2376	47.75	23.75	29.25	30	60	5	-	-
	59THDH6030CBFP_W_	2174	2560	59.75	29.75	29.25	33.25	76	6.5	-	-
	59THDH7236CBFP_W_	2364	2886	71.75	35.75	29.25	45.25	95	8	-	-



Half Round Nesting Table w/T - Base. Casters or Glides - No Modesty Panel	59THDH6030TBFP_W_	2174	2560	59.75	29.75	29.25	33.25	76	6.5	-	-
	59THDH7236TBFP_W_	2364	2886	71.75	35.75	29.25	45.25	95	8	-	-



45° Corner Tops	59TC242445	415	456	18.25	23.75	29.25	18.25	21	2.5	-	-
	59TC303045	438	483	22.75	35.75	29.25	22.75	27	3.5	-	-
	59TC363645	470	515	27.75	35.75	29.25	27.25	36	4.5	-	-



60° Corner Tops	59TC242460	470	515	23.75	23.75	29.25	23.75	27	3	-	-
	59TC303060	497	546	29.75	29.75	29.25	29.75	36	4	-	-
	59TC363660	532	586	35.75	35.75	29.25	35.75	44	5.5	-	-



ORDERING NOTES: To order bases with glides, replace the 1st underscore in the model number with the letter “G”; e.g. “59THRT7224CBFDGW_”.

To order bases with casters, replace the 1st underscore in the model number with the letter “C”; e.g. “59THRT7224CBFDCW_”.

To order the standard cable manager replace the 2nd underscore in the model number with the number “1”; e.g. “59THRT7224CBFDGW1”.

To order the high capacity base cable manager replace the 2nd underscore in the model number with the number “2”; e.g. “59THRT7224CBFDCW2”.

Please note that modesty panels are not available on half round tables.

DIMENSION KEY

W – width
D – depth
H – height of worksurface
KW – kneehole width
X & Y – dimensions as indicated on line drawing

Dimensions are in inches and approximate.
Contact Customer Service if dimensions are critical.

KRUG EXPRESS

See page 346 for Krug Express program.

STANDARD FINISHES

For a complete list of standard finishes, please see page 347 for Standard Wood Finishes or In-Stock Laminates.

MODESTY PANELS

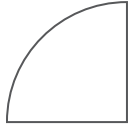
Modesty Panels are not available on half round tables.

VENEER TOPS

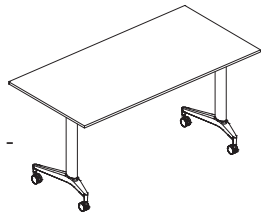
Please note when ordering wood veneer tables, these tables can only be ordered with a wood edge.

REVO | CORNER CONNECTING TOPS RECTANGULAR TABLES W/ FOLDING C & T BASES

Description	Model	Laminate W/ PVC Edge	Rift Oak, Cherry, Walnut, Maple	W	D	H	KW	Shipping Weight	Cubic Feet
90 Corner Tops	59TC242490	555	606	33.75	23.75	29.25	33.75	36	2.5
	59TC303090	586	644	42.75	29.75	29.25	42	44	5.5
	59TC363690	627	689	50.5	35.75	29.25	50.5	61	8

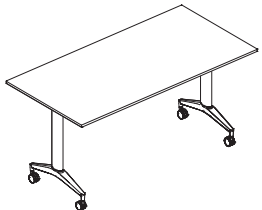


Description	Model	Laminate W/ PVC Edge	Rift Oak, Cherry, Walnut, Maple	W	D	H	KW	Shipping Weight	Cubic Feet
Rectangular Table w/ Folding C - Base. Casters or Glides - No Modesty Panel	59THRT6020CBFD_W_	1634	2046	59.75	19.75	29.25	48.5	69	5.5
	59THRT6620CBFD_W_	1729	2147	65.75	19.75	29.25	54.5	76	6
	59THRT7220CBFD_W_	1781	2210	71.75	19.75	29.25	60.5	82	6
	59THRT7820CBFD_W_	1945	2412	77.75	19.75	29.25	60.5	83	6.5
	59THRT8420CBFD_W_	2039	2492	83.75	19.75	29.25	48.5	84	7
	59THRT6024CBFD_W_	1688	2112	59.75	23.75	29.25	48.5	77	6
	59THRT6624CBFD_W_	1796	2219	65.75	23.75	29.25	54.5	80	6.5
	59THRT7224CBFD_W_	1861	2282	71.75	23.75	29.25	60.5	91	6.5
	59THRT7824CBFD_W_	2030	2489	77.75	23.75	29.25	60.5	92	7
	59THRT8424CBFD_W_	2122	2554	83.75	23.75	29.25	48.5	93	7.5
	59THRT6030CBFD_W_	1758	2194	59.75	29.75	29.25	48.5	88	6.5
	59THRT6630CBFD_W_	1863	2312	65.75	29.75	29.25	54.5	90	7
	59THRT7230CBFD_W_	1926	2386	71.75	29.75	29.25	60.5	104	7.5
	59THRT7830CBFD_W_	2108	2530	77.75	29.75	29.25	60.5	107	8
59THRT8430CBFD_W_	2169	2615	83.75	29.75	29.25	48.5	109	8	



C-base inset from ends:
72" tables & smaller - 3"
78" tables - inset 6"
84" tables - inset 15"

Description	Model	Laminate W/ PVC Edge	Rift Oak, Cherry, Walnut, Maple	W	D	H	KW	Shipping Weight	Cubic Feet
Rectangular Table w/ Folding T- Base. Casters or Glides - No Modesty Panel	59THRT6024TBFD_W_	1688	2112	59.75	23.75	29.25	48.5	77	6
	59THRT6624TBFD_W_	1796	2219	65.75	23.75	29.25	54.5	80	6.5
	59THRT7224TBFD_W_	1861	2282	71.75	23.75	29.25	60.5	91	6.5
	59THRT7824TBFD_W_	2030	2489	77.75	23.75	29.25	60.5	92	7
	59THRT8424TBFD_W_	2122	2554	83.75	23.75	29.25	48.5	93	7.5
	59THRT6030TBFD_W_	1758	2194	59.75	29.75	29.25	48.5	88	6.5
	59THRT6630TBFD_W_	1863	2312	65.75	29.75	29.25	54.5	90	7
	59THRT7230TBFD_W_	1926	2386	71.75	29.75	29.25	60.5	104	7.5
	59THRT7830TBFD_W_	2108	2530	77.75	29.75	29.25	60.5	107	8
	59THRT8430TBFD_W_	2169	2615	83.75	29.75	29.25	48.5	109	8
	59THRT6036TBFD_W_	1905	2357	59.75	35.75	29.25	48.5	104	9
	59THRT6636TBFD_W_	2010	2480	65.75	35.75	29.25	54.5	113	9.5
	59THRT7236TBFD_W_	2072	2560	71.75	35.75	29.25	60.5	122	9.5
	59THRT7836TBFD_W_	2214	2665	77.75	35.75	29.25	60.5	126	10
59THRT8436TBFD_W_	2278	2686	83.75	35.75	29.25	48.5	130	10	



T-base inset from ends:
72" tables & smaller - 3"
78" tables - inset 6"
84" tables - inset 15"

ORDERING NOTES:

To order bases with glides, replace the 1st underscore in the model number with the letter "G"; e.g. "59THRT7224CBFDGW_".

To order bases with casters, replace the 1st underscore in the model number with the letter "C"; e.g. "59THRT7224CBFDCW_".

To order the standard cable manager replace the 2nd underscore in the model number with the number "1";

e.g. "59THRT7224CBFDGW1".

To order the high capacity base cable manager replace the 2nd underscore in the model number with the number "2";

e.g. "59THRT7224CBFDCW2".

DIMENSION KEY

W - width
D - depth
H - height of worksurface
KW - kneehole width
X & Y - dimensions as indicated on line drawing

Dimensions are in inches and approximate.
Contact Customer Service if dimensions are critical.

KRUG EXPRESS

See page 346 for Krug Express program.

STANDARD FINISHES

For a complete list of standard finishes, please see page 347 for Standard Wood Finishes or In-Stock Laminates.

MODESTY PANELS

Please see page 147 for options and upcharges.

VENEER TOPS

Please note when ordering wood veneer tables, these tables can only be ordered with a wood edge.

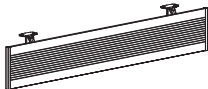
Description	Model	Table	Size	Upcharge	W	D	H	Shipping Weight	Cubic Feet
Fixed Modesty Panels Laminate No Cable Management Trough	F61	Rectangle	48"	328	46.5	4	10	14	2.5
			54"	337	52.5	4	10	15	2.5
			60"	344	58.5	4	10	16	3
			66"	357	64.5	4	10	17	3
			72"	365	70.5	4	10	18	3.5
			78"	384	76.5	4	10	20	3.5
		Arced Trapezoid	48" x 24"	283	22.5	4	10	9	1
			60" x 24"	299	34.5	4	10	12	1.5
			72" x 24"	328	46.5	4	10	14	2.5
			60" x 30"	292	28.5	4	10	11	1.5
			72" x 30"	319	40.5	4	10	13	2
Trapezoid	60" x 36"	283	22.5	4	10	9	1		
	72" x 36"	299	34.5	4	10	12	1.5		
	48" x 24"	283	22.5	4	10	9	1		
			60" x 30"	292	28.5	4	10	11	1.5
			72" x 36"	299	34.5	4	10	12	1.5



ORDERING NOTES

On laminate modesty panels, the grain runs horizontally. To specify a fixed laminate modesty panel, apply above pricing for the specific modesty panel and add "F61" to the end of the tables model number; e.g. 59THRT7224CBFDGW1F61.

Fixed Modesty Panels Aluminum No Cable Management Trough	F51	Rectangle	48"	384	46.5	6	10	19	2.5
			54"	412	52.5	6	10	21	2.5
			60"	437	58.5	6	10	23	3
			66"	460	64.5	6	10	24	3
			72"	481	70.5	6	10	26	4
			78"	518	76.5	6	10	27	3.5
		Arced Trapezoid	48" x 24"	260	22.5	6	10	13	1.5
			60" x 24"	321	34.5	6	10	17	2
			72" x 24"	369	46.5	6	10	19	3
			60" x 30"	291	28.5	6	10	15	2
			72" x 30"	352	40.5	6	10	18	2.5
Trapezoid	60" x 36"	260	22.5	6	10	13	1.5		
	72" x 36"	321	34.5	6	10	17	2		
	48" x 24"	260	22.5	6	10	13	1.5		
			60" x 30"	291	28.5	6	10	15	2
			72" x 36"	321	34.5	6	10	17	2



ORDERING NOTES

To specify an aluminum modesty panel, apply above pricing for the specific modesty panel and add "F51" to the end of the tables model number; e.g. 59THRT7224CBFDGW1F51.

DIMENSION KEY

Dimensions are in inches and approximate. Contact Customer Service if dimensions are critical.

STANDARD FINISHES

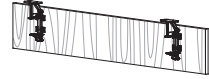
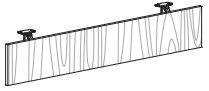
For a complete list of In-Stock Laminates, please see page 347.

KRUG EXPRESS

See page 346 for Krug Express program.

REVO | MODESTY PANELS

Description	Model	Table	Size	Upcharge	W	D	H	Shipping Weight	Cubic Feet
Fixed Modesty Panels Wood No Cable Management Trough	F11	Rectangle	48"	585	46.5	5	10	19	2.5
			54"	597	52.5	5	10	21	2.5
			60"	610	58.5	5	10	23	3
			66"	622	64.5	5	10	24	3
			72"	637	70.5	5	10	26	4
			78"	647	76.5	5	10	27	3.5
			84"	654	82.5	5	10	29	4.5
			Arced Trapezoid	48" x 24"	535	22.5	5	10	13
		60" x 24"		560	34.5	5	10	17	2
		72" x 24"		585	46.5	5	10	19	3
		60" x 30"		544	28.5	5	10	15	2
		72" x 30"		571	40.5	5	10	18	2.5
		60" x 36"		535	22.5	5	10	13	1.5
		72" x 36"		560	34.5	5	10	17	2
		Trapezoid		48" x 24"	535	22.5	5	10	13
			60" x 30"	544	28.5	5	10	15	2
	72" x 36"	560	34.5	5	10	17	2		



ORDERING NOTES

On wood modesty panels, the grain runs vertically. To specify a fixed wood modesty panel, apply above pricing for the specific modesty panel and add "F11" to the end of the tables model number; e.g. 59THRT7224CBFDGW1F11.

Fixed Modesty Panels Laminate With Cable Management Trough	F62	Rectangle	48"	365	46.5	5	10	19	2.5
			54"	374	52.5	5	10	15	2.5
			60"	382	58.5	5	10	23	3
			66"	391	64.5	5	10	17	3
			72"	404	70.5	5	10	26	4
			78"	427	76.5	5	10	20	3.5
			84"	451	82.5	5	10	29	4.5
			Arced Trapezoid	48" x 24"	321	22.5	5	10	13
		60" x 24"		338	34.5	5	10	17	2
		72" x 24"		365	46.5	5	10	19	3
		60" x 30"		330	28.5	5	10	15	2
		72" x 30"		357	40.5	5	10	18	2.5
		60" x 36"		321	22.5	5	10	13	1.5
		72" x 36"		338	34.5	5	10	17	2
		Trapezoid		48" x 24"	321	22.5	5	10	13
			60" x 30"	330	28.5	5	10	15	2
			72" x 36"	338	34.5	5	10	17	2



ORDERING NOTES

On laminate modesty panels, the grain runs horizontally. To specify a fixed laminate modesty panel, apply above pricing for the specific modesty panel and add "F62" to the end of the tables model number; e.g. 59THRT7224CBFDGW1F62.

DIMENSION KEY

Dimensions are in inches and approximate. Contact Customer Service if dimensions are critical.

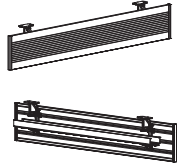
STANDARD FINISHES

For a complete list of standard finishes, please see page 347 for Standard Wood Finishes or In-Stock Laminates.

KRUG EXPRESS

See page 346 for Krug Express program.

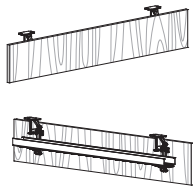
Description	Model	Table	Size	Upcharge	W	D	H	Shipping Weight	Cubic Feet		
Fixed Modesty Panels Aluminum With Cable Management Trough	F52	Rectangle	48"	434	46.5	4	10	14	2.5		
			54"	463	52.5	4	10	15	2.5		
			60"	491	58.5	4	10	16	3		
			66"	512	64.5	4	10	17	3		
			72"	532	70.5	4	10	18	3.5		
			78"	571	76.5	4	10	20	3.5		
			84"	614	82.5	4	10	21	4		
			Arced Trapezoid	48" x 24"	312	22.5	4	10	9	1	
		60" x 24"		376	34.5	4	10	12	1.5		
		72" x 24"		434	46.5	4	10	14	2.5		
		60" x 30"		345	28.5	4	10	11	1.5		
		72" x 30"		407	40.5	4	10	13	2		
		60" x 36"		312	22.5	4	10	9	1		
		Trapezoid	72" x 36"	376	34.5	4	10	12	1.5		
			48" x 24"	312	22.5	4	10	9	1		
			60" x 30"	345	28.5	4	10	11	1.5		
					72" x 36"	376	34.5	4	10	12	1.5



ORDERING NOTES

To specify an aluminum modesty panel, apply above pricing for the specific modesty panel and add "F52" to the end of the tables model number; e.g. 59THRT7224CBFDGW1F52.

Fixed Modesty Panels Wood with Cable Management Trough	F12	Rectangle	48"	619	46.5	6	10	19	2.5		
			54"	633	52.5	6	10	21	2.5		
			60"	647	58.5	6	10	23	3		
			66"	662	52.5	6	10	24	3		
			72"	676	70.5	6	10	26	4		
			78"	686	76.5	6	10	27	3.5		
			84"	695	82.5	6	10	29	4.5		
			Arced Trapezoid	48" x 24"	544	22.5	6	10	13	1.5	
		60" x 24"		582	34.5	6	10	17	2		
		72" x 24"		619	46.5	6	10	19	3		
		60" x 30"		562	28.5	6	10	15	2		
		72" x 30"		598	40.5	6	10	18	2.5		
		60" x 36"		544	22.5	6	10	13	1.5		
		Trapezoid	72" x 36"	582	34.5	6	10	17	2		
			48" x 24"	544	22.5	6	10	13	1.5		
			60" x 30"	562	28.5	6	10	15	2		
					72" x 36"	582	34.5	6	10	17	2



ORDERING NOTES

On wood modesty panels, the grain runs vertically. To specify a fixed wood modesty panel, apply above pricing for the specific modesty panel and add "F12" to the end of the tables model number; e.g. 59THRT7224CBFDGW1F12.

DIMENSION KEY

Dimensions are in inches and approximate. Contact Customer Service if dimensions are critical.

STANDARD FINISHES

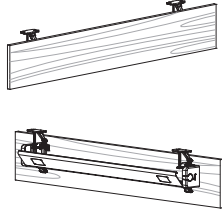
For a complete list of standard wood finishes, please see page 347.

KRUG EXPRESS

See page 346 for Krug Express program.

REVO | MODESTY PANELS

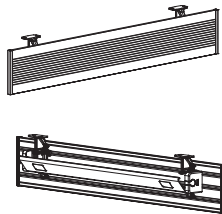
Description	Model	Table	Size	Upcharge	W	D	H	Shipping Weight	Cubic Feet
Fixed Modesty Panels Laminate For Power/ Data	F63	Rectangle	48"	466	46.5	5	10	19	2.5
			54"	478	52.5	5	10	21	2.5
			60"	485	58.5	5	10	23	3
			66"	493	64.5	5	10	24	3
			72"	507	70.5	5	10	26	4
			78"	521	76.5	5	10	27	3.5
			84"	541	82.5	5	10	29	4.5
			Arced Trapezoid	48" x 24"	423	22.5	5	10	13
		60" x 24"		438	34.5	5	10	17	2
		72" x 24"		466	46.5	5	10	19	3
		60" x 30"		431	28.5	5	10	15	2
		72" x 30"		457	40.5	5	10	18	2.5
		60" x 36"		423	22.5	5	10	13	1.5
		72" x 36"		438	34.5	5	10	17	2
		Trapezoid	48" x 24"	423	22.5	5	10	13	1.5
60" x 30"	431		28.5	5	10	15	2		
72" x 36"	438		34.5	5	10	17	2		



ORDERING NOTES

On laminate modesty panels, the grain runs horizontally. To specify a fixed laminate modesty panel, apply above pricing for the specific modesty panel and add "F63" to the end of the tables model number; e.g. 59THRT7224CBFDGW1F63.

Fixed Modesty Panels Aluminum For Power/ Data	F53	Rectangle	48"	517	46.5	5	10	19	2.5
			54"	543	52.5	5	10	21	2.5
			60"	569	58.5	5	10	23	3
			66"	602	64.5	5	10	24	3
			72"	634	70.5	5	10	26	4
			78"	680	76.5	5	10	20	3.5
			84"	730	82.5	5	10	29	4.5
			Arced Trapezoid	48" x 24"	399	22.5	5	10	13
		60" x 24"		458	34.5	5	10	17	2
		72" x 24"		517	46.5	5	10	19	3
		60" x 30"		428	28.5	5	10	15	2
		72" x 30"		480	40.5	5	10	18	2.5
		60" x 36"		399	22.5	5	10	13	1.5
		72" x 36"		458	34.5	5	10	17	2
		Trapezoid	48" x 24"	399	22.5	5	10	13	1.5
60" x 30"	428		28.5	5	10	15	2		
72" x 36"	458		34.5	5	10	17	2		



ORDERING NOTES

To specify an aluminum modesty panel, apply above pricing for the specific modesty panel and add "F53" to the end of the tables model number; e.g. 59THRT7224CBFDGW1F53.

DIMENSION KEY

Dimensions are in inches and approximate. Contact Customer Service if dimensions are critical.

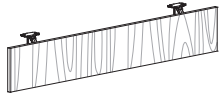
STANDARD FINISHES

For a complete list of In-Stock Laminates, please see page 347.

KRUG EXPRESS

See page 346 for Krug Express program.

Description	Model	Table	Size	Upcharge	W	D	H	Shipping Weight	Cubic Feet
Fixed Modesty Panels Wood For Power/ Data	F13	Rectangle	48"	720	46.5	4	10	14	2.5
			54"	735	52.5	4	10	15	2.5
			60"	751	58.5	4	10	16	3
			66"	763	64.5	4	10	17	3
			72"	777	70.5	4	10	18	3.5
			78"	794	76.5	4	10	20	3.5
			84"	811	82.5	4	10	21	4
		Arced Trapezoid	48" x 24"	648	22.5	4	10	9	1
			60" x 24"	680	34.5	4	10	12	1.5
			72" x 24"	720	46.5	4	10	14	2.5
			60" x 30"	665	28.5	4	10	11	1.5
			72" x 30"	699	40.5	4	10	13	2
			60" x 36"	648	22.5	4	10	9	1
		Trapezoid	72" x 36"	680	34.5	4	10	12	1.5
			48" x 24"	648	22.5	4	10	9	1
60" x 30"	665		28.5	4	10	11	1.5		
		72" x 36"	680	34.5	4	10	12	1.5	



ORDERING NOTES

On wood modesty panels, the grain runs vertically. To specify a fixed wood modesty panel, apply above pricing for the specific modesty panel and add "F13" to the end of the tables model number; e.g. 59THRT7224CBFDGW1F13.

Flip Modesty Panels Laminate For Power/ Data	Y64	Rectangle	48"	517	46.5	6	10	19	2.5
			54"	527	52.5	6	10	21	2.5
			60"	535	58.5	6	10	23	3
			66"	543	64.5	6	10	24	3
			72"	556	70.5	6	10	26	4
			78"	571	76.5	6	10	20	3.5
			84"	591	82.5	6	10	29	4.5
		Arced Trapezoid	48" x 24"	473	22.5	6	10	13	1.5
			60" x 24"	489	34.5	6	10	17	2
			72" x 24"	517	46.5	6	10	19	3
			60" x 30"	481	28.5	6	10	15	2
			72" x 30"	509	40.5	6	10	18	2.5
			60" x 36"	473	22.5	6	10	13	1.5
		Trapezoid	72" x 36"	489	34.5	6	10	17	2
			48" x 24"	473	22.5	6	10	13	1.5
60" x 30"	481		28.5	6	10	15	2		
		72" x 36"	489	34.5	6	10	17	2	



ORDERING NOTES

On laminate modesty panels, the grain runs horizontally. To specify a flip laminate modesty panel, apply above pricing for the specific modesty panel and add "Y64" to the end of the tables model number; e.g. 59THRT7224CBFDGW1Y64.

DIMENSION KEY

Dimensions are in inches and approximate. Contact Customer Service if dimensions are critical.

STANDARD FINISHES

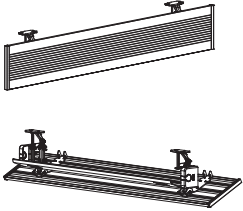
For a complete list of standard finishes, please see page 347 for Standard Wood Finishes In-Stock Laminates.

KRUG EXPRESS

See page 346 for Krug Express program.

REVO | MODESTY PANELS

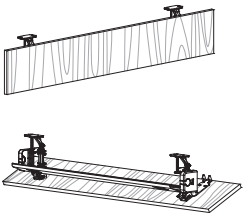
Description	Model	Table	Size	Upcharge	W	D	H	Shipping Weight	Cubic Feet
Flip Modesty Panels Aluminum For Power/ Data	Y54	Rectangle	48"	569	46.5	6	10	19	2.5
			54"	597	52.5	6	10	21	2.5
			60"	621	58.5	6	10	23	3
			66"	655	64.5	6	10	24	3
			72"	689	70.5	6	10	26	4
			78"	740	76.5	6	10	27	3.5
		84"	793	82.5	6	10	29	4.5	
		Arced Trapezoid	48" x 24"	451	22.5	6	10	13	1.5
			60" x 24"	513	34.5	6	10	17	2
			72" x 24"	569	46.5	6	10	19	3
60" x 30"	481		28.5	6	10	15	2		
72" x 30"	532		40.5	6	10	18	2.5		
60" x 36"	451		22.5	6	10	13	1.5		
Trapezoid	72" x 36"	513	34.5	6	10	17	2		
	48" x 24"	451	22.5	6	10	13	1.5		
	60" x 30"	481	28.5	6	10	15	2		
72" x 36"	513	34.5	6	10	17	2			



ORDERING NOTES

To specify a flip aluminum modesty panel, apply above pricing for the specific modesty panel and add "Y54" to the end of the tables model number; e.g. 59THRT7224CBFDGW1Y54.

Flip Modesty Panels Wood For Power/ Data	Y14	Rectangle	48"	765	46.5	6	10	19	2.5
			54"	779	52.5	6	10	21	2.5
			60"	793	58.5	6	10	23	3
			66"	806	64.5	6	10	24	3
			72"	819	70.5	6	10	26	4
			78"	837	76.5	6	10	27	3.5
		84"	854	82.5	6	10	29	4.5	
		Arced Trapezoid	48" x 24"	697	22.5	6	10	13	1.5
			60" x 24"	731	34.5	6	10	17	2
			72" x 24"	765	46.5	6	10	19	3
60" x 30"	715		28.5	6	10	15	2		
72" x 30"	751		40.5	6	10	18	2.5		
60" x 36"	697		22.5	6	10	13	1.5		
Trapezoid	72" x 36"	731	34.5	6	10	17	2		
	48" x 24"	697	22.5	6	10	13	1.5		
	60" x 30"	715	28.5	6	10	15	2		
72" x 36"	731	34.5	6	10	17	2			



ORDERING NOTES

On wood modesty panels, the grain runs vertically. To specify a flip wood modesty panel, apply above pricing for the specific modesty panel and add "Y14" to the end of the tables model number; e.g. 59THRT7224CBFDGW1Y14.

DIMENSION KEY

Dimensions are in inches and approximate. Contact Customer Service if dimensions are critical.

STANDARD FINISHES

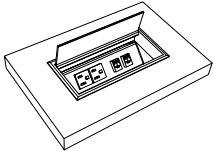
For a complete list of standard wood finishes please see page 347.

KRUG EXPRESS

See page 346 for Krug Express program.

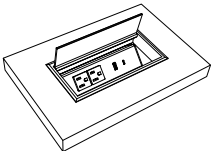
POWERPORTS

Description	Model	Price	W	D	H	Shipping Weight	Cubic Feet
PowerPort 1 - 2 RJ45s (Category 5/6)	PORT1	278	8	4	-	-	-



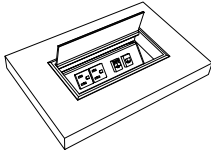
Port Includes: 2 accessible power outlets & 1 side utility outlet powered by a 10' plug-in cord; 2 RJ45 (category 5/6) each with hard wired 10' data cords; 2 velcro wire managers and metal PowerPort shroud. PortPort lid is Silver Metallic.
NOTE: RJ45 jacks with hard wired data cords included here must be within 10' of building utilities source to be functional.

PowerPort 2 - USB-A & USB-C	PORT2	280	8	4	-	-	-
--------------------------------	-------	-----	---	---	---	---	---



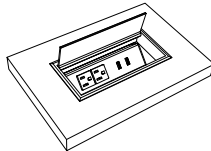
Port Includes: 2 accessible power outlets & 1 side utility outlet; 1 USB-A & 1 USB-C charging ports all powered by a 10' plug-in cord; 2 velcro wire managers and metal PowerPort shroud. PortPort lid is Silver Metallic.

PowerPort 3 - RJ11 & RJ45	PORT3	269	8	4	-	-	-
------------------------------	-------	-----	---	---	---	---	---



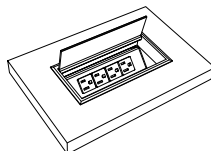
Port Includes: 2 accessible power outlets & 1 side utility outlet; 1 RJ11 & 1 RJ45 (Category 5/6); 2 Velcro wire managers & PowerPort Shroud; 1 x 10 Foot Data Cords (T568A) & 1 x 14 Foot RJ11 (Telecomm); powered by a 10' plug-in cord. PortPort lid is Silver Metallic.
NOTE: RJ45 & RJ11 jacks with hard wired data cords included here must be within 10' of building utilities source to be functional.

PowerPort 4 - 2 USB-A	PORT4	286	8	4	-	-	-
--------------------------	-------	-----	---	---	---	---	---



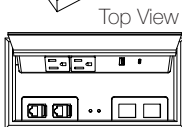
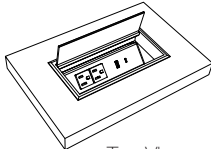
Port Includes: 2 accessible power outlets & 1 side utility outlet; 2- USB-A charging ports all powered by a 10' plug-in cord; 2 velcro wire managers and metal PortPort shroud. PortPort lid is Silver Metallic.

PowerPort 5 - 4 Receptacles	PORT5	280	8	4	-	-	-
--------------------------------	-------	-----	---	---	---	---	---



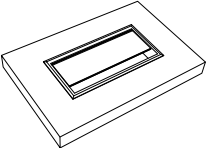
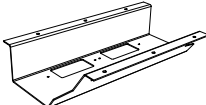
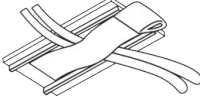

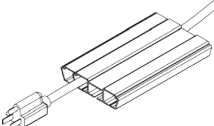
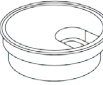
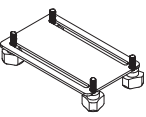
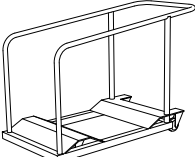
Port Includes: 4 accessible power outlets & 1 side utility outlet powered by a 10' plug-in cord; 2 velcro wire managers and metal power port shroud. PortPort lid is Silver Metallic.

PowerPort 6 - USB-A, USB-C & RJ45	PORT6	406	8	4	-	-	-
--------------------------------------	-------	-----	---	---	---	---	---

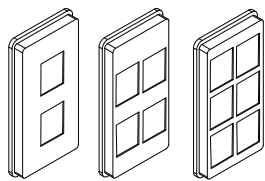


Port Includes: 2 accessible power outlets & 1 side utility outlet 1 USB-A, 1 USB-C charging ports all powered by a 10' plug-in power cord. Includes 2 velcro wire managers and metal PortPort shroud with 2 data plate knock outs, 1 #M02 plate insert & 2 #S01W RJ45 female input, punch down terminal output snap in jacks. 2nd data plate knock out is blank for future use. PortPort lid is Silver Metallic.

WIRE MANAGEMENT & ACCESSORIES

Description	Model	Price	W	D	H	Shipping Weight	Cubic Feet
Port - no Powerbar	Port0	137	8	4	-	-	-
	Port Includes: Lid & Shroud only.						
ORDERING NOTE: Velcro wire managers not included, see below for pricing. Port lid is Silver Metallic.							
PowerPort Shroud with 2 Data Plate Knock-outs	SHROUD2KO	Must be requested - no upcharge	-	-	-	-	-
	Angled PowerPort Shroud Includes: shroud with 2 data plate knock-outs in the bottom.						
ORDERING NOTE: Please refer to data plate, data and AV integration options on page XX.							
Velcro Wire Manager (qty 1)	WM-4	26	2	4.5	0.5	-	-
	2 velcro wire managers are included with Ports 1-5.						
Wire Management Trough	WM-72	182	72	3	1	-	-
	Wire Management Trough is standard in a 72" length & can be cut to specific length; double-sided tape installation.						
4-Channel Wire Management	CM-72	231	72	3	1	-	-
	4-Channel Wire Management is standard in a 72" length & can be cut to specific length; double-sided tape installation.						
Round Grommet	Round Grommet - Silver Metallic	152	-	-	-	-	-
	Round Grommet - Black	152	-	-	-	-	-
One 60mm Grommet in a standard position is available at no charge per table.							
Ganging Brackets	59GANG	48	-	-	-	1	0.5
							
Table Storage Cart	59STC	1032	60.5	32.5	34.5	82	2.5
	ORDERING NOTES Storage cart will hold 5 tables.						

SNAP IN PORTS Reference Code Description List Price



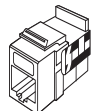
ADAPTOR PLATES

M02	Adaptor Plate (2) - accepts two snap in data ports	38
M04	Adaptor Plate (4) - accepts four snap in data ports	38
M06	Adaptor Plate (6) - accepts six snap in data ports	38

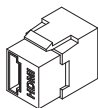
ORDERING NOTES: Blank covers are required when port is not in use, please see page 55.



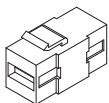
	RJ-45 - Category 6 data connection. This connector is also downwards compatible with Category 5 cabling. Connector is a female input with a #110 punch-down terminal block output (back side of Console interface) for on-site hard wire connection.	47
S01W	RJ45-CAT6 (White)	
S01B	RJ45-CAT6 (Blue)	
S01R	RJ45-CAT6 (Red)	



	RJ11 - Telephone type connection. Connector is a female input with a #110 punch-down terminal block output (back side of Console interface) for on-site hard wire connection.	32
S02W	RJ11 (White)	
S02B	RJ11-B (Black)	
S02G	RJ11-G (Green)	
S02R	RJ11-R (Red)	
S02Y	RJ11-Y (Yellow)	

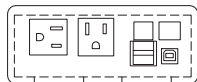


S04	HDMI - High Definition Multimedia Interface connection. Connector carries both HD audio and video data. Connector is a female-to-female pass through.	173
------------	--	-----



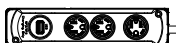
S08	USB-A - Full size USB "A" style connection. Connector is a female-to-female pass through.	61
------------	--	----

Surface Module	59SURFACEMODULE	199	8	4	-	-	-
----------------	-----------------	-----	---	---	---	---	---



ORDERING NOTES
Surface module comes with 3 receptacles - 2 above the worksurface and 1 below, 2 USB ports, 1 USB printer port, 1 RJ45 and 1 RJ11. Surface Modules have a 10' cord. Folding tables cannot accommodate surface modules.

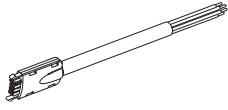
Power Bar	59PWR-USB	120	8	2	-	2	0.2
-----------	-----------	-----	---	---	---	---	-----



ORDERING NOTES
Power bar comes with 3 outlets and one powered USB port, and it has a 10' cord.

REVO | ELECTRICAL

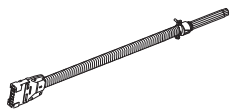
Description	Model	Price	W	D	H	Shipping Weight	Cubic Feet
Power Entry - 4 wire, 2 circuit	59EC4PE	136	-	-	-	1	.25



ORDERING NOTES

Please note when ordering the 4-wire Power Entry components, you must also order the 4-wire System, to work in conjunction. 4-wire Power Entry is hardwired into buildings power source.

Power Entry - 8 wire, 4 circuit	59EC8PE	195	-	-	-	1	.25
---------------------------------	---------	-----	---	---	---	---	-----



ORDERING NOTES

Please note when ordering the 8-wire Power Entry components, you must also order the 8-wire System, to work in conjunction. 8-wire Power Entry is hardwired into buildings power source.

4-wire 42" Jumper	59EC4JUMP-42	103	-	-	-	1	.25
-------------------	--------------	-----	---	---	---	---	-----



ORDERING NOTES

This longer jumper cable is required when connecting one table off the edge to the end of another table using the 4-Trac® system. Jumper cables allow you to daisy chain each wired table to the next.

8-wire 42" Jumper	59EC8JUMP-42	161	-	-	-	1	.25
-------------------	--------------	-----	---	---	---	---	-----



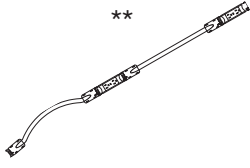
ORDERING NOTES

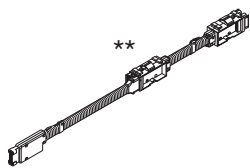
This longer jumper cable is required when connecting one table off the edge to the end of another table using the 8-wire system. Jumper cables allow you to daisy chain each wired table to the next.

DIMENSION KEY

Dimensions are in inches and approximate. Contact Customer Service if dimensions are critical.

Description

4-wire System	MODEL	MODEL	PRICE	W	D	H	SHIPPING	CUBIC
	<u>CIRCUIT 1</u>	<u>CIRCUIT 2</u>					WEIGHT	FEET
	59EC4-24-1	59EC4-24-2	220	-	-	-	2	.25
	59EC4-30-1	59EC4-30-2	224	-	-	-	2	.25
	59EC4-36-1	59EC4-36-2	227	-	-	-	2	.25
	59EC4-42-1	59EC4-42-2	229	-	-	-	2	.25
	59EC4-48-1	59EC4-48-2	233	-	-	-	2	.25
	59EC4-54-1	59EC4-54-2	239	-	-	-	2	.25
	59EC4-60-1	59EC4-60-2	244	-	-	-	2	.25
	59EC4-66-1	59EC4-66-2	250	-	-	-	2	.25
	59EC4-72-1	59EC4-72-2	257	-	-	-	2	.25
	59EC4-78-1	59EC4-78-2	261	-	-	-	2	.25
	59EC4-84-1	59EC4-84-2	267	-	-	-	2	.25

8-wire System	MODEL	MODEL	MODEL	MODEL	PRICE	W	D	H	SHIPPING	CUBIC
	<u>CIRCUIT 1</u>	<u>CIRCUIT 2</u>	<u>CIRCUIT 3</u>	<u>CIRCUIT 4</u>					WEIGHT	FEET
	59EC8-24-1	59EC8-24-2	59EC8-24-3	59EC8-24-4	318	-	-	-	2	.25
	59EC8-30-1	59EC8-30-2	59EC8-30-3	59EC8-30-4	340	-	-	-	2	.25
	59EC8-36-1	59EC8-36-2	59EC8-36-3	59EC8-36-4	372	-	-	-	2	.25
	59EC8-42-1	59EC8-42-2	59EC8-42-3	59EC8-42-4	381	-	-	-	2	.25
	59EC8-48-1	59EC8-48-2	59EC8-48-3	59EC8-48-4	388	-	-	-	2	.25
	59EC8-54-1	59EC8-54-2	59EC8-54-3	59EC8-54-4	397	-	-	-	2	.25
	59EC8-60-1	59EC8-60-2	59EC8-60-3	59EC8-60-4	411	-	-	-	2	.25
	59EC8-66-1	59EC8-66-2	59EC8-66-3	59EC8-66-4	420	-	-	-	2	.25
	59EC8-72-1	59EC8-72-2	59EC8-72-3	59EC8-72-4	428	-	-	-	2	.25
	59EC8-78-1	59EC8-78-2	59EC8-78-3	59EC8-78-4	435	-	-	-	2	.25
	59EC8-84-1	59EC8-84-2	59EC8-84-3	59EC8-84-4	444	-	-	-	2	.25

**** ORDERING NOTES**

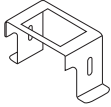
Each model comes standard with an 18" Jumper. Please note when ordering the 4-wire or 8-wire System, you must also order the appropriate 4-wire or 8-wire Power Entry.

DIMENSION KEY

Dimensions are in inches and approximate. Contact Customer Service if dimensions are critical.

REVO | DATA MOUNTING BRACKET & ACCESSORIES

Description	Model	Suffix	Description	Price	W	D	H	Shipping Weight	Cubic Feet
Data Mount Bracket black	59DMB		Mounting bracket for configured plates and side mount ports	40	6	2.75	3.25	.5	.25



ORDERING NOTES

Opening on top is for mounting a Decora wall plate and adapter plate (wall plate and blank adapter plate are standard). Openings on sides are for mounting an optional DVI connector, and a VGA connector or Serial Port.

Configured Plate Options									
	HDMI	1 HDMI Pass thru	190	-	-	-	-	-	-
	2HDMI	2 HDMI Pass thru	284	-	-	-	-	-	-
	USB-A	1 USB-A Female Port	190	-	-	-	-	-	-
	2USB-A	2 USB-A Female Ports	284	-	-	-	-	-	-
	VGA3.5*	VGA/3.5 Mini Port	120	-	-	-	-	-	-
	XLR	1 STD XLR Female (Mic) Port	261	-	-	-	-	-	-
	2XLR	2 STD XLR Female (Mic) Ports	365	-	-	-	-	-	-

Side Mount Ports									
	DVI-D*	DVI-D to DVI-D	113	-	-	-	-	-	-
	DVI-I	DVI-I to DVI-I	183	-	-	-	-	-	-

ORDERING NOTES: To specify a Configured Plate Option apply above pricing and the corresponding suffix to the end of the Data Mount Bracket price and model number. e.g. 59DMBHDMI

Data Mount Bracket Insert Plate & Face Plates For Snap-in Ports	59DMB2B	2 Blank Faceplate	64	-	-	-	-	-	-
	59DMB4B	4 Blank Faceplate	80	-	-	-	-	-	-
	59DMB6B	6 Blank Faceplate	80	-	-	-	-	-	-


Snap-In Port Options									
1C	Blank Port Cover	(Qty 1)	16	-	-	-	-	-	-
2C	Blank Port Cover	(Qty 2)	24	-	-	-	-	-	-
4C	Blank Port Cover	(Qty 4)	40	-	-	-	-	-	-
1D	RJ45 - Cat 6	(Qty 1)	71	-	-	-	-	-	-
2D	RJ45 - Cat 6	(Qty 2)	136	-	-	-	-	-	-
4D	RJ45 - Cat 6	(Qty 4)	269	-	-	-	-	-	-
6D	RJ45 - Cat 6	(Qty 6)	397	-	-	-	-	-	-
1E	RJ11	(Qty 1)	29	-	-	-	-	-	-
2E	RJ11 x 2	(Qty 2)	47	-	-	-	-	-	-
4E	RJ11 x 4	(Qty 4)	71	-	-	-	-	-	-
1F	3.5 Mini Stereo		80	-	-	-	-	-	-
1G	USB "A" Female/Female		64	-	-	-	-	-	-
1H	USB Mini B Female - A Male Exit		278	-	-	-	-	-	-
1J	Fibre Optic Jack for MTRJ		64	-	-	-	-	-	-
1K	3 Pin Mini XLR (Mic) w/Cable		752	-	-	-	-	-	-
1L	HDMI Pass Thru		388	-	-	-	-	-	-
1M	White DSL Pass thru		40	-	-	-	-	-	-
1N	BNC		64	-	-	-	-	-	-
1O	RCA Black Strip (LT Audio)		64	-	-	-	-	-	-
1P	RCA Red Strip (RT Audio)		64	-	-	-	-	-	-
1Q	RCA Yellow Strip (Video)		64	-	-	-	-	-	-
1R	4 Pin Mini Din S-Video		120	-	-	-	-	-	-
1S	RJ45 - Cat 5	(Qty 1)	64	-	-	-	-	-	-
2S	RJ45 - Cat 5	(Qty 2)	127	-	-	-	-	-	-
1T	SRL/VGA Pass Thru		223	-	-	-	-	-	-


ORDERING NOTES: To specify a Mounting Bracket with Snap-In Port options, apply above pricing and the corresponding suffix to the end of the Data Mount Bracket & Snap-In Port Face Plate price and model number. e.g. 59DMB4B2D1E1G

DIMENSION KEY

Dimensions are in inches and approximate. Contact Customer Service if dimensions are critical.

REVO | CABLE MANAGEMENT, GANGING HARDWARE, TABLE STORAGE CART

Description	Model	Price	W	D	H	Shipping Weight	Cubic Feet
Table to Table	59CMB14	46	14	2	3	0.5	0.5
Cable Manager	59CMB17	54	17	2	3	0.5	0.5
-grey plastic	59CMB20	64	20	2	3	0.5	0.5
	59CMB26	81	26	2	3	0.5	0.5
	59CMB29	92	29	2	3	0.5	0.5
	59CMB38	119	38	2	3	0.5	0.5
	59CMB14 - for use on connecting tables equal or less than 72"						
	59CMB17 - for use on connecting 78" tables to tables equal or less than 72"						
	59CMB20 - for use when connecting 78" tables to 78" tables						
	59CMB26 - for use when connecting 84" tables to tables equal or less than 72"						
	59CMB29 - for use when connecting 84" tables to 78" tables						
	59CMB38 - for use when connecting 84" tables to 84" tables						

Techflex F6 Split Braided Tube	59CMC18	58	18	1.5	1.5	0.5	0.5
-black							
	ORDERING NOTES						
	Flexible, semi-rigid wrap-able split braided tube. Used when running cables past corner connecting tops.						

DIMENSION KEY

Dimensions are in inches and approximate.
Contact Customer Service if dimensions are critical.

CHAT TABLES | TABLE OF CONTENTS

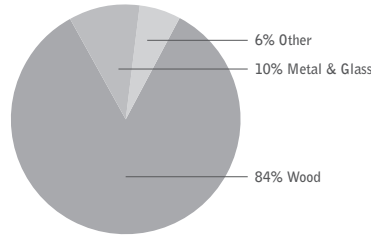
CHIT CHAT

- 163 Environmental Summary
- 164 Product Features & Options
- 165 Dimensions
- 166 Chit Chat Tables
- 167 Chit Chat Bar Tables
- 168 Chit Chat Counter Tables
- 169 Chit Chat Occasional Tables

LEED CI CREDITS



MATERIAL CONTENT:



PRE-CONSUMER
RECYCLED CONTENT = 81%

POST-CONSUMER
RECYCLED CONTENT = 3%

		CONTRIBUTES TO
CREDIT 2.1 - 2.2	Construction Waste Management	1-2 point(s)
CREDIT 3.3	Resource Reuse	1 point
CREDIT 4.1	Recycled Content	1 point
CREDIT 4.2	Recycled Content	1 point
CREDIT 4.5	Low Emitting Materials, Systems & Seating	1 point
CREDIT 5.1	Regional Materials*	1 point
CREDIT 7	Certified Wood (MUST BE REQUESTED)	1 point(s)

*This credit is only applicable if in total 20% of the combined value of the procurement of construction materials and in the furniture are manufactured within a radius of 500 miles. This credit will apply if the installation of the finished product occurs within 500 miles of Kitchener, Ontario.



level® CERTIFICATION

BIFMA's e3 Furniture Sustainability Standard is a voluntary, multi-attribute standard that measures the degree of sustainability of furniture. This standard evaluates product and company environmental attributes and compliance systems in a wide range of elements which include Materials, Energy & Atmosphere, Human & Ecosystem Health and Social Responsibility. Chit Chat products have earned level®, BIFMA's sustainability certification program for furniture, certification through third-party verification against the e3 standard. All Chit Chat products can be supplied with level® certification. In order to accomplish this, the product must also be ordered with the air-emissions-certification option. Contact customer service for information and upcharges.



FSC
www.fsc.org
FSC® C021699

the mark of responsible forest

AIR-EMISSIONS

All Chit Chat products can be supplied with air-emissions-certified materials. Contact customer service for information and upcharges.

FSC®

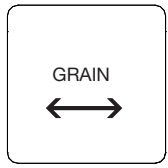
FSC® In 2005, Krug received Forest Stewardship Council® (FSC®) Chain-of-Custody certification for our manufacturing facilities. The FSC® Chain-of-Custody tracks certified wood from seedling to final sale. It verifies that the material for our FSC® certified products only come from well-managed, FSC®-certified forests and other controlled sources. FSC® is dedicated to the promotion of responsible forest management worldwide helping to take care of forests for future generations. Chit Chat and other Krug products can be specified with FSC® Certification. Contact customer service for further information, pricing and lead times..



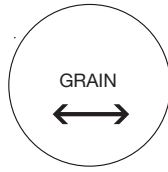
In addition, architects, designers, and building professionals can specify FSC®-certified products in order to achieve a point from the U.S. Green Building Council's Leadership in Energy and Environmental Design (LEED) Rating System.

CHIT CHAT | PRODUCT FEATURES & OPTIONS

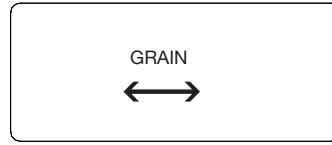
TOP SHAPE & GRAIN DIRECTION



Square

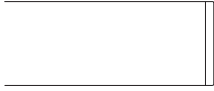


Round



Rectangle

EDGE PROFILES



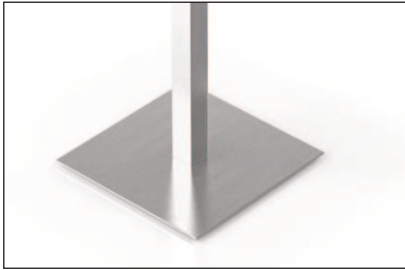
Flat Edge - T



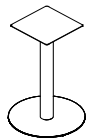
Radius Edge - D

Chit Chat Table tops are 1-1/4" thick and available in two edge profiles. **Note:** Solid Surface is only available in the D Radius edge profile. See page 348 for color options.

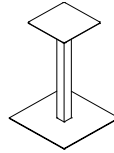
BASES



Chit Chat Table bases are available in Brushed Stainless Steel, Matte Black or White finishes with non-marring glides.



Cylindrical column with disc base



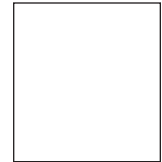
Square column with square base



Brushed Stainless Steel (-13)



Matte Black (-14)

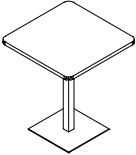


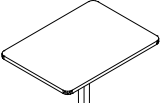
White (-44)

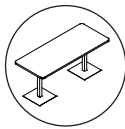
CHIT CHAT | DIMENSIONS

Model	Width	Depth	Height	Shipping Weight	Cubes
Table					
Square Table -Rounded Corners					
7261242429	24	24	29.5	40	22.25
7261303029	30	30	29.5	45	30.5
7261363629	36	36	29.5	52	40.25
Rectangular Table -Rounded Corners					
7261233029	23	30	29.5	42	18.5
7261243029	24	30	29.5	42	18.5
7261463029	45.75	30	29.5	59	32.75
7261483029	48	30	29.5	85	33.25
7261693029	68.75	30	29.5	96	47.25
7261723029	72	30	29.5	117	49
Round Table					
72052429	24D		29.5	40	15
72053029	30D		29.5	45	22
72053629	36D		29.5	62	30.25
Bar					
Square Table -Rounded Corners					
7261242442	24	24	41.75	45	21.25
7261303042*	30	30	41.75	50	31
7261363642	36	36	41.75	67	42.75
Rectangular Table -Rounded Corners					
7261233042	23	30	41.75	47	25.75
7261243042	24	30	41.75	47	25.75
7261463042	45.75	30	41.75	65	45.25
7261483042	48	30	41.75	95	47
7261693042	68.75	30	41.75	101	65.75
7261723042	72	30	41.75	127	68.5
Round Table					
72052442	25D		41.75	45	21.25
72053042	30D		41.75	50	31
72053642	36D		41.75	67	42.75
Counter					
Square Table -Rounded Corners					
7261242436	24	24	36	45	21.25
7261303036*	30	30	36	50	31
7261363636	36	36	36	67	42.75
Rectangular Table -Rounded Corners					
7261233036	23	30	36	47	25.75
7261243036	24	30	36	47	25.75
7261463036	45.75	30	36	65	45.25
7261483036	48	30	36	95	47
7261693036	68.75	30	36	101	65.75
7261723036	72	30	36	127	68.5
Round Table					
72052436	25D		36	45	21.25
72053036	30D		36	50	31
72053636	36D		36	67	42.75
Occasional					
Square Table -Rounded Corners					
7261242416	24	24	16	35	10.25
7261303016	30	30	16	40	15
7261363616	36	36	16	47	20.5
Rectangular Table -Rounded Corners					
7261233016	23	30	16	37	12.5
7261243016	24	30	16	37	12.5
7261463016	45.75	30	16	54	21.75
7261483016	48	30	16	75	22.75
7261693016	68.75	30	16	91	31.5
7261723016	72	30	16	107	32.75
Round Table					
72052416	24D		16	35	10.25
72053016	30D		16	40	15
72053616	36D		16	57	20.5

CHIT CHAT | TABLE

DESCRIPTION/MODEL		Laminate PVC Edge	HPL PVC Edge	Solid Surface top Grade A - White	Solid Surface top Grade A - Color	Solid Surface top Grade B	Solid Surface top Grade C
Square Table, -Rounded Corners 	Square Plate Base						
	7261242429SQ	868	1041	1380	1465	1570	1731
	7261303029SQ	937	1124	1569	1671	1835	2058
	7261363629SQ	1068	1284	2060	2201	2449	2778

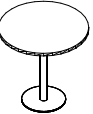
Rectangular Table, -Rounded Corners 	Square Plate Base						
	7261233029SQ	885	1062	1458	1551	1672	1856
	7261243029SQ	885	1062	1458	1551	1672	1856
	7261463029SQ	1386	1663	2377	2522	2778	3114
	7261483029SQ	1416	1699	2458	2609	2878	3231
	7261693029SQ	1535	1841	3157	3370	3741	4231

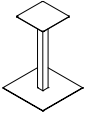


	Round Disc Base						
	7261233029DB	851	1020	1422	1515	1640	1821
	7261243029DB	851	1020	1422	1515	1640	1821
	7261463029DB	1317	1582	2310	2455	2712	3047
	7261483029DB	1351	1620	2390	2541	2810	3163
	7261693029DB	1465	1758	3089	3304	3672	4163
	7261723029DB	1505	1804	3208	3433	3822	4337

ORDERING NOTES:

Rectangular Chit Chat Tables 46" (45.75) and longer include two bases. Please note table sizes 23", 46" & 69" (68.75) coordinate with all Zola one, two and three-seat Benches.

Round Table 	Round Disc Base						
	72052429DB	834	1002	1320	1405	1530	1705
	72053029DB	900	1081	1507	1609	1802	2033
	72053629DB	1042	1251	1999	2136	2312	2434

Model		Price		Shipping Weight	Cubes
Square Plate Base 	72541828	344		39.5	1.3
	72542428	404		60.5	1.6

ORDERING NOTES:

A single 18" base can be used with tops up to a maximum of 30 inches.

Round Disc Base 	72141828	309		39.5	1.3
	72142428	380		60.5	1.6

ORDERING NOTES:

A single 18" base can be used with tops up to a maximum of 30 inches.

ORDERING PROCEDURE

To order please specify the following:

1. Select model number
2. Select top material
3. Select a color for top
4. Select base finish
5. Select edge profile

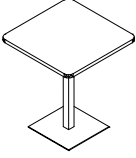
BASE FINISH

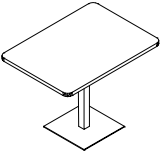
- Round Disc Base, Brushed Stainless- DB-13
- Square Plate Base, Brushed Stainless- SQ-13
- Round Disc Base, White- DB-44
- Square Plate Base, White- SQ-44
- Round Disc Base, Matte Black- DB-14
- Square Plate Base, Matte Black- SQ-14

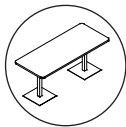
MATERIALS

For a complete list of Solid Surface colors please see page 348. Solid Surface is only available in the D Radius edge profile.

For a complete list of Laminate colors please see page 179.

DESCRIPTION/MODEL		Laminate PVC Edge	HPL PVC Edge	Solid Surface top Grade A - White	Solid Surface top Grade A - Color	Solid Surface top Grade B	Solid Surface top Grade C
Square Table, -Rounded Corners 	Square Plate Base						
	7261242442SQ	914	1096	1428	1512	1617	1777
	7261303042SQ*	984	1181	1615	1717	1881	2104
	7261363642SQ	1117	1340	2107	2249	2496	2824

Rectangular Table, -Rounded Corners 	Square Plate Base						
	7261233042SQ	931	1117	1504	1596	1719	1902
	7261243042SQ	931	1117	1504	1596	1719	1902
	7261463042SQ	1480	1774	2471	2614	2870	3207
	7261483042SQ	1509	1811	2551	2701	2970	3323
	7261693042SQ	1627	1954	3248	3463	3834	4323
	7261723042SQ	1664	1998	3368	3594	3982	4498
	Round Disc Base						
	7261233042DB	875	1048	1446	1539	1663	1845
	7261243042DB	875	1048	1446	1539	1663	1845
	7261463042DB	1374	1647	2359	2504	2760	3095
	7261483042DB	1398	1677	2438	2590	2859	3211
	7261693042DB	1514	1818	3137	3353	3722	4213
7261723042DB	1552	1861	3257	3483	3871	4385	



ORDERING NOTES:

Rectangular Chit Chat Tables 46" (45.75) and longer include two bases.

Please note table sizes 23", 46" & 69" (68.75) coordinate with all Zola one, two and three-seat Benches.

Round Table 	Round Disc Base						
	72052442DB	857	1031	1346	1430	1555	1729
	72053042DB	924	1109	1530	1632	1825	2058
	72053642DB*	1065	1279	2028	2165	2340	2462

Model		Price		Shipping Weight	Cubes
Square Plate Base 	72541841	389		42.5	1.6
	72542441	451		63.5	1.9

ORDERING NOTES:

A single 18" base can be used with tops up to a maximum of 30 inches.

Round Disc Base 	72141841	333		42.5	1.6
	72142441	407		63.5	1.9

ORDERING NOTES:

A single 18" base can be used with tops up to a maximum of 30 inches.

ORDERING PROCEDURE

To order please specify the following:

1. Select model number
2. Select top material
3. Select a color for top
4. Select base finish
5. Select edge profile

BASE FINISH

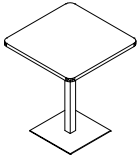
Round Disc Base, Brushed Stainless- DB-13
 Square Plate Base, Brushed Stainless- SQ-13
 Round Disc Base, White- DB-44
 Square Plate Base, White- SQ-44
 Round Disc Base, Matte Black- DB-14
 Square Plate Base, Matte Black- SQ-14

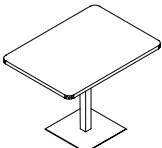
MATERIALS

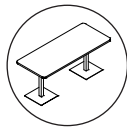
For a complete list of Solid Surface colors please see page 348. Solid Surface is only available in the D Radius edge profile.

For a complete list of Laminate colors please see page 347.

CHIT CHAT | COUNTER

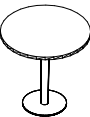
DESCRIPTION/MODEL		Laminate PVC Edge	HPL PVC Edge	Solid Surface top Grade A - White	Solid Surface top Grade A - Color	Solid Surface top Grade B	Solid Surface top Grade C
 Square Table, -Rounded Corners	Square Plate Base						
	7261242436SQ	914	1096	1428	1512	1617	1777
	7261303036SQ*	984	1181	1615	1717	1881	2104
	7261363636SQ	1117	1340	2107	2249	2496	2824

 Rectangular Table, -Rounded Corners	Square Plate Base						
	7261233036SQ	931	1117	1504	1596	1719	1902
	7261243036SQ	931	1117	1504	1596	1719	1902
	7261463036SQ	1480	1774	2471	2614	2870	3207
	7261483036SQ	1509	1811	2551	2701	2970	3323
	7261693036SQ	1627	1954	3248	3463	3834	4323
	7261723036SQ	1664	1998	3368	3594	3982	4498
	Round Disc Base						
	7261233036DB	875	1048	1446	1539	1663	1845
	7261243036DB	875	1048	1446	1539	1663	1845
	7261463036DB	1374	1647	2359	2504	2760	3095
	7261483036DB	1398	1677	2438	2590	2859	3211
	7261693036DB	1514	1818	3137	3353	3722	4213
	7261723036DB	1552	1861	3257	3483	3871	4385



ORDERING NOTES:

Rectangular Chit Chat Tables 46" (45.75) and longer include two bases.
Please note table sizes 23", 46" & 69" (68.75) coordinate with all Zola one, two and three-seat Benches.

 Round Table	Round Disc Base						
	72052436DB	857	1031	1346	1430	1555	1729
	72053036DB	924	1109	1530	1632	1825	2058
	72053636DB*	1065	1279	2028	2165	2340	2462

Model		Price		Shipping Weight	Cubes
 Square Plate Base	72541836	389		41.5	1.4
	72542436	451		62.5	1.7

ORDERING NOTES:

A single 18" base can be used with tops up to a maximum of 30 inches.

 Round Disc Base	72141836	333		41.5	1.4
	72142436	407		62.5	1.7

ORDERING NOTES:

A single 18" base can be used with tops up to a maximum of 30 inches.

ORDERING PROCEDURE

To order please specify the following:

1. Select model number
2. Select top material
3. Select a color for top
4. Select base finish
5. Select edge profile

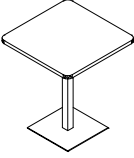
BASE FINISH

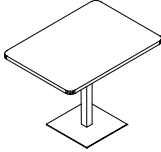
Round Disc Base, Brushed Stainless- DB-13
 Square Plate Base, Brushed Stainless- SQ-13
 Round Disc Base, White- DB-44
 Square Plate Base, White- SQ-44
 Round Disc Base, Matte Black- DB-14
 Square Plate Base, Matte Black- SQ-14

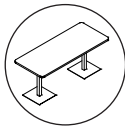
MATERIALS & FINISHES

For a complete list of Solid Surface colors please see page 348. Solid Surface is only available in the D Radius edge profile.

For a complete list of Laminate colors please see page 347.


DESCRIPTION/MODEL		Laminate PVC Edge	HPL PVC Edge	Solid Surface top Grade A - White	Solid Surface top Grade A - Color	Solid Surface top Grade B	Solid Surface top Grade C
Square Table, -Rounded Corners 	Square Plate Base						
	7261242416SQ	868	1041	1380	1465	1570	1731
	7261303016SQ	937	1124	1569	1671	1835	2058
	7261363616SQ	1068	1284	2060	2201	2449	2778

Rectangular Table, -Rounded Corners 	Square Plate Base						
	7261233016SQ	885	1062	1458	1551	1672	1856
	7261243016SQ	885	1062	1458	1551	1672	1856
	7261463016SQ	1386	1663	2377	2522	2778	3114
	7261483016SQ	1416	1699	2458	2609	2878	3231
	7261693016SQ	1535	1841	3157	3370	3741	4231
	7261723016SQ	1570	1884	3274	3501	3890	4404
	Round Disc Base						
	7261233016DB	851	1020	1422	1515	1640	1821
	7261243016DB	851	1020	1422	1515	1640	1821
	7261463016DB	1317	1582	2310	2455	2712	3047
	7261483016DB	1351	1620	2390	2541	2810	3163
	7261693016DB	1465	1758	3089	3304	3672	4163
	7261723016DB	1505	1804	3208	3433	3822	4337



ORDERING NOTES:

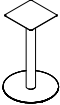
Rectangular Chit Chat Tables 46" (45.75) and longer include two bases. Please note table sizes 23", 46" & 69" (68.75) coordinate with all Zola one, two and three-seat Benches.

Round Table 	Round Disc Base						
	72052416DB	834	1002	1320	1405	1530	1705
	72053016DB	900	1081	1507	1609	1802	2033
	72053616DB	1042	1251	1999	2136	2312	2434

Model		Price		Shipping Weight	Cubes
Square Plate Base 	72541815	344		37	1.1
	72542415	404		58	1.4

ORDERING NOTES:

A single 18" base can be used with tops up to a maximum of 30 inches.

Round Disc Base 	72141815	309		37	1.1
	72142415	380		58	1.4

ORDERING NOTES:

A single 18" base can be used with tops up to a maximum of 30 inches.

ORDERING PROCEDURE

To order please specify the following:

1. Select model number
2. Select top material
3. Select a color for top
4. Select base finish
5. Select edge profile

BASE FINISH

Round Disc Base, Brushed Stainless- DB-13
 Square Plate Base, Brushed Stainless- SQ-13
 Round Disc Base, White- DB-44
 Square Plate Base, White- SQ-44
 Round Disc Base, Matte Black- DB-14
 Square Plate Base, Matte Black- SQ-14

MATERIALS & FINISHES

For a complete list of Solid Surface colors please see page 348. Solid Surface is only available in the D Radius edge profile.

For a complete list of Laminate colors please see page 347.

MILLENNIUM | TABLE OF CONTENTS

MILLENNIUM CONFERENCE TABLES

- 171 Environmental Summary
- 172 Features & Options
- 173 Special Pricing Guidelines
- 174 Tops
- 176 Bases
- 177 Base Requirements Chart
- 178 Power Box

CONNEXUS™ TABLETOP CONNECTIVITY SOLUTION

- 179 Connexus™
- 181 Preconfigured Standard Modules
- 183 Preconfigured Large Modules
- 184 Custom Connexus™
- 186 Port Options
- 190 Connexus™ Location Charts

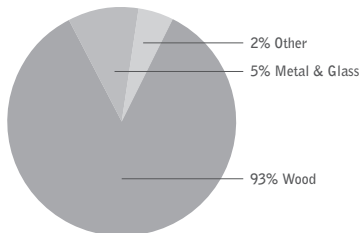
MILLENNIUM MEDIA

- 195 Media

LEED CI CREDITS



MATERIAL CONTENT:



PRE-CONSUMER RECYCLED CONTENT - 74%
POST-CONSUMER RECYCLED CONTENT - 2.5%

		CONTRIBUTES To
Credit 2.1 - 2.2	Construction Waste Management	1-2 point(s)
Credit 3.3	Resource Reuse	1 point
Credit 4.1	Recycled Content	1 point
Credit 4.2	Recycled Content	1 point
Credit 4.5	Low Emitting Materials, (MUST BE REQUESTED) Composite Wood & Laminate Adhesives	1 point
Credit 5.1	Regional Materials*	1 point
Credit 6	Rapidly Renewable Materials (MUST BE REQUESTED)	1 point
Credit 7	Certified Wood (MUST BE REQUESTED)	1 point

*This credit is only applicable if in total 20% of the combined value of the procurement of construction materials and in the furniture are manufactured within a radius of 500 miles. This credit will apply if the installation of the finished product occurs within 500 miles of Kitchener, Ontario.



level® CERTIFICATION

BIFMA's e3 Furniture Sustainability Standard is a voluntary, multi-attribute standard that measures the degree of sustainability of furniture. This standard evaluates product and company environmental attributes and compliance systems in a wide range of elements which include Materials, Energy & Atmosphere, Human & Ecosystem Health and Social Responsibility. Millennium products have earned level®, BIFMA's sustainability certification program for furniture, certification through third-party verification against the e3 standard. All Millennium products can be supplied with level® certification. In order to accomplish this, the product must also be ordered with the air-emissions-certification option. Contact customer service for information and upcharges.



The mark of responsible forestry

AIR-EMISSIONS

All Millennium products can be supplied with air-emissions-certified materials. Contact customer service for information and upcharges.

FSC®

FSC® In 2005, Krug received Forest Stewardship Council® (FSC®) Chain-of-Custody certification for our manufacturing facilities. The FSC® Chain-of-Custody tracks certified wood from seedling to final sale. It verifies that the material for our FSC® certified products only come from well-managed, FSC®-certified forests and other controlled sources. FSC® is dedicated to the promotion of responsible forest management worldwide helping to take care of forests for future generations. Millennium and other Krug products can be specified with FSC® Certification. Contact customer service for further information, pricing and lead times..



In addition, architects, designers, and building professionals can specify FSC®-certified products in order to achieve a point from the U.S. Green Building Council's Leadership in Energy and Environmental Design (LEED) Rating System.

MILLENNIUM | FEATURES & OPTIONS

EDGE PROFILES

Millennium conference product is available in Oak, Maple, Walnut and Cherry with a 32° sheen and seven distinctive edge details. Millennium conference product edge profiles match those of Millennium casegoods. Please specify an edge profile for all Millennium conference tops, and bases where indicated.



Seville
- contrasting crisp and rounded sculpted edge



Madrid
- ribbon fluted edge



Zamora
- bull nose edge



Valen
- transitional beveled edge



Barcelona
- half round edge



Williamsburg
- traditional edge



Torrens
- softened square edge

DRAWER PULLS



Oyster



Luna



Eclipse



Crescent



Williamsburg

Pulls are available in Satin Nickel, Matte Black, Polished Chrome, Black Chrome, and Brushed Brass. Pull color must be mentioned clearly on the purchase order. Pulls are located on all drawer fronts, storage wood doors, and bookcase wood doors. Glass door bookcases feature the Luna knob in the same finish as pulls on the order. Glass door hutches and wood door hutches do not have pulls. If a pull style and finish is not provided, the Eclipse pull in Black Chrome will be applied to the product. A Williamsburg pull in polished brass finish is standard on all products specified with the Williamsburg edge detail.

BASES

All bases are shipped separately and require assembly to selected top. Refer to the base requirements chart on page 173 to select the appropriate bases and sizes for conference tops. Round drums and rectangular conference bases require an edge profile to be specified, please select from the drawings shown in the previous section. Metal bases are available in a choice of chrome or black powder coat epoxy.

FINISH

A five step catalyzed varnish finish that when dry has a sheen value of 32°, is applied to all cases.

CUSTOM CONFERENCE TABLES

Krug has extensive capabilities for customization of conference tables, including special sizes, finishes, veneers, and special features such as ganging or mobility options. Please contact Customer Service with specific requirements and a drawing for more information.

SEATING CAPABILITIES

To establish seating capabilities, an outside chair dimension of 24" has been used for this price list, plus an allowance of 5" between chairs, for a total of 29". This is an approximation only. When using another chair, particularly seating with a 5 prong caster base, be sure to adjust the approximate seating capacity accordingly. Since not all manufacturers use this same formula, when a seating capacity is in question, please contact Krug Customer Service to review the specific seating that is being used with Krug Conference product.

BIRDSEYE MAPLE

Birdseye Maple veneer is available on 6800 Millennium conference tops at an upcharge of **\$76 list** per square foot. Birdseye Maple is recommended in a clear finish only. This option could extend regular lead times.

LAMINATE WORKSURFACES

Laminate worksurfaces are available at an upcharge of 10% (a higher upcharge may apply to specially priced plastic laminates). Where there are wood profile edges on worksurface tops, they will remain as wood profiles on laminate tops. Krug will order and procure laminates. Purchase orders with a plastic laminate option must include Laminate Name.

Krug reserves the right to decline a laminate that may not be suitable for the application. Krug assumes no responsibility for the durability, consistent coloration or any other performance characteristic of a customer specified laminate. Laminates may extend the normal lead-time, check with Customer Service for current scheduling information. Please see page 347 for laminate information.

MILLENNIUM | SPECIAL PRICING GUIDELINES AND PRICING METHODS

CONFERENCE

Custom sizing and additional customization is available on Krug Conference product. For more information or to obtain quotations, please contact Krug Customer Service.

Other Customization Pricing Methods for Conference

One side square add **\$238**

OTHER PRICING METHODS

6800 & 9800 - any case where tops are

Flush left/right or both add: **\$120**

9800 storage units-flush **\$199**

6800 glass tops on buffets add: **\$2373** for 60", 72", & 84" cases

Grommets in non-standard positions **\$159 list.**

Microphone cut outs per table for up to 7 microphone cut outs **\$379 list**

EXCEPTIONS TO THE PRICING METHODS ABOVE

Sizes larger than largest shown in Price List.

Non-standard extension on drawer slides.

Non-standard drawer depths in standard depth pedestals.

Glass door – any style.

Curvilinear tops with non-standard radius.

A/V cabinets.

Any case with flipper doors.

Lecterns.

Conference tables with non-standard bases, power boxes or positions.


6200 conference tables – non-standard sizes.


Please contact Krug Customer Service at 1.888.578.KRUG if you require assistance.

PLEASE NOTE: Cases with non-standard features do not apply to the rules above.

Contact Krug Customer Service if you require assistance.

MILLENNIUM | TOPS

Description	Model	Cherry Maple Walnut	Approx. Seating	Sections	Shipping Weight	Cubes
Millennium Square and Rectangular Tops 	6801-36-36	2125	4	1	52	3
	6801-42-42	2378	4	1	58	4
	6801-48-36	2439	4	1	65	3
	6801-48-42	2607	4	1	72	4
	6801-48-48	2682	4	1	84	4
	6801-60-30	2819	6	1	68	4
	6801-60-36	2881	6	1	78	4
	6801-60-60	4128	6	1	132	6
	6801-72-36	3140	6	1	100	5
	6801-84-42	4038	8	2	140	7
	6801-96-42	4422	8	2	180	8
	6801-96-48	4807	8	2	200	9
	6801-120-48	5806	10	3	240	11
	6801-120-54	6303	10	3	265	12
	6801-144-54	7225	12	3	310	14
	6801-168-54	8678	12	4	355	16
	6801-192-54	9472	12	4	400	18
	6801-216-60	10841	14	5	490	23
	6801-240-60	12048	16	5	560	25
	6801-264-60	13244	16	6	630	28
6801-288-60	14461	18	6	700	30	

Millennium Racetrack Tops 	6802-72-36	3914	6	1	100	5
	6802-84-42	4180	8	2	140	7
	6802-96-42	4444	8	2	160	8
	6802-96-48	4799	8	2	185	9
	6802-120-48	6151	10	3	225	11
	6802-120-54	6594	10	3	255	14
	6802-144-54	7369	12	3	300	16
	6802-168-54	8860	12	4	345	16
	6802-192-54	9663	12	4	390	18
	6802-216-60	11415	14	5	480	23
	6802-240-60	12675	16	5	550	25
	6802-264-60	13946	16	6	620	28
	6802-288-60	14931	18	6	690	30

All Millennium Conference products are available on the Krug Express Program with a size limitation of up to and including 168" tables only.

ORDERING PROCEDURE

To order, please specify the following:


- 1) Krug product model number
- 2) Wood species and finish
- 3) Wood edge detail - S, V, T, M, B, Z or W
see page 168


STANDARD FINISHES

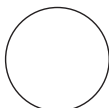
For a complete list of standard finishes please see page 347.

BASE REQUIREMENTS

See Page 173 for the base requirements chart.

Description	Model	Cherry Maple Walnut	Approx. Seating	Sections	Shipping Weight	Cubes	
	Millennium Boat	6804-96-48-42	5140	8	2	185	8
	Shaped Tops	6804-120-48-42	7057	10	2	255	10
		6804-144-48-42	7890	12	2	300	12
		6804-168-48-42	9483	12	3	345	12
		6804-192-54-48	10339	12	4	390	18
		6804-216-54-48	12211	14	5	480	23
		6804-240-54-48	13563	16	5	550	25
		6804-264-60-48	14924	16	6	620	28
		6804-288-60-48	15979	18	6	690	30

	Millennium Arc Ended Tops	6806-72-36	3988	6	1	100	5
		6806-84-42	4259	8	2	140	7
		6806-96-42	4529	8	2	160	8
		6806-96-48	4890	8	2	185	9
		6806-120-48	6268	10	3	225	11
		6806-120-54	6717	10	3	255	14
		6806-144-54	7511	12	3	300	16
		6806-168-54	9028	12	4	345	16
		6806-192-54	9846	12	4	390	18
		6806-216-60	11632	14	5	480	23
		6806-240-60	12921	16	5	550	25
	6806-264-60	14213	16	6	620	28	
	6806-288-60	15216	18	6	690	30	

	Millennium Round Tops	6805-36 dia.	2164	3	1	48	3
		6805-42 dia.	2535	4	1	54	4
		6805-48 dia.	2757	5	1	74	4
		6805-54 dia.	3656	6	1	100	6
		6805-60 dia.	4558	7	1	134	6

All Millennium Conference products are available on the Krug Express Program with a size limitation of up to and including 168" tables only.

ORDERING PROCEDURE

To order, please specify the following:

- 1) Krug product model number
- 2) Wood species and finish
- 3) Wood edge detail - S, V, T, M, B, Z or W see page 168

See page 346 for *KrugExpress* program.

STANDARD FINISHES

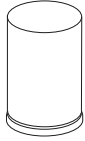
For a complete list of standard finishes please see page 347.

WIRE ACCESS DOORS

Please specify wire access doors on bases when ordering tops in conjunction with wiring grommets.

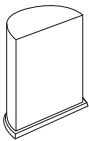
MILLENNIUM | BASES

Description	Model	Cherry Maple Walnut			L	W	H	Shipping Weight	Cubes
Round Wood Drum	6810-18D-29		1220		18 Dia.	–	29	97	7
Millennium Edge Detail	6810-24D-29		1241		24 Dia.	–	29	115	14
	6810-30D-29		1622		30 Dia.	–	29	135	20



Please select a Millennium edge detail for this item.
Please add **WMD** to the end of the model number for wire management.
Wire management cavity for this base is:
6810-18D-29 – 18" diameter by 16" in height
6810-24D-29 – 24" diameter by 16" in height
6810-30D-29 – 30" diameter by 16" in height

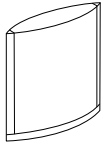
Half Round Wood Drum	6809-18-9-29		981		18 Dia.	9	29	68	4
Millennium Edge Detail	6809-24-12-29		1181		24 Dia.	12	29	89	8
	6809-30-15-29		1289		30 Dia.	15	29	110	12



Please select a Millennium edge detail for this item.
Please add **WMD** to the end of the model number for wire management.
Wire management cavity for this base is:

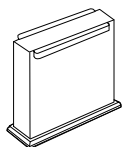
6809-18-9-29 – 1/2 of 18" diameter by 13 1/4" in height
6809-24-12-29 – 1/2 of 24" diameter by 17 1/4" in height
6809-30-15-29 – 1/2 of 30" diameter by 17 1/4" in height

Elliptical Wood Panel	6816-24-6-29		1275		24	6	29	25	4
	6816-30-6-29		1370		30	6	29	35	6



Wire management cavity for this base is:
6816-24-6-29 – 24" elliptical shape width by 25" in height
6816-30-6-29 – 30" elliptical shape width by 25" in height

Wood Panel	6815-28-6-29		1103		28	6	29	30	4
	6815-34-6-29		1183		34	6	29	50	6



Wire management cavity for this base is:
6815-28-6-29 – 28" x 6" rectangular by 25" in height
6815-34-6-29 – 34" x 6" rectangular by 25" in height

DIMENSION KEY

L – length
W – width
H – height

Model numbers represent nominal dimensions only. Contact Customer Service if dimensions are critical.

STANDARD FINISHES

For a complete list of standard finishes please see page 347.

BASE REQUIREMENTS

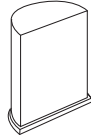
See page 173 for the base requirements chart.

POWER BOXES

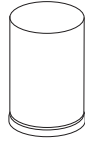
See page 174 for information on conferencing power boxes.

MILLENNIUM | BASE REQUIREMENTS CHART

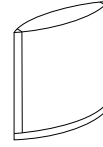
Half Round Drum Base
6809



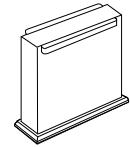
Round Drum Base
6810



Elliptical Wood Panel
6816



Wood Panel
6815




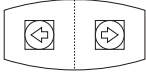

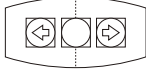
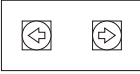
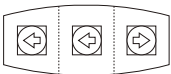
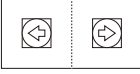
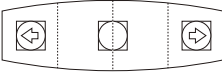

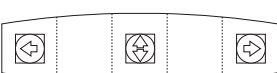

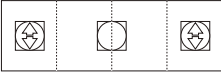
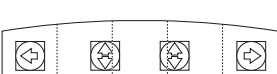
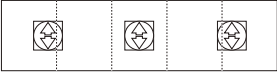
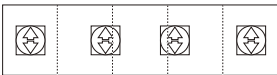
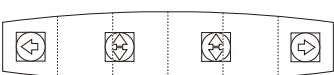
Top Size	Quantity	Size	Quantity	Size	Quantity	Size	Quantity	Size
36 diameter			1	18				
36 - 36			1	18				
42 diameter			1	18				
42 - 42			1	18				
48 - 36			1	18				
48 - 42			1	18				
48 diameter			1	18				
48 - 48			1	18				
54 diameter			1	24				
54 - 54			1	24				
60 - 30	2	18	2	18				
60 - 36	2	18	2	18	2	24	2	28
60 diameter			1	30				
60 - 60				1	30			
72 - 36	2	18	2	18	2	24	2	28
84 - 42	2	18	2	18	2	24	2	28
96 - 42	2	18	2	18	2	24	2	28
96 - 48	2	18	2	18	2	24	2	28
96-48-42	2	18	2	18	2	24	2	28
120 - 48	2**	18	2	18	3	24	3	28
120-48-42			2	18	3	24	3	28
120 - 54	2*	24	2	24	3	30	3	34
144 - 54	2*	24	2	24	3	30	3	34
144-48-42	2**	18	3	18	3	24	3	28
168 - 54	2*	24	3	24	4	30	4	34
168-48-42			3	18	3	24	3	28
192 - 54	2*	24	3	24	4	30	4	34
192-54-48			2	18	2	24	2	28
			1	24	2	30	2	34
216-54-48			2	18	2	24	2	28
			1	24	3	30	3	34
216 - 60			3	30	5	30	5	34
240-54-48			2	18	2	24	2	28
			2	24	3	30	3	34
240 - 60			4	30	5	30	5	34
264 - 60			4	30	6	30	6	34
264-60-48			2	18	2	24	2	28
			2	30	4	30	4	34
288 - 60			4	30	6	30	6	34
288-60-48			2	18	2	24	2	28
			2	30	4	30	4	34

*Add an additional 24" diameter drum base for center-support.
 **Add an additional 18" diameter drum base for center-support.

MILLENNIUM POWER BOX UPCHARGES

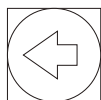
This chart applies to Millennium & Stratford square/rectangular, racetrack, arc ended and round tops:

This chart applies to Millennium & Stratford boat shaped tops: racetrack, arc ended and round tops:

Single / Multi Section Tops	Standard Top Sizes	\$ Upcharge per table	Single / Multi Section Tops	Standard Top Sizes	\$ Upcharge per table
 68PB	36 diameter 36-36 42 diameter 42-42 48-36 48-42 48 diameter 48-48	961		96-48-42 144-48-42	1924
	54 diameter 54-54 60 diameter 60-60	1924		144-48-42	1924
	60-30 60-36 72-36	1924		120-48-42	2883
	84-42 96-42 96-48	1924		168-48-42 192-54-48	1924
	120-48	1924		216 - 54 - 48	4040
	120 - 54 *144 - 54	4040			
	*168 - 54 *192 - 54	4040		240 - 54 - 48	6154
	216 - 60	6154			
	240 - 60 288 - 60	8265		264-60-48 288-60-48	6154

* Stratford Conference tops only, feature single power box configuration.

Note: When specified with power boxes, standard tops sizes must be ordered in configurations shown above. Upcharges shown are list prices.



Indicate 18" round and square drum bases with one power box facing ends of top.



Indicate 24" and 30" round and square bases with twin power box facing sides of top.

Connexus™ is Krug's proprietary tabletop connectivity solution. When opened, it presents power and data outlets on a convenient angle to the user and provides storage for wiring.

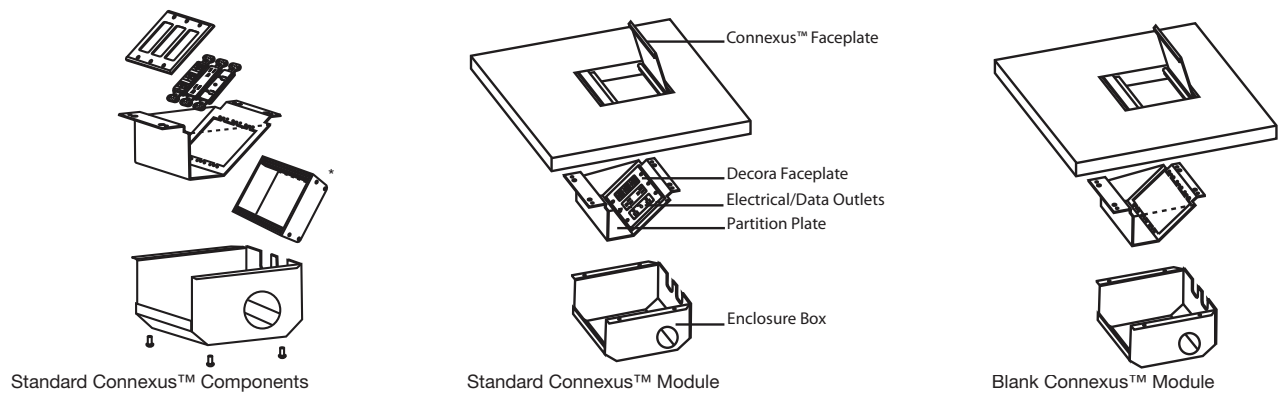
The faceplate of Connexus™ is available in either Glass or Aluminum and sits flush with the tabletop. It is designed to allow wiring to pass through the surface cover in both the open and closed positions. The faceplate opens to a 100° angle from the table top.

Connexus™ utilizes UL standard receptacle outlets. Connexus™ offers 11 pre-configured units with a wide selection of power, data and presentation system outlets, or alternatively can be purchased with just electrical ports with blank data ports. Connexus™ also can be designed and built specifically to meet your connectivity needs by using the snap-in or plate mounted port options.

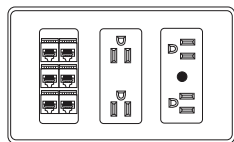
All corded units can be modified to allow the units to be hard wired by an electrician and data ports can be reconfigured easily when desired. To facilitate this process, the Enclosure Box of each Connexus™ module is easily removable.

*All duplex outlets are contained within a metal box that is attached to the Partition Plate. If additional outlets need to be added in the future, these boxes need to be ordered from Krug to expand the enclosure. All modifications must be done by a qualified electrician.

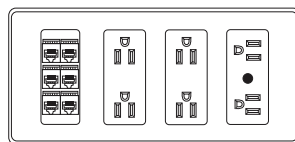
The label drawing shown below illustrates the way a Connexus™ module is shipped to the user. The Partition Plate is mounted on-site to the underside of the top with the Enclosure Box over top to conceal the module. Please note, enclosure boxes are not required when modules are enclosed in a base. Enclosure boxes are not supplied with Connexus™ modules; they must be ordered separately when required.



CONNEXUS™ SIZES



Standard - 3 Gang



Large - 4 Gang

Connexus™ modules may be specified in Standard or Large sizes.

Standard modules are available in 7 standard configurations or custom configurations. Connexus™ modules in Standard configurations are 6 1/8" x 7 3/8". Depth on Standard module is 4.5".

Large modules are available in 4 standard configurations or custom configurations. Connexus™ modules in Large configurations are 8 1/4" x 7 3/8". Depth on Large module is 4.5".

CONNEXUS™

Connexus™ modules are wired independently of each other to maximize the amount of electrical devices serviced. All Connexus™ modules may sustain individual loads of 15 amps or 12 amps of continuous load. Each Connexus™ module will require a single isolated circuit to maximize its service capabilities. An optional utility a/c power outlet is available on the back surface of the outlet box.

Connexus™ components are UL and CSA US approved and manufactured in accordance to the National Electrical Code. Hardwiring Connexus™ modules on-site must be performed by a licensed electrician. Connexus™ units can be ordered with an optional utility outlet, which is located on the bottom side of the Connexus™ unit and underneath the work surface. Other Connexus™ products could employ these utility outlets as a source of power. In this scenario, it is solely the responsibility of the end user to assure that proper circuit protection is in place that never exceeds the 15 Ampere Circuit Breaker Rating.

ELECTRICAL CORD LENGTHS

Connexus™ modules come with pre-determined electrical cord lengths that are suited to the size and configuration of each table (16' & 25'). Each will plug into a standard floor monument power source. However, in situations where a table length exceeds our maximum cord length, a second power entry is necessary to avoid daisy-chaining of electrical power. To determine when a second power entry is required follow these steps:

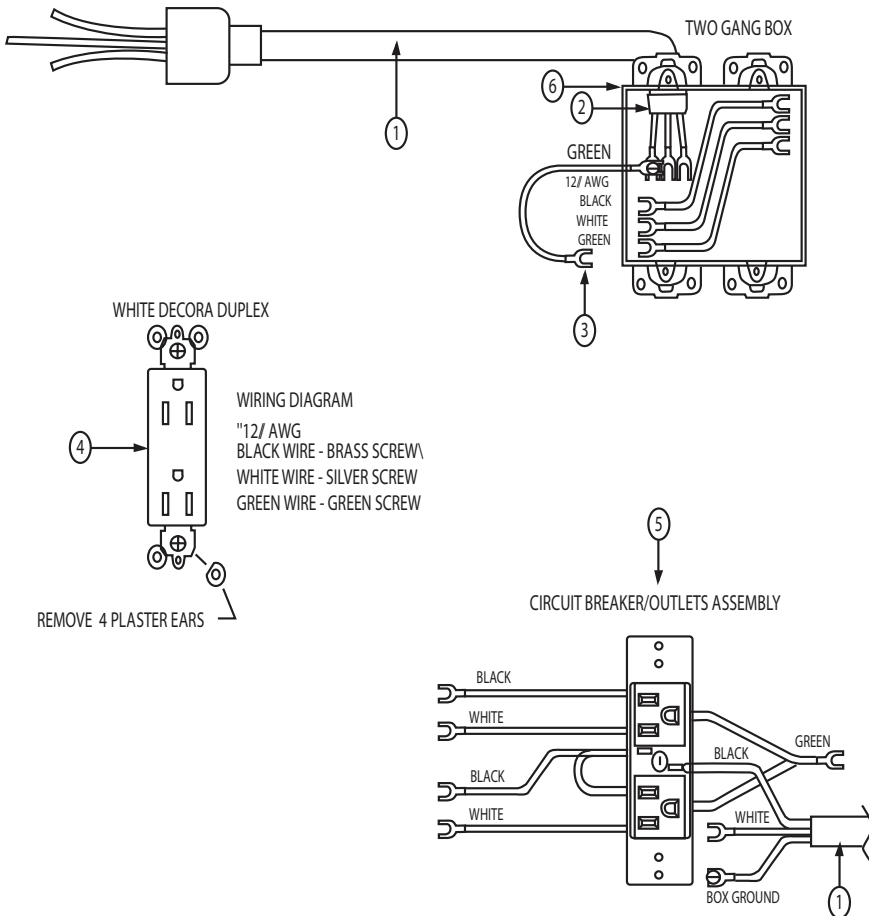
1. Select your Connexus™ locations.
2. Select your Floor Monument Location(s) if they do not already exist in the room.
3. If the number of Connexus™ modules exceed three consecutive positions left or right of the power entry, then an additional power entry will be required.

Note: Connexus™ modules in pairs count as one position.

HARDWIRING ON SITE

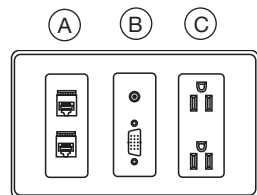
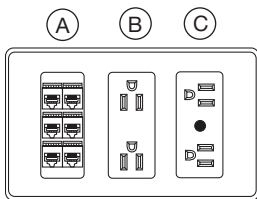
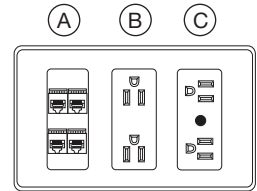
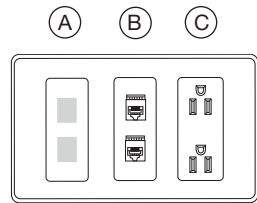
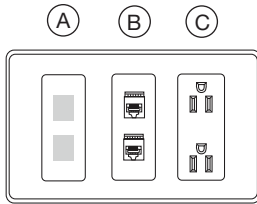
For hardwiring on-site by electricians, please use the following schematic:

- ① Power Supply Cord
- ② Strain Relief
- ③ Fork Terminals
- ④ Duplex Receptacles
- ⑤ Outlets with Circuit Breaker Assembly
- ⑥ Handy Box



CONNEXUS™ | PRECONFIGURED STANDARD MODULES

Standard - 3 GANG



Port Options	Model #	List Price	
		Aluminum	Glass

BASIC DATA 62 CON BD 1064 1178

- (A) (2) Blanks (for future use)
- (B) (2) RJ45 port (Category 6)
- (C) (2) AC power ports

BASIC VOICE DATA 62 CON BV 1032 1143

- (A) (2) Blanks (for future use)
- (B) (1) RJ11 port
(1) RJ45 port (Category 6)
- (C) (2) AC power ports

EXPANDED DATA 62 CON ED 1307 1419

- (A) (4) RJ45 port (Category 6)
- (B) (2) AC power ports
- (C) (2) AC power ports / with 15 amp circuit breaker

EXPANDED VOICE/DATA 62 CON 1338 1451

- (A) (2) RJ11 port
(4) RJ45 port (Category 6)
- (B) (2) AC power ports
- (C) (2) AC power ports / with 15 amp circuit breaker

BASIC MULTIMEDIA 62 CON BM 1209 1319

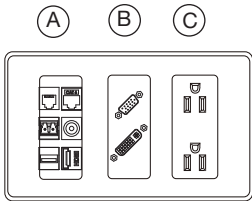
- (A) (1) RJ11 port
(1) RJ45 port (Category 6)
- (B) (1) 3.5 mm Mini
(1) VGA Type 15 pin HD
- (C) (2) AC power ports

ORDERING NOTE: Enclosure box is only required only when the Connexus™ is not positioned over a base. If an enclosure box is required, please clearly state this requirement on your purchase order and add the **\$302** per Connexus™.

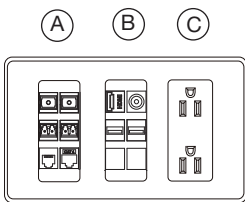
CONNEXUS™ | PRECONFIGURED STANDARD MODULES

Standard - 3 GANG

Port Options	Model #	List Price	
		Aluminum	Glass

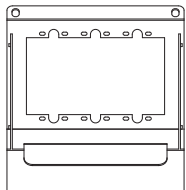


DATA & MULTIMEDIA	62 CON DM	1662	1773
<p>(A)</p> <ul style="list-style-type: none"> (1) RJ11 (1) RJ45 (1) Fiber Optic LC Duplex (1) 3.5mm Stereo Mini (1) USB "A" (1) HDMI <p>(B)</p> <ul style="list-style-type: none"> (1) DVI-I (1) VGA <p>(C)</p> <ul style="list-style-type: none"> (2) AC power ports 			



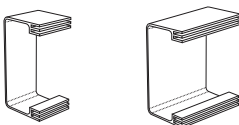
BASIC FIBRE OPTIC & MULTIMEDIA	62 CON BF	1596	1708
<p>(A)</p> <ul style="list-style-type: none"> (2) Fibre Optic SC Simplex (2) Fiber Optic LC Duplex (1) RJ11 (1) RJ45 <p>(B)</p> <ul style="list-style-type: none"> (1) HDMI (1) 3.5mm Stereo Mini (2) USB "A" (2) Blanks <p>(C)</p> <ul style="list-style-type: none"> (2) AC power ports 			

ORDERING NOTE: Enclosure box is only required only when the Connexus™ is not positioned over a base. If an enclosure box is required, please clearly state this requirement on your purchase order and add the **\$302** per Connexus™.

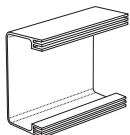


STANDARD BLANK MODULE	62 CON X1	129
------------------------------	-----------	-----

Blank Modules does not include the Connexus™ lid.

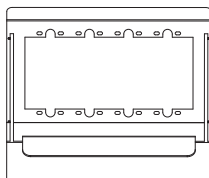
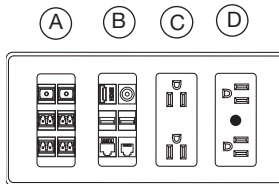
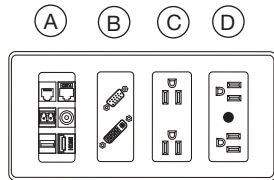
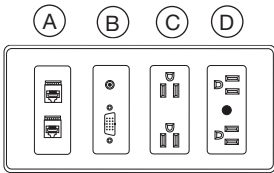
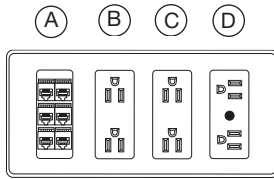


DUPLEX OUTLET ENCLOSURE	62 CON OUTBOX-1	49
To be used when adding duplex outlets to existing Connexus™ Modules.	62 CON OUTBOX-2	66
	62 CON OUTBOX-3	82



CONNEXUS™ | PRECONFIGURED LARGE MODULES

Large - 4 GANG



Port Options	Model #	List Price	
		Aluminum	Glass
NETWORK AND POWER CENTRE (A) (6) RJ-45 ports (B) (2) AC power ports (C) (2) AC power ports (D) (2) AC power ports/with 15 amp circuit breaker	62 CON NP	1629	1727
BASIC MULTIMEDIA WITH 2X POWER (A) (1) RJ11 port (1) RJ45 port (B) (1) 3.5 mm Mini with 2x Power (1) VGA type 15 pin HD (C) (2) AC power ports (D) (2) AC power ports/with 15 amp circuit breaker	62 CON B2	1491	1587
DATA & MULTIMEDIA WITH 2X POWER (A) (1) RJ11 port (1) RJ45 port (1) 1 Fiber Optic LC Duplex (1) 1 3.5mm Stereo Mini (1) 1 USB "A" (1) 1 HDMI (B) (1) DVI-I (1) VGA (C) (2) AC power ports (D) (2) AC power ports/with 15 amp circuit breaker	62 CON DM2	1951	2046
EXPANDED FIBRE OPTIC AND MULTIMEDIA (A) (2) Fibre Optic SC Simplex (4) Fiber Optic LC Duplex (B) (1) HDMI, (1) Stereo 3.5 Mini (2) USB "A", (1) RJ45 (1) RJ11 (C) (2) AC power port (D) (2) AC power ports/with 15 amp circuit breaker	62 CON EF	2031	2129
LARGE BLANK MODULE Blank Modules does not include the Connexus™ lid. ORDERING NOTE: Enclosure box is only required when the Connexus™ is not positioned over a base. If an enclosure box is required, please clearly state this requirement on your purchase order and add the \$302 per Connexus™.	62 CON X2		148

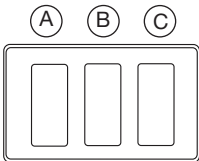
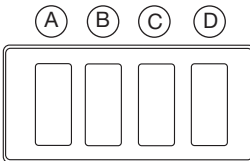
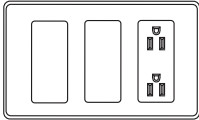
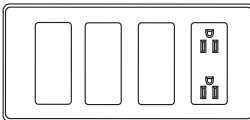
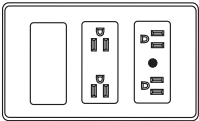
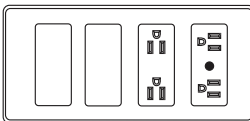
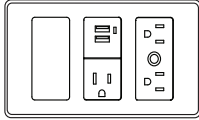
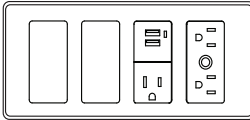
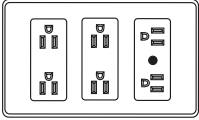
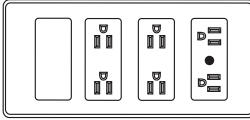
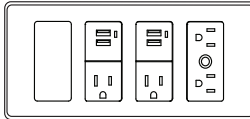
CONNEXUS™ | CUSTOM CONNEXUS™

Planning a custom Connexus™ unit is easy when following these 6 simple steps.

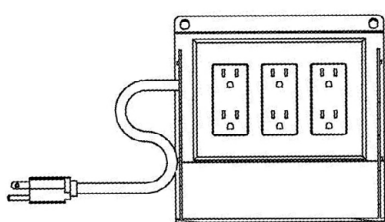
STEP ONE: Select the quantity of AC power ports or AC power ports with USB Charging (select configurations only) that are required.

Power modules must always be positioned starting from the right side of the unit. For example, 3 gang Connexus™ can have a power module located in position C with data ports in position A and B, or power can be located in position B and C with data port in position A, or position A,B and C can have all power ports or all data ports. Please note, 4 gang Connexus™ are not available with power ports located in position A.

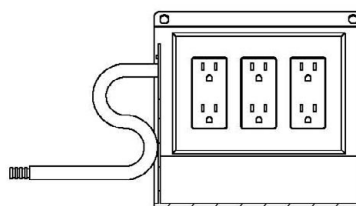
On select configurations shown below, USB charging outlets are available. These charging outlets allow a user to charge most personal electronic devices without the need for any special power adapter or a computer - simply plug in your device with any compatible USB cable. This component has 2 USB charging slots that supply 5V DC at 700mA. Comes with a charging indicator light, as well as a standard 120 volt simplex receptacle on the bottom portion of the component.

Standard Connexus™	List Price	Large Connexus™	List Price
 <p>3 Gang: Data ports only E300 - Standard Data Ports</p>	82	 <p>4 Gang: Data Ports only E400 - Large Data Ports</p>	170
 <p>3 Gang: AC Power Port E31S - Standard Outlet E31U - Standard & Utility Outlets</p>	565 605	 <p>4 Gang: AC Power Port E41S - Large Outlet E41U - Large & Utility Outlets</p>	637 677
 <p>3 Gang: AC Power Port / AC Power Port with 15 amp circuit breaker E32S - Standard Outlet E32U - Standard & Utility Outlet</p>	740 782	 <p>4 Gang: AC Power Port / AC Power Port with 15 amp circuit breaker E42S - Large Outlet E42U - Large & Utility Outlets</p>	832 871
 <p>3 Gang: AC Power Port Simplex with USB Charging/AC Power Port with 15 amp circuit breaker E32SC - Standard Outlet E32UC - Standard & Utility Outlet</p>	984 1026	 <p>4 Gang: AC Power Port Simplex with USB Charging/AC Power Port with 15 amp circuit breaker E42SC - Standard Outlet E42UC - Standard & Utility Outlet</p>	1071 1114
 <p>3 Gang: (2) AC Power Port / AC Power Port with 15 amp circuit breaker E33S - Standard Outlet E33U - Standard & Utility Outlet</p>	904 942	 <p>4 Gang: (2) AC Power Port / AC Power Port with 15 amp circuit breaker E43S - Large Outlet E43U - Large & Utility Outlets</p>	887 928
		 <p>4 Gang: (2) AC Power Port Simplex with USB Charging/AC Power Port with 15 amp circuit breaker E43SC - Standard Outlet E43UC - Standard & Utility Outlet</p>	1127 1168

STEP TWO : There are two cord end options available; Plug In and Conduit. The standard Plug In option will connect with any standard floor monument power source. The Conduit option is Liguatite® (a steel inner conduit with a PVC overlay) by Anamet, meant for specific hard wiring applications. Units can come in cord lengths of 16' or 25'. Not Applicable if no power is selected.

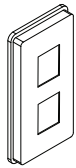


EP
Electrical Plug In
No Upcharge

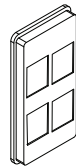


EC
Electrical Conduit
Add upcharge
16' 137
25' 218

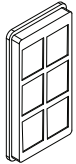
STEP THREE: There are two data options available; Plate mounted ports or Snap-in ports. Snap-in ports are available in configurations of two, four or six. Choose the faceplate below that meets your data requirements. If an odd number of Snap-in ports are required, a blank port needs to be selected when the opening is not in use.



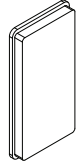
M02
Mounting Plate (2)
accepts two snap in data ports
Add \$37 list



M04
Mounting Plate (4)
accepts four snap in data ports
Add \$37 list



M06
Mounting Plate (6)
accepts six snap in data ports
Add \$37 list



M00
Mounting Plates
Add \$37 list

STEP FOUR: Choose the Plate mounted port or Snap-in ports options for non-powered positions. As an aid, use the chart below to help design and build your Connexus™ to meet the rooms needs. Use the check boxes and list the components on the lines below.

Standard Connexus™

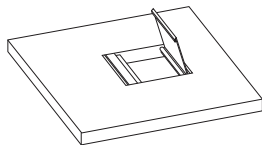
(A)	(B)	(C)
<input type="checkbox"/> POWER	<input type="checkbox"/> POWER/POWER & USB CHARGING	<input type="checkbox"/> POWER
OR	OR	OR
<input type="checkbox"/> PLATE MOUNTED PORT	<input type="checkbox"/> PLATE MOUNTED PORT	<input type="checkbox"/> PLATE MOUNTED PORT
OR	OR	OR
<input type="checkbox"/> SNAP-IN PORTS	<input type="checkbox"/> SNAP-IN PORTS	<input type="checkbox"/> SNAP-IN PORTS
_____	_____	_____
_____	_____	_____
_____	_____	_____

Large Connexus™

(A)	(B)	(C)	(D)
<input type="checkbox"/> POWER	<input type="checkbox"/> POWER/POWER & USB CHARGING	<input type="checkbox"/> POWER/POWER & USB CHARGING	<input type="checkbox"/> POWER
OR	OR	OR	OR
<input type="checkbox"/> PLATE MOUNTED PORT	<input type="checkbox"/> PLATE MOUNTED PORT	<input type="checkbox"/> PLATE MOUNTED PORT	<input type="checkbox"/> PLATE MOUNTED PORT
OR	OR	OR	OR
<input type="checkbox"/> SNAP-IN PORTS	<input type="checkbox"/> SNAP-IN PORTS	<input type="checkbox"/> SNAP-IN PORTS	<input type="checkbox"/> SNAP-IN PORTS
_____	_____	_____	_____
_____	_____	_____	_____
_____	_____	_____	_____

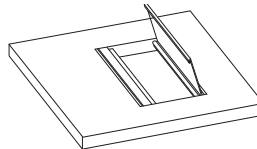
STEP FIVE: Select the Connexus™ Cover (Aluminum or Glass)

Standard Connexus™



3 GANG
3CCA Aluminum \$379 list
3CFG Glass \$468 list
3C00 No Lid

Large Connexus™



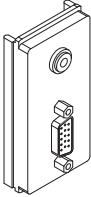
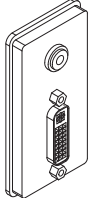
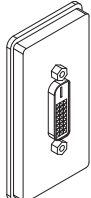
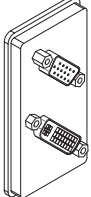
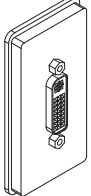
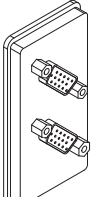
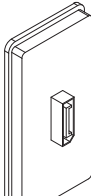
4 GANG
4CCA Aluminum \$391 list
4CFG Glass \$483 list
4C00 No Lid

STEP SIX: Enclosure box is only required only when the Connexus™ is not positioned over a base. If an enclosure box is required, please clearly state this requirement on your order and add the **\$302** per Connexus™.

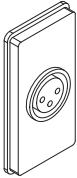
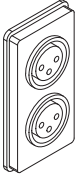
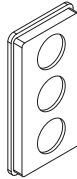
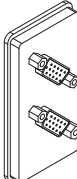
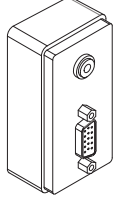
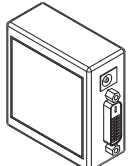
STEP SEVEN: Calculate the total list price for the custom Connexus™ by adding the following prices:

- Connexus™ Box with required AC Power Ports
- Faceplate (Snap-in Ports Only)
- Snap-In Ports or Plate Mounted Data Ports
- Enclosure Box (if required)
- Connexus™ Lid (Aluminum or Glass)

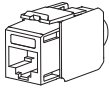


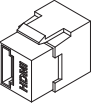




CONNEXUS™ | PORT OPTIONS

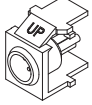
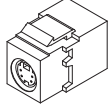
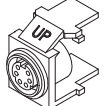
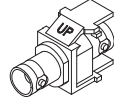

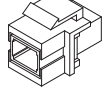
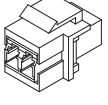
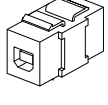
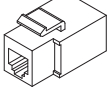
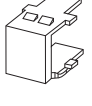
PLATE MOUNTED PORTS	Reference Code	Description	List Price
	P01	VGA & 3.5 STEREO MINI - Use for VGA (DB15) connections and for 3.5mm stereo connections. Connector is a female input with screw terminal output (back side of Console interface).	143
	P02	DVI-I DUAL (DIGITAL/ANALOG) & 3.5 STEREO MINI - Use for DVI Integrated - Digital and Analog connections and for 3.5mm stereo connection. The DVI connector is a Dual Link. DVI-I connector is a female-to-female pass through and the 3.5 Mini is a female input with screw terminal output (back side of Console interface).	212
	P03	DVI-D DUAL (DIGITAL) - Use for DVI-D Digital only connection. The connector is a Dual Link. Connector is a female-to-female pass through.	137
	P04	DVI-I DUAL (DIGITAL/ANALOG) & VGA - Use for DVI Integrated - Digital and Analog and for VGA (DB15) connections. The DVI connector is a Dual Link. Both connectors are female-to-female pass through.	271
	P05	DVI-I DUAL (DIGITAL/ANALOG) - Use for DVI Integrated - Digital and Analog connections. DVI connector is a Dual Link. Connector is a female-to-female pass through.	173
	P06	VGA-2 - Use for two VGA (DB15) connections. Both connectors are female-to-female pass through.	168
	P07	DISPLAYPORT - Use for DisplayPort connection. This connector is primarily used to connect a video source to a display device and also carries audio signals. Connector is a female input to a 3' corded output (back side of Console interface) with a male Display Port termination.	168

CONNEXUS™ | PORT OPTIONS

PLATE MOUNTED PORTS	Reference Code	Description	List Price
	P08	MICROPHONE XLR STANDARD - Use for standard size XLR microphone connection. Connector is a female input with a 3 pin screw terminal output (back side of Console interface).	228
	P09	MICROPHONE STANDARD XLR -2 - Use for two standard size XLR microphone connections. Each connector is a female input with a 3 pin screw terminal output (back side of Console interface).	333
	P10	3 HOLE CABLE PASS THROUGH - Use for running loose cables from the under side of the table up into the Console interface cavity. Often used with running wires for PolyCom™ devices.	54
	P11	VGA-to-BNCx2 - Use for two VGA (DB15) connections that are input female pass through and are terminated on the output (back side of Console interface) with 5 BNC female pigtail connections, for each VGA connector.	542
	P12	INPUT VGA & 3.5 Stereo (POWERED) - VGA + Audio Line Driver designed for VGA (DB15) connections and for 3.5mm stereo connections. This unit provides a method of transmitting signals to a remote display and audio receiver or amplifier. VGA connector is a female input and comes with cabling for either VGA output, or 5 BNC output and the 3.5 Mini is a female input with screw terminal output (back side of Console interface). A 9 volt DC 500mA power supply is required to power this unit.	1327
PORT ACCESSORIES	Reference Code	Description	List Price
	DVIR	DVI-REPEATER - Is a cable equalizer that automatically compensates for long DVI cable runs. This unit extends the usable cable distance up to 130ft depending on the quality of the cable and the resolution of the video signal. Additionally, it is capable of extending dual link signals allowing for much greater resolutions and refresh rates. This unit comes with a power supply and is generally mounted underneath a table.	1046

CONNEXUS™ | PORT OPTIONS

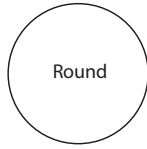
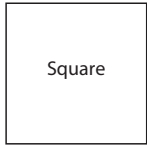
SNAP IN PORTS	Reference Code	Description	List Price
	S01W S01B S01R	RJ-45 - Category 6 data connection. This connector is also downwards compatible with Category 5 cabling. Connector is a female input with a #110 punch-down terminal block output (back side of Console interface) for on-site hard wire connection. RJ45-CAT6 (White) RJ45-CAT6 (Blue) RJ45-CAT6 (Red)	47
	S02W S02B S02G S02R S02Y	RJ11 - Telephone type connection. Connector is a female input with a #110 punch-down terminal block output (back side of Console interface) for on-site hard wire connection. RJ11 (White) RJ11-B (Black) RJ11-G (Green) RJ11-R (Red) RJ11-Y (Yellow)	32
	S03	3.5 STEREO MINI - 3.5mm stereo connection. Connector is a female input with screw terminal output (back side of Console interface).	92
	S04	HDMI - High Definition Multimedia Interface connection. Connector carries both HD audio and video data. Connector is a female-to-female pass through.	173
	S05	RCA-LEFT - RCA left audio channel connection. Color coded with black. Connector is a female-to-female pass through.	38
	S06	RCA-RIGHT -RCA right audio channel connection. Color coded with red. Connector is a female-to-female pass through.	38
	S07	RCA- VIDEO - RCA video channel connection. Color coded with yellow. Connector is a female-to-female pass through.	38
	S08	USB-A - Full size USB "A" style connection. Connector is a female-to-female pass through.	61

SNAP IN PORTS	Reference Code	Description	List Price
	S09	3 PIN MINI XLR - 3 Pin Mini XLR microphone connection. Connector is a female input to a 6' corded output (back side of Console interface) with a 3 Pin Mini XLR male termination.	739
	S10	S-VIDEO - S-Video connection. Connector is a female-to-female pass through.	68
	S11	PS/2 (6 PIN MINI DIN) - PS/2 (mouse, keyboard, other input devices) connections. Connector is a female-to-female pass through.	85
	S12	BNC - BNC style data connection for use with co-axial cable. Connector is a female-to-female pass through.	47
	S13	F-TYPE - F-Type (DSL, Cable) connections, generally for high speed Internet or video applications. Connector is a female-to-female threaded pass through.	38
	S14	FIBER OPTIC SC - Fibre Optic SC Simplex connection. Connector is a female-to-female pass through. Please note that two of these connectors are required to complete the data transmissions to and from the source and destination units.	47
	S15	FIBER OPTIC LC - Fibre Optic LC Duplex connection. Connector is a female-to-female pass through. One connector only is required to complete the data transmissions to and from source and destination units.	92
	S16	USB-B - USB "B" type connection. Connector is a female "B" input to a female "A" output (back side of Console interface). This connector is reversible.	137
	S17	RJ12 (White) - RJ12 style PolyCom™ connection. Connector is a female input with a 6' corded output (back side) of Console interface) with a male RJ12 termination.	295
	S00	BLANK COVER - Blank covers are required when port is not in use.	16

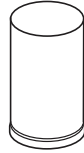
NOTE: Up to 6 snap-in data ports can be ordered for open data positions. Snap-in adaptors can accept 2, 4 or 6 snap-in data ports. Please order a blank port when an odd number of snap-in ports are specified.

MILLENNIUM | CONNEXUS™ LOCATIONS CHARTS

TOP STYLES



BASE STYLES

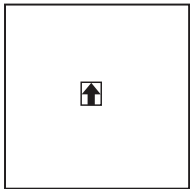


Round Drum Base

The Connexus™ Locations diagrams below show the available Connexus™ locations for only the top and base configurations shown above. Please note that the maximum allowable Connexus™ modules per top are shown, and tops may be specified with fewer modules. Each Connexus™ module has a code to represent its location on the table surface. To specify a Connexus™ module in a particular location, please use the code listed above it.

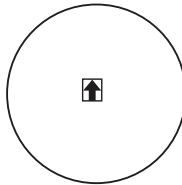
Note: One Connexus™ module is available where two modules are shown. Please refer to location code above the drawing for single center location in which case the Connexus™ unit will face West if on the left end of the top, and East if on the right end of the top. For large Connexus™ units please replace “3” in location code with “4”.

ACN3



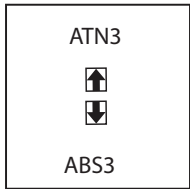
Represents 42” and 48” top locations

ACN3



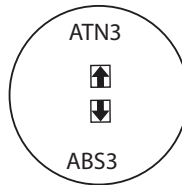
Represents 42”, 48” and 54” top locations

ACN3



Represents 60” top locations

ACN3



Represents 60” top locations

18” Drum bases will accommodate single standard Connexus™ units only.
 24” Drum bases will accommodate single standard or large Connexus™ units only.
 30” Drum bases will accommodate single or double standard or large Connexus™ units.



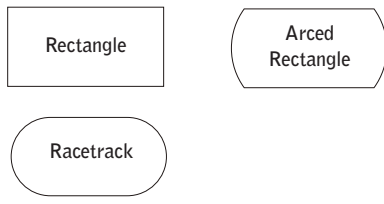
REPRESENTS MODULES THAT WHEN OPENED FACE THE ENDS OF THE TABLE



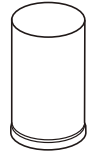
REPRESENTS MODULES THAT WHEN OPENED FACE THE SIDES OF THE TABLE

MILLENNIUM | CONNEXUS™ LOCATIONS CHARTS

TOP STYLES



BASE STYLES

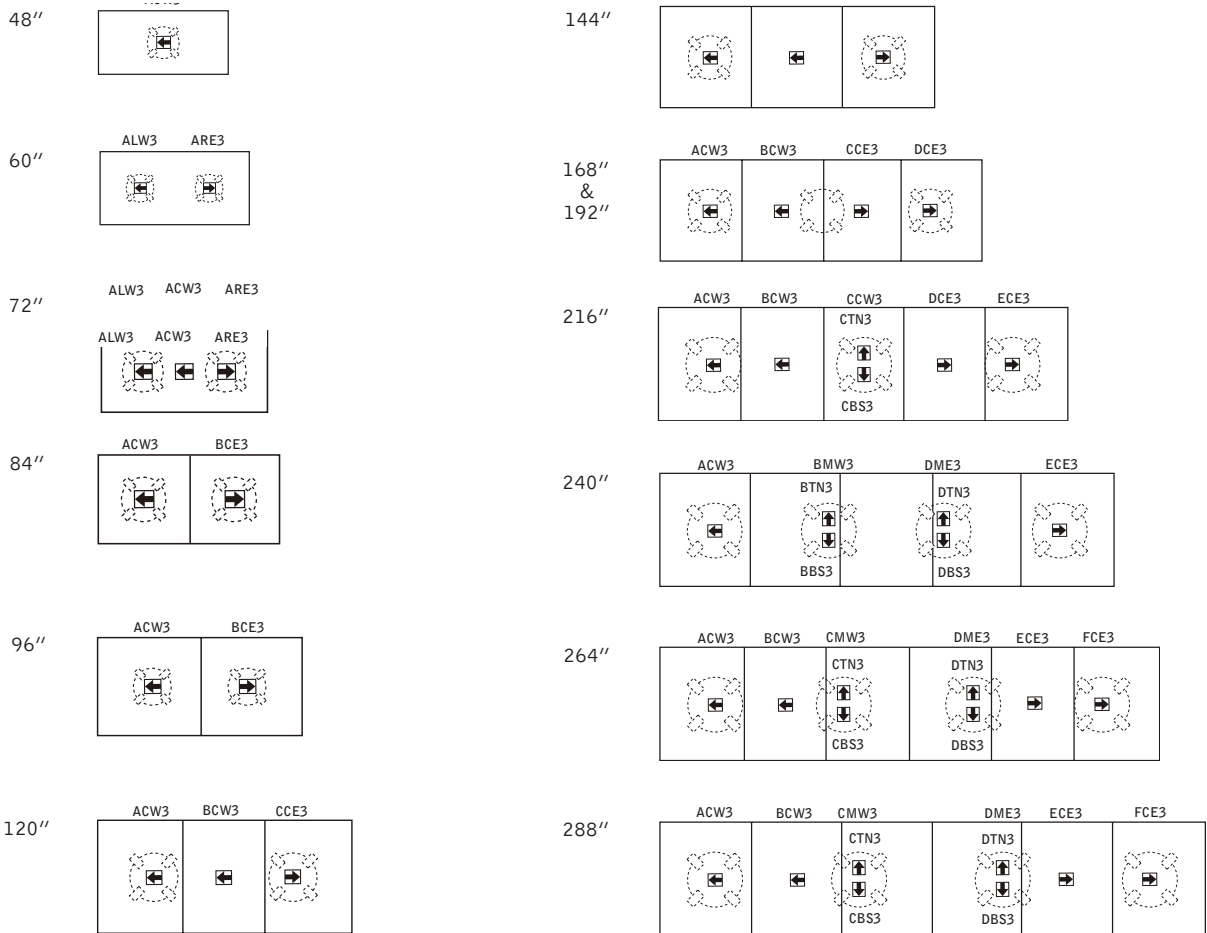


Round Drum Base

The Connexus™ Locations diagrams below show the available Connexus™ locations for only the top and base configurations shown above. Please note that the maximum allowable Connexus™ modules per top are shown, and tops may be specified with fewer modules. Each Connexus™ module has a code to represent its location on the table surface. To specify a Connexus™ module in a particular location, please use the code listed above it.

Note: One Connexus™ module is available where two modules are shown. Please refer to location code above the drawing for single center location in which case the Connexus™ unit will face West if on the left end of the top, and East if on the right end of the top.

For large Connexus™ units please replace “3” in location code with “4”.



18" Drum bases will accommodate single standard Connexus™ units only.

18" Drum bases will accommodate single standard Connexus™ units only.

24" Drum bases will accommodate single standard or large Connexus™ units only.

30" Drum bases will accommodate single or double standard or large Connexus™ units.

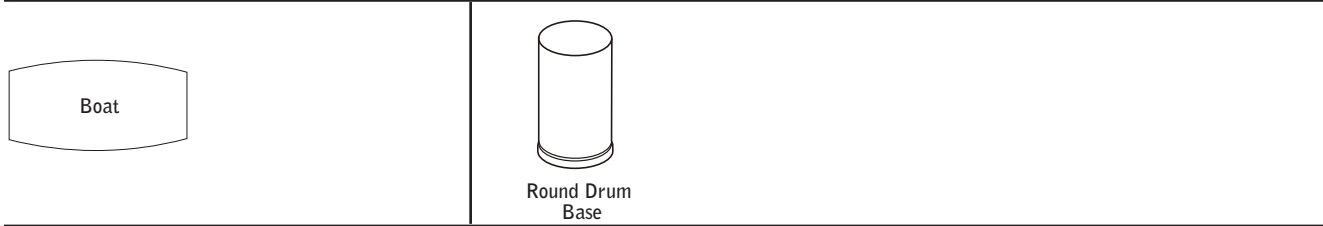
REPRESENTS MODULES THAT WHEN OPENED FACE THE ENDS OF THE TABLE

REPRESENTS MODULES THAT WHEN OPENED FACE THE SIDES OF THE TABLE

MILLENNIUM | CONNEXUS™ LOCATIONS CHARTS

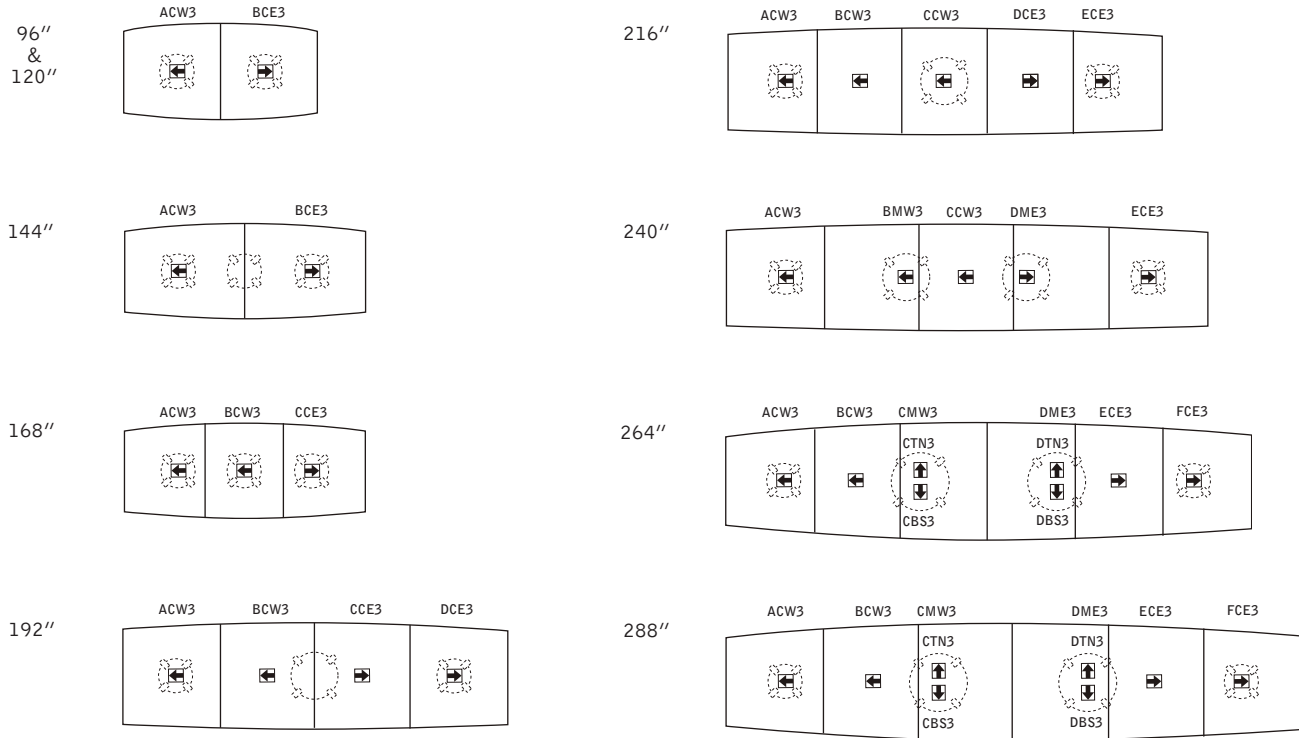
TOP STYLES

BASE STYLES





The Connexus™ Locations diagrams below show the available Connexus™ locations for only the top and base configurations shown above. Please note that the maximum allowable Connexus™ modules per top are shown, and tops may be specified with fewer modules. Each Connexus™ module has a code to represent its location on the table surface. To specify a Connexus™ module in a particular location, please use the code listed above it.

Note: One Connexus™ module is available where two modules are shown. Please refer to location code above the drawing for single center location in which case the Connexus™ unit will face West if on the left end of the top, and East if on the right end of the top. For large Connexus™ units please replace “3” in location code with “4”.



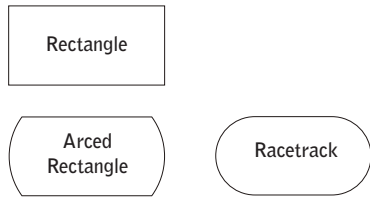
18" Drum bases will accommodate single standard Connexus™ units only.
 24" Drum bases will accommodate single standard or large Connexus™ units only.
 30" Drum bases will accommodate single or double standard or large Connexus™ units.

 REPRESENTS MODULES THAT WHEN OPENED FACE THE ENDS OF THE TABLE

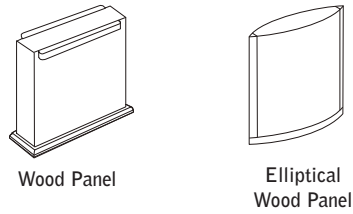
 REPRESENTS MODULES THAT WHEN OPENED FACE THE SIDES OF THE TABLE

MILLENNIUM | CONNEXUS™ LOCATIONS CHARTS

TOP STYLES

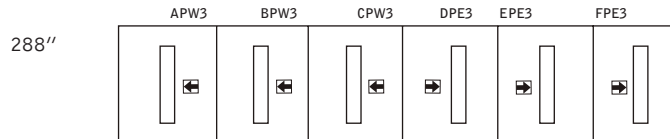
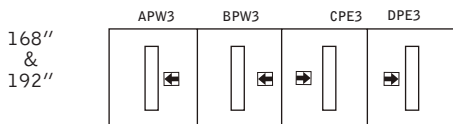
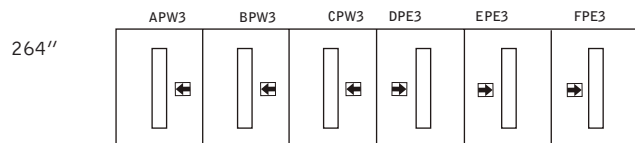
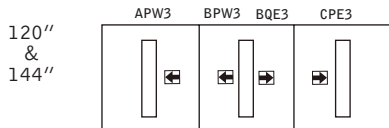
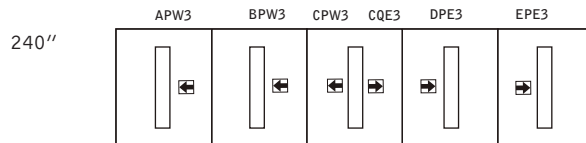
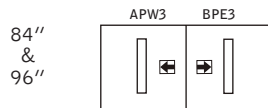
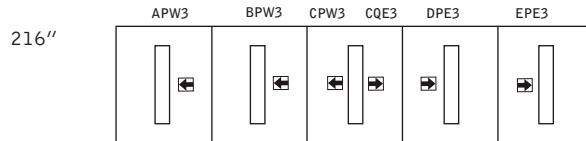
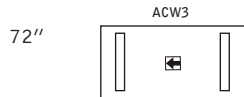


BASE STYLES



The Connexus™ Locations diagrams below show the available Connexus™ locations for only the top and base configurations shown above. Please note that the maximum allowable Connexus™ modules per top are shown, and tops may be specified with fewer modules. Each Connexus™ module has a code to represent its location on the table surface. To specify a Connexus™ module in a particular location, please use the code listed above it.

Note: One Connexus™ module is available where two modules are shown. Please refer to location code above the drawing for single center location in which case the Connexus™ unit will face West if on the left end of the top, and East if on the right end of the top. For large Connexus™ units please replace “3” in location code with “4”.



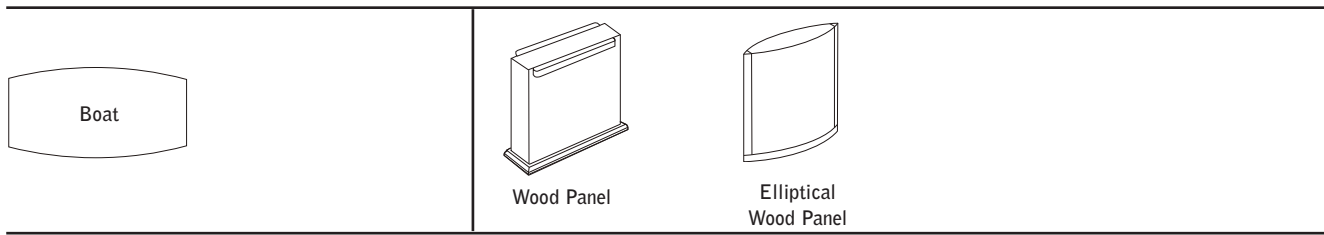
REPRESENTS MODULES THAT WHEN OPENED FACE THE ENDS OF THE TABLE

REPRESENTS MODULES THAT WHEN OPENED FACE THE SIDES OF THE TABLE

MILLENNIUM | CONNEXUS™ LOCATIONS CHARTS

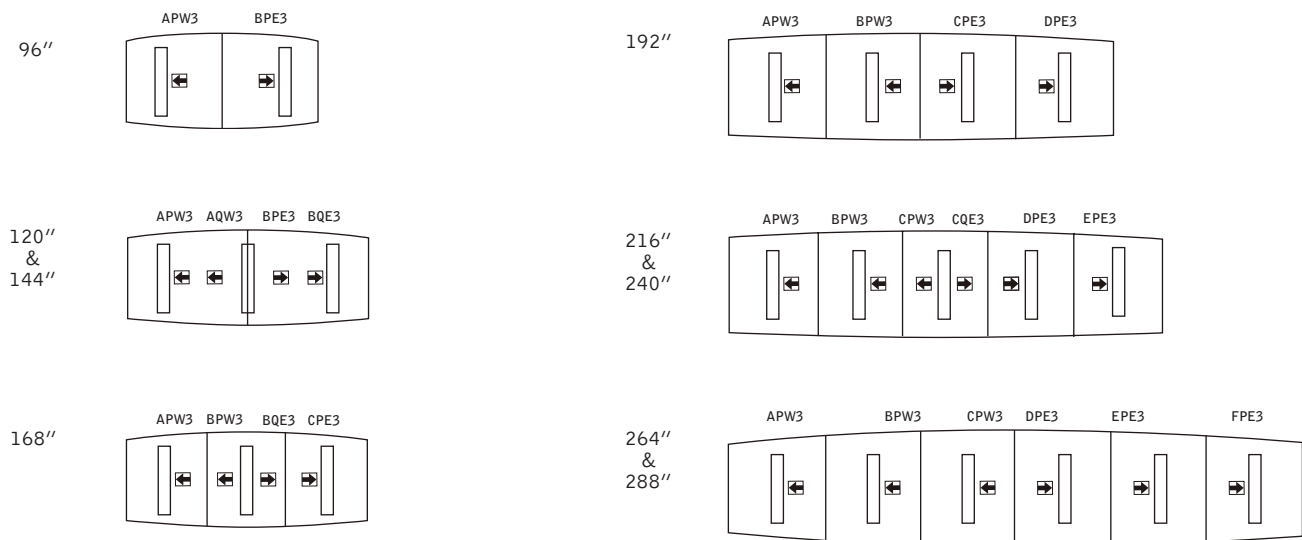
TOP STYLES


BASE STYLES




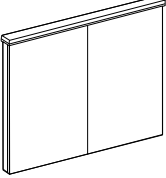
The Connexus™ Locations diagrams below show the available Connexus™ locations for only the top and base configurations shown above. Please note that the maximum allowable Connexus™ modules per top are shown, and tops may be specified with fewer modules. Each Connexus™ module has a code to represent its location on the table surface. To specify a Connexus™ module in a particular location, please use the code listed above it.

Note: One Connexus™ module is available where two modules are shown. Please refer to location code above the drawing for single center location in which case the Connexus™ unit will face West if on the left end of the top, and East if on the right end of the top. For large Connexus™ units please replace “3” in location code with “4”.

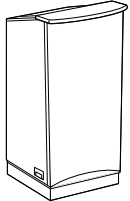


 REPRESENTS MODULES THAT WHEN OPENED FACE THE ENDS OF THE TABLE

 REPRESENTS MODULES THAT WHEN OPENED FACE THE SIDES OF THE TABLE


Description	Model	Cherry Maple Walnut	L	w	H	Shipping Weight	Cubes
	68VB-3632	3418	36.25	5.25	32	89	4
	68VB-4832	3723	48	5.25	32	105	6
	68VB-4848	3917	48	5.25	48	143	9

Includes an upholstered tackboard or optional cork surface. Please specify a tackboard fabric when ordering. Visual boards also include a flip chart and four dry erase markers. An optional pull down screen is also available at **\$265 list**.


	Full Height Lectern	68LN-272348	4882	27.25	23	48.5	194	21
---	---------------------	-------------	------	-------	----	------	-----	----

Includes one open shelf and one closed shelf, an electrical plug-in and four casters. An adjustable reading light is also available at an upcharge of **\$249 list**. Please select hardware pull and finish.


	Table Top Lectern	68LN-272320	1817	27.2	22.8	19.6	30	7
---	-------------------	-------------	------	------	------	------	----	---

	Buffet	68BU-712036	6225	71	20.25	36	380	55
---	--------	-------------	------	----	-------	----	-----	----

Includes one cutlery tray in drawer and an adjustable shelf in each of the three storage compartments. Please select hardware pull and finish.

	Audio Visual Mobile Cabinet	68TV-362461	6540	36	24.25	61	210	44
---	-----------------------------	-------------	------	----	-------	----	-----	----

Cabinet has pocket doors on top and hinged doors on bottom. Includes a pull-out swivel T.V. shelf, a VCR shelf, grommets for wire management and air vents in back panel.

	Mobile Cart	68PS-362436	3871	36.25	24.25	36	145	20
---	-------------	-------------	------	-------	-------	----	-----	----

Interior shelf is adjustable. Cart comes with a 2" grommet in back center located 8 1/2" below the top.

ORDERING PROCEDURE

To order, please specify the following:

- 1) Krug product model number
- 2) Wood species and finish
- 3) Wood edge detail - S, V, T, M, B, Z or W
see page 168
- 4) Pull style and finish, see page 168

STANDARD FINISHES

For a complete list of standard finishes please see page 347.

BASE REQUIREMENTS

See page 173 for the base requirements chart.

STRATFORD | TABLE OF CONTENTS

STRATFORD | CONFERENCE TABLES

- 197 Environmental Summary
- 198 Features & Options
- 199 Tops
- 200 Bases
- 201 Base Requirements Chart
- 202 Power Box

CONNEXUS™ TABLETOP CONNECTIVITY SOLUTION

- 203 Connexus™
- 205 Preconfigured Standard Modules
- 207 Preconfigured Large Modules
- 208 Custom Connexus™
- 210 Port Options
- 214 Connexus™ Location Charts

STRATFORD | MEDIA

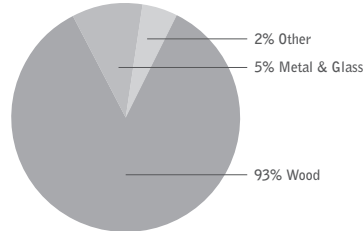
- 219 Media

STRATFORD | ENVIRONMENTAL SUMMARY

LEED CERTIFICATION



MATERIAL CONTENT:



PRE-CONSUMER RECYCLED CONTENT - 74%
POST-CONSUMER RECYCLED CONTENT - 2.5%

		CONTRIBUTES To
Credit 2.1 - 2.2	Construction Waste Management	1-2 point(s)
Credit 3.3	Resource Reuse	1 point
Credit 4.1	Recycled Content	1 point
Credit 4.2	Recycled Content	1 point
Credit 4.5	Low Emitting Materials, (MUST BE REQUESTED) Composite Wood & Laminate Adhesives	1 point
Credit 5.1	Regional Materials*	1 point
Credit 6	Rapidly Renewable Materials (MUST BE REQUESTED)	1 point
Credit 7	Certified Wood (MUST BE REQUESTED)	1 point

*This credit is only applicable if in total 20% of the combined value of the procurement of construction materials and in the furniture are manufactured within a radius of 500 miles. This credit will apply if the installation of the finished product occurs within 500 miles of Kitchener, Ontario.



level® CERTIFICATION

BIFMA's e3 Furniture Sustainability Standard is a voluntary, multi-attribute standard that measures the degree of sustainability of furniture. This standard evaluates product and company environmental attributes and compliance systems in a wide range of elements which include Materials, Energy & Atmosphere, Human & Ecosystem Health and Social Responsibility. Stratford products have earned level®, BIFMA's sustainability certification program for furniture, certification through third-party verification against the e3 standard. All Stratford products can be supplied with level® certification. In order to accomplish this, the product must also be ordered with the air-emissions-certification option. Contact customer service for information and upcharges.



the mark of responsible forest

AIR-EMISSIONS

All Stratford products can be supplied with air-emissions-certified materials. Contact customer service for information and upcharges.

FSC®

FSC® In 2005, Krug received Forest Stewardship Council® (FSC®) Chain-of-Custody certification for our manufacturing facilities. The FSC® Chain-of-Custody tracks certified wood from seedling to final sale. It verifies that the material for our FSC® certified products only come from well-managed, FSC®-certified forests and other controlled sources. FSC® is dedicated to the promotion of responsible forest management worldwide helping to take care of forests for future generations. Stratford and other Krug products can be specified with FSC® Certification. Contact customer service for further information, pricing and lead times..



In addition, architects, designers, and building professionals can specify FSC®-certified products in order to achieve a point from the U.S. Green Building Council's Leadership in Energy and Environmental Design (LEED) Rating System.

STRATFORD | FEATURES & OPTIONS

PROFILES

Stratford conference product is available in all standard Cherry and Walnut, profile is shown below:



top profile



base profile

BASES

All bases are shipped separately and require assembly to selected top.

Refer to the base requirement chart on page 197 to select the appropriate bases and sizes for conference tops.

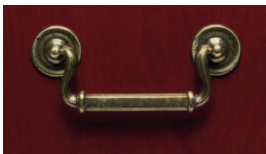
FINISH

A five step catalyzed varnish finish that when dry has a sheen value of 52°, is applied to all finished cases.

DRAWER PULLS

Stratford traditional series offers a choice of three pull combinations as described below.

Please indicate a pull designation for every Stratford product on your order. There is no default selection and orders will not be processed until a pull selection is received.



DEVON

Drawers are furnished with an arced Devon bail finished in antiqued brass and mounted with rosettes. Bookcase doors and hutch doors are provided with an antiqued brushed brass knob.



CANTERBURY

Drawers are furnished with a Canterbury bail finished in antiqued brass and mounted with rosettes. Bookcase doors are provided with an antiqued brushed brass knob.



AVON

All drawers, bookcase doors are provided with an antiqued brushed brass knob.

SEATING CAPABILITIES

To establish seating capabilities, an outside chair dimension of 24" has been used for this price list, plus an allowance of 5" between chairs, for a total of 29". This is an approximation only. When using another chair, particularly seating with a 5 prong caster base, be sure to adjust the approximate seating capacity accordingly. Since not all manufacturers use this same formula, when a seating capacity is in question, please contact Krug Customer Service to review the specific seating that is being used with Krug Conference product.

DATA AND POWER OPTIONS

Data and power options can be specified on all Stratford conference product.

The power pod on page 215 has surface mounted electrical access and data or communication ports for ease of use of powered items on the conference table top. Standard location for this item is over a base to allow cable management to the floor.

Please specify location on the purchase order or provide a drawing at time of order.

The power box on page 215 features two power outlets, one RJ-11 phone line coupler and one RJ-45 data coupler. Power boxes are finished in a black sand-tex powder coat, and when closed is lowered to a flush table top position.


LAMINATE WORKSURFACES

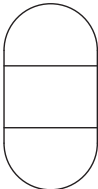
Laminate worksurfaces are available at an upcharge of 10% (a higher upcharge may apply to specially priced plastic laminates). Where there are wood profile edges on worksurface tops, they will remain as wood profiles on laminate tops. Krug will order and procure laminates. Purchase orders with a plastic laminate option must include Laminate Name.

Krug reserves the right to decline a laminate that may not be suitable for the application. Krug assumes no responsibility for the durability, consistent coloration or any other performance characteristic of a customer specified laminate. Laminates may extend the normal lead-time, check with Customer Service for current scheduling information. Please see page 347 for laminate information.


CUSTOM CONFERENCE TABLES

Krug has extensive capabilities for customization of conference tables, including special sizes, finishes, veneers, and special features such as ganging or mobility options. Please contact Customer Service with specific requirements and a drawing for more information.

Description	Model	Cherry Walnut	Approx. Seating	Sections	Shipping Weight	Cubes
Stratford square and rectangular tops 	9801-36-36	2042	4	1	40	3
	9801-42-42	2281	4	1	44	4
	9801-48-36	2341	4	1	50	4
	9801-48-42	2505	4	1	55	4
	9801-48-48	2579	4	1	64	5
	9801-60-30	2707	6	1	52	8
	9801-60-36	2767	6	1	60	8
	9801-72-36	3016	6	1	80	10
	9801-84-42	3880	8	2	107	12
	9801-96-42	4247	8	2	138	14
	9801-96-48	4616	8	2	152	14
	9801-120-48	5573	10	3	183	18
	9801-120-54	6054	10	3	202	18
	9801-144-54	6936	12	3	237	21
	9801-168-54	8337	12	4	271	26
	9801-192-54	9095	12	4	305	28
	9801-216-60	10410	14	5	374	28
	9801-240-60	11566	16	5	428	39
	9801-264-60	12720	16	6	481	44
	9801-288-60	13888	18	6	534	47

Stratford racetrack tops 	9802-96-42	4267	8	2	122	10
	9802-96-48	4610	8	2	142	14
	9802-120-48	5910	10	3	172	18
	9802-120-54	6332	10	3	195	18
	9802-144-54	7078	12	3	229	21
	9802-168-54	8509	12	4	264	26
	9802-192-54	9285	12	4	298	29
	9802-216-60	10960	14	5	366	36
	9802-240-60	12174	16	5	420	39
	9802-264-60	13394	16	6	473	41
9802-288-60	14339	18	6	527	47	

All Stratford Conference products are available on the Krug Express Program with a size limitation of up to and including 168" tables only.

Stratford boat-shaped tops 	9804-96-48-42	4844	8	2	142	14
	9804-120-48-42	6648	10	3	195	18
	9804-144-48-42	7437	12	3	229	21
	9804-168-48-42	8938	12	3	263	26
	9804-192-54-48	9744	12	4	298	29
	9804-216-54-48	11512	14	5	366	36
	9804-240-54-48	12782	16	5	420	39
	9804-264-60-48	14064	16	6	473	41
	9804-288-60-48	15060	18	6	527	47

ORDERING PROCEDURE

To order, please specify the following:

- 1) Krug product model number
- 2) Wood species and finish

STANDARD FINISHES

For a complete list of standard finishes please see page 347.

WIRE ACCESS DOORS

Please specify wire access doors on round bases when specifying conference product with power boxes or wiring grommets.

BASE REQUIREMENTS

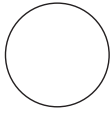
See page 197 for the base requirements chart.

POWER BOXES

See page 198 for information on conferencing power boxes.

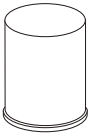
STRATFORD | TOPS AND BASES

Description	Model	Cherry Walnut	Approx. Seating	Sections	Shipping Weight	Cubes
Stratford round tops	9805-36D	2039	3	1	42	3
	9805-42D	2387	4	1	48	4
	9805-48D	2595	5	1	54	5
	9805-54D	3448	6	1	74	7
	9805-60D	4292	7	1	100	8



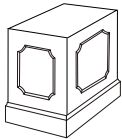
All Stratford Conference products are available on the Krug Express Program with a size limitation of up to and including 168" tables only.

Description	Model	Cherry Walnut	Approx. Seating	Sections	Shipping Weight	Cubes
Round drum base	9810-18D-30	1038	18 diameter	29	97	7
	9810-24D-30	1059	24 diameter	29	115	14
	9810-30D-30	1319	30 diameter	29	180	19



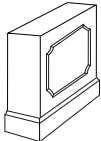
Wire management cavity for this base is:
 9810-18D-30 – 18" diameter by 16" in height
 9810-24D-30 – 24" diameter by 16" in height
 9810-30D-30 – 30" diameter by 16" in height
 Please add **WMD** to the end of the model number for wire management.

Description	Model	Cherry Walnut	W	D	H	Shipping Weight	Cubes
Square base	9818-1818-30	1247	17.75	17.75	29	99	7
	9818-2424-30	1268	23.75	23.75	29	117	14



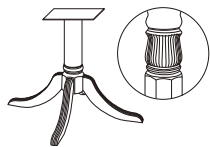
The square drum base has a removable side panel to allow access to the hidden cable management cavity.
 Wire management cavity for this base is:
 9818-1818-30 – 18" square by 25" in height
 9818-2424-30 – 24" square by 25" in height

Description	Model	Cherry Walnut	W	D	H	Shipping Weight	Cubes
Panel base	9815-28-6-30	940	27.75	5.75	29	30	4
	9815-34-6-30	1008	33.75	5.75	29	50	6



The panel base has a removable side panel to allow access to the hidden cable management cavity.
 Wire management cavity for this base is:
 9815-28-6-30 – 28" x 6" rectangular by 25" in height
 9815-34-6-30 – 28" x 6" rectangular by 25" in height

Pedestal base	9817	1031	26.5	26.5	29	40	10
---------------	------	------	------	------	----	----	----



48" and 54" diameter tops come standard with a larger pedestal base.

DIMENSION KEY

W – width
 D – depth
 H – height

Model numbers represent nominal dimensions only. Contact Customer Service if dimensions are critical.

See page 346 for *KrugExpress* program.

STANDARD FINISHES

For a complete list of standard finishes please see page 347.

BASE REQUIREMENTS

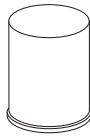
See page 197 for the base requirements chart.

POWER BOXES

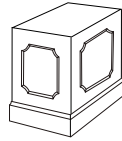
See page 198 for information on conferencing power boxes.

STRATFORD | BASE REQUIREMENTS

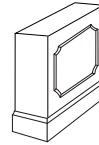
Round Drum
9810



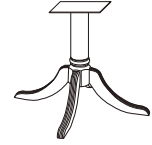
Square drum
9818



Panel base
9815



Pedestal panel
9817



Top Size	Quantity	Size	Quantity	Size	Quantity	Size	Quantity	Size
36 diameter	1	18					1	
36 - 36	1	18	1	18				
42 diameter	\						1	
42 - 42	1	18	1	18				
48 - 36	1	18	1	18				
48 - 42	1	18	1	18				
48 diameter	1	18	1	18			1	
48 - 48	1	18	1	18				
54 diameter	1	24					1	
60 - 30	2	18	2	18				
60 - 36	2	18	2	18				
60 diameter	1	30						
72 - 36	2	18	2	18				
84 - 42	2	18	2	18	2	28		
96 - 42	2	18	2	18	2	28		
96 - 48	2	18	2	18	2	28		
96-48-42	2	18	2	18	2	28		
120 - 48	2	18	2	18	3	28		
120-48-42	2	18	2	18	3	28		
120 - 54	2	18	2	18	3	34		
144 - 54	2	18	2	18	3	34		
144-48-42	3	18	3	18	3	28		
168 - 54	3	18	3	18	4	34		
168-48-42	3	18	3	18	3	28		
192 - 54	3	18	3	18	4	34		
192-54-48	3	18	3	18	4	34		
216-54-48	2	18	2	18	5	34		
	1	24	1	24				
216 - 60	3	24	3	24	5	34		
240-54-48	4	24	4	24	5	34		
240 - 60	4	24	4	24	5	34		
264 - 60	4	24	4	24	6	34		
264-60-48	4	24	4	24	6	34		
288 - 60	4	24	4	24	6	34		
288-60-48	4	24	4	24	6	34		


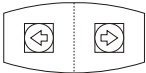

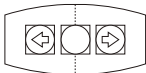
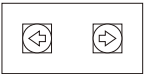
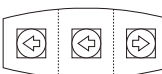
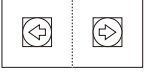
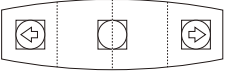
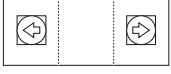
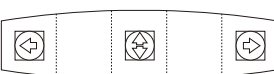

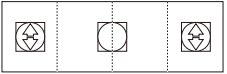
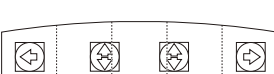
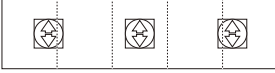
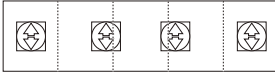
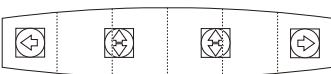
*Add an additional 24" diameter drum base for center-support.

**Add an additional 18" diameter drum base for center-support.

STRATFORD POWER BOX UPCHARGES

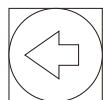
This chart applies to Stratford square/rectangular, racetrack, arc ended and round tops:

This chart applies to Stratford boat shaped tops: racetrack, arc ended and round tops:

Single / Multi Section Tops	Standard Top Sizes	\$ Upcharge per table	Single / Multi Section Tops	Standard Top Sizes	\$ Upcharge per table
 68PB	36 diameter 36-36 42 diameter 42-42 48-36 48-42 48 diameter 48-48	961		96-48-42 144-48-42	1924
	54 diameter 54-54 60 diameter 60-60	1924		144-48-42	1924
	60-30 60-36 72-36	1924		120-48-42	2883
	84-42 96-42 96-48	1924		168-48-42 192-54-48	1924
	120-48	1924		216 - 54 - 48	4040
	120 - 54 *144 - 54	4040			
	*168 - 54 *192 - 54	4040		240 - 54 - 48	6154
	216 - 60	6154			
	240 - 60 288 - 60	8265		264-60-48 288-60-48	6154

* Stratford Conference tops only, feature single power box configuration.

Note: When specified with power boxes, standard tops sizes must be ordered in configurations shown above. Upcharges shown are list prices.



Indicate 18" round and square drum bases with one power box facing ends of top.



Indicate 24" and 30" round and square bases with twin power box facing sides of top.

Connexus™ is Krug's proprietary tabletop connectivity solution. When opened, it presents power and data outlets on a convenient angle to the user and provides storage for wiring.

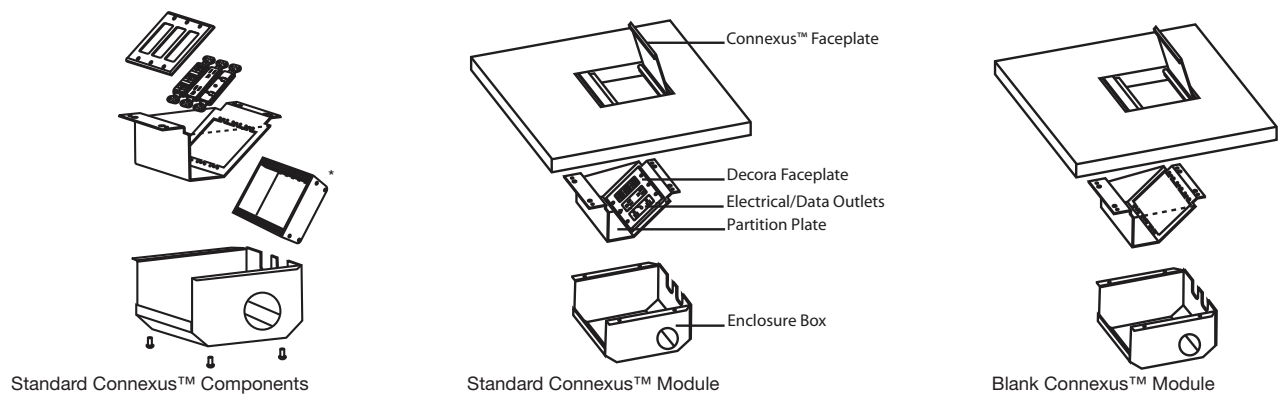
The faceplate of Connexus™ is available in either Glass or Aluminum and sits flush with the tabletop. It is designed to allow wiring to pass through the surface cover in both the open and closed positions. The faceplate opens to a 100° angle from the table top.

Connexus™ utilizes UL standard receptacle outlets. Connexus™ offers 11 pre-configured units with a wide selection of power, data and presentation system outlets, or alternatively can be purchased with just electrical ports with blank data ports. Connexus™ also can be designed and built specifically to meet your connectivity needs by using the snap-in or plate mounted port options.

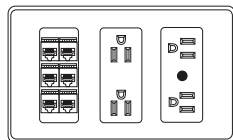
All corded units can be modified to allow the units to be hard wired by an electrician and data ports can be reconfigured easily when desired. To facilitate this process, the Enclosure Box of each Connexus™ module is easily removable.

*All duplex outlets are contained within a metal box that is attached to the Partition Plate. If additional outlets need to be added in the future, these boxes need to be ordered from Krug to expand the enclosure. All modifications must be done by a qualified electrician.

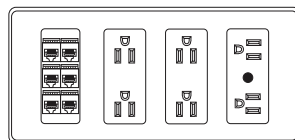
The label drawing shown below illustrates the way a Connexus™ module is shipped to the user. The Partition Plate is mounted on-site to the underside of the top with the Enclosure Box over top to conceal the module. Please note, enclosure boxes are not required when modules are enclosed in a base. Enclosure boxes are not supplied with Connexus™ modules; they must be ordered separately when required.



CONNEXUS™ SIZES



Standard - 3 Gang



Large - 4 Gang

Connexus™ modules may be specified in Standard or Large sizes.

Standard modules are available in 7 standard configurations or custom configurations. Connexus™ modules in Standard configurations are 6 1/8" x 7 3/8". Depth on Standard module is 4.5".

Large modules are available in 4 standard configurations or custom configurations. Connexus™ modules in Large configurations are 8 1/4" x 7 3/8". Depth on Large module is 4.5".

CONNEXUS™

Connexus™ modules are wired independently of each other to maximize the amount of electrical devices serviced. All Connexus™ modules may sustain individual loads of 15 amps or 12 amps of continuous load. Each Connexus™ module will require a single isolated circuit to maximize its service capabilities. An optional utility a/c power outlet is available on the back surface of the outlet box.

Connexus™ components are UL and CSA US approved and manufactured in accordance to the National Electrical Code. Hardwiring Connexus™ modules on-site must be performed by a licensed electrician. Connexus™ units can be ordered with an optional utility outlet, which is located on the bottom side of the Connexus™ unit and underneath the work surface. Other Connexus™ products could employ these utility outlets as a source of power. In this scenario, it is solely the responsibility of the end user to assure that proper circuit protection is in place that never exceeds the 15 Ampere Circuit Breaker Rating.

ELECTRICAL CORD LENGTHS

Connexus™ modules come with pre-determined electrical cord lengths that are suited to the size and configuration of each table (16' & 25'). Each will plug into a standard floor monument power source. However, in situations where a table length exceeds our maximum cord length, a second power entry is necessary to avoid daisy-chaining of electrical power. To determine when a second power entry is required follow these steps:

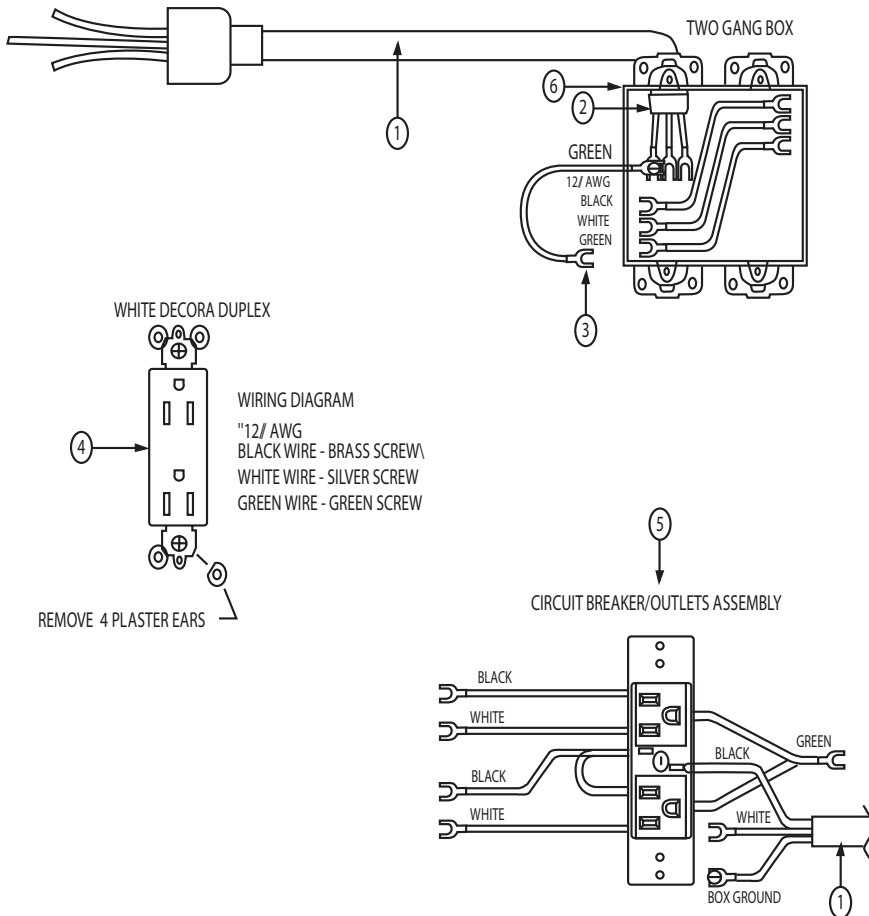
1. Select your Connexus™ locations.
2. Select your Floor Monument Location(s) if they do not already exist in the room.
3. If the number of Connexus™ modules exceed three consecutive positions left or right of the power entry, then an additional power entry will be required.

Note: Connexus™ modules in pairs count as one position.

HARDWIRING ON SITE

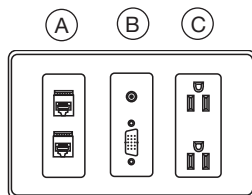
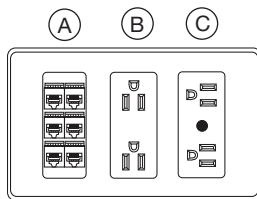
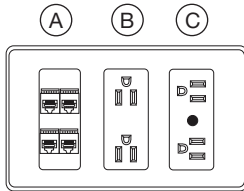
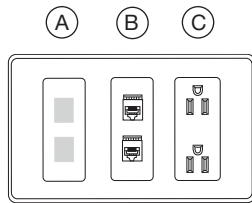
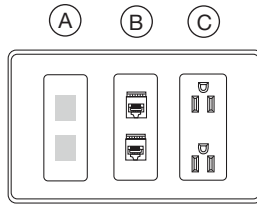
For hardwiring on-site by electricians, please use the following schematic:

- ① Power Supply Cord
- ② Strain Relief
- ③ Fork Terminals
- ④ Duplex Receptacles
- ⑤ Outlets with Circuit Breaker Assembly
- ⑥ Handy Box



CONNEXUS™ | PRECONFIGURED STANDARD MODULES

Standard - 3 GANG



Port Options	Model #	List Price	
		Aluminum	Glass

BASIC DATA

62 CON BD

1032

1143

- (A) (2) Blanks (for future use)
- (B) (2) RJ45 port (Category 6)
- (C) (2) AC power ports

BASIC VOICE DATA

62 CON BV

1307

1419

- (A) (2) Blanks (for future use)
- (B) (1) RJ11 port
(1) RJ45 port (Category 6)
- (C) (2) AC power ports

EXPANDED DATA

62 CON ED

1338

1451

- (A) (4) RJ45 port (Category 6)
- (B) (2) AC power ports
- (C) (2) AC power ports / with 15 amp circuit breaker

EXPANDED VOICE/DATA

62 CON

1209

1319

- (A) (2) RJ11 port
(4) RJ45 port (Category 6)
- (B) (2) AC power ports
- (C) (2) AC power ports / with 15 amp circuit breaker

BASIC MULTIMEDIA

62 CON BM

1660

1773

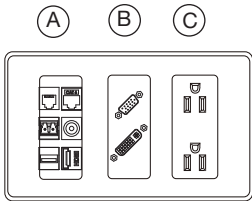
- (A) (1) RJ11 port
(1) RJ45 port (Category 6)
- (B) (1) 3.5 mm Mini
(1) VGA Type 15 pin HD
- (C) (2) AC power ports

ORDERING NOTE: Enclosure box is only required only when the Connexus™ is not positioned over a base. If an enclosure box is required, please clearly state this requirement on your purchase order and add the **\$302** per Connexus™.

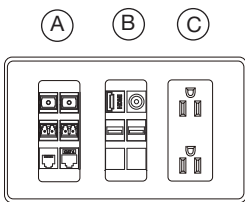
CONNEXUS™ | PRECONFIGURED STANDARD MODULES

Standard - 3 GANG

Port Options	Model #	List Price	
		Aluminum	Glass

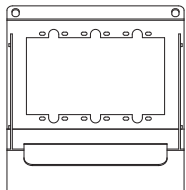


DATA & MULTIMEDIA	62 CON DM	1662	1773
(A)	(1) RJ11 (1) RJ45 (1) Fiber Optic LC Duplex (1) 3.5mm Stereo Mini (1) USB "A" (1) HDMI		
(B)	(1) DVI-I (1) VGA		
(C)	(2) AC power ports		



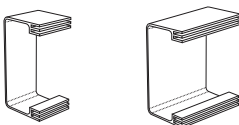
BASIC FIBRE OPTIC & MULTIMEDIA	62 CON BF	1596	1708
(A)	(2) Fibre Optic SC Simplex (2) Fiber Optic LC Duplex (1) RJ11 (1) RJ45		
(B)	(1) HDMI (1) 3.5mm Stereo Mini (2) USB "A" (2) Blanks		
(C)	(2) AC power ports		

ORDERING NOTE: Enclosure box is only required only when the Connexus™ is not positioned over a base. If an enclosure box is required, please clearly state this requirement on your purchase order and add the **\$302** per Connexus™.

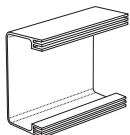


STANDARD BLANK MODULE	62 CON X1	129
------------------------------	-----------	-----

Blank Modules does not include the Connexus™ lid.

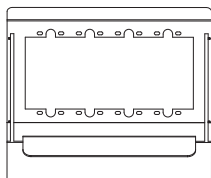
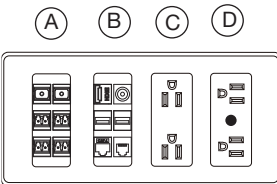
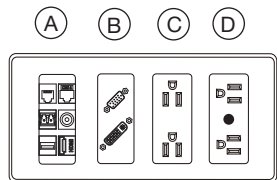
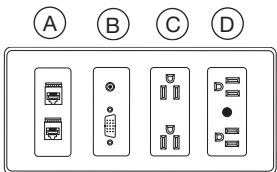
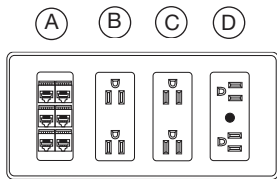


DUPLEX OUTLET ENCLOSURE	62 CON OUTBOX-1	49
To be used when adding duplex outlets to existing Connexus™ Modules.	62 CON OUTBOX-2	66
	62 CON OUTBOX-3	82



CONNEXUS™ | PRECONFIGURED LARGE MODULES

Large - 4 GANG



Port Options	Model #	List Price	
		Aluminum	Glass
NETWORK AND POWER CENTRE	62 CON NP	1629	1727
(A) (6) RJ-45 ports			
(B) (2) AC power ports			
(C) (2) AC power ports			
(D) (2) AC power ports/with 15 amp circuit breaker			
BASIC MULTIMEDIA WITH 2X POWER	62 CON B2	1491	1587
(A) (1) RJ11 port (1) RJ45 port			
(B) (1) 3.5 mm Mini with 2x Power (1) VGA type 15 pin HD			
(C) (2) AC power ports			
(D) (2) AC power ports/with 15 amp circuit breaker			
DATA & MULTIMEDIA WITH 2X POWER	62 CON DM2	1951	2046
(A) (1) RJ11 port (1) RJ45 port (1) 1 Fiber Optic LC Duplex (1) 1 3.5mm Stereo Mini (1) 1 USB "A" (1) 1 HDMI			
(B) (1) DVI-I (1) VGA			
(C) (2) AC power ports			
(D) (2) AC power ports/with 15 amp circuit breaker			
EXPANDED FIBRE OPTIC AND MULTIMEDIA	62 CON EF	2031	2129
(A) (2) Fibre Optic SC Simplex (4) Fiber Optic LC Duplex			
(B) (1) HDMI, (1) Stereo 3.5 Mini (2) USB "A", (1) RJ45 (1) RJ11			
(C) (2) AC power port			
(D) (2) AC power ports/with 15 amp circuit breaker			
LARGE BLANK MODULE	62 CON X2		148

Blank Modules does not include the Connexus™ lid.

ORDERING NOTE: Enclosure box is only required when the Connexus™ is not positioned over a base. If an enclosure box is required, please clearly state this requirement on your purchase order and add the **\$302** per Connexus™.

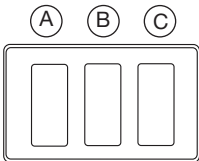
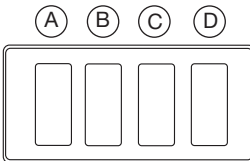
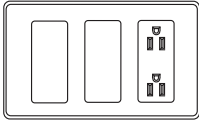
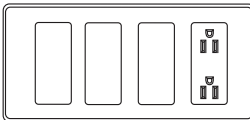
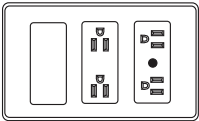
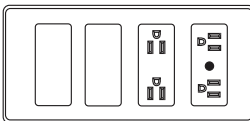
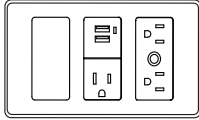
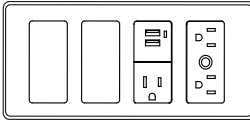
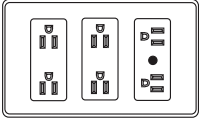
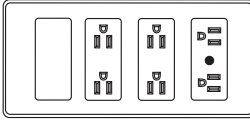
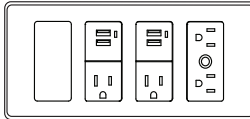
CONNEXUS™ | CUSTOM CONNEXUS™

Planning a custom Connexus™ unit is easy when following these 6 simple steps.

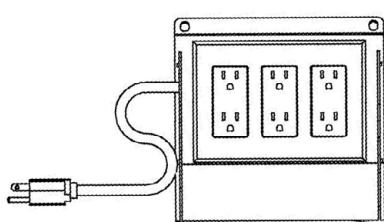
STEP ONE: Select the quantity of AC power ports or AC power ports with USB Charging (select configurations only) that are required.

Power modules must always be positioned starting from the right side of the unit. For example, 3 gang Connexus™ can have a power module located in position C with data ports in position A and B, or power can be located in position B and C with data port in position A, or position A,B and C can have all power ports or all data ports. Please note, 4 gang Connexus™ are not available with power ports located in position A.

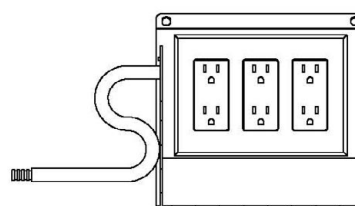
On select configurations shown below, USB charging outlets are available. These charging outlets allow a user to charge most personal electronic devices without the need for any special power adapter or a computer - simply plug in your device with any compatible USB cable. This component has 2 USB charging slots that supply 5V DC at 700mA. Comes with a charging indicator light, as well as a standard 120 volt simplex receptacle on the bottom portion of the component.

Standard Connexus™	List Price	Large Connexus™	List Price
 <p>3 Gang: Data ports only E300 - Standard Data Ports</p>	82	 <p>4 Gang: Data Ports only E400 - Large Data Ports</p>	170
 <p>3 Gang: AC Power Port E31S - Standard Outlet E31U - Standard & Utility Outlets</p>	565 605	 <p>4 Gang: AC Power Port E41S - Large Outlet E41U - Large & Utility Outlets</p>	637 677
 <p>3 Gang: AC Power Port / AC Power Port with 15 amp circuit breaker E32S - Standard Outlet E32U - Standard & Utility Outlet</p>	740 782	 <p>4 Gang: AC Power Port / AC Power Port with 15 amp circuit breaker E42S - Large Outlet E42U - Large & Utility Outlets</p>	832 871
 <p>3 Gang: AC Power Port Simplex with USB Charging/AC Power Port with 15 amp circuit breaker E32SC - Standard Outlet E32UC - Standard & Utility Outlet</p>	984 1026	 <p>4 Gang: AC Power Port Simplex with USB Charging/AC Power Port with 15 amp circuit breaker E42SC - Standard Outlet E42UC - Standard & Utility Outlet</p>	1071 1114
 <p>3 Gang: (2) AC Power Port / AC Power Port with 15 amp circuit breaker E33S - Standard Outlet E33U - Standard & Utility Outlet</p>	904 942	 <p>4 Gang: (2) AC Power Port / AC Power Port with 15 amp circuit breaker E43S - Large Outlet E43U - Large & Utility Outlets</p>	887 928
		 <p>4 Gang: (2) AC Power Port Simplex with USB Charging/AC Power Port with 15 amp circuit breaker E43SC - Standard Outlet E43UC - Standard & Utility Outlet</p>	1127 1168

STEP TWO : There are two cord end options available; Plug In and Conduit. The standard Plug In option will connect with any standard floor monument power source. The Conduit option is Liguatite® (a steel inner conduit with a PVC overlay) by Anamet, meant for specific hard wiring applications. Units can come in cord lengths of 16' or 25'. Not Applicable if no power is selected.

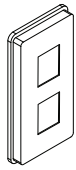


EP
Electrical Plug In
No Upcharge

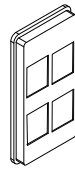


EC
Electrical Conduit
Add upcharge
16' 148
25' 243

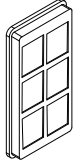
STEP THREE: There are two data options available; Plate mounted ports or Snap-in ports. Snap-in ports are available in configurations of two, four or six. Choose the faceplate below that meets your data requirements. If an odd number of Snap-in ports are required, a blank port needs to be selected when the opening is not in use.



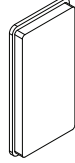
M02
Mounting Plate (2)
accepts two snap in data ports
Add \$37 list



M04
Mounting Plate (4)
accepts four snap in data ports
Add \$37 list



M06
Mounting Plate (6)
accepts six snap in data ports
Add \$37 list



M00
Mounting Plates
Add \$37 list

STEP FOUR: Choose the Plate mounted port or Snap-in ports options for non-powered positions. As an aid, use the chart below to help design and build your Connexus™ to meet the rooms needs. Use the check boxes and list the components on the lines below.

Standard Connexus™

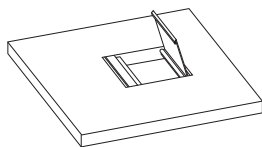
(A)	(B)	(C)
<input type="checkbox"/> POWER	<input type="checkbox"/> POWER/POWER & USB CHARGING	<input type="checkbox"/> POWER
OR	OR	OR
<input type="checkbox"/> PLATE MOUNTED PORT	<input type="checkbox"/> PLATE MOUNTED PORT	<input type="checkbox"/> PLATE MOUNTED PORT
OR	OR	OR
<input type="checkbox"/> SNAP-IN PORTS	<input type="checkbox"/> SNAP-IN PORTS	<input type="checkbox"/> SNAP-IN PORTS
_____	_____	_____
_____	_____	_____
_____	_____	_____

Large Connexus™

(A)	(B)	(C)	(D)
<input type="checkbox"/> POWER	<input type="checkbox"/> POWER/POWER & USB CHARGING	<input type="checkbox"/> POWER/POWER & USB CHARGING	<input type="checkbox"/> POWER
OR	OR	OR	OR
<input type="checkbox"/> PLATE MOUNTED PORT	<input type="checkbox"/> PLATE MOUNTED PORT	<input type="checkbox"/> PLATE MOUNTED PORT	<input type="checkbox"/> PLATE MOUNTED PORT
OR	OR	OR	OR
<input type="checkbox"/> SNAP-IN PORTS	<input type="checkbox"/> SNAP-IN PORTS	<input type="checkbox"/> SNAP-IN PORTS	<input type="checkbox"/> SNAP-IN PORTS
_____	_____	_____	_____
_____	_____	_____	_____
_____	_____	_____	_____

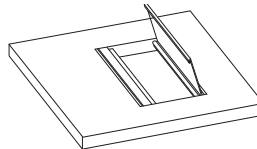
STEP FIVE: Select the Connexus™ Cover (Aluminum or Glass)

Standard Connexus™



3 GANG
3CCA Aluminum \$379 list
3CFG Glass \$468 list
3C00 No Lid

Large Connexus™



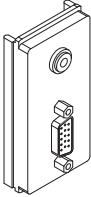
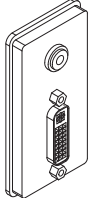
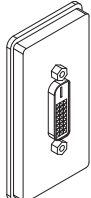
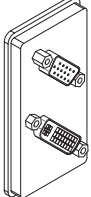
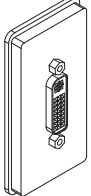
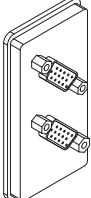
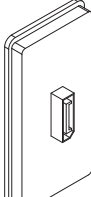
4 GANG
4CCA Aluminum \$391 list
4CFG Glass \$483 list
4C00 No Lid

STEP SIX: Enclosure box is only required only when the Connexus™ is not positioned over a base. If an enclosure box is required, please clearly state this requirement on your order and add the **\$302** per Connexus™.

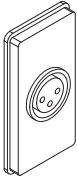
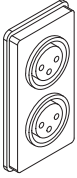
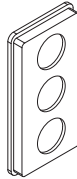
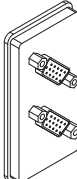
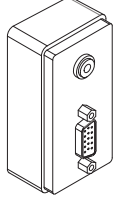
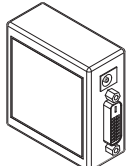
STEP SEVEN: Calculate the total list price for the custom Connexus™ by adding the following prices:

- Connexus™ Box with required AC Power Ports
- Faceplate (Snap-in Ports Only)
- Snap-In Ports or Plate Mounted Data Ports
- Enclosure Box (if required)
- Connexus™ Lid (Aluminum or Glass)

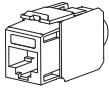

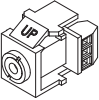
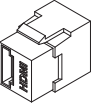



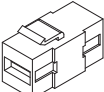
CONNEXUS™ | PORT OPTIONS

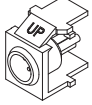
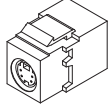
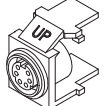
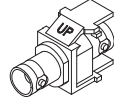

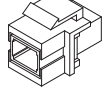
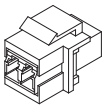
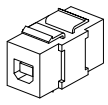
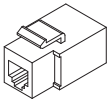
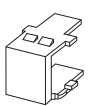
PLATE MOUNTED PORTS	Reference Code	Description	List Price
	P01	VGA & 3.5 STEREO MINI - Use for VGA (DB15) connections and for 3.5mm stereo connections. Connector is a female input with screw terminal output (back side of Console interface).	143
	P02	DVI-I DUAL (DIGITAL/ANALOG) & 3.5 STEREO MINI - Use for DVI Integrated - Digital and Analog connections and for 3.5mm stereo connection. The DVI connector is a Dual Link. DVI-I connector is a female-to-female pass through and the 3.5 Mini is a female input with screw terminal output (back side of Console interface).	212
	P03	DVI-D DUAL (DIGITAL) - Use for DVI-D Digital only connection. The connector is a Dual Link. Connector is a female-to-female pass through.	137
	P04	DVI-I DUAL (DIGITAL/ANALOG) & VGA - Use for DVI Integrated - Digital and Analog and for VGA (DB15) connections. The DVI connector is a Dual Link. Both connectors are female-to-female pass through.	271
	P05	DVI-I DUAL (DIGITAL/ANALOG) - Use for DVI Integrated - Digital and Analog connections. DVI connector is a Dual Link. Connector is a female-to-female pass through.	173
	P06	VGA-2 - Use for two VGA (DB15) connections. Both connectors are female-to-female pass through.	168
	P07	DISPLAYPORT - Use for DisplayPort connection. This connector is primarily used to connect a video source to a display device and also carries audio signals, Connector is a female input to a 3' corded output (back side of Console interface) with a male Display Port termination.	168

CONNEXUS™ | PORT OPTIONS

PLATE MOUNTED PORTS	Reference Code	Description	List Price
	P08	MICROPHONE XLR STANDARD - Use for standard size XLR microphone connection. Connector is a female input with a 3 pin screw terminal output (back side of Console interface).	228
	P09	MICROPHONE STANDARD XLR -2 - Use for two standard size XLR microphone connections. Each connector is a female input with a 3 pin screw terminal output (back side of Console interface).	333
	P10	3 HOLE CABLE PASS THROUGH - Use for running loose cables from the under side of the table up into the Console interface cavity. Often used with running wires for PolyCom™ devices.	54
	P11	VGA-to-BNCx2 - Use for two VGA (DB15) connections that are input female pass through and are terminated on the output (back side of Console interface) with 5 BNC female pigtail connections, for each VGA connector.	542
	P12	INPUT VGA & 3.5 Stereo (POWERED) - VGA + Audio Line Driver designed for VGA (DB15) connections and for 3.5mm stereo connections. This unit provides a method of transmitting signals to a remote display and audio receiver or amplifier. VGA connector is a female input and comes with cabling for either VGA output, or 5 BNC output and the 3.5 Mini is a female input with screw terminal output (back side of Console interface). A 9 volt DC 500mA power supply is required to power this unit.	1327
PORT ACCESSORIES	Reference Code	Description	List Price
	DVIR	DVI-REPEATER - Is a cable equalizer that automatically compensates for long DVI cable runs. This unit extends the usable cable distance up to 130ft depending on the quality of the cable and the resolution of the video signal. Additionally, it is capable of extending dual link signals allowing for much greater resolutions and refresh rates. This unit comes with a power supply and is generally mounted underneath a table.	1046

CONNEXUS™ | PORT OPTIONS

SNAP IN PORTS	Reference Code	Description	List Price
	S01W S01B S01R	RJ-45 - Category 6 data connection. This connector is also downwards compatible with Category 5 cabling. Connector is a female input with a #110 punch-down terminal block output (back side of Console interface) for on-site hard wire connection. RJ45-CAT6 (White) RJ45-CAT6 (Blue) RJ45-CAT6 (Red)	47
	S02W S02B S02G S02R S02Y	RJ11 - Telephone type connection. Connector is a female input with a #110 punch-down terminal block output (back side of Console interface) for on-site hard wire connection. RJ11 (White) RJ11-B (Black) RJ11-G (Green) RJ11-R (Red) RJ11-Y (Yellow)	32
	S03	3.5 STEREO MINI - 3.5mm stereo connection. Connector is a female input with screw terminal output (back side of Console interface).	92
	S04	HDMI - High Definition Multimedia Interface connection. Connector carries both HD audio and video data. Connector is a female-to-female pass through.	173
	S05	RCA-LEFT - RCA left audio channel connection. Color coded with black. Connector is a female-to-female pass through.	38
	S06	RCA-RIGHT -RCA right audio channel connection. Color coded with red. Connector is a female-to-female pass through.	38
	S07	RCA- VIDEO - RCA video channel connection. Color coded with yellow. Connector is a female-to-female pass through.	38
	S08	USB-A - Full size USB "A" style connection. Connector is a female-to-female pass through.	61

SNAP IN PORTS	Reference Code	Description	List Price
	S09	3 PIN MINI XLR - 3 Pin Mini XLR microphone connection. Connector is a female input to a 6' corded output (back side of Console interface) with a 3 Pin Mini XLR male termination.	739
	S10	S-VIDEO - S-Video connection. Connector is a female-to-female pass through.	68
	S11	PS/2 (6 PIN MINI DIN) - PS/2 (mouse, keyboard, other input devices) connections. Connector is a female-to-female pass through.	85
	S12	BNC - BNC style data connection for use with co-axial cable. Connector is a female-to-female pass through.	47
	S13	F-TYPE - F-Type (DSL, Cable) connections, generally for high speed Internet or video applications. Connector is a female-to-female threaded pass through.	38
	S14	FIBER OPTIC SC - Fibre Optic SC Simplex connection. Connector is a female-to-female pass through. Please note that two of these connectors are required to complete the data transmissions to and from the source and destination units.	47
	S15	FIBER OPTIC LC - Fibre Optic LC Duplex connection. Connector is a female-to-female pass through. One connector only is required to complete the data transmissions to and from source and destination units.	92
	S16	USB-B - USB "B" type connection. Connector is a female "B" input to a female "A" output (back side of Console interface). This connector is reversible.	137
	S17	RJ12 (White) - RJ12 style PolyCom™ connection. Connector is a female input with a 6' corded output (back side) of Console interface) with a male RJ12 termination.	295
	S00	BLANK COVER - Blank covers are required when port is not in use.	16

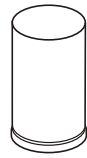
NOTE: Up to 6 snap-in data ports can be ordered for open data positions. Snap-in adaptors can accept 2, 4 or 6 snap-in data ports. Please order a blank port when an odd number of snap-in ports are specified.

STRATFORD | CONNEXUS™ LOCATIONS CHARTS

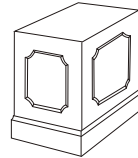
TOP STYLES



BASE STYLES



Round Drum Base

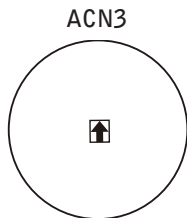


Square Drum Base

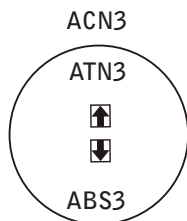
The Connexus™ Locations diagrams below show the available Connexus™ locations for only the top and base configurations shown above. Please note that the maximum allowable Connexus™ modules per top are shown, and tops may be specified with fewer modules. Each Connexus™ module has a code to represent its location on the table surface. To specify a Connexus™ module in a particular location, please use the code listed above it. For information on Connexus™ modules please see page 201.

Note: One Connexus™ module is available where two modules are shown. Please refer to location code above the drawing for single center location in which case the Connexus™ unit will face West if on the left end of the top, and East if on the right end of the top.

For large Connexus™ units please replace "3" in location code with "4". Please see conditions at bottom of page.



Represents 42", 48" and 54" top locations




Represents 60" top location


Connexus™ is not available on 36" square or round tops.

18" Drum bases will accommodate single standard Connexus™ units only.

24" Drum bases will accommodate single standard or large Connexus™ units only.

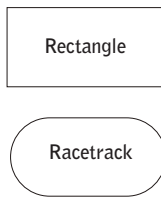
30" Drum bases will accommodate single or double standard or large Connexus™ units.

 REPRESENTS MODULES THAT WHEN OPENED FACE THE ENDS OF THE TABLE

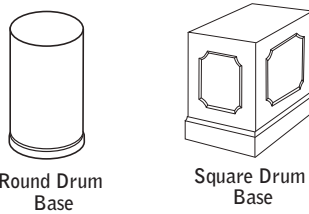
 REPRESENTS MODULES THAT WHEN OPENED FACE THE SIDES OF THE TABLE

STRATFORD | CONNEXUS™ LOCATIONS CHARTS

TOP STYLES

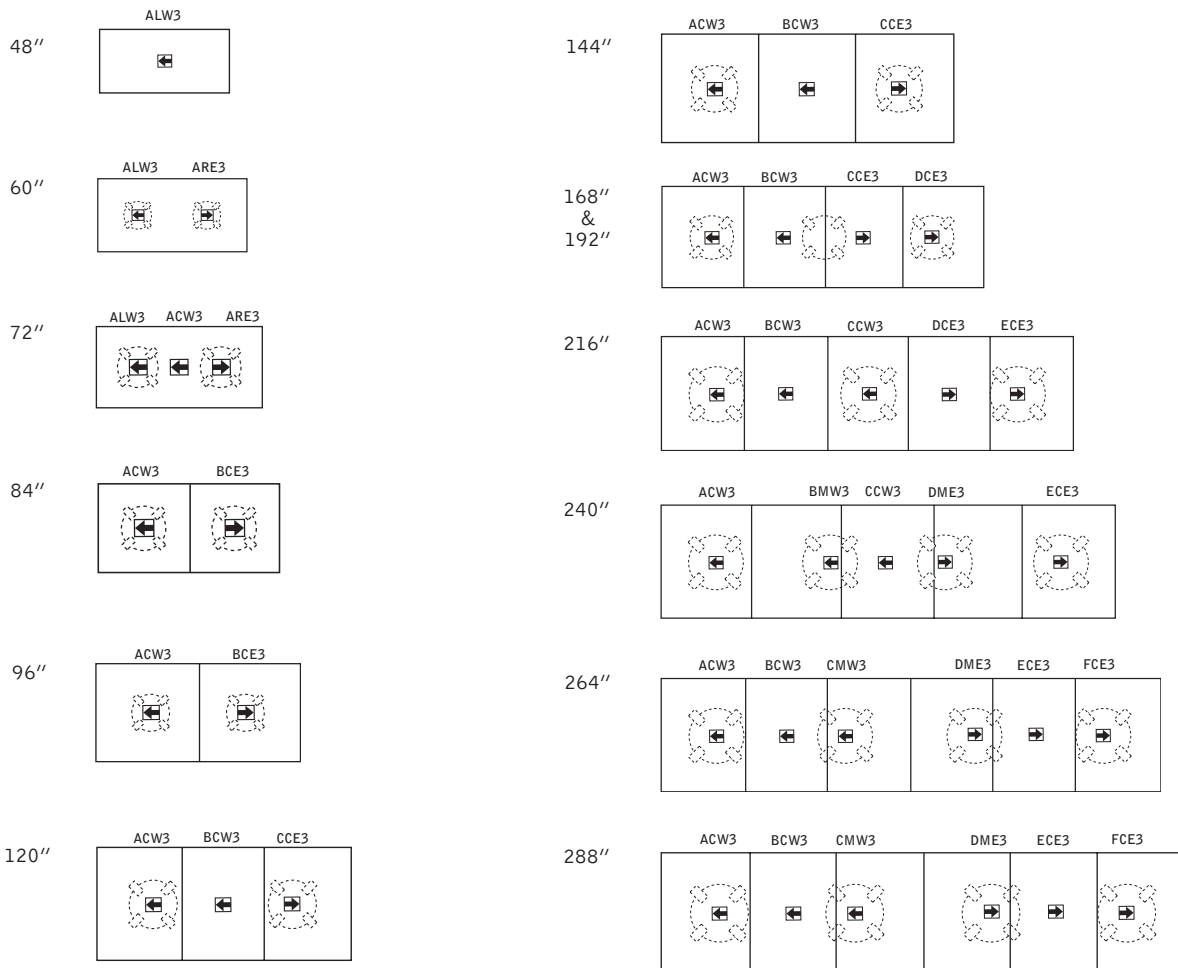


BASE STYLES



The Connexus™ Locations diagrams below show the available Connexus™ locations for only the top and base configurations shown above. Please note that the maximum allowable Connexus™ modules per top are shown, and tops may be specified with fewer modules. Each Connexus™ module has a code to represent its location on the table surface. To specify a Connexus™ module in a particular location, please use the code listed above it. For information on Connexus™ modules please see page 201.

Note: One Connexus™ module is available where two modules are shown. Please refer to location code above the drawing for single center location in which case the Connexus™ unit will face West if on the left end of the top, and East if on the right end of the top. For large Connexus™ units please replace “3” in location code with “4”. Please see conditions at bottom of page.



18" Drum bases will accommodate single standard Connexus™ units only.

24" Drum bases will accommodate single standard or large Connexus™ units only.

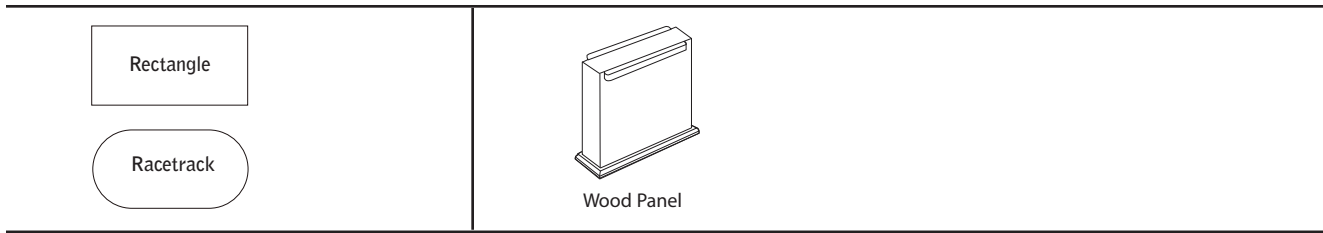
REPRESENTS MODULES THAT WHEN OPENED FACE THE ENDS OF THE TABLE

REPRESENTS MODULES THAT WHEN OPENED FACE THE SIDES OF THE TABLE

STRATFORD | CONNEXUS™ LOCATIONS CHARTS

TOP STYLES

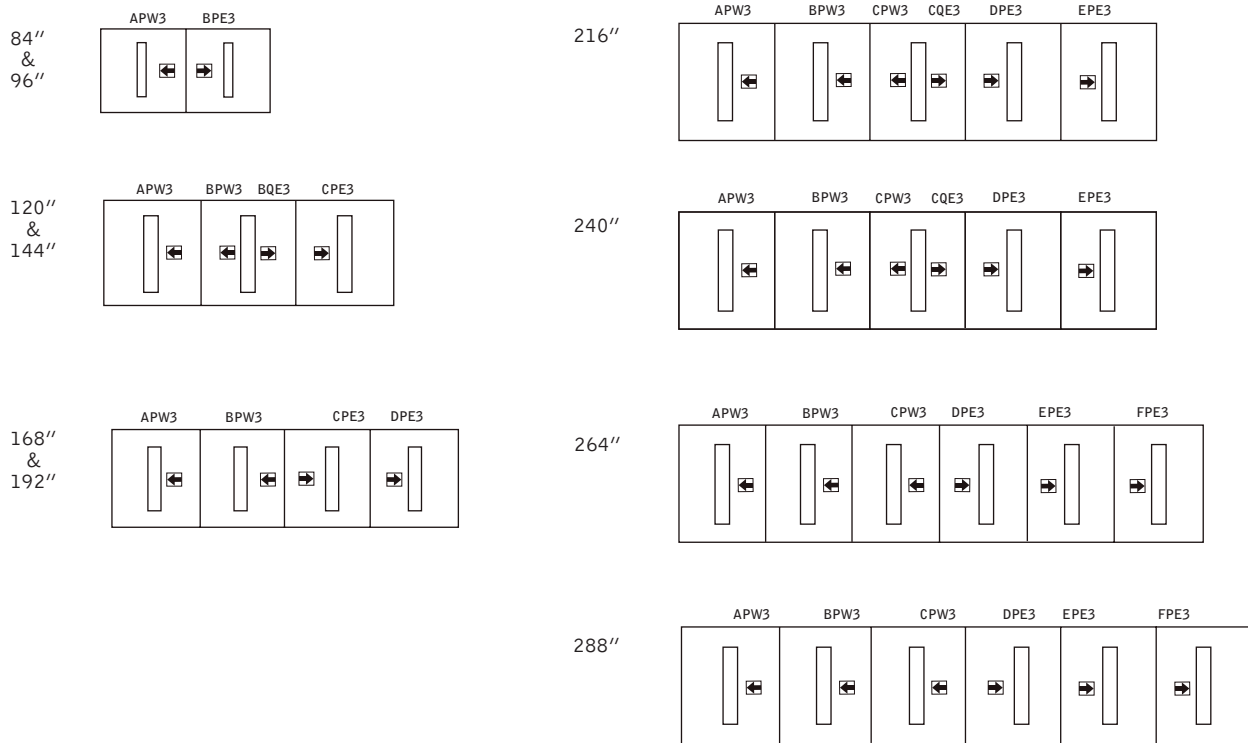
BASE STYLES





The Connexus™ Locations diagrams below show the available Connexus™ locations for only the top and base configurations shown above. Please note that the maximum allowable Connexus™ modules per top are shown, and tops may be specified with fewer modules. Each Connexus™ module has a code to represent its location on the table surface. To specify a Connexus™ module in a particular location, please use the code listed above it. For information on Connexus™ modules please see page 201.

Note: One Connexus™ module is available where two modules are shown. Please refer to location code above the drawing for single center location in which case the Connexus™ unit will face West if on the left end of the top, and East if on the right end of the top.

For large Connexus™ units please replace “3” in location code with “4”.



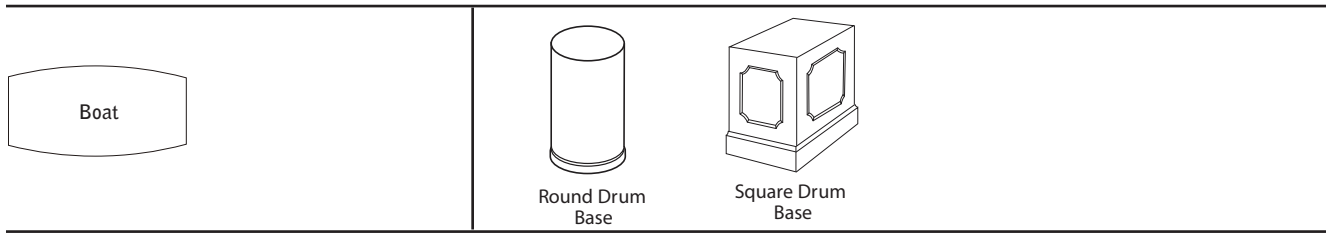
 REPRESENTS MODULES THAT WHEN OPENED FACE THE ENDS OF THE TABLE

 REPRESENTS MODULES THAT WHEN OPENED FACE THE SIDES OF THE TABLE

STRATFORD | CONNEXUS™ LOCATIONS CHARTS

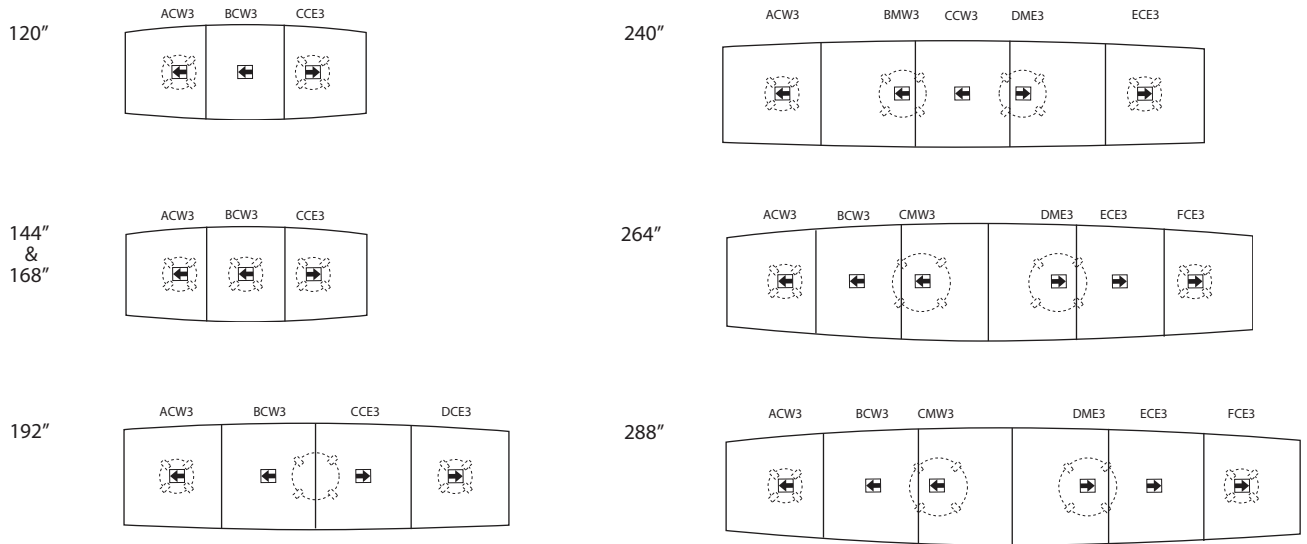
TOP STYLES

BASE STYLES



The Connexus™ Locations diagrams below show the available Connexus™ locations for only the top and base configurations shown above. Please note that the maximum allowable Connexus™ modules per top are shown, and tops may be specified with fewer modules. Each Connexus™ module has a code to represent its location on the table surface. To specify a Connexus™ module in a particular location, please use the code listed above it. For information on Connexus™ modules please see page 201.

Note: One Connexus™ module is available where two modules are shown. Please refer to location code above the drawing for single center location in which case the Connexus™ unit will face West if on the left end of the top, and East if on the right end of the top. For large Connexus™ units please replace “3” in location code with “4”. Please see conditions at bottom of page.



18" Drum bases will accommodate single standard Connexus™ units only.
 24" Drum bases will accommodate single standard or large Connexus™ units only.

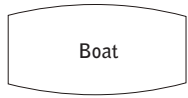
REPRESENTS MODULES THAT WHEN OPENED FACE THE ENDS OF THE TABLE

REPRESENTS MODULES THAT WHEN OPENED FACE THE SIDES OF THE TABLE

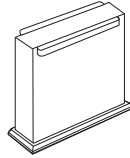
STRATFORD | CONNEXUS™ LOCATIONS CHARTS

TOP STYLES

BASE STYLES



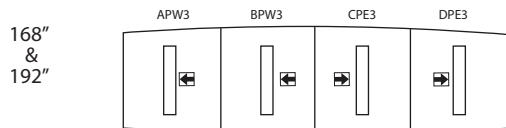
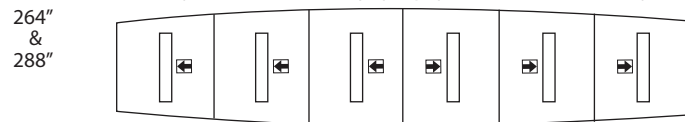
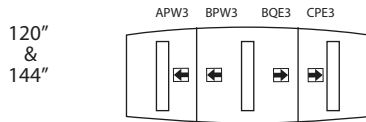
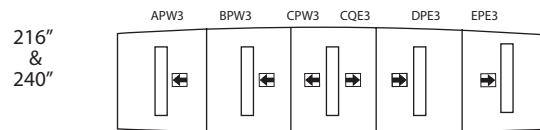
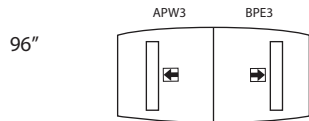
Boat







Wood Panel

The Connexus™ Locations diagrams below show the available Connexus™ locations for only the top and base configurations shown above. Please note that the maximum allowable Connexus™ modules per top are shown, and tops may be specified with fewer modules. Each Connexus™ module has a code to represent its location on the table surface. To specify a Connexus™ module in a particular location, please use the code listed above it. For information on Connexus™ modules please see page 201.

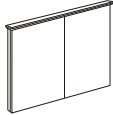
Note: One Connexus™ module is available where two modules are shown. Please refer to location code above the drawing for single center location in which case the Connexus™ unit will face West if on the left end of the top, and East if on the right end of the top. For large Connexus™ units please replace “3” in location code with “4”.





 REPRESENTS MODULES THAT WHEN OPENED FACE THE ENDS OF THE TABLE

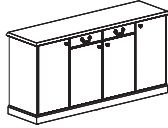


 REPRESENTS MODULES THAT WHEN OPENED FACE THE SIDES OF THE TABLE

Description	Model	Cherry Walnut	W	D	H	Shipping Weight	Cubes
Visual board	98VB-4848	3428	48	48	-	43	10



The visual board includes a standard tackboard in a grade 1 fabric or optional cork surface. Visual boards also include a flip chart, and four dry erase markers. An optional pull down screen is also available at **\$212 list**.

Buffet	98BU722036	6352	72.25	19.75	36	380	55
	98BU722436	6872	72.25	23.75	36	390	60

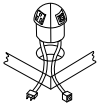


STRATFORD | POWER MANAGEMENT

Description	Model	Price	L	w	H	Shipping Weight	Cubes
Wire management cover	68WM-72	164	72	2.5	1	-	-
	68WM-4	34	3.4	1.75	-	-	-

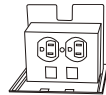


Power pod	68PP-1	435	3.2Dia.	3.5	-	-	-
-----------	--------	-----	---------	-----	---	---	---



Power pod includes two power ports and two communication ports with RJ45 couplers as a standard. Unit may also be ordered with 4 power ports or with RJ11 couplers. Please specify at time of order.

Power box
Power boxes may be specified for use over round and square drum bases only. 18" bases accommodate boxes with ports facing the ends of the table. 24" and 30" bases house two power boxes in a back to back configuration with ports facing the sides of the table.



- Power boxes include:
- 2 power outlets
 - 1 RJ-11 phone line coupler
 - 1 RJ-45 data coupler
 - 1 six foot 14/3 power cord

Please see charts (page 198) for standard power box locations and their respective upcharges. For more information on selecting base sizes for tops see base requirements charts on page 197. To order tops with power boxes, please indicate clearly on purchase order.

ORDERING PROCEDURE

To order, please specify the following:

- 1) Krug product model number
- 2) Wood species and finish

STANDARD FINISHES

For a complete list of standard finishes please see page 347.

POWER BOXES

See page 198 for information on conferencing power boxes.

VIRTU | TABLE OF CONTENTS

VIRTU | CONFERENCE TABLES

221	Environmental Summary
222	Introduction & Overview
224	Features & Options
228	Sample Layouts
230	Rectangular Table Specifications
234	Arced Rectangle Table Specifications
238	Racetrack Table Specifications
242	Boat Table Specifications
246	Oval Table Specifications
250	Verso Table Specifications
252	Visio Table Specifications
256	Open Visio Table Specifications
260	Delta & Arched Square Table Specifications
262	Round & Square Table Specifications
264	Power & Communication Planning

CONNEXUS™ TABLETOP CONNECTIVITY SOLUTION

271	Connexus™
273	Preconfigured Standard Modules
275	Preconfigured Large Modules
276	Custom Connexus™
278	Port Options
282	Connexus™ Location Charts
294	Floor Monument Locations
312	Conference Table Ordering Chart Sample

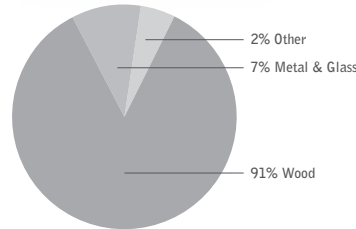
VIRTU MEDIA

313	Cabinets
327	Wardrobes
328	Credenzas & Buffets
332	Server Cart & Media Cart
333	Visual Board
334	Lectern
336	Electrical Accessories
237	Installation Instructions

LEED CERTIFICATION



MATERIAL CONTENT:



PRE-CONSUMER RECYCLED CONTENT - 73%
POST-CONSUMER RECYCLED CONTENT - 2.5%

Credit	Description	CONTRIBUTES To
Credit 2.1 - 2.2	Construction Waste Management	1-2 point(s)
Credit 3.3	Resource Reuse	1 point
Credit 4.1	Recycled Content	1 point
Credit 4.2	Recycled Content	1 point
Credit 4.5	Low Emitting Materials, (MUST BE REQUESTED) Composite Wood & Laminate Adhesives	1 point
Credit 5.1	Regional Materials*	1 point
Credit 6	Rapidly Renewable Materials (MUST BE REQUESTED)	1 point
Credit 7	Certified Wood (MUST BE REQUESTED)	1 point

*This credit is only applicable if in total 20% of the combined value of the procurement of construction materials and in the furniture are manufactured within a radius of 500 miles. This credit will apply if the installation of the finished product occurs within 500 miles of Kitchener, Ontario.



level® CERTIFICATION

BIFMA's e3 Furniture Sustainability Standard is a voluntary, multi-attribute standard that measures the degree of sustainability of furniture. This standard evaluates product and company environmental attributes and compliance systems in a wide range of elements which include Materials, Energy & Atmosphere, Human & Ecosystem Health and Social Responsibility. Virtu products have earned level®, BIFMA's sustainability certification program for furniture, certification through third-party verification against the e3 standard. All Virtu products can be supplied with level® certification. In order to accomplish this, the product must also be ordered with the air-emissions-certification option. Contact customer service for information and upcharges.



FSC
www.fsc.org
FSC® C021699

the mark of responsible forest

AIR-EMISSIONS

All Virtu products can be supplied with air-emissions-certified materials. Contact customer service for information and upcharges.

FSC®

FSC® In 2005, Krug received Forest Stewardship Council® (FSC®) Chain-of-Custody certification for our manufacturing facilities. The FSC® Chain-of-Custody tracks certified wood from seedling to final sale. It verifies that the material for our FSC® certified products only come from well-managed, FSC®-certified forests and other controlled sources. FSC® is dedicated to the promotion of responsible forest management worldwide helping to take care of forests for future generations. Virtu and other Krug products can be specified with FSC® Certification. Contact customer service for further information, pricing and lead times..



In addition, architects, designers, and building professionals can specify FSC®-certified products in order to achieve a point from the U.S. Green Building Council's Leadership in Energy and Environmental Design (LEED) Rating System.

VIRTU | INTRODUCTION AND OVERVIEW

FUELING CREATIVITY

As much as anything, the development of VIRTU reflects the growing importance of meeting space in virtually all organizations. Facilitating interaction and collaboration between people, and creating environments where relationships can be established and built, is both the challenge and the opportunity of office design.

This was the inspiration for creating VIRTU Conferencing – a collaborative process itself, between Hatch Design and Krug’s in-house design team. Spending countless hours in meeting rooms was a pretty good way to develop a conferencing product – lots of firsthand knowledge was involved. But we also talked to facility managers, designers and architects about what their needs were, and what was lacking among available products. We talked to dealers and installers about what goes wrong when meeting rooms are ordered and installed, and to electricians about how we could create an interface with technology that would not become outdated by the constant advances in this area.

Most of all, VIRTU is about design that helps organizations reach their potential. In the words of principal designer John Edwards, “VIRTU has many attributes, but our primary goal was to create meeting rooms that would truly stimulate people. Many of the unique elements of VIRTU – such as the Verso Table, the Connexus™ module, the shapes and angles, the combinations of materials – are meant to allow a space to facilitate the creative process. Furnishings that can do this deliver tremendous value.”

To this point, higher-end conference rooms have usually required the client or the designer to find a custom millwork house to make furniture. This can offer some advantages, but also some disadvantages: high cost, long lead times, the challenges of matching finishes and materials to other furniture, and perhaps most of all, the extensive work involved with designing custom furniture in the first place.

VIRTU changes all of that. All of these issues are turned into solutions. VIRTU is the most extensive product offering of its kind. Krug’s industry-leading production system provides a huge array of options within this line, allowing for the specific needs and wants of each project to be addressed. But addressed with a product range that is already designed, engineered, and is manufactured with a process that takes a few days, rather than weeks. And when all is said and done, VIRTU provides the best value available today.

THE VERSO TABLE – PATENTED FOR PRESENTATIONS!

The Verso table offers a unique range of conferencing options in a single table. First, its tapered shape - like the Visio and Open Visio tables in VIRTU – provides a great solution for videoconferencing. Second, the Verso table incorporates leading-edge thinking on how to make the best in-person presentations. This thinking says that from the audience’s perspective, the presenter should always be positioned to the left of the visuals at the front of the room. The Verso table is designed to orient the presenter and the audience in this correct positioning.

Third, Verso is designed to work well for meetings where participants are all seated at the table. Many videoconferencing tables, with a separation in the middle, do not work particularly well for sit-down meetings. The Verso table’s effective accommodation of all three meeting room scenarios makes it the most versatile conference table on the market. And if there is one thing that is usually required of meeting rooms, it is the ability to accommodate many different uses.

OPTIONS, OPTIONS, AND MORE OPTIONS

Speaking of versatility – VIRTU Conferencing Tables offers a huge selection:

- 12 table top shapes, each in a large range of sizes.
- 4 edge profile options.
- 7 table base styles, each with built-in wire management.
- 4 wood species: Maple, Cherry, Walnut and Anigre.
- 15 wood finishes
- a large array of Connexus™ configurations, and the option to order as a Blank module and configure on-site.
- Connexus™ modules that can be specified in a range of locations on table tops, to provide the desirable location for, and quantity of, power interfaces.

VIRTU features numerous complimentary pieces, including Media Cabinets, Display Cabinets, Lecterns, Visual Boards, Buffets, Credenzas, Storage Cabinets, Bookcases, and Mobile Media and Server Carts.

VIRTU AND VIDEOCONFERENCING

VIRTU has been designed to accommodate all the latest in videoconference applications, and can be reconfigured with off-the-shelf components as needs and office technology change. The following are the fundamental principles of videoconferencing that were incorporated into the thinking of creating VIRTU – which we feel successfully supports a multitude of videoconferencing environments.

VIDEOCONFERENCING DEFINED

Videoconferencing is the use of audio, video and data communications to enable groups to interact without being in the same geographic location. Many companies have found they cannot afford the down time and considerable cost of mobilizing their staff for face-to-face meetings. To optimize the videoconferencing experience, the right environment must be created to support both the participants and the technology.

VISUAL COMPONENTS

Cameras that are used to convey images are very sensitive to movement. When too much motion is captured, it creates a backlog of images. These images are then compressed which causes the system to drop frames and/or compromise the spatial resolution in an effort to keep up with the participants. This leads to a disjointed broadcast and pixilated images.

To prevent this disruption several things can be done. First, ensure that the camera is situated on a flat, stable surface. Next, eliminate all extraneous motion. This means everything from clocks to people walking in the background. The only backdrop to videoconferencing should be a blank wall of neutral color.

Since eye contact is an important part of the videoconferencing experience it is vital that the camera not be placed too far away from the participants. In a group setting the technology being used today mandates that users not be more than 10 feet from the camera. This fact will limit the size of the room being used for group meetings: a 12 or 13 foot long room allows for optimal visuals and provides enough room for six or seven participants to be seated around a conference table. Furthermore, sitting too close to the source will lead to a fisheye effect and a distorted image.

All participants should be visible to the camera, so a traditional seating arrangement (rectangular, straight line) will not work. To ensure that all group members are included in the telecast, a table that staggers the sight line of the camera is suggested. The ideal shape has one end narrower than the other and is long enough to place the person seated at the back no more than 10 feet from the camera. To help simulate a more natural face-to-face meeting, it is typical to employ the use of two monitors in a videoconferencing room. The use of two monitors allows the participants to view not only those positioned off-site, but themselves. By placing these monitors side by side a focal point is created that keeps the group's attention.

To have all the participants focused on one point in the room is key. This allows for the camera to capture the faces of the assembled group. Face time is essential in videoconferencing so the speaker can be easily identified. Aside from simulating a natural "physical" environment it also keeps the pace of the conversation moving forward and eliminates the need for disruptive introductions throughout the conference.

The room's focal point should be the storage unit positioned at the head of the conference table. This unit should be able to house one or two monitors side by side and have a shelf above for the camera and speakers. To support these components, a PC is usually dedicated to the room to coordinate and document the meetings. Therefore, a well-ventilated storage unit that is high enough to position the camera correctly is as important as the technology itself.

To prevent poor visual tones the surroundings of the participants should be darker than they are. Darker finishes on the table and other furnishings will allow the camera to be more effective; walls should be neutral. Fluorescent lighting creates hot spots, so use incandescent lighting whenever possible. Furthermore, glare and reflections from windows and glass frames throw the image off. The room should have dark blinds for all windows; glass surfaces (dry erase boards, framed pictures) should be situated on side walls rather than the background.

AUDIO COMPONENTS

The audio portion of videoconferencing is comprised of two physical components: the microphone and speakers. The microphone picks up the voices of the participants and should be placed an equal distance from all group members to prevent a dominant voice from overwhelming the meeting. Tabletop microphones are the most common and can be easily moved to accommodate the number of participants in each meeting. Some form of surface wire management should be in place to facilitate the installation and removal of the microphone.

To eliminate sound distortion and echo, the conference room should have soft furnishings such as: upholstered seating, carpeting and ceiling tiles. Plastic and mesh chairs reduce acoustical quality and range. Acoustical panels are also suggested for rooms in constant use. The location of the room is also important. The ideal room is not located near a main thoroughfare where people will often stop and chat, creating unnecessary background noise. Moreover, all air ducts should be well insulated to avoid "white noise."

TECHNOLOGY SUPPORT FURNITURE

The table in use should adapt to the requirements of each conference by including tabletop access to power and data. These "ports" allow conference participants to position a microphone, telephone or laptop on the table without stringing wires from the table to the wall. This helps keep the focus on the meeting, allows information to be shared more readily, and protects wires from both feet and chair casters. Also, with plug and play ability, the room can be reconfigured to fit the requirements of each meeting and its participants.

The tabletop interface should provide power and data outlets beneath a removable, protective cover; this will prevent any spilled liquids or cleanser from entering the wiring cavity. The cover should provide enough room for the wires to enter the cavity below without force or threading. The interface itself should be placed at an angle to allow an ease of use and prevent data wires from crimping and denigrating their capacity to deliver information.

The faceplates that cover the interface should be universal and reconfigurable to adapt to frequent technology and network upgrades. The interface should be accessible from below so that the back panel and electrical module itself can be switched out as easily as the faceplates. Access to the bases through removable panels should allow for the easy management of wiring to the interface itself or the module into which it is wired. This not only keeps the wires hidden from view, but also protects wiring from exterior elements. Bases can provide an opening to the floor where wires can be routed to the underside of the table. A table leg with a channeling insert can make the same connection.

Any storage unit housing monitors, cameras, speakers and computers must have a wire management system in place. This should include oversized grommets leading from one level to another and ventilation to the back to promote air circulation and release the heat generated by electronics. The grommets should be easily accessible so that retrofits, upgrades and maintenance can take place on a regular basis. Access to the wall behind the housing is also advisable so that faceplates in the wall can be reached without moving the entire unit.

VIRTU | FEATURES & OPTIONS

METAL FINISH OPTIONS

Metal components of VIRTU are available in a Satin Aluminum finish. This encompasses all metal hardware with the exception of glass door frames, and Connexus™ Faceplate components which are only available in Satin Aluminum finish. Please specify Metal Finish Option on purchase order.

PULLS

Pulls are located on all drawer fronts and all wood or glass storage and display doors. Pulls are shipped installed on the interior of doors to prevent any damage.

SOLIDS

All Conference top edges, except Fino, have 1 3/8" wide laminated solid Maple or Cherry headers. Fino edges are 5/16" wide. Edges on casegoods are 5/16" wide as well. Where Anigre is the veneer species chosen, edges are of solid Maple. All solids used are Maple or Cherry, kiln dried by Krug to a 6% moisture content.

VENEER

Veneers are #1 grade flat sliced Anigre, Maple, Cherry or Walnut and of uniform color and grain pattern.

FINISH

All finished surfaces are well sanded before applying finishing materials. The procedure begins by applying a base color via an NGR stain. A wash coat follows to further enhance the color. Next is the glazing process, which provides the 3rd color step and fills the pores of the wood. A sealer coat is then applied, twice to the horizontal worksurfaces to enhance the finish. The product is then scuff sanded to prepare for the top coat. The top coat is a catalyzed varnish that when dry has a sheen value of 32°. Krug's catalyzed varnish has been tested to be one of the industry's most durable and long lasting. Custom finishes are available at an upcharge of 10% list per unit.

GABLES

Gables are 3/4" thick – 45 lbs per cubic foot density particleboard core, 3 ply. Edges are banded with veneer.

GLASS SURFACES

All vertical and horizontal glass surfaces are tempered and frosted. For proper cleaning of all glass surfaces, Windex™ brand cleaning solution is recommended. Horizontal tempered and frosted glass surfaces are 10 mm thick.

HALOGEN LIGHTING

Halogen lighting is optional in both Small and Large Display Cabinets with glass shelving. The standard is one light per unit at a price of **\$555 list**.

LOCKS

Locks are optional on a selection of cabinets and must be specified at time of order. Locks are only available on wood doors at **\$152 list** per lock mechanism.

LEVELING LEG

Standard on all cabinets is a unique leveling leg – a metal casing moves up to allow for access to a glide, then neatly drops into place around the glide, concealing it from view. The glide can be adjusted 5/8".

GLIDES

Adjustable glides are installed on conference table bases at factory and allow for 5/8" of adjustment.

CASTERS

Locking casters are standard on the Server and Media Carts. Casters may be specified as an option on Dual Media Cabinets and on Small Media Cabinets at a price of **\$208 list** per unit.

LAMINATES

Laminate worksurfaces are available at an upcharge of 10%. Specialty laminates may be priced higher.

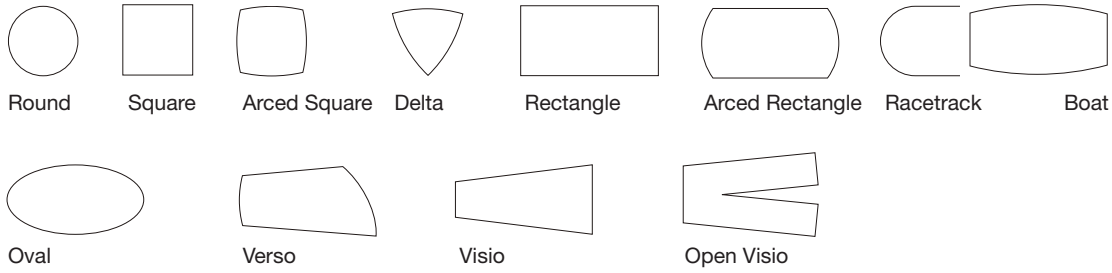
HINGES

All hinges on VIRTU cases are European style chrome with 3-way adjustment and quick release. Openings on all doors are 95 degrees, with the exception of upper doors on Media Cabinets and Visual Boards, which feature an opening of 165 degrees (upper pocket doors on Media Cabinets open to 95 degrees). Synch doors are mounted on ball bearing slides and open to a 38" expanse. Bi-fold doors on Dual Media Cabinets are mounted on interior control arms which allow the doors to open in a 165 degree controlled arc. The small access door on the back of the Mobile Media Cart features a touch latch with a free swing hinge.

TESTING INFORMATION

All product has been tested in accordance with ANSI/BIFMA X5.5-2014 or X5.9-2012.

TABLE TOP STYLES



Verso, Visio and Open Visio tops feature unique shapes that are ideal for presentations and videoconferencing. Presenters are easily seen and heard by those seated, and television monitors are unobstructed to the audience as well. The typical camera location, centered over the monitor at the front of the room, can easily scan all of the participants seated down the length of the table.

SEATING CAPABILITIES

Estimated seating capacity for each table top size can be found in the Conference Top section. To establish seating capacities, an outside chair dimension of 24" has been used, plus an allowance of 5" between chairs, for a total of 29". This is an approximation and based on seating with 5 prong bases. When using chairs with different specifications be sure to adjust the approximate seating capacity accordingly. Since not all manufacturers use this same seating formula, when a seating capacity is in question, please contact Krug Customer Service to review the specific seating that is being used with Krug Conference product.

EDGE PROFILES – CONFERENCE TOPS

VIRTU conference product offers 12 table tops in Anigre, Maple, Cherry and Walnut, with 4 distinct edge profiles, with a top thickness of 1 1/2". Please specify an edge profile for all VIRTU conference tops. Please note that the edge width (measurement from end of table veneer to the end of table edge) on Vita, Vero and Lineo is 1 3/8". Fino edge width is 3/8".

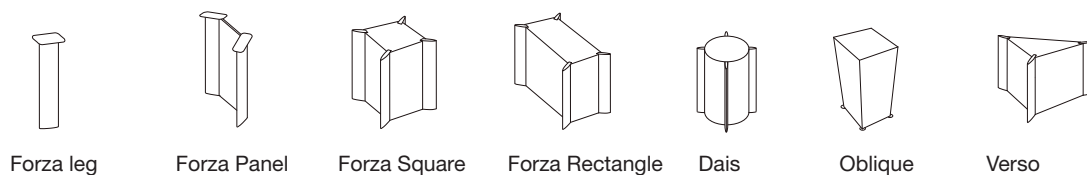


Edge Profiles – Caseworks

VIRTU casework surfaces feature the Fino profile at 1 1/8" thickness.

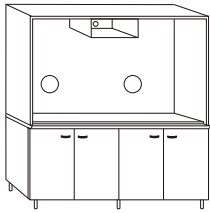


BASE STYLES



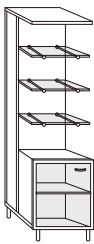
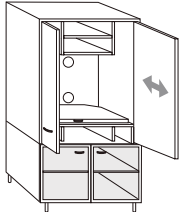
Seven base styles allow for numerous conference table configurations. The five enclosed bases allow for total concealment of wiring when floor monuments are located underneath. These bases also provide plenty of leg room around the perimeter of conference tables. Enclosed bases include 72 lbs. of ballast inside of the bases to provide enhanced table stability. Forza Panel and Forza Leg bases give users an abundance of space underneath the middle of the table, as these bases are positioned near to the table ends. Wood elements on bases will be finished in the same finish as the top if no finish is specified. Metal elements are available in Satin Aluminum finish. All bases are shipped separately and require assembly to the selected top.

VIRTU | FEATURES & OPTIONS



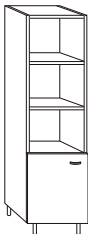
MEDIA CABINETS

- Media Cabinets are available in three sizes.
- Dual Media Cabinets accommodate two televisions up to 35" in width.
- Large cabinets accommodate televisions up to 35" in width. Small cabinets up to 27" in width.
- Cabinets may be specified with wood veneer doors or with frosted glass in aluminum frames.
- Large cabinets feature synchronized upper doors, pocket doors or hinged doors that open 170 degrees.
- Optional wood or glass doors.
- All horizontal levels of the cabinet interior are accessible through grommets in the rear of each shelf - additional holes are located in the case back for wall entry of power and cables.
- Locks are optional on wood doors only.
- Unique leveling glides adjust to uneven floors without exposing the glide.
- Optional Rollout Equipment Rack and Cable Carrier in the lower portion of the cabinet is available with the Large model at **\$3188 list**.
- Dual Media Cabinets and Small Media Cabinets are available with heavy duty locking casters at a price of **\$208 list** per unit.
- Upper shelf accommodates videoconferencing camera.



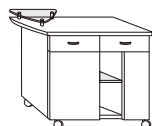
DISPLAY CABINETS

- Available as single or double widths.
- Some units come equipped with wardrobes located behind the front display cabinets.
- Wardrobes on 21" wide Display Cabinets are equipped with 3 coat hooks.
- Wardrobes on 42" wide Display Cabinets are equipped with a hanger bar.
- All wardrobes have a rubber floor mat.
- Available with open glass or wood veneer shelf options.
- Available with wood veneer doors or glass doors.
- Interior wood shelves are height adjustable in increments of 1 1/4".
- Glass shelved units feature a halogen light at a price of **\$582**.
- Glass shelves are 7.8" deep. Wood shelves are 11.8" deep.
- Open shelves are glass.
- Closed shelves are wood veneer.
- Locks are optional on wood doors only.
- Unique leveling glides adjust to uneven floors without exposing the glide.
- Single and double wardrobe units are available.
- Glass shelves are shipped wrapped in foam and secured to the front of the case.



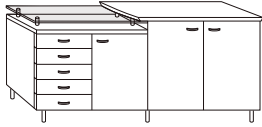
STORAGE CABINETS

- Available in single and double widths.
- Locks are optional on wood doors only.
- Available with wood veneer doors or glass doors.
- Shelves are height adjustable in increments of 1 1/4".
- Unique leveling glides adjust to uneven floors without exposing the glide.



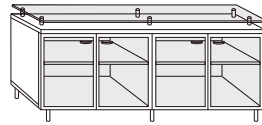
SERVER CARTS

- A unique raised glass platform and rear overhang provide a guest "serving" area.
- The cart is mounted on heavy-duty locking casters.
- The top surface overhang and underside finger groove facilitate movement of the cart.
- The cart features a stainless steel refuse container and black felt cutlery insert.
- Glass shelves are shipped wrapped in foam and placed securely in the case.



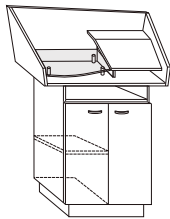
CREDENZAS AND BUFFETS

- 3 styles of cabinet tops are available: wood top, glass top and glass and wood combination.
- Doors are available in glass and wood veneer.
- Storage sections feature one wooden shelf which is height adjustable in increments of 1 1/4".
- Unique leveling glides adjust without exposing the glide.
- Buffets with wood drawers feature a black felt cutlery insert.
- Buffet may be specified with optional Mini Refrigerator on 24" deep Buffets at a price of **\$2638 list**.
- Mini refrigerator features volume of 1.1 cu. ft., 2 inner door racks, automatic defrost, and lock.
- Credenzas and Buffets with partial glass tops are shipped with glass installed.
- Credenzas and Buffets with full glass tops are shipped unattached with glass wrapped in foam.



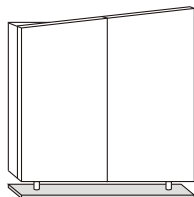
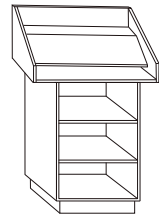
MOBILE MEDIA CARTS

- The primary cart surface can accommodate a keyboard or laptop, which in turn can be connected to a TV or monitor on upper surface.
- The top surface overhang and underside finger groove facilitate movement of the cart.
- A built-in power bar and cable slot in the upper column provide ready access to power.
- The unit is oriented to provide the correct position for the presenter.
- The cart may be specified with one or two equipment shelves on the top of the unit.
- Media Carts will generally accommodate monitors up to 27" in size.



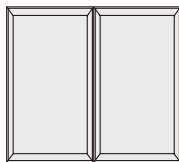
LECTERNS

- Glass shelf version has a wood upper flat shelf which provides a place for pens, pencils or a glass of water, and optional reference light at a price of **\$465 list**. It will also accommodate a user-specified microphone.
- Angled wood shelf has a bottom lip to hold papers in place. The shelf lifts to reveal an optional power and data interface point – an Altinex box at a price of **\$1336 list**.
- Glass shelf provides more surface area for equipment such as a laptop. A presenter's open laptop is not visible to the seated audience.
- Wires from the interface point, (or user supplied cables) are routed down through grommets holes to the back of the unit - to facilitate routing and access to these cables, a hinged back access door opens to reveal a cableway and optional power bar at a price of **\$208 list**.
- Full width shelf version is available.
- Lecterns are available with front hinged doors or open shelves.
- Mobile versions are available.
- Glass shelf is shipped installed.



VISUAL BOARDS

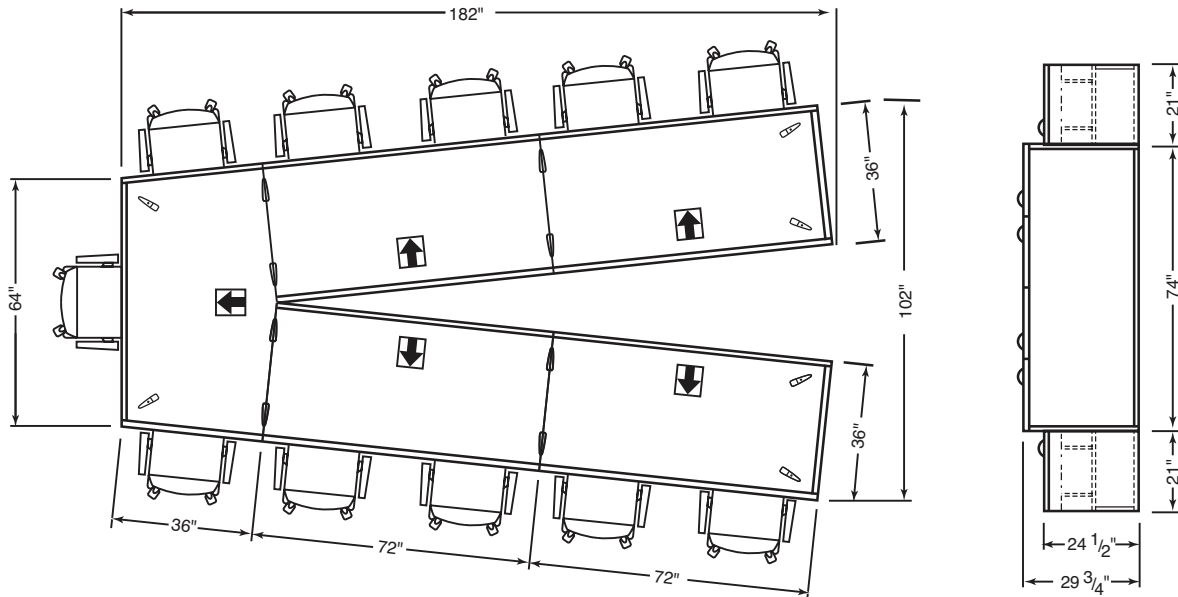
- Includes white board for use with four dry erase markers.
- Includes upholstered tackboard or optional cork surface on inside face of doors (except glass door version).
- Flip chart and four dry erase markers (except glass door version).
- Optional pull-down projector screen is available at a price of **\$278 list**.
- Inclined top model features lower glass shelf.



VIRTU | CONFERENCE ROOM SAMPLE LAYOUTS

OPEN VISIO

This table is available with seating capacities ranging from 9 to 15. The example shows the table in relation to the Dual Media Cabinet and Display Cabinets (with wardrobes). This Media Cabinet accommodates two 35" monitors side by side and other audio/visual equipment for videoconferencing or other presentation requirements. The table bases are Forza Leg bases. Connexus™ modules are indicated in standard locations.

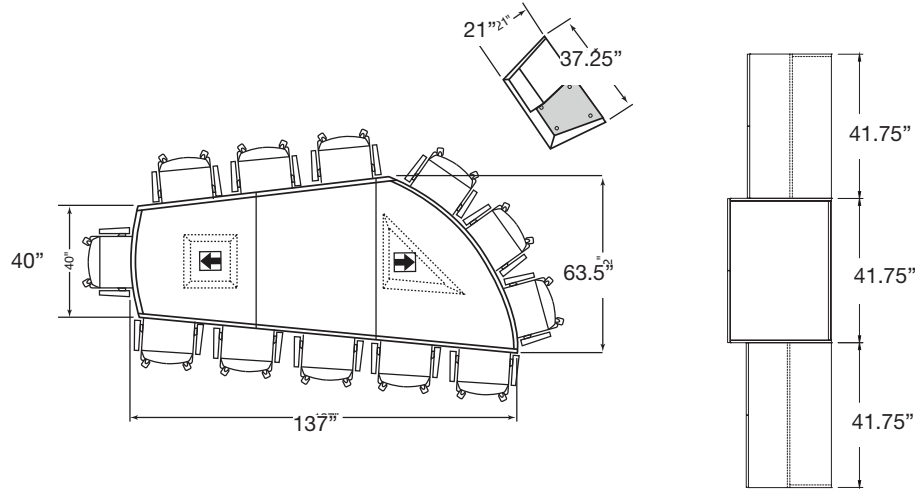


	Model Number	Cherry/Maple/Walnut	Anigre
1 Open Visio Top	6260-182-102-64	23862	25883
14 Forza Leg Bases	6238-29		
5 Connexus™ - Aluminum	62CON	5717	5717
1 Dual Media Cabinet	62MC-75307614	13146	14185
1 Display Cabinet	62DC-21247672L	4392	5053
1 Display Cabinet	62DC-21247672R	4392	5053
TOTAL (totals do not include seating)		74378	\$78,762

VIRTU | CONFERENCE ROOM SAMPLE LAYOUTS

VERSO

This table is available with seating capacities ranging from 9 to 14. The example shows the table in relation to a Large Media Cabinet and Double Display Cabinets (with wardrobes) and Lectern. This Media Cabinet accommodates a 35" monitor and other audio/visual equipment for video-conferencing or other presentation requirements. The table bases are Forza Square and Verso bases. Connexus™ modules are indicated in standard locations.



Model Number

1 Verso Top	6258-137-63-40
1 Forza Square Base	6234-14-14-29
1 Verso Base	6231-18-19-29

Cherry/Maple/Walnut

2286

Anigre

2286

2 Connexus™ - Aluminum	62CON
1 Large Media Cabinet	62MC-42308514A
1 Double Display Cabinet	62DC-42247671L
1 Double Display Cabinet	62DC-42247671R
1 Lectern	62LN-37225011

8412

9674

6182

7107

6182

7107

6974

8017

TOTAL

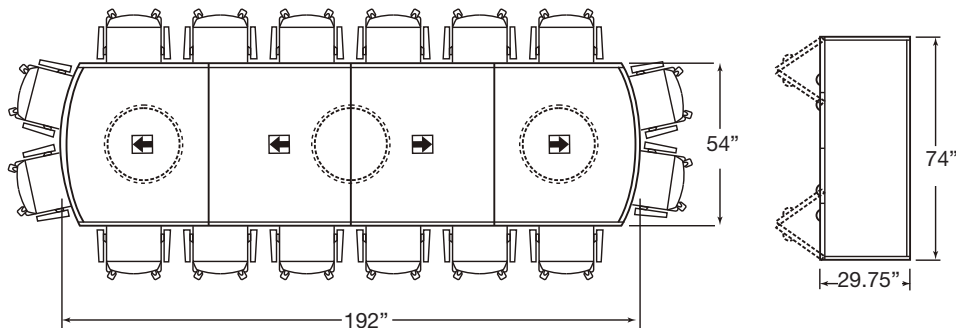
(totals do not include seating)

38451

\$43,869

ARCED RECTANGLE

This table is available with seating capacities ranging from 6 to 20. The example shows the table in relation to the Dual Media Cabinet. This Media Cabinet accommodates two 32" monitors side by side and other audio/visual equipment for videoconferencing or other presentation requirements. The table bases are Dais bases. Connexus™ modules are indicated in standard locations.



1 Arced Rectangle Top
3 Dais Bases

Model Number

6256-192-54
6230-24D-29

Cherry/Maple/Walnut

16235

Anigre

18617

4 Connexus™ - Aluminum
1 Dual Media Cabinet (bi-fold doors)

62CON
62MC-75307614

5355

5355

13146

14185

TOTAL

(totals do not include seating)

50801

\$54,223

VIRTU | CONFERENCE TABLE SPECIFICATIONS

Description	Top Size	Approximate Seating	No. of Sections	Shipping Weight	Cubic Feet
Conference Table Top – Rectangle 6251	72-36	6	1	100	10.7
	84-42	6	1	140	15
	96-42	8	2	180	16.8
	96-48	8	2	200	18.8
	120-48	10	3	240	24.2
	120-54	10	3	265	26.5
	144-54	12	3	310	28.2
	168-54	12	4	355	36.8
	192-54	14	4	400	41.2
	216-60	16	5	490	53.2
	240-60	18	5	560	58
	264-60	20	6	630	64.8
	288-60	22	6	700	69.6

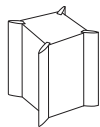


Conference tables up to and including 168" in length are available on the KrugExpress quick ship program.

Description	Base Size	W	D	H	Shipping Weight	Cubic Feet
Forza Leg Base 6238	29	6	n/a	28	15	0.9



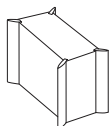
Forza Square 6234	14-14-29	14	14	28	177	6.5
-------------------	----------	----	----	----	-----	-----



Forza Panel Base 6232	24-29	24	n/a	28	54	5.5
	30-29	30	n/a	28	56	6.4



Forza Rectangle Base 6233	13-30-29	13	30	28	126	10.8
---------------------------	----------	----	----	----	-----	------



DIMENSION KEY

L – length
W – width
H – height

Model numbers represent nominal dimensions only. Contact Customer Service if dimensions are critical.

SPECIAL FEATURES

Conference tops are designed to accommodate microphones, which can be field installed. Please contact Customer Service for more information on where they can be positioned. Custom table sizes are available. Please contact Customer Service or your local Krug representative.


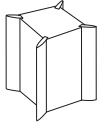

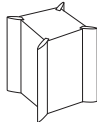
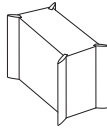
“Base Size” represents wood dimensions and does not include metal accents. Please contact Customer Service if dimensions are critical.

Bookmatched Birdseye Maple veneer is available on VIRTU Conference Table Tops at an upcharge of **\$76 list** per square foot.

Conference tops may be ordered with a reduced number of sections at an upcharge. Please contact Customer Service or your local Krug representative for details.

VIRTU | CONFERENCE TABLE PRICING AND MODEL NUMBERS

Shown below are model numbers and pricing for VIRTU conference tops and bases. The pricing is the combined price of the top and the base(s) that are cross-referenced in the chart. Please note that some bases are not available on all tops. Only the top and base combinations listed are available. When ordering, please specify the model number of the top, the model number(s) of the base(s), followed by their combined price. See bottom page for Conference Table Ordering Procedure.

Rectangle Table Top 6251	GROUP 1				GROUP 2					
	FORZA LEG 6238	FORZA SQUARE 6234	PRICE FOR TOP AND BASE(S)	PRICE FOR TOP AND BASE(S)	FORZA PANEL 6232	FORZA SQUARE 6234	FORZA RECT. 6233	PRICE FOR TOP AND BASE(S)	PRICE FOR TOP AND BASE(S)	
										
MODEL #	6238-29	6234-14-14-29	MAPLE/ CHERRY/ WALNUT	ANIGRE	6232-24-29	6232-30-29	6234-14-14-29	6233-13-30-29	MAPLE/ CHERRY/ WALNUT	ANIGRE
	QTY	QTY			QTY	QTY	QTY	QTY		
6251-72 - 36	4		4890	5468	2				5658	6505
6251-84 - 42	4		5993	6733	2				6757	7770
6251-96 - 42	4		6463	7268	2				7227	8307
6251-96 - 48	4		6931	7816	2				7697	8847
6251-120 - 48	4	+ 1	9435	10698	2		+ 1		10202	11818
6251-120 - 54	4	+ 1	10048	11404		2	+ 1		10884	12520
6251-144 - 54	4	+ 1	11169	12695		2		+ 1	12417	14282
6251-168 - 54	4	+ 2	14238	16220		2		+ 1	14202	16332
6251-192 - 54	4	+ 2	15207	17335		2		+ 2	16866	19396
6251-216 - 60	4	+ 3	18159	20738		2		+ 2	18538	21318
6251-240 - 60	4	+ 3	19635	22435		2		+ 2	20013	23016
6251-264 - 60	4	+ 4	22389	25608		2		+ 2	21483	24706
6251-288 - 60	4	+ 4	23872	27312		2		+ 3	24665	28361

ORDERING PROCEDURE

Please specify the following:

1. Select Table Top shape, size, model number and wood species.
2. Select Table Base(s), size, model number, quantity and wood species.
3. Obtain Table Price by cross-referencing selected top with selected base(s). The prices listed are the combined total of the top and base(s).
4. Select Connexus™ Module(s) and a Location Code for either a Glass or Satin Aluminum module.
Add pricing for the selected Connexus™ Module(s) to the table price.
5. Select Monument Location(s) and provide monument location code(s) on purchase order.
6. Select a Wood Finish
7. Select an Edge Profile.

Model numbers represent nominal dimensions only (in inches). Contact Customer Service if dimensions are critical.

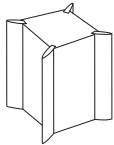
VIRTU | CONFERENCE TABLE SPECIFICATIONS

Description	Top Size	Approximate Seating	No. of Sections	Shipping Weight	Cubic Feet
Conference Table Top – Rectangle 6251	84-42	6	1	140	15
	96-42	8	2	180	16.8
	96-48	8	2	200	18.8
	120-48	10	3	240	24.2
	120-54	10	3	265	26.5
	144-54	12	3	310	28.2
	168-54	12	4	355	36.8
	192-54	14	4	400	41.2
	216-60	16	5	490	53.2
	240-60	18	5	560	58
	264-60	20	6	630	64.8
	288-60	22	6	700	69.6

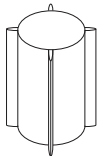


Conference tables up to and including 168" in length are available on the KrugExpress quick ship program.

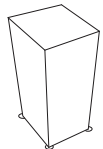
Description	Base Size	W	D	H	Shipping Weight	Cubic Feet
Forza Square Base 6234	14-14-29	14	14	28	177	6.5
	20-20-29	20	20	28	199	10.9
	26-26-29	26	26	28	225	17.6



Dais Base 6230	18D-29	18 dia.	n/a	28	149	6.5
	24D-29	24 dia.	n/a	28	171	10.9
	30D-29	30 dia.	n/a	28	196	17.6



Oblique Base 6237	18-18-29	18	18	28	149	6.5
	24-24-29	24	24	28	171	10.9
	30-30-29	30	30	28	196	17.6



DIMENSION KEY

L – length
W – width
H – height

Model numbers represent nominal dimensions only. Contact Customer Service if dimensions are critical.

SPECIAL FEATURES

Conference tops are designed to accommodate microphones, which can be field installed. Please contact Customer Service for more information on where they can be positioned. Custom table sizes are available. Please contact Customer Service or your local Krug representative.

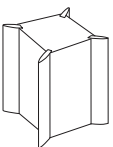
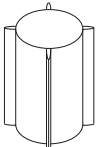
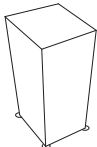
“Base Size” represents wood dimensions and does not include metal accents. Please contact Customer Service if dimensions are critical.

Bookmatched Birdseye Maple veneer is available on VIRTU Conference Table Tops at an upcharge of **\$76 list per square foot**.

Conference tops may be ordered with a reduced number of sections at an upcharge. Please contact Customer Service or your local Krug representative for details.

VIRTU | CONFERENCE TABLE PRICING AND MODEL NUMBERS

Shown below are model numbers and pricing for VIRTU conference tops and bases. The pricing is the combined price of the top and the base(s) that are cross-referenced in the chart. Please note that some bases are not available on all tops. Only the top and base combinations listed are available. When ordering, please specify the model number of the top, the model number(s) of the base(s), followed by their combined price. See bottom page for Conference Table Ordering Procedure.

Rectangle Table Top 6251	GROUP 3					GROUP 4					GROUP 5					
	FORZA SQUARE 6234 			PRICE FOR TOP AND BASE(S)	PRICE FOR TOP AND BASE(S)	DAIS 6230 			PRICE FOR TOP AND BASE(S)	PRICE FOR TOP AND BASE(S)	OBLIQUE 6237 			PRICE FOR TOP AND BASE(S)	PRICE FOR TOP AND BASE(S)	
	MODEL #	6234-14- 14-29 QTY	6234-20- 20-29 QTY	6234-26- 26-29 QTY	MAPLE/ CHERRY/ WALNUT	ANIGRE	6230- 18D-29 QTY	6230- 24D-29 QTY	6230- 30D29 QTY	MAPLE/ CHERRY/ WALNUT	ANIGRE	6237-18- 18-29 QTY	6237-24- 24-29 QTY	6237-30- 30-29 QTY	MAPLE/ CHERRY/ WALNUT	ANIGRE
6251-72 - 36	2			6408	7377				6496	7472						
6251-84 - 42	2			7507	8077	2			7599	8739	2			7424	8535	
6251-96 - 42	2			7973	9179	2			8064	9273	2			7891	8613	
6251-96 - 48	2			8445	9721	2			8535	9817	2			8366	9616	
6251-120-48	2			9667	11125	2			9756	11219	2			9581	11018	
6251-120-54		2		10480	12034		2		10456	12028		2		10281	11820	
6251-144-54		2		11599	13326		2		11579	13319		2		11406	13112	
6251-168-54		3		14764	16962		3		14731	16945		3		13188	16637	
6251-192-54		3		15732	18072		3		15699	18061		3		14157	17751	
6251-216-60			3	17659	19994			3	17500	20129			3	17241	19831	
6251-240-60			4	20606	23695			4	20391	23457			4	20046	23052	
6251-264-60			4	22074	25386			4	21859	25147			4	20105	24744	
6251-288-60			4	23558	27090			4	23344	26852			4	21514	26449	

ORDERING PROCEDURE

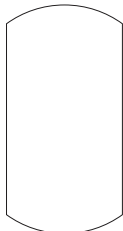
Please specify the following:

1. Select Table Top shape, size, model number and wood species.
2. Select Table Base(s), size, model number, quantity and wood species.
3. Obtain Table Price by cross-referencing selected top with selected base(s). The prices listed are the combined total of the top and base(s).
4. Select Connexus™ Module(s) and a Location Code for either a Glass or Satin Aluminum module.
Add pricing for the selected Connexus™ Module(s) to the table price.
5. Select Monument Location(s) and provide monument location code(s) on purchase order.
6. Select a Wood Finish
7. Select an Edge Profile.

Model numbers represent nominal dimensions only (in inches). Contact Customer Service if dimensions are critical.

VIRTU | CONFERENCE TABLE SPECIFICATIONS

Description	Top Size	Approximate Seating	No. of Sections	Shipping Weight	Cubic Feet
Conference Table Top – Arced Rectangle 6256	72-36	6	1	100	10.7
	84-42	6	1	140	15
	96-42	8	2	180	16.8
	96-48	8	2	200	18.8
	120-48	10	3	240	24.2
	120-54	10	3	265	26.5
	144-54	12	3	310	28.2
	168-54	12	4	355	36.8
	192-54	14	4	400	41.2
	216-60	16	5	490	53.2
	240-60	18	5	560	58
	264-60	20	6	630	64.8
	288-60	22	6	700	69.6

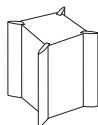


Conference tables up to and including 168" in length are available on the KrugExpress quick ship program.

Description	Base Size	W	D	H	Shipping Weight	Cubic Feet
Forza Leg Base 6238	29	6	n/a	28	15	0.9



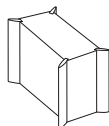
Forza Square 6234	14-14-29	14	14	28	177	6.5
-------------------	----------	----	----	----	-----	-----



Forza Panel Base 6232	24-29	24	n/a	28	54	5.5
	30-29	30	n/a	28	56	6.4



Forza Rectangle Base 6233	13-30-29	13	30	28	126	10.8
---------------------------	----------	----	----	----	-----	------



DIMENSION KEY

L – length
W – width
H – height

Model numbers represent nominal dimensions only. Contact Customer Service if dimensions are critical.

SPECIAL FEATURES

Conference tops are designed to accommodate microphones, which can be field installed. Please contact Customer Service for more information on where they can be positioned. Custom table sizes are available. Please contact Customer Service or your local Krug representative.


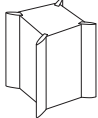
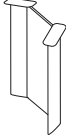
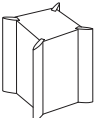
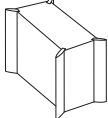
“Base Size” represents wood dimensions and does not include metal accents. Please contact Customer Service if dimensions are critical.

Bookmatched Birdseye Maple veneer is available on VIRTU Conference Table Tops at an upcharge of **\$76 list per square foot**.

Conference tops may be ordered with a reduced number of sections at an upcharge. Please contact Customer Service or your local Krug representative for details.

VIRTU | CONFERENCE TABLE PRICING AND MODEL NUMBERS

Shown below are model numbers and pricing for VIRTU conference tops and bases. The pricing is the combined price of the top and the base(s) that are cross-referenced in the chart. Please note that some bases are not available on all tops. Only the top and base combinations listed are available. When ordering, please specify the model number of the top, the model number(s) of the base(s), followed by their combined price. See bottom page for Conference Table Ordering Procedure.

Arced Rectangle Table Top 6256	GROUP 1				GROUP 2						
	FORZA LEG 6238	FORZA SQUARE 6234	PRICE FOR TOP AND BASE(S)	PRICE FOR TOP AND BASE(S)	FORZA PANEL 6232	FORZA SQUARE 6234	FORZA RECT. 6233	PRICE FOR TOP AND BASE(S)	PRICE FOR TOP AND BASE(S)		
											
MODEL #	6238-29	6234-14-14-29	MAPLE/CHERRY/WALNUT	ANIGRE	6232-24-29	6232-30-29	6234-14-14-29	6233-13-30-29	MAPLE/CHERRY/WALNUT	ANIGRE	
	QTY	QTY			QTY	QTY	QTY	QTY			
6256-72 - 36	4		5054	5656	2				5814	6688	
6256-84 - 42	4		6199	6973	2				6964	8007	
6256-96 - 42	4		6686	7532	2				7452	8569	
6256-96 - 48	4		7179	8094	2				7940	9131	
6256-120 - 48	4	+	9731	11037	2		+	1	10495	12072	
6256-120 - 54	4	+	10368	11775		2	+	1	11204	12890	
6256-144 - 54	4	+	11537	13119		2		+	1	12790	14707
6256-168 - 54	4	+	14680	16732		2		+	1	14642	16835
6256-192 - 54	4	+	15687	17890		2		+	2	17348	19952
6256-216 - 60	4	+	14842	21374		2		+	2	19090	21956
6256-240 - 60	4	+	20248	23144		2		+	2	20626	23723
6256-264 - 60	4	+	23062	26384		2		+	2	22157	25477
6256-288 - 60	4	+	24608	28162		2		+	3	25398	29211

ORDERING PROCEDURE

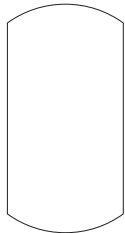
Please specify the following:

1. Select Table Top shape, size, model number and wood species.
2. Select Table Base(s), size, model number, quantity and wood species.
3. Obtain Table Price by cross-referencing selected top with selected base(s). The prices listed are the combined total of the top and base(s).
4. Select Connexus™ Module(s) and a Location Code for either a Glass or Satin Aluminum module. Add pricing for the selected Connexus™ Module(s) to the table price.
5. Select Monument Location(s) and provide monument location code(s) on purchase order.
6. Select a Wood Finish
7. Select an Edge Profile.

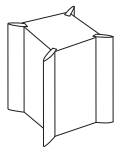
Model numbers represent nominal dimensions only (in inches). Contact Customer Service if dimensions are critical.

VIRTU | CONFERENCE TABLE SPECIFICATIONS

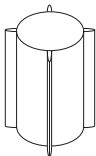
Description	Top Size	Approximate Seating	No. of Sections	Shipping Weight	Cubic Feet
Conference Table Top – Arced Rectangle 6256	84-42	6	1	140	15
	96-42	8	2	180	16.8
	96-48	8	2	200	18.8
	120-48	10	3	240	24.2
	120-54	10	3	265	26.5
	144-54	12	3	310	28.2
	168-54	12	4	355	36.8
	192-54	14	4	400	41.2
	216-60	16	5	490	53.2
	240-60	18	5	560	58
	264-60	20	6	630	64.8
	288-60	22	6	700	69.6



Description	Base Size	W	D	H	Shipping Weight	Cubic Feet
Forza Square Base 6234	14-14-29	14	14	28	177	6.5
	20-20-29	20	20	28	199	10.9
	26-26-29	26	26	28	225	17.6



Dais Base 6230	18D-29	18 dia.	n/a	28	149	6.5
	24D-29	24 dia.	n/a	28	171	10.9
	30D-29	30 dia.	n/a	28	196	17.6



Oblique Base 6237	18-18-29	18	18	28	149	6.5
	24-24-29	24	24	28	171	10.9
	30-30-29	30	30	28	196	17.6



DIMENSION KEY

L – length
W – width
H – height

Model numbers represent nominal dimensions only. Contact Customer Service if dimensions are critical.

SPECIAL FEATURES

Conference tops are designed to accommodate microphones, which can be field installed. Please contact Customer Service for more information on where they can be positioned. Custom table sizes are available. Please contact Customer Service or your local Krug representative.

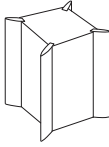
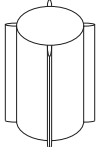
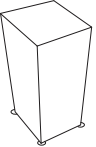
“Base Size” represents wood dimensions and does not include metal accents. Please contact Customer Service if dimensions are critical.

Bookmatched Birdseye Maple veneer is available on VIRTU Conference Table Tops at an upcharge of **\$76 list per square foot**.

Conference tops may be ordered with a reduced number of sections at an upcharge. Please contact Customer Service or your local Krug representative for details.

VIRTU | CONFERENCE TABLE PRICING AND MODEL NUMBERS

Shown below are model numbers and pricing for VIRTU conference tops and bases. The pricing is the combined price of the top and the base(s) that are cross-referenced in the chart. Please note that some bases are not available on all tops. Only the top and base combinations listed are available. When ordering, please specify the model number of the top, the model number(s) of the base(s), followed by their combined price. See bottom page for Conference Table Ordering Procedure.

Arced Rectangle Table Top 6256	GROUP 3					GROUP 4					GROUP 5				
	FORZA SQUARE 6234			PRICE FOR TOP AND BASE(S)	PRICE FOR TOP AND BASE(S)	DAIS 6230			PRICE FOR TOP AND BASE(S)	PRICE FOR TOP AND BASE(S)	OBLIQUE 6237			PRICE FOR TOP AND BASE(S)	PRICE FOR TOP AND BASE(S)
															
MODEL #	6234-14-14-29	6234-20-20-29	6234-26-26-29	MAPLE/CHERRY/WALNUT	ANIGRE	6230-18D-29	6230-24D-29	6230-30D29	MAPLE/CHERRY/WALNUT	ANIGRE	6237-18-18-29	6237-24-24-29	6237-30-30-29	MAPLE/CHERRY/WALNUT	ANIGRE
	QTY	QTY	QTY			QTY	QTY	QTY			QTY	QTY	QTY		
6256-72-36	2			6570	7566	2			6657	7656					
6256-84 - 42	2			7714	8880	2			7805	8975	2			7630	8768
6256-96 - 42	2			8197	9442	2			8290	9536	2			8118	9335
6256-96 - 48	2			8692	10001	2			8782	10096	2			8610	9895
6256-120-48	2			9962	11466	2			10050	11561	2			9880	11357
6256-120-54		2		10797	12405		2		10776	12396		2		10602	12191
6256-144-54		2		11967	13748		2		11944	13742		2		11776	13534
6256-168-54		3		15208	17468		3		15173	17456		3		14917	17143
6256-192-54		3		16214	18627		3		16235	18617		3		15926	18310
6256-216-60			3	18211	20943			3	18050	20766			3	17792	20463
6256-240-60			4	21221	24399			4	21007	24164			4	20661	23759
6256-264-60			4	22749	26161			4	22537	25922			4	22192	25519
6256-288-60			4	24295	27939			4	24081	27699			4	23739	27295

ORDERING PROCEDURE

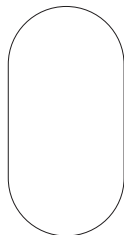
Please specify the following:

1. Select Table Top shape, size, model number and wood species.
2. Select Table Base(s), size, model number, quantity and wood species.
3. Obtain Table Price by cross-referencing selected top with selected base(s). The prices listed are the combined total of the top and base(s).
4. Select Connexus™ Module(s) and a Location Code for either a Glass or Satin Aluminum module.
Add pricing for the selected Connexus™ Module(s) to the table price.
5. Select Monument Location(s) and provide monument location code(s) on purchase order.
6. Select a Wood Finish
7. Select an Edge Profile.

Model numbers represent nominal dimensions only (in inches). Contact Customer Service if dimensions are critical.

VIRTU | CONFERENCE TABLE SPECIFICATIONS

Description	Top Size	Approximate Seating	No. of Sections	Shipping Weight	Cubic Feet
Conference Table Top – Racetrack 6252	72-36	6	1	100	10.7
	84-42	6	1	140	15
	96-42	8	2	180	16.8
	96-48	8	2	200	18.8
	120-48	10	3	240	24.2
	120-54	10	3	265	26.5
	144-54	12	3	310	28.2
	168-54	12	4	355	36.8
	192-54	14	4	400	41.2
	216-60	16	5	490	53.2
	240-60	18	5	560	58
	264-60	20	6	630	64.8
	288-60	22	6	700	69.6

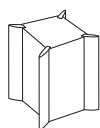


Conference tables up to and including 168" in length are available on the KrugExpress quick ship program.

Description	Base Size	W	D	H	Shipping Weight	Cubic Feet
Forza Leg Base 6238	29	6	n/a	28	15	0.9



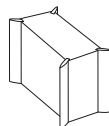
Forza Square 6234	14-14-29	14	14	28	177	6.5
-------------------	----------	----	----	----	-----	-----



Forza Panel Base 6232	24-29	24	n/a	28	54	5.5
	30-29	30	n/a	28	56	6.4



Forza Rectangle Base 6233	13-30-29	13	30	28	126	10.8
---------------------------	----------	----	----	----	-----	------



DIMENSION KEY

L – length
W – width
H – height

Model numbers represent nominal dimensions only. Contact Customer Service if dimensions are critical.

SPECIAL FEATURES

Conference tops are designed to accommodate microphones, which can be field installed. Please contact Customer Service for more information on where they can be positioned. Custom table sizes are available. Please contact Customer Service or your local Krug representative.


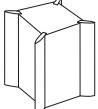

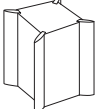
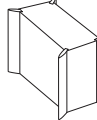
“Base Size” represents wood dimensions and does not include metal accents. Please contact Customer Service if dimensions are critical.

Bookmatched Birdseye Maple veneer is available on VIRTU Conference Table Tops at an upcharge of **\$76 list per square foot**.

Conference tops may be ordered with a reduced number of sections at an upcharge. Please contact Customer Service or your local Krug representative for details.

VIRTU | CONFERENCE TABLE PRICING AND MODEL NUMBERS

Shown below are model numbers and pricing for VIRTU conference tops and bases. The pricing is the combined price of the top and the base(s) that are cross-referenced in the chart. Please note that some bases are not available on all tops. Only the top and base combinations listed are available. When ordering, please specify the model number of the top, the model number(s) of the base(s), followed by their combined price. See bottom page for Conference Table Ordering Procedure.

	GROUP 1				GROUP 2						
	FORZA LEG 6238 	FORZA SQUARE 6234 	PRICE FOR TOP AND BASE(S)	PRICE FOR TOP AND BASE(S)	FORZA PANEL 6232 	FORZA SQUARE 6234 	FORZA RECT. 6233 	PRICE FOR TOP AND BASE(S)	PRICE FOR TOP AND BASE(S)		
Racetrack Table Top 6252											
MODEL #	6238-29	6234-14-14-29	MAPLE/ CHERRY/ WALNUT	ANIGRE	6232-24-29	6232-30-29	6234-14-14-29	6233-13-30-29	MAPLE/ CHERRY/ WALNUT	ANIGRE	
	QTY	QTY			QTY	QTY	QTY	QTY			
6252-72 - 36	4		5634	6555	2				6603	7594	
6252-84 - 42	4		6159	6928	2				6928	7965	
6252-96 - 42	4		6484	7298	2				7250	8335	
6252-96 - 48	4		6927	7806	2				7690	8842	
6252-120 - 48	4	+	9861	11182	2		+	1	10623	12222	
6252-120 - 54	4	+	10398	11806		2	+	1	11230	12923	
6252-144 - 54	4	+	11348	12899		2		+	1	12595	14486
6252-168 - 54	4	+	14456	16476		2		+	1	14422	16582
6252-192 - 54	4	+	15437	17604		2		+	2	17098	19664
6252-216 - 60	4	+	18865	21549		2		+	2	19240	22129
6252-240 - 60	4	+	20408	23324		2		+	2	20781	23906
6252-264 - 60	4	+	23245	26592		2		+	2	22338	25693
6252-288 - 60	4	+	24448	27975		2		+	3	25242	29025

ORDERING PROCEDURE

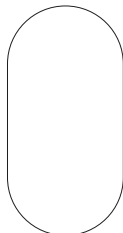
Please specify the following:

1. Select Table Top shape, size, model number and wood species.
2. Select Table Base(s), size, model number, quantity and wood species.
3. Obtain Table Price by cross-referencing selected top with selected base(s). The prices listed are the combined total of the top and base(s).
4. Select Connexus™ Module(s) and a Location Code for either a Glass or Satin Aluminum module.
Add pricing for the selected Connexus™ Module(s) to the table price.
5. Select Monument Location(s) and provide monument location code(s) on purchase order.
6. Select a Wood Finish
7. Select an Edge Profile.

Model numbers represent nominal dimensions only (in inches). Contact Customer Service if dimensions are critical.

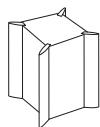
VIRTU | CONFERENCE TABLE SPECIFICATIONS

Description	Top Size	Approximate Seating	No. of Sections	Shipping Weight	Cubic Feet
Conference Table Top – Racetrack 6252	84-42	6	1	140	15
	96-42	8	2	180	16.8
	96-48	8	2	200	18.8
	120-48	10	3	240	24.2
	120-54	10	3	265	26.5
	144-54	12	3	310	28.2
	168-54	12	4	355	36.8
	192-54	14	4	400	41.2
	216-60	16	5	490	53.2
	240-60	18	5	560	58
	264-60	20	6	630	64.8
	288-60	22	6	700	69.6

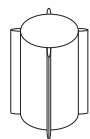


Conference tables up to and including 168" in length are available on the KrugExpress quick ship program.

Description	Base Size	W	D	H	Shipping Weight	Cubic Feet
Forza Square Base 6234	14-14-29	14	14	28	177	6.5
	20-20-29	20	20	28	199	10.9
	26-26-29	26	26	28	225	17.6



Dais Base 6230	18D-29	18 dia.	n/a	28	149	6.5
	24D-29	24 dia.	n/a	28	171	10.9
	30D-29	30 dia.	n/a	28	196	17.6



DIMENSION KEY

L — length
W — width
H — height

Model numbers represent nominal dimensions only. Contact Customer Service if dimensions are critical.

SPECIAL FEATURES

Conference tops are designed to accommodate microphones, which can be field installed. Please contact Customer Service for more information on where they can be positioned. Custom table sizes are available. Please contact Customer Service or your local Krug representative.

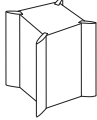
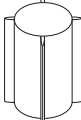
“Base Size” represents wood dimensions and does not include metal accents. Please contact Customer Service if dimensions are critical.

Bookmatched Birdseye Maple veneer is available on VIRTU Conference Table Tops at an upcharge of **\$76 list per square foot**.

Conference tops may be ordered with a reduced number of sections at an upcharge. Please contact Customer Service or your local Krug representative for details.

VIRTU | CONFERENCE TABLE PRICING AND MODEL NUMBERS

Shown below are model numbers and pricing for VIRTU conference tops and bases. The pricing is the combined price of the top and the base(s) that are cross-referenced in the chart. Please note that some bases are not available on all tops. Only the top and base combinations listed are available. When ordering, please specify the model number of the top, the model number(s) of the base(s), followed by their combined price. See bottom page for Conference Table Ordering Procedure.

Racetrack Table Top 6252	GROUP 3					GROUP 4				
	FORZA SQUARE 6234			PRICE FOR TOP AND BASE(S)	PRICE FOR TOP AND BASE(S)	DAIS 6230			PRICE FOR TOP AND BASE(S)	PRICE FOR TOP AND BASE(S)
										
MODEL #	6234-14- 14-29	6234-20- 20-29	6234-26- 26-29	MAPLE/ CHERRY/ WALNUT	ANIGRE	6230- 18d-29	6230- 24d-29	6230- 30d-29	MAPLE/ CHERRY/ WALNUT	ANIGRE
	QTY	QTY	QTY			QTY	QTY	QTY		
6252-72 - 36	2			7355	8465	2			7445	8559
6252-84 - 42	2			7675	8836	2			7765	8933
6252-96 - 42	2			7998	9207	2			8089	9306
6252-96 - 48	2			8439	9715	2			8529	9810
6252-120-48	2			10090	11611	2			10181	11708
6252-120-54		2		10823	12440		2		10805	12430
6252-144-54		2		11778	13530		2		11754	13524
6252-168-54		3		14983	17212		3		14952	17195
6252-192-54		3		15961	18341		3		15933	18329
6252-216-60			3	18367	21121			3	18205	20942
6252-240-60			4	21381	24582			4	21165	24345
6252-264-60			4	22933	26369			4	22719	26131
6252-288-60			4	24134	27755			4	23922	27514

ORDERING PROCEDURE

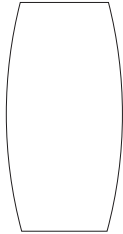
Please specify the following:

1. Select Table Top shape, size, model number and wood species.
2. Select Table Base(s), size, model number, quantity and wood species.
3. Obtain Table Price by cross-referencing selected top with selected base(s). The prices listed are the combined total of the top and base(s).
4. Select Connexus™ Module(s) and a Location Code for either a Glass or Satin Aluminum module.
Add pricing for the selected Connexus™ Module(s) to the table price.
5. Select Monument Location(s) and provide monument location code(s) on purchase order.
6. Select a Wood Finish
7. Select an Edge Profile.

Model numbers represent nominal dimensions only (in inches). Contact Customer Service if dimensions are critical.

VIRTU | CONFERENCE TABLE SPECIFICATIONS

Description	Top Size	Approximate Seating	No. of Sections	Shipping Weight	Cubic Feet
Conference Table Top – Boat 6254	96-48-42	8	2	185	18.8
	120-48-42	10	3	255	24.2
	144-48-42	12	3	300	28.2
	168-48-42	12	4	345	36.8
	192-54-48	14	4	390	41.2
	216-54-48	16	5	480	47.1
	240-54-48	18	5	550	51.5
	264-60-48	20	6	620	64.8
	288-60-48	22	6	690	69.6

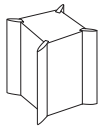


Conference tables up to and including 168" in length are available on the KrugExpress quick ship program.

Description	Base Size	W	D	H	Shipping Weight	Cubic Feet
Forza Leg Base 6238	29	6	n/a	28	15	0.9



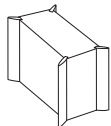
Forza Square 6234	14-14-29	14	14	28	177	6.5
-------------------	----------	----	----	----	-----	-----



Forza Panel Base 6232	24-29	24	n/a	28	54	5.5
	30-29	30	n/a	28	56	6.4



Forza Rectangle Base 6233	13-30-29	13	30	28	126	10.8
---------------------------	----------	----	----	----	-----	------



DIMENSION KEY

L – length
W – width
H – height

Model numbers represent nominal dimensions only. Contact Customer Service if dimensions are critical.

SPECIAL FEATURES

Conference tops are designed to accommodate microphones, which can be field installed. Please contact Customer Service for more information on where they can be positioned. Custom table sizes are available. Please contact Customer Service or your local Krug representative.


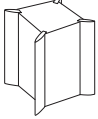

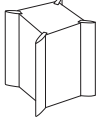
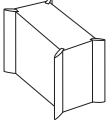
“Base Size” represents wood dimensions and does not include metal accents. Please contact Customer Service if dimensions are critical.

Bookmatched Birdseye Maple veneer is available on VIRTU Conference Table Tops at an upcharge of **\$76 list per square foot**.

Conference tops may be ordered with a reduced number of sections at an upcharge. Please contact Customer Service or your local Krug representative for details.

VIRTU | CONFERENCE TABLE PRICING AND MODEL NUMBERS

Shown below are model numbers and pricing for VIRTU conference tops and bases. The pricing is the combined price of the top and the base(s) that are cross-referenced in the chart. Please note that some bases are not available on all tops. Only the top and base combinations listed are available. When ordering, please specify the model number of the top, the model number(s) of the base(s), followed by their combined price. See bottom page for Conference Table Ordering Procedure.

Boat Table Top 6254	GROUP 1				GROUP 2					
	FORZA LEG 6238	FORZA SQUARE 6234	PRICE FOR TOP AND BASE(S)	PRICE FOR TOP AND BASE(S)	FORZA PANEL 6232	FORZA SQUARE 6234	FORZA RECT. 6233	PRICE FOR TOP AND BASE(S)	PRICE FOR TOP AND BASE(S)	
										
MODEL #	6238-29	6234-14-14-29	MAPLE/ CHERRY/ WALNUT	ANIGRE	6232-24-29	6232-30-29	6234-14-14-29	6233-13-30-29	MAPLE/ CHERRY/ WALNUT	ANIGRE
	QTY	QTY			QTY	QTY	QTY	QTY		
6254-96-48-42	4		7221	8148	2				7986	9185
6254-120-48-42	4	+ 1	10805	12273	2		+ 1		11567	13309
6254-144-48-42	4	+ 1	11806	13420	2			+ 1	12982	14929
6254-168-48-42	4	+ 2	14999	17101	2			+ 1	14896	17128
6254-192-54-48	4	+ 2	16025	18283	2			+ 2	17620	20261
6254-216-54-48	4	+ 3	19562	22351	2			+ 2	19867	22850
6254-240-54-48	4	+ 3	21181	24216	2			+ 2	21492	24713
6254-264-60-48	4	+ 4	24098	27574	2			+ 2	23122	26589
6254-288-60-48	4	+ 4	25362	29032	2			+ 3	26086	29999

ORDERING PROCEDURE

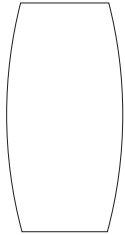
Please specify the following:

1. Select Table Top shape, size, model number and wood species.
2. Select Table Base(s), size, model number, quantity and wood species.
3. Obtain Table Price by cross-referencing selected top with selected base(s). The prices listed are the combined total of the top and base(s).
4. Select Connexus™ Module(s) and a Location Code for either a Glass or Satin Aluminum module.
Add pricing for the selected Connexus™ Module(s) to the table price.
5. Select Monument Location(s) and provide monument location code(s) on purchase order.
6. Select a Wood Finish
7. Select an Edge Profile.

Model numbers represent nominal dimensions only (in inches). Contact Customer Service if dimensions are critical.

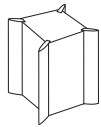
VIRTU | CONFERENCE TABLE SPECIFICATIONS

Description	Top Size	Approximate Seating	No. of Sections	Shipping Weight	Cubic Feet
Conference Table Top – Boat 6254	96-48-42	8	2	185	18.8
	120-48-42	10	3	255	24.2
	144-48-42	12	3	300	28.2
	168-48-42	12	4	345	36.8
	192-54-48	14	4	390	41.2
	216-54-48	16	5	480	47.1
	240-54-48	18	5	550	51.5
	264-60-48	20	6	620	64.8
	288-60-48	22	6	690	69.6



Conference tables up to and including 168" in length are available on the KrugExpress quick ship program.

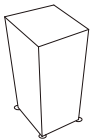
Description	Base Size	W	D	H	Shipping Weight	Cubic Feet
Forza Square Base 6234	14-14-29	14	14	28	177	6.5
	20-20-29	20	20	28	199	10.9
	26-26-29	26	26	28	225	17.6



Description	Base Size	W	D	H	Shipping Weight	Cubic Feet
Dais Base 6230	18D-29	18 dia.	n/a	28	149	6.5
	24D-29	24 dia.	n/a	28	171	10.9
	30D-29	30 dia.	n/a	28	196	17.6



Description	Base Size	W	D	H	Shipping Weight	Cubic Feet
Oblique Base 6237	18-18-29	18	18	28	149	6.5
	24-24-29	24	24	28	171	10.9
	30-30-29	30	30	28	196	17.6



DIMENSION KEY

L – length
W – width
H – height

Model numbers represent nominal dimensions only. Contact Customer Service if dimensions are critical.

SPECIAL FEATURES

Conference tops are designed to accommodate microphones, which can be field installed. Please contact Customer Service for more information on where they can be positioned. Custom table sizes are available. Please contact Customer Service or your local Krug representative.

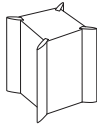
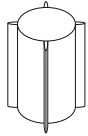
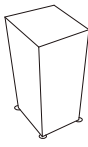
“Base Size” represents wood dimensions and does not include metal accents. Please contact Customer Service if dimensions are critical.

Bookmatched Birdseye Maple veneer is available on VIRTU Conference Table Tops at an upcharge of **\$76 list per square foot**.

Conference tops may be ordered with a reduced number of sections at an upcharge. Please contact Customer Service or your local Krug representative for details.

VIRTU | CONFERENCE TABLE PRICING AND MODEL NUMBERS

Shown below are model numbers and pricing for VIRTU conference tops and bases. The pricing is the combined price of the top and the base(s) that are cross-referenced in the chart. Please note that some bases are not available on all tops. Only the top and base combinations listed are available. When ordering, please specify the model number of the top, the model number(s) of the base(s), followed by their combined price. See bottom page for Conference Table Ordering Procedure.

Boat Table Top 6254	GROUP 3					GROUP 4					GROUP 5				
	FORZA SQUARE 6234			PRICE FOR TOP AND BASE(S)	PRICE FOR TOP AND BASE(S)	DAIS 6230			PRICE FOR TOP AND BASE(S)	PRICE FOR TOP AND BASE(S)	OBLIQUE 6237			PRICE FOR TOP AND BASE(S)	PRICE FOR TOP AND BASE(S)
															
MODEL #	6234-14- 14-29	6234-20- 20-29	6234-26- 26-29	MAPLE/ CHERRY/ WALNUT	ANIGRE	6230- 18d-29	6230- 24d-29	6230- 30d-29	MAPLE/ CHERRY/ WALNUT	ANIGRE	6237-18- 18-29	6237-24- 24-29	6237-30- 30-29	MAPLE/ CHERRY/ WALNUT	ANIGRE
	QTY	QTY	QTY			QTY	QTY	QTY			QTY	QTY	QTY		
6254-96-48-42	2			8733	10059	2			8733	10059	2			8650	9947
6254-120-48-42	3			11036	12701	2			11036	12701	2			10954	12593
6254-144-48-42	3			13319	15331	3			13319	15331	3			13198	15170
6254-168-48-42	3			15231	17529	3			15231	17529	3			15107	17370
6254-192-54-48	2	+	1	16354	18812	2	+	1	16354	18812	2	+	1	16175	18598
6254-216-54-48	2	+	1	18606	21403	2	+	1	18606	21403	2	+	1	18426	21186
6254-240-54-48	2	+	2	21611	24848	2	+	2	21611	24848	2	+	2	21334	24529
6254-264-60-48	2	+	2	23413	26936	2	+	2	23413	26936	2	+	2	23052	26509
6254-288-60-48	2	+	2	24688	28393	2	+	2	24688	28393	2	+	2	24322	27966

ORDERING PROCEDURE

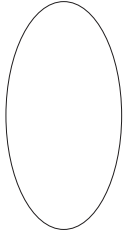
Please specify the following:

1. Select Table Top shape, size, model number and wood species.
2. Select Table Base(s), size, model number, quantity and wood species.
3. Obtain Table Price by cross-referencing selected top with selected base(s). The prices listed are the combined total of the top and base(s).
4. Select Connexus™ Module(s) and a Location Code for either a Glass or Satin Aluminum module.
Add pricing for the selected Connexus™ Module(s) to the table price.
5. Select Monument Location(s) and provide monument location code(s) on purchase order.
6. Select a Wood Finish
7. Select an Edge Profile.

Model numbers represent nominal dimensions only (in inches). Contact Customer Service if dimensions are critical.

VIRTU | CONFERENCE TABLE SPECIFICATIONS

Description	Top Size	Approximate Seating	No. of Sections	Shipping Weight	Cubic Feet
Conference Table Top – Oval	96-48	8	2	165	18.8
6259	120-54	10	3	240	30.9
	144-60	12	3	290	34.8

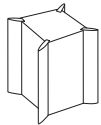


Conference tables up to and including 168" in length are available on the KrugExpress quick ship program.

Description	Base Size	W	D	H	Shipping Weight	Cubic Feet
Forza Leg Base	29	6	n/a	28	15	0.9
6238						



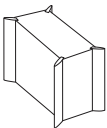
Forza Square	14-14-29	14	14	28	177	6.5
6234						



Forza Panel Base	24-29	24	n/a	28	54	5.5
6232	30-29	30	n/a	28	56	6.4



Forza Rectangle Base	13-30-29	13	30	28	126	10.8
6233						



DIMENSION KEY

L – length
W – width
H – height

Model numbers represent nominal dimensions only. Contact Customer Service if dimensions are critical.

SPECIAL FEATURES

Conference tops are designed to accommodate microphones, which can be field installed. Please contact Customer Service for more information on where they can be positioned. Custom table sizes are available. Please contact Customer Service or your local Krug representative.


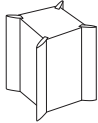

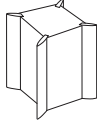
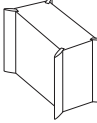
“Base Size” represents wood dimensions and does not include metal accents. Please contact Customer Service if dimensions are critical.

Bookmatched Birdseye Maple veneer is available on VIRTU Conference Table Tops at an upcharge of **\$76 list per square foot**.

Conference tops may be ordered with a reduced number of sections at an upcharge. Please contact Customer Service or your local Krug representative for details.

VIRTU | CONFERENCE TABLE PRICING AND MODEL NUMBERS

Shown below are model numbers and pricing for VIRTU conference tops and bases. The pricing is the combined price of the top and the base(s) that are cross-referenced in the chart. Please note that some bases are not available on all tops. Only the top and base combinations listed are available. When ordering, please specify the model number of the top, the model number(s) of the base(s), followed by their combined price. See bottom page for Conference Table Ordering Procedure.

	GROUP 1				GROUP 2					
	FORZA LEG 6238 	FORZA SQUARE 6234 	PRICE FOR TOP AND BASE(S)	PRICE FOR TOP AND BASE(S)	FORZA PANEL 6232 	FORZA SQUARE 6234 	FORZA RECT. 6233 	PRICE FOR TOP AND BASE(S)	PRICE FOR TOP AND BASE(S)	
Oval Table Top 6259										
MODEL #	6238-29	6234-14-14-29	MAPLE/ CHERRY/ WALNUT	ANIGRE	6232-24-29	6232-30-29	6234-14-14-29	6233-13-30-29	MAPLE/ CHERRY/ WALNUT	ANIGRE
	QTY	QTY			QTY	QTY	QTY	QTY		
6259-96-48	4		7733	8733	2				8499	9771
6259-120-54	4 +	1	11513	13085		2 +	1		12343	14204
6259-144-60	4 +	1**	13009	13266		2		+ 1	13844	15922

** REQUIRES RECTANGLE BASE

ORDERING PROCEDURE

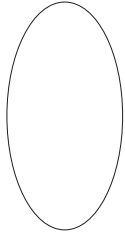
Please specify the following:

1. Select Table Top shape, size, model number and wood species.
2. Select Table Base(s), size, model number, quantity and wood species.
3. Obtain Table Price by cross-referencing selected top with selected base(s). The prices listed are the combined total of the top and base(s).
4. Select Connexus™ Module(s) and a Location Code for either a Glass or Satin Aluminum module.
Add pricing for the selected Connexus™ Module(s) to the table price.
5. Select Monument Location(s) and provide monument location code(s) on purchase order.
6. Select a Wood Finish
7. Select an Edge Profile.

Model numbers represent nominal dimensions only (in inches). Contact Customer Service if dimensions are critical.

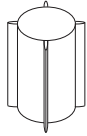
VIRTU | CONFERENCE TABLE SPECIFICATIONS

Description	Top Size	Approximate Seating	No. of Sections	Shipping Weight	Cubic Feet
Conference	96-48	8	2	165	18.8
Table Top – Oval	120-54	10	3	240	30.9
6259	144-60	12	3	290	34.8



Conference tables up to and including 168" in length are available on the KrugExpress quick ship program.

Description	Base Size	W	D	H	Shipping Weight	Cubic Feet
Dais Base	18D-29	18 dia.	n/a	28	149	6.5
6230	24D-29	24 dia.	n/a	28	171	10.9
	30D-29	30 dia.	n/a	28	196	17.6



DIMENSION KEY

L – length
W – width
H – height

Model numbers represent nominal dimensions only. Contact Customer Service if dimensions are critical.

SPECIAL FEATURES

Conference tops are designed to accommodate microphones, which can be field installed. Please contact Customer Service for more information on where they can be positioned. Custom table sizes are available. Please contact Customer Service or your local Krug representative.

“Base Size” represents wood dimensions and does not include metal accents. Please contact Customer Service if dimensions are critical.

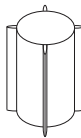
Bookmatched Birdseye Maple veneer is available on VIRTU Conference Table Tops at an upcharge of **\$76 list per square foot**.

Conference tops may be ordered with a reduced number of sections at an upcharge. Please contact Customer Service or your local Krug representative for details.

VIRTU | CONFERENCE TABLE PRICING AND MODEL NUMBERS

Shown below are model numbers and pricing for VIRTU conference tops and bases. The pricing is the combined price of the top and the base(s) that are cross-referenced in the chart. Please note that some bases are not available on all tops. Only the top and base combinations listed are available. When ordering, please specify the model number of the top, the model number(s) of the base(s), followed by their combined price. See bottom page for Conference Table Ordering Procedure.

GROUP 3

Oval Table Top 6259	DAIS 6230			PRICE FOR TOP AND BASE(S)	PRICE FOR TOP AND BASE(S)
					
MODEL #	6230- 18D-29	6230- 24D-29	6230- 30D-29	MAPLE/ CHERRY/ WALNUT	ANIGRE
6259-96-48	2			9338	10741
6259-120-54		2		11917	13711
6259-144-60	2	+	1	14330	16480

ORDERING PROCEDURE

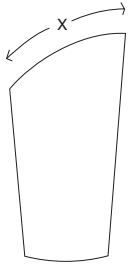
Please specify the following:

1. Select Table Top shape, size, model number and wood species.
2. Select Table Base(s), size, model number, quantity and wood species.
3. Obtain Table Price by cross-referencing selected top with selected base(s). The prices listed are the combined total of the top and base(s).
4. Select Connexus™ Module(s) and a Location Code for either a Glass or Satin Aluminum module.
Add pricing for the selected Connexus™ Module(s) to the table price.
5. Select Monument Location(s) and provide monument location code(s) on purchase order.
6. Select a Wood Finish
7. Select an Edge Profile.

Model numbers represent nominal dimensions only (in inches). Contact Customer Service if dimensions are critical.

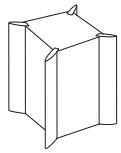
VIRTU | CONFERENCE TABLE SPECIFICATIONS

Description	Top Size	Approximate Seating	X	No. of Sections	Shipping Weight	Cubic Feet
Conference Table Top – Verso 6258	107-57-40	9	73	2	230	28.8
	137-63-40	12	78	3	310	35.5
	144-48-42	14	83	4	390	44.3

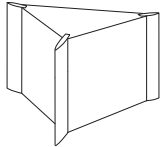


Conference tables up to and including 168" in length are available on the KrugExpress quick ship program.

Description	Base Size	W	D	H	Shipping Weight	Cubic Feet
Forza Square Base 6234	14-14-29	14	14	28	177	6.5
	20-20-29	20	20	28	199	10.9
	26-26-29	26	26	28	225	17.6



Verso Base 6231	18-19-29	18	19	28	178	13.5
	23-24-29	23	24	28	192	22.1



Forza Leg Base 6238	29	6	n/a	28	15	0.9
---------------------	----	---	-----	----	----	-----



DIMENSION KEY

L – length
W – width
H – height

Model numbers represent nominal dimensions only. Contact Customer Service if dimensions are critical.

SPECIAL FEATURES

Conference tops are designed to accommodate microphones, which can be field installed. Please contact Customer Service for more information on where they can be positioned. Custom table sizes are available. Please contact Customer Service or your local Krug representative.

“Base Size” represents wood dimensions and does not include metal accents. Please contact Customer Service if dimensions are critical.

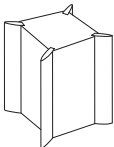
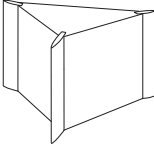
Bookmatched Birdseye Maple veneer is available on VIRTU Conference Table Tops at an upcharge of **\$76 list per square foot**.

Conference tops may be ordered with a reduced number of sections at an upcharge. Please contact Customer Service or your local Krug representative for details.


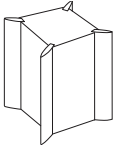
VIRTU | CONFERENCE TABLE PRICING AND MODEL NUMBERS

Shown below are model numbers and pricing for VIRTU conference tops and bases. The pricing is the combined price of the top and the base(s) that are cross-referenced in the chart. Please note that some bases are not available on all tops. Only the top and base combinations listed are available. When ordering, please specify the model number of the top, the model number(s) of the base(s), followed by their combined price. See bottom page for Conference Table Ordering Procedure.

GROUP 1

Verso Table Top 6258	FORZA SQUARE 6234 			VERSO 6231 		PRICE FOR TOP AND BASE(S)	PRICE FOR TOP AND BASE(S)
	6234-14-14-29	6234-20-20-29	6234-26-26-29	6231-18-19-296231-23-24-29			
MODEL #	QTY	QTY	QTY	QTY	QTY	MAPLE/ CHERRY/ WALNUT	ANIGRE
6258-107-57-40	1		+	1		12083	13891
6258-137-63-40	1		+	1		15577	17797
6258-167-70-40	1	1	+		1	17939	20613

GROUP 2

Verso Table Top 6258	FORZA LEG 6238 		FORZA SQUARE 6234 		PRICE FOR TOP	PRICE FOR TOP
	6238-29		6234-14-14-29			
MODEL #	QTY		QTY		MAPLE/ CHERRY/ WALNUT	ANIGRE
6258-107-57-40	4				10573	12096
6258-137-63-40	4	+	1		15310	17464
6258-167-70-40	4	+	2		17646	20144

ORDERING PROCEDURE

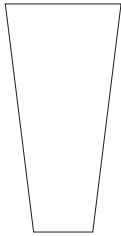
Please specify the following:

1. Select Table Top shape, size, model number and wood species.
2. Select Table Base(s), size, model number, quantity and wood species.
3. Obtain Table Price by cross-referencing selected top with selected base(s). The prices listed are the combined total of the top and base(s).
4. Select Connexus™ Module(s) and a Location Code for either a Glass or Satin Aluminum module.
Add pricing for the selected Connexus™ Module(s) to the table price.
5. Select Monument Location(s) and provide monument location code(s) on purchase order.
6. Select a Wood Finish
7. Select an Edge Profile.

Model numbers represent nominal dimensions only (in inches). Contact Customer Service if dimensions are critical.

VIRTU | CONFERENCE TABLE SPECIFICATIONS

Description	Top Size	Approximate Seating	No. of Sections	Shipping Weight	Cubic Feet
Conference	120-60-42	11	3	265	30.3
Table Top – Visio 6257	144-60-42	13	3	310	31.3
	168-66-42	15	4	355	40.8
	192-69-42	17	4	400	43.8
	216-73-42	19	5	445	53.3
	240-76-42	21	5	490	58.6

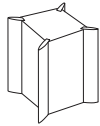


Conference tables up to and including 168" in length are available on the KrugExpress quick ship program.

Description	Base Size	W	D	H	Shipping Weight	Cubic Feet
Forza Leg Base 6238	29	6	n/a	28	15	0.9



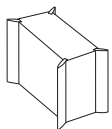
Forza Square 6234	14-14-29	14	14	28	177	6.5
-------------------	----------	----	----	----	-----	-----



Forza Panel Base 6232	24-29	24	n/a	28	54	5.5
	30-29	30	n/a	28	56	6.4
	34-29	34	n/a	28	58	7.5
	41-29	41	n/a	28	63	9.1
	48-29	48	n/a	28	68	10.7



Forza Rectangle Base 6233	13-30-29	13	30	28	126	10.8
---------------------------	----------	----	----	----	-----	------



DIMENSION KEY

L – length
W – width
H – height

Model numbers represent nominal dimensions only. Contact Customer Service if dimensions are critical.

SPECIAL FEATURES

Conference tops are designed to accommodate microphones, which can be field installed. Please contact Customer Service for more information on where they can be positioned. Custom table sizes are available. Please contact Customer Service or your local Krug representative.


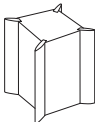

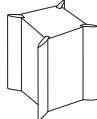
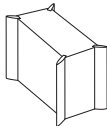
“Base Size” represents wood dimensions and does not include metal accents. Please contact Customer Service if dimensions are critical.

Bookmatched Birdseye Maple veneer is available on VIRTU Conference Table Tops at an upcharge of **\$76 list per square foot**.

Conference tops may be ordered with a reduced number of sections at an upcharge. Please contact Customer Service or your local Krug representative for details.

VIRTU | CONFERENCE TABLE PRICING AND MODEL NUMBERS

Shown below are model numbers and pricing for VIRTU conference tops and bases. The pricing is the combined price of the top and the base(s) that are cross-referenced in the chart. Please note that some bases are not available on all tops. Only the top and base combinations listed are available. When ordering, please specify the model number of the top, the model number(s) of the base(s), followed by their combined price. See bottom page for Conference Table Ordering Procedure.

	GROUP 1				GROUP 2									
	FORZA LEG 6238 	FORZA SQUARE 6234 	PRICE FOR TOP AND BASE(S)	PRICE FOR TOP AND BASE(S)	FORZA PANEL 6232 	FORZA SQUARE 6234 	FORZA RECT. 6233 	PRICE FOR TOP AND BASE(S)	PRICE FOR TOP AND BASE(S)					
MODEL #	6238-29	6234-14-14-29	MAPLE/ CHERRY/ WALNUT	ANIGRE	6232-24-29	6232-30-29	6232-34-29	6232-41-29	6232-48-29	6234-14-14-29	6233-13-30-29	MAPLE/ CHERRY/ WALNUT	ANIGRE	
	QTY	QTY			QTY	QTY	QTY	QTY	QTY	QTY	QTY			
6257-120-60-42	4	+	1	10873	12361	1	1			+	1	11624	13368	
6257-144-60-42	4	+	1**	14357	16364	1		1		+	1	15154	17413	
6257-168-66-42	4	+	2	16083	18357	1			1	+	1	16114	18511	
6257-192-69-42	4	+	2	17098	19522	1			1	+	2	18715	21498	
6257-216-72-42	4	+	3	19388	22169	1				1	+	2	19858	22825
6257-240-76-42	4	+	3	20580	21135	1				1	+	2	21048	24190

**Requires rectangle base

ORDERING PROCEDURE

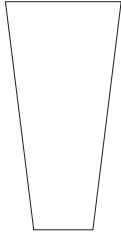
Please specify the following:

1. Select Table Top shape, size, model number and wood species.
2. Select Table Base(s), size, model number, quantity and wood species.
3. Obtain Table Price by cross-referencing selected top with selected base(s). The prices listed are the combined total of the top and base(s).
4. Select Connexus™ Module(s) and a Location Code for either a Glass or Satin Aluminum module. Add pricing for the selected Connexus™ Module(s) to the table price.
5. Select Monument Location(s) and provide monument location code(s) on purchase order.
6. Select a Wood Finish
7. Select an Edge Profile.

Model numbers represent nominal dimensions only (in inches). Contact Customer Service if dimensions are critical.

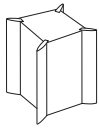
VIRTU | CONFERENCE TABLE SPECIFICATIONS

Description	Top Size	Approximate Seating	No. of Sections	Shipping Weight	Cubic Feet
Conference Table Top – Visio 6257	120-60-42	11	3	265	30.3
	144-60-42	13	3	310	31.3
	168-66-42	15	4	355	40.8
	192-69-42	17	4	400	43.8
	216-73-42	19	5	445	53.3
	240-76-42	21	5	490	58.6

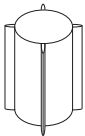


Conference tables up to and including 168" in length are available on the KrugExpress quick ship program.

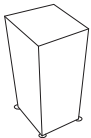
Description	Base Size	W	D	H	Shipping Weight	Cubic Feet
Forza Square Base 6234	14-14-29	14	14	28	177	6.5
	20-20-29	20	20	28	199	10.9
	26-26-29	26	26	28	225	17.6



Description	Base Size	W	D	H	Shipping Weight	Cubic Feet
Dais Base 6230	18D-29	18 dia.	n/a	28	149	6.5
	24D-29	24 dia.	n/a	28	171	10.9
	30D-29	30 dia.	n/a	28	196	17.6



Description	Base Size	W	D	H	Shipping Weight	Cubic Feet
Oblique Base 6237	18-18-29	18	18	28	149	6.5
	24-24-29	24	24	28	171	10.9
	30-30-29	30	30	28	196	17.6



DIMENSION KEY

L – length
W – width
H – height

Model numbers represent nominal dimensions only. Contact Customer Service if dimensions are critical.

SPECIAL FEATURES

Conference tops are designed to accommodate microphones, which can be field installed. Please contact Customer Service for more information on where they can be positioned. Custom table sizes are available. Please contact Customer Service or your local Krug representative.

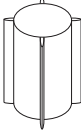
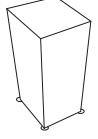
“Base Size” represents wood dimensions and does not include metal accents. Please contact Customer Service if dimensions are critical.

Bookmatched Birdseye Maple veneer is available on VIRTU Conference Table Tops at an upcharge of **\$76 list per square foot**.

Conference tops may be ordered with a reduced number of sections at an upcharge. Please contact Customer Service or your local Krug representative for details.

VIRTU | CONFERENCE TABLE PRICING AND MODEL NUMBERS

Shown below are model numbers and pricing for VIRTU conference tops and bases. The pricing is the combined price of the top and the base(s) that are cross-referenced in the chart. Please note that some bases are not available on all tops. Only the top and base combinations listed are available. When ordering, please specify the model number of the top, the model number(s) of the base(s), followed by their combined price. See bottom page for Conference Table Ordering Procedure.

Visio Table Top 6257	GROUP 3					GROUP 4					GROUP 5				
	FORZA SQUARE 6234			PRICE FOR TOP AND BASE(S)	PRICE FOR TOP AND BASE(S)	DAIS 6230			PRICE FOR TOP AND BASE(S)	PRICE FOR TOP AND BASE(S)	OBLIQUE 6237			PRICE FOR TOP AND BASE(S)	PRICE FOR TOP AND BASE(S)
															
MODEL #	6234-14- 14-29	6234-20- 20-29	6234-26- 26-29	MAPLE/ CHERRY/ WALNUT	ANIGRE	6230- 18d-29	6230- 24d-29	6230- 30d-29	MAPLE/ CHERRY/ WALNUT	ANIGRE	6237-18- 18-29	6237-24- 24-29	6237-30- 30-29	MAPLE/ CHERRY/ WALNUT	ANIGRE
	QTY	QTY	QTY			QTY	QTY	QTY			QTY	QTY	QTY		
6257-120-60-42	1	+	1			1	+	1			1	+	1		
				11963	13761				12000	13800				11826	13593
6257-144-60-42	1		+	1		1		+	1		1		+	1	
				15364	17675				15357	17659				15181	17461
6257-168-66-42	1	+	1	+	1	1	+	1	+	1	1	+	1	+	1
				17722	20381				17706	20363				17444	20058
6257-192-69-42	1	+	1	+	1	1	+	1	+	1	1	+	1	+	1
				18809	21627				18789	21612				18532	21305
6257-216-72-42	1	+	1	+	1	1	+	1	+	1	1	+	1	+	1
				19977	22978				19960	22960				19700	22657
6257-240-76-42	1	+	1	+	2	1	+	1	+	2	1	+	1	+	2
				22720	26120				22646	26047				22302	25642

ORDERING PROCEDURE

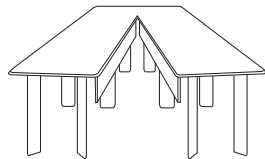
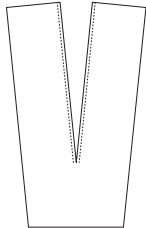
Please specify the following:

1. Select Table Top shape, size, model number and wood species.
2. Select Table Base(s), size, model number, quantity and wood species.
3. Obtain Table Price by cross-referencing selected top with selected base(s). The prices listed are the combined total of the top and base(s).
4. Select Connexus™ Module(s) and a Location Code for either a Glass or Satin Aluminum module.
Add pricing for the selected Connexus™ Module(s) to the table price.
5. Select Monument Location(s) and provide monument location code(s) on purchase order.
6. Select a Wood Finish
7. Select an Edge Profile.

Model numbers represent nominal dimensions only (in inches). Contact Customer Service if dimensions are critical.

VIRTU | CONFERENCE TABLE SPECIFICATIONS

Description	Top Size	Approximate Seating	No. of Sections	Shipping Weight	Cubic Feet
Conference Table Top –	134-80-52	9	3	282	37.7
Open Visio	134-92-64	9	3	317	40.3
with partial	158-85-52	11	5	350	44.9
modesty panel*	158-96-64	11	5	395	47.5
6260	182-90-52	11	5	404	50.9
	182-102-64	11	5	459	53.5
	218-97-52	15	7	486	63.3
	218-109-64	15	7	551	65.9
	254-105-52	15	7	567	72.3
	254-117-64	15	7	629	74.9



Open Visio Conference tops feature a combination of three, five or seven pieces to make up the table surface:

6260-134-80-52 features 2 tops at 30 x 96" and 1 end top at 52 x 36"

6260-134-92-64 features 2 tops at 36 x 96" and 1 end top at 64 x 36"

6260-158-85-52 features 4 tops at 30 x 60" and 1 end top at 52 x 36"

6260-158-96-64 features 4 tops at 36 x 60" and 1 end top at 64 x 36"

6260-182-90-52 features 4 tops at 30 x 72" and 1 end top at 52 x 36"

6260-182-102-64 features 4 tops at 36 x 72" and 1 end top at 64 x 36"

6260-218-97-52 features 6 tops at 30 x 60" and 1 end top at 52 x 36"

6260-218-109-64 features 6 tops at 36 x 60" and 1 end top at 64 x 36"

6260-254-105-52 features 6 tops at 30 x 72" and 1 end top at 52 x 36"

6260-254-117-64 features 6 tops at 36 x 72" and 1 end top at 64 x 36"

***Wood modesty panel on Open Visio table is 8 3/4" in height and 3/4" thick.**

Conference tables up to and including 168" in length are available on the KrugExpress quick ship program.

Description	Base Size	W	D	H	Shipping Weight	Cubic Feet
Forza Leg Base 6238	29	6	n/a	28	15	0.9



DIMENSION KEY

L – length
W – width
H – height

Model numbers represent nominal dimensions only. Contact Customer Service if dimensions are critical.

SPECIAL FEATURES

Conference tops are designed to accommodate microphones, which can be field installed. Please contact Customer Service for more information on where they can be positioned. Custom table sizes are available. Please contact Customer Service or your local Krug representative.

"Base Size" represents wood dimensions and does not include metal accents. Please contact Customer Service if dimensions are critical.


Bookmatched Birdseye Maple veneer is available on VIRTU Conference Table Tops at an upcharge of **\$76 list per square foot**.

Conference tops may be ordered with a reduced number of sections at an upcharge. Please contact Customer Service or your local Krug representative for details.

VIRTU | CONFERENCE TABLE PRICING AND MODEL NUMBERS

Shown below are model numbers and pricing for VIRTU conference tops and bases. The pricing is the combined price of the top and the base(s) that are cross-referenced in the chart. Please note that some bases are not available on all tops. Only the top and base combinations listed are available. When ordering, please specify the model number of the top, the model number(s) of the base(s), followed by their combined price. See bottom page for Conference Table Ordering Procedure.

GROUP 1

Open Visio Table Top (partial modesty) 6260	FORZA LEG 6238	PRICE FOR TOP AND BASE(S)	PRICE FOR TOP AND BASE(S)
			
MODEL #	6238-29	MAPLE/ CHERRY/ WALNUT	ANIGRE
	QTY		
6260-134-80-52	10	17839	20362
6260-134-92-64	10	18297	20834
6260-158-85-52	14	20276	22814
6260-158-96-64	14	20711	23268
6260-182-90-52	14	22032	24782
6260-182-102-64	14	23862	25883
6260-218-97-52	18	26531	28705
6260-218-109-64	18	28273	30683
6260-254-105-52	18	30627	33215
6260-254-117-64	18	32697	35494

ORDERING PROCEDURE

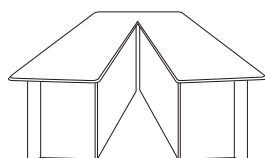
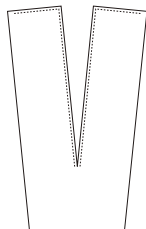
Please specify the following:

1. Select Table Top shape, size, model number and wood species.
2. Select Table Base(s), size, model number, quantity and wood species.
3. Obtain Table Price by cross-referencing selected top with selected base(s). The prices listed are the combined total of the top and base(s).
4. Select Connexus™ Module(s) and a Location Code for either a Glass or Satin Aluminum module.
Add pricing for the selected Connexus™ Module(s) to the table price.
5. Select Monument Location(s) and provide monument location code(s) on purchase order.
6. Select a Wood Finish
7. Select an Edge Profile.

Model numbers represent nominal dimensions only (in inches). Contact Customer Service if dimensions are critical.

VIRTU | CONFERENCE TABLE SPECIFICATIONS

Description	Top Size	Approximate Seating	No. of Sections	Shipping Weight	Cubic Feet
Conference Table Top –	134-80-52	9	3	342	37.7
Open Visio with full height modesty panel	134-92-64	9	3	377	40.3
6262	158-85-52	11	5	470	44.9
	158-96-64	11	5	515	47.5
	182-90-52*	11	5	524	50.9
	182-102-64	11	5	579	53.5
	218-97-52	15	7	665	63.3
	218-109-64	15	7	731	65.9
	254-105-52	15	7	747	72.3
	254-117-64	15	7	809	74.9



Open Visio Conference tops feature a combination of three, five or seven pieces to make up the table surface:

6262-134-80-52 features 2 tops at 30 x 96" and 1 end top at 52 x 36"

6262-134-92-64 features 2 tops at 36 x 96" and 1 end top at 64 x 36"

6262-158-85-52 features 4 tops at 30 x 60" and 1 end top at 52 x 36"

6262-158-96-64 features 4 tops at 36 x 60" and 1 end top at 64 x 36"

6262-182-90-52 features 4 tops at 30 x 72" and 1 end top at 52 x 36"

6262-182-102-64 features 4 tops at 36 x 72" and 1 end top at 64 x 36"

6262-218-97-52 features 6 tops at 30 x 60" and 1 end top at 52 x 36"

6262-218-109-64 features 6 tops at 36 x 60" and 1 end top at 64 x 36"

6262-254-105-52 features 6 tops at 30 x 72" and 1 end top at 52 x 36"

6262-254-117-64 features 6 tops at 36 x 72" and 1 end top at 64 x 36"

***wood modesty panel on Open Visio table is 28" in height and 3/4" thick.**

Conference tables up to and including 168" in length are available on the KrugExpress quick ship program.

Description	Base Size	W	D	H	Shipping Weight	Cubic Feet
Forza Leg Base 6238	29	6	n/a	28	15	0.9



DIMENSION KEY

L – length
W – width
H – height

Model numbers represent nominal dimensions only. Contact Customer Service if dimensions are critical.

SPECIAL FEATURES

Conference tops are designed to accommodate microphones, which can be field installed. Please contact Customer Service for more information on where they can be positioned. Custom table sizes are available. Please contact Customer Service or your local Krug representative.


"Base Size" represents wood dimensions and does not include metal accents. Please contact Customer Service if dimensions are critical.

Bookmatched Birdseye Maple veneer is available on VIRTU Conference Table Tops at an upcharge of **\$76 list per square foot**.

Conference tops may be ordered with a reduced number of sections at an upcharge. Please contact Customer Service or your local Krug representative for details.

VIRTU | CONFERENCE TABLE PRICING AND MODEL NUMBERS

Shown below are model numbers and pricing for VIRTU conference tops and bases. The pricing is the combined price of the top and the base(s) that are cross-referenced in the chart. Please note that some bases are not available on all tops. Only the top and base combinations listed are available. When ordering, please specify the model number of the top, the model number(s) of the base(s), followed by their combined price. See bottom page for Conference Table Ordering Procedure.

GROUP 1			
Open Visio Table Top (full modesty) 6262	FORZA LEG 6238	PRICE FOR TOP AND BASE(S)	PRICE FOR TOP AND BASE(S)
			
MODEL #	6238-29	MAPLE/ CHERRY/ WALNUT	ANIGRE
	QTY		
6262-134-80-52	6	19978	22807
6262-134-92-64	6	20492	23337
6262-158-85-52	8	22707	25551
6262-158-96-64	8	23197	26057
6262-182-90-52	8	24670	27758
6262-182-102-64	8	26726	28990
6262-218-97-52	10	29715	32154
6262-218-109-64	10	31665	34362
6262-254-105-52	10	34302	37202
6262-254-117-64	10	36617	39750

ORDERING PROCEDURE

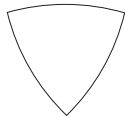
Please specify the following:

1. Select Table Top shape, size, model number and wood species.
2. Select Table Base(s), size, model number, quantity and wood species.
3. Obtain Table Price by cross-referencing selected top with selected base(s). The prices listed are the combined total of the top and base(s).
4. Select Connexus™ Module(s) and a Location Code for either a Glass or Satin Aluminum module.
Add pricing for the selected Connexus™ Module(s) to the table price.
5. Select Monument Location(s) and provide monument location code(s) on purchase order.
6. Select a Wood Finish
7. Select an Edge Profile.

Model numbers represent nominal dimensions only (in inches). Contact Customer Service if dimensions are critical.

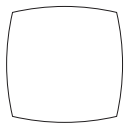
VIRTU | CONFERENCE TABLE SPECIFICATIONS

Description	Top Size	Approximate Seating	No. of Sections	Shipping Weight	Cubic Feet
Conference	36D	3	1	48	5.8
Table Top – Delta	42D	3	1	54	7.5
6253	48D	3	1	74	9.4
	54D	3	1	100	14.4
	60D	3	1	134	14.4



Conference tables up to and including 168" in length are available on the KrugExpress quick ship program.

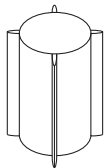
Conference	36-36	4	1	50	5.8
Table Top – Arced Square	42-42	4	1	56	7.5
6256	48-48	4	1	82	9.4
	54-54	4	1	100	14.4
	60-60	4	1	132	14.4



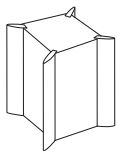
Description	Base Size	W	D	H	Shipping Weight	Cubic Feet
Forza Leg Base	29	6	n/a	28	15	0.9
6238						



Dais Base	18D -29	18 Dia	n/a	28	149	6.5
6230	24D -29	24 Dia	n/a	28	171	10.9
	30D -29	30 Dia	n/a	28	196	17.6



Forza Square Base	14-14-29	14	14	28	177	6.5
6234	20-20-29	20	20	28	199	10.9
	26-26-29	26	26	28	225	17.6



DIMENSION KEY

L – length
W – width
H – height

Model numbers represent nominal dimensions only. Contact Customer Service if dimensions are critical.

SPECIAL FEATURES

Conference tops are designed to accommodate microphones, which can be field installed. Please contact Customer Service for more information on where they can be positioned. Custom table sizes are available. Please contact Customer Service or your local Krug representative.


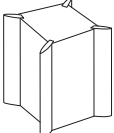
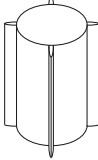
“Base Size” represents wood dimensions and does not include metal accents. Please contact Customer Service if dimensions are critical.

Bookmatched Birdseye Maple veneer is available on VIRTU Conference Table Tops at an upcharge of **\$76 list per square foot**.

Conference tops may be ordered with a reduced number of sections at an upcharge. Please contact Customer Service or your local Krug representative for details.

VIRTU | CONFERENCE TABLE PRICING AND MODEL NUMBERS

Shown below are model numbers and pricing for VIRTU conference tops and bases. The pricing is the combined price of the top and the base(s) that are cross-referenced in the chart. Please note that some bases are not available on all tops. Only the top and base combinations listed are available. When ordering, please specify the model number of the top, the model number(s) of the base(s), followed by their combined price. See bottom page for Conference Table Ordering Procedure.

GROUP 1				GROUP 2				GROUP 3					
	FORZA LEG 6238 	PRICE FOR TOP AND BASE(S)	PRICE FOR TOP AND BASE(S)	FORZA SQUARE 6234 			PRICE FOR TOP AND BASE(S)	PRICE FOR TOP AND BASE(S)	DAIS 6230 			PRICE FOR TOP AND BASE(S)	PRICE FOR TOP AND BASE(S)
MODEL #	6238-29	MAPLE/ CHERRY/ WALNUT	ANIGRE	6234-14 14-29	6234-20 20-29	6234-26 26-29	MAPLE/ CHERRY/ WALNUT	ANIGRE	6230- 18D-29	6230- 24D-29	6230- 30D-29	MAPLE/ CHERRY/ WALNUT	ANIGRE
	QTY			QTY	QTY	QTY			QTY	QTY	QTY		
Delta Table Top 6253													
6253-36									1			4158	4799
6253-42	3	3959	4432						1			4496	5171
6253-48	3	4235	4752						1			4773	5493
6253-54	3	5362	6045							1		5943	6836
6253-60	3	6484	7339								1	7109	8178
Arced Square Table Top 6256													
6256-36-36	4	3762	4162	1			3994	4595	1			4037	4641
6256-42-42	4	4080	4534	1			4311	4763	1			4355	5006
6256-48-48	4	4470	4984	1			4698	5411	1			4748	5457
6256-54-54	4	4643	5185		1		4972	5716		1		4961	5712
6256-60-60	4	6311	7100			1	6728	7733			1	6671	7674

ORDERING PROCEDURE

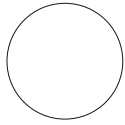
Please specify the following:

1. Select Table Top shape, size, model number and wood species.
2. Select Table Base(s), size, model number, quantity and wood species.
3. Obtain Table Price by cross-referencing selected top with selected base(s). The prices listed are the combined total of the top and base(s).
4. Select Connexus™ Module(s) and a Location Code for either a Glass or Satin Aluminum module.
Add pricing for the selected Connexus™ Module(s) to the table price.
5. Select Monument Location(s) and provide monument location code(s) on purchase order.
6. Select a Wood Finish
7. Select an Edge Profile.

Model numbers represent nominal dimensions only (in inches). Contact Customer Service if dimensions are critical.

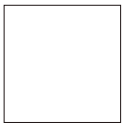
VIRTU | CONFERENCE TABLE SPECIFICATIONS

Description	Top Size	Approximate Seating	No. of Sections	Shipping Weight	Cubic Feet
Conference Table Top – Round 6255	36D	3	1	48	5.8
	42D	3	1	54	7.5
	48D	3	1	74	9.4
	54D	3	1	100	14.4
	60D	3	1	134	14.4



Conference tables up to and including 168" in length are available on the KrugExpress quick ship program.

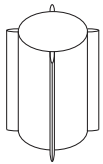
Conference Table Top – Square 6251	36-36	4	1	50	5.8
	42-42	4	1	56	7.5
	48-48	4	1	82	9.4
	54-54	4	1	100	14.4
	60-60	4	1	132	14.4



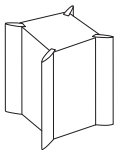
Description	Base Size	W	D	H	Shipping Weight	Cubic Feet
Forza Leg Base 6238	29	6	n/a	28	15	0.9



Dais Base 6230	18D -29	18 Dia	n/a	28	149	6.5
	24D -29	24 Dia	n/a	28	171	10.9
	30D -29	30 Dia	n/a	28	196	17.6



Forza Square Base 6234	14-14-29	14	14	28	177	6.5
	20-20-29	20	20	28	199	10.9
	26-26-29	26	26	28	225	17.6



DIMENSION KEY

L – length
W – width
H – height

Model numbers represent nominal dimensions only. Contact Customer Service if dimensions are critical.

SPECIAL FEATURES

Conference tops are designed to accommodate microphones, which can be field installed. Please contact Customer Service for more information on where they can be positioned. Custom table sizes are available. Please contact Customer Service or your local Krug representative.


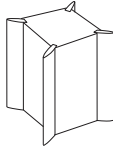
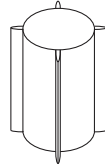
“Base Size” represents wood dimensions and does not include metal accents. Please contact Customer Service if dimensions are critical.

Bookmatched Birdseye Maple veneer is available on VIRTU Conference Table Tops at an upcharge of **\$76 list per square foot**.

Conference tops may be ordered with a reduced number of sections at an upcharge. Please contact Customer Service or your local Krug representative for details.

VIRTU | CONFERENCE TABLE PRICING AND MODEL NUMBERS

Shown below are model numbers and pricing for VIRTU conference tops and bases. The pricing is the combined price of the top and the base(s) that are cross-referenced in the chart. Please note that some bases are not available on all tops. Only the top and base combinations listed are available. When ordering, please specify the model number of the top, the model number(s) of the base(s), followed by their combined price. See bottom page for Conference Table Ordering Procedure.

GROUP 1				GROUP 2					GROUP 3				
	FORZA LEG 6238 	PRICE FOR TOP AND BASE(S)	PRICE FOR TOP AND BASE(S)	FORZA SQUARE 6234 			PRICE FOR TOP AND BASE(S)	PRICE FOR TOP AND BASE(S)	DAIS 6230 			PRICE FOR TOP AND BASE(S)	PRICE FOR TOP AND BASE(S)
MODEL #	6238-29	MAPLE/ CHERRY/ WALNUT	ANIGRE	6234-14 14-29	6234-20 20-29	6234-26 26-29	MAPLE/ CHERRY/ WALNUT	ANIGRE	6230- 18D-29	6230- 24D-29	6230- 30D-29	MAPLE/ CHERRY/ WALNUT	ANIGRE
	QTY			QTY	QTY	QTY			QTY	QTY	QTY		
Round Table Top 6255													
6255-36 dia.	3	3384	3772						1			3922	4510
6255-42 dia.	3	3830	4289	1			4324	4980	1			4370	5028
6255-48 dia.	4	4361	4855	1			4592	5284	1			4637	5332
6255-54 dia.	4	5441	6099		1		5767	6630		1		5760	6623
6255-60 dia.	4	6521	7339			1	6936	7973			1	6882	7915
Square Table Top 6251													
6251-36-36	4	3654	4041	1			3885	4470	1			3930	4520
6251-42-42	4	3958	4394	1			4189	4822	1			4235	4869
6251-48-48	4	4336	4828	1			4565	5256	1			4610	5300
6251-54-54	4	4499	5017		1		4830	5546		1		4818	6623
6251-60-60	4	6103	6859			1	6936	7493			1	6463	7915

ORDERING PROCEDURE

Please specify the following:

1. Select Table Top shape, size, model number and wood species.
2. Select Table Base(s), size, model number, quantity and wood species.
3. Obtain Table Price by cross-referencing selected top with selected base(s). The prices listed are the combined total of the top and base(s).
4. Select Connexus™ Module(s) and a Location Code for either a Glass or Satin Aluminum module.
Add pricing for the selected Connexus™ Module(s) to the table price.
5. Select Monument Location(s) and provide monument location code(s) on purchase order.
6. Select a Wood Finish
7. Select an Edge Profile.

Model numbers represent nominal dimensions only (in inches). Contact Customer Service if dimensions are critical.

VIRTU | POWER & COMMUNICATION PLANNING

OBJECTIVE

We have designed this section to help you determine the appropriate power and communications options for your specific application. This section is divided into two parts with the following objectives:

1. Provide detailed information on Connexus™, VIRTU's tabletop power and data module: what it is, its abilities and its applications.
2. Provide a description and specifications of VIRTU's wire management capabilities.

CONNEXUS™

Using technology and furniture together can be a challenge, and at worst can ruin a meeting or presentation. VIRTU is totally designed around the interface with office technology and equipment. The Connexus™ power module in table tops provides an unlimited range of connectivity. Going way beyond electrical, Connexus™ offers connections for voice, data, multimedia presentations, network and internet connections, and much more. Connexus™ can be specified in any number of locations in a table, and features a substantial cavity for easy access and wire storage.

But the greatest innovation of patent-pending Connexus™ is that it utilizes industry-standard receptacle outlets for this multitude of connection options. This provides huge advantages over the more limited interface found in other products. VIRTU offers 11 standard configurations for Connexus™, which will address almost any user need. And Connexus™ can also be ordered as a Blank module, and configured by electricians on-site with off-the-shelf receptacles and wiring to a user's specific needs. This feature makes VIRTU exceptionally suited to customers where local codes require on-site configuring and installation of all electrical components.

There's more. Connexus™ can be reconfigured on-site, with the same components used by electricians everywhere, and can be purchased wherever electrical components are sold. Likewise, Connexus™ faceplates are standard Decora style, which are also readily available. VIRTU is designed to allow this reconfiguration of wiring without having to take tables apart and re-install. VIRTU is the conferencing product that best addresses the inevitability of changing office technology, and the need for interfaces to change and evolve with it. This unique design philosophy means that VIRTU will never be outmoded or outdated by changing user needs.

CONNEXUS™

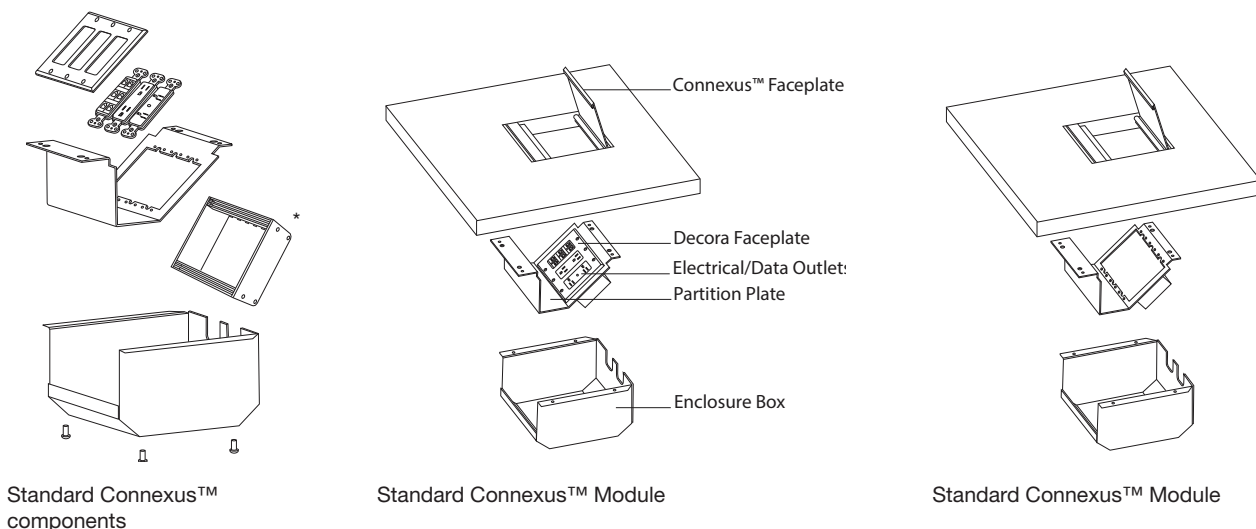
Connexus™ is Krug's proprietary tabletop power and data module. When opened, it presents power and data outlets on a convenient angle to the user and provides storage for wiring.

The faceplate of Connexus™ can be either Glass or Aluminum, and sits flush with the tabletop. It is designed to allow wiring to pass through the surface cover in both the open and closed positions. The faceplate opens to a 100° angle from the table top.

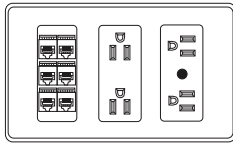
Connexus™ utilizes standard receptacle outlets, which can be field converted and reconfigured at any time. Connexus™ comes with receptacles pre-wired, with a wide selection of power, data and presentation system outlets, or alternatively can be purchased as Blank modules that can be hard-wired on site by the user and reconfigured easily when this is desired. To facilitate this process, the Enclosure Box of each Connexus™ module is easily removable.

* All duplex outlets are contained within a metal box that is attached to the Partition Plate. If additional outlets need to be added in the future, these boxes need to be ordered from Krug to expand the enclosure. This modification should be done by a qualified electrician.

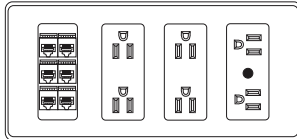
The labeled drawing shown below illustrates the way a Connexus™ module is shipped to the user. The Partition Plate is mounted on-site to the under side of the top and the Enclosure Box over top to conceal the module.



VIRTU | POWER & COMMUNICATION PLANNING



Standard



Large

Connexus™ modules may be specified in **Standard** or **Large** sizes. Standard modules are available in 6 configurations. Large modules are available in 5 configurations. As an alternative, **Blank** Connexus™ modules may be purchased for future use by the customer.

CONNEXUS™ PORT OPTIONS :

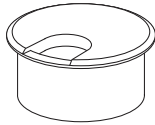
- RJ11 port** - Connection for Telephone/Modem
- RJ45 port** - Category 6 Connection for Network Connector
- AC Power** - Power Input
- RCA ports** - Female RCA type pass-through (left – black, right – red) cable connectors from stereo source to audio system
- BNC port** - High quality pass-through connector from broadcast video or computer video to display monitor
- Stereo Mini Video pass-through port** - 3.5mm Mini pass-through connector from computer sound card to amplified sound system
- 15 PIN HD** - Female RCA type pass-through cable connector for video signal from VCR or video camera source to video display or VCR
- DB-9 (Serial)** - VGA type 15 pin pass-through connector from computer video to video display monitor
- Pass-through data connector from computer to switcher control for lights, blinds, projector screens, etc.

Please note: RJ11, RJ45 and Stereo Mini are not shipped pre-wired. A telephone IT or AV specialist should perform these connections.

Connexus™ modules in **Standard** configurations are 6 1/8" x 7 3/8".

Connexus™ modules in **Large** configurations are 8 1/4" x 7 3/8".

Depth on Standard and Large modules is 4.5".



As an alternative to Connexus™, a 60mm diameter round grommet, in a Satin Aluminum finish may be specified at a list price of **\$156** per grommet.

CONNEXUS™ PLANNING

Connexus™ modules are wired independently of each other to maximize the amount of electrical devices serviced. All Connexus™ modules may sustain individual loads of 15 amps, or 12 amps of continuous load. Each Connexus™ module will require a single isolated circuit to maximize its service capabilities. Connexus™ modules are not daisy-chained together, thereby preserving the system's optimum performance. As an example, if four Connexus™ modules were specified, it will be necessary to provide two duplex outlets with a total of four circuits. Each Connexus™ module can then be plugged into each supplied outlet.

Connexus™ components are UL and CSA US approved and manufactured in accordance to the National Electrical Code.

Hardwiring Connexus™ modules on-site should be performed by a licensed electrician.

It is important to note that each Connexus™ module is rated for 15 amps and each should be connected to a single isolated circuit. Although each Connexus™ module is rated for 15 amps, please note that the National Electric Code restricts the amount of any known continuous load to 12 amps.

For maximum power utilization, it is recommended that each Connexus™ module be plugged directly into a single isolated circuit.

Below we have included a list of typical office equipment and their appropriate amp ratings to assist in planning your electrical requirements.

Typical Amp requirements of office equipment, when drawing full power.

GENERAL EQUIPMENT	AMP RATING	ELECTRONIC EQUIPMENT	AMP RATING
AC adapter	.05	Desktop printer	1.2 – 5
Adding machine	.05	Laptop	1.5 – 3.5
Answering machine	.08	Modems	.15
Calculator	.25	VDTs and PCs	.08 – 4.8
Clock	.03	Video projector	.67 – 3.47
Coffee pot	10		
Fan	1.0		
Microwave	8 – 12		
Pencil sharpener	.25		
Polycom Conference Phone	.23		
Radio	.05		
Slide projector	2 – 6		
Space heater, 1000 watts	8.6		
Space heater, 1500 watts	13		
Transcriber	.15		

VIRTU | POWER & COMMUNICATION PLANNING

ELECTRICAL CORD LENGTHS

Connexus™ modules come with pre-determined electrical cord lengths that are suited to the size and configuration of each table (6', 16', 25'). Each will plug into a standard floor monument power source. However, in situations where a table length exceeds our maximum cord length, a second power entry is necessary to avoid daisy-chaining of electrical power. To determine when a second power entry is required follow these steps:

1. Select your Connexus™ locations.
2. Select your Floor Monument Location(s) if they do not already exist in the room.
3. If the number of Connexus™ modules exceed three consecutive positions left or right of the power entry, then an additional power entry will be required.

Note: Connexus™ modules in pairs count as one position.

* Open Visio tables require 2 power sources, one per wing, or a single power source located at the apex of the two tables.

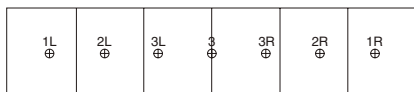
Example 1

If the designated **Floor Monument location** for the table scenario shown below is **1L**, the user would be able to power-up any or all of the following **Connexus™ locations: AL, BL, and CL.**

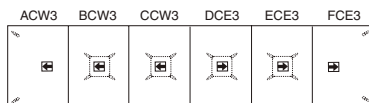
Example 2

If the designated **Floor Monument location** for the table scenario shown below is **2R**, the user would be able to power-up any or all of the following **Connexus™ locations: CL, CR, BR and AR.**

Monument Location Scenario



Connexus™ Location Scenario

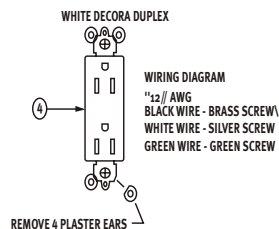
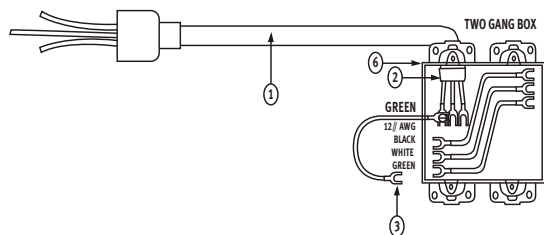


HARDWIRING ON SITE

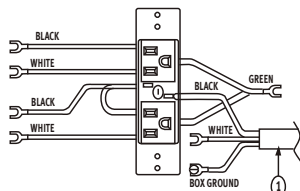
For hardwiring on-site by electricians, please use the following schematic:

- 1 Power Supply Cord
- 2 Strain Relief
- 3 Fork Terminals
- 4 Duplex Receptacles
- 5 Outlets with Circuit Breaker Assembly
- 6 Handy Box

TWO GANG BOX

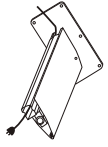


CIRCUIT BREAKER/OUTLETS ASSEMBLY

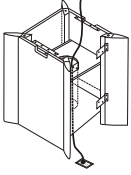


WIRE MANAGEMENT

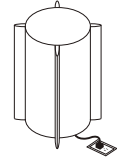
Wires are channeled behind the Forza Leg and Forza Panel bases, and concealed by design by a black PVC insert that runs the entire length of the base. The insert is 27" long and the channel opening is approximately 1.5" x 1.25" wide.



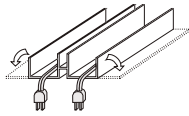
Wires are channeled through the center of Dais, Forza Rectangle, Forza Square, Oblique and Verso bases to floor monuments.



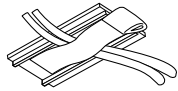
In the situation where the power source is outside of the table base, it will be necessary to pass the power supply cord underneath and into the table base. VIRTU bases are equipped with removable panels which makes access to the interior quick and easy. The Dais base (shown left) is the only exception. Dais bases are equipped with a small removable access panel, but may require a mouse-hole cut in the field.



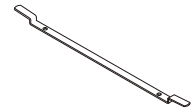
All VIRTU conference tables except open Visio are designed to accommodate wiring channeled underneath the table top and into bases. A flexible PVC wire management channel is provided with all multi-section tables at no charge, and mounted on-site. It features dual channels to allow separation of fibre optic cables. Open Visio tables use the wire management cover. All VIRTU bases have access holes to allow this wiring to pass into or out of the bases. The channel is flexible and allows for wiring to be easily inserted or removed at the sides.



When power is being routed through Forza Leg or Forza Panel bases, velcro wire management straps are attached to the underside of the top to manage wiring from Connexus™ modules to the floor monument. The velcro straps are supplied at no charge.



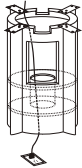
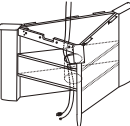
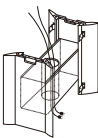
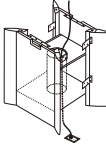
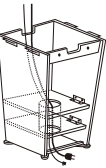
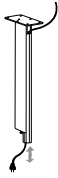
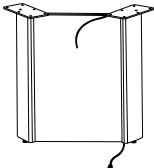
A metal cord spooler is standard on all bases with interior cavities and provided at no charge. The spooler provides for tidy wire management when there is an excessive amount of cord length.



VIRTU | POWER & COMMUNICATION PLANNING

WIRE MANAGEMENT - BASES

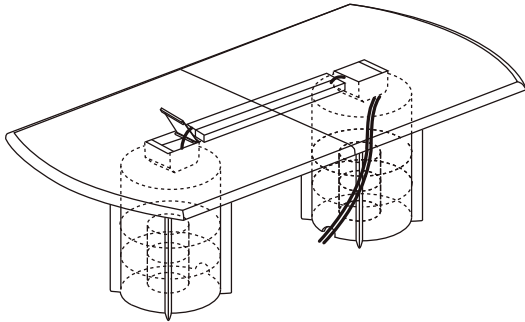
All VIRTU table bases feature wire management capabilities for routing wires between floor monuments and Connexus™ modules. Bases with interior cavities have openings in the top and a 5" recessed bottom panel which provides full access for wiring and cord plugs to the floor. Access doors are also provided on these bases to facilitate easy access to the interior. Forza Leg and Forza Panel bases use a black PVC insert to channel wires from the table top to the floor. Please see the chart below for specifications. All bases are 29" in height. Please note that all bases with interior cavities are weighted with 72 lbs. of ballast to ensure table stability.

Base Type	Base Size	Door Opening Dimensions	Interior Access Cavity Dimensions
Dais Base 	18" Dia.	11.8" x 11.4"	17.25 Dia. x 14.5"
	24" Dia.	16" x 11.4"	23.25 Dia. x 14.5"
	30" Dia.	20.3" x 11.4"	29.25 Dia. x 14.5"
	Note: Cylindrical wire cavity for this base is 12" in diameter.		
Verso Base 	18" x 19"	17.75" x 27.9"	17.75 x 18 x 12"
	23" x 24"	22.5" x 27.9"	22.5 x 22.5 x 12"
Note: Used only with Verso table top. Note: Cylindrical wire cavity for this base is 6" in diameter.			
Forza Rectangle Base 	13" x 30"	24.1" x 27.9"	28.5 x 8.25 x 8.5"
Note: Cylindrical wire cavity for this base is 6" in diameter.			
Forza Square Base 	14" x 14"	10.25" x 27.9"	13 x 11.5 x 13"
	20" x 20"	16.25" x 27.9"	19 x 17.5 x 13"
	26" x 26"	22.25" x 27.9"	25 x 23.5 x 13"
	Note: Cylindrical wire cavity for this base is 6" in diameter.		
Oblique Base 	18" x 18"	17.6" x 27.6"	14.75 x 14.25 x 17.5"
	24" x 24"	23.5" x 27.6"	20.75 x 20.25 x 17.5"
	30" x 30"	29.5" x 27.6"	26.75 x 26.25 x 17.5"
Note: Cylindrical wire cavity for this base is 6" in diameter.			
Forza Leg Base 	Uses Black PVC Insert to channel wires. Insert is 27" in length. Channel opening is 1.5" x 1.25" wide.		
Forza Panel Base 	24"		
	30"		
	34"		
	41"		
	48"		
Uses Black PVC Insert to channel wires. Insert is 27" in length. Channel opening is 1.5" x 1.25" wide.			

SAMPLE CONFIGURATIONS

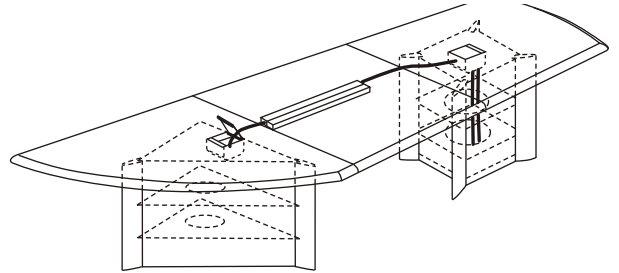
The following diagrams are samples of wire channeling for specific VIRTU table top and base configurations.

EXAMPLE #1 - ARCED RECTANGLE TOP WITH DAIS BASES

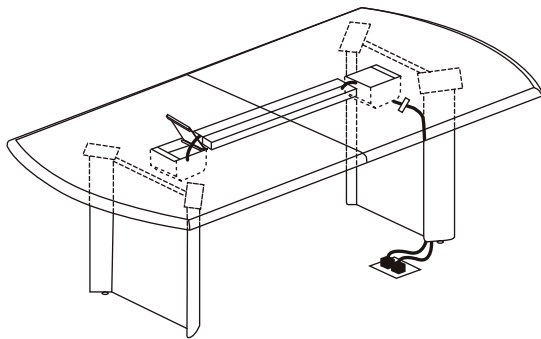


Also applicable for Forza Rectangle, Forza Square, and Oblique Bases.

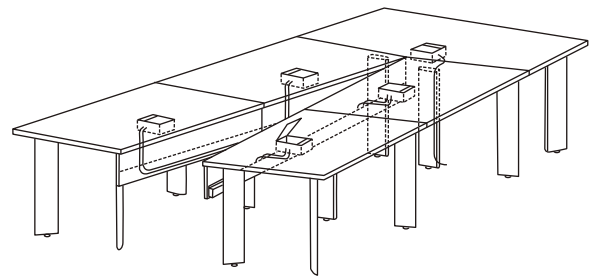
EXAMPLE #4 - VERSO TOP WITH VERSO BASE AND FORZA SQUARE BASE



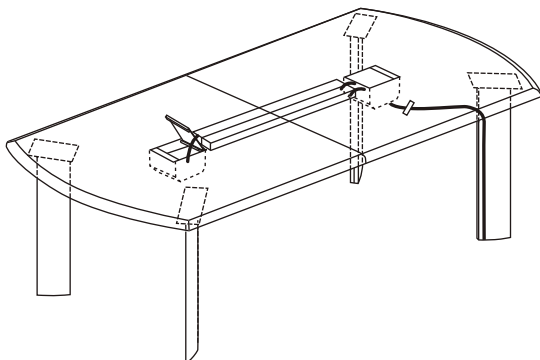
EXAMPLE #2 - ARCED RECTANGLE TOP WITH FORZA PANEL BASES



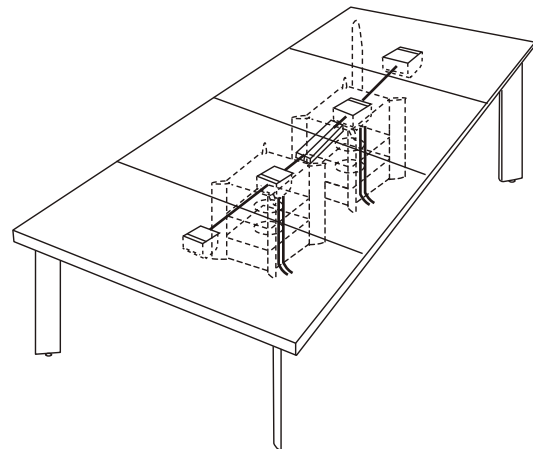
EXAMPLE #5 - OPEN VISIO TOP WITH FORZA LEG BASES



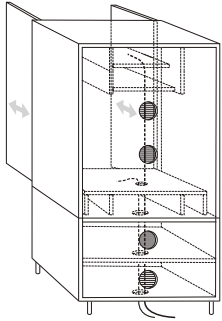
EXAMPLE #3 - ARCED RECTANGLE TOP WITH FORZA LEG BASES



EXAMPLE #6 - VISIO TOP WITH FORZA LEG AND FORZA SQUARE BASES

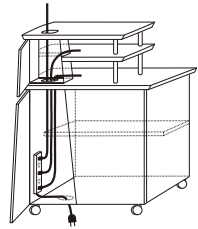


VIRTU | POWER & COMMUNICATION PLANNING



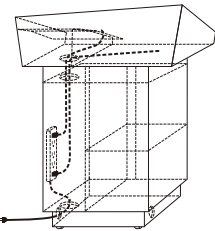
MEDIA CABINET WIRING SAMPLE

VIRTU Media Cabinets feature 2" and 4" diameter vertical and horizontal grommets to accommodate all types of videoconferencing equipment. As well, large 4" diameter air vents are strategically located on the backs of each unit. Dual Media Cabinets can accommodate two television monitors up to 35" wide, Large Media Cabinets accommodate one 35" wide monitor, and Small Media Cabinets can accommodate television monitors up to 27" wide. Cabinets can also accommodate videoconferencing cameras and microphone systems, DVD and VCR players, and projectors. Below is an example of wire management on a VIRTU Media Cabinet.



MEDIA CART WIRING SAMPLE

VIRTU Media Carts accommodate laptops or keyboards on the primary surface of the cart, and television monitors up to 27" on the top shelf. DVD and VCR players can be accommodated on all surfaces. Media Carts, depending on the model, come equipped with several vertical and horizontal grommets to provide easy connection between equipment located on the interior and exterior of the cart. Media Carts also feature a standard power bar. Below is an example of wire management on the VIRTU Media Cart.



LECTERN WIRING SAMPLE

VIRTU Lecterns offer the presenter various media options. Notebook computers, paper notes, lighting, microphones, pens and pencils, a glass of water... everything for a presenter can be accommodated. The optional Altinex power and data interface system is concealed but easily accessed. The hinged rear door, which is standard on lecterns with front hinged doors, provides access to the interior for a computer CPU to run presentations. An optional power bar is available. Below is an example of wire management on a VIRTU Lectern.

ALTINEX

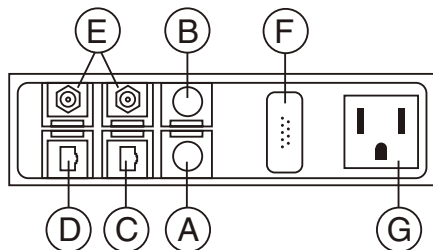
The Altinex box offers an ideal solution for the power and data requirements of a speaker using the VIRTU Lectern.

Altinex features the following power/data connectors:

A	(1) Stereo Mini	3.5 mm Mini pass-through connector from computer sound card to amplified sound system
B	(1) BNC port	High quality pass-through connector from broadcast video or computer video to video display monitor
C	(1) RJ11 port	Connection for Telephone / Modem
D	(1) RJ45 port	Connection for Network Connector
E	(2) RCA ports	Female RCA type pass-through (Left - Black, Right - Red) cable connectors from stereo audio source to audio system
F	(1) 15 Pin HD port	VGA type 15 pin pass-through connector from computer video to display monitor
G	(1) Simplex Power port	Power Input

For more information or questions regarding the Altinex Box, please contact Krug Customer Service or Altinex Technical Support at 1-800-258-4623.

This option is available on VIRTU lecterns at an upcharge of **\$1273 list**.



Connexus™ is Krug's proprietary tabletop connectivity solution. When opened, it presents power and data outlets on a convenient angle to the user and provides storage for wiring.

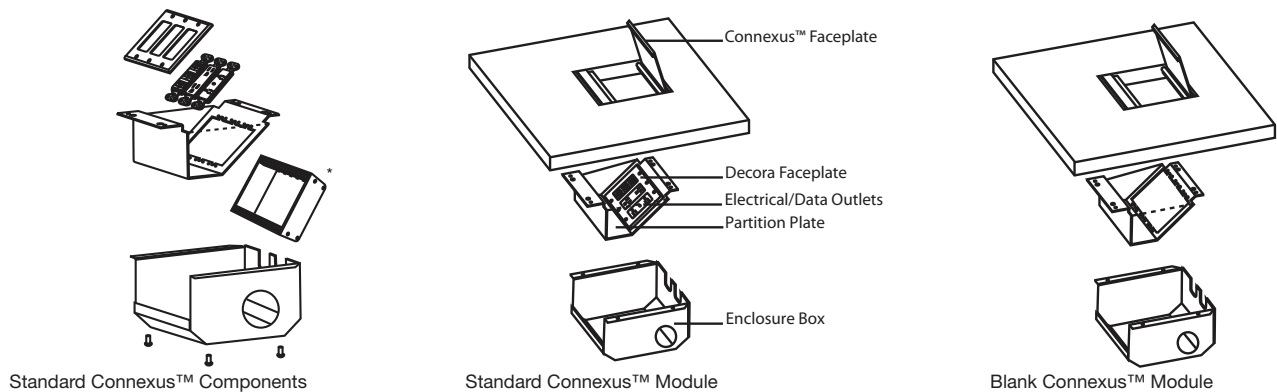
The faceplate of Connexus™ is available in either Glass or Aluminum and sits flush with the tabletop. It is designed to allow wiring to pass through the surface cover in both the open and closed positions. The faceplate opens to a 100° angle from the table top.

Connexus™ utilizes UL standard receptacle outlets. Connexus™ offers 11 pre-configured units with a wide selection of power, data and presentation system outlets, or alternatively can be purchased with just electrical ports with blank data ports. Connexus™ also can be designed and built specifically to meet your connectivity needs by using the snap-in or plate mounted port options.

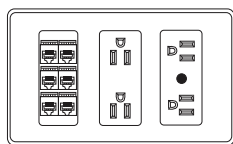
All corded units can be modified to allow the units to be hard wired by an electrician and data ports can be reconfigured easily when desired. To facilitate this process, the Enclosure Box of each Connexus™ module is easily removable.

*All duplex outlets are contained within a metal box that is attached to the Partition Plate. If additional outlets need to be added in the future, these boxes need to be ordered from Krug to expand the enclosure. All modifications must be done by a qualified electrician.

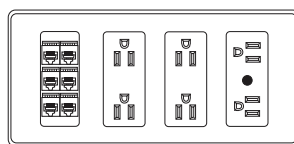
The label drawing shown below illustrates the way a Connexus™ module is shipped to the user. The Partition Plate is mounted on-site to the underside of the top with the Enclosure Box over top to conceal the module. Please note, enclosure boxes are not required when modules are enclosed in a base. Enclosure boxes are not supplied with Connexus™ modules; they must be ordered separately when required.



CONNEXUS™ SIZES



Standard - 3 Gang



Large - 4 Gang

Connexus™ modules may be specified in Standard or Large sizes.

Standard modules are available in 7 standard configurations or custom configurations. Connexus™ modules in Standard configurations are 6 1/8" x 7 3/8". Depth on Standard module is 4.5".

Large modules are available in 4 standard configurations or custom configurations. Connexus™ modules in Large configurations are 8 1/4" x 7 3/8". Depth on Large module is 4.5".

CONNEXUS™ | PLANNING

Connexus™ modules are wired independently of each other to maximize the amount of electrical devices serviced. All Connexus™ modules may sustain individual loads of 15 amps or 12 amps of continuous load. Each Connexus™ module will require a single isolated circuit to maximize its service capabilities. An optional utility a/c power outlet is available on the back surface of the outlet box.

Connexus™ components are UL and CSA US approved and manufactured in accordance to the National Electrical Code. Hardwiring Connexus™ modules on-site must be performed by a licensed electrician. Connexus™ units can be ordered with an optional utility outlet, which is located on the bottom side of the Connexus™ unit and underneath the work surface. Other Connexus™ products could employ these utility outlets as a source of power. In this scenario, it is solely the responsibility of the end user to assure that proper circuit protection is in place that never exceeds the 15 Ampere Circuit Breaker Rating.

CONNEXUS™

ELECTRICAL CORD LENGTHS

Connexus™ modules come with pre-determined electrical cord lengths that are suited to the size and configuration of each table (16' & 25'). Each will plug into a standard floor monument power source. However, in situations where a table length exceeds our maximum cord length, a second power entry is necessary to avoid daisy-chaining of electrical power. To determine when a second power entry is required follow these steps:

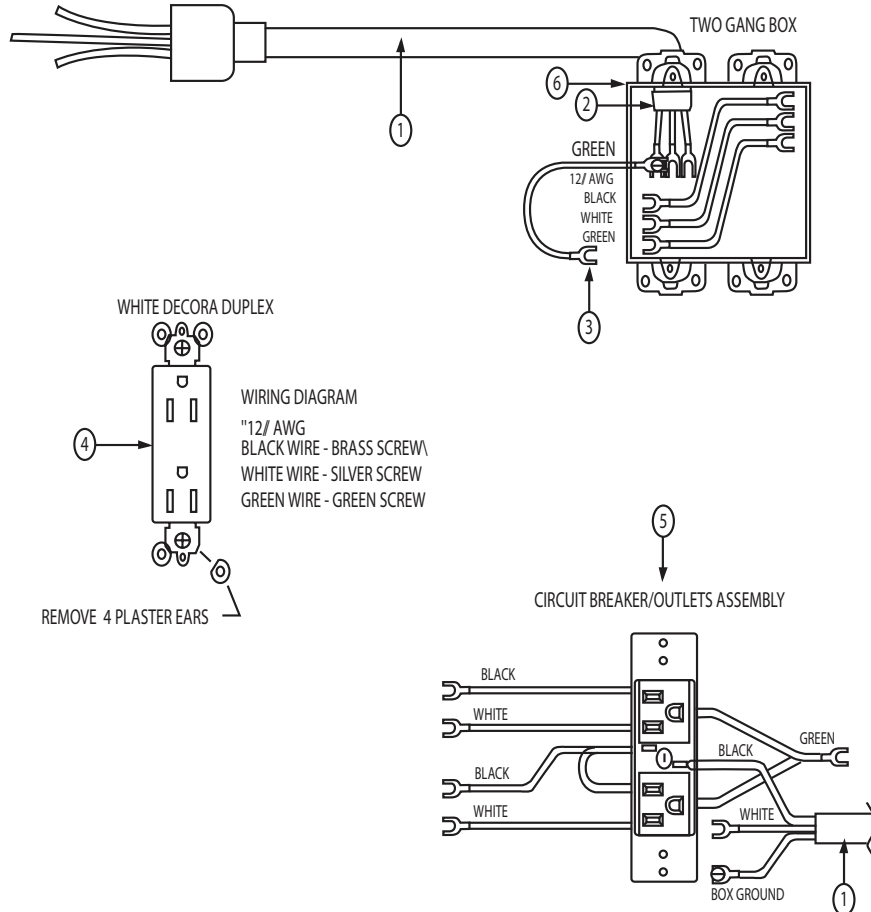
1. Select your Connexus™ locations.
2. Select your Floor Monument Location(s) if they do not already exist in the room.
3. If the number of Connexus™ modules exceed three consecutive positions left or right of the power entry, then an additional power entry will be required.

Note: Connexus™ modules in pairs count as one position.

HARDWIRING ON SITE

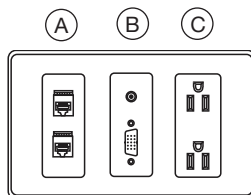
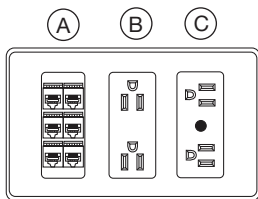
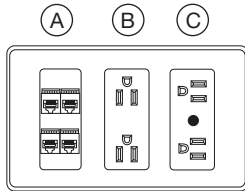
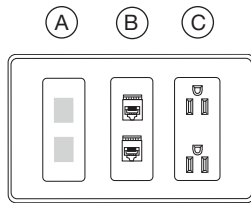
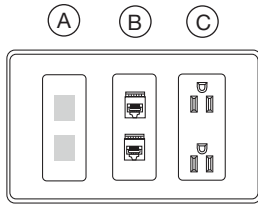
For hardwiring on-site by electricians, please use the following schematic:

- ① Power Supply Cord
- ② Strain Relief
- ③ Fork Terminals
- ④ Duplex Receptacles
- ⑤ Outlets with Circuit Breaker Assembly
- ⑥ Handy Box



CONNEXUS™ | PRECONFIGURED STANDARD MODULES

Standard - 3 GANG



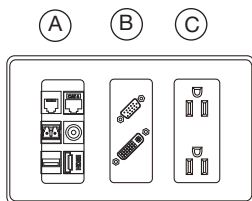
Port Options	Model #	List Price	
		Aluminum	Glass
BASIC DATA	62 CON BD	1064	1178
(A) (2) Blanks (for future use)			
(B) (2) RJ45 port (Category 6)			
(C) (2) AC power ports			
BASIC VOICE DATA	62 CON BV	1032	1143
(A) (2) Blanks (for future use)			
(B) (1) RJ11 port			
(B) (1) RJ45 port (Category 6)			
(C) (2) AC power ports			
EXPANDED DATA	62 CON ED	1307	1419
(A) (4) RJ45 port (Category 6)			
(B) (2) AC power ports			
(C) (2) AC power ports / with 15 amp circuit breaker			
EXPANDED VOICE/DATA	62 CON	1338	1451
(A) (2) RJ11 port			
(A) (4) RJ45 port (Category 6)			
(B) (2) AC power ports			
(C) (2) AC power ports / with 15 amp circuit breaker			
BASIC MULTIMEDIA	62 CON BM	1209	1319
(A) (1) RJ11 port			
(A) (1) RJ45 port (Category 6)			
(B) (1) 3.5 mm Mini			
(B) (1) VGA Type 15 pin HD			
(C) (2) AC power ports			

ORDERING NOTE: Enclosure box is only required only when the Connexus™ is not positioned over a base. If an enclosure box is required, please clearly state this requirement on your purchase order and add the **\$302** per Connexus™.

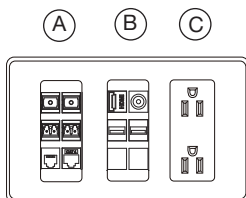
CONNEXUS™ | PRECONFIGURED STANDARD MODULES

Standard - 3 GANG

Port Options	Model #	List Price	
		Aluminum	Glass

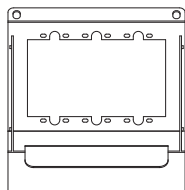


DATA & MULTIMEDIA	62 CON DM	1662	1773
<p>(A)</p> <ul style="list-style-type: none"> (1) RJ11 (1) RJ45 (1) Fiber Optic LC Duplex (1) 3.5mm Stereo Mini (1) USB "A" (1) HDMI <p>(B)</p> <ul style="list-style-type: none"> (1) DVI-I (1) VGA <p>(C)</p> <ul style="list-style-type: none"> (2) AC power ports 			



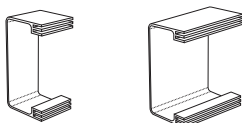
BASIC FIBRE OPTIC & MULTIMEDIA	62 CON BF	1596	1708
<p>(A)</p> <ul style="list-style-type: none"> (2) Fibre Optic SC Simplex (2) Fiber Optic LC Duplex (1) RJ11 (1) RJ45 <p>(B)</p> <ul style="list-style-type: none"> (1) HDMI (1) 3.5mm Stereo Mini (2) USB "A" (2) Blanks <p>(C)</p> <ul style="list-style-type: none"> (2) AC power ports 			

ORDERING NOTE: Enclosure box is only required only when the Connexus™ is not positioned over a base. If an enclosure box is required, please clearly state this requirement on your purchase order and add the **\$302** per Connexus™.

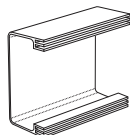


STANDARD BLANK MODULE	62 CON X1	129
------------------------------	-----------	-----

Blank Modules does not include the Connexus™ lid.

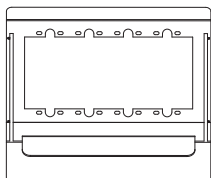
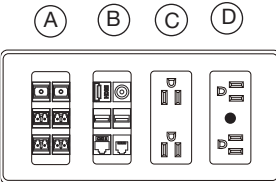
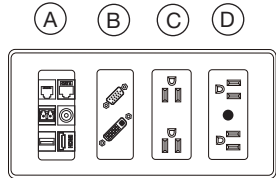
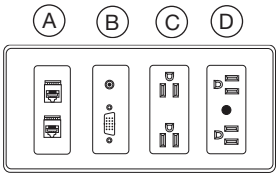
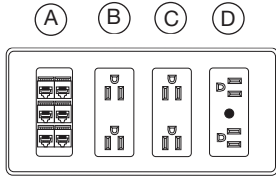


DUPLEX OUTLET ENCLOSURE	62 CON OUTBOX-1	49
To be used when adding duplex outlets to existing Connexus™ Modules.	62 CON OUTBOX-2	66
	62 CON OUTBOX-3	82



CONNEXUS™ | PRECONFIGURED LARGE MODULES

Large - 4 GANG



Port Options	Model #	List Price	
		Aluminum	Glass

NETWORK AND POWER CENTRE

62 CON NP

1629

1727

- (A) (6) RJ-45 ports
- (B) (2) AC power ports
- (C) (2) AC power ports
- (D) (2) AC power ports/with 15 amp circuit breaker

BASIC MULTIMEDIA WITH 2X POWER

62 CON B2

1491

1587

- (A) (1) RJ11 port
(1) RJ45 port
- (B) (1) 3.5 mm Mini with 2x Power
(1) VGA type 15 pin HD
- (C) (2) AC power ports
- (D) (2) AC power ports/with 15 amp circuit breaker

DATA & MULTIMEDIA WITH 2X POWER

62 CON DM2

1951

2046

- (A) (1) RJ11 port
(1) RJ45 port
(1) 1 Fiber Optic LC Duplex
(1) 1 3.5mm Stereo Mini
(1) 1 USB "A"
(1) 1 HDMI
- (B) (1) DVI-I
(1) VGA
- (C) (2) AC power ports
- (D) (2) AC power ports/with 15 amp circuit breaker

EXPANDED FIBRE OPTIC AND MULTIMEDIA

62 CON EF

2031

2129

- (A) (2) Fibre Optic SC Simplex
(4) Fiber Optic LC Duplex
- (B) (1) HDMI,
(1) Stereo 3.5 Mini
(2) USB "A",
(1) RJ45
(1) RJ11
- (C) (2) AC power port
- (D) (2) AC power ports/with 15 amp circuit breaker

LARGE BLANK MODULE

62 CON X2

148

Blank Modules does not include the Connexus™ lid.

ORDERING NOTE: Enclosure box is only required when the Connexus™ is not positioned over a base. If an enclosure box is required, please clearly state this requirement on your purchase order and add the **\$302** per Connexus™.

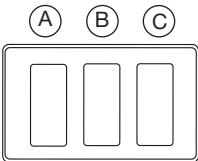
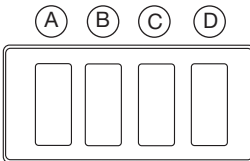
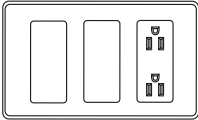
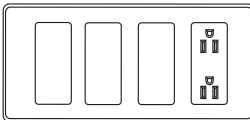
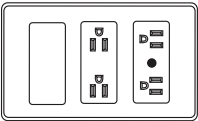
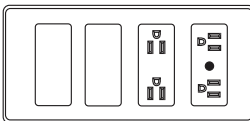
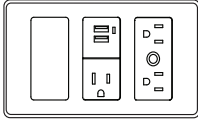
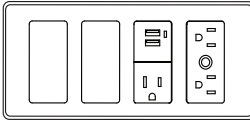
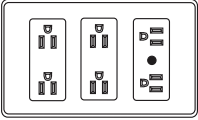
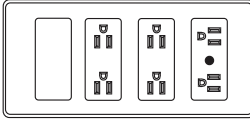
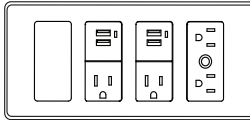
CONNEXUS™ | CUSTOM CONNEXUS™

Planning a custom Connexus™ unit is easy when following these 6 simple steps.

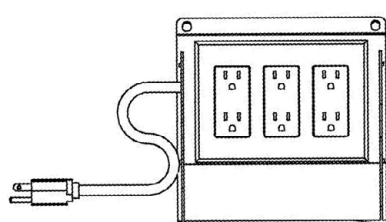
STEP ONE: Select the quantity of AC power ports or AC power ports with USB Charging (select configurations only) that are required.

Power modules must always be positioned starting from the right side of the unit. For example, 3 gang Connexus™ can have a power module located in position C with data ports in position A and B, or power can be located in position B and C with data port in position A, or position A,B and C can have all power ports or all data ports. Please note, 4 gang Connexus™ are not available with power ports located in position A.

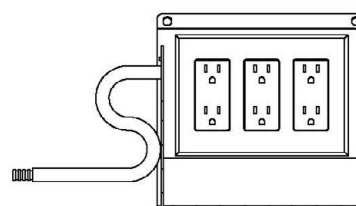
On select configurations shown below, USB charging outlets are available. These charging outlets allow a user to charge most personal electronic devices without the need for any special power adapter or a computer - simply plug in your device with any compatible USB cable. This component has 2 USB charging slots that supply 5V DC at 700mA. Comes with a charging indicator light, as well as a standard 120 volt simplex receptacle on the bottom portion of the component.

Standard Connexus™	List Price	Large Connexus™	List Price
 <p>3 Gang: Data ports only E300 - Standard Data Ports</p>	82	 <p>4 Gang: Data Ports only E400 - Large Data Ports</p>	170
 <p>3 Gang: AC Power Port E31S - Standard Outlet E31U - Standard & Utility Outlets</p>	565 605	 <p>4 Gang: AC Power Port E41S - Large Outlet E41U - Large & Utility Outlets</p>	637 677
 <p>3 Gang: AC Power Port / AC Power Port with 15 amp circuit breaker E32S - Standard Outlet E32U - Standard & Utility Outlet</p>	740 782	 <p>4 Gang: AC Power Port / AC Power Port with 15 amp circuit breaker E42S - Large Outlet E42U - Large & Utility Outlets</p>	832 871
 <p>3 Gang: AC Power Port Simplex with USB Charging/AC Power Port with 15 amp circuit breaker E32SC - Standard Outlet E32UC - Standard & Utility Outlet</p>	984 1026	 <p>4 Gang: AC Power Port Simplex with USB Charging/AC Power Port with 15 amp circuit breaker E42SC - Standard Outlet E42UC - Standard & Utility Outlet</p>	1071 1114
 <p>3 Gang: (2) AC Power Port / AC Power Port with 15 amp circuit breaker E33S - Standard Outlet E33U - Standard & Utility Outlet</p>	904 942	 <p>4 Gang: (2) AC Power Port / AC Power Port with 15 amp circuit breaker E43S - Large Outlet E43U - Large & Utility Outlets</p>	887 928
		 <p>4 Gang: (2) AC Power Port Simplex with USB Charging/AC Power Port with 15 amp circuit breaker E43SC - Standard Outlet E43UC - Standard & Utility Outlet</p>	1127 1168

STEP TWO : There are two cord end options available; Plug In and Conduit. The standard Plug In option will connect with any standard floor monument power source. The Conduit option is Liguatite® (a steel inner conduit with a PVC overlay) by Anamet, meant for specific hard wiring applications. Units can come in cord lengths of 16' or 25'. Not Applicable if no power is selected.

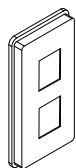


EP
Electrical Plug In
No Upcharge

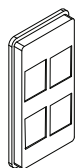


EC
Electrical Conduit
Add upcharge
16' 148
25' 243

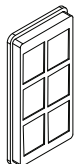
STEP THREE: There are two data options available; Plate mounted ports or Snap-in ports. Snap-in ports are available in configurations of two, four or six. Choose the faceplate below that meets your data requirements. If an odd number of Snap-in ports are required, a blank port needs to be selected when the opening is not in use.



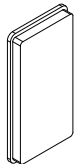
M02
Mounting Plate (2)
accepts two snap in data ports
Add \$37 list



M04
Mounting Plate (4)
accepts four snap in data ports
Add \$37 list



M06
Mounting Plate (6)
accepts six snap in data ports
Add \$37 list



M00
Mounting Plates
Add \$37 list

STEP FOUR: Choose the Plate mounted port or Snap-in ports options for non-powered positions. As an aid, use the chart below to help design and build your Connexus™ to meet the rooms needs. Use the check boxes and list the components on the lines below.

Standard Connexus™

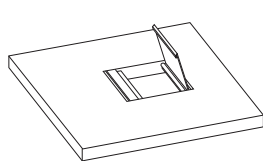
(A)	(B)	(C)
<input type="checkbox"/> POWER	<input type="checkbox"/> POWER/POWER & USB CHARGING	<input type="checkbox"/> POWER
OR	OR	OR
<input type="checkbox"/> PLATE MOUNTED PORT	<input type="checkbox"/> PLATE MOUNTED PORT	<input type="checkbox"/> PLATE MOUNTED PORT
OR	OR	OR
<input type="checkbox"/> SNAP-IN PORTS	<input type="checkbox"/> SNAP-IN PORTS	<input type="checkbox"/> SNAP-IN PORTS
_____	_____	_____
_____	_____	_____
_____	_____	_____

Large Connexus™

(A)	(B)	(C)	(D)
<input type="checkbox"/> POWER	<input type="checkbox"/> POWER/POWER & USB CHARGING	<input type="checkbox"/> POWER/POWER & USB CHARGING	<input type="checkbox"/> POWER
OR	OR	OR	OR
<input type="checkbox"/> PLATE MOUNTED PORT	<input type="checkbox"/> PLATE MOUNTED PORT	<input type="checkbox"/> PLATE MOUNTED PORT	<input type="checkbox"/> PLATE MOUNTED PORT
OR	OR	OR	OR
<input type="checkbox"/> SNAP-IN PORTS	<input type="checkbox"/> SNAP-IN PORTS	<input type="checkbox"/> SNAP-IN PORTS	<input type="checkbox"/> SNAP-IN PORTS
_____	_____	_____	_____
_____	_____	_____	_____
_____	_____	_____	_____

STEP FIVE: Select the Connexus™ Cover (Aluminum or Glass)

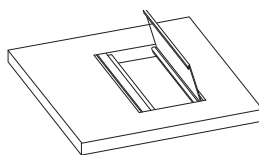
Standard Connexus™



3 GANG

3CCA	Aluminum	\$379 list
3CFG	Glass	\$468 list
3C00	No Lid	

Large Connexus™



4 GANG

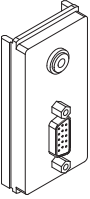
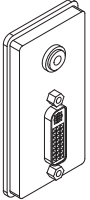
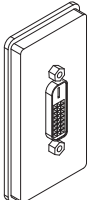
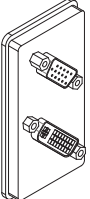
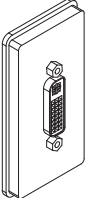
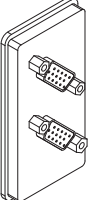
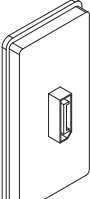
4CCA	Aluminum	\$391 list
4CFG	Glass	\$483 list
4C00	No Lid	

STEP SIX: Enclosure box is only required only when the Connexus™ is not positioned over a base. If an enclosure box is required, please clearly state this requirement on your order and add the **\$302** per Connexus™.

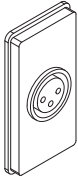
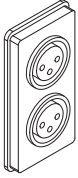
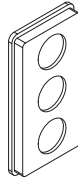
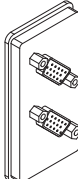
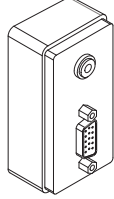
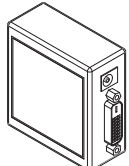
STEP SEVEN: Calculate the total list price for the custom Connexus™ by adding the following prices:

- Connexus™ Box with required AC Power Ports
- Faceplate (Snap-in Ports Only)
- Snap-In Ports or Plate Mounted Data Ports
- Enclosure Box (if required)
- Connexus™ Lid (Aluminum or Glass)

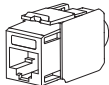


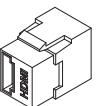



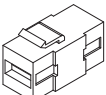
CONNEXUS™ | PORT OPTIONS

PLATE MOUNTED PORTS	Reference Code	Description	List Price
	P01	VGA & 3.5 STEREO MINI - Use for VGA (DB15) connections and for 3.5mm stereo connections. Connector is a female input with screw terminal output (back side of Console interface).	143
	P02	DVI-I DUAL (DIGITAL/ANALOG) & 3.5 STEREO MINI - Use for DVI Integrated - Digital and Analog connections and for 3.5mm stereo connection. The DVI connector is a Dual Link. DVI-I connector is a female-to-female pass through and the 3.5 Mini is a female input with screw terminal output (back side of Console interface).	212
	P03	DVI-D DUAL (DIGITAL) - Use for DVI-D Digital only connection. The connector is a Dual Link. Connector is a female-to-female pass through.	137
	P04	DVI-I DUAL (DIGITAL/ANALOG) & VGA - Use for DVI Integrated - Digital and Analog and for VGA (DB15) connections. The DVI connector is a Dual Link. Both connectors are female-to-female pass through.	271
	P05	DVI-I DUAL (DIGITAL/ANALOG) - Use for DVI Integrated -Digital and Analog connections. DVI connector is a Dual Link. Connector is a female-to-female pass through.	173
	P06	VGA-2 - Use for two VGA (DB15) connections. Both connectors are female-to-female pass through.	168
	P07	DISPLAYPORT - Use for DisplayPort connection. This connector is primarily used to connect a video source to a display device and also carries audio signals, Connector is a female input to a 3' corded output (back side of Console interface) with a male Display Port termination.	168


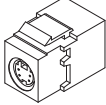
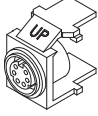
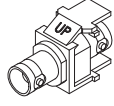
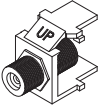
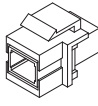
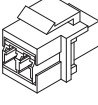
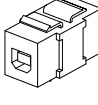
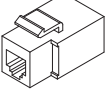

CONNEXUS™ | PORT OPTIONS

PLATE MOUNTED PORTS	Reference Code	Description	List Price
	P08	MICROPHONE XLR STANDARD - Use for standard size XLR microphone connection. Connector is a female input with a 3 pin screw terminal output (back side of Console interface).	228
	P09	MICROPHONE STANDARD XLR -2 - Use for two standard size XLR microphone connections. Each connector is a female input with a 3 pin screw terminal output (back side of Console interface).	333
	P10	3 HOLE CABLE PASS THROUGH - Use for running loose cables from the under side of the table up into the Console interface cavity. Often used with running wires for PolyCom™ devices.	54
	P11	VGA-to-BNCx2 - Use for two VGA (DB15) connections that are input female pass through and are terminated on the output (back side of Console interface) with 5 BNC female pigtail connections, for each VGA connector.	542
	P12	INPUT VGA & 3.5 Stereo (POWERED) - VGA + Audio Line Driver designed for VGA (DB15) connections and for 3.5mm stereo connections. This unit provides a method of transmitting signals to a remote display and audio receiver or amplifier. VGA connector is a female input and comes with cabling for either VGA output, or 5 BNC output and the 3.5 Mini is a female input with screw terminal output (back side of Console interface). A 9 volt DC 500mA power supply is required to power this unit.	1327
PORT ACCESSORIES	Reference Code	Description	List Price
	DVIR	DVI-REPEATER - Is a cable equalizer that automatically compensates for long DVI cable runs. This unit extends the usable cable distance up to 130ft depending on the quality of the cable and the resolution of the video signal. Additionally, it is capable of extending dual link signals allowing for much greater resolutions and refresh rates. This unit comes with a power supply and is generally mounted underneath a table.	1046

CONNEXUS™ | PORT OPTIONS

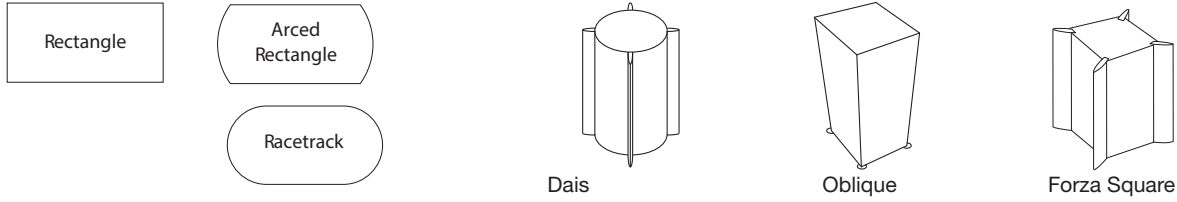
SNAP IN PORTS	Reference Code	Description	List Price
	S01W S01B S01R	RJ-45 - Category 6 data connection. This connector is also downwards compatible with Category 5 cabling. Connector is a female input with a #110 punch-down terminal block output (back side of Console interface) for on-site hard wire connection. RJ45-CAT6 (White) RJ45-CAT6 (Blue) RJ45-CAT6 (Red)	47
	S02W S02B S02G S02R S02Y	RJ11 - Telephone type connection. Connector is a female input with a #110 punch-down terminal block output (back side of Console interface) for on-site hard wire connection. RJ11 (White) RJ11-B (Black) RJ11-G (Green) RJ11-R (Red) RJ11-Y (Yellow)	32
	S03	3.5 STEREO MINI - 3.5mm stereo connection. Connector is a female input with screw terminal output (back side of Console interface).	92
	S04	HDMI - High Definition Multimedia Interface connection. Connector carries both HD audio and video data. Connector is a female-to-female pass through.	173
	S05	RCA-LEFT - RCA left audio channel connection. Color coded with black. Connector is a female-to-female pass through.	38
	S06	RCA-RIGHT -RCA right audio channel connection. Color coded with red. Connector is a female-to-female pass through.	38
	S07	RCA- VIDEO - RCA video channel connection. Color coded with yellow. Connector is a female-to-female pass through.	38
	S08	USB-A - Full size USB “A” style connection. Connector is a female-to-female pass through.	61

CONNEXUS™ | PORT OPTIONS

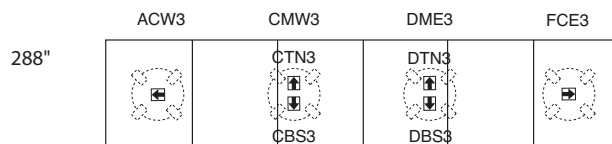
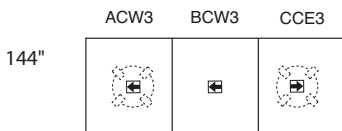
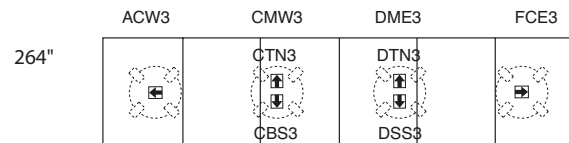
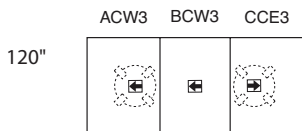
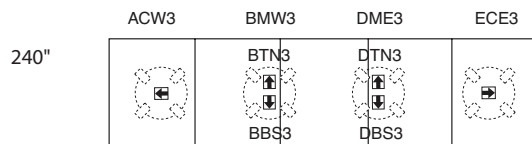
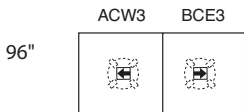
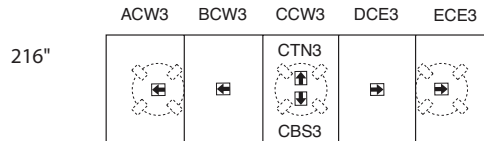
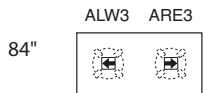
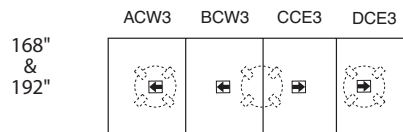
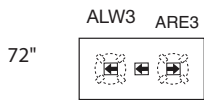
SNAP IN PORTS	Reference Code	Description	List Price
	S09	3 PIN MINI XLR - 3 Pin Mini XLR microphone connection. Connector is a female input to a 6' corded output (back side of Console interface) with a 3 Pin Mini XLR male termination.	739
	S10	S-VIDEO - S-Video connection. Connector is a female-to-female pass through.	68
	S11	PS/2 (6 PIN MINI DIN) - PS/2 (mouse, keyboard, other input devices) connections. Connector is a female-to-female pass through.	85
	S12	BNC - BNC style data connection for use with co-axial cable. Connector is a female-to-female pass through.	47
	S13	F-TYPE - F-Type (DSL,Cable) connections, generally for high speed Internet or video applications. Connector is a female-to-female threaded pass through.	38
	S14	FIBER OPTIC SC - Fibre Optic SC Simplex connection. Connector is a female-to-female pass through. Please note that two of these connectors are required to complete the data transmissions to and from the source and destination units.	47
	S15	FIBER OPTIC LC - Fibre Optic LC Duplex connection. Connector is a female-to-female pass through. One connector only is required to complete the data transmissions to and from source and destination units.	92
	S16	USB-B - USB "B" type connection. Connector is a female "B" input to a female "A" output (back side of Console interface). This connector is reversible.	137
	S17	RJ12 (White) - RJ12 style PolyCom™ connection. Connector is a female input with a 6' corded output (back side) of Console interface) with a male RJ12 termination.	295
	S00	BLANK COVER - Blank covers are required when port is not in use.	16

NOTE: Up to 6 snap-in data ports can be ordered for open data positions. Snap-in adaptors can accept 2, 4 or 6 snap-in data ports. Please order a blank port when an odd number of snap-in ports are specified.

VIRTU | CONNEXUS™ LOCATIONS CHARTS



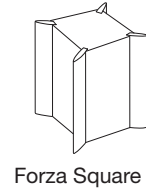
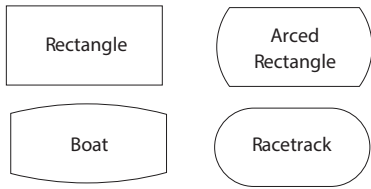
The Connexus™ Locations diagrams below show the available Connexus™ locations for only the top and base configurations shown above. **Please note that the maximum allowable Connexus™ modules per top are shown, and tops may be specified with fewer modules.** Each Connexus™ module has a code to represent its location on the table surface. To specify a Connexus™ module in a particular location, please use the code listed above it. Note that Large Connexus™ modules can only be specified on the outside sections of tops. **Connexus™ locations and quantities may be limited if Floor Monuments already exist at installation site. Please see Floor Monuments section for more information. For large Connexus™ units, please replace “3” in location code with “4”.** Codes that appear above table illustrations represent single center locations, in which unit will face West if on left end of top, and East if on right end of top. Note: For Connexus™ locations other than those shown below, contact Customer Service for upcharge.



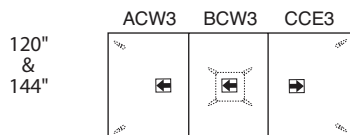
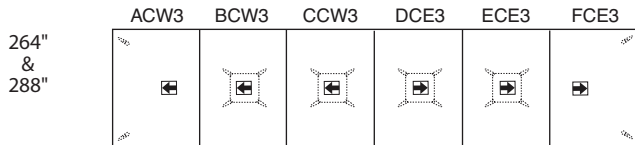
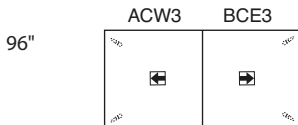
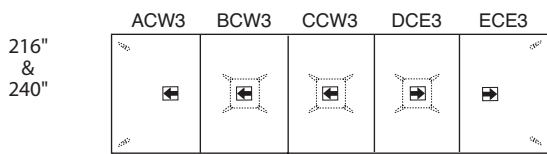
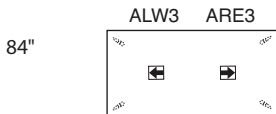
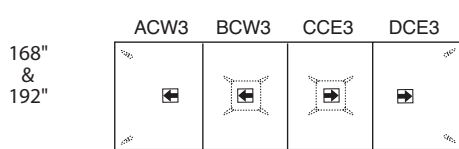
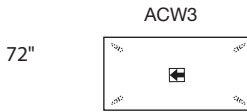
REPRESENTS MODULES THAT WHEN OPENED FACE THE ENDS OF THE TABLE

REPRESENTS MODULES THAT WHEN OPENED FACE THE SIDES OF THE TABLE

VIRTU | CONNEXUS™ LOCATIONS CHARTS



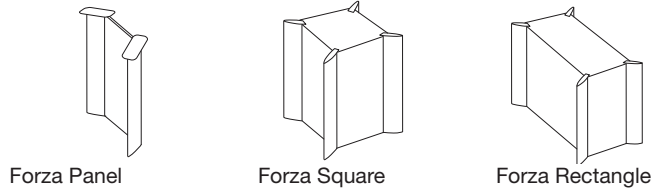
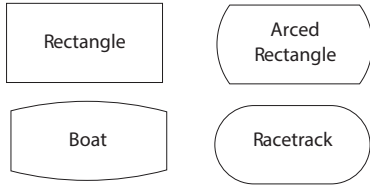
The Connexus™ Locations diagrams below show the available Connexus™ locations for only the top and base configurations shown above. **Please note that the maximum allowable Connexus™ modules per top are shown, and tops may be specified with fewer modules.** Each Connexus™ module has a code to represent its location on the table surface. To specify a Connexus™ module in a particular location, please use the code listed above it. Note that Large Connexus™ modules can only be specified on the outside sections of tops. **Connexus™ locations and quantities may be limited if Floor Monuments already exist at installation site. Please see Floor Monuments section for more information. For large Connexus™ units, please replace “3” in location code with “4”.** Codes that appear above table illustrations represent single center locations, in which unit will face West if on left end of top, and East if on right end of top. Note: For Connexus™ locations other than those shown below, contact Customer Service for upcharge.



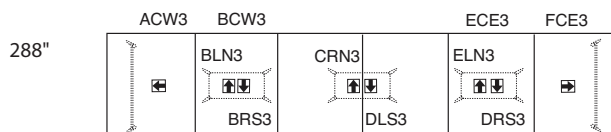
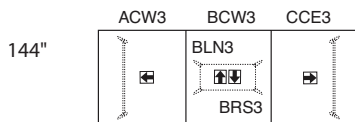
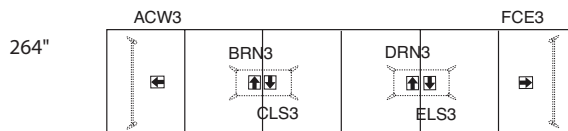
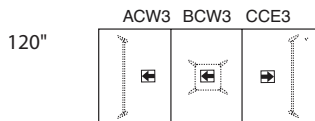
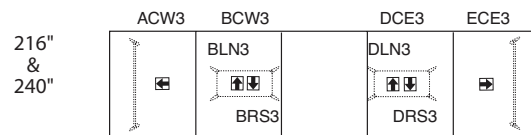
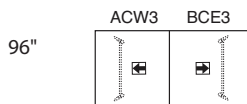
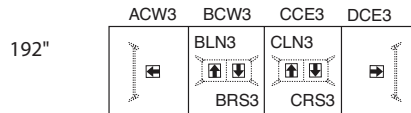
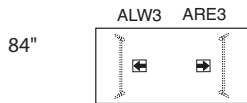
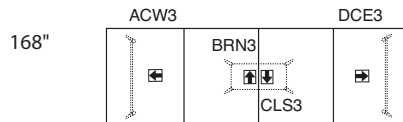
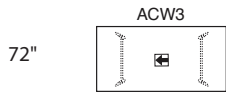
REPRESENTS MODULES THAT WHEN OPENED FACE THE ENDS OF THE TABLE

REPRESENTS MODULES THAT WHEN OPENED FACE THE SIDES OF THE TABLE

VIRTU | CONNEXUS™ LOCATIONS CHARTS



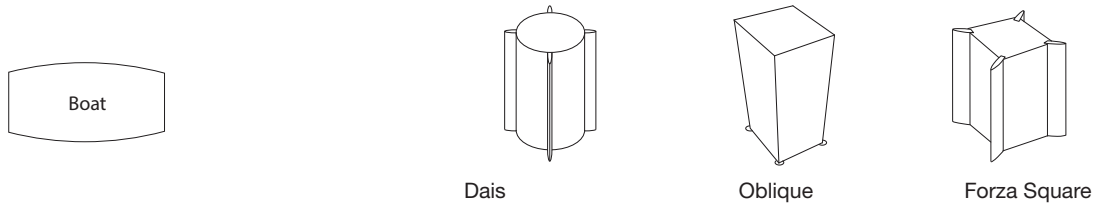
The Connexus™ Locations diagrams below show the available Connexus™ locations for only the top and base configurations shown above. **Please note that the maximum allowable Connexus™ modules per top are shown, and tops may be specified with fewer modules.** Each Connexus™ module has a code to represent its location on the table surface. To specify a Connexus™ module in a particular location, please use the code listed above it. Note that Large Connexus™ modules can only be specified on the outside sections of tops. **Connexus™ locations and quantities may be limited if Floor Monuments already exist at installation site. Please see Floor Monuments section for more information. For large Connexus™ units, please replace “3” in location code with “4”.** Codes that appear above table illustrations represent single center locations, in which unit will face West if on left end of top, and East if on right end of top. Note: For Connexus™ locations other than those shown below, contact Customer Service for upcharge.



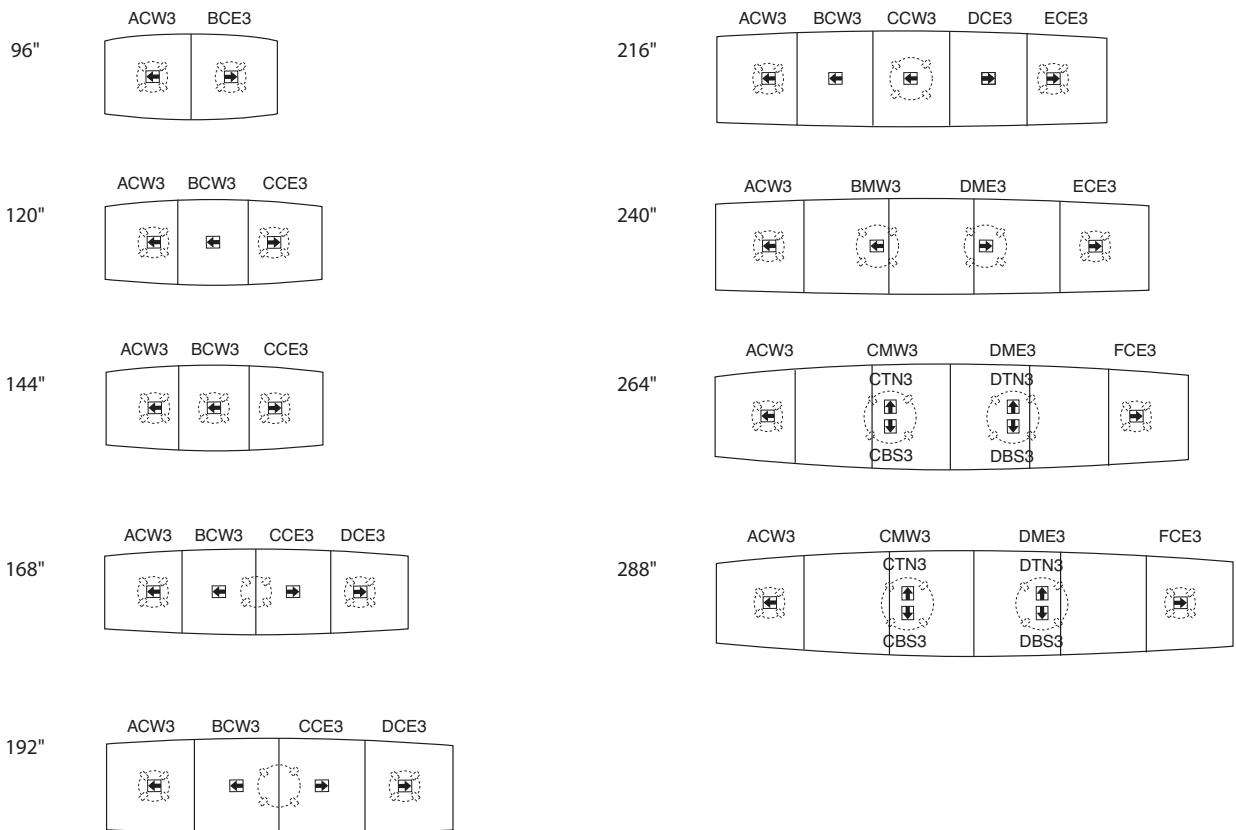
REPRESENTS MODULES THAT WHEN OPENED FACE THE ENDS OF THE TABLE



REPRESENTS MODULES THAT WHEN OPENED FACE THE SIDES OF THE TABLE



VIRTU | CONNEXUS™ LOCATIONS CHARTS



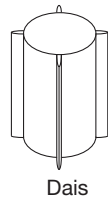
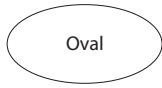
The Connexus™ Locations diagrams below show the available Connexus™ locations for only the top and base configurations shown above. **Please note that the maximum allowable Connexus™ modules per top are shown, and tops may be specified with fewer modules.** Each Connexus™ module has a code to represent its location on the table surface. To specify a Connexus™ module in a particular location, please use the code listed above it. Note that Large Connexus™ modules can only be specified on the outside sections of tops. **Connexus™ locations and quantities may be limited if Floor Monuments already exist at installation site. Please see Floor Monuments section for more information. For large Connexus™ units, please replace “3” in location code with “4”.** Codes that appear above table illustrations represent single center locations, in which unit will face West if on left end of top, and East if on right end of top. Note: For Connexus™ locations other than those shown below, contact Customer Service for upcharge.



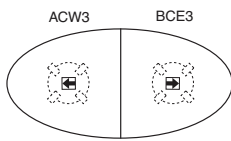
  REPRESENTS MODULES THAT WHEN OPENED FACE THE ENDS OF THE TABLE

  REPRESENTS MODULES THAT WHEN OPENED FACE THE SIDES OF THE TABLE

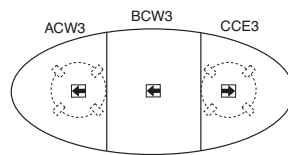
VIRTU | CONNEXUS™ LOCATIONS CHARTS



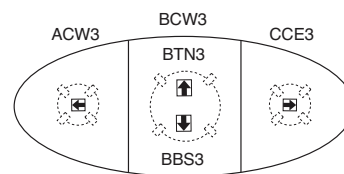
The Connexus™ Locations diagrams below show the available Connexus™ locations for only the top and base configurations shown above. **Please note that the maximum allowable Connexus™ modules per top are shown, and tops may be specified with fewer modules.** Each Connexus™ module has a code to represent its location on the table surface. To specify a Connexus™ module in a particular location, please use the code listed above it. Note that Large Connexus™ modules can only be specified on the outside sections of tops. **Connexus™ locations and quantities may be limited if Floor Monuments already exist at installation site. Please see Floor Monuments section for more information. For large Connexus™ units, please replace “3” in location code with “4”.** Codes that appear above table illustrations represent single center locations, in which unit will face West if on left end of top, and East if on right end of top. Note: For Connexus™ locations other than those shown below, contact Customer Service for upcharge.



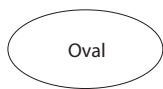
96"



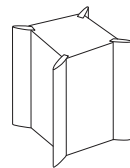
120"



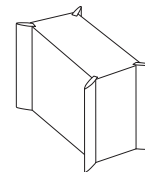
144"



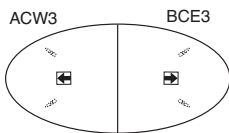
Forza Leg



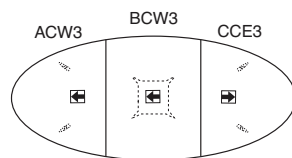
Forza Square



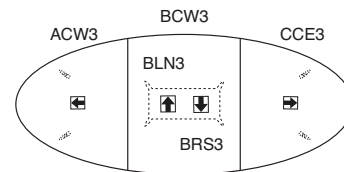
Forza Rectangle





96"





120"

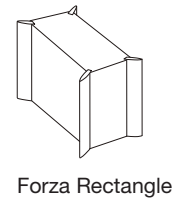
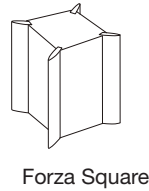
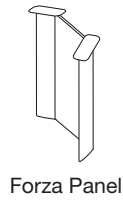


144"

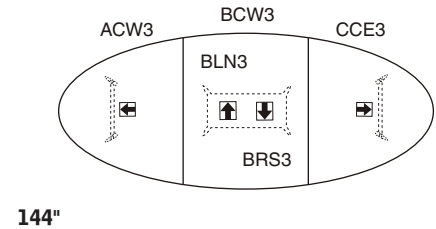
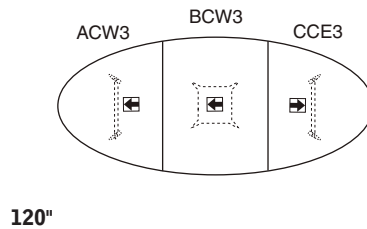
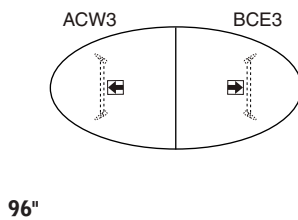
  REPRESENTS MODULES THAT WHEN OPENED FACE THE ENDS OF THE TABLE

  REPRESENTS MODULES THAT WHEN OPENED FACE THE SIDES OF THE TABLE

VIRTU | CONNEXUS™ LOCATIONS CHARTS



The Connexus™ Locations diagrams below show the available Connexus™ locations for only the top and base configurations shown above. **Please note that the maximum allowable Connexus™ modules per top are shown, and tops may be specified with fewer modules.** Each Connexus™ module has a code to represent its location on the table surface. To specify a Connexus™ module in a particular location, please use the code listed above it. Note that Large Connexus™ modules can only be specified on the outside sections of tops. **Connexus™ locations and quantities may be limited if Floor Monuments already exist at installation site. Please see Floor Monuments section for more information. For large Connexus™ units, please replace “3” in location code with “4”.** Codes that appear above table illustrations represent single center locations, in which unit will face West if on left end of top, and East if on right end of top. Note: For Connexus™ locations other than those shown below, contact Customer Service for upcharge.



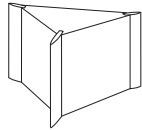
  REPRESENTS MODULES THAT WHEN OPENED FACE THE ENDS OF THE TABLE

  REPRESENTS MODULES THAT WHEN OPENED FACE THE SIDES OF THE TABLE

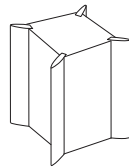
VIRTU | CONNEXUS™ LOCATIONS CHARTS



Verso

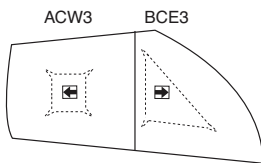


Verso

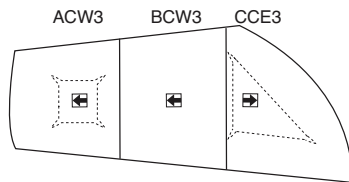


Forza Square

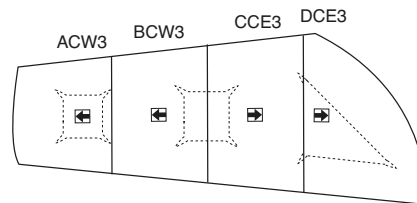
The Connexus™ Locations diagrams below show the available Connexus™ locations for only the top and base configurations shown above. **Please note that the maximum allowable Connexus™ modules per top are shown, and tops may be specified with fewer modules.** Each Connexus™ module has a code to represent its location on the table surface. To specify a Connexus™ module in a particular location, please use the code listed above it. Note that Large Connexus™ modules can only be specified on the outside sections of tops. **Connexus™ locations and quantities may be limited if Floor Monuments already exist at installation site. Please see Floor Monuments section for more information. For large Connexus™ units, please replace “3” in location code with “4”.** Codes that appear above table illustrations represent single center locations, in which unit will face West if on left end of top, and East if on right end of top. Note: For Connexus™ locations other than those shown below, contact Customer Service for upcharge.



107"



137"



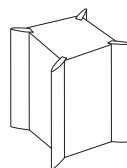
168"



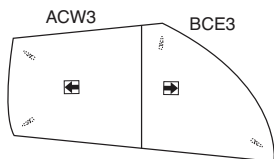
Verso



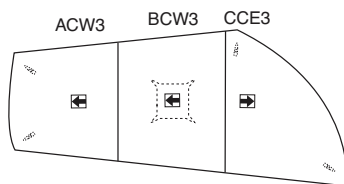
Forza Leg



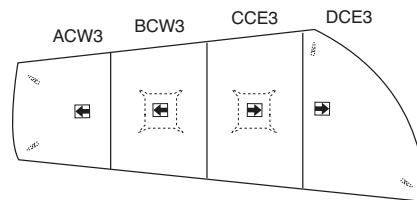
Forza Square





107"





137"



168"

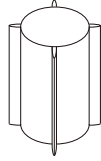


 REPRESENTS MODULES THAT WHEN OPENED FACE THE ENDS OF THE TABLE



 REPRESENTS MODULES THAT WHEN OPENED FACE THE SIDES OF THE TABLE

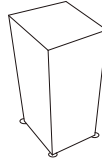
VIRTU | CONNEXUS™ LOCATIONS CHARTS



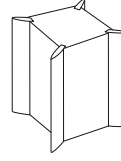
Visio



Dais

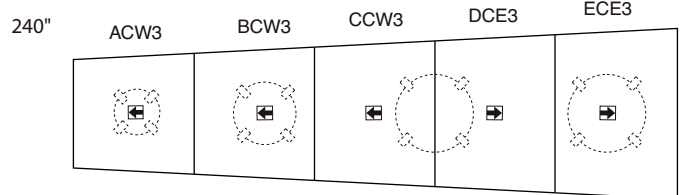
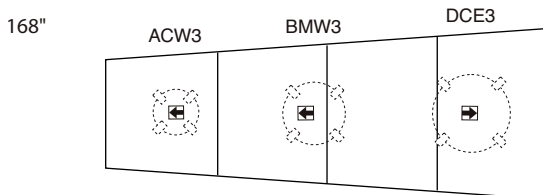
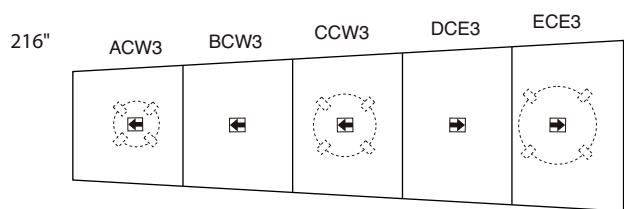
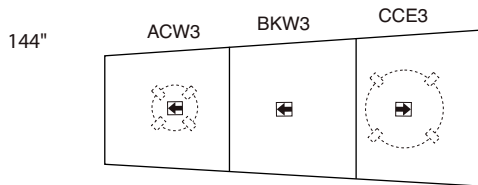
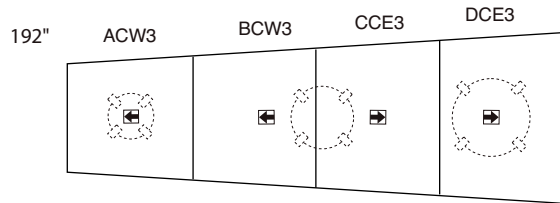
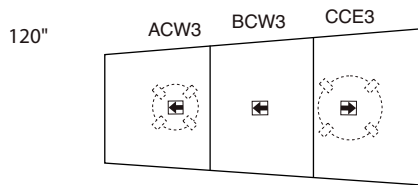




Oblique





Forza Square

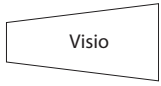
The Connexus™ Locations diagrams below show the available Connexus™ locations for only the top and base configurations shown above. **Please note that the maximum allowable Connexus™ modules per top are shown, and tops may be specified with fewer modules.** Each Connexus™ module has a code to represent its location on the table surface. To specify a Connexus™ module in a particular location, please use the code listed above it. Note that Large Connexus™ modules can only be specified on the outside sections of tops. **Connexus™ locations and quantities may be limited if Floor Monuments already exist at installation site. Please see Floor Monuments section for more information. For large Connexus™ units, please replace “3” in location code with “4”.** Codes that appear above table illustrations represent single center locations, in which unit will face West if on left end of top, and East if on right end of top. Note: For Connexus™ locations other than those shown below, contact Customer Service for upcharge.



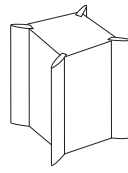


 REPRESENTS MODULES THAT
WHEN OPENED FACE THE ENDS
OF THE TABLE



 REPRESENTS MODULES THAT
WHEN OPENED FACE THE SIDES
OF THE TABLE

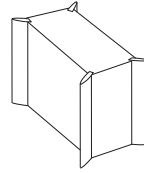
VIRTU | CONNEXUS™ LOCATIONS CHARTS



Forza Panel

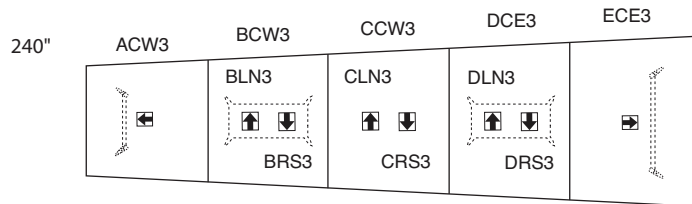
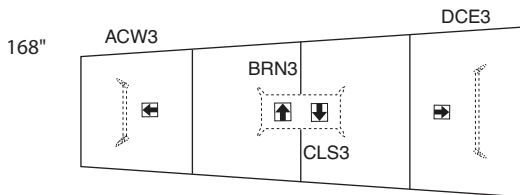
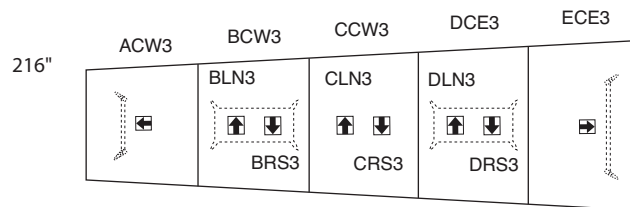
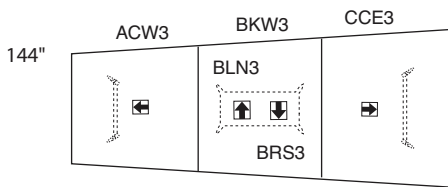
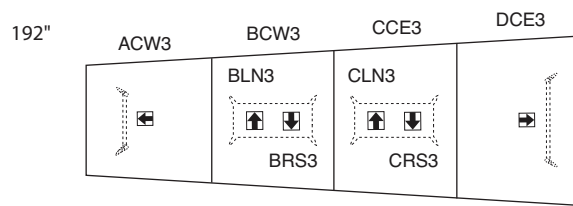
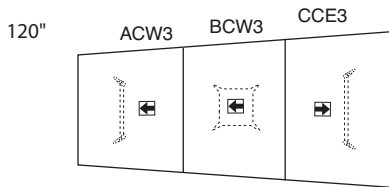


Forza Square



Forza Rectangle

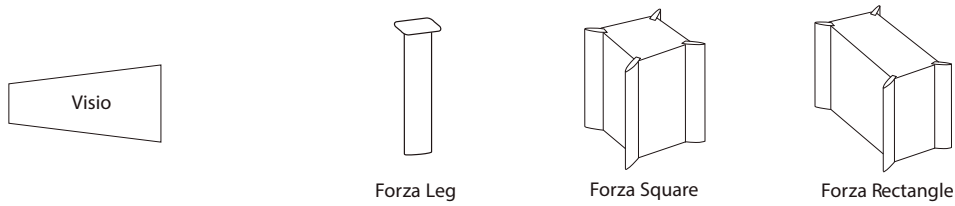
The Connexus™ Locations diagrams below show the available Connexus™ locations for only the top and base configurations shown above. **Please note that the maximum allowable Connexus™ modules per top are shown, and tops may be specified with fewer modules.** Each Connexus™ module has a code to represent its location on the table surface. To specify a Connexus™ module in a particular location, please use the code listed above it. Note that Large Connexus™ modules can only be specified on the outside sections of tops. **Connexus™ locations and quantities may be limited if Floor Monuments already exist at installation site. Please see Floor Monuments section for more information. For large Connexus™ units, please replace “3” in location code with “4”.** Codes that appear above table illustrations represent single center locations, in which unit will face West if on left end of top, and East if on right end of top. Note: For Connexus™ locations other than those shown below, contact Customer Service for upcharge.



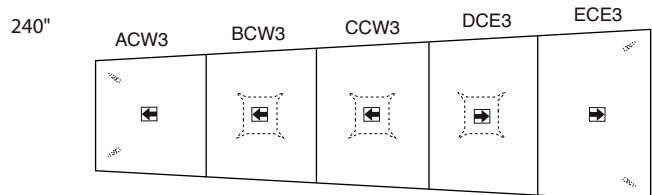
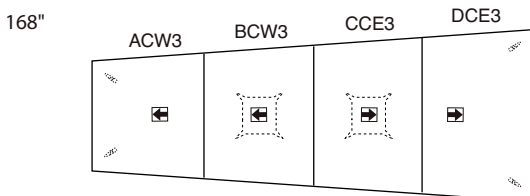
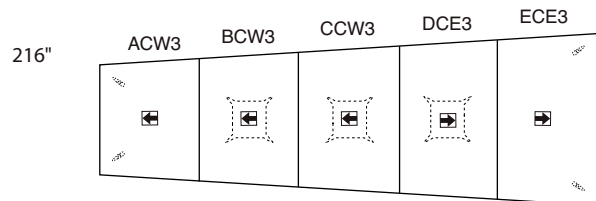
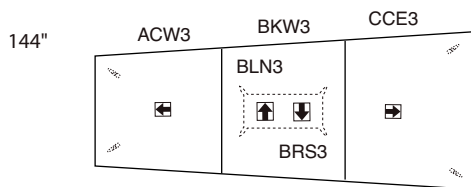
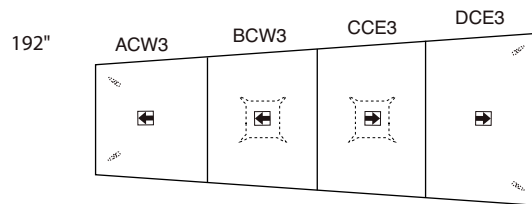
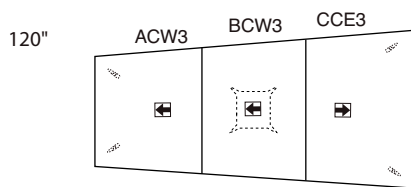
REPRESENTS MODULES THAT WHEN OPENED FACE THE ENDS OF THE TABLE

REPRESENTS MODULES THAT WHEN OPENED FACE THE SIDES OF THE TABLE

VIRTU | CONNEXUS™ | LOCATIONS CHARTS



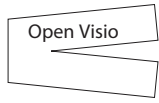
The Connexus™ Locations diagrams below show the available Connexus™ locations for only the top and base configurations shown above. **Please note that the maximum allowable Connexus™ modules per top are shown, and tops may be specified with fewer modules.** Each Connexus™ module has a code to represent its location on the table surface. To specify a Connexus™ module in a particular location, please use the code listed above it. Note that Large Connexus™ modules can only be specified on the outside sections of tops. **Connexus™ locations and quantities may be limited if Floor Monuments already exist at installation site. Please see Floor Monuments section for more information. For large Connexus™ units, please replace “3” in location code with “4”.** Codes that appear above table illustrations represent single center locations, in which unit will face West if on left end of top, and East if on right end of top. Note: For Connexus™ locations other than those shown below, contact Customer Service for upcharge.



REPRESENTS MODULES THAT WHEN OPENED FACE THE ENDS OF THE TABLE

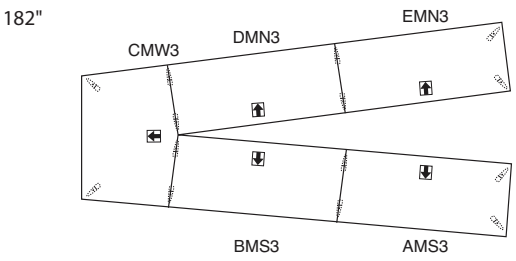
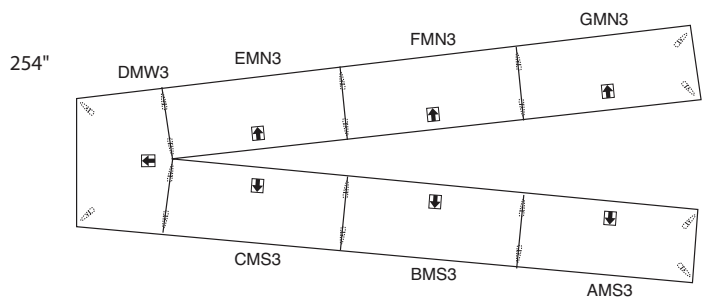
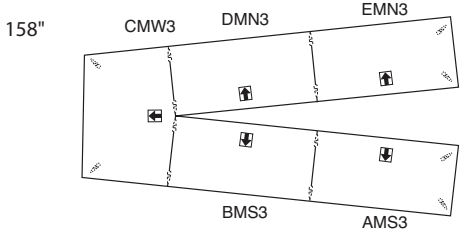
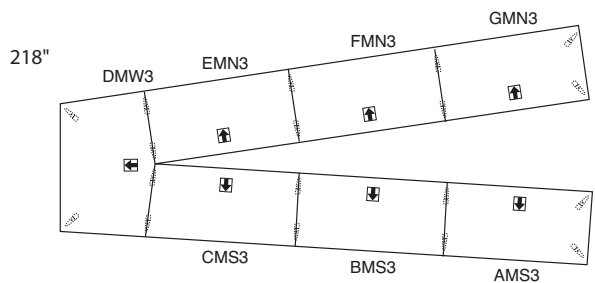
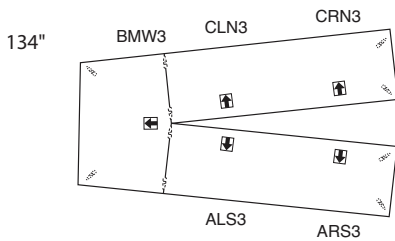
REPRESENTS MODULES THAT WHEN OPENED FACE THE SIDES OF THE TABLE

VIRTU | CONNEXUS™ LOCATIONS CHARTS



Forza

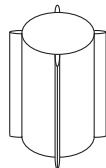
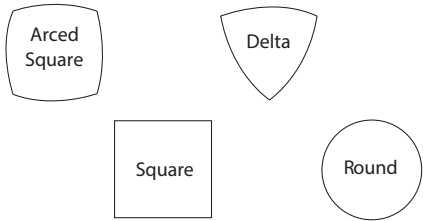
The Connexus™ Locations diagrams below show the available Connexus™ locations for only the top and base configurations shown above. **Please note that the maximum allowable Connexus™ modules per top are shown, and tops may be specified with fewer modules.** Each Connexus™ module has a code to represent its location on the table surface. To specify a Connexus™ module in a particular location, please use the code listed above it. Note that Large Connexus™ modules can only be specified on the outside sections of tops. **Connexus™ locations and quantities may be limited if Floor Monuments already exist at installation site. Please see Floor Monuments section for more information. For large Connexus™ units, please replace “3” in location code with “4”.** Codes that appear above table illustrations represent single center locations, in which unit will face West if on left end of top, and East if on right end of top. Note: For Connexus™ locations other than those shown below, contact Customer Service for upcharge.



◀ ▶ REPRESENTS MODULES THAT WHEN OPENED FACE THE ENDS OF THE TABLE

⬇ ⬆ REPRESENTS MODULES THAT WHEN OPENED FACE THE SIDES OF THE TABLE

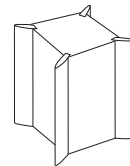
VIRTU | CONNEXUS™ | LOCATIONS CHARTS



Dais

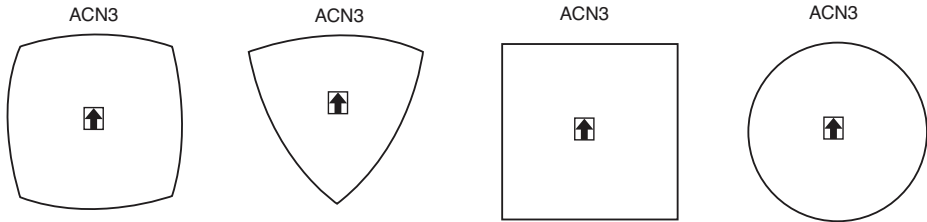


Forza Leg




Forza Square

The Connexus™ Location , “C”, is the only code required when specifying a Connexus™ module on a Round, Square, Arced Square or Delta table. For large Connexus™ units, please replace “3” in location code with “4”. Codes that appear above table illustrations represent single center locations, in which unit will face West if on left end of top, and East if on right end of top. Note: For Connexus™ locations other than those shown below, contact Customer Service for upcharge.



Note: It is recommended that Connexus™ Modules not be specified on 36" and 42" Delta tops and 42" Arced Square, Round and Square tops when used in conjunction with Forza Leg bases due to leg room constraints.

 REPRESENTS MODULES THAT WHEN OPENED FACE THE SIDES OF THE TABLE

VIRTU | FLOOR MONUMENT LOCATIONS

FLOOR MONUMENT LOCATIONS

All VIRTU table bases and casegoods designed for use with office equipment provide wire management with easy door access to floor and wall monuments. This allows for change and updating of wiring throughout the product without having to take furniture apart and re-install it. We've provided in this guide helpful information on the optimum locations of floor monuments in relation to the table base locations, so that you can position each appropriately. Follow the New Monument Locations guidelines to determine these positions. We've also given you steps for determining what locations and quantities of Connexus™ modules are available if floor monuments already exist at the installation site. Follow the Existing Monument Locations guidelines if this applies.

NEW MONUMENT LOCATIONS

Steps to Determine Recommended Floor Monument Location Codes for Tables

1. In the "Chart A" section, locate the page which represents the Base(s) and Top Shape for your table, which are listed at the top of each page.
2. Locate your "Top Size" and "Top Shape" from the chart on that page.
3. On the left, you will see a diagram with "Codes" indicated for Recommended Monument Locations.
4. Select the Code(s) for your preferred Monument Location(s) and note for ordering purposes.

Note: Some restrictions apply in selecting Monument Locations, due to pre-determined electrical cord lengths. See Electrical Cord Lengths details.

Steps to Determine Recommended Monument Location Measurements

1. In the "Chart B" section, locate the page which represents the Bases(s) and Top Shape for your table, which are located at the top of each chart.
2. Locate your "Top Size".
3. Cross reference your table size with the "Codes" that you have selected for your table.

Note: The measurements listed represent the distance in inches that a particular "Code" is from the left edge of your table. The shaded columns, ML and MR, represent the distance in inches that a particular "Code" is from the center line (lengthwise) of the table.

EXISTING MONUMENT LOCATIONS

If your VIRTU Conference Table is to be installed in a room with existing floor monuments, please use the following steps to determine the available location(s) and quantity of Connexus™ modules.

1. Create an overhead view of the room in which your conference table is to be located, including measurements of floor space.
2. Sketch in an outline of your conference table in the position you would like it to be located in the room.
3. Measure the exact positions of the existing floor monuments in relation to the perimeter of your conference table.
4. Follow the steps outlined in Electrical Cord Lengths to determine the available locations(s) and quantity of Connexus™ modules.
5. Submit the overhead view of the room with your purchase order so that Krug can provide the proper electrical cord lengths with your order.

It is recommended that a flush floor mounted monument is specified to best facilitate access into all VIRTU bases. Monument locations listed within "Chart B" provide dimensional information as it relates to the position of the monuments and bases. Enclosed bases have been designed to be placed over top of the monument, while tables supported with Forza Leg and Forza Panel bases have the monuments located offset to the leg. Please note that the measurements listed are the optimum location for Floor Monuments so that wiring does not interfere with the users. The monument will require a minimum of one dedicated receptacle and provision for communication wire passage as well. Monuments with combined electrical capabilities will restrict the number of communication cables for use. For situations requiring large amounts of communication wiring, we highly recommend entering the table through another base from a monument designed for communication wires only. The Floor Monument charts and diagrams are also designed to help determine the proper cord length designations. In order for Krug to supply the proper length of electrical cords for VIRTU Conference tops specified with Connexus™ modules, the user must specify Monument Location Codes which can be found in these drawings. If floor monuments already exist, please provide an overhead room layout, with exact measurements of your conference table and monuments positions, as outlined in Existing Monument Locations.

ELECTRICAL CORD LENGTHS

Connexus™ Modules come with pre-determined electrical cord lengths that are suited to the size and configuration of each table. Each will plug into a standard floor monument power source. However, in situations where a table length exceeds our maximum cord length, a second power entry is necessary to avoid daisy-chaining of electrical power. To determine when a second power entry is required please follow these steps.

1. Select your Connexus™ Location(s).
2. Select your Floor Monument Location(s) if they do not already exist in the room.
3. If the number of Connexus™ Modules exceed three consecutive positions left or right of the power entry, then an additional power entry will be required. Refer to the Connexus™ Diagrams that illustrate the base and tabletop combination of your selection.

Note: Connexus™ Modules in pairs count as one position.

* Open Visio tables require 2 power sources, one per wing, or a single power source located at the apex of the two tables.

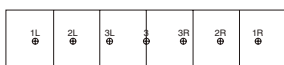
Example 1

If the designated Floor Monument location for the table scenario shown below is 1L, the user would be able to power-up any or all of the following Connexus™ locations: ACW3, BCW3 and CCW3.

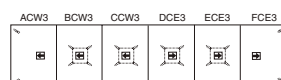
Example 2

If the designated Floor Monument location for the table scenario shown below is 2R, the user would be able to power-up any or all of the following Connexus™ locations: CCW3, DCE3, ECE3 and FCE3.

Monument Location Scenario



Connexus™ Location Scenario

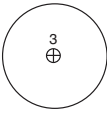

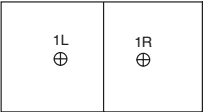

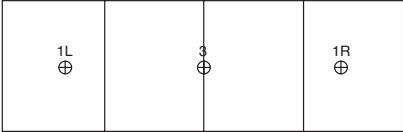
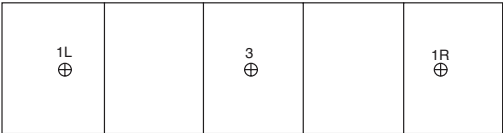
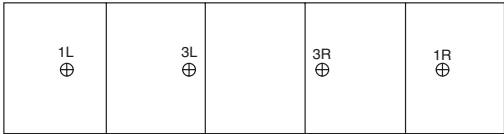



1L 2L 3L 3R 2R 1R
ACW3 BCW3 CCW3 DCE3 ECE3 FCE3

VIRTU | RECOMMENDED FLOOR MONUMENT LOCATIONS

Chart A

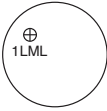
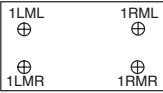
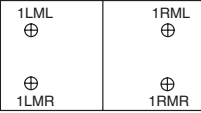
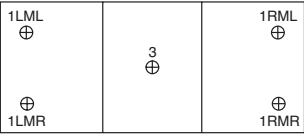
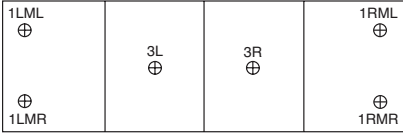
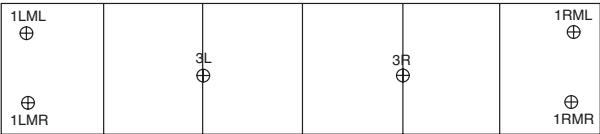
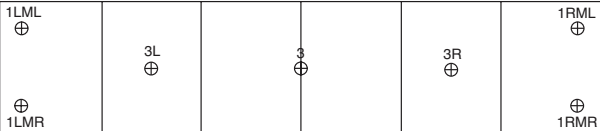
Top Shapes:	<ul style="list-style-type: none"> • Rectangle • Boat • Square 	<ul style="list-style-type: none"> • Arced Rectangle • Round • Arced Square 	<ul style="list-style-type: none"> • Racetrack • Delta
Bases:	<ul style="list-style-type: none"> • Dais 	<ul style="list-style-type: none"> • Forza Square 	<ul style="list-style-type: none"> • Oblique

CODES	TOP SIZE	TOP SHAPES
		Round, Delta, Square, Arced Square
	72-36 84-42	Rectangle, Arced Rectangle, Racetrack
	96-42 96-48-42 96-48	Rectangle, Arced Rectangle, Racetrack, Boat
	120-48 20-48-42 120-54 144-54	Rectangle, Arced Rectangle, Racetrack, Boat
	144-48-42 168-42-42 168-54 192-54 192-54-48	Rectangle, Arced Rectangle, Racetrack, Boat
	216-54-48 216-60	Rectangle, Arced Rectangle, Racetrack, Boat
	240-54-48 240-60	Rectangle, Arced Rectangle, Racetrack, Boat
	264-60 264-60-48 288-60 288-60-48	Rectangle, Arced Rectangle, Racetrack, Boat

VIRTU | RECOMMENDED FLOOR MONUMENT LOCATIONS

Chart A

Top Shapes:	<ul style="list-style-type: none"> • Rectangle • Boat • Square 	<ul style="list-style-type: none"> • Arced Rectangle • Round • Arced Square 	<ul style="list-style-type: none"> • Racetrack • Delta
Bases:	<ul style="list-style-type: none"> • Forza Leg 	<ul style="list-style-type: none"> • Forza Leg with Forza Square 	<ul style="list-style-type: none"> • Forza Leg with Forza Rectangle

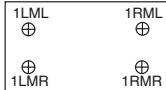
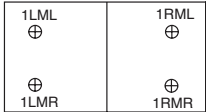
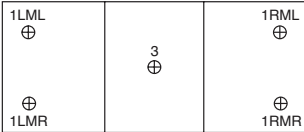
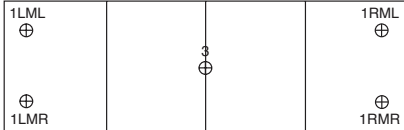
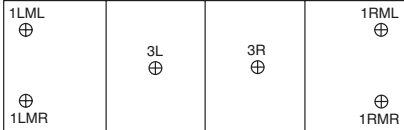
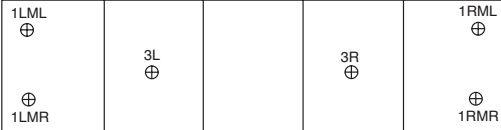

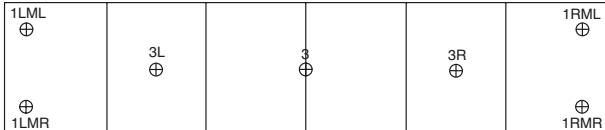
CODES	TOP SIZE	TOP SHAPES
		Round, Delta, Square, Arced Square
	72-36 84-42	Rectangle, Arced Rectangle, Racetrack
	72-36 84-42 96-42 96-48 96-48-42	Rectangle, Arced Rectangle, Racetrack, Boat
	120-48 120-48-42 120-54 144-48-42 144-54	Rectangle, Arced Rectangle, Racetrack, Boat
	168-48-42 168-54 192-54 192-54-48	Rectangle, Arced Rectangle, Racetrack, Boat
	216-54-48 16-60 240-54-48 240-60	Rectangle, Arced Rectangle, Racetrack, Boat
	264-60 64-60-48 288-60 288-60-48	Rectangle, Arced Rectangle, Racetrack, Boat

VIRTU | RECOMMENDED FLOOR MONUMENT LOCATIONS

Chart A

Top Shapes: • Rectangle • Arced Rectangle • Racetrack • Boat

Bases: • Forza Panel • Forza Panel with Forza Square • Forza Panel with Forza Rectangle

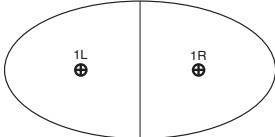
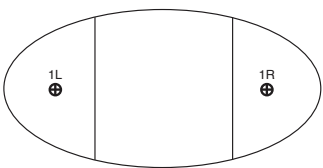
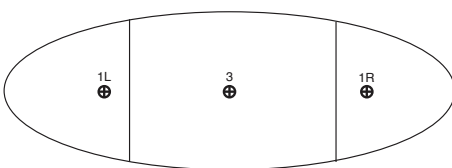
CODES	TOP SIZE	TOP SHAPES
	72-36 84-42	Rectangle, Arced Rectangle, Racetrack
	96-42 96-48-42 96-48	Rectangle, Arced Rectangle, Racetrack, Boat
	120-48 120-48-42 120-54 144-48-42 144-54	Rectangle, Arced Rectangle, Racetrack, Boat
	168-48-42 168-54	Rectangle, Arced Rectangle, Racetrack, Boat
	192-54 192-54-48	Rectangle, Arced Rectangle, Racetrack, Boat
	216-54-48 216-60 240-54-48 240-60	Rectangle, Arced Rectangle, Racetrack, Boat
	264-60 264-60-48	Rectangle, Arced Rectangle, Racetrack, Boat
	288-60 88-60-48	Rectangle, Arced Rectangle, Racetrack, Boat

VIRTU | RECOMMENDED FLOOR MONUMENT LOCATIONS

Chart A

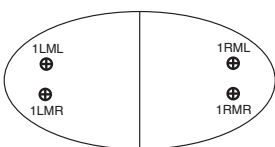
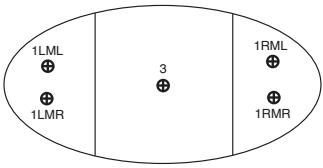
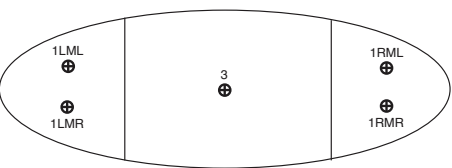
Top Shapes: • Oval

Bases: • Dais

CODES	TOP SIZE
	96-48
	120-54
	

Top Shape: • Oval

Bases: • Forza Leg • Forza Leg with Forza Square • Forza Leg with Forza Rectangle
 • Forza Panel with Forza Square • Forza Panel • Forza Panel with Forza Rectangle

CODES	TOP SIZE
	96-48
	120-54
	144-60

VIRTU | RECOMMENDED FLOOR MONUMENT LOCATIONS

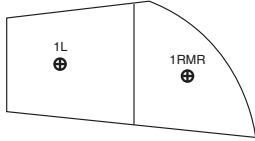
Chart A

Top Shapes: • Verso

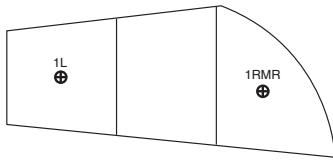
Bases: • Forza Square • Verso

CODES

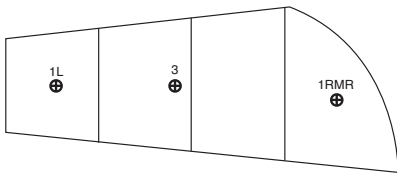
TOP SIZE



107-57-40



137-63-40



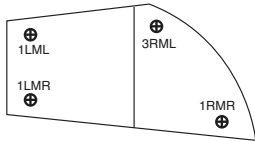
167-70-40

Top Shapes: • Verso

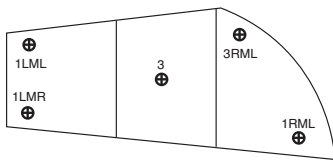
Bases: • Forza Leg • Forza Leg with Forza Square

CODES

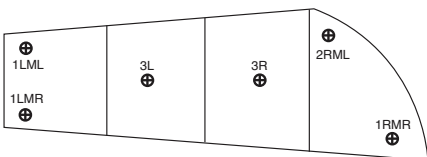
TOP SIZE



107-57-40



137-63-40



167-70-40

VIRTU | RECOMMENDED FLOOR MONUMENT LOCATIONS

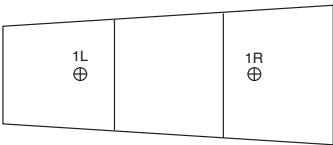
Chart A

Top Shapes: • Visio

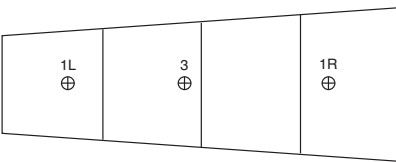
Bases: • Forza Square • Dais
• Oblique

CODES

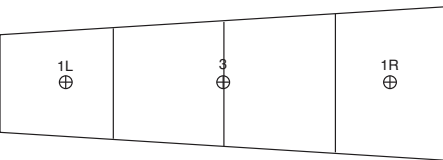
TOP SIZE



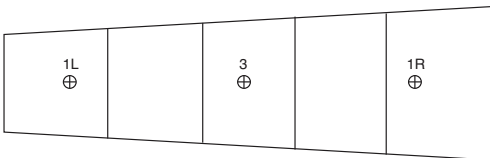
120-60-42
144-60-42



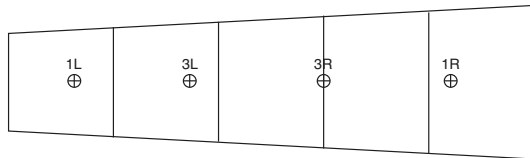
168-60-42



192-66-42



216-73-42



240-76-42

VIRTU | RECOMMENDED FLOOR MONUMENT LOCATIONS

Chart A

Top Shapes:

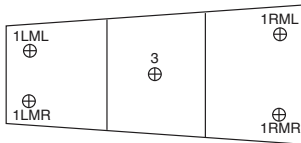
- Visio

Bases:

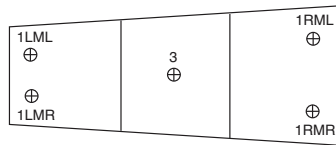
- Forza Leg with Forza Square
- Forza Leg with Forza Rectangle
- Forza Panel with Forza Square
- Forza Panel with Rectangle

CODES

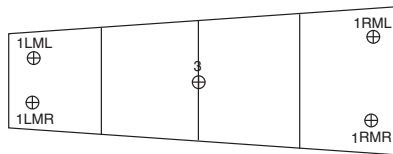
TOP SIZE



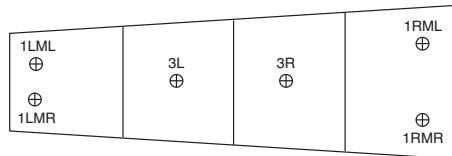
120-60-42



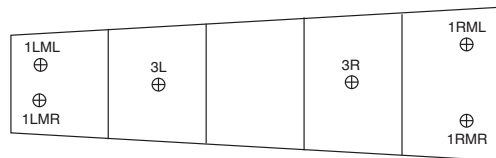
144-60-42



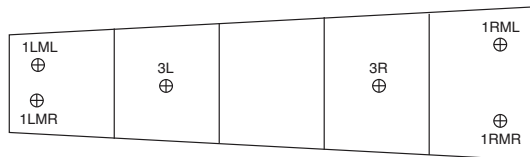
168-60-42



192-69-42



216-73-42



240-76-42

VIRTU | RECOMMENDED FLOOR MONUMENT LOCATIONS

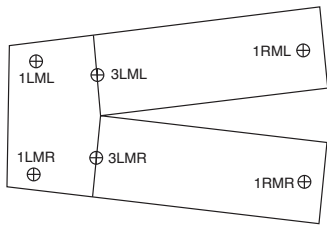
Chart A

Top Shapes: • Open Visio

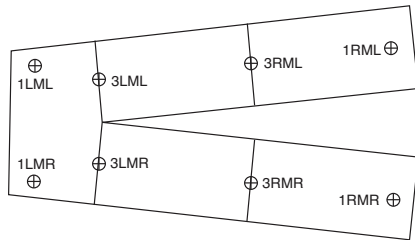
Bases: • Forza Leg

CODES

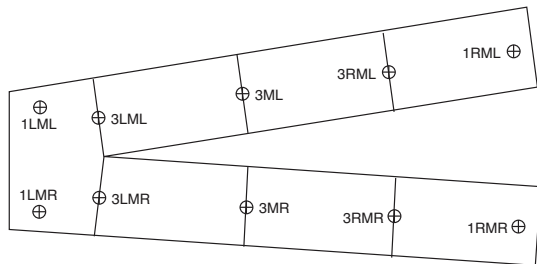
TOP SIZE



134-80-52
134-92-64



158-85-52
158-96-64
182-90-52
182-102-64



218-97-52
218-109-64
254-105-52
254-117-64

VIRTU | RECOMMENDED FLOOR MONUMENT LOCATIONS

Chart B

Top Shapes:	<ul style="list-style-type: none"> • Rectangle • Delta 	<ul style="list-style-type: none"> • Arced Rectangle • Square 	<ul style="list-style-type: none"> • Racetrack • Arced Square 	<ul style="list-style-type: none"> • Boat • Round
Bases:	<ul style="list-style-type: none"> • Dais 	<ul style="list-style-type: none"> • Forza Square 	<ul style="list-style-type: none"> • Oblique 	

Indicates distance in inches from the left end of table to center of monument

Indicates distance in inches from center line (*lengthwise*) of table to center of monument

	CODES								
	1L	2L	3L	3	3R	2R	1R	ML	MR
42 dia				21					
42-42 square				21					
42-42 arched square				21					
42 delta				18					
48 dia				24					
48-48 square				24					
48-48 arched square				21					
48 delta									
54 dia				21					
54-54 square				21					
54-54 arched square				21					
54 delta				18					
60 dia				21					
60-60 square				21					
60-60 arched square				21					
60 delta				18					
72-36	18						54		
84-42	24						59		
96-42	26						70		
96-48	26						70		
96-48-42	26						70		
120-48	27						93		
120-48-42	27						93		
120-54	27						93		
144-54	27						117		
144-48-42	27			72			117		
168-54	27			84			141		
168-48-42	27			84			141		
192-54	27			96			165		
192-54-48	27			96			165		
216-54-48	29			108			186		
216-60	29			108			186		
240-54-48	30		90		150		210		
240-60	30		90		150		210		
264-60	30		98		166		234		
264-60-48	30		98		166		234		
288-60	30		107		181		258		
288-60-48	30		107		181		258		

VIRTU | RECOMMENDED FLOOR MONUMENT LOCATIONS

Chart B

Top Shapes: • Rectangle • Arced Rectangle • Racetrack • Boat
 • Delta • Square • Arced Square • Round

Bases: • Dais • Forza Square • Oblique

Indicates distance in inches from the left end of table to center of monument

Indicates distance in inches from center line (*lengthwise*) of table to center of monument

	CODES								
	1L	2L	3L	3	3R	2R	1R	ML	MR
42 dia.	13								
42-42 square	12							12	
42-42 arched square	13							13	
42 delta	14								
48 dia.	13								
48-48 square	12							12	
48-48 arched square	13							13	
48 delta	14								
54 dia.	13								
54-54 square	12							12	
54-54 arched square	13							13	
54 delta	14								
60 dia.	13								
60-60 square	12							12	
60-60 arched square	13							13	
60 delta	14								
72-36	12						59	8	8
84-42	12						71	11	11
96-42	12						83	11	11
96-48	12						83	13	13
120-48	12			60			107	13	13
120-54	12			60			107	17	17
144-54	12			72			131	17	17
168-54	12		63		105		155	17	17
192-54	12		72		120		179	17	17
216-60	12		65	108	151		203	20	20
240-60	12		72	120	168		227	20	20
264-60	12	67	120		144	197	251	20	20
288-60	12	73	120		168	215	275	20	20

VIRTU | RECOMMENDED FLOOR MONUMENT LOCATIONS

Chart B

Top Shape: • Arched Rectangle

Bases: • Forza Leg with Forza Square • Forza Leg with Forza Rectangle

Indicates distance in inches from the left end of table to center of monument

Indicates distance in inches from center line (*lengthwise*) of table to center of monument

	CODES								
	1L	2L	3L	3	3R	2R	1R	ML	MR
72-36	18						53	8	8
84-42	18						66	11	11
96-42	18						77	11	11
96-48	18						77	13	13
120-48	18			60			101	13	13
120-54	18			60			101	17	17
144-54	18			72			125	17	17
168-54	18		63		105		149	17	17
192-54	18		72		120		173	17	17
216-60	18		65	108	151		197	20	20
240-60	18		73	120	167		221	20	20
264-60	18	67	110		154	197	245	20	20
288-60	18	73	120		168	215	269	20	20

Top Shape: • Boat

Bases: • Forza Leg with Forza Square • Forza Leg with Forza Rectangle

	CODES								
	1L	2L	3L	3	3R	2R	1R	ML	MR
96-48-42	12						83	11	11
120-48-42	12			60			107	11	11
144-48-42	12			72			131	11	11
168-48-42	12		63		105		155	11	11
192-54-48	12		72		120		179	14	14
216-54-48	12		65	108	151		203	14	14
240-54-48	12		73	120	167		227	14	14
264-60-48	12	67	110		154	197	251	14	14
288-60-48	12	73	120		168	215	275	14	14

VIRTU | RECOMMENDED FLOOR MONUMENT LOCATIONS

Chart B

Top Shape: • Arched Rectangle

Bases: • Forza Leg with Forza Square • Forza Leg with Forza Rectangle

Indicates distance in inches from the left end of table to center of monument

Indicates distance in inches from center line (*lengthwise*) of table to center of monument

	CODES								
	1L	2L	3L	3	3R	2R	1R	ML	MR
72-36	17						55	6	6
84-42	17						67	8	8
96-42	17						79	8	8
96-48	19						77	11	11
120-48	19			60			101	11	11
120-54	21			60			99	14	14
144-54	21			72			123	14	14
168-54	21		63		105		147	14	14
192-54	21		72		120		171	14	14
216-60	23		65	108	151		193	17	17
240-60	23		73	120	167		217	17	17
264-60	23	67	110		154	197	241	17	17
288-60	23	73	120		168	215	265	17	17

VIRTU | RECOMMENDED FLOOR MONUMENT LOCATIONS

Chart B

Top Shape:	• Rectangle	• Arched Rectangle	• Racetrack	• Boat
Bases:	• Forza Panel	• Forza Leg with Forza Square	• Forza Leg with Forza Rectangle	

Indicates distance in inches from the left end of table to center of monument

Indicates distance in inches from center line (*lengthwise*) of table to center of monument

	CODES									
	1L	2L	3L	3	3R	2R	1R	ML	MR	
72-36	19						53	7	7	
84-42	19						65	7	7	
96-42	20						76	10	10	
96-48	20						76	10	10	
96-48-42	20						76	10	10	
120-48	20			60			100	10	10	
120-48-42	20			60			100	10	10	
120-54	20			60			100	13	13	
144-54	20			72			123	13	13	
144-48-42	20			72			123	13	13	
168-54	20			84			148	13	13	
168-48-42	20			84			148	13	13	
192-54	20		72		120		172	13	13	
192-54-48	20		72		120		172	13	13	
216-54-48	20		87		129		196	13	13	
216-60	20		65		150		196	13	13	
240-54-48	20		78		162		220	13	13	
240-60	20		78		162		220	13	13	
264-60	20		88		175		244	13	13	
264-60-48	20		88		175		244	13	13	
288-60	20		73	144	215		268	13	13	
288-60-48	20		73	144	215		268	13	13	

VIRTU | RECOMMENDED FLOOR MONUMENT LOCATIONS

Chart B

Top Shape: • Oval

Bases: • Dais

Indicates distance in inches from the left end of table to center of monument

Indicates distance in inches from center line (*lengthwise*) of table to center of monument

	CODES								
	1L	2L	3L	3	3R	2R	1R	ML	MR
96-48	25						70		
120-54	28						92		
144-60	27			72			117		

Top Shape: • Oval

Bases: • Forza Leg
• Forza Leg with Forza Square • Forza Leg with Forza Rectangle

Indicates distance in inches from the left end of table to center of monument

Indicates distance in inches from center line (*lengthwise*) of table to center of monument

	CODES								
	1L	2L	3L	3	3R	2R	1R	ML	MR
96-48	24						71	7	7
120-54	27			60			93	10	10
144-60	26			72			118	10	10

Top Shape: • Oval

Bases: • Forza Panel
• Forza Panel with Forza Square • Forza Panel with Forza Rectangle

Indicates distance in inches from the left end of table to center of monument

Indicates distance in inches from center line (*lengthwise*) of table to center of monument

	CODES								
	1L	2L	3L	3	3R	2R	1R	ML	MR
96-48	24						71	7	7
120-54	27			60			93	10	10
144-60	26			72			118	10	10

VIRTU | RECOMMENDED FLOOR MONUMENT LOCATIONS

Chart B

Top Shape: • Verso

Bases: • Forza Square • Verso

Indicates distance in inches from the left end of table to center of monument

Indicates distance in inches from center line (*lengthwise*) of table to center of monument

	CODES								
	1L	2L	3L	3	3R	2R	1R	ML	MR
107-57-40	26						71		5
137-63-40	27						102		6
167-70-40	27			79			130		8

Top Shape: • Verso

Bases: • Forza Leg • Forza Square

Indicates distance in inches from the left end of table to center of monument

Indicates distance in inches from center line (*lengthwise*) of table to center of monument

	CODES								
	1L	2L	3L	3	3R	2R	1R	ML	MR
107-57-40	14				61		95	10 & 13	10 & 20
137-63-40	14			68	91		125	10 & 16	10 & 23
167-70-40	14		60		98	120	154	10 & 19	10 & 27

VIRTU | RECOMMENDED FLOOR MONUMENT LOCATIONS

Chart B

Top Shape: • Visio

Bases: • Dais • Forza Square • Oblique

Indicates distance in inches from the left end of table to center of monument

Indicates distance in inches from center line (*lengthwise*) of table to center of monument

	CODES								
	1L	2L	3L	3	3R	2R	1R	ML	MR
102-60-42	26						93		
144-60-42	26						114		
168-66-42	26			79			138		
192-66-42	24			96			164		
216-73-42	24			108			188		
240-76-42	24		76		144		212		

Top Shape: • Visio

Bases: • Forza Leg with Forza Square • Forza Leg with Forza Square

Indicates distance in inches from the left end of table to center of monument

Indicates distance in inches from center line (*lengthwise*) of table to center of monument

	CODES								
	1L	2L	3L	3	3R	2R	1R	ML	MR
102-60-42	12			60			107	10	10
144-60-42	12			72			131	10	10
168-66-42	12		63		104		155	10	10
192-66-42	12		72		120		179	10	10
216-73-42	12		65	108	151		203	10	10
240-76-42	12		72	120	168		227	10	10

Top Shape: • Visio

Bases: • Forza Panel with Forza Square • Forza Panel with Forza Square

Indicates distance in inches from the left end of table to center of monument

Indicates distance in inches from center line (*lengthwise*) of table to center of monument

	CODES								
	1L	2L	3L	3	3R	2R	1R	ML	MR
102-60-42	21			60			99	7	7
144-60-42	21			72			122	7	7
168-66-42	21			84			147	7	7
192-66-42	21		72		120		170	7	7
216-73-42	21		65		151		194	7	7
240-76-42	21		72		168		218	7	7

VIRTU | RECOMMENDED FLOOR MONUMENT LOCATIONS

Chart B

Top Shape: • Arched Rectangle

Bases: • Forza Leg with Forza Square • Forza Leg with Forza Rectangle

Indicates distance in inches from the left end of table to center of monument

Indicates distance in inches from center line (*lengthwise*) of table to center of monument

	CODES														
	1L	ML	MR	3L	ML	MR	3	ML	MR	3R	ML	MR	1R	ML	MR
134-80-52 (30-96)	13	17	17	37	15	15							124	24	24
134-92-64 (36-96)	13	23	23	38	18	18							124	27	27
158-85-52 (30-60)	13	17	17	37	15	15				97	21	21	148	27	27
158-96-64 (36-60)	13	23	23	38	18	18				97	24	24	148	30	30
179-90-52 (30-72)	13	17	17	37	15	15				109	22	22	172	29	29
179-102-64 (36-72)	13	23	23	38	18	18				109	25	25	172	32	32
218-97-52 (30-60)	13	17	17	37	15	15	97	21	21	157	27	27	208	33	33
218-109-64 (36-60)	13	23	23	38	18	18	97	24	24	157	30	30	208	36	36
254-105-52 (30-72)	13	17	17	37	15	15	109	22	22	180	30	30	243	37	37
254-117-64 (36-72)	13	23	23	38	18	18	109	25	25	180	33	33	243	40	40

Due to the unique shape of Open Visio tables, this Monument Location Chart differs from the other charts

VIRTU | CONFERENCE TABLE ORDERING CHART SAMPLE

Conference Table Ordering Chart Samples

To assist in the specification of VIRTU conference tables we have provided an ordering chart. Shown first is a completed sample chart. This sample chart shows exactly what information is needed to complete an order. The exception is the Connexus™ and Floor Monument areas, as they are not required if Connexus™ modules are not included in the order. You may photocopy the blank chart on bottom of the page and use it exclusively for ordering VIRTU conference tables, attach the charts to the rest of your order, or simply use the chart as a reference to what information is required to complete your conference table order.

SAMPLE

VIRTU Conferencing Table Configuration

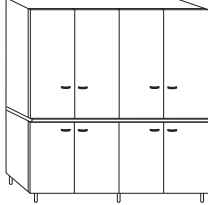
Conference Top Model # Base Model #'s	Base Qty	Price for Top and Base(s)		
6258-167-70-40		\$21007		
6234-14-14-29	1			
6234-20-20-29	1			
6231-23-24-29	1			
Species		Finish	Edge Profile	Metal Finish
Anigre		Clear	Fino	Satin Aluminum
Connexus™ Location	Connexus™ Model #(s)	Price	Monument Locations	Other
AL	62 CON ED - Alum.	1307	1L	
C	62 CON BD - Alum.	1064	1L	
AR	62 CON BD - Alum	1064	1R	
			Total List \$	\$24,442

VIRTU Conferencing Table Configuration

Conference Top Model # Base Model #'s	Base Qty	Price for Top and Base(s)		
Species		Finish	Edge Profile	Metal Finish
Connexus™ Location	Connexus™ Model #(s)	Price	Monument Locations	Other
			Total List \$	

VIRTU | DUAL MEDIA CABINETS

Description	Model	Cherry/Maple/ Walnut			W	D	H	Shipping Weight	Cubic Feet
			Anigre						
Dual Media Cabinet full height upper bi-fold wood doors lower hinged wood doors	62MC-75307614	13146	14185	75	30	76	645	116	



ORDERING NOTES

Locks are optional on upper and lower wood doors at a price of **\$152 list** per set of two doors.
Interior dimensions for monitor shelf on this unit are: Width=73 1/4" Depth=27 3/4"
Height with camera shelf=30 3/4" Height without camera shelf=39"

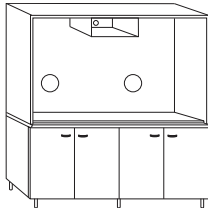
Dual Media Cabinet full height upper bi-fold wood doors lower hinged glass doors	62MC-75307614GW	13816	14884	75	30	76	645	116
---	-----------------	-------	-------	----	----	----	-----	-----



ORDERING NOTES

Locks are optional on upper doors at a price of **\$152 list** per set of two doors.
Interior dimensions for monitor shelf on this unit are: Width=73 1/4" Depth=27 3/4"
Height with camera shelf=30 3/4" Height without camera shelf=39"

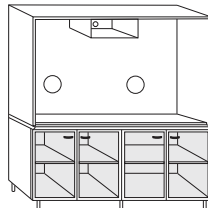
Dual Media Cabinet full height open top cabinet lower hinged wood doors	62MC-75307613 Media Cabinet full height	11383	12439	75	30	76	570	116
--	---	-------	-------	----	----	----	-----	-----



ORDERING NOTES

Locks are optional on lower wood doors at a price of **\$152 list** per set of two doors.
Interior dimensions for monitor shelf on this unit are: Width=73 1/4" Depth=27 3/4"
Height with camera shelf=30 3/4" Height without camera shelf=39"

Dual Media Cabinet full height open top cabinet lower hinged glass doors	62MC-75307613G	12071	13211	75	30	76	570	116
---	----------------	-------	-------	----	----	----	-----	-----



ORDERING NOTES

Interior dimensions for monitor shelf on this unit are: Width=73 1/4" Depth=27 3/4"
Height with camera shelf=30 3/4" Height without camera shelf=39"

ORDERING PROCEDURE

To order, please specify the following:

1. Product model number
2. Wood species and finish
3. Metal finish
4. Special options/features

CODE DESCRIPTION

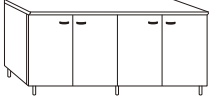
MC - media cabinet
G - glass doors
W - wood doors

SPECIAL FEATURES

- Dual Media Cabinets will accommodate 2 monitors up to 35" each in width. Please contact Customer Service if dimensions are critical.
- Locks are optional on wood doors at a price of **\$152 list** per lock.
- Casters are optional on Dual Media Cabinets at a price of **\$208 list**.
- Dual Media Cabinets feature removable shelf and grommet for CPU storage.

VIRTU | MEDIA CABINETS

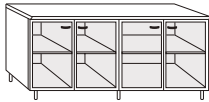
Description	Model	Cherry/Maple/ Walnut	Anigre	W	D	H	Shipping Weight	Cubic Feet
Dual Media Cabinet buffet height hinged wood doors	62MC-75303511	7243	8290	75	30	34.5	345	49



ORDERING NOTES

Locks are optional on wood doors at a price of **\$152 list** per set of two doors.
Casters are optional on Dual Media Cabinets at a price of **\$208 list**.

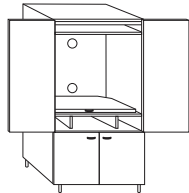
Dual Media Cabinet buffet height hinged glass doors	62MC-75303511G	7920	9060	75	30	34.5	345	49
---	----------------	------	------	----	----	------	-----	----



ORDERING NOTES

Casters are optional on Dual Media Cabinets at a price of **\$208 list**.ordering procedure

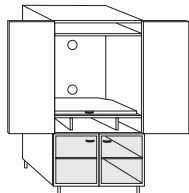
Large Media Cabinet hinged wood doors lower hinged wood doors (2 Piece Assembly)	62MC-42308514	7568	8702	42	30	85	455	59
---	---------------	------	------	----	----	----	-----	----



ORDERING NOTES

Upper and lower doors have an optional lock at a price of **\$152 list** per set of two doors.
Interior dimensions for monitor shelf on this unit are:
Width=40 3/16" Depth=28 3/8" Height=33 3/8"
An optional pull-out equipment rack and cable carrier are available on Media Cabinets at a price of **\$3188 list**.

Large Media Cabinet hinged glass doors lower hinged glass doors (2 Piece Assembly)	62MC-42308514GW	7829	9002	42	30	85	455	59
---	-----------------	------	------	----	----	----	-----	----



ORDERING NOTES

Upper and lower doors have an optional lock at a price of **\$152 list** per set of two doors.
Interior dimensions for monitor shelf on this unit are:
Width=40 3/16" Depth=28 3/8" Height=33 3/8"
An optional pull-out equipment rack and cable carrier are available on Media Cabinets at a price of **\$3188 list**.

ORDERING PROCEDURE

To order, please specify the following:

1. Product model number
2. Wood species and finish
3. Metal finish
4. Special options/features

CODE DESCRIPTION

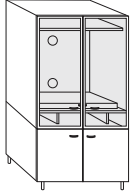
MC - media cabinet
G - glass doors

SPECIAL FEATURES

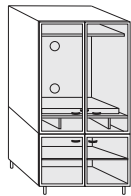
- Dual Media Cabinets will accommodate 2 monitors up to 35" each in width. Please contact Customer Service if dimensions are critical
- Locks are optional on wood doors at a price of **\$152 list** per lock mechanism.
- Bookmatched Birdseye Maple veneer is available on work surfaces of VIRTU cases at an upcharge of **\$76 list** per square foot.

VIRTU | LARGE MEDIA CABINETS

Description	Model	Cherry/Maple/ Walnut			W	D	H	Shipping Weight	Cubic Feet
			Anigre						
Large Media Cabinet hinged glass doors lower hinged wood doors (2 Piece Assembly)	62MC-42308514WG	8659	9843		42	30	85	455	59



Large Media Cabinet hinged glass doors lower hinged glass doors (2 Piece Assembly)	62MC-42308514G	9087	10264		42	30	85	455	59
---	----------------	------	-------	--	----	----	----	-----	----



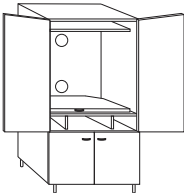
ORDERING NOTES

Interior dimensions for monitor shelf on this unit are:

Width=40 3/16" Depth=28 3/8" Height=33 3/8"

An optional pull-out equipment rack and cable carrier are available on Media Cabinets at a price of **\$3188 list**.

Large Media Cabinet gabled top hinged wood doors lower hinged wood doors (2 Piece Assembly)	.62MC-42308514A	7695	8845		42	30	85	455	61
---	-----------------	------	------	--	----	----	----	-----	----



ORDERING NOTES

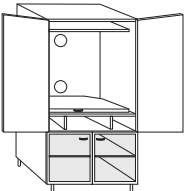
For security reasons, upper doors have an optional lock at a price of **\$152 list**.

Interior dimensions for monitor shelf on this unit are:

Width=40 3/16" Depth=28 3/8" Height=33 3/8"

An optional pull-out equipment rack and cable carrier are available on Media Cabinets at a price of **\$3188 list**.

Large Media Cabinet gabled top hinged wood doors lower hinged wood doors (2 Piece Assembly)	62MC-42308514GWA	7953	9146		42	30	85	455	61
---	------------------	------	------	--	----	----	----	-----	----



ORDERING NOTES

For security reasons, upper doors have an optional lock at a price of **\$152 list**.

Interior dimensions for monitor shelf on this unit are:

Width=40 3/16" Depth=28 3/8" Height=33 3/8"

An optional pull-out equipment rack and cable carrier are available on Media Cabinets at a price of **\$3188 list**.

ORDERING PROCEDURE

To order, please specify the following:

1. Product model number
2. Wood species and finish
3. Metal finish
4. Special options/features

CODE DESCRIPTION

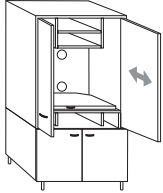
MC - media cabinet
G - glass doors

SPECIAL FEATURES

- Large Media Cabinets will accommodate monitors up to 35" in width. Please contact Customer Service if dimensions are critical.
- Locks are optional on wood doors at a price of **\$152 list** per lock mechanism.
- Media Cabinets with hinged or pocket doors come equipped with a pullout swivel shelf (which accommodates up to 250 lbs.).

VIRTU | LARGE MEDIA CABINETS

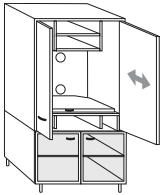
Description	Model	Cherry/Maple/ Walnut			W	D	H	Shipping Weight	Cubic Feet
		Walnut	Anigre						
Large Media Cabinet wood pocket doors wood lower hinged doors (2 Piece Assembly)	62MC-42308502	8978	10325	42	30	85	455	59	



ORDERING NOTES

For security reasons, upper pocket doors have an optional lock at a price of **\$152 list**.
Lower doors feature an optional lock at a price of **\$152 list**.
Interior dimensions for monitor shelf on this unit are:
Width=36 15/16" Depth=28 7/16" Height=30 3/8"

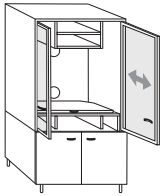
Large Media Cabinet wood pocket doors glass lower hinged doors (2 Piece Assembly)	62MC-42308502GW	9232	10616	42	30	85	455	59
--	-----------------	------	-------	----	----	----	-----	----



ORDERING NOTES

For security reasons, upper pocket doors have an optional lock at a price of **\$152 list**.
Interior dimensions for monitor shelf on this unit are:
Width=36 15/16" Depth=28 7/16" Height=30 3/8"

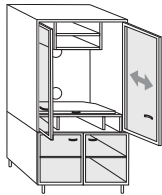
Large Media Cabinet glass pocket doors wood lower hinged doors (2 Piece Assembly)	62MC-42308502WG	9966	11562	42	30	85	455	59
--	-----------------	------	-------	----	----	----	-----	----



ORDERING NOTES

For security reasons, lower doors have an optional lock at a price of **\$152 list**.
Interior dimensions for monitor shelf on this unit are:
Width=36 15/16" Depth=28 7/16" Height=30 3/8"
Locks are optional on wood doors at a price of **\$152 list** per lock mechanism.

Large Media Cabinet glass pocket doors glass lower hinged doors (2 Piece Assembly)	62MC-42308502G	10224	11754	42	30	85	455	59
---	----------------	-------	-------	----	----	----	-----	----



ORDERING NOTES

Interior dimensions for monitor shelf on this unit are:
Width=36 15/16" Depth=28 7/16" Height=30 3/8"
Locks are optional on wood doors at a price of **\$152 list** per lock mechanism.

ORDERING PROCEDURE

To order, please specify the following:

1. Product model number
2. Wood species and finish
3. Metal finish
4. Special options/features

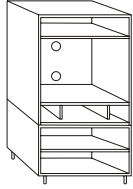
CODE DESCRIPTION

MC - media cabinet
G - glass doors
W - wood doors
A - gabled doors

SPECIAL FEATURES

- Large Media Cabinets will accommodate monitors up to 35" in width. Please contact Customer Service if dimensions are critical.
- Locks are optional on wood doors at a price of **\$152 list** per lock mechanism.
- Media Cabinets with hinged or pocket doors come equipped with a pullout swivel shelf (which accommodates up to 250 lbs.).

Description	Model	Cherry/Maple/ Walnut	Anigre	W	D	H	Shipping Weight	Cubic Feet
Large Media Cabinet open monitor shelf (2 Piece Assembly)	62MC-42308517	7105	8173	42	30	85	440	59



ORDERING NOTES

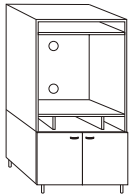
Interior dimensions for monitor shelf on this unit are:

Width=40 3/16" Depth=28 5/16" Height=35 7/16"

Locks are optional on wood doors at a price of **\$152 list** per lock mechanism.

An optional pull-out equipment rack and cable carrier are available on Media Cabinets at a price of \$3188 list.

Large Media Cabinet open monitor shelf lower hinged wood doors (2 Piece Assembly)	62MC-42308507	7269	8361	42	30	85	445	59
--	---------------	------	------	----	----	----	-----	----



ORDERING NOTES

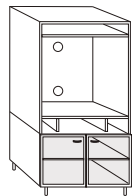
For security reasons, lower hinged doors have an optional lock at a price of **\$152 list**.

Interior dimensions for monitor shelf on this unit are:

Width=40 3/16" Depth=28 5/16" Height=35 7/16"

An optional pull-out equipment rack and cable carrier are available on Media Cabinets at a price of \$3188 list.

Large Media Cabinet open monitor shelf lower hinged glass doors (2 Piece Assembly)	62MC-42308507G	7486	8607	42	30	85	445	59
---	----------------	------	------	----	----	----	-----	----



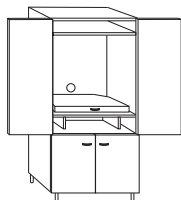
ORDERING NOTES

Interior dimensions for monitor shelf on this unit are:

Width=40 3/16" Depth=28 5/16" Height=35 7/16"

An optional pull-out equipment rack and cable carrier are available on Media Cabinets at a price of \$3188 list.

Small Media Cabinet hinged wood doors lower hinged doors - wood (casters optional)	62MC-36247614	6102	7018	36	24	75	235	40
---	---------------	------	------	----	----	----	-----	----



ORDERING NOTES

For security reasons, upper and lower doors have an optional lock at a price of **\$152 list** per set of two doors.

Interior dimensions for monitor shelf on this unit are:

Width=34 5/16" Depth=22 15/16" Height=28 9/16"

Castors are optional on Small Media Cabinets at a price of **\$208 list**.

ORDERING PROCEDURE

To order, please specify the following:

1. Product model number
2. Wood species and finish
3. Metal finish
4. Special options/features

CODE DESCRIPTION

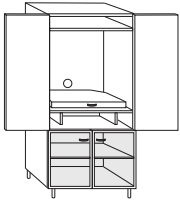
MC - media cabinet
G - glass doors
W - wood doors

SPECIAL FEATURES

- Large Media Cabinets will accommodate monitors up to 35" in width. Please contact Customer Service if dimensions are critical.
- Locks are optional on wood doors at a price of **\$152 list** per lock mechanism.
- Media Cabinets with hinged or pocket doors come equipped with a pullout swivel shelf (which accommodates up to 250 lbs.).

VIRTU | MEDIA CABINETS

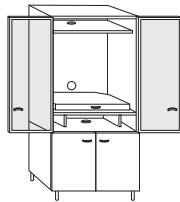
Description	Model	Cherry/Maple/ Walnut	Anigre	W	D	H	Shipping Weight	Cubic Feet
Small Media Cabinet hinged wood doors glass lower hinged doors	62MC-36247614GW	6715	7722	36	24	75	235	40



ORDERING NOTES

For security reasons, upper doors have an optional lock at a price of **\$152 list**.
Interior dimensions for monitor shelf on this unit are:
Width=34 5/16" Depth=22 15/16" Height=28 9/16"
Casters are optional on Small Media Cabinets at a price of **\$208 list**.

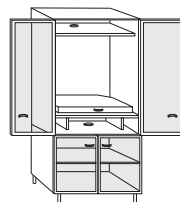
Small Media Cabinet hinged glass doors wood lower hinged doors (casters optional)	62MC-36247614WG	6953	7847	36	24	75	235	40
--	-----------------	------	------	----	----	----	-----	----



ORDERING NOTES

For security reasons, lower doors have an optional lock at a price of **\$152 list**.
Interior dimensions for monitor shelf on this unit are:
Width=34 5/16" Depth=22 15/16" Height=28 9/16"
Casters are optional on Small Media Cabinets at a price of **\$208 list**.

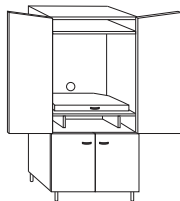
Small Media Cabinet hinged glass doors glass lower hinged doors (casters optional)	62MC-36247614G	7323	8220	36	24	75	235	40
---	----------------	------	------	----	----	----	-----	----



ORDERING NOTES

Interior dimensions for monitor shelf on this unit are:
Width=34 5/16" Depth=22 15/16" Height=28 9/16"

Small Media Cabinet gabled doors hinged wood doors wood lower hinged doors (casters optional)	62MC-36247614A	6419	7379	36	24	75	235	40
---	----------------	------	------	----	----	----	-----	----



ORDERING NOTES

For security reasons, upper and lower doors have an optional lock at a price of **\$152 list** per set of two doors.
Interior dimensions for monitor shelf on this unit are:
Width=34 5/16" Depth=22 15/16" Height=28 9/16"

ORDERING PROCEDURE

To order, please specify the following:

1. Product model number
2. Wood species and finish
3. Metal finish
4. Special options/features

CODE DESCRIPTION

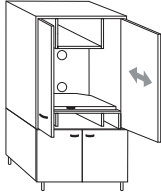
MC - media cabinet
G - glass doors
W - wood doors
A - gabled doors

SPECIAL FEATURES

- Large Media Cabinets will accommodate monitors up to 35" in width. Please contact Customer Service if dimensions are critical.
- Locks are optional on wood doors at a price of **\$152 list** per lock mechanism.
- Media Cabinets with hinged or pocket doors come equipped with a pullout swivel shelf (which accommodates up to 250 lbs.).

VIRTU | SMALL MEDIA CABINETS

Description	Model	Cherry/Maple/ Walnut		Anigre	W	D	H	Shipping Weight	Cubic Feet
Small Media Cabinet gabled doors hinged wood doors glass lower hinged doors (casters optional)	62MC-36247614GA	6911	7949		36	24	75	235	40



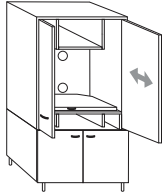
ORDERING NOTES

For security reasons, upper hinged doors have an optional lock at a price of **\$152 list**.

Interior dimensions for monitor shelf on this unit are:

Width=34 5/16" Depth=22 15/16" Height=28 9/16"

Small Media Cabinet wood pocket doors wood lower hinged doors (casters optional)	62MC-36247602	7360	8461		36	24	75	235	40
---	---------------	------	------	--	----	----	----	-----	----



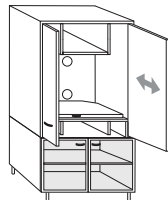
ORDERING NOTES

For security reasons, upper and lower doors have an optional lock at a price of **\$152 list** per set of two doors.

Interior dimensions for monitor shelf on this unit are:

Width=30 15/16" Depth=22 15/16" Height=26"

Small Media Cabinet hinged glass doors glass lower hinged doors (casters optional)	62MC-36247602GW	7906	9090		36	24	75	235	40
---	-----------------	------	------	--	----	----	----	-----	----



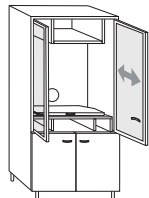
ORDERING NOTES

For security reasons, upper pocket doors have an optional lock at a price of **\$152 list**.

Interior dimensions for monitor shelf on this unit are:

Width=30 15/16" Depth=22 15/16" Height=26"

Small Media Cabinet glass pocket doors wood lower hinged doors (casters optional)	62MC-36247602WG	8331	9598		36	24	75	235	40
--	-----------------	------	------	--	----	----	----	-----	----



ORDERING NOTES

For security reasons, lower doors have an optional lock at a price of **\$152 list**.

Interior dimensions for monitor shelf on this unit are:

Width=30 15/16" Depth=22 15/16" Height=26"

ORDERING PROCEDURE

To order, please specify the following:

1. Product model number
2. Wood species and finish
3. Metal finish
4. Special options/features

CODE DESCRIPTION

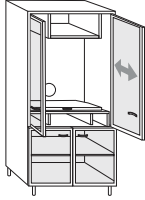
MC - media cabinet
G - glass doors

SPECIAL FEATURES

- Casters are optional on Small Media Cabinets at a price of **\$208 list**.
- Small Media Cabinets are suitable for use with 27" wide monitors. Please contact Customer Service if dimensions are critical.
- Locks are optional on wood doors at a price of **\$152 list** per lock mechanism.
- Media Cabinets with hinged or pocket doors come equipped with a pull-out swivel shelf (which can accommodate up to 250 lbs.).

VIRTU | SMALL MEDIA CABINETS

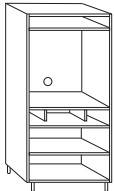
Description	Model	Cherry/Maple/ Walnut			W	D	H	Shipping Weight	Cubic Feet
		Walnut	Anigre						
Small Media Cabinet glass pocket doors glass lower hinged doors (casters optional)	62MC-36247602G	8889	10172		36	24	75	235	40



ORDERING NOTES

Interior dimensions for monitor shelf on this unit are:
Width=30 15/16" Depth=22 15/16" Height=26"

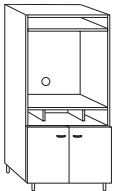
Small Media Cabinet Small open shelf (casters optional)	62MC-36247617	5727	6587		36	24	75	225	40
--	---------------	------	------	--	----	----	----	-----	----



ORDERING NOTES

Interior dimensions for monitor shelf on this unit are:
Width=34 5/16" Depth=22 7/8" Height=30 5/8"

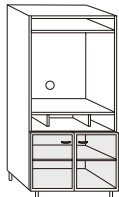
Small Media Cabinet open monitor shelf wood lower hinged doors (casters optional)	62MC-36247607	5939	6843		36	24	75	230	40
--	---------------	------	------	--	----	----	----	-----	----



ORDERING NOTES

For security reasons, lower doors have an optional lock at a price of **\$152 list**.
Interior dimensions for monitor shelf on this unit are:
Width=34 5/16" Depth=22 7/8" Height=30 5/8"

Small Media Cabinet open monitor shelf glass lower hinged doors (casters optional)	62MC-36247607G	6430	7392		36	24	75	230	40
---	----------------	------	------	--	----	----	----	-----	----



ORDERING NOTES

Interior dimensions for monitor shelf on this unit are:
Width=34 5/16" Depth=22 7/8" Height=30 5/8"

ORDERING PROCEDURE

To order, please specify the following:

1. Product model number
2. Wood species and finish
3. Metal finish
4. Special options/features

CODE DESCRIPTION

MC - media cabinet
G - glass doors
W - wood doors

SPECIAL FEATURES

- Casters are optional on Small Media Cabinets at a price of **\$208 list**.
- Small Media Cabinets are suitable for use with 27" wide monitors. Please contact Customer Service if dimensions are critical.
- Locks are optional on wood doors at a price of **\$152 list** per lock mechanism.
- Media Cabinets with hinged or pocket doors come equipped with a pull-out swivel shelf (which can accommodate up to 250 lbs.).

VIRTU | SMALL MEDIA CABINETS & DISPLAY CABINETS

Description	Model	Cherry/Maple/ Walnut	Anigre	W	D	H	Shipping Weight	Cubic Feet
Monitor cabinet lower hinged wood doors	62MC-36243011	3587	4670	36	24	29.5	170	19



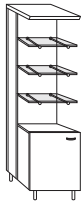
ORDERING NOTES

For security reasons, a lock is optional for this unit at a price of **\$152 list**.

Monitor cabinet lower hinged glass doors	62MC-36243011G	3843	4421	36	24	29.5	170	19
---	----------------	------	------	----	----	------	-----	----



Display Cabinet with ward- robe fixed glass shelves lower wood door	62DC-21247671L	4446	5115	21	24	76	190	24
	62DC-21247671R	4446	5115	21	24	76	190	24



ORDERING NOTES

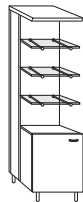
Locks are optional on both lower door and wardrobe door at a price of **\$152 list** each.

Glass shelves are not fixed to shelf supports.

We recommend that halogen lights be specified on Display Cabinets with glass shelves only.

Available at a price of **\$555 list** each.

Display Cabinet with ward- robe fixed glass shelves lower glass door	62DC-21247671GL	4736	5448	21	24	76	190	24
	62DC-21247671GR	4736	5448	21	24	76	190	24



ORDERING NOTES

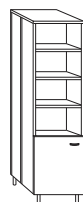
Wardrobe door features an optional lock at a price of **\$152 list** each.

Glass shelves are not fixed to shelf supports.

We recommend that halogen lights be specified on Display Cabinets with glass shelves only.

Available at a price of **\$555 list** each.

Display Cabinet with ward- robe fixed wood shelves lower wood door	62DC-21247672L	4392	5053	21	24	76	190	24
	62DC-21247672R	4392	5053	21	24	76	190	24



ORDERING NOTES

Locks are optional on both lower door and wardrobe door at a price of **\$152 list** each.

This item is available on the KrugExpress quickship program.

ORDERING PROCEDURE

To order, please specify the following:

1. Product model number
2. Wood species and finish
3. Metal finish
4. Special options/features

CODE DESCRIPTION

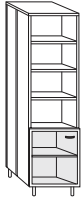
MC - media cabinet
G - glass doors
W - wood doors
A - gabled doors

SPECIAL FEATURES

- Casters are optional on Small Media Cabinets at a price of **\$208 list**.
- Small Media Cabinets are suitable for use with 27" wide monitors. Please contact Customer Service if dimensions are critical.
- Locks are optional on wood doors at a price of **\$152 list** per lock mechanism.
- Media Cabinets with hinged or pocket doors come equipped with a pull-out swivel shelf (which can accommodate up to 250 lbs.).

VIRTU | SMALL DISPLAY CABINETS

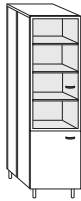
Description	Model	Cherry/Maple/ Walnut			W	D	H	Shipping Weight	Cubic Feet
		Walnut	Anigre						
Display Cabinet with wardrobe	62DC-21247672GL	4683	5385	21	24	76	190	24	
fixed wood shelves lower glass door	62DC-21247672GR	4683	5385	21	24	76	190	24	



ORDERING NOTES

Wardrobe door features an optional lock at a price of **\$152 list** each.

Display Cabinet with wardrobe	62DC-21247674WGL	5231	6014	21	24	76	195	24
upper glass door lower wood door	62DC-21247674WGR	5231	6014	21	24	76	195	24



ORDERING NOTES

Lower and wardrobe doors feature an optional lock at a price of **152 list** each.

Display Cabinet with wardrobe	62DC-21247674GL	5479	6304	21	24	76	195	24
upper glass door lower glass door	62DC-21247674GR	5479	6304	21	24	76	195	24



ORDERING NOTES

Lower and wardrobe doors feature an optional lock at a price of **\$152 list** each.

Display Cabinet with wardrobe	62ST-21207613L	4521	5199	21	20	76	145	20
adjust. wood shelves lower wood door	62ST-21207613R	4521	5199	21	20	76	145	20



ORDERING NOTES

Wardrobe door features an optional lock at a price of **\$152 list** each.

ORDERING PROCEDURE

To order, please specify the following:

1. Product model number
2. Wood species and finish
3. Metal finish
4. Special options/features

CODE DESCRIPTION

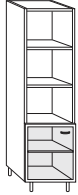
MC - media cabinet
G - glass doors
W - wood doors

SPECIAL FEATURES

- Casters are optional on Small Media Cabinets at a price of **\$208 list**.
- Small Media Cabinets are suitable for use with 27" wide monitors. Please contact Customer Service if dimensions are critical.
- Locks are optional on wood doors at a price of **\$152 list** per lock mechanism.
- Media Cabinets with hinged or pocket doors come equipped with a pull-out swivel shelf (which can accommodate up to 250 lbs.).

VIRTU | SMALL DISPLAY CABINETS

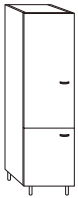
Description	Model	Cherry/Maple/ Walnut	Anigre	W	D	H	Shipping Weight	Cubic Feet
Display Cabinet with wardrobe	62ST-21207613GL	4814	5536	21	20	76	145	20
adjust. wood shelves lower glass door	62ST-21207613GR	4814	5536	21	20	76	145	20



ORDERING NOTES

Lower door features an optional lock at a price of **\$152 list**.
This item is available on the KrugExpress quickship program.

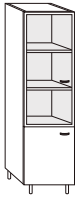
Display/Storage Cabinet upper wood door	62ST-21207614L	5002	5755	21	20	76	150	20
lower wood door	62ST-21207614R	5002	5755	21	20	76	150	20



ORDERING NOTES

Upper and lower doors feature an optional lock at a price of **\$152 list** each.
This item is available on the KrugExpress quickship program.

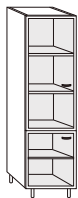
Display/Storage Cabinet upper glass door	62ST-21207614WGL	5362	6163	21	20	76	150	20
lower wood door	62ST-21207614WGR	5362	6163	21	20	76	150	20



ORDERING NOTES

Lower door features an optional lock at a price of **\$152 list**.

Display/Storage Cabinet upper glass door	62ST-21207614GL	5613	6461	21	20	76	150	20
lower glass door	62ST-21207614GR	5613	6461	21	20	76	150	20



ORDERING PROCEDURE

To order, please specify the following:

1. Product model number
2. Wood species and finish
3. Metal finish
4. Special options/features

CODE DESCRIPTION

DC - display cabinet
G - glass doors
L - door hinged left
R - door hinged right

SPECIAL FEATURES

- We recommend that halogen lights be specified on Display Cabinets with glass shelves only. Available at a price of **\$555 list** each.
- Interior wood shelves are removable.
- Locks are optional on wood doors at a price of **\$152 list** per lock mechanism.
- 21" Display Cabinets feature wardrobes with coat hooks behind the front display.

VIRTU | DISPLAY CABINETS

Description	Model	Cherry/Maple/ Walnut		W	D	H	Shipping Weight	Cubic Feet
		Anigre						
Display Cabinet with wardrobe fixed glass shelves lower wood doors	62DC-42247671L	6182	7107	42	24	76	270	42
	62DC-42247671R	6182	7107	42	24	76	270	42



ORDERING NOTES

Lower doors and wardrobe doors feature an optional lock at a price of **\$152 list** each.
Glass shelves are not fixed to shelf supports.
We recommend that halogen lights be specified on Display Cabinets with glass shelves only.
Available at a price of **\$555 list** each.

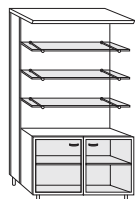
Display Cabinet with ward- robe fixed wood shelves lower wood doors	62DC-42247672L	5927	6819	42	24	76	270	42
	62DC-42247672R	5927	6819	42	24	76	270	42



ORDERING NOTES

Lower doors and wardrobe doors feature an optional lock at a price of **\$152 list** each.
This item is available on the KrugExpress quickship program.

Display Cabinet with wardrobe fixed glass shelves lower glass doors	62DC-42247671GL	6448	7421	42	24	76	270	42
	62DC-42247671GR	6448	7421	42	24	76	270	42



ORDERING NOTES

Wardrobe doors feature an optional lock at a price of **\$152 list**.
Glass shelves are not fixed to shelf supports.
We recommend that halogen lights be specified on Display Cabinets with glass shelves only.
Available at a price of **\$555 list** each.

Display Cabinet with wardrobe fixed wood shelves lower glass doors	62DC-42247672GL	6123	7043	42	24	76	270	42
	62DC-42247672GR	6123	7043	42	24	76	270	42



ORDERING NOTES

Wardrobe doors feature an optional lock at a price of **\$152 list**.

ORDERING PROCEDURE

To order, please specify the following:

1. Product model number
2. Wood species and finish
3. Metal finish
4. Special options/features

CODE DESCRIPTION

DC - display cabinet
W - wood doors
G - glass doors
L - door hinged left
R - door hinged right
ST - storage cabinet

SPECIAL FEATURES

- We recommend that halogen lights be specified on Display Cabinets with glass shelves only. Available at a price of **\$555 list** each.
- Interior wood shelves are removable.
- Locks are optional on wood doors at a price of **\$152 list** per lock mechanism.
- 21" Display Cabinets feature wardrobes with coat hooks behind the front display.

VIRTU | STORAGE CABINETS

Description	Model	Cherry/Maple/ Walnut	Anigre	W	D	H	Shipping Weight	Cubic Feet
Storage Cabinet adjust. wood shelves lower wood doors	62ST-42207613	5954	6843	42	24	76	220	39



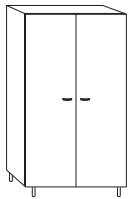
ORDERING NOTES

Lower doors feature an optional lock at a price of **\$152 list**.
This item is available on the KrugExpress quickship program.

Storage Cabinet adjust. wood shelves lower glass doors	62ST-42207613G	6469	7222	42	24	76	220	39
--	----------------	------	------	----	----	----	-----	----



Storage Cabinet with shelves wood doors (42")	62ST-42207611	5911	6795	42	20	76	225	39
	62ST-42247611	6107	7017	42	24	76	265	47



ORDERING NOTES

Wood doors feature an optional lock at a price of **\$152 list**.
This item is available on the KrugExpress quickship program.

Storage Cabinet upper glass shelves lower wood doors	62ST-42207614WG	6550	7534	42	20	76	225	39
	62ST-42247614WG	6942	7986	42	24	76	265	47



ORDERING NOTES

Lower doors feature an optional lock at a price of **\$152 list**.

ORDERING PROCEDURE

To order, please specify the following:

1. Product model number
2. Wood species and finish
3. Metal finish
4. Special options/features

CODE DESCRIPTION

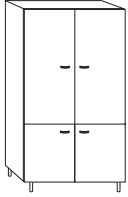
ST - storage cabinet
G - glass doors
L - door hinged left
R - door hinged right
W - wood doors

SPECIAL FEATURES

- Locks are available on wood doors at a price of **\$152 list** per lock mechanism.
- Interior shelves are height adjustable in increments of 1 1/4".
- Interior wood shelves are removable.

VIRTU | STORAGE CABINETS

Description	Model	Cherry/Maple/ Walnut	Anigre	W	D	H	Shipping Weight	Cubic Feet
Storage Cabinet upper wood shelves lower wood doors	62ST-42207614	6240	7534	42	20	76	225	39
	62ST-42247614	6612	7986	42	24	76	265	47



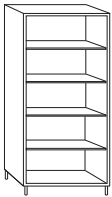
ORDERING NOTES

Upper and lower doors feature an optional combined lock at a price of **\$152 list**.
This item is available on the KrugExpress quickship program.

Storage Cabinet upper glass doors lower glass doors	62ST-42207614G	7365	8470	42	20	76	225	39
	62ST-42247614G	7807	8979	42	24	76	265	47



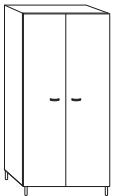
Storage Cabinet open bookcase	62ST-36207617	4362	5017	36	20	76	190	34
----------------------------------	---------------	------	------	----	----	----	-----	----



ORDERING NOTES

This item is available on the KrugExpress quickship program.

Storage Cabinet closed bookcase wood doors (36")	62ST-36207611	4752	5463	36	20	76	220	34
--	---------------	------	------	----	----	----	-----	----



ORDERING NOTES

Wood doors feature an optional lock at a price of **\$152 list**.
This item is available on the KrugExpress quickship program.

ORDERING PROCEDURE

To order, please specify the following:

1. Product model number
2. Wood species and finish
3. Metal finish
4. Special options/features

CODE DESCRIPTION

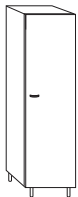
ST - storage cabinet
G - glass doors

SPECIAL FEATURES

- Locks are available on wood doors at a price of **\$152 list** per lock mechanism.
- Interior shelves are height adjustable in increments of 1 1/4".
- Interior wood shelves are removable.

VIRTU | STORAGE CABINETS & WARDROBES

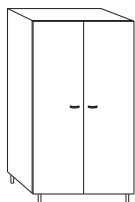
Description	Model	Cherry/Maple/ Walnut	Anigre	W	D	H	Shipping Weight	Cubic Feet
Storage Cabinet with shelves wood door	62ST-21207611L	3797	4369	21	20	76	150	20
	62ST-21207611R	3797	4369	21	20	76	150	20
	62ST-21247611L	3996	4596	21	24	76	174	24
	62ST-21247611R	3996	4596	21	24	76	174	24



ORDERING NOTES

Wood door features an optional lock at a price of **\$152 list**.
This item is available on the KrugExpress quickship program.

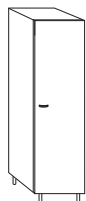
Wardrobe wood doors	62WR-42247601	5868	6749	42	24	76	265	47
------------------------	---------------	------	------	----	----	----	-----	----



ORDERING NOTES

Wood doors feature an optional lock at a price of **\$152 list**.
Interior is identical to wardrobe with glass doors.
This item is available on the KrugExpress quickship program.

Wardrobe wood door	62WR-21247602L	3724	4287	21	24	76	170	24
	62WR-21247602R	3724	4287	21	24	76	170	24



ORDERING NOTES

Wood door features an optional lock at a price of **\$152 list**.
This item is available on the KrugExpress quickship program.

ORDERING PROCEDURE

To order, please specify the following:

1. Product model number
2. Wood species and finish
3. Metal finish
4. Special options/features

CODE DESCRIPTION

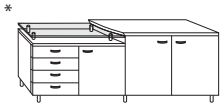
ST - storage cabinet

SPECIAL FEATURES

- Locks are available on wood doors at a price of **\$152 list** per lock mechanism.
- Interior shelves are height adjustable in increments of 1 1/4".
- Interior wood shelves are removable.

VIRTU | CREDENZAS

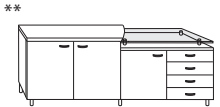
Description	Model	Cherry/Maple/ Walnut		Anigre	W	D	H	Shipping Weight	Cubic Feet
Credenza	62C-75202901*	9027	10381	75	20	29.5	217	27	
Standard Height	62C-75242901*	9228	10613	75	24	29.5	255	32	
wood drawers, wood doors	62C-75202902**	9027	10381	75	20	29.5	217	27	
partial glass top	62C-75242902**	9228	10613	75	24	29.5	255	32	



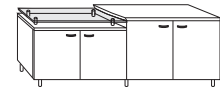
ORDERING NOTES

Wood doors feature an optional lock at a price of **\$152 list**.

Bookmatched Birdseye Maple veneer is available on worksurfaces of VIRTU cases at an upcharge of **\$76 list per square foot**.



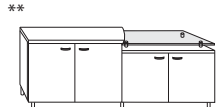
Credenza	62C-75202903*	8331	9581	75	20	29.5	217	27
Standard Height	62C-75242903*	8535	9816	75	24	29.5	255	32
wood doors	62C-75202904**	8331	9581	75	20	29.5	217	27
partial glass top	62C-75242904**	8535	9816	75	24	29.5	255	32



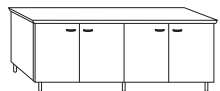
ORDERING NOTES

Wood doors feature an optional lock at a price of **\$152 list**.

Bookmatched Birdseye Maple veneer is available on worksurfaces of VIRTU cases at an upcharge of **\$76 list per square foot**.



Credenza	62C-75202905	6760	7773	75	20	29.5	217	27
Standard Height	62C-75242905	6974	8017	75	24	29.5	255	32
wood doors								
full wood top								



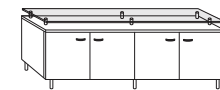
ORDERING NOTES

Wood doors feature an optional lock at a price of **\$152 list**.

Bookmatched Birdseye Maple veneer is available on worksurfaces of VIRTU cases at an upcharge of **\$76 list per square foot**.

This item is available on the KrugExpress quickship program.

Credenza	62C-75202906	7969	9161	75	20	29.5	217	27
Standard Height	62C-75242906	8149	9371	75	24	29.5	255	32
wood doors								
full glass top								



ORDERING NOTES

Wood doors feature an optional lock at a price of **\$152 list**.

ORDERING PROCEDURE

To order, please specify the following:

1. Product model number
2. Wood species and finish
3. Metal finish
4. Special options/features

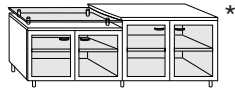
CODE DESCRIPTION

C - credenza

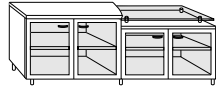
SPECIAL FEATURES

- Horizontal glass surfaces on Credenzas feature 10 mm thick frosted tempered glass.
- Locks are optional on wood doors at a price of **\$152 list** per lock mechanism.
- Wooden shelves are height adjustable in increments of 1 1/4".
- Bookmatched Birdseye Maple veneer is available on worksurfaces of VIRTU cases at an upcharge of **\$76 list** per square foot.

Description	Model	Cherry/Maple/ Walnut	Anigre	W	D	H	Shipping Weight	Cubic Feet
Credenza	62C-75202903G*	8939	10278	75	20	29.5	217	27
Standard Height	62C-75242903G*	9135	10498	75	24	29.5	255	32
glass doors	62C-75202904G**	8939	10278	75	20	29.5	217	27
partial glass top	62C-75242904G**	9135	10498	75	24	29.5	255	32



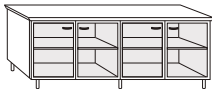
**



ORDERING NOTES

Bookmatched Birdseye Maple veneer is available on worksurfaces of VIRTU cases at an upcharge of **\$76 list per square foot.**

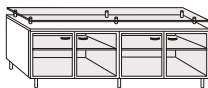
Credenza	62C-75202905G	7369	8477	75	20	29.5	217	27
Standard Height	62C-75242905G	7571	8709	75	24	29.5	255	32
glass doors								
full wood top								



ORDERING NOTES

Bookmatched Birdseye Maple veneer is available on worksurfaces of VIRTU cases at an upcharge of **\$76 list per square foot.**

Credenza	62C-75202906G	8521	9800	75	20	29.5	217	27
Standard Height	62C-75242906G	8724	10032	75	24	29.5	255	32
glass doors								
full glass top								



ORDERING PROCEDURE

To order, please specify the following:

1. Product model number
2. Wood species and finish
3. Metal finish
4. Special options/features

CODE DESCRIPTION

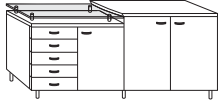
C - credenza
G - glass doors

SPECIAL FEATURES

- Horizontal glass surfaces on Credenzas feature 10 mm thick frosted tempered glass.
- Wooden shelves are height adjustable in increments of 1 1/4".
- Bookmatched Birdseye Maple veneer is available on work surfaces of VIRTU cases at an upcharge of **\$76 list** per square foot.

VIRTU | BUFFETS

Description	Model	Cherry/Maple/ Walnut			W	D	H	Shipping Weight	Cubic Feet
		Walnut	Anigre						
Buffet	62BU-75203501*	7085	10680		75	20	34.5	245	31
wood drawers	62BU-75243501*	9492	10915		75	24	34.5	295	37
wood doors	62BU-75203502**	9290	10680		75	20	34.5	245	31
partial glass top	62BU-75243502**	9492	10915		75	24	34.5	295	37



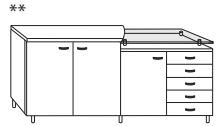
ORDERING NOTES

Wood doors feature an optional lock at a price of **\$152 list**.

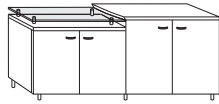
Buffets ordered with mini refrigerators have different interior dimensions than those ordered without.

Refrigerators cannot be retrofitted into a unit shipped without a refrigerator.

Bookmatched Birdseye Maple veneer is available on worksurfaces of VIRTU cases at an upcharge of **\$76 list per square foot**.



Buffet	62BU-75203503*	8594	9883		75	20	34.5	245	31
wood doors	62BU-75243503*	8797	10116		75	24	34.5	295	37
partial glass top	62BU-75203504**	8594	9883		75	20	34.5	245	31
	62BU-75243504**	8797	10116		75	24	34.5	295	37



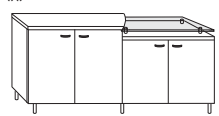
ORDERING NOTES

Wood doors feature an optional lock at a price of **\$152 list** per set of two doors.

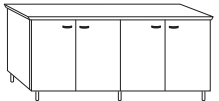
Buffets ordered with mini refrigerators have different interior dimensions than those ordered without.

Refrigerators cannot be retrofitted into a unit shipped without a refrigerator.

Bookmatched Birdseye Maple veneer is available on worksurfaces of VIRTU cases at an upcharge of **\$76 list per square foot**.



Buffet	62BU-75203505	7027	8074		75	20	34.5	245	31
wood doors	62BU-75243505	7234	8321		75	24	34.5	295	37
full wood top									



ORDERING NOTES

Wood doors feature an optional lock at a price of **\$152 list** per set of two doors.

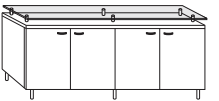
Buffets ordered with mini refrigerators have different interior dimensions than those ordered without.

Refrigerators cannot be retrofitted into a unit shipped without a refrigerator.

Bookmatched Birdseye Maple veneer is available on worksurfaces of VIRTU cases at an upcharge of **\$76 list per square foot**.

This item is available on the KrugExpress quickship program.

Buffet	62BU-75203506	8232	9466		75	20	34.5	245	31
wood doors	62BU-75243506	8414	9671		75	24	34.5	295	37
full glass top									



ORDERING NOTES

Wood doors feature an optional lock at a price of **\$152 list** per set of two doors.

Buffets ordered with mini refrigerators have different interior dimensions than those ordered without.

Refrigerators cannot be retrofitted into a unit shipped without a refrigerator.

ORDERING PROCEDURE

To order, please specify the following:

1. Product model number
2. Wood species and finish
3. Metal finish
4. Special options/features

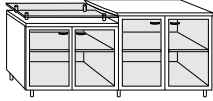
CODE DESCRIPTION

BU - buffet

SPECIAL FEATURES

- Buffets with wood drawers feature a cutlery drawer for serving needs.
- Horizontal glass surfaces on Buffets feature 10 mm thick frosted tempered glass.
- Optional Mini Refrigerators are available on 24" deep units at a price of **\$2638 list**. Please contact Customer Service for specific information.
- Locks are optional on wood doors at a price of **\$152 list** per lock mechanism.
- Bookmatched Birdseye Maple veneer is available on worksurfaces of VIRTU cases at an upcharge of **\$76 list** per square foot.

Description	Model	Cherry/Maple/ Walnut		Anigre	W	D	H	Shipping Weight	Cubic Feet
Buffet	62BU-75203503G*	9201	10577	75	20	34.5	245	31	
glass doors	62BU-75243503G*	9395	10802	75	24	34.5	295	37	
partial glass top	62BU-75203504G**	9201	10577	75	20	34.5	245	31	
*	62BU-75243504G**	9395	10802	75	24	34.5	295	37	



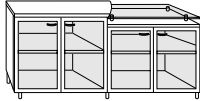
ORDERING NOTES

Buffets ordered with mini refrigerators have different interior dimensions than those ordered without.

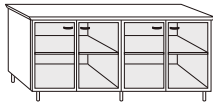
Refrigerators cannot be retrofitted into a unit shipped without a refrigerator.

Bookmatched Birdseye Maple veneer is available on worksurfaces of VIRTU cases at an upcharge of **\$76 list per square foot**.

**



Buffet	62BU-75203505G	7644	8788	75	20	34.5	245	31
glass doors	62BU-75243505G	7835	9010	75	24	34.5	295	37
full wood top								



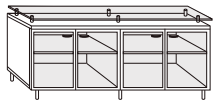
ORDERING NOTES

Buffets ordered with mini refrigerators have different interior dimensions than those ordered without.

Refrigerators cannot be retrofitted into a unit shipped without a refrigerator.

Bookmatched Birdseye Maple veneer is available on worksurfaces of VIRTU cases at an upcharge of **\$76 list per square foot**.

Buffet	62BU-75203506G	8785	10099	75	20	34.5	245	31
glass doors	62BU-75243506G	8983	10330	75	24	34.5	295	37
full glass top								



ORDERING NOTES

Buffets ordered with mini refrigerators have different interior dimensions than those ordered without.

Refrigerators cannot be retrofitted into a unit shipped without a refrigerator.

ORDERING PROCEDURE

To order, please specify the following:

1. Product model number
2. Wood species and finish
3. Metal finish
4. Special options/features

CODE DESCRIPTION

BU - buffet
G - glass doors

SPECIAL FEATURES

- Buffets with wood drawers feature a cutlery drawer for serving needs.
- Horizontal glass surfaces on Buffets feature 10 mm thick frosted tempered glass.
- Optional Mini Refrigerators are available on 24" deep units at a price of **\$2638 list**. Please contact Customer Service for specific information.
- Locks are optional on wood doors at a price of **\$152 list** per lock mechanism.
- Bookmatched Birdseye Maple veneer is available on worksurfaces of VIRTU cases at an upcharge of **\$76 list** per square foot.

VIRTU | SERVER CART AND MEDIA CART

Description	Model	Cherry/Maple/ Walnut	Anigre	W	D	H	Shipping Weight	Cubic Feet
Server Cart refuse container cutlery drawer glass serving shelf	62MSC-422435	4918	5655	42.25	23.5	34.5	180	23



Mobile Media Cart wood top wood doors	62MMC-402438	4494	5168	40	24.25	38.5	188	22
---	--------------	------	------	----	-------	------	-----	----



ORDERING NOTES

It is recommended that Media Carts be moved by 2 people when A/V equipment is attached.

Mobile Media Cart wood top, wood shelf wood doors	62MMC-402447	4721	5429	40	24.25	46.5	190	28
---	--------------	------	------	----	-------	------	-----	----



ORDERING NOTES

It is recommended that Media Carts be moved by 2 people when A/V equipment is attached.

ORDERING PROCEDURE

To order, please specify the following:

1. Product model number
2. Wood species and finish
3. Metal finish
4. Special options/features

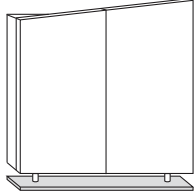
CODE DESCRIPTION

MSC - Mobile Carts
MMC - Mobile Media Cart

SPECIAL FEATURES

- Locks are available on wood doors at a price of **\$152 list** per lock mechanism.
- Interior shelves are height adjustable in increments of 1 1/4".
- Interior wood shelves are removable.

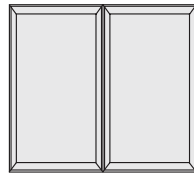
Description	Model	Cherry/Maple/ Walnut			W	D	H	Shipping Weight	Cubic Feet
		Anigre							
Visual Board inclined doors wood doors glass shelf	62VB-3632IGS	4245	4834	36	-	32	73	5	
	62VB-4832IGS	4617	5256	48	-	32	93	6.5	
	62VB-4848IGS	4893	5566	48	-	48	128	10	



ORDERING NOTES

Includes an upholstered tackboard in grade 1 fabric or optional cork surface. Please specify a tackboard fabric when ordering. Visual Boards also include a flip chart, eraser and four dry erase markers. An optional pull down screen is also available at **\$245 list**.

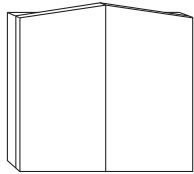
Visual Board glass doors	62VB-3632G	4758	5346	36	-	32	68	5
	62VB-4832G	5286	5923	48	-	32	88	6.5
	62VB-4848G	5719	6390	48	-	48	123	10



ORDERING NOTES

Visual Board includes four dry erase markers. An optional pull down screen is also available at **\$245 list**. Flip chart and tackboard are not available on this model.

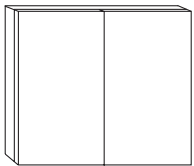
Visual Board gabled doors wood doors	62VB-3632A	4061	4669	36	-	32	73	5.5
	62VB-4832A	4378	5034	48	-	32	93	7
	62VB-4848A	4632	5327	48	-	48	128	10.5



ORDERING NOTES

Includes an upholstered tackboard in grade 1 fabric or optional cork surface. Please specify a tackboard fabric when ordering. Visual Boards also include a flip chart, eraser and four dry erase markers. An optional pull down screen is also available at **\$245 list**.

Visual Board wood doors	62VB-3632	3937	4528	36	-	32	71	5
	62VB-4832	4259	4893	48	-	32	90	6.5
	62VB-4848	4485	5154	48	-	48	125	10



ORDERING NOTES

Includes an upholstered tackboard in grade 1 fabric or optional cork surface. Please specify a tackboard fabric when ordering. Visual Boards also include a flip chart, eraser and four dry erase markers. An optional pull down screen is also available at **\$245 list**.

ORDERING PROCEDURE

To order, please specify the following:

1. Product model number
2. Wood species and finish
3. Metal finish
4. Special options/features

CODE DESCRIPTION

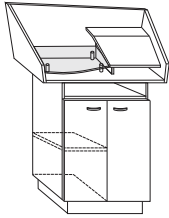
VB - Visual boards
A - gabled Doors
G - glass doors
GS - glass shelf
IGS - inclined glass shelf

SPECIAL FEATURES

- Server Carts come with a cutlery drawer and refuse container.
- Media Carts feature built in a power bar and cable slot for wire management.
- Locks are optional on wood doors at a price of **\$152 list** per lock mechanism.
- Mobile Media Carts will generously accommodate monitors up to 27" in size. Please contact Customer Service if dimensions are critical.
- Server Cart and Media Cart top surface overhang and underside finger groove facilitate movement.

VIRTU | LECTERN

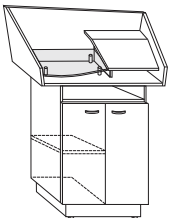
Description	Model	Cherry/Maple/ Walnut	Anigre	W	D	H	Shipping Weight	Cubic Feet
Lectern - floor lectern hardware storage with hinged access door hinged doors glass laptop shelf	62LN-37225011	6974	8017	37	22	50	215	25



ORDERING NOTES

Lectern features grommets for wire management.
Left side shelf is adjustable on this version. Right side of this version is open.

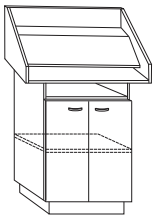
Lectern - mobile lectern hardware storage with hinged access door hinged doors glass laptop shelf	62LNM-37225011	7147	8220	37	22	50	215	25
---	----------------	------	------	----	----	----	-----	----



ORDERING NOTES

Lectern features grommets for wire management.
Left side shelf is adjustable on this version. Right side of this version is open.

Lectern - floor lectern hardware storage hinged doors full width worksurface	62LNX-37225011	6596	7632	37	22	50	215	25
---	----------------	------	------	----	----	----	-----	----



ORDERING NOTES

Lectern features grommets for wire management.
Center shelf on this version is adjustable.

ORDERING PROCEDURE

To order, please specify the following:

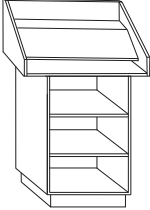
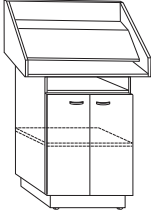
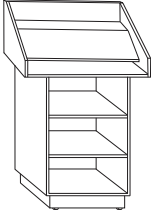
1. Product model number
2. Wood species and finish
3. Metal finish
4. Special options/features

CODE DESCRIPTION

LN - Lectern
LNM - Lectern (mobile)
LNX - Lectern with full
width shelf

SPECIAL FEATURES

- See above for special features specific to each Visual board tackboard fabrics
- Please contact Customer Service for information on Grade 1 fabrics suitable for use on Visual Board tackboards.
- COM and other in-stock fabrics may be specified at an upcharge. Please contact Customer Service for details.

Description	Model	Cherry/Maple/ Walnut			W	D	H	Shipping Weight	Cubic Feet
		Walnut	Anigre						
Lectern - floor lectern open shelves full width worksurface	62LNX-37225017	6330	7365	37	22	50	205	25	
	ORDERING NOTES Lectern features grommets for wire management. Both shelves on this version are adjustable.								
Lectern - mobile lectern hardware storage with hinged access door hinged doors full width worksurface	62LNXM-37225011	6833	7873	37	22	50	215	25	
	ORDERING NOTES Lectern features grommets for wire management.								
Lectern - mobile lectern open shelves full width worksurface	62LNXM-37225017	6567	7607	37	22	50	205	25	
	ORDERING NOTES Lectern features grommets for wire management.								
Logo Plate	62-LOGO-14-7	823		14	0.4	6.3			



The Satin Aluminum Logo Plate comes unattached to the Lectern. It is designed to be provided to a signage company for application of the company logo, with either a vinyl transfer or silk screening. After the signage is complete, the Logo Plate can be attached to the Lectern surface. First, determine the position that the Logo Plate is to be positioned. Remove the black plastic end caps and attach via wood screws. Once secure, snap the Logo Plate over top of the end caps to complete the installation.

ORDERING PROCEDURE

To order, please specify the following:

1. Product model number
2. Wood species and finish
3. Metal finish
4. Special options/features

CODE DESCRIPTION

LNXM - Lectern with full length shelf (mobile)

SPECIAL FEATURES

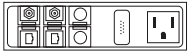
- Lecterns are designed to accommodate microphones which can be field installed. Please contact Customer Service for more information.
- All hinged doors on Lecterns feature standard locks.

Lectern options

- Altinex Box : price of **\$1273 list.**
- Power Bar : price of **\$208 list.**
- Reference Light : price of **\$443 list.**

VIRTU | ELECTRICAL ACCESSORIES

Description	Model	Price
Altinex Box		1273



ORDERING NOTES

Please note clearly on order if Altinex is to be added to lectern

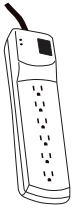
Whip Cord	62EX	204
-----------	------	-----



ORDERING NOTES

A short extension cord with standard male/female 3 prong head at either end. Enables Connexus™ use with large transformers, such as the Polycom conference phone, to connect externally from the module.

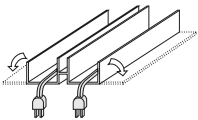
Power Bar	62PWR01	204
-----------	---------	-----



ORDERING NOTES

Power bars feature a 6' long cord, 6 AC power outlets and a circuit breaker. Power bars can be added to table bases, Media Cabinets and Lecterns. Power bars are standard on Media Carts.

Wire Management Trough	62WM-48	93
------------------------	---------	----



ORDERING PROCEDURE

To order, please specify the following:

1. Product model number

CODE DESCRIPTION

EX - Whip cord
PWR - Power bar

VIRTU | INSTALLATION INSTRUCTIONS

SINGLE SECTION WITH DAIS, FORZA SQUARE & OBLIQUE



COMPONENTS

- 3/4" Hex drive bolt (112164)
- 8 per Dais/Oblique base
- 12 per Verso/Forza Square base

TOOLS REQUIRED

- 5/32" Allen Key or driver

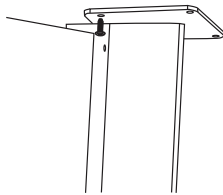
IMPORTANT: If table has Connexus™ modules, install them using their instructions before proceeding.

PROCEDURE

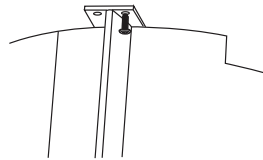
1. Unpack table and all base(s). Find all of the hardware listed. Fasteners are in a bag on the bottom of one section (some fasteners may be shipped with the bases).
MAKE SURE THE CORRECT SIZE AND QUANTITY OF COMPONENTS ARE INCLUDED WITH THE TABLE.

2. Put base(s) in the approximate place where the table will be located in the room. Place over base(s). Align the metal base plates with the inserts in the underside of the top.

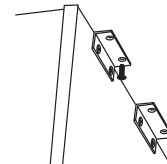
3. To fasten bases to the top, insert the 3/4" bolts through the plate on the base and into the inserts. Start threading the bolts by hand to prevent cross-threading. Tighten with Allen key or power driver.



Forza

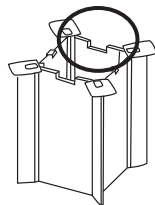


Dais

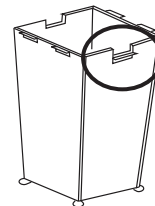


Oblique

4. Attach wire management components to bottom of assembled table. For additional help please contact Customer Service.



cut outs face towards center of table



door faces towards center of table

CAUTION: TABLES CAN BE EXTREMELY HEAVY. MAKE SURE THERE ARE SUFFICIENT PEOPLE AVAILABLE TO FLIP TABLE UPRIGHT. DO NOT SUBSTITUTE HARDWARE. IF HARDWARE IS MISSING, CONTACT CUSTOMER SERVICE.

VIRTU | INSTALLATION INSTRUCTIONS

OPEN VISIO



COMPONENTS

- A) 3/4" hex drive bolt (112164)
 - 6 per Forza Leg
 - + 16 per joint



- B) Tite-joint fastener (10637)
 - 3 per joint



- C) Fastener rod (11687)

TOOLS REQUIRED

- 5/32" Allen Key or driver

IMPORTANT: If table has Connexus™ modules, install them using their instructions before proceeding.

PROCEDURE

1. Unpack all table sections and bases. Find all the hardware listed. Fasteners are in a bag on the bottom of one section (some fasteners may be shipped with the bases). **MAKE SURE THE CORRECT SIZE AND QUANTITY OF COMPONENTS ARE INCLUDED WITH THE TABLE.**
2. Place single end section table upside down onto a soft surface. See figure 1.

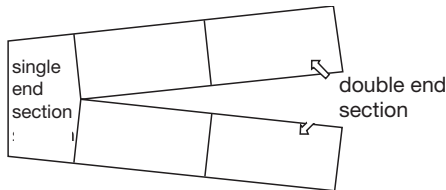


Figure 1

3. Fasten six bases to the top, insert the 3/4" bolts (A) through the plate on the base and into the inserts. Start threading the bolts by hand to prevent cross-threading. Tighten with allen key or power driver.
4. Stand end section upright.
5. Place center table sections upside down onto a soft surface. Identify top section number coding on bottom of sections that is the same as the single end section.
6. Fasten two bases to the top on the other end from the location found in step 5. See figure 2. Insert the 3/4" bolts (A) through the plate on the base and into the inserts. Start threading the bolts by hand to prevent cross-threading. Tighten with allen key or power driver.

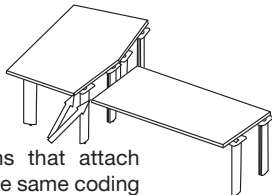
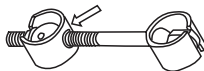


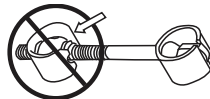
Figure 2

Sections that attach will have same coding underside

7. Stand centre section upright and attach to appropriate side of single end section. Insert the 3/4" bolts (A) through the plate on the base and into the inserts. Start threading the bolts by hand to prevent cross-threading. Tighten with allen key or power driver.
8. Repeat steps 5-7 for double end sections.
9. Assemble the tite-joint fastener as shown in figure 3. Install assembled tite-joint with machining in table sections.



correctly installed



incorrectly installed

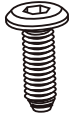
10. Flush the edge of the sections and tighten fasteners with rod provided (C). Do not over tighten.
11. Adjust top alignment, if required by slightly loosening tite-joint fasteners and base plate bolts, making the adjustment and re-tightening fasteners and bolts.
12. Attach modesty panels with L-brackets and screws provided.
13. Attach wire management extrusion to modesty panels with screws provided.

For additional help please contact Customer Service.

CAUTION: TABLES CAN BE EXTREMELY HEAVY. MAKE SURE THERE ARE SUFFICIENT PEOPLE AVAILABLE TO FLIP TABLE UPRIGHT. DO NOT SUBSTITUTE HARDWARE. IF HARDWARE IS MISSING, CONTACT CUSTOMER SERVICE.

VIRTU | INSTALLATION INSTRUCTIONS

SINGLE SECTION WITH FORZA LEGS OR PANELS



COMPONENTS

- 3/4" Hex drive bolt (112164)
- 6 per leg/12 per panel

TOOLS REQUIRED

- 5/32" Allen Key or driver

IMPORTANT: If table has Connexus™ modules, install them using their instructions before proceeding.

PROCEDURE

1. Unpack table and all bases. Find all the hardware listed. Fasteners are in a bag on the bottom of one section (some fasteners may be shipped with the bases.) **MAKE SURE THE CORRECT SIZE AND QUANTITY OF COMPONENTS ARE INCLUDED WITH THE TABLE.**
2. Place table upside down onto a soft surface. As shown in Figure 1, invert and position the bases onto the underside of the table and align the metal base plates with the inserts in the underside of the top. **THE BLACK PLASTIC EXTRUSION FACES TOWARDS THE CENTER OF THE TABLE.**

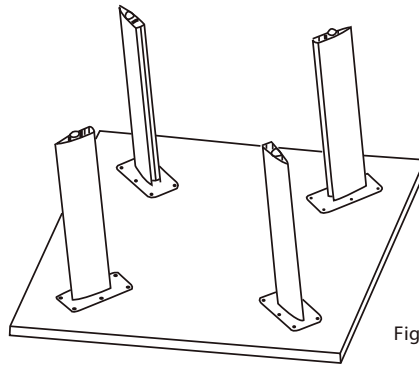


Figure 1

3. To fasten bases to the top, insert the 3/4" bolts through the plate on the base and into the inserts. Start threading the bolts by hand to prevent cross-threading. Tighten with allen key or power driver.
4. Flip assembled table over.
5. Attach wire management components to bottom of assembled table.

For additional help please contact Customer Service.

CAUTION: TABLES CAN BE EXTREMELY HEAVY. MAKE SURE THERE ARE SUFFICIENT PEOPLE AVAILABLE TO FLIP TABLE UPRIGHT. DO NOT SUBSTITUTE HARDWARE. IF HARDWARE IS MISSING, CONTACT CUSTOMER SERVICE.

VIRTU | INSTALLATION INSTRUCTIONS

MULTI-SECTION WITH FORZA LEGS OR PANELS

COMPONENTS

- A) 3/4" Hex drive bolt (112164)
 • 16 per joint
 + (8 per Dais/Oblique)/(12 per Verso/Forza)



TOOLS REQUIRED

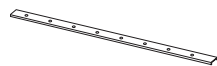
- 5/32" Allen Key or driver



- B) Tite-joint fastener (10637)
 • 3 per joint



- C) Fastener rod (11687)



- D) Channel bracket
 • per joint

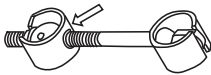
IMPORTANT: If table has Connexus™ components, install them using their instructions before proceeding.

PROCEDURE

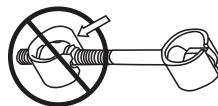
1. Unpack all table sections and bases. Find all the hardware listed. Fasteners are in a bag on the bottom of one section and the channels are wrapped together (some fasteners may be shipped with the bases.) **MAKE SURE THE CORRECT SIZE AND QUANTITY OF COMPONENTS ARE INCLUDED WITH THE TABLE.**
2. Place table upside down onto a soft surface. Arrange top sections by the number coding on bottom of sections.
3. For tables with four (4) or more sections refer to chart for assembly detail. Align the machining in one section with the machining in the adjacent section. Bring the sections tight together.

Top	Top Lengths	Assembly Order	
		Before Flipping	After Flipping
	168 192	ACW3-BCW3 CCE3-DCE3	ACW3/BCW3-CCE3/DCE3
	216 240	ACW3-BCW3 DCE3-ECE3	ACW3/BCW3-CCW3 CCW3-DCE3/ECE3
	264 288	ACW3-BCW3 ECE3-FCE3 CCW3-DCE3	ACW3/BCW3-CCW3/DCE3 CCW3/DCE3-ECE3/FCE3

4. Assemble the tite-joint fastener as shown in figure 1. Install assembled tite-joint with machining in table sections.



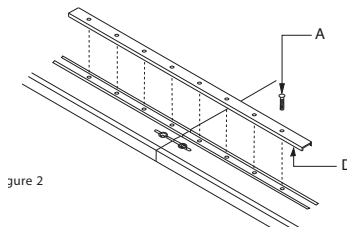
correctly installed



incorrectly installed

5. Flush the edge of the sections and tighten fasteners with rod provided (C). Do not over tighten
6. As shown in Figure 2, align holes in the channel brackets (D) with threaded inserts in the top sections. To fasten the channel brackets, start threading the 3/4" bolts (A) by hand. This will prevent cross-threading the bolt into the inserts, which may cause damage to the table tops.

Figure 2



VIRTU | INSTALLATION INSTRUCTIONS

7. As shown in Figure 3, invert and position the bases onto the underside of the outer table sections and align the metal base plates with the inserts in the underside of the top. To fasten bases to the top, insert the 3/4" bolts (A) through the plate on the base and into the inserts. Start threading the bolts by hand to prevent cross-threading. Tighten with allen key or power driver.

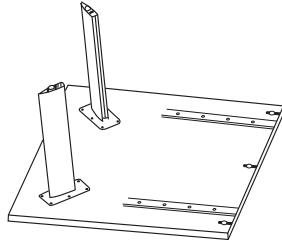
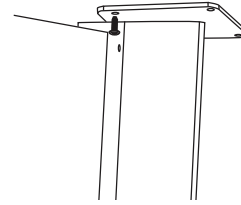
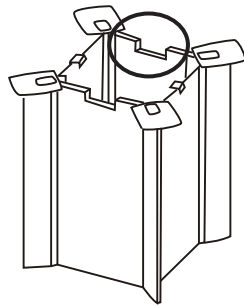


Figure 3



8. If table has center bases put bases in the approximate place where the table will be located in the room. Flip all assembled table sections over and place over center bases (if required). Repeat steps 4-6 (if required) for sections not already attached.



cut outs face towards
center of table

9. Adjust top alignment, if required by slightly loosening tite-joint fasteners and channel bracket bolts, making the adjustment and re-tightening fasteners and bolts.

10. Attach wire management extrusion to bottom of assembled table with screw provided.

For additional help please contact Customer Service.

CAUTION: TABLES CAN BE EXTREMELY HEAVY. MAKE SURE THERE ARE SUFFICIENT PEOPLE AVAILABLE TO FLIP TABLE UPRIGHT. DO NOT SUBSTITUTE HARDWARE. IF HARDWARE IS MISSING, CONTACT CUSTOMER SERVICE.

VIRTU | INSTALLATION INSTRUCTIONS

MULTI-SECTION WITH DAIS, VERSO, FORZA SQUARE & RECTANGLE AND OBLIQUE

COMPONENTS

TOOLS REQUIRED

A) 3/4" Hex drive bolt (112164) 5/32" Allen Key or driver
 • 16 per joint
 + (8 per Dais/Oblique)/(12 per Verso/Forza)

B) Tite-joint fastener (10637)
 • 3 per joint

C) Fastener rod (11687)

D) Channel bracket
 • per joint

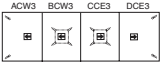
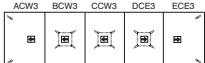
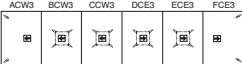
IMPORTANT: If table has Connexus™ modules, install them using their instructions before proceeding.

PROCEDURE

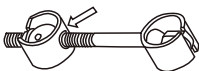
1. Unpack all table sections and bases. Find all the hardware listed. Fasteners are in a bag on the bottom of one section and the channels are wrapped together (some fasteners may be shipped with the bases.)
MAKE SURE THE CORRECT SIZE AND QUANTITY OF COMPONENTS ARE INCLUDED WITH THE TABLE.

2. Place table upside down onto a soft surface. Arrange top sections by the number coding on bottom of sections.

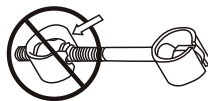
3. For tables with four (4) or more sections refer to chart for assembly detail. Align the machining in one section with the machining in the adjacent section. Bring the sections tight together.

Top	Top Lengths	Assembly Order	
		Before Flipping	After Flipping
	168 192	ACW3-BCW3 CCE3-DCE3	ACW3/BCW3-CCE3/DCE3
	216 240	ACW3-BCW3 DCE3-ECE3	ACW3/BCW3-CCW3 CCW3-DCE3/ECE3
	264 288	ACW3-BCW3 ECE3-FCE3	ACW3/BCW3-CCW3/DCE3 CCW3/DCE3-ECE3/FCE3

4. Assemble the tite-joint fastener as shown in figure 1. Install assembled tite-joint with machining in table sections.



correctly installed



incorrectly installed

5. Flush the edge of the sections and tighten fasteners with rod provided (C). Do not over tighten

6. As shown in Figure 2, align holes in the channel brackets (D) with threaded inserts in the top sections. To fasten the channel brackets, start threading the 3/4" bolts (A) by hand. This will prevent cross-threading the bolt into the inserts, which may cause damage to the table tops.

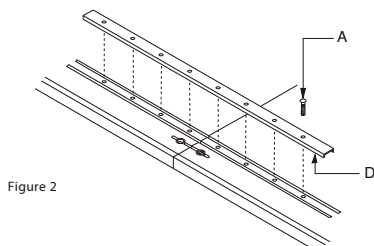
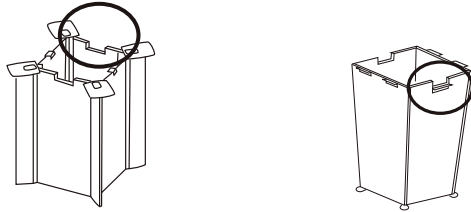


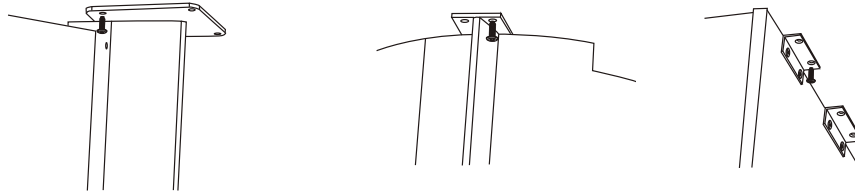
Figure 2

Multi-Section with Dais, Verso, Forza Square & Rectangle and Oblique

7. As shown in Figure 3, invert and position the bases onto the underside of the outer table sections and align the metal base plates with the inserts in the underside of the top. To fasten bases to the top, insert the 3/4" bolts (A) through the plate on the base and into the inserts. Start threading the bolts by hand to prevent cross-threading. Tighten with allen key or power driver.



8. To fasten bases to the top, insert the 3/4" bolts (A) through the plate on the base and into the inserts. Start threading the bolts by hand to prevent cross-threading. Tighten with allen key or power driver.



Forza Square
Forza Rectangle
Verso

Dais

Oblique

9. Adjust top alignment, if required by slightly loosening tite-joint fasteners and channel bracket bolts, making the adjustment and re-tightening fasteners and bolts.

10. Attach wire management extrusion to bottom of assembled table with screw provided.

For additional help please contact Customer Service.

CAUTION: TABLES CAN BE EXTREMELY HEAVY. MAKE SURE THERE ARE SUFFICIENT PEOPLE AVAILABLE TO FLIP TABLE UPRIGHT. DO NOT SUBSTITUTE HARDWARE. IF HARDWARE IS MISSING, CONTACT CUSTOMER SERVICE.

VIRTU | INSTALLATION INSTRUCTIONS

CONNEXUS™ INTERFACE INSTALLATION

We recommend that you place the table on a soft surface
SAVE THESE INSTRUCTIONS

Tools Required:

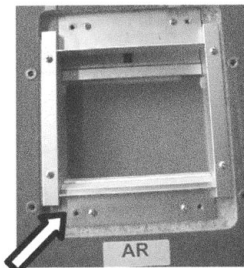
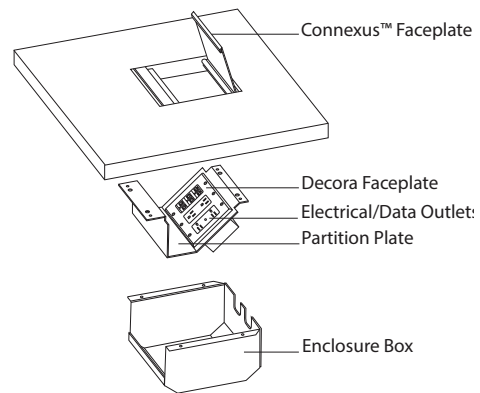
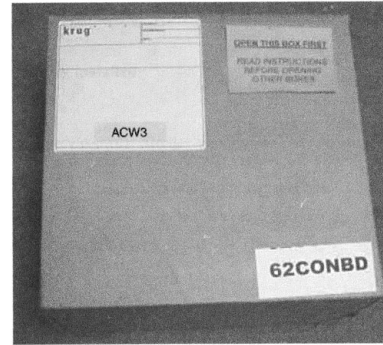
Drill with driver bits or screwdriver

Utility Knife (if required)

INSTALLATION

1. Identify ALL the connexus locations on the top sections and connexus cartons. (They will be labeled with a green tag to indicate the location within the table. For example, ACW3. See Figure 1. Place the cartons (containing the connexus Interface) with the same coded top section carton.
2. Open the top carton that corresponds with the carton that these instructions came from and then remove protective packaging from both top and interface. Do each interface and top section one at a time to prevent mixing interfaces.
3. After unpacking, place the top section with the bottom facing up on a soft surface as to not damage the top.
4. Place the tongue of the corresponding interface into aluminum extrusion in top, see Fig. 2a. Aligning the electrical components in the interface over the door hinge on the aluminum components in the top. The door hinge side of the connexus is labeled with the location code, see Fig. 2b. Screw interface to inserts in the table top with screws shown in Fig. 3.
5. Align the u-shaped cutouts in the cover-box with the electrical components in the interface. Pass the power cord thru one of the u-shaped cutouts. The large flat face of the interface should line up flush with the large opening in the cover-box. Screw cover box to table top with screws shown in Fig. 3.
6. Repeat steps 3 to 5 for each location.
7. Assemble top according to Assembly instructions provided.
8. Attach wire management extrusion to bottom of assembled table. Trough may need to be cut to length. Align the extrusion with the bases and/or the cutout in the cover-box as required with screws provided.

For additional help please contact Customer Service



Door hinge

Figure 2b

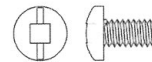


Figure 3

VIRTU | INSTALLATION INSTRUCTIONS

On-site RJ45 wire instructions

Category 6 Snap-In Connector Installation Instructions

INTRODUCTION: Leviton Telcom eXtreme 6 products are designed to work as a system to achieve proposed Category 6 component level performance. The Leviton eXtreme 6 Cabling System consists of eXtreme 6 connectors and eXtreme patch cords, as well as “gigabit-rated” cable from a Leviton eXtreme cable partner. If Category 5 components are substituted for eXtreme components, a lesser performance level can be expected.

SAFETY INFORMATION

1. Never install communications wiring or components during a lightning storm.
2. Never install communications components in wet locations unless the components are designed specifically for use in wet locations.
3. Never touch uninsulated wires or terminals unless the wiring has been disconnected at the network interface.
4. Use caution when installing or modifying communications wiring or components.
5. To prevent electrical shock, each opening must be filled with a module or blank filler.

IMPORTANT INSTRUCTIONS

1. Read and understand all instructions.
2. Follow all warnings and instructions marked on the product.
3. Do not use this product near water—e.g., near a tub, wash bowl, kitchen sink or laundry tub, in a wet basement, or near a swimming pool.
4. Never push objects of any kind into this product through cabinet slots, as they may touch dangerous voltages.

SAVE THESE INSTRUCTIONS

1. Remove connector from Connexus interface panel by inserting a small flat screw into top of connector/ faceplate and twist slightly.

Connector should pop out.

2. Remove about 2” of jacket from cable.
3. Determine which wiring scheme (T568A or T568B) and note the associated color codes on the label located between the IDC connector slots. The label also includes connector pin numbers. Refer to Fig 2-1 & 2-2.
4. Route the wires for termination as shown in Fig 3-1. Terminate one pair at a time starting from the side of cable entry. Terminating each pair after placement will prevent crushing the inside pairs with a punch-down tool (not supplied). Lay cable in so that jacket touches edge of connector as shown.*
5. Using a 110 style impact tool set to “low” impact (not supplied), seat the wires into the IDC slots. Maintain wire pair twisting as close as possible to the IDC contact (Must be 1/4” or closer). Use the cutting side of the tool to trim the excess wire flush with the connector body. See Fig 4-1.

Pin Numbers
Número de las pautas
Numéros de broches

Color Codes for T568A & B Wiring
Código de color para T568A y cableado B
Chromocodage du câblage de type T568 A et B

2-1

Front View
Vista Frontal
Vue Avant

2-2

T568A & T568B Wiring Standards - Connector Pin/Color Assignments
Normativas de cableado T568A y T568B - Patillas de conexión/Asignaciones de color
Normes de câblage T568A et T568B - Attributions broche / couleur des connecteurs

	CABLE ENTRY FROM LEFT Entrada de cable desde la izquierda Entrée de câble par la gauche	CABLE ENTRY FROM RIGHT Entrada de cable desde la derecha Entrée de câble par la droite
T568A	<p>4 5 2 1 8 7 6 3</p>	<p>4 5 2 1 8 7 6 3</p>
	5 WHITE/BLUE 4 BLUE/WHITE 3 WHITE/ORANGE 6 ORANGE/WHITE 1 WHITE/GREEN 2 GREEN/WHITE 7 WHITE/BROWN 8 BROWN/WHITE	Blanco/Azul Azul/Blanco Blanco/Naranja Naranja/Blanco Blanco/Verde Verde/Blanco Blanco/Café Café/Blanco
T568B	<p>4 5 2 1 8 7 6 3</p>	<p>4 5 2 1 8 7 6 3</p>
	5 WHITE/BLUE 4 BLUE/WHITE 1 WHITE/ORANGE 2 ORANGE/WHITE 3 WHITE/GREEN 6 GREEN/WHITE 7 WHITE/BROWN 8 BROWN/WHITE	Blanco/Azul Azul/Blanco Blanco/Naranja Naranja/Blanco Blanco/Verde Verde/Blanco Blanco/Café Café/Blanco

VIRTU | INSTALLATION INSTRUCTIONS

On site RJ11 wire instructions

Voice grade Snap-In Connector Installation Instructions

SAFETY INFORMATION

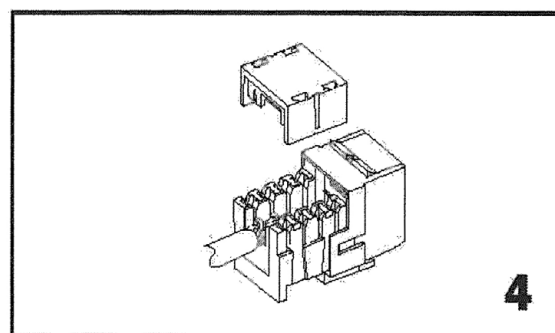
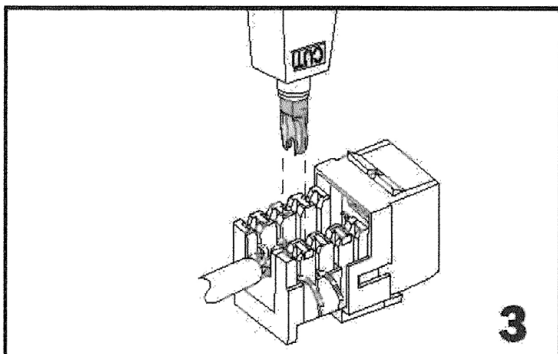
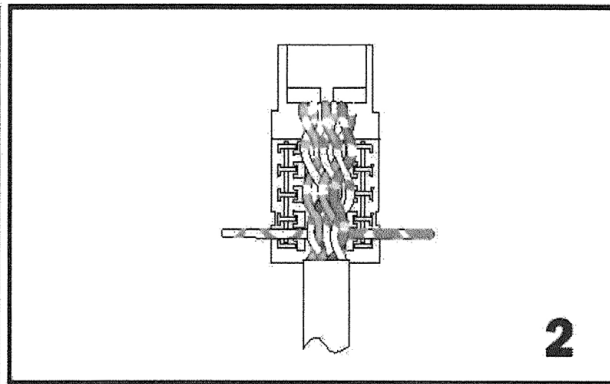
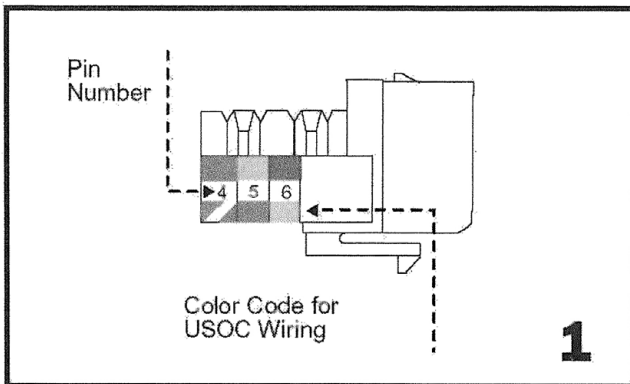
1. Never install communications wiring or components during a lightning storm.
2. Never install communications components in wet locations unless the components are designed specifically for use in wet locations.
3. Never touch uninsulated wires or terminals unless the wiring has been disconnected at the network interface.
4. Use caution when installing or modifying communications wiring or components.
5. To prevent electrical shock, each opening must be filled with a module or blank filler.

IMPORTANT INSTRUCTIONS

1. Read and understand all instructions.
2. Follow all warnings and instructions marked on the product.
3. Do not use this product near water—e.g., near a tub, wash bowl, kitchen sink or laundry tub, in a wet basement, or near a swimming pool.
4. Never push objects of any kind into this product through cabinet slots, as they may touch dangerous voltages.

SAVE THESE INSTRUCTIONS

1. Remove connector from Connexus interface panel by inserting a small flat screw into top of connector/ faceplate and twist slightly. Connector should pop out.
2. Remove jacket from cable.
3. Check jack termination label (located on sides of jack) for wiring standard and associated color codes. The label also includes jack pin numbers. (Figure 1)
4. Route the wires for termination as shown in Figure 2.
5. Using a 110 style punch-down tool (not supplied), seat the wires into the IDC slots. With the cutting edge of the tool to the outside, trim the excess wire flush with the jack body. (Figure 3)
6. Place the cap over the termination wires for secure connection and added strain relief. (Figure 4)
7. Insert connector assembly into Connexus interface. Note the “UP” position of the connector.



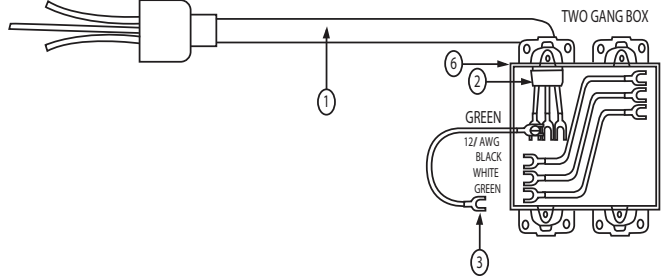
On site electrical outlet wire schematic

1. Power supply
2. Strain relief
3. Fork terminal
4. Duplex receptacles
5. Outlet with breaker assembly
6. Handy box

HARDWIRING ON SITE

For hardwiring on-site by electricians, please use the following schematic:

- ① Power Supply Cord
- ② Strain Relief
- ③ Fork Terminals
- ④ Duplex Receptacles
- ⑤ Outlets with Circuit Breaker Assembly
- ⑥ Handy Box



On site RCA cable hookup

1. Determine the correct length of cord (RCA cable is not supplied).
2. Attach appropriate end of cable to the back of Connexus interface connector.
3. Route cable through appropriate wire management.

On site BNC cable hookup

1. Determine the correct length of cord (BNC cable is not supplied).
2. Attach appropriate end of cable to the back of Connexus interface connector.
3. Route cable through appropriate wire management.

On site 15 PIN HD cable hookup

1. Determine the correct length of cord (VGA cable is not supplied).
2. Attach appropriate end of cable to the back of Connexus interface connector. Tighten fasteners if equipped.
3. Route cable through appropriate wire management.

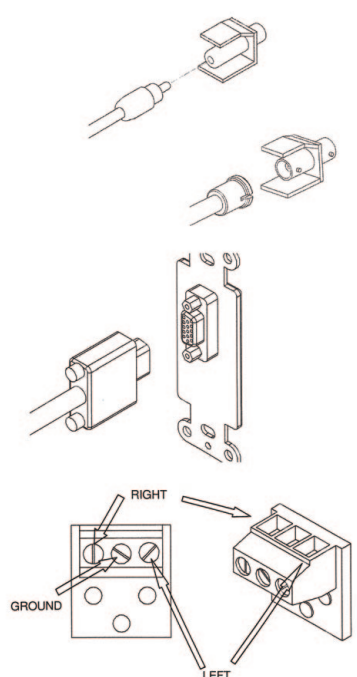
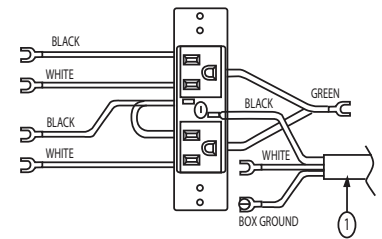
On site DB-9 cable hookup

1. Determine the correct length of cord (Serial cable is not supplied).
2. Attach appropriate end of cable to the back of Connexus interface connector. Tighten fasteners if equipped.
3. Route cable through appropriate wire management.

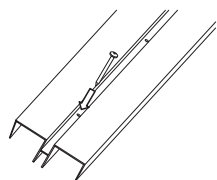
On site MINI STEREO wiring hookup

1. Determine the correct length of cord (shielded 2 conductor cable is not supplied).
2. Remove about 1" of the wire jacket and about 1/4" of insulation from each wire.
3. Insert wire into terminal block and tighten with a 3/32" flat screw driver. See Fig. 1.
4. Route cable through appropriate wire management.

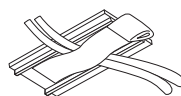
⑤
CIRCUIT BREAKER/OUTLETS ASSEMBLY



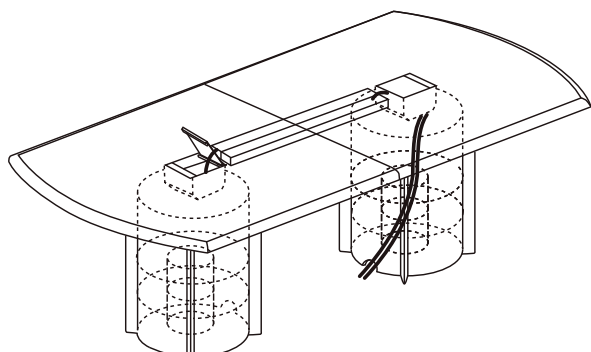
VIRTU | INSTALLATION INSTRUCTIONS



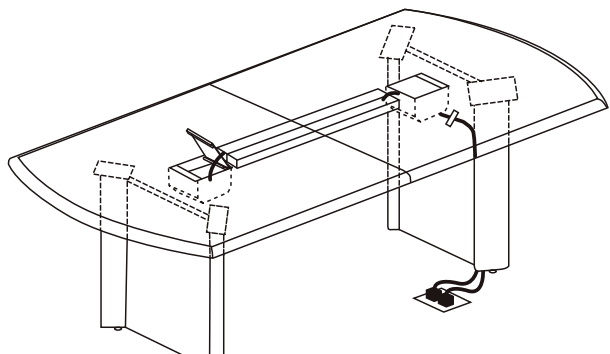
Wire Trough. Used when two or more connexus boxes are installed and with all bases. Trough may need to be cut.



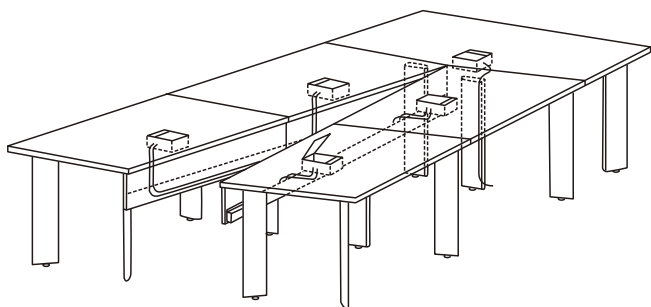
Velcro wire management strap. Used with 6232 & 6238 bases.



Example of wire management routing for table with 6230 bases using wire trough. Similar routing will work for tables 6234 and 6237 bases.



Example of wire management routing for tables with 6232 bases using both the wire trough and Velcro straps.



Example of wire management routing for Open Visio tables using the wire trough

Terms and Conditions

Net 30 days on approved credit. A late payment charge of 1% per month will be applied on overdue invoices. This charge will be pro-rated to the number of days past 30 days that the invoice is overdue. All applicable sales taxes are extra. Distribution of this price list does not in itself constitute an offer to sell. Orders can be received only from authorized Krug dealers. Acceptance of any order and terms of sale may be established at the discretion of Krug. Deposits are required on orders received from new accounts as well as on large or special orders. Krug reserves the right to discontinue designs, or to change designs, construction, prices, or materials without notice.

Contact Information

Phone: 1.888.578.KRUG (5784) | Fax: 1.519.748.5177
Purchase Order Fax: 1.888.236.4783
Purchase Order E-mail: orders@krug.ca
Web: www.krug.ca E-mail: solutions@krug.ca

Customer Service Hours

Please note customer service hours are:
8:30 am to 5:00 pm est

Customer Satisfaction

It is the primary goal of Krug and our staff to ensure the complete satisfaction of our customers with our products and performance. If a problem arises with a Krug product after the expiration of the limited warranty period, Krug will exercise its best efforts to achieve the satisfaction of the customer in a manner that is fair to all concerned.

Order Acknowledgments

Each order will be acknowledged via e-mail or fax. This acknowledgment is the final agreement between Krug and the customer, superseding all previous communications regarding the purchase order. Where there is a discrepancy on a purchase order between a product code and a description, Krug will make every effort to resolve the discrepancy, but will be ruled by the product code ordered. Please check all acknowledgments for accuracy, and advise Krug of any discrepancies with a purchase order.

Order Cancellation

Krug reserves the right to not accept or allow cancellation of orders. All products are manufactured on a custom-made, make-to-order basis, and the purchasing, engineering and production of orders begins shortly after order placement - and the customer purchase order is a contract that authorizes Krug to manufacture the products. Acceptance of order cancellation (or partial cancellation) is solely at the discretion of Krug, and is dependent on the extent to which engineering, purchasing and manufacturing has been initiated by the time cancellation is requested. No order cancellations (partial or otherwise) are allowable more than 4 weeks from date of order placement (as order production is unable to be terminated by that point), and full payment of the acknowledged order value is required for any orders cancelled after 4 weeks. Cancellations may be allowable in less than 4 weeks after order placement, depending on the extent to which manufacturing has been initiated. An acceptance of order cancellation requires that the purchaser agrees to make payment for all costs incurred to the point of acceptance of cancellation. Cancellation charges include all costs for purchase of dedicated material and components, engineering costs for non-standard products, and all costs for manufacturing completed to that point, as well as a \$350 net charge for processing of the original order and for processing of cancellation invoicing.

Pricing

Krug endeavors to ensure that all prices in this price list reflect accurately our current prices. However, errors do occur and will be rectified through notices to the field. Krug reserves the right to acknowledge pricing that may be different from the price list.

Storage Charges

Krug reserves the right to assess a nominal storage charge if a customer does not accept shipment of an order within a week of the ship date.

Warranty

Krug warrants the construction and the finish of all our products to be free from defects in materials and workmanship for a period of 10 years from the date of purchase. This warranty is applicable to products in use by their original purchaser. This warranty does not apply to components not manufactured by Krug including textiles, which are subject to the specific warranties of those manufacturers, if any. Textiles (fabric, leather, vinyl, or any other covering material) suppliers do not guarantee their products for durability and color fastness, and nor does Krug. Casters, mechanical and electrical components have a warranty of five years from the date of purchase. The Krug warranty does not apply to COM-specified materials, damage caused by a carrier other than Krug, or variation in wood finishes due to natural wood color variation. Krug cannot be held responsible for variations in fabric dye lots from order to order. All fabric is carefully inspected when it is received, but a degree of variation in color should be expected. Repairs or replacement of any defect covered under this warranty by Krug will be made, at our option and method, at no charge to the original purchaser during the warranty period. Krug's judgement is final and binding with respect to the nature or cause of defects or damage, and the necessity or manner of repair or replacement.

This warranty does not apply to defects or damage resulting from:

- normal wear and tear occurring with the use of the product
- negligence, misuse, excessive use, alteration, improper cleaning or repair
- substitution or use of incorrect or unauthorized components or material
- handling or installation that is incorrect, or that causes damage or defect
- damage incurred by a freight carrier other than Krug
- wearing of finishes and fabrics, and normal variations in materials (including dye lot variations)
- properties of natural materials, including wood and leather
- exposure to environments with uncontrolled temperature and humidity (products must be transported, stored and used in climate-controlled conditions)

Export Packaging

Krug is pleased to provide the option for export packaging on all our products, to provide additional protection from damage. For shipments overseas, a quote for export packaging can be provided, based on the products to be ordered and the delivery destination - please contact Customer Service or Bids & Specification Support for more information and a quotation. KRUG is not responsible for shipment damage occurring on overseas shipments

Export Packaging is STRONGLY RECOMMENDED for:

- (A) all shipments outside of the lower 48 states and Canada.
- (B) all shipments that will be held in storage for an extended period prior to installation.

Important: Please note that Krug will not be responsible for damage claims on product shipped or stored in the above conditions but where export packaging has not been utilized.

Dimensions

Dimensions are in inches and approximate, and subject to change without notice. Contact Customer Service if dimensions are critical.

Installation Support

For assistance please contact Technical Support at 1-888-578-5784 x216 or e-mail installationhelp@krug.ca and you will be directed to the appropriate installation support person.

Custom Capabilities

Over 15% of our orders involve some type of custom work, and we invite our customers to make use of our extensive capabilities. These include:

- 1) Dimensional customization of standard size products
- 2) Custom wood finishes
- 3) For larger orders, completely custom-designed products, as well as non-standard wood species can be specified.

Custom orders may require additional production lead times. Contact Customer Service for more information.

GENERAL INFORMATION

Freight Terms and Conditions

1. All product is shipped FOB the Krug factory. Freight is either pre-paid to the destination or not pre-paid, depending on established customer specific freight terms.
2. Docks at the selected delivery location must be equipped to handle a 53' trailer. If a dock is inadequate for delivery by Krug, Krug will re-deliver to another local location and any additional costs will be charged to the customer.
3. For all deliveries, it is understood that Krug or its agent is making a dock delivery only (equipped to handle a 53' trailer), and any further work of truck unloading, delivery beyond the dock, installation, and removal of packaging is not authorized or paid for by Krug.
4. Drop shipments to the installation site, and timed deliveries, are available on larger shipments (full truckloads or slightly less) at no additional charge. Drop shipments or timed deliveries for smaller shipments may not be available, or if available will require a surcharge. Deliveries on an after hours basis, or on weekends, or any other special requirements, may be subject to a surcharge. Location and contact information, and the requested time of delivery, is required at least one week prior to the acknowledged shipment date. If this information is not provided one week in advance, or if the location or time of the drop shipment is changed less than one week in advance, a surcharge may be applied, and/or the drop shipment may not be scheduled. For deliveries requested Monday to Thursday after 5:00 pm, please apply a surcharge of \$250/shipment. For deliveries requested Monday to Friday before 7:00 am, please apply a surcharge of \$250/shipment. For deliveries requested Friday (after 3:00 pm) or weekends, please apply a surcharge of \$500/shipment. (local times).
5. For all deliveries - whether to the Customer location or drop shipment - any circumstances that result in the delay of our carrier (including unsuitable receiving facilities, or facilities not open or available), service charges will be applied at the rate of \$125/hour. Where re-delivery is necessary because of these circumstances, the full cost of re-delivery will be charged. If Less Than Truck Load is delivering, one hour is allocated to unload. Any additional time required to unload after the first hour is \$125/hour. If a Truck Load is delivering the order, three hours is allocated to unload. Any additional time required to unload is \$125/hour. Direct deliveries to site for large orders are possible, (must exceed \$60,000 net), and accommodate 48 - 53' trailers. Krug is responsible for delivery to the approved delivery address. If an address change is required, this must be authorized by Krug 5 business days prior to ship date. Any additional delivery costs incurred after this time will be charged to the customer.

Product Strength and Durability Testing

All Krug Conference products meet or exceed the testing requirements of ANSI/BIFMA X5.5-2014 or X5.9-2012.



Damaged Shipments

All Krug product is well engineered, carefully inspected, and expertly loaded onto our trucks at our Distribution Center. If you receive any damaged freight, we ask that you do not refuse the shipment. Krug is not responsible for damage to goods that occurs in transit or storage. It is the purchaser and/or receiver's responsibility to examine the goods upon receipt and to notify Krug of any damages, overages or shortages. Any discrepancies should be noted on the Bill of Lading. The delivering carrier will not accept responsibility for shortages or damages if signed "clear". Notification of concealed damage claims must be made to Krug Distribution within 5 days of delivery, along with digital pictures if available. All product and packaging must be available for inspection. Krug liability ceases after 5 business days and Krug will not be responsible for concealed damages if shipments are left unopened. Krug is not responsible for the condition of product that is stored or installed in an environment where temperature and humidity are not controlled.

Field Product Report Authorization

Krug's written authorization, in the form of an FPR number, must be obtained prior to incurring charges of any kind if Krug is expected to pay these charges. This includes authorization for returns, field repairs and replacements, post field repairs, installation and delivery charges. Krug reserves the right to have its representative inspect product related to any request for such authorizations, prior to that authorization being provided. Deductions from invoices paid for any charges to Krug, without prior written authorization in the form of an FPR, will not be accepted. Digital photographs may be required to complete the FPR process.

Care and Maintenance

Wood Finishes - Although Krug's extensive finishing process ensures a durable finish on all our products, there are several steps that can be taken to protect and prolong the life and beauty of the finish. Protect the top by placing felt pads on the bottom of any accessories and mechanical equipment. Rubber and oil will permanently mark surfaces. Use a desk pad to prevent possible damage and imprinting caused by writing instruments and sharp objects. Dust only with a clean, dry cloth, going with the grain. Clean any marks with a damp cloth, using a small quantity of mild soap or detergent. Do not use any wax-based polish, spray or silicone. Eventually, a film will build up and discolor the top. Do not place your furniture in a position of permanent exposure to direct sunlight.

Plastic Laminates - Clean plastic laminates with mild soap and warm water. Do not use steel wool, hot water, or any abrasive cleaning product.

Krug Panel Fabric Program

Tackboards can be upholstered in COM material supplied by the customer, and in a selection of stocked tackboard fabrics supplied by Momentum. The Momentum Panel fabrics are available on Krug Express. They are 100% polyester. For additional information and color selections, please refer to our Panel Fabrics card and Krug's website. www.krug.ca PRODUCTS / FABRICS / PANEL
The Momentum panel fabrics pass ASTM-E84-87 Fire Codes.
If memo samples are required please call Momentum at 1-800-366-6839.



PROGRAM DETAILS

KrugExpress orders are ready to ship by the date acknowledged. Delivery and shipping schedules may result in actual shipping of orders at a later date. Statutory holidays and scheduled factory vacations may add to acknowledged lead times of *KrugExpress* orders. Unless otherwise specified on the order, the customer's standard method of shipping Krug products will be utilized.

Available factory capacity for *KrugExpress* is filled by orders received on a "first come, first serve" basis. If the normal *KrugExpress* lead time is not available for your order because available capacity has been filled, you will be immediately advised of the earliest available ready-to-ship date. Please consult your Customer Service representative in advance if you wish to confirm the specific lead time availability for a *KrugExpress* order.

Orders must be received by midnight of a given day for that day to be considered the official day the order is received. Order lead times are acknowledged from the date the order is received, but not including the date the order is received.

KrugExpress orders must be "clean" when received in order to be considered officially received on a given day, and lead times will be acknowledged from the date orders are determined to be "clean".

Changes to *KrugExpress* orders are not allowed under any circumstances. Orders for product on *KrugExpress* must clearly state: "*KrugExpress*".

WOOD FINISHES AND LAMINATES

Standard Wood Finishes:

(See product pages for individual species availability)

SPECIES	FINISH
Cherry	Light Cherry
	Natural Cherry
	American Cherry
	Medium Cherry
	Standard Cherry
	Imperial Cherry
	Appalachian Cherry
	Sable Cherry
Maple	Clear Maple
	Honey Maple
	Wheat Maple
Oak	Light Oak
	SilverGrey on Oak
	Harvest Oak
	Mahogany Oak
	Medium Cherry on Oak
	Mellow Oak
	Walnut on Oak
Espresso on Oak	
Walnut	Natural Walnut
	Regular Walnut
	Mahogany on Walnut
	Dark Walnut
	Cordovan Walnut
SilverGrey on Walnut	
Anigre	Clear Anigre
	Medium Anigre
Palette	Black
	White
	Sand
	Soft Green
	Steel Blue
	Slate

NATURAL CHARACTERISTICS OF WOOD

Wood is a natural product with inherent color variations that will never be fully mitigated by the finishing process. Please anticipate variation in colors within a single unit, from piece to piece, and from Krug wood finish samples. If a very close match is required, a sample must be provided with the order and an upcharge will apply. Exact color matches are not possible.

CUSTOM WOOD FINISHES

Add 10% list to your order for special finishes, minimum upcharge is \$600 list per finish per order. (For example, on all orders up to \$6000 list, an upcharge of \$600 will apply, on orders \$6000 and up add 10% list to your order.) For orders with special finishes, a sample that is a minimum 3" by 3" must be received with the order. Special finishes may add additional lead time to production schedules. Since wood is a natural product, some variations in grain, color and stain acceptance will occur. In our finishing processes, we try to minimize variations, but some variation between samples and finished goods should be anticipated.

FINISH

Conference products feature Krug's finish, a proprietary catalyzed varnish formulation, that has repeatedly shown through independent laboratory testing to be the industry leader in durability and abrasion resistance. The Krug finish looks better longer than competitors and is uniquely suited to the demands of high traffic environments.

WOOD FINISHES TO MATCH STANDARD LAMINATES

Willow on Rift Oak
 Dune on Rift Oak
 Portobello on Rift Oak
 Ash on Rift Oak
 Copper on Cherry
 Shiraz Cherry
 Park Avenue Walnut
 Chocolate on Walnut
 Nutmeg on Walnut
 Dark Walnut
 Hardrock Maple

LAMINATES

Krug's in-stock Laminates are available in 17 different laminate selections. Please note that 4 of the colors (Gingerbread, Portobello, Ash and Willow) have textured finishes and may not be appropriate for use in patient areas due to infection control concerns. Minimum order quantities and extended lead times may apply for exotic laminate colors, please check with customer service. Polymer Edge will be selected to match the worksurface. Krug's previous laminate in-stock program will be phased out as in-stock supply depletes. Please contact customer service for availability.

IN-STOCK LAMINATES

Wood Grain Laminates	High Pressure Laminate Supplier	Textured Wood Grain Laminates	High Pressure Laminate Supplier
Champagne	Tafisa T492CR	Gingerbread	Tafisa T556UR
Hardrock Maple	Formica 86992-58	Portobello	Tafisa T557UR
Dune	Tafisa T491CR	Ash	Tafisa T535AT
Copper	Tafisa T521CR	Willow	Tafisa T543AT
Shiraz Cherry	Tafisa T472CR	Solid Laminates	
Park Avenue Walnut	Wilsonart 7984-38	Designer White	Wilsonart D354-60
Chocolate	Tafisa T498CR	Platinum	Tafisa T202CR
Nutmeg	Tafisa T477CR	Earth	Tafisa T767CR
Dark Walnut	Tafisa T469CR	Charcoal	Tafisa T228CR

PHASE OUT LAMINATES Almond - Black- Shadows - Edgewood Sycamore - Gunstock Walnut

NON-STOCKED LAMINATES

For specific lead time and application questions, please contact Krug Customer Service for your requirement. Upcharges will be applicable for non-stocked laminates, depending on their cost. Non-stock laminates may require a minimum order quantity, please contact customer service. Stocked polymer edges only can be specified for use with non-stocked laminates or tops will be self-edged.

SOLID SURFACE

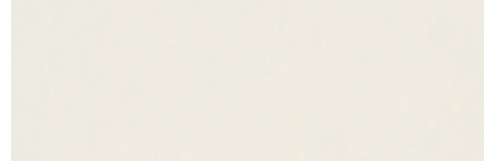
SOLID SURFACE

The Solid Surface option provides an enhanced durability, protection and cleanability. It is available in 8 standard colors and is replaceable if it becomes damaged or degraded. See individual products for list upcharge chart.

GROUP GRADE A - WHITE

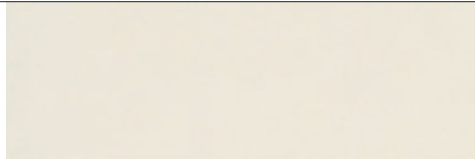


Glacier White



Cameo White

GROUP GRADE A - COLOR

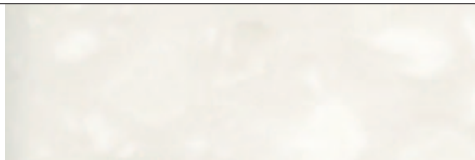


Bisque

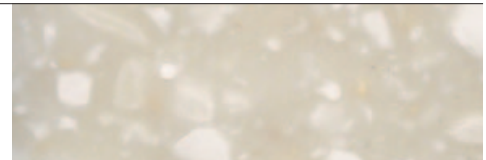


Linen

GROUP GRADE B



Antarctica

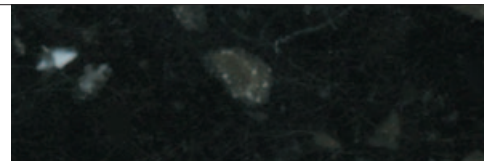


Savannah

GROUP GRADE C



Dove



Deep Night Sky



FSC
www.fsc.org
FSC® C021699

The mark of responsible forestry



All products are air emissions certified and are available as FSC® certified

krug

solutions@krug.ca | www.krug.ca | 1.888.578.KRUG