

HEALTHCARE
Price and Specification Guide
CANADA



TABLE OF CONTENTS

PRICING & SPECIFICATIONS

2 Guest & Multi-Purpose Seating

- 3 Mobi
- 7 Karma
- 18 Cressida
- 23 Solis
- 30 Faeron Wood
- 36 Faeron Metal
- 42 Jordan
- 50 Corfu

56 Patient Seating

- 57 Cressida
- 60 Solis
- 65 Faeron Wood
- 69 Faeron Metal
- 73 Jordan

79 Multiple Seating

- 80 Cressida
- 96 Solis
- 114 Faeron Wood
- 128 Faeron Metal
- 143 Jordan

159 Easy Access and Stools

- 160 Karma
- 163 Solis
- 165 Faeron Wood
- 168 Faeron Metal
- 171 Jordan
- 174 Corfu

180 Lounge Seating

- 181 Cressida
- 191 Leyton
- 206 Zola
- 223 Zola Privacy
- 289 Faeron
- 314 Jordan
- 320 Carlyle

322 Benches

- 323 Tate
- 329 Zola
- 339 Jordan
- 342 Carlyle

344 Recliners

- 345 Ascend
- 353 Jordan Active Patient Recliner
- 359 Jordan 3 Position Recliner
- 368 Jordan Recliner Plus
- 373 Jordan Sleep Recliner

379 Gliders

- 380 Jordan

384 Sleepers

- 385 Amelio Sofa Sleeper & Modular Sofa
- 400 Amelio Bench Sleeper
- 407 Jordan Lounge Sleeper

419 Behavioral Health

- 420 Solis
- 436 Faeron
- 472 Zola
- 479 Leyton
- 489 Tate
- 493 Karma
- 497 Chit Chat
- 504 Juno

523 Occasional Tables

- 524 Karma
- 529 Cressida
- 535 Leyton
- 537 Faeron Wood
- 541 Faeron Metal
- 544 Zola
- 549 Jordan
- 552 Solis

556 Infusion Bays

- 557 Tranquility

574 Casegoods

- 575 Juno
- 599 Trevisa

622 General Information

- 622 Terms & Conditions
- 622 Warranty
- 624 Krug Textiles - Upholstery Fabrics
- 627 Krug Textiles - Leather
- 627 Krug Textiles - Luxe Faux Leather
- 628 Customer's Own Material - C.O.M.
- 629 Graded-In Upholstery Programs
- 549 *KrugExpress* Program
- 630 Wood Finishes
- 631 Laminate Program
- 631 Solid Surface Program
- 632 Base Styles

GUEST & MULTI-PURPOSE SEATING

3	Mobi
7	Karma
18	Cressida
23	Solis
30	Faeron
42	Jordan
50	Corfu

MOBI | ENVIRONMENTAL SUMMARY

LEED CI CREDITS



MATERIAL CONTENT:

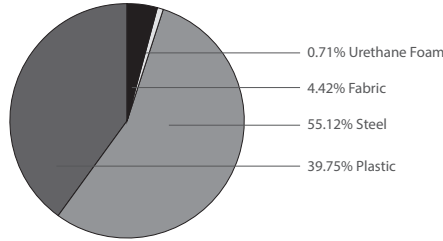

PRE-CONSUMER RECYCLED CONTENT = 13.78%

POST-CONSUMER RECYCLED CONTENT = 14.33%

Up to 55.11% of this Mobi product is recyclable at the end of its useful life.

CONTRIBUTES TO

CREDIT 2.1 - 2.2	Construction Waste Management	1-2 point(s)
CREDIT 3.3	Resource Reuse	1 point
CREDIT 4.1	Recycled Content	1 point
CREDIT 4.2	Recycled Content	1 point
CREDIT 4.5	Low Emitting Materials, Systems & Seating	1 point
CREDIT 5.1	Regional Materials*	1 point

*This credit is only applicable if in total 20% of the combined value of the procurement of construction materials and in the furniture are manufactured within a radius of 500 miles. This credit will apply if the installation of the finished product occurs within 500 miles of Kitchener, Ontario.

level® CERTIFICATION & AIR EMISSIONS



level® CERTIFICATION

BIFMA's e3 Furniture Sustainability Standard is a voluntary, multi-attribute standard that measures the degree of sustainability of furniture. This standard evaluates product and company environmental attributes and compliance systems in a wide range of elements which include Materials, Energy & Atmosphere, Human & Ecosystem Health and Social Responsibility. Mobi products have earned level®, BIFMA's sustainability certification program for furniture, certification through third-party verification against the e3 standard.



AIR EMISSIONS

All Mobi products are supplied with air emissions-certified materials. Contact customer service for specific test results.

MOBI | FEATURES, OPTIONS, DIMENSIONS & COM REQUIREMENTS



ARMS

Arms are available in the full range of polymer colors: Black, White, Grey, Taupe, Yellow, Red, Blue, Green. Please specify when ordering.



The Mobli caddie provides enhanced stackability, along with the ease of movement and storage. It has a durable tubular construction and 4 soft-wheel swivel, locking casters. Its design allows for the stacking and storage of all Krug stackable chairs.



ARMLESS



COMBINATION COLORS

More than one polymer color can be selected in any combination for seats, backs and arms. Please specify when ordering.



POLYMER SEATS & BACKS

Available Polymer colors: White, Grey, Taupe, Yellow, Red, Blue, Green and Black.

OPTIONS

REPLACEMENT AND REMOVABLE COMPONENTS

Mobli is designed to allow major components to be field replaced, providing a very cost effective means to significantly extend the life of the product. Mobli Chairs are available with Removable Seat and Removable Back Covers.



UPHOLSTERED SEATS & BACKS

Optional Removable covers can be quickly installed on Mobli products that were originally ordered with the removable cover option.

CAL 133 & MOISTURE BARRIER

California Technical Bulletin 133 is a flammability test for seating. Krug offers a compliance method which, in combination with non-flammable upholstery covers, may enable the products to meet certification requirements for this test. This process at the same time also provides the products with a Moisture Barrier - a treatment that helps to prevent the passage of liquids and moisture to inside of upholstered components - thereby conferring sanitary and anti-infection benefits. So when CAL 133 is specified, the product also automatically has a Moisture Barrier, and when a Moisture Barrier is specified, the product also features the compliance method and low flammability features of CAL 133.



MESH BACKS

Available mesh colors: Grey, Black & White. Please specify when ordering.

The application of this upcharge and the compliance method does not mean that the specific configuration of product and upholstery cover are tested and officially certified as being CAL 133 compliant. If official certification is required, Krug will provide this (through an independent certified testing laboratory) at a charge of \$917 per item, plus the cost of the product to be tested. Lead time for certification testing is typically 4-8 weeks. Krug assumes no responsibility for the testing of our products in combination with upholstery covers, or for the results of any testing conducted. Some specific configurations of product and upholstery have already been tested. Please contact Customer Service for additional information.



STACKABILITY

Mobli chairs are stackable to a maximum of 8 chairs high on the floor as well as caddie.



LEGS & GLIDES

Mobli legs are structural steel legs in Polished Chrome with non-marring glides.

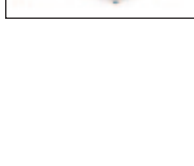

WEIGHT CAPACITY





Mobli has been tested and complies with ANSI/BIFMA x5.1-2011 standards. Mobli has been load tested up to 300lbs.

CADDIE

DIMENSIONS & COM REQUIREMENTS

	Overall Width	Overall Depth	Overall Height	Seat Height	Arms From Floor	Between Arms	Seat Depth	Shipping Weight	Cubes	COM YRD
MOB210P	18	21	31	17	n/a	n/a	18.75	21	14	-
MOB211P	21.25	21	31	17	27	20.5	18.75	21	14	-
MOB220P	18	21	31	17	n/a	n/a	18.75	21	14	.63
MOB221P	21.25	21	31	17	27	20.5	18.75	21	14	.63
MOB230P	18	21	31	17	n/a	n/a	18.75	21	14	.63
MOB231P	21.25	21	31	17	27	20.5	18.75	21	14	.63
MOB240P	18	21	31	17	n/a	n/a	18.75	21	14	-
MOB241P	21.25	21	31	17	27	20.5	18.75	21	14	-
MOB250P	18	21	31	17	n/a	n/a	18.75	21	14	1.22
MOB251P	21.25	21	31	17	27	20.5	18.75	21	14	1.22

MOBI

DESCRIPTION/MODEL	COM		COL	FABRIC GRADES			LEATHER		
	1	2	3	4	5	6	7	8	9
 Polymer Seat and Back, Armless MOB210P	383								
 Polymer Seat and Back, with Arms MOB211P	423								
 Polymer Back and Upholstered Seat, Armless MOB220P	505	529	552	598	646	694	740	789	885
 Polymer Back and Upholstered Seat, with Arms MOB221P	555	576	599	647	695	743	790	837	932
 Mesh Back and Upholstered Seat, Armless MOB230P	513	537	561	610	656	703	752	798	894







Mobi Option Upcharges

\$ List

CAL 133 & Moisture Barrier (per yard)	64
Removable Seat Covers	71
Removeable Back Covers	71

PRODUCT CODE KEY

Line	Series	Chair Style	Arm Style	Metal Finish
MOB Mobi	2 Multi-Purpose	1 Polymer Seat & Back	0 Armless	P Polished Chrome
		2 Polymer Back & Upholstered Seat	1 Armed	
		3 Mesh Back & Upholstered Seat		
		4 Mesh Back & Polymer Seat		
		5 Fully Upholstered Seat & Back		

DESCRIPTION/MODEL	COM		COL	FABRIC GRADES			LEATHER		
	1	2	3	4	5	6	7	8	9
 Mesh Back and Upholstered Seat, with Arms MOB231P	562	586	611	658	705	753	799	848	942
 Mesh Back and Polymer Seat, Armless MOB240P	392								
 Mesh Back and Polymer Seat, with Arms MOB241P	441								
 Fully Upholstered Seat and Back, Armless MOB250P	611	647	686	761	838	914	989	1065	1220
 Fully Upholstered Seat and Back, with Arms MOB251P	648	687	725	803	877	955	1031	1107	1257
 Caddie DOL6	838								

Mobi Option Upcharges

\$ List

CAL 133 & Moisture Barrier (per yard)	64
Removable Seat Covers	71
Removeable Back Covers	71

PRODUCT CODE KEY

Line	Series	Chair Style	Arm Style	Metal Finish
MOB Mobi	2 Multi-Purpose	1 Polymer Seat & Back	0 Armless	P Polished Chrome
		2 Polymer Back & Upholstered Seat	1 Armed	
		3 Mesh Back & Upholstered Seat		
		4 Mesh Back & Polymer Seat		
		5 Fully Upholstered Seat & Back		

KARMA | ENVIRONMENTAL SUMMARY

LEED CI CREDITS



MATERIAL CONTENT:

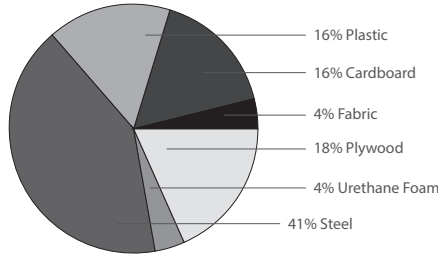

PRE-CONSUMER RECYCLED CONTENT = 5.51%

POST-CONSUMER RECYCLED CONTENT = 24.98%

Up to 73.47% of this Karma product is recyclable at the end of its useful life.

CONTRIBUTES TO

CREDIT 2.1 - 2.2	Construction Waste Management	1-2 point(s)
CREDIT 3.3	Resource Reuse	1 point
CREDIT 4.1	Recycled Content	1 point
CREDIT 4.2	Recycled Content	1 point
CREDIT 4.5	Low Emitting Materials, Systems & Seating	1 point
CREDIT 5.1	Regional Materials*	1 point
CREDIT 7	Certified Wood (MUST BE REQUESTED)	1 point(s)

*This credit is only applicable if in total 20% of the combined value of the procurement of construction materials and in the furniture are manufactured within a radius of 500 miles. This credit will apply if the installation of the finished product occurs within 500 miles of Kitchener, Ontario.

level® CERTIFICATION, AIR EMISSIONS AND FSC® CERTIFICATION



level® CERTIFICATION

BIFMA's e3 Furniture Sustainability Standard is a voluntary, multi-attribute standard that measures the degree of sustainability of furniture. This standard evaluates product and company environmental attributes and compliance systems in a wide range of elements which include Materials, Energy & Atmosphere, Human & Ecosystem Health and Social Responsibility. Karma products have earned level®, BIFMA's sustainability certification program for furniture, certification through third-party verification against the e3 standard.

AIR-EMISSIONS

All Karma products are supplied with air-emissions certified. Contact customer service for information.



FSC®

In 2005, Krug received Forest Stewardship Council® (FSC®) Chain-of-Custody certification for our manufacturing facilities. The FSC® Chain-of-Custody tracks certified wood from seedling to final sale. It verifies that the material for our FSC® certified products only come from well-managed, FSC®-certified forests and other controlled sources. FSC® is dedicated to the promotion of responsible forest management worldwide helping to take care of forests for future generations. Karma and other Krug products can be specified with FSC® Certification. Contact customer service for further information, pricing and lead times.



Architects, designers, and building professionals can specify FSC®-certified products in order to achieve a point from the U.S. Green Building Council's Leadership in Energy and Environmental Design (LEED) Rating System.



DESIGNED FOR COMFORT

The seat features an enhanced standard foam thickness, combined with our proprietary webbing suspension system, to provide superior comfort and a longer life cycle. The back is contoured and angled to provide supportive sitting.



WALL SAVER

The angle of the back and the rear legs are designed to keep the back away from the wall, to prevent wear and damage to both the chairs and to the walls of the facility.



STACKING

Karma stacks 7 high on the floor, and 12 chairs on the caddie. The optional Underseat Cover can be specified to help prevent indenting of seat upholstery on chairs that will be stacked. Karma chairs with the Sled Base option do not stack.



LIGHT GREY POLYMER BACK

Polypropylene backs are injection molded, with Light Grey pigment diffused throughout the mold, featuring a compound that provides UV resistance to fading and brittleness from exposure to light. Backs have a minimum wall thickness of 5 mm, providing excellent strength and shock resistance.



POLYMER ARM

Karma arms are durable, comfortable, and long lasting. They are made with injected polymer that is a solid color throughout the arm and are available in three color options: Black, Grey, Light Grey and Taupe.



STANDARD GLIDE

Karma's black domed polymer glides are non-adjustable, and field-replaceable if damaged or degraded. Ideal for carpeted flooring. For additional glide options, Floor-Saver and Non-Slip see page 9.



REPLACEABLE COMPONENTS

Karma is designed to allow major components to be field replaced, providing a very cost effective means to significantly extend the life of the product.



TANDEM SEATING

Karma chairs, and in-line tables, are designed to be instantly converted to (or ordered as) tandem seating. Armed and armless chairs can be connected - when joining arm chairs the positioning prevents a pinch point between the arms. In-line tables can be configured between chairs or as end tables. And the tandem components can be easily removed to convert to freestanding.



TABLES

Karma tables are Solid Beech & Maple edges with 1 7/8" Veneered tops. Tables are available in laminates with wood or laminates with Polymer edge. See page 631 for laminate information.



EASY ACCESS CHAIR

This chair, designed for hip surgery patients and other applications where a higher seated position is desired, has a removable footrest that is 8" in depth, with a non-slip tread. The footrest can be swung up and inward to facilitate cleaning and eliminate the trip hazard.

FRAME COLORS AVAILABLE

The Karma Leg is available in 2 standard finishes; Silver Metallic and Matte Black. Polished Chrome is also available for an upcharge.

WEIGHT CAPACITIES

Karma has been laboratory tested to meet a weight capacity of 500 lbs, in all versions: arm and armless, and all widths (including the Plus upgrade).

Karma Images | www.krug.ca

KARMA | OPTIONS



REMOVABLE COVERS & REPLACEMENT COMPONENTS

Optional Removeable seat and back covers are available on Karma. Replacement Removable covers are available for products that were originally ordered with the Removable cover option.



CASTERS OPTION

Karma features durable low profile 1 1/2" diameter casters in black nylon offering an impressive 500lb load rating. Caster models are available in Silver Metallic only. Karma chairs with the caster option do not stack.



FLOOR SAVER GLIDE

Karma's Floor Saver Glides are a larger, white, nylon glide incorporating a much larger surface area, and is a self-adjusting to help protect LVT, vinyl, tile, or hardwood where risk of marking might occur.



NON-SLIP GLIDE

Features a much larger surface area and is also self-adjusting. It also features a softer outer coating to hold and prevent chair from sliding on LVT, vinyl, or tile flooring. Perfect for more slippery/smooth floor areas where prevention of chair movement is required.



SLED BASE OPTION

Optional Sled Base frames are available in Silver Metallic and Matte Black. The integrated steel rail spans between the front and rear legs which are fitted with black nylon glides. Karma chairs with the Sled Base option do not stack.



POLYMER SHROUD

As an alternative to the standard dust cover under the seat, this option, in black polymer, closes off the underside of the chair, functioning as a cleanable Splashguard to protect the interior from moisture. It also assists in chair stacking, by distributing the weight to eliminate any indentations in the seat upholstery.



COMBINATION UPHOLSTERY COVERS

When combination upholstery is specified with fabric of the same grade or COM, an upcharge for dual fabrics is **\$33 list** per unit. When graded in combination upholstery is selected, use the highest grade upholstery selected or to obtain a quote for blended grading contact Customer Service (please provide the fabrics specified and location of where each fabric is to be applied on the product).

CAL 133 & MOISTURE BARRIER

California Technical Bulletin 133 is a flammability test for seating. Krug offers a compliance method which, in combination with non-flammable upholstery covers, may enable the products to meet certification requirements for this test. This process at the same time also provides the products with a Moisture Barrier - a treatment that helps to prevent the passage of liquids and moisture to inside of upholstered components - thereby conferring sanitary and anti-infection benefits. So when CAL 133 is specified, the product also automatically has a Moisture Barrier, and when a Moisture Barrier is specified, the product also features the compliance method and low flammability features of CAL 133.

The application of this upcharge and the compliance method does not mean that the specific configuration of product and upholstery cover are tested and officially certified as being CAL 133 compliant. If official certification is required, Krug will provide this (through an independent certified testing laboratory) at a charge of \$917 per item, plus the cost of the product to be tested. Lead time for certification testing is typically 4-8 weeks. Krug assumes no responsibility for the testing of our products in combination with upholstery covers, or for the results of any testing conducted. Some specific configurations of product and upholstery have already been tested. Please contact Customer Service for additional information.







KARMA | DIMENSIONS & COM REQUIREMENTS

	Overall Width	Overall Depth	Overall Height	Seat Height	Arms From Floor	Between Arms	Seat Depth	Shipping Weight/box			COM YRD	Cubes
								1 Chair	2 Chairs	3 Chairs		
Leg Base Stacking Chair Upholstered												
Armless												
KAR2C-18.5	20.2	21.9	33.9	18	n/a	n/a	17	22.5	41	59.5	1	18
KAR2C-22	23.7	21.9	33.9	18	n/a	n/a	17	24	44	64	1	18
KAR2C-26	27.7	21.9	33.9	18	n/a	n/a	17	25.5	47	68.5	1.7	21
With Arms												
KAR2C-18.5	24.5	21.9	33.9	18	26.8	18.5	17	24	44	64	1	18
KAR2C-22	28	21.9	33.9	18	26.8	22	17	25.5	47	68.5	1	18
KAR2C-26	32	21.9	33.9	18	26.8	26	17	27	50	73	1.7	21
Leg Base Stacking Chair Wood Back												
Armless												
KAR2C-18.5	20.2	21.9	33.9	18	n/a	n/a	17	22.5	41	59.5	0.7	18
KAR2C-22	23.7	21.9	33.9	18	n/a	n/a	17	24	44	64	0.7	18
KAR2C-26	27.7	21.9	33.9	18	n/a	n/a	17	25.5	47	68.5	0.7	21
With Arms												
KAR2C-18.5	24.5	21.9	33.9	18	26.8	18.5	17	24	44	64	0.7	18
KAR2C-22	28	21.9	33.9	18	26.8	22	17	25.5	47	68.5	0.7	18
KAR2C-26	32	21.9	33.9	18	26.8	26	17	27	50	73	0.7	21
Leg Base Stacking Chair Polymer Back												
Armless												
KAR2C-18.5	20.2	21.9	33.9	18	n/a	n/a	17	22.5	41	59.5	n/a	18
With Arms												
KAR2C-18.5	24.5	21.9	33.9	18	26.8	18.5	17	24	44	64	n/a	18
Caster Base Chair Upholstered - With Arms												
KAR2C-18.5	24.5	21.9	33.9	18	26.8	18.5	17	24	44	64	1	18
KAR2C-22	28	21.9	33.9	18	26.8	22	17	25.5	47	68.5	1	18
Caster Base Chair Wood Back - With Arms												
KAR2C-18.5	24.5	21.9	33.9	18	26.8	18.5	17	24	44	64	0.7	18
KAR2C-22	28	21.9	33.9	18	26.8	22	17	25.5	47	68.5	0.7	18
Caster Base Chair Polymer Back - With Arms												
KAR2C-18.5	24.5	21.9	33.9	18	26.8	18.5	17	24	44	64	0.7	18
Sled Base Chair Upholstered												
Armless												
KAR2C-18.5	20.2	21.9	33.9	18	n/a	n/a	17	25.5	-	-	1	18
KAR2C-22	23.7	21.9	33.9	18	n/a	n/a	17	27	-	-	1	18
KAR2C-26	27.7	21.9	33.9	18	n/a	n/a	17	28.5	-	-	1.7	21
With Arms												
KAR2C-18.5	24.5	21.9	33.9	18	26.8	18.5	17	27	-	-	1	18
KAR2C-22	28	21.9	33.9	18	26.8	22	17	28.5	-	-	1	18
KAR2C-26	32	21.9	33.9	18	26.8	26	17	30	-	-	1.7	21
Sled Base Chair Wood Back												
Armless												
KAR2C-18.5	20.2	21.9	33.9	18	n/a	n/a	17	25.5	-	-	0.7	18
KAR2C-22	23.7	21.9	33.9	18	n/a	n/a	17	27	-	-	0.7	18
KAR2C-26	27.7	21.9	33.9	18	n/a	n/a	17	28.5	-	-	0.7	21
With Arms												
KAR2C-18.5	24.5	21.9	33.9	18	26.8	18.5	17	27	-	-	0.7	18
KAR2C-22	28	21.9	33.9	18	26.8	22	17	28.5	-	-	0.7	18
KAR2C-26	32	21.9	33.9	18	26.8	26	17	30	-	-	0.7	21
Sled Base Chair Polymer Back												
Armless												
KAR2C-18.5	20.2	21.9	33.9	18	n/a	n/a	17	25.5	-	-	0.7	18
With Arms												
KAR2C-18.5	24.5	21.9	33.9	18	26.8	18.5	17	27	-	-	0.7	18
Yardage for Individual Components												
			Back	Seat								
			Fabric 18.5"	0.50	0.75							
			Fabric 22"	0.50	0.75							
			Fabric 26"	1.00	0.75							

DIMENSIONS:

All dimensions are in inches and approximate and are subject to change without notice. Contact Customer Service if dimensions are critical.

KARMA | LEG BASE

DESCRIPTION/MODEL	COM		COL			FABRIC GRADES			LEATHER	
	1	2	3	4	5	6	7	8	9	
 18.5" Leg Base, Matte Black or Silver Metallic - Upholstered Seat & Polymer Back, No Arm with Standard Dust Cover KAR2-18.5L_PNAD	424	450	475	509	552	585	625	676	727	
18.5" Leg Base, Polished Chrome - Upholstered Seat & Polymer Back, No Arm with Standard Dust Cover KAR2-18.5LCPNAD	529	555	580	613	656	690	730	780	829	
 18.5" Leg Base, Matte Black or Silver Metallic - Fully Upholstered, No Arm with Standard Dust Cover KAR2-18.5L_UNAD	458	486	511	543	586	621	661	711	763	
18.5" Leg Base, Polished Chrome - Fully Upholstered, No Arm, and Standard Dust Cover KAR2-18.5LCUNAD	564	590	615	648	691	725	765	815	866	
 18.5" Leg Base, Matte Black or Silver Metallic - Upholstered Seat & Wood Back, No Arm with Standard Dust Cover KAR2-18.5L_WNAD	491	508	516	536	557	571	595	620	645	
18.5" Leg Base, Polished Chrome - Upholstered Seat & Wood Back, No Arm with Standard Dust Cover KAR2-18.5LCWNAD	596	611	621	641	661	677	699	725	751	
 18.5" Leg Base, Matte Black or Silver Metallic - Upholstered Seat & Polymer Back, with Arm and Standard Dust Cover KAR2-18.5L_PA_D	457	483	510	547	585	620	662	711	762	
18.5" Leg Base, Polished Chrome - Upholstered Seat & Polymer Back, with Arm and Standard Dust Cover KAR2-18.5LC PA_D	562	588	617	651	690	724	767	816	868	
 18.5" Leg Base, Matte Black or Silver Metallic - Fully Upholstered, with Arm and Standard Dust Cover KAR2-18.5L_UA_D	494	518	544	583	621	656	697	747	798	
18.5" Leg Base, Polished Chrome - Fully Upholstered, with Arm and Standard Dust Cover KAR2-18.5LCUA_D	599	624	652	687	725	761	804	852	904	
 18.5" Leg Base, Matte Black or Silver Metallic - Upholstered Seat & Wood Back, with Arm and Standard Dust Cover KAR2-18.5L_WA_D	517	533	543	562	584	599	621	647	673	
18.5" Leg Base, Polished Chrome - Upholstered Seat & Wood Back, with Arm and Standard Dust Cover KAR2-18.5LC WA_D	622	637	648	667	688	705	705	725	751	







ORDERING NOTES: When selecting Frame Color and Arm Style please see Product Code Key below.

Karma Option Upcharges	\$ List	\$ List
CAL 133 & Moisture Barrier (per yard)	64	Floor Saver Glide (per chair)
Removable Seat Cover (per seat)	71	Non-Slip Glide (per chair)
Removable Back Cover (per back)	71	Combination Upholstery - dual fabrics
Polymer Underseat Shroud 18.5"	47	

PRODUCT CODE KEY

Line	Series	Frame Size	Frame Color	Style	Arm Style	Underseat Shroud
KAR	2	18.5L	B	U	NA	S
Karma	Stacking Chair	18.5" Leg Base	Matte Black	Fully Upholstered	No Arm	Polymer Shroud
			S	W	AB	D
			Silver Metallic	Beech Wood Back	Black	Standard Dust Cover
			C	P	AG	
			Polished Chrome	Polymer Back	Grey	
					ALG	
					Light Grey	
					AT	
					Taupe	

KARMA | LEG BASE

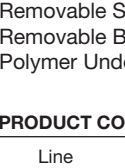
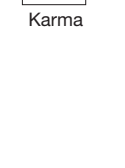
DESCRIPTION/MODEL	COM		COL		FABRIC GRADES			LEATHER	
	1	2	3	4	5	6	7	8	9
	22" Leg Base, Matte Black or Silver Metallic - Fully Upholstered, No Arm with Standard Dust Cover								
	KAR2-22L_UNAD	497	521	547	585	622	659	699	751
	22" Leg Base, Polished Chrome - Fully Upholstered, No Arm, and Standard Dust Cover								
	KAR2-22LCUNAD	626	651	676	711	751	785	829	878
	22" Leg Base, Matte Black or Silver Metallic - Upholstered Seat & Wood Back, No Arm with Standard Dust Cover								
	KAR2-22L_WNAD	537	547	562	582	599	619	640	664
	22" Leg Base, Polished Chrome - Upholstered Seat & Wood Back, No Arm with Standard Dust Cover								
	KAR2-22LCWNAD	665	676	691	707	729	746	766	791
	22" Leg Base, Matte Black or Silver Metallic - Fully Upholstered, with Arm and Standard Dust Cover								
	KAR2-22L_UA_D	535	560	585	620	661	695	735	784
	22" Leg Base, Polished Chrome - Fully Upholstered, with Arm and Standard Dust Cover								
	KAR2-22LCUA_D	662	688	711	747	786	822	864	913
	22" Leg Base, Matte Black or Silver Metallic- Upholstered Seat & Wood Back, with Arm and Standard Dust Cover								
	KAR2-22L_WA_D	564	576	590	606	627	645	666	691
	22" Leg Base, Polished Chrome - Upholstered Seat & Wood Back, with Arm and Standard Dust Cover								
	KAR2-22LCWA_D	693	703	717	735	756	774	794	819





ORDERING NOTES: When selecting Frame Color and Arm Style please see Product Code Key below.

Karma Option Upcharges	\$ List		\$ List
CAL 133 & Moisture Barrier (per yard)	64	Floor Saver Glide (per chair)	37
Removable Seat Cover (per seat)	71	Non-Slip Glide (per chair)	37
Removable Back Cover (per back)	71	Combination Upholstery - dual fabrics	33
Polymer Underseat Shroud 22"	63		

PRODUCT CODE KEY

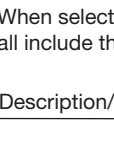
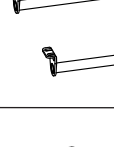
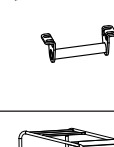
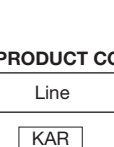

Line	Series	Frame Size	Frame Color	Style	Arm Style	Underseat Shroud
KAR	2C	22L	B	U	NA	S
Karma	Stacking Chair	22" Leg Base	Matte Black	Fully Upholstered	No Arm	Polymer Shroud
			S	W	AB	D
			Silver Metallic	Beech Wood Back	Black	Standard Dust Cover
			C		AG	
			Polished Chrome		Grey	
					ALG	
					Light Grey	
					AT	
					Taupe	

KARMA | LEG BASE

DESCRIPTION/MODEL	COM		COL	FABRIC GRADES			LEATHER			
	1	2	3	4	5	6	7	8	9	
	26" Leg Base, Matte Black or Silver Metallic - Fully Upholstered, Armless with Standard Dust Cover									
	KAR2-26L_UNAD	597	645	695	763	840	908	984	1083	1178
	26" Leg Base, Polished Chrome - Fully Upholstered, Armless, with Standard Dust Cover									
	KAR2-26LCUNAD	727	777	823	892	968	1036	1114	1210	1307
	26" Leg Base, Matte Black or Silver Metallic - Upholstered Seat & Wood Back, Armless, with Standard Dust Cover									
	KAR2-26L_WNAD	617	640	661	694	730	763	798	843	888
	26" Leg Base, Polished Chrome - Upholstered Seat & Wood Back, Armless, with Standard Dust Cover									
	KAR2-26LCWNAD	744	767	789	822	857	890	928	973	1017
	26" Leg Base, Matte Black or Silver Metallic - Fully Upholstered, with Arm and Standard Dust Cover									
	KAR2-26L_UA_D	633	680	730	798	875	942	1019	1118	1215
	26" Leg Base, Polished Chrome - Fully Upholstered, with Arm and Standard Dust Cover									
	KAR2-26LCUA_D	763	810	857	928	1004	1071	1149	1245	1345
	26" Leg Base, Matte Black or Silver Metallic - Upholstered Seat & Wood Back, with Arm and Standard Dust Cover									
	KAR2-26L_WA_D	643	666	688	721	756	786	824	870	914
	26" Leg Base, Polished Chrome - Upholstered Seat & Wood Back, with Arm and Standard Dust Cover									
	KAR2-26LCWA_D	771	795	816	849	885	916	955	999	1043

ORDERING NOTES:

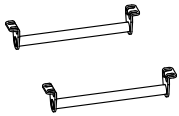



When selecting Frame Color and Arm Style please see Product Code Key below. See following page for additional options. Karma chairs all include the Standard Dust Cover ("D"), for optional Polymer Shroud change "D" to "S" and add **\$74 list**.

Description/Model	Price	
	Tandem Seating Bracket -Matte Black (for armed chair) KAR2C-GB BA	80
	Tandem Seating Bracket- Silver Metallic (for armed chair) KAR2C-GB BSA	80
	Tandem Seating Bracket- Polished Chrome (for armed chair) KAR2C-GB BCA	91
	Tandem Seating Bracket-Matte Black (for chairs without arms) KAR2C-GB BNA	71
	Tandem Seating Bracket- Silver Metallic (for chairs without arms) KAR2C-GB BSNA	71
	Tandem Seating Bracket- Polished Chrome (for chairs without arms) KAR2C-GB BCNA	81
	Caddie DOL6	840

PRODUCT CODE KEY

Line	Series	Frame Size	Frame Color	Style	Arm Style	Underseat Shroud
KAR	2	26L	B	U	NA	S
Karma	Stacking Chair	26" Leg Base	Matte Black	Fully Upholstered	No Arm	Polymer Shroud
			S	W	AB	D
			Silver Metallic	Beech Wood Back	Black	Standard Dust Cover
			C		AG	
			Polished Chrome		Grey	
					ALG	
					Light Grey	
					AT	
					Taupe	

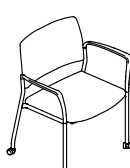
KARMA | CASTER BASE

DESCRIPTION/MODEL	COM		COL		FABRIC GRADES			LEATHER	
	1	2	3	4	5	6	7	8	9
 18.5" Caster Base, Silver Metallic - Upholstered Seat & Polymer Back, with Arm and Standard Dust Cover KAR2-18.5MSPA_D	541	567	592	630	669	703	745	830	845
 18.5" Caster Base, Silver Metallic - Fully Upholstered, with Arm and Standard Dust Cover KAR2-18.5MSUA_D	577	602	628	665	705	739	781	830	882
 18.5" Caster Base, Silver Metallic - Upholstered Seat & Wood Back, with Arm and Standard Dust Cover KAR2-18.5MSWA_D	601	615	627	645	666	681	705	731	756
 22" Caster Base, Silver Metallic - Fully Upholstered, with Arm and Standard Dust Cover KAR2-22MSUA_D	617	643	667	703	743	779	819	868	917
 22" Caster Base, Silver Metallic - Upholstered Seat & Wood Back, with Arm and Standard Dust Cover KAR2-22MSWA_D	646	659	673	689	710	729	749	774	798



ORDERING NOTES: When selecting Arm Style please see Product Code Key below.
Karma chairs all include the Standard Dust Cover ("D"), for optional Polymer Shroud change "D" to "S" and add upcharge listed below.

Karma Option Upcharges	\$ List
CAL 133 & Moisture Barrier (per yard)	64
Removable Seat Covers	71
Removable Back Covers	71
Polymer Underseat Shroud 18.5"	47
Polymer Underseat Shroud 22"	63
Combination Upholstery - dual fabrics	33

PRODUCT CODE KEY

Line	Series	Frame Size	Frame Color	Style	Arm Style	Underseat Shroud
KAR	2	18.5M	S	U	AB	S
Karma	Chair	18.5" Caster Base	Silver Metallic	Fully Upholstered	Black	Polymer Shroud
		22M		W	AG	D
		22" Caster Base		Beech Wood Back	Grey	Standard Dust Cover
				P	ALG	
				Polymer Back	Light Grey	
					AT	
					Taupe	

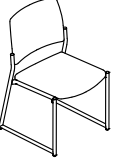
KARMA | SLED BASE

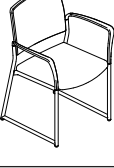
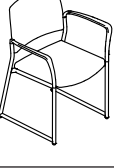
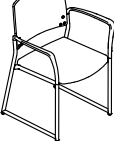
DESCRIPTION/MODEL	COM		COL		FABRIC GRADES			LEATHER	
	1	2	3	4	5	6	7	8	9
 18.5" Sled Base, Matte Black or Silver Metallic - Upholstered Seat & Polymer Back, No Arm with Standrad Dust Cover KAR2-18.5S_PNAD	529	555	580	613	656	690	730	781	832
 18.5" Sled Base, Matte Black or Silver Metallic - Fully Upholstered, No Arm with Standrad Dust Cover KAR2-18.5S_UNAD	597	622	647	681	723	760	798	849	900
 18.5" Sled Base, Matte Black or Silver Metallic - Upholstered Seat & Wood Back, No Arm with Standrad Dust Cover KAR2-18.5S_WNAD	628	644	655	673	694	710	732	759	783
 18.5" Sled Base, Matte Black or Silver Metallic - Upholstered Seat & Polymer Back, with Arm and Standrad Dust Cover KAR2-18.5S_PA_D	564	589	615	652	690	725	766	816	867
 18.5" Sled Base, Matte Black or Silver Metallic - Fully Upholstered, with Arm and Standrad Dust Cover KAR2-18.5S_UA_D	633	658	685	720	760	794	835	886	935
 18.5" Sled Base, Matte Black or Silver Metallic - Upholstered Seat & Wood Back, with Arm and Standrad Dust Cover KAR2-18.5S_WA_D	656	670	681	701	721	738	760	785	810



ORDERING NOTES: When selecting Frame Color and Arm Style please see Product Code Key below.

Karma Option Upcharges	\$ List	\$ List
CAL 133 & Moisture Barrier (per yard)	64	Polymer Underseat Shroud 18.5" 47
Removable Seat Covers	71	Combination Upholstery - dual fabrics 33
Removable Back Covers	71	

PRODUCT CODE KEY

Line	Series	Frame Size	Frame Color	Style	Arm Style	Underseat Shroud
KAR	2	18.5S	B	U	NA	S
Karma	Chair	18.5" Sled Base	Matte Black	Fully Upholstered	No Arm	Polymer Shroud
			S	W	AB	D
			Silver Metallic	Beech Wood Back	Black	Standard Dust Cover
				P	AG	
				Polymer Back	Grey	
					ALG	
					Light Grey	
					AT	
					Taupe	

KARMA | SLED BASE

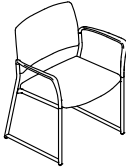
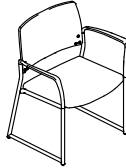
DESCRIPTION/MODEL	COM		COL	FABRIC GRADES			LEATHER		
	1	2	3	4	5	6	7	8	9
 22" Sled Base, Matte Black or Silver Metallic - Fully Upholstered, No Arm with Standrad Dust Cover KAR2-22S_UNAD	636	661	687	722	761	796	837	888	939
 22" Sled Base, Matte Black or Silver Metallic - Upholstered Seat & Wood Back, No Arm with Standrad Dust Cover KAR2-22S_WNAD	674	687	701	719	738	757	778	803	827
 22" Sled Base, Matte Black or Silver Metallic - Fully Upholstered, with Arm and Standrad Dust Cover KAR2-22S_UA_D	672	697	722	759	798	833	872	922	974
 22" Sled Base, Matte Black or Silver Metallic- Upholstered Seat & Wood Back, with Arm and Standrad Dust Cover KAR2-22S_WA_D	702	715	729	744	765	783	805	829	853

ORDERING NOTES: When selecting Frame Color and Arm Style please see Product Code Key below.

Karma Option Upcharges

\$ List

CAL 133 & Moisture Barrier (per yard)	64
Removable Seat Covers	71
Removable Back Covers	71
Polymer Underseat Shroud 22"	63
Combination Upholstery - dual fabrics	33

PRODUCT CODE KEY

Line	Series	Frame Size	Frame Color	Style	Arm Style	Underseat Shroud
KAR Karma	2 Chair	22S 22" Sled Base	B Matte Black	U Fully Upholstered	NA No Arm	S Polymer Shroud
			S Silver Metallic	W Beech Wood Back	AB Black	D Standard Dust Cover
					AG Grey	
					ALG Light Grey	
					AT Taupe	

KARMA | SLED BASE

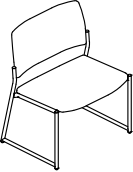
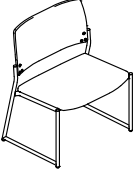
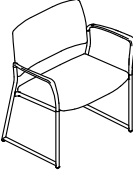
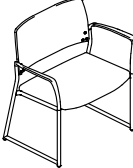
DESCRIPTION/MODEL	COM		COL	FABRIC GRADES			LEATHER		
	1	2	3	4	5	6	7	8	9
 26" Sled Base, Matte Black or Silver Metallic - Fully Upholstered, Armless with Standrad Dust Cover KAR2-26S_UNAD	735	783	833	900	978	1044	1121	1221	1315
 26" Sled Base, Matte Black or Silver Metallic - Upholstered Seat & Wood Back, Armless, with Standrad Dust Cover KAR2-26S_WNAD	754	778	798	832	868	900	935	981	1027
 26" Sled Base, Matte Black or Silver Metallic - Fully Upholstered, with Arm and Standrad Dust Cover KAR2-26S_UA_D	769	820	868	935	1014	1082	1158	1256	1354
 26" Sled Base, Matte Black or Silver Metallic- Upholstered Seat & Wood Back, with Arm and Standrad Dust Cover KAR2-26S_WA_D	781	805	826	859	894	927	961	1008	1053

ORDERING NOTES: When selecting Frame Color and Arm Style please see Product Code Key below.

Karma Option Upcharges

\$ List

CAL 133 & Moisture Barrier (per yard)	64
Removable Seat Covers	71
Removable Back Covers	71
Polymer Underseat Shroud 26"	80
Combination Upholstery - dual fabrics	33

PRODUCT CODE KEY

Line	Series	Frame Size	Frame Color	Style	Arm Style	Underseat Shroud
KAR	2	26S	B	U	NA	S
Karma	Chair	26" Sled Base	Matte Black	Fully Upholstered	No Arm	Polymer Shroud
			S	W	AB	D
			Silver Metallic	Beech Wood Back	Black	Standard Dust Cover
					AG	
					Grey	
					ALG	
					Light Grey	
					AT	
					Taupe	

LEED CI CREDITS



MATERIAL CONTENT:

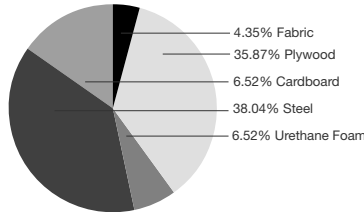

PRE-CONSUMER
RECYCLED CONTENT = 6.66%

POST-CONSUMER
RECYCLED CONTENT = 22.07%

Up to 53.26% of this Cressida product is recyclable at the end of its useful life.

	CONTRIBUTES TO	
CREDIT 2.1 - 2.2	Construction Waste Management	1-2 point(s)
CREDIT 3.3	Resource Reuse	1 point
CREDIT 4.1	Recycled Content	1 point
CREDIT 4.2	Recycled Content	1 point
CREDIT 4.5	Low Emitting Materials, Systems & Seating	1 point
CREDIT 5.1	Regional Materials*	1 point
CREDIT 7	Certified Wood (MUST BE REQUESTED)	1 point(s)

*This credit is only applicable if in total 20% of the combined value of the procurement of construction materials and in the furniture are manufactured within a radius of 500 miles. This credit will apply if the installation of the finished product occurs within 500 miles of Kitchener, Ontario.

level® CERTIFICATION, AIR EMISSIONS AND FSC® CERTIFICATION



level® CERTIFICATION

BIFMA's e3 Furniture Sustainability Standard is a voluntary, multi-attribute standard that measures the degree of sustainability of furniture. This standard evaluates product and company environmental attributes and compliance systems in a wide range of elements which include Materials, Energy & Atmosphere, Human & Ecosystem Health and Social Responsibility. Cressida products have earned level®, BIFMA's sustainability certification program for furniture, certification through third-party verification against the e3 standard.

AIR-EMISSIONS

All Cressida products are supplied with air-emissions certified. Contact customer service for information.



FSC®

In 2005, Krug received Forest Stewardship Council® (FSC®) Chain-of-Custody certification for our manufacturing facilities. The FSC® Chain-of-Custody tracks certified wood from seedling to final sale. It verifies that the material for our FSC® certified products only come from well-managed, FSC®-certified forests and other controlled sources. FSC® is dedicated to the promotion of responsible forest management worldwide helping to take care of forests for future generations. Cressida and other Krug products can be specified with FSC® Certification. Contact customer service for further information, pricing and lead times.



Architects, designers, and building professionals can specify FSC®-certified products in order to achieve a point from the U.S. Green Building Council's Leadership in Energy and Environmental Design (LEED) Rating System.

CRESSIDA | GUEST, PATIENT & MULTIPLE FEATURES & OPTIONS



CLEAN OUT

All Cressida seating models have a built-in clean out feature: a space at the back of the seat that allows dirt, debris and liquid to fall to the floor for easy clean up and maintenance - designed so that it does not detract from the comfort or appearance of the product.



POLYMER ARM CAP

The optional arm cap provides enhanced durability and protection for the arms. Arm cap is available in Grey or Black and is field replaceable if it becomes damaged or degraded.



WOOD ARM

Wood Arms are available in either beech or maple hardwood and in 22 Krug standard finishes.

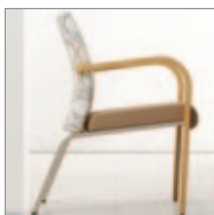

WALL SAVER

The angle of the back and the rear legs are designed to keep the back away from the wall, to prevent wear and damage to both the chairs and to the walls of the facility.



METAL BACK LEGS

Cressida's metal back legs are built from structural rectangular steel tubing for exceptional strength and appealing design. Silver Metallic is offered as Krug's standard finish, additional metal finish colors are available at an upcharge - please contact Customer Service for pricing and more information.



METAL TO METAL CONNECTIONS

Steel seat frames are joined to other components, and to each other in the multiple seating products, with hardened steel bolts and inserts, ensuring exceptional durability and strength, and easy reconfigurability, as well as on-site replacement of damaged or degraded components.

STEEL SEAT FRAME

Seats are constructed of high strength plywood with suspension webbing. The upholstered seat assembly is then further supported by steel frame construction running below the plywood

FINISH DURABILITY

The Krug finish, a proprietary catalyzed varnish formulation, has been repeatedly shown, through independent laboratory testing, to be the industry leader in durability and abrasion resistance. The Krug finish looks better longer than competitors, and is uniquely suited to the demands of healthcare environments.

PLUS UPGRADE

Cressida 30" and 44" models feature Plus Upgrade. Plus Seating has been engineered to support higher weight capacities, accommodating a wider variety of users.

LATEX FREE

Krug products are made with latex-free materials to prevent the allergic reaction that latex causes in some people.

WEIGHT CAPACITIES

Cressida weight capacities are as follows:
Guest & Patient Chairs (21" & 24") - 350 lbs
Plus Chairs (30" & 44") - 750 lbs
Multiple Seating & Pre-configured - 350 lbs per seat
2-Seat Freespan - 525 lbs per unit
3-Seat Freespan - 750 lbs per unit

REPLACEABLE COMPONENTS

Cressida chairs are uniquely designed to allow virtually all major components to be field replaced, providing a very cost effective means to significantly extend the life of the product. Seats, backs, frames are field replaceable.

CUSTOM CAPABILITIES

Modifications in dimension, seat and back shape or thickness, and other modifications are possible with Krug's capability to customize for specific requirements and needs. We can also provide custom finishes.

OPTIONS

CLEANABLE UNDER-SEAT SPLASHGUARD

All Cressida seating models are available with a plastic moisture barrier that covers and encloses the underside of the seat (while still allowing air transfer and ventilation in and out of the seat cushion). The Splashguard significantly enhances the germ resistance properties of the product, by enclosing the part of the chair that can be most susceptible to infection-causing pathogens. The Splashguard is a smooth, easy to clean surface, either while on the chair or when removed, and is also field replaceable.

METAL FINISH OPTIONS

Silver Metallic frames are available with an anti-microbial finish for an upcharge of **\$64 list** per arm frame pair or table. Additional Frame Finishes, which include anti-microbial finish, are available for an upcharge of **\$64 list** per per arm frame pair or table. Available colors are: White, Parchment, Sand, Taupe, Warm Grey, Cool Grey or Black. For all metal finishes other than Silver Metallic Standard, there is a minimum order quantity of 30 units per color. Upcharges for order quantities less than 30 units per color or custom metal finishes, please contact Customer Service to obtain a quote.

GANGING

All Cressida freestanding chairs can be ganged using a ganging bracket. The powder coated metal bracket is fastened to the inside face of each side frame.

ADJUSTABLE HEADREST

The adjustable headrest uses dual density foam providing excellent support and comfort. The headrest is securely fastened using an innovative clip allowing the headrest to be easily removed for cleaning and/or replacement. The headrest is easily adjusted by sliding the headrest vertically allowing the user to maximize their comfort.



CRESSIDA | GUEST, PATIENT & MULTIPLE OPTIONS

COMBINATION UPHOLSTERY OPTIONS

When combination upholstery is specified with fabric of the same grade or COM, an upcharge for dual fabrics is **\$33 list** per unit and **\$64 list** per unit for three fabrics will be applied. When graded in combination upholstery is selected, use the highest grade upholstery selected or to obtain a quote for blended grading contact Customer Service (please provide the fabrics specified and location of where each fabric is to be applied on the product).

MOISTURE BARRIER & CAL 133

California Technical Bulletin 133 is a flammability test for seating. Krug offers a compliance method, in combination with non-flammable upholstery covers, may enable products to meet certification requirements for this test. This process at the same time also provides the products with a Moisture Barrier - a treatment that helps to prevent the passage of liquids and moisture to inside of the upholstered components - thereby conferring sanitary and anti-infection benefits. So when CAL 133 is specified, the product also automatically has a Moisture Barrier, and when a Moisture Barrier is specified, the product also features the compliance method and low flammability features of CAL 133.

The application of this up-charge and the compliance method does not mean that the specific configuration of product and upholstery cover are tested and officially certified as being CAL133 compliant. If the official certification is required, Krug will provide this (through an independent certified testing laboratory) at a charge of \$917 per

item, plus the cost of the product to be tested. Lead time for certification testing is typically 4-8 weeks.

Krug assumes no responsibility for the testing of our products in combination with upholstery covers, or for the results of any testing conducted. Some specific configurations of products and upholstery have already been tested. Please contact Customer Service for additional information.

REPLACEMENT / REMOVABLE COVER OPTION

Replacement seat and back covers can be quickly installed on Cressida products that were originally ordered with the Removeable cover option. Replacement seat and back covers can also be installed on Cressida products that were not originally ordered with the Removeable cover option, with some simple staple removal on the original seats and backs.

CRESSIDA | GUEST

DIMENSIONS & COM REQUIREMENTS

	Overall Width	Overall Depth	Overall Height	Seat Height	Height of Arms from Floor	Width Between Arms	Seat Depth	Shipping Weight	Cube
21" Seat	24.5	28.5	33.75	18.5	26	21	18.75	42	14
24" Seat	27.5	28.5	33.75	18.5	26	24	18.75	46	19
30" Seat	33.5	28.5	33.75	18.5	26	30	18.75	57	20
44" Seat	47.5	28.5	33.75	18.5	26	44	18.75	69	28

COM - YARDAGE REQUIREMENTS





	COM Yardage Seat & Back	COM Yardage Seats Only	COM Yardage Back Only	COM Yardage Closed Arm Panel
21" - One Chair	1.4	0.8	0.7	.8
21" - Two Chairs	2.59	1.19	1.4	.8
21" - Three Chairs	4.08	2	2.08	.8
21" - Four Chairs	5.18	2.38	2.8	.8
24" - One Chair	1.75	0.8	1.4	.8
24" - Two Chairs	3.3	1.19	2.08	.8
24" - Three Chairs	5.05	2	3.48	.8
24" - Four Chairs	6.6	2.38	4.16	.8
30" - One Chair	2.5	1.1	1.4	.8
30" - Two Chairs	5	2.2	2.8	.8
30" - Three Chairs	7.5	3.3	4.2	.8
30" - Four Chairs	10	4.4	5.6	.8
44" - One Chair	2.5	1.1	1.4	.8
44" - Two Chairs	5	2.2	2.8	.8
44" - Three Chairs	7.5	3.3	4.2	.8
44" - Four Chairs	10	4.4	5.6	.8

Note: Some vinyls, leathers & upholsteries are not suitable for application on Cressida seating.

The approval process is as follows:

1. A sample of the COM must be provided to Krug Customer Service prior to or at the time of order.
2. The sample will be reviewed and the customer advised if the fabric is unsuitable.
3. The COM fabric or leather will be inspected when received at the factory, to identify any further concerns with its suitability.

CRESSIDA | GUEST

DESCRIPTION	MODEL	SPECIES	COM		COL	FABRIC GRADES			LEATHER		
			1	2	3	4	5	6	7	8	9
	21" Open Arm CRE2-G21OPS	Beech, Maple	1033	1086	1141	1244	1346	1439	1547	1657	1858
	21" Open Arm with arm cap CRE2-G21OPP		1058	1108	1165	1267	1369	1461	1568	1677	1881
	21" Closed Arm CRE2-G21CLS	Beech, Maple	1318	1412	1495	1633	1774	1905	2055	2214	2466
	21" Closed Arm with arm cap CRE2-G21CLP		1342	1434	1518	1657	1797	1926	2077	2237	2491
	24" Open Arm CRE2-G24OPS	Beech, Maple	1092	1141	1194	1294	1403	1504	1606	1714	1915
	24" Open Arm with arm cap CRE2-G24OPP		1116	1165	1215	1316	1423	1527	1629	1736	1938
	24" Closed Arm CRE2-G24CLS	Beech, Maple	1378	1467	1545	1683	1833	1968	2112	2271	2526
	24" Closed Arm with arm cap CRE2-G24CLP		1402	1492	1567	1703	1855	1991	2135	2294	2549



Cressida Option Upcharges

\$ List

Moisture Barrier (per yard)	64
Ganging Bracket	84
Removable Seat Cover	85
Guest Removeable 21" & 24" Back Covers	54
21" & 24" Cleanable Under-Seat Splashguard	59
Combination Upholstery - Dual Fabrics	33
Combination Upholstery - Three Fabrics	64

PRODUCT CODE KEY

Line	Series	Chair Style	Size	Arm Style
CRE Cressida	2 Chair	G Guest	21	OPS Open Arm
			24	OPP Open Arm Polymer Arm Cap
				CLS Closed Arm
				CLP Closed Arm Polymer Arm Cap

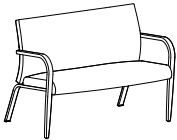
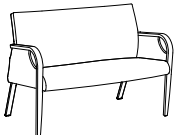
DESCRIPTION	MODEL	SPECIES	COM		COL	FABRIC GRADES			LEATHER		
			1	2	3	4	5	6	7	8	9
	30" Open Arm CRE2-G30OPS	Beech, Maple	1272	1311	1387	1534	1755	1915	2011	2170	2479
	30" Open Arm with arm cap CRE2-G30OPP		1295	1333	1411	1557	1778	1938	2033	2194	2502
	30" Closed Arm CRE2-G30CLS	Beech, Maple	1559	1678	1782	1970	2188	2382	2584	2800	3166
	30" Closed Arm with arm cap CRE2-G30CLP		1583	1703	1808	1993	2210	2405	2607	2822	3189
	44" Open Arm CRE2-G44OPS	Beech, Maple	1538	1619	1706	1863	2017	2185	2348	2507	2833
	44" Open Arm with arm cap CRE2-G44OPP		1562	1642	1729	1886	2039	2206	2373	2531	2857
	44" Closed Arm CRE2-G44CLS	Beech, Maple	1825	1946	2059	2254	2445	2649	2857	3067	3444
	44" Closed Arm with arm cap CRE2-G44CLP		1846	1967	2083	2278	2466	2671	2880	3090	3465

Cressida Option Upcharges

\$ List

Moisture Barrier (per yard)	64
Ganging Bracket	84
Removable Seat Cover	85
Guest Removeable 30" & 44" Back Covers	85
30" Cleanable Under-Seat Splashguard	67
44" Cleanable Under-Seat Splashguard	80
Combination Upholstery - Dual Fabrics	33
Combination Upholstery - Three Fabrics	64

PRODUCT CODE KEY

Line	Series	Chair Style	Size	Arm Style
CRE Cressida	2 Chair	G Guest	21	OPS Open Arm
			24	OPP Open Arm Polymer Arm Cap
			30	CLS Closed Arm
			44	CLP Closed Arm Polymer Arm Cap

SOLIS | ENVIRONMENTAL SUMMARY

LEED CI CREDITS



MATERIAL CONTENT:

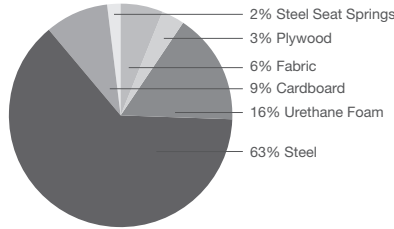

PRE-CONSUMER
RECYCLED CONTENT = 16%

POST-CONSUMER
RECYCLED CONTENT = 22%

CONTRIBUTES TO

CREDIT 2.1 - 2.2	Construction Waste Management	1-2 point(s)
CREDIT 3.3	Resource Reuse	1 point
CREDIT 4.1	Recycled Content	1 point
CREDIT 4.2	Recycled Content	1 point
CREDIT 4.5	Low Emitting Materials, (PLEASE ENQUIRE) Composite Wood & Laminate Adhesives	1 point
CREDIT 5.1	Regional Materials*	1 point
CREDIT 7	Certified Wood (PLEASE ENQUIRE)	1 point

* This credit is only applicable if in total 20% of the combined value of the procurement of construction materials and in the furniture are manufactured within a radius of 500 miles. This credit will apply if the installation of the finished product occurs within 500 miles of Toronto, Ontario.

The above information regarding LEED contribution applies to both the upholstered as well as mesh back versions.

level® CERTIFICATION, AIR EMISSIONS AND FSC® CERTIFICATION



level® CERTIFICATION

BIFMA's e3 Furniture Sustainability Standard is a voluntary, multi-attribute standard that measures the degree of sustainability of furniture. This standard evaluates product and company environmental attributes and compliance systems in a wide range of elements which include Materials, Energy & Atmosphere, Human & Ecosystem Health and Social Responsibility. Solis products have earned level®, BIFMA's sustainability certification program for furniture, certification through third-party verification against the e3 standard.

AIR-EMISSIONS

All Solis products are supplied with air-emissions certified. Contact customer service for information.



FSC®

In 2005, Krug received Forest Stewardship Council® (FSC®) Chain-of-Custody certification for our manufacturing facilities. The FSC® Chain-of-Custody tracks certified wood from seedling to final sale. It verifies that the material for our FSC® certified products only come from well-managed, FSC®-certified forests and other controlled sources. FSC® is dedicated to the promotion of responsible forest management worldwide helping to take care of forests for future generations. Solis and other Krug products can be specified with FSC® Certification. Contact customer service for further information, pricing and lead times.



Architects, designers, and building professionals can specify FSC®-certified products in order to achieve a point from the U.S. Green Building Council's Leadership in Energy and Environmental Design (LEED) Rating System.



CLEAN OUT

All Solis seating models have a built-in clean out feature: a space at the back of the seat that allows dirt, debris and liquids to fall to the floor for easy clean up and maintenance - designed so that it does not detract from the comfort or appearance of the product.



STEEL SEAT FRAME

The structural seat frame is made from welded steel with a powder-coated finish that allows Solis to well exceed ANSI/BIFMA standards. Rounded arms provide support for safe and easy ingress and egress.

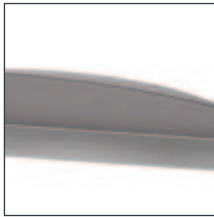

HIGH DENSITY FOAM

Solis features dual density foam that is soft on the outside for comfort, dense on the inside for high durability. The seat and back foam features a compound curvature that supports healthy sitting postures, while also designed to ease ingress and egress.



FLEX BACK

Solis sets a new standard for comfort and ergonomics in healthcare seating. The ergonomically-designed back has a slight flexing action, which significantly enhances comfort.



URETHANE ARM

Solis arms are durable, comfortable, and long lasting. Urethane arms are available in three color options; Black, Grey and Taupe.



WOODEN ARM

Wood arms are available in either beech or maple hardwood and in 22 Krug standard finishes. Maple arm caps are available for an up-charge of **\$77 list** per arm using beech pricing.

REPLACEABLE COMPONENTS

Solis chairs are uniquely designed to allow virtually all major components to be field replaced, providing a very cost effective means to significantly extend the life of the product. Seats, backs, arms, frames and casters are field replaceable. Pricing and model numbers can be viewed online at www.krug.ca.

TUBULAR STEEL CHAIR FRAME

The overall aesthetic frame of the chair is built from structural steel tubing, both elliptical and rectangular for exceptional strength and appealing design. The frame is electro welded and polished joints for ease of cleaning and a one piece look. Available in eight powder-coated finishes. Silver Metallic is offered as Krug's standard finish.

METAL FINISH OPTIONS

Silver Metallic frames are available with an anti-microbial finish for an upcharge of **\$64 list** per arm frame pair or table. Additional Frame Finishes, which include anti-microbial finish, are available for an upcharge of **\$64 list** per per arm frame pair or table. Available colors are: White, Parchment, Sand, Taupe, Warm Grey, Cool Grey or Black. For all metal finishes other than Silver Metallic Standard, there is a minimum order quantity of 30 units per color. Upcharges for order quantities less than 30 units per color or custom metal finishes, please contact Customer Service to obtain a quote.

WALL SAVER

The angle of the back and the rear legs are designed to keep the back away from the wall, to prevent wear and damage to both the chairs and to the walls of the facility. Patient and Guest chairs with mesh backs are excluded as they do not have the wall saver feature.

LATEX-FREE

Krug products are made with latex-free materials, to prevent the allergic reaction that latex causes in some people.

GANGING

All Solis Freestanding chairs can be ganged using a ganging bracket. The powder-coated metal plate is fastened to the underside of the steel side rails using the pre-existing holes in the frame.

EASY ACCESS ADJUSTABLE GLIDES

With the larger footprint of this chair and critical importance of stability for the user, we have included adjustable glides on the front legs - this allows the Easy Access chair to be perfectly leveled to any floor for maximum safety and stability.

FINISH DURABILITY

The Krug Enduraguard finish, a proprietary catalyzed varnish formulation, has been repeatedly shown, through independent laboratory testing, to be the industry leader in durability and abrasion resistance. The Krug finish looks better longer than competitors, and is uniquely suited to the demands of healthcare environments.

WEIGHT CAPACITIES

Weight capacities are as follows:
Guest & Patient Chairs (21" & 24") - 500 lbs
Plus Chairs (30" & 44") - 750 lbs
Multiple Seating & Pre-configured - 500 lbs per seat
2-Seat Freespan - 525 lbs per unit
3-Seat Freespan = 750 lbs per unit

PLUS UPGRADE

Solis 30" and 44" models feature Plus Upgrade. Plus Upgraded seating has been engineered to support higher weight capacities, accommodating a wider variety of users.

[View Solis Images | www.krug.ca](http://www.krug.ca)

SOLIS | OPTIONS

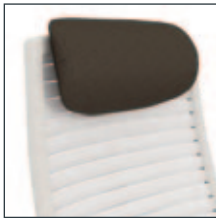

ADJUSTABLE HEADREST

The adjustable headrest uses dual density foam providing excellent support and comfort. The headrest is securely fastened using an innovative clip allowing the headrest to be easily removed for cleaning and/or replacement. The headrest is easily adjusted by sliding the headrest vertically allowing the user to maximize their comfort.



EASY CLEAN BACKREST COVERS

Easy clean backrest covers are available on all mesh back Patient chairs. They are removable, replaceable and cleanable. The easy clean backrest cover features a foam interior for comfort and durability.



WOOD SIDE RAILS

Solis can be specified with solid wood side rails, which, along with the selection of wood arms and a choice of metal finishes, provides a warmer look and feel. All Solis wood components feature Krug's high durability Enduraguard finish. Wood Side Rails are available for an upcharge and are not available with closed arm panels.



CASTERS

Castors are available on all 21" and 24" guest and patient chairs. Two rear hard wheel casters or four hard wheel casters are available for an upcharge per chair. The option of soft wheel casters can be ordered for additional upcharge. Both hard and soft caster options are standard non-locking but can be specified locking at no additional charge. The Solis caster is not a heavy-duty caster - it is designed and rated for normal use and load bearing, but has the potential to fail with excessive use, force, or weight. The caster was designed to allow the chairs to be moved for ease of cleaning and furniture arranging. Krug is not responsible for caster breakage under any circumstances. Solis casters are field replaceable.



KINETIC BACK OPTION

This optional feature provides the chair back with a very pleasant and comfortable rocking motion, which can significantly enhance long-term sitting for patients and guests alike. The durable spring-loaded mechanism provides a range of motion of 20 degrees, and can be field-installed or replaced. It's available on any Solis chair back - Guest, Patient and Multiple Seating - with the exception of the 30" and 44" sizes.



SOLID SURFACE ARM

The optional Solid Surface Arm provides enhanced durability, protection and cleanability for the arms. This is field replaceable if this becomes damaged or degraded and is available in 8 standard colors. See page 631 for color selection.

CAL133 & MOISTURE BARRIER

California Technical Bulletin 133 is a flammability test for seating. Krug offers a compliance method, in combination with non-flammable upholstery covers, may enable products to meet certification requirements for this test. This process at the same time also provides the products with a Moisture Barrier - a treatment that helps to prevent the passage of liquids and moisture to inside of the upholstered components - thereby conferring sanitary and anti-infection benefits. So when CAL 133 is specified, the product also automatically has a Moisture Barrier, and when a Moisture Barrier is specified, the product also features the compliance method and low flammability features of CAL 133.

The application of this up-charge and the compliance method does not mean that the specific configuration of product and upholstery cover are tested and officially certified as being CAL133 compliant. If the official certification is required, Krug will provide this (through an independent certified testing laboratory) at a charge of \$917 per item, plus the cost of the product to be tested. Lead time for certification testing is typically 4-8 weeks. Krug assumes no responsibility for the testing of our products in combination with upholstery covers, or for the results of any testing conducted. Some specific configurations of products and upholstery have already been tested. Please contact Customer Service for additional information.

REMOVABLE COVERS & REPLACEMENT COMPONENTS

Optional Removeable seat and back covers can be quickly installed on Solis products that were originally ordered with the Removeable cover option. Replacement seat and back covers can also be installed on Solis products that were not originally ordered with the Removeable cover option, with some simple staple removal on the original seats and backs. Complete Mesh backs can be ordered and field replaced.

CLEANABLE UNDER-SEAT SPLASHGUARD

All Solis seating models are available with a plastic moisture barrier that covers and encloses the underside of the seat (while still allowing air transfer and ventilation in and out of the seat cushion). The Splashguard significantly enhances the germ resistance properties of the product, by enclosing the part of the chair that can be most susceptible to infection-causing pathogens. The Splashguard is a smooth, easy to clean surface, either while on the chair or when removed, and is also field replaceable. The upcharges for the Splashguard are based on the size of the seat.

COMBINATION UPHOLSTERY OPTIONS

When combination upholstery is specified with fabric of the same grade or COM, an upcharge for dual fabrics is **\$33 list** per unit and **\$64 list** per unit for three fabrics will be applied. When graded in combination upholstery is selected, use the highest grade upholstery selected or to obtain a quote for blended grading contact Customer Service (please provide the fabrics specified and location of where each fabric is to be applied on the product).

SOLIS | GUEST, DIMENSIONS & COM REQUIREMENTS

DIMENSIONS & COM REQUIREMENTS

	Overall Width	Overall Depth	Overall Height	Seat Height	Height of Arms from Floor	Width Between Arms	Seat Depth	Shipping Weight	Cube	COM Yardage Seat & Back	COM Yardage Seat	COM Yardage Back	COM Yardage Closed Arm Panel
UPHOLSTERED BACK													
21" Seat	25	28	34.5	18.5	26	20	20	51	16	1.6	0.9	1.5	0.8
24" Seat	28	28	34.5	18.5	26	23	20	55	18	1.6	0.9	1.5	0.8
30" Seat	34	28	34.5	18.5	26	29	20	60	22	2.5	0.9	1.6	0.8
44" Seat	48	28	34.5	18.5	26	43	20	74	31	3.2	1.1	2.3	0.8
MESH BACK													
21" Seat	25	28	34.5	18.5	26	20	20	49	16	-	0.9	-	0.8
24" Seat	28	28	34.5	18.5	26	23	20	52	18	-	0.9	-	0.8

COM - YARDAGE REQUIREMENTS

	Yardage Seat & Back	Yardage Seat	Yardage Back	Yardage Closed Arm Panel
21" & 24" - One Chair	1.6	0.9	1.5	0.8
21" & 24" - Two Chairs	3.1	1.3	2.3	1.2
21" & 24" - Three Chairs	4.9	2.1	3.1	1.6
30" - One Chair	2.5	0.9	1.6	0.8
30" - Two Chairs	5	1.8	3.2	1.2
30" - Three Chairs	7.5	2.7	4.8	1.6
44" - One Chair	3.2	1.1	2.3	0.8
44" - Two Chairs	5.6	2.2	3.9	1.2
44" - Three Chairs	8.7	3.3	5.5	1.6

Multiple yardage requirements can also be used for Guest Back Easy Access chairs and Guest Back Start, Center, End Multiple seating.

Note: Some vinyls, leathers & upholsteries are not suitable for application on Solis seating.

The approval process is as follows:

1. A sample of the COM must be provided to Krug Customer Service prior to or at the time of order.

For Maharam, Momentum or CF Stinson, Krug will obtain the fabric sample.

2. The sample will be reviewed and the customer advised if the fabric is unsuitable.

3. The COM fabric or leather will be inspected when received at the factory, to identify any further concerns with its suitability.

MESH COLORS

- Slate
- Sand
- Celery
- Earth

- Warm Grey
- Terra
- Sky
- Olive

Mesh Specifications & Performance

ASTM D4157 Abrasion Resistance (Oscillatory Cylinder) 30,000 Rubs

ASTM D5034 Breaking Strength N 2167 Warp 1916 Weft

Flammability CAL177

AATCC TM8: Colorfastness to Crooking

Dry Class 5

Wet Class 5

ASTM D3511: Brush Pilling Rating 5

ASTM D6797: Ball Burst N 2486

Krug's Mesh backs covers are produced with Polyester yarns that are 100% recyclable. The yarn dying process is a closed loop system that recycles and recaptures 100% of the energy from the heating systems needed. All dyes contain no heavy metals, carcinogens or allergens.







SOLIS | GUEST | UPHOLSTERED BACKS

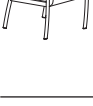

SOLIS | GUEST | MESH BACKS



SOLIS | GUEST

DESCRIPTION/MODEL	Arm Type	COM		COL		FABRIC GRADES			LEATHER		
		1	2	3	4	5	6	7	8	9	
	21" Open Arm, Mesh Back										
	SOL2-GM21OPU Urethane	1012	1044	1080	1142	1209	1276	1342	1409	1512	
	SOL2-GM21OPW Beech	1138	1170	1203	1270	1336	1403	1467	1536	1639	
	21" Open Arm, Upholstered Back										
	SOL2-GU21OPU Urethane	1063	1117	1170	1279	1384	1492	1598	1705	1920	
	SOL2-GU21OPW Beech	1191	1244	1297	1404	1510	1618	1727	1833	2046	
	24" Open Arm, Mesh Back										
	SOL2-GM24OPU Urethane	1053	1086	1118	1185	1251	1316	1384	1451	1555	
	SOL2-GM24OPW Beech	1178	1212	1245	1311	1377	1445	1510	1578	1678	
	24" Open Arm, Upholstered Back										
	SOL2-GU24OPU Urethane	1106	1158	1213	1317	1425	1534	1640	1747	1962	
	SOL2-GU24OPW Beech	1230	1284	1340	1446	1555	1662	1767	1872	2088	
	30" Open Arm, Upholstered Back										
	SOL2-GU30OPU Urethane	1286	1372	1456	1622	1790	1957	2124	2294	2629	
	SOL2-GU30OPW Beech	1415	1497	1584	1748	1915	2085	2250	2419	2754	
	44" Open Arm, Upholstered Back										
	SOL2-GU44OPU Urethane	1491	1572	1659	1822	1991	2160	2327	2493	2828	
	SOL2-GU44OPW Beech	1617	1699	1782	1949	2118	2283	2453	2620	2956	
	Solis Ganging Bracket SOL2-RLKBS		33								

Closed Arm Panels (per chair) - please add the following up charges for closed arm panels.

Fabric Grades	(COM) 1	2	(COL) 3	4	5	6	7	8	9
2 ARMS	418	448	477	531	588	643	699	757	869

Solis Guest Option Upcharges







	\$ List	\$ List
CAL 133 & Moisture Barrier (per yard)	64	Solid Surface Arm (per pair) - Gr A White
Guest chair - Removable Seat Cover (per seat)	90	Solid Surface Arm (per pair) - Gr A Color
21" & 24" - Removeable Back Cover (per back)	58	Solid Surface Arm (per pair) - Gr B
30" & 44" - Removeable Back Cover (per back)	90	Solid Surface Arm (per pair) - Gr C
21" & 24" Cleanable Under-seat Splashguard	40	Maple Arm upgrade per arm (add to beech price)
30" Cleanable Under-seat Splashguard	48	Beech Wood Side Rails Upgrade (per chair)
44" Cleanable Under-seat Splashguard	64	Maple wood Side Rails Upgrade (per chair)
Combination Upholstery - Dual Fabrics	33	Kinetic Back option (not available for 30" & 44")
Combination Upholstery - Three Fabrics	64	Non-Marring Glide
Soft Casters (21" & 24" chairs) -4 set	64	
Soft Casters (21" & 24" chairs) -2 set	33	
Non-locking Casters (21" & 24" chairs) -4 set	120	
Non-locking Casters (21" & 24" chairs) -2 set	80	

Note: Locking casters are available, clearly mark on the purchase order.

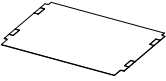
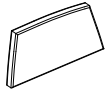

PRODUCT CODE KEY

Line	Series	Chair Type	Back Type	Size	Arm Type
<input type="text" value="SOL"/>	<input type="text" value="2"/>	<input type="text" value="G"/>	<input type="text" value="U"/>	<input type="text" value="21"/>	<input type="text" value="OPW"/> <input type="text" value="CLW"/>
Solis	Chair	Guest Seating	Upholstered Back		Open Arm - Wood Arm Closed Arm-Wood Arm
		<input type="text" value="M"/>	<input type="text" value="24"/>		<input type="text" value="OPU"/> <input type="text" value="CLU"/>
		Mesh Back 21" & 24" Only			Open Arm Urethane Arm Closed Arm-Urethane Arm
			<input type="text" value="30"/>		<input type="text" value="OSA"/> <input type="text" value="CSA"/>
					Open Arm - Solid Surface Arm Closed Arm-Solid Surface Arm

SOLIS | REPLACEMENT COMPONENTS

DESCRIPTION/MODEL	COM	COL		FABRIC GRADES			LEATHER			Yds	Weight	Cube	
	1	2	3	4	5	6	7	8	9				
	21" Replacement Guest Upholstered Backs SOL2-RBGU21	567	610	651	710	778	835	904	987	1071	1.5	14	2.7
	21" Replacement Guest Mesh Backs SOL2-RBGM21	477										10	2.7
	24" Replacement Guest Upholstered Backs SOL2-RBGU24	581	621	664	722	790	849	916	1002	1086	1.5	15	2.8
	24" Replacement Guest Mesh Backs SOL2-RBGM24	497										11	2.8
	30" Replacement Guest Upholstered Backs SOL2-RBGU30	632	679	727	795	871	938	1016	1111	1207	1.6	19	3.4
	44" Replacement Guest Upholstered Backs SOL2-RBGU44	794	843	889	957	1034	1102	1179	1273	1371	1.6	28	4.8
	21" Replacement Guest Upholstered Back Cover SOL2-RBCGU21	198	240	287	340	408	467	535	618	702	1.5	2	.8
	24" Replacement Guest Upholstered Back Cover SOL2-RBCGU24	198	240	287	340	408	467	535	618	702	1.5	2.3	.8
	30" Replacement Guest Upholstered Back Cover SOL2-RBCGU30	214	260	309	378	453	520	597	693	789	1.6	2.6	.8
	44" Replacement Guest Upholstered Back Cover SOL2-RBCGU44	218	267	315	382	458	527	602	697	795	2.25	3.5	.8
	Replacement Mesh Back Top Bar SOL2-RMBTB21	33										2.5	.5
	SOL2-RMBTB24	34										3.0	.7
	21" Replacement Seat SOL2-RS21	389	418	443	481	523	561	605	659	715	.9	9	2.7
	24" Replacement Seat SOL2-RS24	409	436	464	501	543	583	626	679	733	.9	10	2.7
	30" Replacement Seat SOL2-RS30	487	513	540	577	620	659	702	756	809	.9	12	3.4
	44" Replacement Seat SOL2-RS44	628	662	694	740	793	840	892	958	1022	1.1	14	4.8
	21" Replacement Seat Cover SOL2-RSC21	130	159	185	223	267	304	374	403	455	1.0	1.6	.8
	24" Replacement Seat Cover SOL2-RSC24	134	160	189	227	270	306	350	405	458	1.0	1.7	.8
	30" Replacement Seat Cover SOL2-RSC30	136	161	189	227	270	306	350	405	458	1.0	2	.8
	44" Replacement Seat Cover SOL2-RSC44	152	186	218	265	318	363	416	483	547	1.1	2.5	.8
	Replacement Splash Guard SOL2-RSG21	90										1	.3
	SOL2-RSG24	110										2	.4
	SOL2-RSG30	154										3	.5
	SOL2-RSG44	166										4	.6
	Replacement Closed Arm SOL2-RCA	207	218	231	247	267	283	303	327	350	0.4	6	.9
	Replacement Arm Top - Urethane SOL2-RACU	70										1.5	.2
	Replacement Arm Top - Beech SOL2-RACWB	213										1.0	.2
	Replacement Arm Top - Maple SOL2-RACWM	229										1.0	.2
	Replacement Arm Top - Solid Surface SOL2-RACSS				Grade A- White	Grade A- Color		Grade- B	Grade- C			1.0	.2
					256	261		282	304			1.0	.2

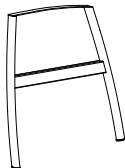
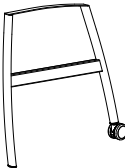
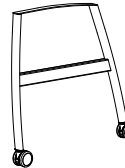
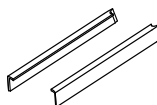
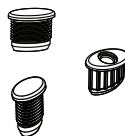
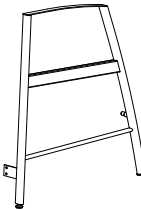
SOLIS | REPLACEMENT COMPONENTS

DESCRIPTION/MODEL	Price	Yds	Weight	Cube
	Replacement Side Frame - Start SOL2-RSFS	134	9	1.5
	Replacement Side Frame - Start - No Anti-Microbial SOL2-RSFSX	111	9	1.5
	Replacement Side Frame - End SOL2-RSFE	134	9	1.5
	Replacement Side Frame - End - No Anti-Microbial SOL2-RSFEX	111	9	1.5
	Replacement Side Frame - Start - 1 Glide, 1 Caster SOL2-RSFSC	172	9.5	1.5
	Replacement Side Frame - Start - 1 Glide, 1 Caster- No Anti-Microbial SOL2-RSFSCX	138	9.5	1.5
	Replacement Side Frame - End - 1 Glide, 1 Caster SOL2-RSFEC	172	9.5	1.5
	Replacement Side Frame - End - 1 Glide, 1 Caster- No Anti-Microbial SOL2-RSFECX	138	9.5	1.5
	Replacement Side Frame - Start - 2 Caster SOL2-RSFSC2	149	10	1.5
	Replacement Side Frame - Start - 2 Caster- No Anti-Microbial SOL2-RSFSC2X	145	10	1.5
	Replacement Side Frame - End - 2 Caster SOL2-RSFEC2	149	10	1.5
	Replacement Side Frame - End - 2 Caster- No Anti-Microbial SOL2-RSFEC2X	145	10	1.5
	Replacement Wood Side Rail Cover - Beech SOL2-RSRCB	180	1.0	.3
	Replacement Wood Side Rail Cover - Maple SOL2-RSRCM	231	1.0	.3
	Replacement Glide - Front SOL2-RGF	22	.5	.1
	Replacement Glide - Back SOL2-RGB	22	.5	.1
	Replacement Glide - Set of 4 SOL2-RGS4	24	2	.1
	Replacement Caster Glide - Front SOL2-RGFC	23	2	.1
	Replacement Caster Glide - Back SOL2-RGBC	23	2	.1
	Replacement Caster - Hard Wheel SOL2 - RCH	30	1.5	.3
Replacement Caster - Soft Wheel SOL2 - RCS	33	1.5	.3	
	Replacement Side Frame - Easy Access SOL2-RSFSEA	204	14	2.2
	SOL2-RSFEEA	204		
	Replacement Side Frame - Easy Access - No Anti-Microbial SOL2-RSFSEAX	191	14	2.2
	SOL2-RSFEEAX	191		
	Replacement Step for Easy Access SOL2-RSTEP21	182	7	.8
	SOL2-RSTEP24	186	9	1.2
	SOL2-RSTEP21X	178	7	.8
	SOL2-RSTEP24X	183	9	1.2

LEED CI CREDITS



MATERIAL CONTENT:

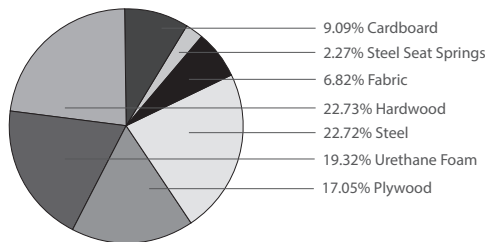

PRE-CONSUMER
RECYCLED CONTENT = 6.25%

POST-CONSUMER
RECYCLED CONTENT = 13.64%

Up to 31.82% of this Faeron product is recyclable at the end of its useful life.

	CONTRIBUTES TO	
CREDIT 2.1 - 2.2	Construction Waste Management	1-2 point(s)
CREDIT 3.3	Resource Reuse	1 point
CREDIT 4.1	Recycled Content	1 point
CREDIT 4.5	Low Emitting Materials, Systems & Seating	1 point
CREDIT 5.1	Regional Materials*	1 point
CREDIT 7	Certified Wood (MUST BE REQUESTED)	1 point(s)

*This credit is only applicable if in total 20% of the combined value of the procurement of construction materials and in the furniture are manufactured within a radius of 500 miles. This credit will apply if the installation of the finished product occurs within 500 miles of Kitchener, Ontario.

level® CERTIFICATION, AIR EMISSIONS AND FSC® CERTIFICATION



level® CERTIFICATION

BIFMA's e3 Furniture Sustainability Standard is a voluntary, multi-attribute standard that measures the degree of sustainability of furniture. This standard evaluates product and company environmental attributes and compliance systems in a wide range of elements which include Materials, Energy & Atmosphere, Human & Ecosystem Health and Social Responsibility. Faeron products have earned level®, BIFMA's sustainability certification program for furniture, certification through third-party verification against the e3 standard.

AIR-EMISSIONS

All Faeron products are supplied with air-emissions certified. Contact customer service for information.



FSC®

In 2005, Krug received Forest Stewardship Council® (FSC®) Chain-of-Custody certification for our manufacturing facilities. The FSC® Chain-of-Custody tracks certified wood from seedling to final sale. It verifies that the material for our FSC® certified products only come from well-managed, FSC®-certified forests and other controlled sources. FSC® is dedicated to the promotion of responsible forest management worldwide helping to take care of forests for future generations. Faeron and other Krug products can be specified with FSC® Certification. Contact customer service for further information, pricing and lead times.



Architects, designers, and building professionals can specify FSC®-certified products in order to achieve a point from the U.S. Green Building Council's Leadership in Energy and Environmental Design (LEED) Rating System.

FAERON WOOD | GUEST, PATIENT, MULTIPLE & EASY ACCESS FEATURES

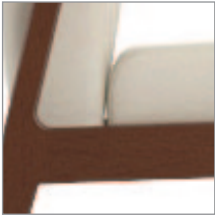

CLEAN OUT

All Faeron seating models have a built-in clean out feature: a space at the back of the seat that allows dirt, debris and liquid to fall to the floor for easy clean up and maintenance - designed so that it does not detract from the comfort or appearance of the product.



FLEX BACK

The ergonomically designed back has been designed with a slight flexing action, to enhance the level of long-term sitting comfort, and provide greater ease of egress.



WALL SAVER

The angle of the back and the rear legs are designed to keep the back away from the wall, to prevent wear and damage to both the chairs and to the walls of the facility.



STEEL SEAT FRAME

Steel seat frames are joined to other components with hardened steel bolts and inserts, ensuring exceptional durability and strength. In addition they ease re-configurability and on-site replacement of damaged or degraded components.

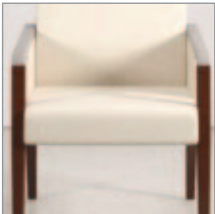

SEAT COMFORT

Seats feature a spring suspension across the entire model range for exceptional comfort while high grade foam provides superior support and longevity.

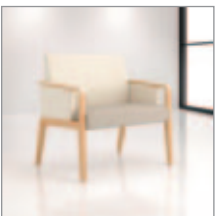

PLUS UPGRADE

Faeron 30" and 44" models feature Plus Upgrade. Plus Upgraded seating has been engineered to support higher weight capacities, accommodating a wider variety of users.



GLIDES

Faeron's Beech wood legs feature non-marring glides.

FINISH DURABILITY

The Krug's finish, a proprietary catalyzed varnish formulation, has been repeatedly shown, through independent laboratory testing, to be the industry leader in durability and abrasion resistance. The Krug finish looks better longer than competitors, and is uniquely suited to the demands of healthcare environments.

LATEX FREE

Krug products are made with latex-free materials to prevent the allergic reaction that latex causes in some people.

REPLACEABLE COMPONENTS

Faeron chairs are uniquely designed to allow virtually all major components to be field replaced, providing a very cost effective means to significantly extend the life of the product. Seats, backs, frames are field replaceable. Pricing and model numbers can be viewed online at www.krug.ca.

CUSTOM CAPABILITIES

Modifications in dimension, seat and back shape or thickness, and other modifications are possible with Krug's capability to customize for specific requirements and needs. We can also provide custom finishes.

WEIGHT CAPACITIES

Faeron weight capacities are as follows:

Guest & Patient Chairs (21" & 24") - 500 lbs

Plus Chairs (30" & 44") - 750 lbs

Easy Access Chairs - 500 lbs

Multiple Seating & Pre-configured - 500 lbs per seat

2-Seat Freespan - 625 lbs per unit

3-Seat Freespan - 750 lbs per unit

FAERON WOOD | GUEST, PATIENT, MULTIPLE & EASY ACCESS OPTIONS



ARM PANELS

Panel arms are available in semi and fully closed styles for optimum design flexibility.

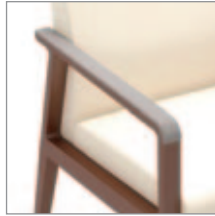

URETHANE ARM CAP

The optional Urethane Arm Cap provides enhanced durability and protection for the arms. This is field replaceable if this becomes damaged or degraded and is available in three colors; Black, Grey and Taupe.

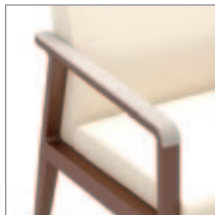

SOLID SURFACE ARM CAP

The optional Solid Surface Arm Cap provides enhanced durability, protection and cleanability for the arms. This is field replaceable if this becomes damaged or degraded and is available in 8 standard colors.



SOLID SURFACE ARM FRAME

The optional Solid Surface Arm provides a fully seamless armrest for enhanced durability, protection and cleanability. It is available in 8 standard colors and replaceable as a full side frame if it becomes damaged or degraded.



COMBINATION UPHOLSTERY OPTIONS

When combination upholstery is specified with fabric of the same grade or COM, an upcharge for dual fabrics is **\$33 list** per unit and **\$64 list** per unit for three fabrics will be applied. When graded in combination upholstery is selected, use the highest grade upholstery selected or to obtain a quote for blended grading contact Customer Service (please provide the fabrics specified and location of where each fabric is to be applied on the product).

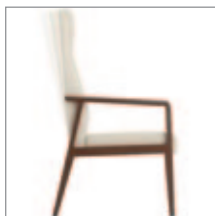

KINETIC BACK OPTION

Provides the chair back with a very pleasant and comfortable rocking motion, which can significantly enhance long-term sitting for patients and guests alike. The durable spring-loaded mechanism provides a range of motion of 20 degrees, and can be field-installed or replaced. It's available on any Faeron Guest or Patient chair back with the exception of the Plus styles (30" and 44").



CLEANABLE UNDER-SEAT SPLASHGUARD

All Faeron seating models are available with a plastic moisture barrier that covers and encloses the underside of the seat (while still allowing air transfer and ventilation in and out of the seat cushion). The Splashguard significantly enhances the germ resistance properties of the product, by enclosing the part of the chair that can be most susceptible to infection-causing pathogens. The Splashguard is a smooth, easy to clean surface, either while on the chair or when removed, and is also field replaceable.

GANGING

All Faeron freestanding Guest/Patient chairs can be ganged using a ganging bracket. The powder coated metal bracket is fastened to the inside face of each side frame.

REMOVABLE COVERS

Faeron chairs (all sizes) are available with removable seat and back covers. Replacement seat and back covers can be quickly installed on Faeron products that were originally ordered with the Removeable cover option. Replacement seat and back covers can also be installed on Faeron products that were not originally ordered with the removable cover option, with some simple staple removal on the original seats and backs

MOISTURE BARRIER & CAL 133

California Technical Bulletin 133 is a flammability test for seating. Krug offers a compliance method, in combination with non-flammable upholstery covers, may enable products to meet certification requirements for this test. This process at the same time also provides the products with a Moisture Barrier - a treatment that helps to prevent the passage of liquids and moisture to inside of the upholstered components - thereby conferring sanitary and anti-infection benefits. So when CAL 133 is specified, the product also automatically has a Moisture Barrier, and when a Moisture Barrier is specified, the product also features the compliance method and low flammability features of CAL 133.

The application of this up-charge and the compliance method does not mean that the specific configuration of product and upholstery cover are tested and officially certified as being CAL133 compliant. If the official certification is required, Krug will provide this (through an independent certified testing laboratory) at a charge of \$917 per item, plus the cost of the product to be tested. Lead time for certification testing is typically 4-8 weeks. Krug assumes no responsibility for the testing of our products in combination with upholstery covers, or for the results of any testing conducted. Some specific configurations of products and upholstery have already been tested. Please contact Customer Service for additional information.

FAERON WOOD | GUEST, DIMENSIONS & COM REQUIREMENTS

DIMENSIONS

	Overall Width	Overall Depth	Overall Height	Seat Height	Height of Arms from Floor	Width Between Arms	Seat Depth	Shipping Weight	Cube
21" Seat	25.0	26.3	34.5	19.0	25.0	21	19.5	44	14
24" Seat	28.0	26.3	34.5	19.0	25.0	24	19.5	48	19
30" Seat	34.0	26.3	34.5	19.0	25.0	30	19.5	54	20
44" Seat	48.0	26.3	34.5	19.0	25.0	44	19.5	71	28

COM- YARDAGE REQUIREMENTS

	COM Yardage Seat & Back	COM Yardage Seats Only	COM Yardage Back Only	COM Yardage Closed Arm Panel
21" & 24" - One Chair	1.6	0.9	1.4	0.8
30" - One Chair	2.3	0.9	1.4	0.8
44" - One Chair	2.9	1.5	1.6	0.8

Note: Some vinyls, leathers & upholsteries are not suitable for application on Faeron seating.

The approval process is as follows:

1. A sample of the COM must be provided to Krug Customer Service prior to or at the time of order.
2. The sample will be reviewed and the customer advised if the fabric is unsuitable.
3. The COM fabric or leather will be inspected when received at the factory, to identify any further concerns with its suitability.

WEIGHT CAPACITIES







Faeron weight capacities are as follows:

Guest Chairs (21" & 24") - 500 lbs

Guest Plus Chairs (30" & 44") - 750 lbs

Faeron Option Upcharges	\$ List		\$ List
CAL 133 & Moisture Barrier (per yard)	64	Solid Surface Arm Cap (per pair) - Gr A White	364
Ganging Bracket	58	Solid Surface Arm Cap (per pair) - Gr A Color	376
Kinetic Back (not available for 30" & 44")	120	Solid Surface Arm Cap (per pair) - Gr B	396
21" & 24" Under-seat Splashguard	58	Solid Surface Arm Cap (per pair) - Gr C	410
30" Under-seat Splashguard	72	Solid Surface Arm (per pair) - Gr A White	573
44" Under-seat Splashguard	91	Solid Surface Arm (per pair) - Gr A Color	598
Removeable Seat Cover	90	Solid Surface Arm (per pair) - Gr B	645
Removeable Back Cover	58	Solid Surface Arm (per pair) - Gr C	678
Urethane Arm Cap (per pair)	138		
Combination Upholstery - Dual Fabrics	33		
Combination Upholstery - Three Fabrics	64		

FAERON WOOD | GUEST



DESCRIPTION/MODEL	Species	COM		COL			FABRIC GRADES			LEATHER	
		1	2	3	4	5	6	7	8	9	
 21" Open Arm FAE2-G21ONC	Beech Palette	1257	1309	1358	1460	1560	1663	1765	1865	2066	
 21" Semi Closed Arm FAE2-G21SNC	Beech Palette	1712	1788	1862	2016	2167	2319	2472	2623	2928	
 21" Closed Arm FAE2-G21CNC	Beech Palette	1724	1801	1878	2030	2182	2332	2486	2637	2942	
 24" Open Arm FAE2-G24ONC	Beech Palette	1348	1399	1451	1552	1653	1753	1856	1956	2160	
 24" Semi Closed Arm FAE2-G24SNC	Beech Palette	1802	1879	1954	2107	2257	2410	2563	2715	3017	
 24" Closed Arm FAE2-G24CNC	Beech Palette	1816	1892	1967	2119	2272	2422	2577	2727	3032	

ORDERING NOTES: Faeron chairs can be specified with Urethane Arm Caps (UC), Solid Surface Arm Caps (SC) or Solid Surface Arm (SA), replace "NC" in the model number with the **Arm Style** selection below and add the upcharge listed on page 33.

PRODUCT CODE KEY

Line	Series	Chair Type	Size	Arm Type	Arm Style
FAE Faeron	2 Chair	G Guest Seating	21	O Open Arm	NC No Cap
			24	S Semi Closed Arm	UC Urethane Cap
			30	C Closed Arm	SC Solid Surface Cap
			44		SA Solid Surface Arm

FAERON WOOD | GUEST

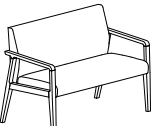
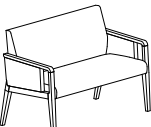
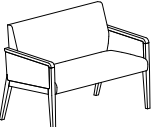
DESCRIPTION/MODEL	Species	COM		COL	FABRIC GRADES			LEATHER		
		1	2	3	4	5	6	7	8	9
 30" Open Arm FAE2-G30ONC	Beech Palette	1538	1611	1685	1831	1976	2121	2266	2412	2705
 30" Semi Closed Arm FAE2-G30SNC	Beech Palette	1991	2089	2189	2385	2581	2778	2972	3169	3563
 30" Closed Arm FAE2-G30CNC	Beech Palette	2006	2105	2201	2398	2594	2791	2987	3185	3578
 44" Open Arm FAE2-G44ONC	Beech Palette	1890	1981	2073	2256	2441	2625	2807	2992	3358
 44" Semi Closed Arm FAE2-G44SNC	Beech Palette	2343	2461	2579	2812	3047	3280	3515	3748	4219
 44" Closed Arm FAE2-G44CNC	Beech Palette	2357	2474	2591	2827	3059	3294	3530	3763	4234

ORDERING NOTES: Faeron chairs can be specified with Urethane Arm Caps (UC), Solid Surface Arm Caps (SC) or Solid Surface Arm (SA), replace "NC" in the model number with the **Arm Style** selection below and add the upcharge listed on page 33.

PRODUCT CODE KEY

Line	Series	Chair Type	Size	Arm Type	Arm Style
FAE Faeron	2 Chair	G Guest Seating	21	O Open Arm	NC No Cap
			24	S Semi Closed Arm	UC Urethane Cap
			30	C Closed Arm	SC Solid Surface Cap
			44		SA Solid Surface Arm

LEED CI CREDITS



MATERIAL CONTENT:

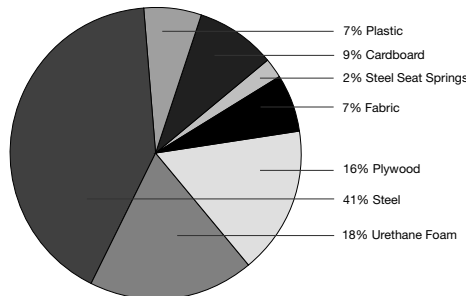

PRE-CONSUMER
RECYCLED CONTENT = 10.87 %

POST-CONSUMER
RECYCLED CONTENT = 17.48%

Up to 50% of this Faeron Metal product is recyclable at the end of its useful life.

CONTRIBUTES TO

CREDIT 2.1 - 2.2	Construction Waste Management	1-2 point(s)
CREDIT 3.3	Resource Reuse	1 point
CREDIT 4.1	Recycled Content	1 point
CREDIT 4.2	Recycled Content	1 point
CREDIT 4.5	Low Emitting Materials, Systems & Seating	1 point
CREDIT 5.1	Regional Materials*	1 point
CREDIT 7	Certified Wood (MUST BE REQUESTED)	1 point(s)

*This credit is only applicable if in total 20% of the combined value of the procurement of construction materials and in the furniture are manufactured within a radius of 500 miles. This credit will apply if the installation of the finished product occurs within 500 miles of Kitchener, Ontario.

level® CERTIFICATION, AIR EMISSIONS AND FSC® CERTIFICATION



level® CERTIFICATION

BIFMA's e3 Furniture Sustainability Standard is a voluntary, multi-attribute standard that measures the degree of sustainability of furniture. This standard evaluates product and company environmental attributes and compliance systems in a wide range of elements which include Materials, Energy & Atmosphere, Human & Ecosystem Health and Social Responsibility. Faeron products have earned level®, BIFMA's sustainability certification program for furniture, certification through third-party verification against the e3 standard.

AIR-EMISSIONS

All Faeron products are supplied with air-emissions certified. Contact customer service for information.



FSC®

In 2005, Krug received Forest Stewardship Council® (FSC®) Chain-of-Custody certification for our manufacturing facilities. The FSC® Chain-of-Custody tracks certified wood from seedling to final sale. It verifies that the material for our FSC® certified products only come from well-managed, FSC®-certified forests and other controlled sources. FSC® is dedicated to the promotion of responsible forest management worldwide helping to take care of forests for future generations. Faeron and other Krug products can be specified with FSC® Certification. Contact customer service for further information, pricing and lead times.



Architects, designers, and building professionals can specify FSC®-certified products in order to achieve a point from the U.S. Green Building Council's Leadership in Energy and Environmental Design (LEED) Rating System.

FAERON METAL | GUEST, PATIENT, MULTIPLE & EASY ACCESS FEATURES

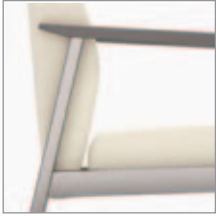

CLEAN OUT

All Faeron Metal seating models have a built-in clean out feature: a space at the back of the seat that allows dirt, debris and liquid to fall to the floor for easy clean up and maintenance - designed so that it does not detract from the comfort or appearance of the product.



FLEX BACK

The ergonomically designed back has been designed with a slight flexing action, to enhance the level of long-term sitting comfort, and provide greater ease of egress.



WALL SAVER

The angle of the back and the rear legs are designed to keep the back away from the wall, to prevent wear and damage to both the chairs and to the walls of the facility.



STEEL SEAT FRAME

Steel seat frames are joined to other components with hardened steel bolts and inserts, ensuring exceptional durability and strength. The seats features a spring system that substantially enhances comfort and extends product life cycle. Seats are removable, and field replaceable.



SEAT COMFORT

Seats feature a spring suspension for exceptional comfort while high grade foam provides superior support and longevity.

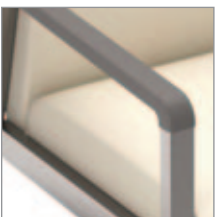

POLYMER ARM

Faeron arms are durable, comfortable, and long lasting. They are made with injected polymer that is a solid color throughout the arm and are available in three color options: Black, Grey and Taupe.

METAL FINISHES

Faeron Metal chairs are available in two metal finishes; Silver Metallic and Brushed Nickel.

FINISH DURABILITY

The Krug's finish, a proprietary catalyzed varnish formulation, has been repeatedly shown, through independent laboratory testing, to be the industry leader in durability and abrasion resistance. The Krug finish looks better longer and is especially suited to the demands of healthcare environments.

LATEX FREE

Krug products are made with latex-free materials to prevent the allergic reaction that latex causes in some people.

REPLACEABLE COMPONENTS

Faeron Metal chairs are uniquely designed to allow virtually all major components to be field replaced, providing a very cost effective means to significantly extend the life of the product. Seats, backs, frames are field replaceable. Pricing and model numbers can be viewed online at www.krug.ca.

CUSTOM CAPABILITIES

Modifications in dimension, seat and back shape or thickness, and other modifications are possible with Krug's capability to customize for specific requirements and needs. We can also provide custom finishes.

WEIGHT CAPACITIES

Faeron Metal weight capacities are as follows:
Guest & Patient Chairs (21" & 24") - 500 lbs
Plus Chairs (30" & 44") - 750 lbs
Easy Access Chairs - 500 lbs
Multiple Seating & Pre-configured - 500 lbs per seat
2-Seat Freespan - 625 lbs per unit
3-Seat Freespan - 750 lbs per unit

PLUS UPGRADE

Faeron 30" and 44" models feature Plus Upgrade. Plus Upgraded seating has been engineered to support higher weight capacities, accommodating a wider variety of users.

[Faeron Metal Images | www.krug.ca](http://www.krug.ca)

FAERON METAL | GUEST, PATIENT, MULTIPLE & EASY ACCESS OPTIONS



ARM PANEL

Upholstered arm panels are available in both semi- and fully-closed styles, and are field replaceable if damaged.



SOLID SURFACE ARM

The optional Solid Surface Arm provides a fully seamless armrest for enhanced durability, protection and cleanability. It is available in 8 standard Corian colors, and custom colors (at an upcharge). Arms are replaceable as a full side frame if they become damaged or degraded.



WOOD ARM

Wood arms are solid Beech and available in standard and custom finishes. Krug's wood finish is a proprietary high-durability formulation that has been shown to be an industry leader in abrasion resistance. Arms can be replaced if they do become damaged or degraded.



COMBINATION UPHOLSTERY OPTIONS

When combination upholstery is specified with fabric of the same grade or COM, an upcharge for dual fabrics is **\$33 list** per unit and **\$64 list** per unit for three fabrics will be applied. When graded in combination upholstery is selected, use the highest grade upholstery selected or to obtain a quote for blended grading contact Customer Service (please provide the fabrics specified and location of where each fabric is to be applied on the product).



KINETIC BACK OPTION

The optional Kinetic Back provides the chair back with a very pleasant and comfortable rocking motion, which can significantly enhance long-term sitting for patients and guests alike. The durable spring-loaded mechanism provides a range of motion of 20 degrees, and can be field-installed or replaced. It's available on any Faeron Guest or Patient chair back with the exception of the Plus styles (30" and 44").



CLEANABLE UNDER-SEAT SPLASHGUARD

All Faeron Metal seating models are available with a plastic moisture barrier that covers and encloses the underside of the seat (while still allowing air transfer and ventilation in and out of the seat cushion). The Splashguard significantly enhances the anti-microbial and germ resistance properties of the product, by enclosing the part of the chair that can be most susceptible to infection-causing pathogens. The Splashguard is a smooth, easy to clean surface, either while on the chair or when removed, and is also field replaceable.



REMOVABLE COVERS

Faeron Metal chairs (all sizes) are available with removable seat and back covers. Replacement seat and back covers can be quickly installed on Faeron products that were originally ordered with the Removeable cover option. Replacement seat and back covers can also be installed on Faeron products that were not originally ordered with the removeable cover option, with some simple staple removal on the original seats and backs.

METAL FINISH OPTIONS

Silver Metallic frames are available with an anti-microbial finish for an upcharge of **\$64 list** per arm frame pair or table. Additional Frame Finishes, which include anti-microbial finish, are available for an upcharge of **\$64 list** per arm frame pair or table. Available colors are: White, Parchment, Sand, Taupe, Warm Grey, Cool Grey or Black. For all metal finishes other than Silver Metallic Standard, there is a minimum order quantity of 30 units per color. Upcharges for order quantities less than 30 units per color or custom metal finishes, please contact Customer Service to obtain a quote.

MOISTURE BARRIER & CAL 133

California Technical Bulletin 133 is a flammability test for seating. Krug offers a compliance method, in combination with non-flammable upholstery covers, may enable products to meet certification requirements for this test. This process at the same time also provides the products with a Moisture Barrier - a treatment that helps to prevent the passage of liquids and moisture to inside of the upholstered components - thereby conferring sanitary and anti-infection benefits. So when CAL 133 is specified, the product also automatically has a Moisture Barrier, and when a Moisture Barrier is specified, the product also features the compliance method and low flammability features of CAL 133.

The application of this up-charge and the compliance method does not mean that the specific configuration of product and upholstery cover are tested and officially certified as being CAL133 compliant. If the official certification is required, Krug will provide this (through an independent certified testing laboratory) at a charge of \$917 per item, plus the cost of the product to be tested. Lead time for certification testing is typically 4-8 weeks. Krug assumes no responsibility for the testing of our products in combination with upholstery covers, or for the results of any testing conducted. Some specific configurations of products and upholstery have already been tested. Please contact Customer Service for additional information.

GANGING

All Faeron Metal freestanding Guest/Patient chairs can be ganged using a ganging bracket. The powder coated metal bracket is fastened to the inside face of each side frame.

FAERON METAL | GUEST

DIMENSIONS

	Overall Width	Overall Depth	Overall Height	Seat Height	Height of Arms from Floor	Width Between Arms	Seat Depth	Shipping Weight	Cube
21" Seat	25.0	26.3	34.5	19.0	25.0	21	19.5	56	14
24" Seat	28.0	26.3	34.5	19.0	25.0	24	19.5	60	19
30" Seat	34.0	26.3	34.5	19.0	25.0	30	19.5	66	20
44" Seat	48.0	26.3	34.5	19.0	25.0	44	19.5	83	28

COM- YARDAGE REQUIREMENTS

	COM Yardage Seat & Back	COM Yardage Seats Only	COM Yardage Back Only	COM Yardage Closed Arm Panel
21" & 24" - One Chair	1.6	0.9	1.4	0.96
30" - One Chair	2.3	0.9	1.4	0.96
44" - One Chair	2.9	1.5	1.6	0.96

ORDERING NOTES:

The approval process is as follows:

1. A sample of the COM must be provided to Krug Customer Service prior to or at the time of order.
 2. The sample will be reviewed and the customer advised if the fabric is unsuitable.
 3. The COM fabric or leather will be inspected when received at the factory, to identify any further concerns with its suitability.
- Note: Some vinyls, leathers & upholsteries are not suitable for application on Faeron Metal seating.

A drawing showing the configuration of the multiple seating and tables is required with each purchase order.

Faeron Option Upcharges

	\$ List		\$ List
CAL 133 & Moisture Barrier (per yard)	64	Solid Surface Arm (per pair) - Gr A White	573
Ganging Bracket	58	Solid Surface Arm (per pair) - Gr A Color	598
Kinetic Back (not available for Plus)	120	Solid Surface Arm (per pair) - Gr B	645
21" & 24" Under-seat Splashguard	58	Solid Surface Arm (per pair) - Gr C	678
30" Under-seat Splashguard	72	Beech/Palette Wood Arm (per pair)	215
44" Under-seat Splashguard	91		
Removeable Seat Cover	90		
Removable Back Cover	58		
Non-Marring Glides	16		







WEIGHT CAPACITIES

Faeron Metal weight capacities are as follows:

Guest Chairs (21" & 24") - 500 lbs

Plus Chairs (30" & 44") - 750 lbs

FAERON METAL | GUEST

DESCRIPTION/MODEL	COM		COL	FABRIC GRADES			LEATHER				
	1	2		4	5	6	7	8	9		
	21" Open Polymer Arm, Silver Metallic Frame FAE2M-G21OPAS		1222	1318	1415	1512	1610	1705	1898		
	21" Open Polymer Arm, Brushed Nickel Frame FAE2M-G21OPAN		1341	1390	1437	1535	1631	1728	1823	1921	2113
	21" Semi Closed Polymer Arm, Silver Metallic Frame FAE2M-G21SPAS		1558	1631	1703	1848	1991	2136	2282	2428	2717
	21" Semi Closed Polymer Arm, Brushed Nickel Frame FAE2M-G21SPAN		1773	1845	1918	2063	2209	2353	2497	2641	2933
	21" Closed Polymer Arm, Silver Metallic Frame FAE2M-G21CPAS		1570	1643	1715	1861	2006	2149	2296	2440	2730
	21" Closed Polymer Arm, Brushed Nickel Frame FAE2M-G21CPAN		1788	1858	1930	2077	2220	2366	2510	2656	2946
	24" Open Polymer Arm, Silver Metallic Frame FAE2M-G24OPAS		1213	1262	1310	1405	1504	1598	1695	1792	1985
	24" Open Polymer Arm, Brushed Nickel Frame FAE2M-G24OPAN		1429	1478	1526	1620	1717	1815	1911	2007	2198
	24" Semi Closed Polymer Arm, Silver Metallic Frame FAE2M-G24SPAS		1644	1716	1790	1935	2080	2222	2369	2513	2804
	24" Semi Closed Polymer Arm, Brushed Nickel Frame FAE2M-G24SPAN		1860	1932	2004	2149	2295	2438	2585	2728	3017
	24" Closed Polymer Arm, Silver Metallic Frame FAE2M-G24CPAS		1659	1730	1802	1947	2091	2237	2383	2527	2817
	24" Closed Polymer Arm, Brushed Nickel Frame FAE2M-G24CPAN		1872	1945	2017	2164	2307	2452	2596	2742	3032

ORDERING NOTES:

Faeron Metal chairs can also be specified with a Wood Arm (WA) or a Solid Surface Arm (SA), replace "PA" in the model number with the **Arm Style** selection below and add the upcharge listed.

Arm Style Option Upcharges





\$ List

Solid Surface Arm (per pair) - Gr A White	573
Solid Surface Arm (per pair) - Gr A Color	598
Solid Surface Arm (per pair) - Gr B	645
Solid Surface Arm (per pair) - Gr C	678
Beech/Palette Wood Arm (per pair)	215

PRODUCT CODE KEY

Line	Series	Chair Type	Size	Arm Type	Arm Style	Metal Finish
<input type="text" value="FAE"/> Faeron	<input type="text" value="2M"/> Chair	<input type="text" value="G"/> Guest Seating	<input type="text" value="21"/>	<input type="text" value="O"/> Open Arm	<input type="text" value="PA"/> Polymer Arm	<input type="text" value="S"/> Silver Metallic
			<input type="text" value="24"/>	<input type="text" value="S"/> Semi Closed Arm	<input type="text" value="WA"/> Wood Arm	<input type="text" value="N"/> Brushed Nickel
			<input type="text" value="30"/>	<input type="text" value="C"/> Closed Arm	<input type="text" value="SA"/> Solid Surface Arm	
			<input type="text" value="44"/>			

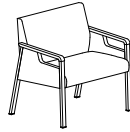
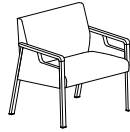
FAERON METAL | GUEST

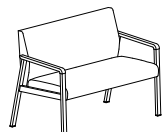
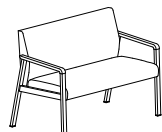
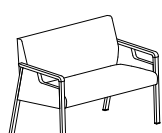
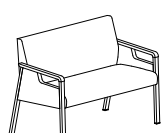
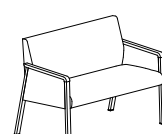
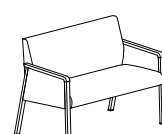
DESCRIPTION/MODEL	COM		COL	FABRIC GRADES			LEATHER		
	1	2	3	4	5	6	7	8	9
	30" Open Polymer Arm, Silver Metallic Frame								
	FAE2M-G30OPAS	1394	1462	1533	1670	1810	1949	2087	2227
	30" Open Polymer Arm, Brushed Nickel Frame								
	FAE2M-G30OPAN	1610	1677	1747	1885	2026	2165	2302	2441
	30" Semi Closed Polymer Arm, Silver Metallic Frame								
	FAE2M-G30SPAS	1825	1920	2012	2198	2386	2574	2761	2948
	30" Semi Closed Polymer Arm, Brushed Nickel Frame								
	FAE2M-G30SPAN	2041	2134	2228	2415	2602	2789	2977	3163
	30" Closed Polymer Arm, Silver Metallic Frame								
	FAE2M-G30CPAS	1839	1932	2026	2213	2399	2587	2773	2962
	30" Closed Polymer Arm, Brushed Nickel Frame								
	FAE2M-G30CPAN	2055	2147	2240	2429	2614	2803	2988	3177
	44" Open Polymer Arm, Silver Metallic Frame								
	FAE2M-G44OPAS	1729	1816	1904	2079	2254	2429	2605	2779
	44" Open Polymer Arm, Brushed Nickel Frame								
	FAE2M-G44OPAN	1944	2031	2118	2294	2470	2642	2818	2994
	44" Semi Closed Polymer Arm, Silver Metallic Frame								
	FAE2M-G44SPAS	2161	2272	2384	2608	2830	3054	3277	3499
	44" Semi Closed Polymer Arm, Brushed Nickel Frame								
	FAE2M-G44SPAN	2376	2487	2597	2822	3045	3268	3491	3714
	44" Closed Polymer Arm, Silver Metallic Frame								
	FAE2M-G44CPAS	2173	2285	2397	2619	2844	3067	3290	3513
	44" Closed Polymer Arm, Brushed Nickel Frame								
	FAE2M-G44CPAN	2388	2502	2612	2835	3058	3281	3505	3728

ORDERING NOTES:

Faeron Metal chairs can also be specified with a Wood Arm (WA) or a Solid Surface Arm (SA), replace "PA" in the model number with the Arm Style selection below and add the upcharge listed.

Arm Style Option Upcharges

\$ List

Solid Surface Arm (per pair) - Gr A White	573
Solid Surface Arm (per pair) - Gr A Color	598
Solid Surface Arm (per pair) - Gr B	645
Solid Surface Arm (per pair) - Gr C	678
Beech/Palette Wood Arm (per pair)	215

PRODUCT CODE KEY

Line	Series	Chair Type	Size	Arm Type	Arm Style	Metal Finish
FAE	2M	G	21	O	PA	S
Faeron	Chair	Guest Seating		Open Arm	Polymer Arm	Silver Metallic
			24	S	WA	N
				Semi Closed Arm	Wood Arm	Brushed Nickel
			30	C	SA	
				Closed Arm	Solid Surface Arm	
			44			

LEED CI CREDITS



MATERIAL CONTENT:

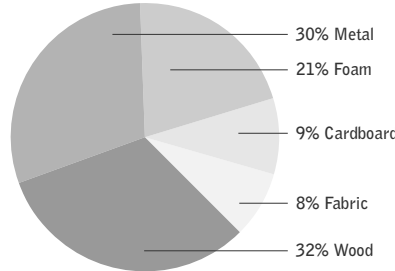

PRE-CONSUMER
RECYCLED CONTENT = 6.0%

POST-CONSUMER
RECYCLED CONTENT = 14.9%

	CONTRIBUTES TO	
CREDIT 2.1 - 2.2	Construction Waste Management	1-2 point(s)
CREDIT 3.3	Resource Reuse	1 point
CREDIT 4.1	Recycled Content	1 point
CREDIT 4.5	Low Emitting Materials, Systems & Seating	1 point
CREDIT 5.1	Regional Materials*	1 point
CREDIT 7	Certified Wood (MUST BE REQUESTED)	1 point(s)

*This credit is only applicable if in total 20% of the combined value of the procurement of construction materials and in the furniture are manufactured within a radius of 500 miles. This credit will apply if the installation of the finished product occurs within 500 miles of Kitchener, Ontario.

level® CERTIFICATION, AIR EMISSIONS AND FSC® CERTIFICATION



level® CERTIFICATION

BIFMA's e3 Furniture Sustainability Standard is a voluntary, multi-attribute standard that measures the degree of sustainability of furniture. This standard evaluates product and company environmental attributes and compliance systems in a wide range of elements which include Materials, Energy & Atmosphere, Human & Ecosystem Health and Social Responsibility. Jordan products have earned level®, BIFMA's sustainability certification program for furniture, certification through third-party verification against the e3 standard.

AIR-EMISSIONS

All Jordan products are supplied with air-emissions certified. Contact customer service for information.



FSC®

In 2005, Krug received Forest Stewardship Council® (FSC®) Chain-of-Custody certification for our manufacturing facilities. The FSC® Chain-of-Custody tracks certified wood from seedling to final sale. It verifies that the material for our FSC® certified products only come from well-managed, FSC®-certified forests and other controlled sources. FSC® is dedicated to the promotion of responsible forest management worldwide helping to take care of forests for future generations. Jordan and other Krug products can be specified with FSC® Certification. Contact customer service for further information, pricing and lead times.



Architects, designers, and building professionals can specify FSC®-certified products in order to achieve a point from the U.S. Green Building Council's Leadership in Energy and Environmental Design (LEED) Rating System.

JORDAN | GUEST - PATIENT, MULTIPLE & EASY ACCESS FEATURES



CLEAN OUT

All Jordan seating models have a built-in clean out feature: a space at the back of the seat that allows dirt, debris and liquid to fall to the floor for easy clean up and maintenance - designed so that it does not detract from the comfort or appearance of the product.



STEEL SEAT FRAME

The structural seat frame is made from welded steel with a powder-coated finish that allows Jordan to well exceed ANSI/BIFMA standards.



FLEX BACK

The ergonomically designed back has been designed with a slight flexing action, to enhance the level of long-term sitting comfort, and provide greater ease of egress.



WALL SAVER

The angle of the back and the rear legs are designed to keep the back away from the wall, to prevent wear and damage to both the chairs and to the walls of the facility.



URETHANE ARM CAP

The optional arm cap provides enhanced durability and protection for the arms. This is field replaceable if this becomes damaged or degraded and is available in three colors; Black, Grey and Taupe.

METAL TO METAL CONNECTIONS

Steel seat frames are joined to other components, and to each other in the multiple seating products, with hardened steel bolts and inserts, ensuring exceptional durability and strength, and easy reconfigurability, as well as on-site replacement of damaged or degraded components.

WEIGHT CAPACITIES

Jordan weight capacities are as follows:
Guest & Patient Chairs (21" & 24") - 500 lbs
Plus Chairs (30" & 44") - 750 lbs
Easy Access Chairs - 350 lbs
Multiple Seating & Pre-configured - 500 lbs per seat
2-Seat Freespan - 525 lbs per unit
3-Seat Freespan = 750 lbs per unit
21" & 24" Bench - 350 lbs
30" Bench - 750 lbs
48" Bench - 525 lbs per unit
72" Bench - 750 lbs per unit

FINISH DURABILITY

The Krug Enduraguard finish, a proprietary catalyzed varnish formulation, has been repeatedly shown, through independent laboratory testing, to be the industry leader in durability and abrasion resistance. The Krug finish looks better longer than competitors, and is uniquely suited to the demands of healthcare environments.

LATEX FREE

Krug products are made with latex-free materials to prevent the allergic reaction that latex causes in some people.

REPLACEABLE COMPONENTS

Jordan chairs are uniquely designed to allow virtually all major components to be field replaced, providing a very cost effective means to significantly extend the life of the product. Seats, backs, frames are field replaceable. Pricing and model numbers can be viewed online at www.krug.ca.

EASY ACCESS ADJUSTABLE GLIDES

With the larger footprint of this chair and critical importance of stability of the user, we have included adjustable glides on the front legs - this allows the Easy Access chair to be perfectly leveled to any floor for maximum safety and stability.

CUSTOM CAPABILITIES

Modifications in dimension, seat and back shape or thickness, and other modifications are possible with Krug's capability to customize for specific requirements and needs. We can also provide custom finishes.

ADDITIONAL FEATURES

- Lifetime warranty
- air-emissions Certified
- Spring seat construction, providing exceptional comfort and longer life for seat foam.
- Mortise and tenon frame construction, for optimal strength in wood joinery.
- Jordan sets a new standard for comfort and ergonomics in healthcare seating. Designed for ergonomically- correct posture and long-term sitting comfort, with contoured back and seat molds. Multi-density foam, provides lumbar, thoracic and pelvic support, while encouraging a healthy sitting posture.
- Large, rounded arms provide support for safe and easy ingress and egress.
- Certified to meet CTB 133/ ASTM E 1537 with appropriate fabrics

PLUS UPGRADE

Jordan 30" and 44" models feature Plus Upgrade. Plus Upgraded seating has been engineered to support higher weight capacities, accommodating a wider variety of users.

JORDAN | GUEST - PATIENT, MULTIPLE & EASY ACCESS OPTIONS



KINETIC BACK OPTION

This optional feature provides the chair back with a very pleasant and comfortable rocking motion, which can significantly enhance long-term sitting for patients and guests alike. The durable spring-loaded mechanism provides a range of motion of 20 degrees, and can be field-installed or replaced. It's available on any Jordan/Solis chair back - Guest, Patient and Multiple Seating - with the exception of the 30" and 44" sizes.



SOLID SURFACE ARM CAP

The optional Solid Surface Arm Cap provides enhanced durability, protection and cleanability for the arms.

This is field replaceable if this becomes damaged or degraded and is available in 8 standard colors. See page 631 for color selection.

CLEANABLE UNDER-SEAT SPLASHGUARD

All Jordan seating models are available with a plastic moisture barrier that covers and encloses the underside of the seat (while still allowing air transfer and ventilation in and out of the seat cushion). The Splashguard significantly enhances the germ resistance properties of the product, by enclosing the part of the chair that can be most susceptible to infection-causing pathogens. The Splashguard is a smooth, easy to clean surface, either while on the chair or when removed, and is also field replaceable.

GANGING

All Jordan freestanding chairs can be ganged using a ganging bracket. The powder coated metal bracket is fastened to the inside face of each side frame.

MOISTURE BARRIER & CAL 133

California Technical Bulletin 133 is a flammability test for seating. Krug offers a compliance method, in combination with non-flammable upholstery covers, may enable products to meet certification requirements for this test. This process at the same time also provides the products with a Moisture Barrier - a treatment that helps to prevent the passage of liquids and moisture to inside of the upholstered components - thereby conferring sanitary and anti-infection benefits. So when CAL 133 is specified, the product also automatically has a Moisture Barrier, and when a Moisture Barrier is specified, the product also features the compliance method and low flammability features of CAL 133.

The application of this up-charge and the compliance method does not mean that the specific configuration of product and upholstery cover are tested and officially certified as being CAL133 compliant. If the official certification is required, Krug will provide this (through an independent certified testing laboratory) at a charge of \$917 per item, plus the cost of the product to be tested. Lead time for certification testing is typically 4-8 weeks. Krug assumes no responsibility for the testing of our products in combination with upholstery covers, or for the results of any testing conducted. Some specific configurations of products and upholstery have already been tested. Please contact Customer Service for additional information.

REMOVABLE COVER OPTION

Jordan chairs (all sizes) are available with removeable seat and back covers. Replacement seat and back covers can be quickly installed on Jordan products that were originally ordered with the Removeable Cover option. Replacement seat and back covers can also be installed on Jordan products that were not originally ordered with the removeable cover option, with some simple staple removal on the original seats and backs.

COMBINATION UPHOLSTERY OPTIONS

When combination upholstery is specified with fabric of the same grade or COM, an upcharge for dual fabrics is **\$33 list** per unit and **\$64 list** per unit for three fabrics will be applied. When graded in combination upholstery is selected, use the highest grade upholstery selected or to obtain a quote for blended grading contact Customer Service (please provide the fabrics specified and location of where each fabric is to be applied on the product).

JORDAN | GUEST - DIMENSIONS & COM REQUIREMENTS

DIMENSIONS & COM REQUIREMENTS

	Overall Width	Overall Depth	Overall Height	Seat Height	Height of Arms from Floor	Width Between Arms	Seat Depth	Shipping Weight	Cube
21" Seat	25	27	34.25	18.5	26	20.5	19	42	14
24" Seat	28	27	34.25	18.5	26	23.5	19	46	19
30" Seat	34	27	34.25	18.5	26	29.5	19	52	20
44" Seat	48	27	34.25	18.5	26	43.5	19	69	28

COM- YARDAGE REQUIREMENTS

	COM Yardage Seat & Back	COM Yardage Seats Only	COM Yardage Back Only	COM Yardage Closed Arm Panel
21" & 24" - One Chair	1.6	0.9	1.4	0.9
21" & 24" - Two Chairs	3.2	1.3	2.8	1.35
21" & 24" - Three Chairs	4.8	2.2	4.2	1.8
21" & 24" - Four Chairs	6.4	2.6	5.6	2.7
30" & 44" - One Chair	2.7	0.9	1.6	0.9
30" & 44" - Two Chairs	5.4	1.8	3.2	1.35
30" & 44" - Three Chairs	8.1	2.7	4.8	1.8
30" & 44" - Four Chairs	10.8	3.6	6.4	2.7

Note: Some vinyls, leathers & upholsteries are not suitable for application on Jordan seating.

The approval process is as follows:

1. A sample of the COM must be provided to Krug Customer Service prior to or at the time of order.
For Maharam or Momentum, Krug will obtain the fabric sample.
2. The sample will be reviewed and the customer advised if the fabric is unsuitable.
3. The COM fabric or leather will be inspected when received at the factory, to identify any further concerns with its suitability.

JORDAN | GUEST & GUEST PLUS









WEIGHT CAPACITIES

Jordan weight capacities are as follows:

Guest Chairs (21" & 24") - 500 lbs

Guest Plus Chairs (30" & 44") - 750 lbs

Jordan Guest Option Upcharges	\$ List	\$ List
CAL 133 & Moisture Barrier (per yard)	64	Solid Surface Arm Cap (per pair) - Gr A White 452
Guest chair - Removable Seat Cover (per seat)	90	Solid Surface Arm Cap (per pair) - Gr A Color 458
21" & 24" - Removeable Back Covers (per back)	58	Solid Surface Arm Cap (per pair) - Gr B 481
30" & 44" - Removeable Back Covers (per back)	90	Solid Surface Arm Cap (per pair) - Gr C 507
Combination Upholstery - Dual Fabrics	33	Kinetic Back option (not available for 30" & 44") 120
Combination Upholstery - Three Fabrics	64	Ganging Bracket 58
21" & 24" Cleanable Under-seat Splashguard	40	
30" Cleanable Under-seat Splashguard	48	
44" Cleanable Under-seat Splashguard	64	
Non-Marring Glide	37	

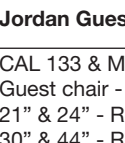
DESCRIPTION/MODEL	Species	COM		COL		FABRIC GRADES			LEATHER		
		1	2	3	4	5	6	7	8	9	
	21" Open Arm										
	JOR2-G21OPS	Beech	1170	1257	1342	1466	1603	1736	1880	2042	2329
	JOR2-G21OPS	Maple	1257	1342	1430	1555	1698	1853	2004	2146	2434
	21" Open Arm Urethane Cap										
	JOR2-G21OPU	Beech	1310	1396	1482	1609	1743	1878	2019	2182	2470
	JOR2-G21OPU	Maple	1396	1482	1568	1693	1837	1990	2144	2285	2574
	21" Closed Arm										
	JOR2-G21CLS	Beech	1292	1378	1464	1589	1724	1857	2002	2165	2452
	JOR2-G21CLS	Maple	1378	1464	1554	1676	1819	1974	2129	2269	2557
	21" Closed Arm Urethane Cap										
	JOR2-G21CLU	Beech	1431	1518	1604	1730	1863	1997	2140	2304	2591
	JOR2-G21CLU	Maple	1518	1604	1691	1816	1959	2112	2266	2410	2697
	24" Open Arm										
	JOR2-G24OPS	Beech	1201	1285	1373	1495	1632	1765	1909	2070	2359
	JOR2-G24OPS	Maple	1295	1380	1466	1592	1736	1887	2042	2188	2472
	24" Open Arm Urethane Cap										
	JOR2-G24OPU	Beech	1340	1423	1512	1636	1771	1905	2048	2211	2497
	JOR2-G24OPU	Maple	1434	1521	1609	1731	1878	2030	2182	2326	2612
	24" Closed Arm										
	JOR2-G24CLS	Beech	1320	1408	1494	1618	1752	1885	2031	2193	2481
	JOR2-G24CLS	Maple	1417	1503	1589	1714	1857	2011	2165	2308	2595
	24" Closed Arm Urethane Cap										
	JOR2-G24CLU	Beech	1461	1547	1634	1756	1892	2026	2170	2332	2620
	JOR2-G24CLU	Maple	1558	1642	1730	1854	1997	2148	2304	2448	2736
	30" Open Arm										
	JOR2-G30OPS	Beech	1563	1716	1853	2083	2312	2541	2772	3003	3366
	JOR2-G30OPS	Maple	1678	1834	1987	2215	2447	2673	2906	3135	3499
	30" Open Arm Urethane Cap										
	JOR2-G30OPU	Beech	1703	1856	1990	2220	2451	2682	2911	3141	3505
	JOR2-G30OPU	Maple	1818	1971	2126	2355	2586	2817	3043	3274	3639
	30" Closed Arm										
	JOR2-G30CLS	Beech	1563	1716	1853	2083	2312	2541	2772	3003	3366

Jordan Guest Option Upcharges		\$ List	\$ List
CAL 133 & Moisture Barrier (per yard)	64	Solid Surface Arm Cap (per pair) - Gr A White	452
Guest chair - Removable Seat Cover (per seat)	90	Solid Surface Arm Cap (per pair) - Gr A Color	458
21" & 24" - Removeable Back Covers	58	Solid Surface Arm Cap (per pair) - Gr B	481
30" & 44" - Removable Back Covers (per back)	90	Solid Surface Arm Cap (per pair) - Gr C	507
Combination Upholstery - Dual Fabrics	33	Kinetic Back option (not available for 30" & 44")	120
Combination Upholstery - Three Fabrics	64	Ganging Bracket	58
21" & 24" Cleanable Under-seat Splashguard	40		
30" Cleanable Under-seat Splashguard	48		
44" Cleanable Under-seat Splashguard	64		
Non-Marring Glide	37		

PRODUCT CODE KEY

Line	Series	Chair Type	Size	Arm Type
JOR	2	G	21	OPS
Jordan	Chair	Guest Seating		Open Arm
				CLS
				Closed Arm
			24	OPU
				Open Arm
				CLU
				Closed Arm
				Urethane Arm Cap
				Urethane Arm Cap
			30	OSC
				Open Arm
				CSC
				Closed Arm
				Solid Surface
				Solid Surface
			44	Arm Cap
				Arm Cap

JORDAN | GUEST

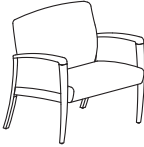
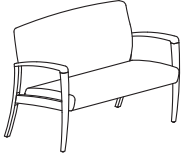
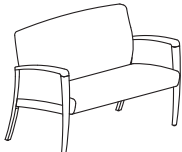
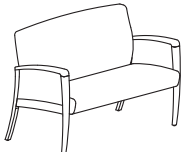
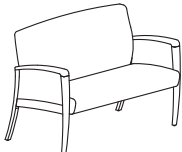
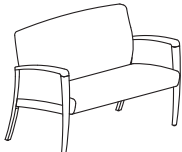
DESCRIPTION/MODEL	Species	COM		COL		FABRIC GRADES			LEATHER		
		1	2	3	4	5	6	7	8	9	
	30" Closed Arm										
	JOR2-G30CLS	Beech	1686	1839	1974	2205	2433	2664	2893	3126	3488
	JOR2-G30CLS	Maple	1802	1955	2108	2337	2567	2798	3028	3259	3622
	30" Closed Arm Urethane Cap										
	44" Open Arm										
	JOR2-G44OPS	Beech	1870	2062	2223	2493	2772	3049	3327	3605	4037
	JOR2-G44OPS	Maple	2012	2206	2378	2657	2934	3211	3489	3759	4198
	44" Open Arm Urethane Cap										
	44" Closed Arm										
	JOR2-G44CLS	Beech	1991	2185	2346	2614	2893	3169	3449	3727	4158
	JOR2-G44CLS	Maple	2135	2327	2500	2778	3056	3333	3609	3880	4319
	44" Closed Arm Urethane Cap										
	30" Closed Arm Urethane Cap										
	JOR2-G30CLU	Beech	1823	1979	2112	2343	2571	2804	3032	3265	3627
	JOR2-G30CLU	Maple	1941	2092	2247	2479	2707	2936	3165	3397	3761
	44" Closed Arm Urethane Cap										
	44" Closed Arm Urethane Cap										
	JOR2-G44OPU	Beech	2010	2201	2362	2634	2911	3187	3468	3743	4177
	JOR2-G44OPU	Maple	2155	2345	2517	2794	3073	3352	3628	3896	4337
	44" Closed Arm Urethane Cap										
	44" Closed Arm Urethane Cap										
	JOR2-G44CLU	Beech	2132	2324	2486	2754	3032	3312	3589	3866	4296
	JOR2-G44CLU	Maple	2274	2465	2638	2919	3194	3472	3752	4020	4459
	44" Closed Arm Urethane Cap										









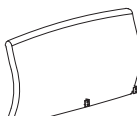

Jordan Guest Option Upcharges

	\$ List		\$ List
CAL 133 & Moisture Barrier (per yard)	64	Solid Surface Arm Cap (per pair) - Gr A White	452
Guest chair - Removable Seat Cover (per seat)	90	Solid Surface Arm Cap (per pair) - Gr A Color	458
21" & 24" - Removeable Back Covers	58	Solid Surface Arm Cap (per pair) - Gr B	481
30" & 44" - Removable Back Cover (per back)	90	Solid Surface Arm Cap (per pair) - Gr C	507
Combination Upholstery - Dual Fabrics	33	Kinetic Back option (not available for 30" & 44")	120
Combination Upholstery - Three Fabrics	64	Ganging Bracket	58
21" & 24" Cleanable Under-seat Splashguard	40		
30" Cleanable Under-seat Splashguard	48		
44" Cleanable Under-seat Splashguard	64		
Non-Marring Glide	37		



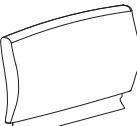

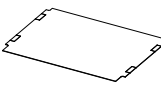

PRODUCT CODE KEY

Line	Series	Chair Type	Size	Arm Type	
JOR	2	G	21	OPS	CLS
Jordan	Chair	Guest Seating		Open Arm	Closed Arm
			24	OPU	CLU
				Open Arm	Closed Arm
				Urethane Arm Cap	Urethane Arm Cap
			30	OSC	CSC
				Open Arm	Closed Arm
				Solid Surface	Solid Surface
			44	Arm Cap	Arm Cap

JORDAN | REPLACEMENT COMPONENTS

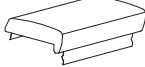
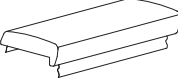
DESCRIPTION/MODEL	COM			COL			FABRIC GRADES			LEATHER			Yds	Weight	Cube
	1	2	3	4	5	6	7	8	9						
 21" Replacement Guest Upholstered Backs JOR2-RBG21	424	466	509	567	634	693	760	844	929	1.4	14	2.7			
 24" Replacement Guest Upholstered Backs JOR2-RBG24	437	480	521	582	647	707	774	857	941	1.4	15	2.7			
 30" Replacement Guest Upholstered Backs JOR2-RBG30	517	567	614	680	769	826	904	999	1094	1.6	19	3.4			
 44" Replacement Guest Upholstered Backs JOR2-RBG44	652	701	749	816	892	960	1037	1134	1228	2.25	28	4.8			
 21" Replacement Guest Upholstered Back Cover JOR2-RBCG21	182	224	267	326	391	452	517	602	687	1.5	2	.8			
 24" Replacement Guest Upholstered Back Cover JOR2-RBCG24	185	227	269	328	394	454	520	605	689	1.5	2.3	.8			
 30" Replacement Guest Upholstered Back Cover JOR2-RBCG30	194	243	290	359	434	501	580	674	769	1.6	2.6	.8			
 44" Replacement Guest Upholstered Back Cover JOR2-RBCG44	203	253	299	365	443	511	641	685	780	2.25	3.5	.8			
 21" Replacement Guest Seat JOR2-RS21	394	416	444	481	523	562	606	661	715	.9	9	2.7			
 24" Replacement Guest Seat JOR2-RS24	410	437	465	502	544	584	627	680	735	.9	10	2.7			
 30" Replacement Guest Seat JOR2-RS30	502	537	569	615	667	715	767	833	898	.9	12	3.4			
 44" Replacement Guest Seat JOR2-RS44	663	695	729	774	827	873	928	992	1059	.9	14	4.8			
	Replacement Splash Guard														
	JOR2-RSG21	90										1	.3		
	JOR2-RSG24	110										2	.4		
	JOR2-RSG30	154										3	.5		
JOR2-RSG44	166										4	.6			

JORDAN | REPLACEMENT COMPONENTS

DESCRIPTION/MODEL	COM			COL			FABRIC GRADES				LEATHER			Yds	Weight	Cube
	1	2	3	4	5	6	7	8	9							
 21" Replacement Seat Cover JOR2-RSC21	78	50	182	218	261	301	344	397	452	1.0	1.6	.8				
 24" Replacement Guest Seat Cover JOR2-RSC24	82	159	186	223	267	304	347	403	455	1.0	1.7	.8				
 30" Replacement Seat Cover JOR2-RSC30	144	179	212	258	310	358	409	477	541	1.0	2	.8				
 44" Replacement Seat Cover SOL2-RSC44	149	183	216	261	315	361	413	480	544	1.0	2.5	.8				
 Replacement Closed Arm Panel JOR2-RCA	218	232	245	265	286	305	327	354	407	0.9	6.0	.8				
	Replacement Side Frame - Start - Beech										7.5	1.4				
	JOR2-RSFS	264														
	Replacement Side Frame - Start - Maple										7.5	1.4				
	JOR2-RSFS	328														
	Replacement Side Frame - End - Beech										7.5	1.4				
	JOR2-RSFE	264														
	Replacement Side Frame - End - Maple										7.5	1.4				
	JOR2-RSFE	328														
	Replacement Center Frame - Start - Beech										7.5	1.4				
	JOR2-RSFC	264														
	Replacement Center Frame - Start - Maple										7.5	1.4				
	JOR2-RSFC	328														
	Replacement Side Frame with Urethane Cap - Start - Beech										7.5	1.4				
	JOR2-RSFSAC	308														
	Replacement Side Frame with Urethane Cap - Start - Maple										7.5	1.4				
	JOR2-RSFSAC	372														
Replacement Side Frame with Urethane Cap - End - Beech										7.5	1.4					
JOR2-RSFEAC	308															
Replacement Side Frame with Urethane Cap - End - Maple										7.5	1.4					
JOR2-RSFEAC	372															
Replacement Center Frame with Urethane Cap - Start - Beech										7.5	1.4					
JOR2-RSFCAC	308															
Replacement Center Frame with Urethane Cap - Start - Maple										7.5	1.4					
JOR2-RSFCAC	372															
	Replacement Arm Cap - Urethane JOR2-RUA										1.5	.2				
	71															
										Grade A- White	Grade A- Color	Grade- B	Grade- C			
Replacement Arm Cap-Solid Surface JOR2-RACSS										238	240	250	264	2	.2	

LEED CI CREDITS

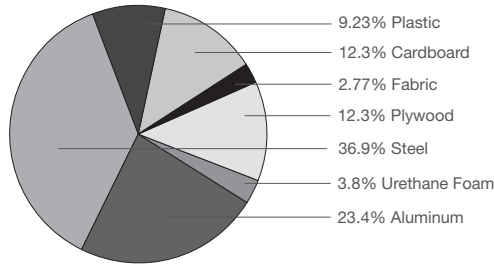

PRE-CONSUMER
RECYCLED CONTENT = 26.34%

POST-CONSUMER
RECYCLED CONTENT = 22.74

Up to 55.38% of this Corfu product is recyclable at the end of its useful life.

(COR2-61S)

CONTRIBUTES TO

CREDIT 2.1 - 2.2	Construction Waste Management	1-2 point(s)
CREDIT 3.3	Resource Reuse	1 point
CREDIT 4.1	Recycled Content	1 point
CREDIT 4.2	Recycled Content	1 point
CREDIT 4.5	Low Emitting Materials, Systems & Seating	1 point
CREDIT 5.1	Regional Materials*	1 point
CREDIT 7	Certified Wood (MUST BE REQUESTED)	1 point(s)

*This credit is only applicable if in total 20% of the combined value of the procurement of construction materials and in the furniture are manufactured within a radius of 500 miles. This credit will apply if the installation of the finished product occurs within 500 miles of Kitchener, Ontario.

level® CERTIFICATION, AIR EMISSIONS AND FSC® CERTIFICATION



level® CERTIFICATION

BIFMA's e3 Furniture Sustainability Standard is a voluntary, multi-attribute standard that measures the degree of sustainability of furniture. This standard evaluates product and company environmental attributes and compliance systems in a wide range of elements which include Materials, Energy & Atmosphere, Human & Ecosystem Health and Social Responsibility. Corfu products have earned level®, BIFMA's sustainability certification program for furniture, certification through third-party verification against the e3 standard.

AIR-EMISSIONS

All Corfu products are supplied with air-emissions certified. Contact customer service for information.



FSC®

In 2005, Krug received Forest Stewardship Council® (FSC®) Chain-of-Custody certification for our manufacturing facilities. The FSC® Chain-of-Custody tracks certified wood from seedling to final sale. It verifies that the material for our FSC® certified products only come from well-managed, FSC®-certified forests and other controlled sources. FSC® is dedicated to the promotion of responsible forest management worldwide helping to take care of forests for future generations. Corfu and other Krug products can be specified with FSC® Certification. Contact customer service for further information, pricing and lead times.



Architects, designers, and building professionals can specify FSC®-certified products in order to achieve a point from the U.S. Green Building Council's Leadership in Energy and Environmental Design (LEED) Rating System.

CORFU | FEATURES & OPTIONS



SUSTAINABLE DESIGN

Corfu is made with recycled materials, with an overall recycled content of 40%. Many of these same materials are also recyclable. Corfu is air emissions certified.



STEEL FRAME

Corfu seating is built with high strength steel castings and extrusions. Finish options are Silver Metallic and Polished Chrome.



UNDER SEAT COVER

Each Corfu includes an underseat system for stacking: a grey polypropylene seat pan that nests into the seat below and protects it from the frame above. It also provides for easy cleaning and maintenance by covering the underside of the chair.



PLASTIC COMPONENTS

Polypropylene seats, backs and other components are injection molded, with pigment diffused throughout the mold, and featuring a compound that provides UV resistance to fading and brittleness from exposure to light. Seats and backs have a minimum wall thickness of 5 mm, providing excellent strength and shock resistance. Corfu (Plastic Seat & Back) is available in six different colors. Please specify a color when ordering.

Color Selection:

White, Black, Grey, Red, Blue, Sand



WOOD FINISH

Krug's Enduraguard™ finish is a catalyzed conversion varnish topcoat, combined with a vinyl polymer-based sealer, that in independent testing has been shown to have exceptional durability characteristics in its resistance to scratching, marring, and degradation from cleaning materials and other substances.



BEECH PLYWOOD

Wood seats and backs are made with European Beech hardwood veneers, featuring nine (9) plies of cross grain for added strength and durability.



STACKING

Corfu chairs are stackable, to a maximum of 13 chairs for the wood or plastic versions, and 10 chairs for the upholstered version, when stacked on the Corfu caddie. Corfu chairs are stackable to a maximum of 9 chairs for the wood or plastic versions and 6 chairs for the upholstered version when stacked on the floor. The upholstered versions stack to a height of 74" in the armless version, and 76" with arms. The non-upholstered versions stack to a height of 70" in the armless version and 72" in the version with arms.

CADDIE

The Corfu caddie provides enhanced stackability, along with the ease of movement and storage. Its design allows for the stacking and storage of all Krug stackable chairs. It has a durable tubular construction and 4 soft-wheel swivel, locking casters. This caddie is designed to stack and transport Krug's other stacking chairs.

GANGING

Corfu can be ordered with the option of ganging for the upcharge. Please specify ganging when ordering.

PACKAGING

Corfu packaging features recycled, recyclable cardboard. The arm and armless chairs are shipped 4 units per carton.

OPTIONS

COMBINATION UPHOLSTERY OPTIONS

When combination upholstery is specified with fabric of the same grade or COM, an upcharge for dual fabrics is **\$33 list** per unit will be applied. When graded in combination upholstery is selected, use the highest grade upholstery selected or to obtain a quote for blended grading contact Customer Service (please provide the fabrics specified and location of where each fabric is to be applied on the product).

CAL 133 & MOISTURE BARRIER

California Technical Bulletin 133 is a flammability test for seating. Krug offers a compliance method which, in combination with non-flammable upholstery covers, may enable the products to meet certification requirements for this test. This process at the same time also provides the products with a Moisture Barrier - a treatment that helps to prevent the passage of liquids and moisture to inside of upholstered components - thereby conferring sanitary and anti-infection benefits. So when CAL 133 is specified, the product also automatically has a Moisture Barrier, and when a Moisture Barrier is specified, the product also features the compliance method and low flammability features of CAL 133.

The application of this upcharge and the compliance method does not mean that the specific configuration of product and upholstery cover are tested and officially certified as being CAL 133 compliant. If official certification is required, Krug will provide this (through an independent certified testing laboratory) at a charge of \$917 per item, plus the cost of the product to be tested. Lead time for certification testing is typically 4-8 weeks. Krug assumes no responsibility for the testing of our products in combination with upholstery covers, or for the results of any testing conducted. Some specific configurations of product and upholstery have already been tested. Please contact Customer Service for additional information.

DIMENSIONS

	Overall Width	Overall Depth	Overall Height	Seat Height	Height of Arms from Floor	Width Between Arms	Seat Depth	Shipping Weights & Cubes			
								1 unit W C	2 units W C	3 units W C	4 units W C
COR2-10S	20.87	20.87	32.28	17.5	n/a	n/a	17	28 16	46 17	65 18	83 20
COR2-10C	20.87	20.87	32.28	17.5	n/a	n/a	17				
COR2-11S	23.23	20.87	32.28	17.5	26.75	21.25	17	30 16	51 17	73 18	93 20
COR2-11C	23.23	20.87	32.28	17.5	26.75	21.25	17				
COR2-20S	20.87	20.87	32.28	17.5	n/a	n/a	17	30 16	51 17	73 18	94 20
COR2-20C	20.87	20.87	32.28	17.5	n/a	n/a	17				
COR2-21S	23.23	20.87	32.28	17.5	26.75	21.25	17	36 16	63 17	92 18	119 20
COR2-21C	23.23	20.87	32.28	17.5	26.75	21.25	17				
COR2-30S	20.87	20.87	32.28	17.5	n/a	n/a	17	31 16	52 17	75 18	97 20
COR2-30C	20.87	20.87	32.28	17.5	n/a	n/a	17				
COR2-31S	23.23	20.87	32.28	17.5	26.75	21.25	17	33 16	57 17	83 18	106 20
COR2-31C	23.23	20.87	32.28	17.5	26.75	21.25	17				
COR2-40S	20.87	20.87	32.28	17.5	n/a	n/a	17	31 16	52 17	75 18	97 20
CORS-40C	20.87	20.87	32.28	17.5	n/a	n/a	17				
COR2-41S	23.23	20.87	32.28	17.5	26.75	21.25	17	33 16	57 17	83 18	106 20
COR2-41C	23.23	20.87	32.28	17.5	26.75	21.25	17				
COR2-50S	20.87	20.87	32.28	17.5	n/a	n/a	17	29 16	48 17	69 18	89 20
COR2-50C	20.87	20.87	32.28	17.5	n/a	n/a	17				
COR2-51S	23.23	20.87	32.28	17.5	26.75	21.25	17	32 16	54 17	77 18	99 20
COR2-51C	23.23	20.87	32.28	17.5	26.75	21.25	17				
COR2-60S	20.87	20.87	32.28	17.5	n/a	n/a	17	31 16	52 17	75 18	97 20
COR2-60C	20.87	20.87	32.28	17.5	n/a	n/a	17				
COR2-61S	23.23	20.87	32.28	17.5	26.75	21.25	17	33 16	57 17	82 18	106 20
COR2-61C	23.23	20.87	32.28	17.5	26.75	21.25	17				
COR6	24	31	15.75								

COM REQUIREMENTS

	COM Yardage Seat Pad Only	Yardage Per Chair - Seat Pad Only	COM Yardage Fully Upholstered Seat Only	Yardage Per Chair - Fully Upholstered Seat Only	COM Yardage Seat & Back Pads	Yardage Per Chair - Seat & Back Pads	COM Yardage Fully Upholstered Seat & Back	Yardage Per Chair - Fully Upholstered Seat & Back
One Chair	0.7	0.7	0.7	0.7	0.7	0.7	1	1
Two Chair	0.7	0.35	0.7	0.35	1.1	0.55	1.7	0.85
Three Chair	1.4	0.47	1.4	0.47	1.8	0.6	2.7	0.9
Four Chair	1.4	0.35	1.4	0.35	2.2	0.55	3.4	0.85

Note: Some vinyls, leathers & upholsteries are not suitable on Corfu seating.





The approval process is as follows:

1. A sample of the COM must be provided to Krug Customer Service prior to or at the time of order.
2. The sample will be reviewed and the customer advised if the upholstery cover is unsuitable.
3. The COM upholstery cover or leather will be inspected when received at the factory, to identify any further concerns with its suitability.

WEIGHT CAPACITY

Corfu has been tested and complies with ANSI/BIFMA x5.1-2011 standards. Corfu has been load tested up to 350lbs.

CORFU | MULTI-PURPOSE SEATING

DESCRIPTION/MODEL	COM 1	2	COL 3	4	FABRIC GRADES 5	6	7	LEATHER 8	9	
	Plastic Seat & Back, Armless, with Silver Metallic Frame COR2-10S	491								
	Plastic Seat & Back, Armless, with Polished Chrome Frame COR2-10C	556								
	Plastic Seat & Back, Plastic Arms, with Silver Metallic Frame COR2-11S	569								
	Plastic Seat & Back, Polished Aluminum Arms, with Polished Chrome Frame COR2-11C	624								
	Plastic Seat & Back with Upholstered Pads, Armless, with Silver Metallic Frame COR2-20S	658	693	727	761	796	832	866	900	935
	Plastic Seat & Back with Upholstered Pads, Armless, with Polished Chrome Frame COR2-20C	721	756	789	823	859	894	929	961	999
	Plastic Seat & Back with Upholstered Pads, Plastic Arms, with Silver Metallic Frame COR2-21S	737	769	806	840	875	910	943	979	1015
	Plastic Seat & Back with Upholstered Pads, Polished Aluminum Arms, with Polished Chrome Frame COR2-21C	791	827	861	895	930	963	1001	1034	1067

ORDERING NOTES:

When ordering the Silver Metallic frame with Plastic Seat and Back, the arm color matches the seat and back. When ordering the Polished Chrome frame, arms are Polished Aluminum. Corfu (Plastic Seat & Back) is available in six different colors. Please specify a color when ordering.

Color Selection: White, Black, Grey, Red, Blue, Sand







Corfu Option Upcharges

	\$ List	\$ List
CAL 133 & Moisture Barrier (per yard)	64	Ganging Bracket
Combination Upholstery - dual fabrics (per chair)	33	33

PRODUCT CODE KEY

Line	Series	Chair Style	Arm Style	Frame Finish
COR	2 Multi-Purpose (stacking)	1 Plastic Seat & Back	0 Armless	S Silver Metallic
		2 Plastic with Upholstered Seat & Back Pads	1 Arms	C Polished Chrome
		3 Wood Seat & Back		
		4 Fully Upholstered Seat & Back		
		5 Plastic Back, Plastic Seat with Upholstered Pad		
		6 Wood Back, Fully Upholstered Seat		

CORFU | MULTI-PURPOSE SEATING

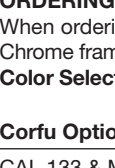
DESCRIPTION/MODEL	SPECIES	COM		COL		FABRIC GRADES			LEATHER		
		1	2	3	4	5	6	7	8	9	
											
	Plastic Back, Plastic Seat with Upholstered Pad, Armless, with Silver Metallic Frame COR2-50S			610	633	658	679	705	729	752	777
											
	Plastic Back, Plastic Seat with Upholstered Pad, Armless, with Polished Chrome Frame COR2-50C			673	696	721	743	767	791	815	838
											
	Plastic Back, Plastic Seat with Upholstered Pad, Plastic Arms with Silver Metallic Frame COR2-51S			689	711	737	760	783	807	832	853
											
	Plastic Back, Plastic Seat with Upholstered Pad, Polished Aluminum Arms, with Polished Chrome Frame COR2-51C			743	767	791	815	838	864	886	910
											
	Wood Seat & Back, Armless, with Silver Metallic Frame COR2-30S Beech			711							
											
	Wood Seat & Back, Armless, with Polished Chrome Frame COR2-30C Beech			783							
											
	Wood Seat & Back, Silver Metallic Arms, with Silver Metallic Frame COR2-31S Beech			853							
											
	Wood Seat & Back, Polished Aluminum Arms, with Polished Chrome Frame COR2-31C Beech			941							

ORDERING NOTES:





When ordering the Silver Metallic frame with Plastic Seat and Back, the arm color matches the seat and back. When ordering the Polished Chrome frame, arms are Polished Aluminum. Corfu (Plastic Seat & Back) is available in six different colors. Please specify a color when ordering.
Color Selection: White, Black, Grey, Red, Blue, Sand

Corfu Option Upcharges	\$ List	\$ List
CAL 133 & Moisture Barrier (per yard)	64	Ganging Bracket 33
Combination Upholstery - dual fabrics (per chair)	33	

PRODUCT CODE KEY

Line	Series	Chair Style	Arm Style	Frame Finish
COR	2 Multi-Purpose (stacking)	1 Plastic Seat & Back	0 Armless	S Silver Metallic
		2 Plastic with Upholstered Seat & Back Pads	1 Arms	C Polished Chrome
		3 Wood Seat & Back		
		4 Fully Upholstered Seat & Back		
		5 Plastic Back, Plastic Seat with Upholstered Pad		
		6 Wood Back, Fully Upholstered Seat		

CORFU | MULTI-PURPOSE SEATING

DESCRIPTION/MODEL	SPECIES	COM		COL		FABRIC GRADES		LEATHER			
		1	2	3	4	5	6	7	8	9	
	Wood Back, Fully Upholstered Seat, Armless, with Silver Metallic Frame COR2-60S	Beech	777	809	845	879	914	952	984	1018	1054
	Wood Back, Fully Upholstered Seat, Armless, with Polished Chrome Frame COR2-60C	Beech	846	882	915	953	985	1019	1056	1090	1124
	Wood Back, Fully Upholstered Seat, Silver Metallic Arms, with Silver Metallic Frame COR2-61S	Beech	916	954	987	1021	1058	1092	1126	1162	1195
	Wood Back, Fully Upholstered Seat, Polished Aluminum arms, with Polished Chrome Frame COR2-61C	Beech	1004	1038	1073	1109	1142	1178	1213	1247	1283
	Fully Upholstered Seat & Back, Armless, with Silver Metallic Frame COR2-40S		807	853	901	952	997	1044	1092	1139	1187
	Fully Upholstered Seat & Back, Armless, with Polished Chrome Frame COR2-40C		878	927	974	1019	1066	1116	1163	1209	1257
	Fully Upholstered Seat & Back, Silver Metallic Arms, with Silver Metallic Frame COR2-41S		952	997	1044	1092	1139	1187	1232	1282	1330
	Fully Upholstered Seat & Back, Polished Aluminum Arms, with Polished Chrome Frame COR2-41C		1036	1084	1131	1178	1226	1273	1319	1370	1416
	Caddie DOL6		838								

ORDERING NOTES:

When ordering the Silver Metallic frame with Plastic Seat and Back, the arm color matches the seat and back. When ordering the Polished Chrome frame, arms are Polished Aluminum. Corfu (Plastic Seat & Back) is available in six different colors. Please specify a color when ordering.
Color Selection: White, Black, Grey, Red, Blue, Sand

Corfu Option Upcharges	\$ List	\$ List
CAL 133 & Moisture Barrier (per yard)	64	Ganging Bracket
Combination Upholstery - dual fabrics (per chair)	33	33

PRODUCT CODE KEY

Line	Series	Chair Style	Arm Style	Frame Finish
COR	2 Multi-Purpose (stacking)	1 Plastic Seat & Back	0 Armless	S Silver Metallic
		2 Plastic with Upholstered Seat & Back Pads	1 Arms	C Polished Chrome
		3 Wood Seat & Back		
		4 Fully Upholstered Seat & Back		
		5 Plastic Back, Plastic Seat with Upholstered Pad		
		6 Wood Back, Fully Upholstered Seat		

PATIENT SEATING

- 57 Cressida
- 60 Solis
- 65 Faeron Wood
- 69 Faeron Metal
- 73 Jordan

CRESSIDA | ENVIRONMENTAL SUMMARY

LEED CI CREDITS



MATERIAL CONTENT:

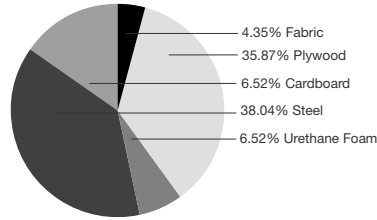

PRE-CONSUMER
RECYCLED CONTENT = 6.66%

POST-CONSUMER
RECYCLED CONTENT = 22.07%

Up to 53.26% of this Cressida product is recyclable at the end of its useful life.

	CONTRIBUTES TO	
CREDIT 2.1 - 2.2	Construction Waste Management	1-2 point(s)
CREDIT 3.3	Resource Reuse	1 point
CREDIT 4.1	Recycled Content	1 point
CREDIT 4.2	Recycled Content	1 point
CREDIT 4.5	Low Emitting Materials, Systems & Seating	1 point
CREDIT 5.1	Regional Materials*	1 point
CREDIT 7	Certified Wood (MUST BE REQUESTED)	1 point(s)

*This credit is only applicable if in total 20% of the combined value of the procurement of construction materials and in the furniture are manufactured within a radius of 500 miles. This credit will apply if the installation of the finished product occurs within 500 miles of Kitchener, Ontario.

level® CERTIFICATION, AIR EMISSIONS AND FSC® CERTIFICATION



level® CERTIFICATION

BIFMA's e3 Furniture Sustainability Standard is a voluntary, multi-attribute standard that measures the degree of sustainability of furniture. This standard evaluates product and company environmental attributes and compliance systems in a wide range of elements which include Materials, Energy & Atmosphere, Human & Ecosystem Health and Social Responsibility. Cressida products have earned level®, BIFMA's sustainability certification program for furniture, certification through third-party verification against the e3 standard.

AIR-EMISSIONS

All Cressida products are supplied with air-emissions certified. Contact customer service for information.



FSC®

In 2005, Krug received Forest Stewardship Council® (FSC®) Chain-of-Custody certification for our manufacturing facilities. The FSC® Chain-of-Custody tracks certified wood from seedling to final sale. It verifies that the material for our FSC® certified products only come from well-managed, FSC®-certified forests and other controlled sources. FSC® is dedicated to the promotion of responsible forest management worldwide helping to take care of forests for future generations. Cressida and other Krug products can be specified with FSC® Certification. Contact customer service for further information, pricing and lead times.



Architects, designers, and building professionals can specify FSC®-certified products in order to achieve a point from the U.S. Green Building Council's Leadership in Energy and Environmental Design (LEED) Rating System.

DIMENSIONS & COM REQUIREMENTS

	Overall Width	Overall Depth	Overall Height	Seat Height	Height of Arms from Floor	Width Between Arms	Seat Depth	Shipping Weight	Cube
21" Seat	24.5	28.5	43.5	18.5	26	21	18.75	45	17
24" Seat	27.5	28.5	43.5	18.5	26	24	18.75	51	22
30" Seat	33.5	28.5	43.5	18.5	26	30	18.75	60	28

COM - YARDAGE REQUIREMENTS

	COM Yardage Seats & Backs Only	COM Yardage Seat Only	COM Yardage Back Only	COM Yardage Closed Arm Panel
21" - One Chair	2.2	0.95	1.25	.8
21" - Two Chairs	4.25	1.3	2.95	.8
21" - Three Chairs	6.45	2.25	4.2	.8
21" - Four Chairs	8.5	4.6	3.9	.8
24" - One Chair	2.1	0.8	1.95	.8
24" - Two Chairs	4.14	1.19	2.95	.8
24" - Three Chairs	6.45	2	4.9	.8
24" - Four Chairs	8.28	2.38	5.9	.8
30" Plus - One Chair	3.15	1.2	1.95	.8
30" Plus - Two Chairs	6.3	2.4	3.9	.8
30" Plus - Three Chairs	9.21	3.6	5.85	.8
30" Plus - Four Chairs	12.6	4.8	7.8	.8

Note: Some vinyls, leathers & upholsteries are not suitable for application on Cressida seating.

The approval process is as follows:

1. A sample of the COM must be provided to Krug Customer Service prior to or at the time of order.
2. The sample will be reviewed and the customer advised if the fabric is unsuitable.
3. The COM fabric or leather will be inspected when received at the factory, to identify any further concerns with its suitability.

WEIGHT CAPACITIES

Cressida weight capacities are as follows:

Patient Chairs (21" & 24") - 350 lbs

Patient Plus Chair (30") - 750 lbs







Cressida Option Upcharges	\$ List
Moisture Barrier (per yard)	64
Removable Seat Cover (per seat)	85
Patient Removeable 21" & 24" Back Covers (per back)	85
Patient Removeable 30" Back Covers (per back)	142
Combination Upholstery - dual fabrics (per chair)	33
Combination Upholstery - Three fabrics (per chair)	64
21" & 24" Cleanable Under-Seat Splashguard	59
30" Cleanable Under-Seat Splashguard	67

Additional features and options information see page 19.

ORDERING NOTES:

Replacement seat and back covers can be quickly installed on Cressida products that were originally ordered with the Removeable cover option. Replacement seat and back covers can also be installed on Cressida products that were not originally ordered with the Removeable cover option, with some simple staple removal on the original seats and backs.

CRESSIDA | PATIENT

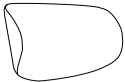
DESCRIPTION	MODEL	SPECIES	COM		COL			FABRIC GRADES			LEATHER		
			1	2	3	4	5	6	7	8	9		
	21" Open Arm CRE2-P21OPS	Beech, Maple	1137	1207	1272	1411	1547	1624	1815	1953	2219		
	21" Open Arm with arm cap CRE2-P21OPP	Beech, Maple	1158	1230	1295	1433	1568	1646	1837	1976	2241		
	21" Closed Arm CRE2-P21CLS	Beech, Maple	1421	1535	1624	1798	1977	2143	2322	2508	2829		
	21" Closed Arm with arm cap CRE2-P21CLP	Beech, Maple	1445	1558	1646	1819	1998	2166	2345	2532	2852		
	24" Open Arm CRE2-P24OPS	Beech, Maple	1194	1266	1331	1466	1606	1735	1871	2010	2278		
	24" Open Arm with arm cap CRE2-P24OPP	Beech, Maple	1215	1288	1354	1488	1629	1756	1894	2031	2299		
	24" Closed Arm CRE2-P24CLS	Beech, Maple	1480	1592	1683	1857	2034	2198	2381	2567	2886		
	24" Closed Arm with arm cap CRE2-P24CLP	Beech, Maple	1503	1615	1705	1880	2058	2221	2403	2590	2910		
	30" Open Arm CRE2-P30OPS	Beech, Maple	1417	1512	1609	1781	1982	2164	2347	2549	2896		
	30" Open Arm with arm cap CRE2-P30OPP	Beech, Maple	1440	1535	1632	1806	2004	2186	2346	2569	2920		
	30" Closed Arm CRE2-P30CLS	Beech, Maple	1704	1839	1932	2170	2411	2629	2854	3104	3507		
	30" Closed Arm with arm cap CRE2-P30CLP	Beech, Maple	1727	1861	1955	2194	2433	2650	2879	3129	3530		
DESCRIPTION	MODEL	COM		COL		FABRIC GRADES			LEATHER			WEIGHT	CUBE
		1	2	3	4	5	6	7	8	9			
	Adjustable Headrest for 21", 24" & 30" CRE2-RH	159	172	187	208	231	253	273	295	338	3	0.9	

Additional features and options information see page 19. Option upcharges page 58.

PRODUCT CODE KEY

Line	Series	Chair Style	Size	Arm Style
CRE Cressida	2 Chair	P Patient	21	OPS Open Arm
			24	OPP Open Arm Polymer Arm Cap
			30	CLS Closed Arm
			44	CLP Closed Arm Polymer Arm Cap

LEED CI CREDITS



MATERIAL CONTENT:

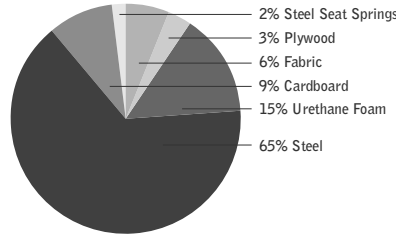

PRE-CONSUMER
RECYCLED CONTENT = 17%

POST-CONSUMER
RECYCLE CONTENT = 22%

	CONTRIBUTES TO	
CREDIT 2.1 - 2.2	Construction Waste Management	1-2 point(s)
CREDIT 3.3	Resource Reuse	1 point
CREDIT 4.1	Recycled Content	1 point
CREDIT 4.2	Recycled Content	1 point
CREDIT 4.5	Low Emitting Materials, Systems & Seating	1 point
CREDIT 5.1	Regional Materials*	1 point
CREDIT 7	Certified Wood (MUST BE REQUESTED)	1 point(s)

*This credit is only applicable if in total 20% of the combined value of the procurement of construction materials and in the furniture are manufactured within a radius of 500 miles. This credit will apply if the installation of the finished product occurs within 500 miles of Kitchener, Ontario.

level® CERTIFICATION, AIR EMISSIONS AND FSC® CERTIFICATION



level® CERTIFICATION

BIFMA's e3 Furniture Sustainability Standard is a voluntary, multi-attribute standard that measures the degree of sustainability of furniture. This standard evaluates product and company environmental attributes and compliance systems in a wide range of elements which include Materials, Energy & Atmosphere, Human & Ecosystem Health and Social Responsibility. Solis products have earned level®, BIFMA's sustainability certification program for furniture, certification through third-party verification against the e3 standard.

AIR-EMISSIONS

All Solis products are supplied with air-emissions certified. Contact customer service for information.



FSC®

In 2005, Krug received Forest Stewardship Council® (FSC®) Chain-of-Custody certification for our manufacturing facilities. The FSC® Chain-of-Custody tracks certified wood from seedling to final sale. It verifies that the material for our FSC® certified products only come from well-managed, FSC®-certified forests and other controlled sources. FSC® is dedicated to the promotion of responsible forest management worldwide helping to take care of forests for future generations. Solis and other Krug products can be specified with FSC® Certification. Contact customer service for further information, pricing and lead times.



Architects, designers, and building professionals can specify FSC®-certified products in order to achieve a point from the U.S. Green Building Council's Leadership in Energy and Environmental Design (LEED) Rating System.

SOLIS | PATIENT, DIMENSIONS & COM REQUIREMENTS

DIMENSIONS & COM. REQUIREMENTS

	Overall Width	Overall Depth	Overall Height	Seat Height	Height of Arms from Floor	Width Between Arms	Seat Depth	Shipping Weight	Cubes	COM Yardage Seat & Back	COM Yardage Seat	COM Yardage Back	COM Yardage Closed Arm Panel
UPHOLSTERED BACK													
21" Seat	25	28	43.75	18.5	26	20	20	54	21	2.1	0.9	2.0	0.8
24" Seat	28	28	43.75	18.5	26	23	20	58	23	2.1	0.9	2.0	0.8
30" Seat	34	28	43.75	18.5	26	29	20	64	28	3.1	0.9	2.2	0.8
MESH BACK													
21" Seat	25	28	43.75	18.5	26	20	20	50	21	-	0.9	-	0.8
24" Seat	28	28	43.75	18.5	26	23	20	53	23	-	0.9	-	0.8

COM - YARDAGE REQUIREMENTS

	Yardage Seat & Back	Yardage Seat	Yardage Back	Yardage Closed Arm Panel
21" & 24" - One Chair	2.1	0.9	2	0.8
21" & 24" - Two Chairs	4	1.3	3.1	1.2
21" & 24" - Three Chairs	6.1	2.1	4.2	1.6
30" - One Chair	3.1	0.9	2.2	0.8
30" - Two Chairs	6.2	1.8	4.4	1.2
30" - Three Chairs	9.3	2.6	6.6	1.6

Multiple yardage requirements can also be used for Patient Back Easy Access chairs and Patient Back Start, Center, End Multiple seating.

Note: Some vinyls, leathers & fabrics may not be suitable for application on Solis seating.

The approval process is as follows:

1. A sample of the COM. must be provided to Krug Customer Service prior to or at the time of order. For Maharam, Momentum or CF Stinson, Krug will obtain the fabric sample.
2. The sample will be reviewed and the customer advised if the fabric is unsuitable.
3. The COM. fabric or leather will be inspected when received at the factory, to identify any further concerns with its suitability.

SOLIS | PATIENT | UPHOLSTERED BACK



Solis Patient Chairs with Upholstered Backs are available in 21", 24" and 30" widths.

SOLIS | PATIENT | MESH BACK







Solis Patient Chairs with Mesh Backs are available in 21" and 24" widths only.



ORDERING NOTES: Complete Mesh backs (21" & 24") can be ordered and field replaced. The standard **Solis Frame Color** is Silver Metallic. Additional frame colors are available for an upcharge of **\$64 list** per arm frame pair, please see page 24 for color selection. Silver Metallic frames are available with an anti-microbial finish for an upcharge of **\$64 list** per arm frame pair or table.

Closed Arm Panels (per chair) - please add the following up charges for closed arm panels.

Fabric Grades	(COM) 1	2	(COL) 3	4	5	6	7	8	9
2 ARMS	418	448	477	531	588	643	699	757	869

[View Solis images | www.krug.ca](http://www.krug.ca)

DESCRIPTION/MODEL	Arm Type	COM		COL		FABRIC GRADES			LEATHER			
		1	2	3	4	5	6	7	8	9		
	21" Open Arm, Mesh Back											
	SOL2-PM21OPU Urethane	1107	1139	1171	1239	1306	1372	1438	1504	1607		
	SOL2-PM21OPW Beech	1231	1266	1298	1363	1431	1497	1563	1632	1732		
	21" Open Arm, Upholstered Back											
	SOL2-PU21OPU Urethane	1163	1231	1304	1445	1584	1727	1863	2004	2285		
	SOL2-PU21OPW Beech	1289	1358	1430	1569	1709	1853	1990	2132	2412		
	24" Open Arm, Mesh Back											
	SOL2-PM24OPU Urethane	1143	1178	1212	1279	1345	1411	1479	1543	1645		
	SOL2-PM24OPW Beech	1271	1306	1338	1404	1468	1537	1604	1669	1773		
	24" Open Arm, Upholstered Back											
	SOL2-PU24OPU Urethane	1203	1275	1345	1484	1624	1765	1908	2048	2328		
	SOL2-PU24OPW Beech	1331	1402	1468	1611	1752	1892	2033	2173	2457		
	30" Open Arm, Upholstered Back											
	SOL2-PU30OPU Urethane	1494	1598	1702	1909	2117	2324	2531	2740	3155		
	SOL2-PU30OPW Beech	1620	1727	1827	2034	2242	2451	2658	2864	3280		

DESCRIPTION/MODEL	COM.		COL	FABRIC GRADES			LEATHER			W	D	H	Weight	Cubes	
	1	2	3	4	5	6	7	8	9						
	Ottoman														
	SOL5	532	555	573	618	661	702	744	786	873	18.25	18.25	13	12	5
Fabric Yardage Required: 1 ottoman = 0.7 yards 2 ottoman = 1 yards															
	Easy Clean Backrest Cover, Mesh Back														
	SOL2-BCM21	111	121	129	151	170	193	213	231	257	20	0.5	8	3	0.9
	SOL2-BCM24	111	121	129	151	170	193	213	231	257	23	0.5	8	3	0.9
	Easy Clean Backrest Cover, Upholstered Back														
SOL2-BCU21	111	121	129	151	170	193	213	231	257	20	0.5	8	3	0.9	
SOL2-BCU24	111	121	129	151	170	193	213	231	257	23	0.5	8	3	0.9	
	Adjustable Headrest														
	SOL2-HRM	173	190	205	231	255	278	301	326	372	15	3	6.75	3	0.9
	SOL2-HRU	173	190	205	231	255	278	301	326	372					
Adjustable headrest are one size and can be used on all Patient Chair models.															
Fabric Yardage Required: 1 headrest = 0.3 yards 2 headrest = 0.6 yards 3 headrest = 0.6 yards															

Solis Patient Option Upcharges





	\$ List	\$ List	
CAL 133 & Moisture Barrier (per yard)	64	Solid Surface Arm (per pair) - Gr A White	488
Removable Seat Cover (per seat)	90	Solid Surface Arm (per pair) - Gr A Color	505
21" & 24" - Removeable Back Covers (per back)	58	Solid Surface Arm (per pair) - Gr B	542
30" Removable Back Cover (per back)	90	Solid Surface Arm (per pair) - Gr C	586
21" & 24" Cleanable Under-seat Splashguard	40	Maple Arm upgrade per arm (add to beech price)	80
30" Cleanable Under-seat Splashguard	48	Beech Wood Side Rails Upgrade (per chair)	127
Soft Casters (21" & 24" chairs) -4 set	64	Maple wood Side Rails Upgrade (per chair)	159
Soft Casters (21" & 24" chairs) -2 set	33	Kinetic Back option (not available for 30" & 44")	120
Non-locking Casters (21" & 24" chairs) -4 set	120	Non-Marring Glide	37
Non-locking Casters (21" & 24" chairs) -2 set	80	Combination Upholstery - dual fabrics (per chair)	33
Note: Locking casters are available, clearly mark on the purchase order.		Combination Upholstery - Three fabrics (per chair)	64

Additional features and options information see page 24. Closed arm panel upcharges page 61.



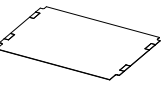
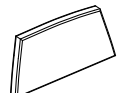

PRODUCT CODE KEY

Line	Series	Chair Type	Back Type	Size	Arm Type
SOL	2	P	U	21	OPW CLW
Solis	Chair	Patient Seating	Upholstered Back		Open Arm - Wood Arm Closed Arm - Wood Arm
			M	24	OPU CLU
			Mesh Back 21" & 24" Only		Open Arm - Urethane Arm Closed Arm - Urethane Arm
				30	OSA CSA
					Open Arm - Solid Surface Arm Closed Arm - Solid Surface Arm

SOLIS | REPLACEMENT COMPONENTS

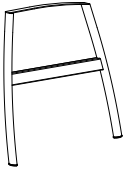
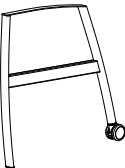
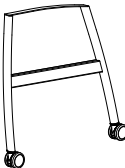
Description	Model	COM		COL			FABRIC GRADES			LEATHER			Yardage	Weight	Cube
		1	2	3	4	5	6	7	8	9					
	21" Replacement Patient Upholstered Backs SOL2-RBPU21	673	732	793	877	973	1058	1152	1272	1393	2.0	21	3.8		
	21" Replacement Patient Mesh Backs SOL2-RBPM21	451										15	3.8		
	24" Replacement Patient Upholstered Backs SOL2-RBPU24	711	771	832	915	1012	1095	1192	1312	1433	2.0	21	3.8		
	24" Replacement Patient Mesh Backs SOL2-RBPM24	517										17	3.8		
	30" Replacement Patient Upholstered Backs SOL2-RBPU30	857	937	1015	1122	1247	1358	1483	1640	1794	2.6	24	4.8		
	21" Replacement Patient Upholstered Back Cover SOL2-RBCPU21	253	312	372	456	554	636	732	852	973	2.0	2.5	.8		
	24" Replacement Patient Upholstered Back Cover SOL2-RBCPU24	254	313	374	457	555	637	733	853	974	2.0	2.7	.8		
	30" Replacement Patient Upholstered Back Cover SOL2-RBCPU30	306	386	464	571	697	807	932	1088	1244	2.6	3	.8		
	Replacement Mesh Back Top Bar SOL2-RMBTB21	33										2.5	.5		
	SOL2-RMBTB24	34										3.0	.7		
	21" Replacement Seat SOL2-RS21	389	418	443	481	523	561	605	659	715	.9	9	2.7		
	24" Replacement Seat SOL2-RS24	409	436	464	501	543	583	626	679	733	.9	10	2.7		
	30" Replacement Seat SOL2-RS30	487	513	540	577	620	659	702	756	809	.9	12	3.4		
	44" Replacement Seat SOL2-RS44	628	662	694	740	793	840	892	958	1022	.9	14	4.8		
	21" Replacement Seat Cover SOL2-RSC21	130	159	185	223	267	304	374	403	455	1.0	1.6	.8		
	24" Replacement Seat Cover SOL2-RSC24	134	160	189	227	270	306	350	405	458	1.0	1.7	.8		
	30" Replacement Seat Cover SOL2-RSC30	136	161	189	227	270	306	350	405	458	1.0	2	.8		
	44" Replacement Seat Cover SOL2-RSC44	152	186	218	265	318	363	416	483	547	1.0	2.5	.8		
	Replacement Splash Guard SOL2-RSG21	90										1	.3		
	SOL2-RSG24	110										2	.4		
	SOL2-RSG30	154										3	.5		
	SOL2-RSG44	166										4	.6		
	Replacement Closed Arm SOL2-RCA	207	218	231	247	267	283	303	327	350	0.4	6	.9		

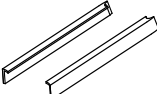
SOLIS | REPLACEMENT COMPONENTS

DESCRIPTION/MODEL	Price	Weight	Cube		
	Replacement Side Frame - Start				
	SOL2-RSFS	134	9 1.5		
	Replacement Side Frame - Start - No Anti-Microbial				
	SOL2-RSFSX	111	9 1.5		
	Replacement Side Frame - End				
SOL2-RSFE	134	9 1.5			
Replacement Side Frame - End - No Anti-Microbial					
SOL2-RSFEX	111	9 1.5			
	Replacement Side Frame - Start - 1 Glide, 1 Caster				
	SOL2-RSFSC	172	9.5 1.5		
	Replacement Side Frame - Start - 1 Glide, 1 Caster- No Anti-Microbial				
	SOL2-RSFSCX	138	9.5 1.5		
	Replacement Side Frame - End - 1 Glide, 1 Caster				
	SOL2-RSFEC	172	9.5 1.5		
Replacement Side Frame - End - 1 Glide, 1 Caster- No Anti-Microbial					
SOL2-RSFECX	138	9.5 1.5			
	Replacement Side Frame - Start - 2 Caster				
	SOL2-RSFSC2	149	10 1.5		
	Replacement Side Frame - Start - 2 Caster- No Anti-Microbial				
	SOL2-RSFSC2X	145	10 1.5		
	Replacement Side Frame - End - 2 Caster				
	SOL2-RSFEC2	149	10 1.5		
Replacement Side Frame - End - 2 Caster- No Anti-Microbial					
SOL2-RSFEC2X	145	10 1.5			
	Replacement Arm Cap - Urethane				
	SOL2-RACU	70	1.0 .2		
	Replacement Arm Cap - Beech				
	SOL2-RACWB	213	1.0 .2		
	Replacement Arm Cap - Maple				
SOL2-RACWM	229	1.0 .2			
Replacement Arm Cap - Solid Surface	Grade	Grade	Grade- B	Grade- C	
SOL2-RACSS	A- White 256	A- Color 261	282	304	2 .2
	Replacement Wood Side Rail Cover - Beech				
	SOL2-RSRCB	180	1.0 .3		
	Replacement Wood Side Rail Cover - Maple				
SOL2-RSRCM	231	1.0 .3			
	Replacement Glide - Front				
	SOL2-RGF	22	.5 .1		
	Replacement Glide - Back				
	SOL2-RGB	22	.5 .1		
	Replacement Glide - Set of 4				
	SOL2-RGS4	24	2 .1		
	Replacement Caster Glide - Front				
	SOL2-RGFC	23	2 .1		
Replacement Caster Glide - Back					
SOL2-RGBC	23	2 .1			
	Replacement Caster - Hard Wheel				
	SOL2 - RCH	30	1.5 .3		
	Replacement Caster - Soft Wheel				
SOL2 - RCS	33	1.5 .3			

FAERON WOOD | ENVIRONMENTAL SUMMARY

LEED CI CREDITS



MATERIAL CONTENT:

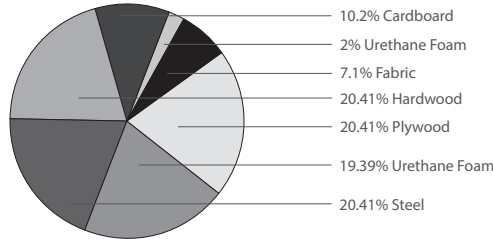

PRE-CONSUMER
RECYCLED CONTENT = 5.61%

POST-CONSUMER
RECYCLED CONTENT = 14.18%

Up to 33.61% of this Faeron product is recyclable at the end of its useful life.

CONTRIBUTES TO

CREDIT	CONTRIBUTES TO	POINTS
CREDIT 2.1 - 2.2	Construction Waste Management	1-2 point(s)
CREDIT 3.3	Resource Reuse	1 point
CREDIT 4.1	Recycled Content	1 point
CREDIT 4.5	Low Emitting Materials, Systems & Seating	1 point
CREDIT 5.1	Regional Materials*	1 point
CREDIT 7	Certified Wood (MUST BE REQUESTED)	1 point(s)

*This credit is only applicable if in total 20% of the combined value of the procurement of construction materials and in the furniture are manufactured within a radius of 500 miles. This credit will apply if the installation of the finished product occurs within 500 miles of Kitchener, Ontario.

level® CERTIFICATION, AIR EMISSIONS AND FSC® CERTIFICATION



level® CERTIFICATION

BIFMA's e3 Furniture Sustainability Standard is a voluntary, multi-attribute standard that measures the degree of sustainability of furniture. This standard evaluates product and company environmental attributes and compliance systems in a wide range of elements which include Materials, Energy & Atmosphere, Human & Ecosystem Health and Social Responsibility. Faeron products have earned level®, BIFMA's sustainability certification program for furniture, certification through third-party verification against the e3 standard.

AIR-EMISSIONS

All Faeron products are supplied with air-emissions certified. Contact customer service for information.



FSC®

In 2005, Krug received Forest Stewardship Council® (FSC®) Chain-of-Custody certification for our manufacturing facilities. The FSC® Chain-of-Custody tracks certified wood from seedling to final sale. It verifies that the material for our FSC® certified products only come from well-managed, FSC®-certified forests and other controlled sources. FSC® is dedicated to the promotion of responsible forest management worldwide helping to take care of forests for future generations. Faeron and other Krug products can be specified with FSC® Certification. Contact customer service for further information, pricing and lead times.



Architects, designers, and building professionals can specify FSC®-certified products in order to achieve a point from the U.S. Green Building Council's Leadership in Energy and Environmental Design (LEED) Rating System.

DIMENSIONS & COM REQUIREMENTS

	Overall Width	Overall Depth	Overall Height	Seat Height	Height of Arms from Floor	Width Between Arms	Seat Depth	Shipping Weight	Cubes
21" Seat	25.0	26.3	45.0	19.0	25	21	19.5	49	17
24" Seat	28.0	26.3	45.0	19.0	25	24	19.5	53	22
30" Seat	34.0	26.3	45.0	19.0	25	30	19.5	64	28

COM - YARDAGE REQUIREMENTS

	COM Yardage Seats & Backs Only	COM Yardage Seat Only	COM Yardage Back Only	COM Yardage Closed Arm Panel
21" & 24" - One Chair	2.0	0.9	2.0	0.8
30" Plus - One Chair	3.0	0.9	2.0	0.8

Note: Some vinyls, leathers & upholsteries are not suitable for application on Faeron seating.

The approval process is as follows:

1. A sample of the COM must be provided to Krug Customer Service prior to or at the time of order.
2. The sample will be reviewed and the customer advised if the fabric is unsuitable.
3. The COM fabric or leather will be inspected when received at the factory, to identify any further concerns with its suitability.

Faeron Guest Option Upcharges

	\$ List		\$ List
CAL 133 & Moisture Barrier (per yard)	64	Solid Surface Arm Cap (per pair) - Gr A White	364
Ganging Bracket	58	Solid Surface Arm Cap (per pair) - Gr A Color	376
Kinetic Back (not available for Plus)	120	Solid Surface Arm Cap (per pair) - Gr B	396
21" & 24" Under-seat Splashguard	58	Solid Surface Arm Cap (per pair) - Gr C	410
30" Under-seat Splashguard	72	Solid Surface Arm (per pair) - Gr A White	573
Removeable Seat Cover	90	Solid Surface Arm (per pair) - Gr A Color	598
Removable Back Cover	58	Solid Surface Arm (per pair) - Gr B	645
Urethane Arm Cap (per pair)	138	Solid Surface Arm (per pair) - Gr C	678
Combination Upholstery - dual fabrics (per chair)	33		
Combination Upholstery - Three fabrics (per chair)	64		

Additional features and options information see page 31.





WEIGHT CAPACITIES

Faeron weight capacities are as follows:

Patient Chairs (21" & 24") - 500 lbs

Plus Chair (30") - 750 lbs

FAERON WOOD | PATIENT

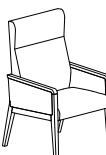
DESCRIPTION/MODEL	Species	COM		COL		FABRIC GRADES			LEATHER		
		1	2	3	4	5	6	7	8	9	
 21" Open Arm FAE2-P21ONC	Beech Palette	1318	1383	1446	1572	1699	1827	1954	2081	2333	
 21" Semi Closed Arm FAE2-P21SNC	Beech Palette	1773	1861	1951	2130	2304	2483	2660	2837	3192	
 21" Closed Arm FAE2-P21CNC	Beech Palette	1788	1875	1965	2143	2319	2496	2673	2851	3207	
 24" Open Arm FAE2-P24ONC	Beech Palette	1395	1459	1522	1647	1776	1902	2030	2157	2410	
 24" Semi Closed Arm FAE2-P24SNC	Beech Palette	1849	1938	2028	2205	2383	2559	2738	2913	3268	
 24" Closed Arm FAE2-P24CNC	Beech Palette	1862	1953	2040	2218	2396	2571	2748	2928	3283	

ORDERING NOTES: Faeron chairs can be specified with Urethane Arm Caps (UC), Solid Surface Arm Caps (SC) or Solid Surface Arm (SA), replace "NC" in the model number with the **Arm Style** selection below and add the upcharge listed on page 66.

PRODUCT CODE KEY

Line	Series	Chair Type	Size	Arm Type	Arm Style
FAE Faeron	2 Chair	P Patient Seating	21	O Open Arm	NC No Cap
			24	S Semi Closed Arm	UC Urethane Cap
			30	C Closed Arm	SC Solid Surface Cap
					SA Solid Surface Arm

FAERON WOOD | PATIENT

DESCRIPTION/MODEL	Species	COM		COL			FABRIC GRADES			LEATHER	
		1	2	3	4	5	6	7	8	9	
 30" Open Arm FAE2-P30ONC	Beech Palette	1613	1708	1803	1993	2185	2374	2564	2754	3135	
 30" Semi Closed Arm FAE2-P30SNC	Beech Palette	2065	2189	2307	2549	2789	3030	3270	3513	3994	
 30" Closed Arm FAE2-P30CNC	Beech Palette	2081	2201	2322	2563	2803	3043	3286	3528	4007	

ORDERING NOTES: Faeron chairs can be specified with Urethane Arm Caps (UC), Solid Surface Arm Caps (SC) or Solid Surface Arm (SA), replace "NC" in the model number with the **Arm Style** selection below and add the upcharge listed on page 66

PRODUCT CODE KEY

Line	Series	Chair Type	Size	Arm Type	Arm Style
FAE Faeron	2 Chair	P Patient Seating	21	O Open Arm	NC No Cap
			24	S Semi Closed Arm	UC Urethane Cap
			30	C Closed Arm	SC Solid Surface Cap
					SA Solid Surface Arm

FAERON METAL | ENVIRONMENTAL SUMMARY

LEED CI CREDITS



MATERIAL CONTENT:

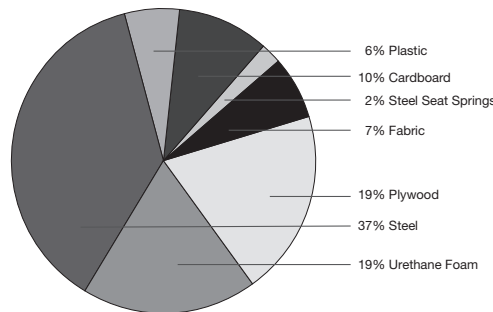

PRE-CONSUMER RECYCLED CONTENT = 9.80%

POST-CONSUMER RECYCLED CONTENT = 17.63%

Up to 47.06% of this Faeron Metal product is recyclable at the end of its useful life.

CONTRIBUTES TO

CREDIT 2.1 - 2.2	Construction Waste Management	1-2 point(s)
CREDIT 3.3	Resource Reuse	1 point
CREDIT 4.1	Recycled Content	1 point
CREDIT 4.2	Recycled Content	1 point
CREDIT 4.5	Low Emitting Materials, Systems & Seating	1 point
CREDIT 5.1	Regional Materials*	1 point
CREDIT 7	Certified Wood (MUST BE REQUESTED)	1 point(s)

*This credit is only applicable if in total 20% of the combined value of the procurement of construction materials and in the furniture are manufactured within a radius of 500 miles. This credit will apply if the installation of the finished product occurs within 500 miles of Kitchener, Ontario.

level® CERTIFICATION, AIR EMISSIONS AND FSC® CERTIFICATION



level® CERTIFICATION

BIFMA's e3 Furniture Sustainability Standard is a voluntary, multi-attribute standard that measures the degree of sustainability of furniture. This standard evaluates product and company environmental attributes and compliance systems in a wide range of elements which include Materials, Energy & Atmosphere, Human & Ecosystem Health and Social Responsibility. Faeron products have earned level®, BIFMA's sustainability certification program for furniture, certification through third-party verification against the e3 standard.

AIR-EMISSIONS

All Faeron products are supplied with air-emissions certified. Contact customer service for information.



FSC®

In 2005, Krug received Forest Stewardship Council® (FSC®) Chain-of-Custody certification for our manufacturing facilities. The FSC® Chain-of-Custody tracks certified wood from seedling to final sale. It verifies that the material for our FSC® certified products only come from well-managed, FSC®-certified forests and other controlled sources. FSC® is dedicated to the promotion of responsible forest management worldwide helping to take care of forests for future generations. Faeron and other Krug products can be specified with FSC® Certification. Contact customer service for further information, pricing and lead times.



Architects, designers, and building professionals can specify FSC®-certified products in order to achieve a point from the U.S. Green Building Council's Leadership in Energy and Environmental Design (LEED) Rating System.

DIMENSIONS & COM REQUIREMENTS

	Overall Width	Overall Depth	Overall Height	Seat Height	Height of Arms from Floor	Width Between Arms	Seat Depth	Shipping Weight	Cubes
21" Seat	25.0	26.3	45.0	19.0	25	21	19.5	61	17
24" Seat	28.0	26.3	45.0	19.0	25	24	19.5	65	22
30" Seat	34.0	26.3	45.0	19.0	25	30	19.5	76	28

COM - YARDAGE REQUIREMENTS

	COM Yardage Seats & Backs Only	COM Yardage Seat Only	COM Yardage Back Only	COM Yardage Closed Arm Panel
21" & 24" - One Chair	2.0	0.9	2.0	0.96
30" Plus - One Chair	3.0	0.9	2.0	0.96

ORDERING NOTES:

The approval process is as follows:

1. A sample of the COM must be provided to Krug Customer Service prior to or at the time of order.
2. The sample will be reviewed and the customer advised if the fabric is unsuitable.
3. The COM fabric or leather will be inspected when received at the factory, to identify any further concerns with its suitability.

Note: Some vinyls, leathers & upholsteries are not suitable for application on Faeron Metal seating.

WEIGHT CAPACITIES

Faeron Metal weight capacities are as follows:













Patient Chairs (21" & 24") - 500 lbs

Patient Plus Chair (30") - 750 lbs

Faeron Metal Option Upcharges	\$ List		\$ List
CAL 133 & Moisture Barrier (per yard)	64	Solid Surface Arm (per pair) - Gr A White	573
Ganging Bracket	58	Solid Surface Arm (per pair) - Gr A Color	598
Kinetic Back (not available for Plus)	120	Solid Surface Arm (per pair) - Gr B	645
21" & 24" Under-seat Splashguard	58	Solid Surface Arm (per pair) - Gr C	678
30" Under-seat Splashguard	72	Beech/Palette Wood Arm (per pair)	215
Removeable Seat Cover	90		
Removable Back Cover	58		
Non-Marring Glides	16		
Combination Upholstery - dual fabrics (per chair)	33		
Combination Upholstery - Three fabrics (per chair)	64		

Additional features and options information see page 37.

FAERON METAL | PATIENT

DESCRIPTION/MODEL	COM		COL	FABRIC GRADES			LEATHER		
	1	2	3	4	5	6	7	8	9
	21" Open Polymer Arm, Silver Metallic Frame								
	FAE2M-P21OPAS	1185 1245	1306	1428	1547	1668	1790	1909	2151
	21" Open Polymer Arm, Brushed Nickel Frame								
	FAE2M-P21OPAN	1401 1461	1521	1642	1764	1883	2004	2124	2367
	21" Semi Closed Polymer Arm, Silver Metallic Frame								
	FAE2M-P21SPAS	1617 1702	1788	1956	2123	2294	2462	2631	2969
	21" Semi Closed Polymer Arm, Brushed Nickel Frame								
	FAE2M-P21SPAN	1833 1915	2002	2170	2340	2508	2678	2846	3185
	21" Closed Polymer Arm, Silver Metallic Frame								
	FAE2M-P21CPAS	1631 1714	1798	1968	2136	2306	2476	2642	2983
	21" Closed Polymer Arm, Brushed Nickel Frame								
	FAE2M-P21CPAN	1845 1929	2014	2185	2353	2522	2691	2859	3197
	24" Open Polymer Arm, Silver Metallic Frame								
	FAE2M-P24OPAS	1257 1317	1378	1499	1619	1741	1861	1982	2222
	24" Open Polymer Arm, Brushed Nickel Frame								
	FAE2M-P24OPAN	1473 1534	1593	1714	1835	1956	2077	2196	2438
	24" Semi Closed Polymer Arm, Silver Metallic Frame								
	FAE2M-P24SPAS	1689 1774	1858	2029	2196	2366	2535	2703	3040
	24" Semi Closed Polymer Arm, Brushed Nickel Frame								
	FAE2M-P24SPAN	1905 1989	2073	2242	2412	2581	2748	2920	3257
	24" Closed Polymer Arm, Silver Metallic Frame								
	FAE2M-P24CPAS	1703 1789	1871	2041	2211	2378	2548	2717	3055
	24" Closed Polymer Arm, Brushed Nickel Frame								
	FAE2M-P24CPAN	1918 2003	2087	2256	2427	2593	2763	2933	3269

ORDERING NOTES:

Faeron Metal chairs can also be specified with a Wood Arm (WA) or a Solid Surface Arm (SA), replace "PA" in the model number with the **Arm Style** selection below and add the upcharge listed.

Additional features and options information see page 37.

Arm Style Option Upcharges



\$ List

Solid Surface Arm (per pair) - Gr A White	573
Solid Surface Arm (per pair) - Gr A Color	598
Solid Surface Arm (per pair) - Gr B	645
Solid Surface Arm (per pair) - Gr C	678
Beech/Palette Wood Arm (per pair)	215

PRODUCT CODE KEY

Line	Series	Chair Type	Size	Arm Type	Arm Style	Metal Finish
FAE Faeron	2M Chair	P Patient Seating	21	O Open Arm	PA Polymer Arm	S Silver Metallic
			24	S Semi Closed Arm	WA Wood Arm	N Brushed Nickel
			30	C Closed Arm	SA Solid Surface Arm	

FAERON METAL | PATIENT

DESCRIPTION/MODEL	COM		COL	FABRIC GRADES			LEATHER				
	1	2	3	4	5	6	7	8	9		
	30" Open Polymer Arm, Silver Metallic Frame FAE2M-P30OPAS		1464	1556	1645	1827	2009	2190	2370	2552	2913
	30" Open Polymer Arm, Brushed Nickel Frame FAE2M-P30OPAN		1680	1771	1861	2042	2222	2405	2586	2767	3131
	30" Semi Closed Polymer Arm, Silver Metallic Frame FAE2M-P30SPAS		1897	2012	2126	2356	2585	2815	3043	3273	3732
	30" Semi Closed Polymer Arm, Brushed Nickel Frame FAE2M-P30SPAN		2112	2228	2342	2570	2800	3030	3260	3489	3948
	30" Closed Polymer Arm, Silver Metallic Frame FAE2M-P30CPAS		1909	2026	2139	2369	2596	2828	3057	3287	3744
	30" Closed Polymer Arm, Brushed Nickel Frame FAE2M-P30CPAN		2124	2240	2355	2585	2814	3042	3271	3502	3960

Faeron Metal Option Upcharges	\$ List
CAL 133 & Moisture Barrier (per yard)	64
Ganging Bracket	58
Kinetic Back (not available for Plus)	120
21" & 24" Under-seat Splashguard	58
30" Under-seat Splashguard	72
Removeable Seat Cover	90
Removable Back Cover	58
Non-Marring Glides	16
Combination Upholstery - dual fabrics (per chair)	33
Combination Upholstery - Three fabrics (per chair)	64

Additional features and options information see page 37.

ORDERING NOTES:

Faeron Metal chairs can also be specified with a Wood Arm (WA) or a Solid Surface Arm (SA), replace "PA" in the model number with the **Arm Style** selection below and add the upcharge listed.

Arm Style Option Upcharges

Arm Style Option Upcharges	\$ List
Solid Surface Arm (per pair) - Gr A White	573
Solid Surface Arm (per pair) - Gr A Color	598
Solid Surface Arm (per pair) - Gr B	645
Solid Surface Arm (per pair) - Gr C	678
Beech/Palette Wood Arm (per pair)	215

PRODUCT CODE KEY

Line	Series	Chair Type	Size	Arm Type	Arm Style	Metal Finish
<input type="text" value="FAE"/> Faeron	<input type="text" value="2M"/> Chair	<input type="text" value="P"/> Patient Seating	<input type="text" value="21"/>	<input type="text" value="O"/> Open Arm	<input type="text" value="PA"/> Polymer Arm	<input type="text" value="S"/> Silver Metallic
			<input type="text" value="24"/>	<input type="text" value="S"/> Semi Closed Arm	<input type="text" value="WA"/> Wood Arm	<input type="text" value="N"/> Brushed Nickel
			<input type="text" value="30"/>	<input type="text" value="C"/> Closed Arm	<input type="text" value="SA"/> Solid Surface Arm	

JORDAN | ENVIRONMENTAL SUMMARY

LEED CI CREDITS



MATERIAL CONTENT:

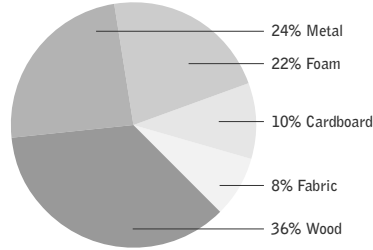

PRE-CONSUMER
RECYCLED CONTENT = 5.9%

POST-CONSUMER
RECYCLED CONTENT = 14.8%

	CONTRIBUTES TO	
CREDIT 2.1 - 2.2	Construction Waste Management	1-2 point(s)
CREDIT 3.3	Resource Reuse	1 point
CREDIT 4.1	Recycled Content	1 point
CREDIT 4.5	Low Emitting Materials, Systems & Seating	1 point
CREDIT 5.1	Regional Materials*	1 point
CREDIT 7	Certified Wood (MUST BE REQUESTED)	1 point(s)

*This credit is only applicable if in total 20% of the combined value of the procurement of construction materials and in the furniture are manufactured within a radius of 500 miles. This credit will apply if the installation of the finished product occurs within 500 miles of Kitchener, Ontario.

level® CERTIFICATION, AIR EMISSIONS AND FSC® CERTIFICATION



level® CERTIFICATION

BIFMA's e3 Furniture Sustainability Standard is a voluntary, multi-attribute standard that measures the degree of sustainability of furniture. This standard evaluates product and company environmental attributes and compliance systems in a wide range of elements which include Materials, Energy & Atmosphere, Human & Ecosystem Health and Social Responsibility. Jordan products have earned level®, BIFMA's sustainability certification program for furniture, certification through third-party verification against the e3 standard.

AIR-EMISSIONS

All Jordan products are supplied with air-emissions certified. Contact customer service for information.



FSC®

In 2005, Krug received Forest Stewardship Council® (FSC®) Chain-of-Custody certification for our manufacturing facilities. The FSC® Chain-of-Custody tracks certified wood from seedling to final sale. It verifies that the material for our FSC® certified products only come from well-managed, FSC®-certified forests and other controlled sources. FSC® is dedicated to the promotion of responsible forest management worldwide helping to take care of forests for future generations. Jordan and other Krug products can be specified with FSC® Certification. Contact customer service for further information, pricing and lead times.



Architects, designers, and building professionals can specify FSC®-certified products in order to achieve a point from the U.S. Green Building Council's Leadership in Energy and Environmental Design (LEED) Rating System.

JORDAN | PATIENT - DIMENSIONS & COM REQUIREMENTS

DIMENSIONS & COM REQUIREMENTS

	Overall Width	Overall Depth	Overall Height	Seat Height	Height of Arms from Floor	Width Between Arms	Seat Depth	Shipping Weight	Cubes
21" Seat	25	27	43.5	18.5	26	20.5	19	47	17
24" Seat	28	27	43.5	18.5	26	23.5	19	51	22
30" Seat	34	27	43.5	18.5	26	29.5	19	62	28
Ottoman	20	18	11.5					14	5

COM - YARDAGE REQUIREMENTS

	COM Yardage Seats & Backs Only	COM Yardage Seat Only	COM Yardage Back Only	COM Yardage Closed Arm Panel
21" & 24" - One Chair	2.2	0.9	1.9	0.9
21" & 24" - Two Chairs	4.2	1.3	3.8	1.35
21" & 24" - Three Chairs	6.3	2.2	5.7	1.8
21" & 24" - Four Chairs	8.4	2.6	7.6	2.7
30" - One Chair	3.1	0.9	2.21	0.9
30" - Two Chairs	6.2	1.8	4.5	1.35
30" - Three Chairs	9.3	2.7	6.7	1.8
30" - Four Chairs	12.4	3.6	9	2.7
Ottoman	0.66			

Note: Some vinyls, leathers & upholsteries are not suitable for application on Jordan seating.

The approval process is as follows:

1. A sample of the COM must be provided to Krug Customer Service prior to or at the time of order.
For Maharam or Momentum, Krug will obtain the fabric sample.
2. The sample will be reviewed and the customer advised if the fabric is unsuitable.
3. The COM fabric or leather will be inspected when received at the factory, to identify any further concerns with its suitability.

JORDAN | PATIENT

21"

21" with headrest

24"

30" Plus

Ottoman



WEIGHT CAPACITIES

Jordan weight capacities are as follows:

Patient Chairs (21" & 24") - 500 lbs







Plus Chair (30") - 750 lbs

Jordan Option Upcharges

	\$ List	\$ List
CAL 133 & Moisture Barrier (per yard)	64	Solid Surface Arm Cap (per pair) - Gr A White
Guest chair - Removable Seat Cover (per seat)	90	Solid Surface Arm Cap (per pair) - Gr A Color
21" & 24" - Removeable Back Covers (per back)	58	Solid Surface Arm Cap (per pair) - Gr B
30" & 44" - Removable Back Covers (per back)	90	Solid Surface Arm Cap (per pair) - Gr C
21" & 24" Cleanable Under-seat Splashguard	40	Kinetic Back option (not available for 30" & 44")
30" Cleanable Under-seat Splashguard	48	Ganging Bracket
Non-Marring Glide	37	
Combination Upholstery - dual fabrics (per chair)	33	
Combination Upholstery - Three fabrics (per chair)	64	

Additional features and options information see page 43.

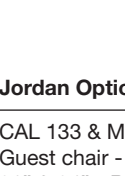
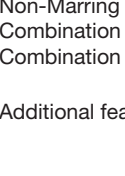
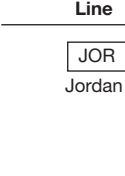
JORDAN | PATIENT

DESCRIPTION/MODEL	Species	COM		COL	FABRIC GRADES			LEATHER			
		1	2		3	4	5	6	7	8	9
	21" Open Arm										
	JOR2-P21OPS	Beech	1439	1570	1706	1938	2166	2396	2628	2857	3203
	JOR2-P21OPS	Maple	1534	1668	1803	2033	2264	2493	2721	2954	3297
	21" Open Arm Urethane Cap										
	JOR2-P21OPU	Beech	1579	1713	1846	2077	2307	2535	2767	2995	3342
	JOR2-P21OPU	Maple	1671	1808	1942	2172	2403	2634	2861	3092	3435
	21" Closed Arm										
	JOR2-P21CLS	Beech	1560	1695	1832	2059	2287	2518	2747	2980	3322
	JOR2-P21CLS	Maple	1657	1790	1924	2157	2385	2612	2845	3074	3420
	21" Closed Arm Urethane Cap										
	JOR2-P21CLU	Beech	1699	1835	1968	2196	2429	2658	2888	3117	3463
	JOR2-P21CLU	Maple	1796	1928	2063	2294	2524	2754	2984	3214	3560
	24" Open Arm										
	JOR2-P24OPS	Beech	1482	1619	1756	1995	2232	2466	2705	2943	3295
	JOR2-P24OPS	Maple	1581	1717	1856	2094	2329	2567	2805	3040	3397
	24" Open Arm Urethane Cap										
	JOR2-P24OPU	Beech	1624	1764	1902	2138	2377	2611	2851	3087	3439
	JOR2-P24OPU	Maple	1724	1861	2001	2238	2473	2713	2947	3186	3539
	24" Closed Arm										
	JOR2-P24CLS	Beech	1609	1746	1884	2119	2357	2594	2831	3068	3424
	JOR2-P24CLS	Maple	1705	1844	1981	2218	2457	2694	2929	3165	3521
	24" Closed Arm Urethane Cap										
	JOR2-P24CLU	Beech	1749	1887	2028	2265	2502	2738	2973	3210	3566
	JOR2-P24CLU	Maple	1852	1988	2126	2360	2601	2837	3070	3312	3666

Jordan Option Upcharges

	\$ List	\$ List
CAL 133 & Moisture Barrier (per yard)	64	Solid Surface Arm Cap (per pair) - Gr A White
Guest chair - Removable Seat Cover (per seat)	90	Solid Surface Arm Cap (per pair) - Gr A Color
21" & 24" - Removeable Back Covers	58	Solid Surface Arm Cap (per pair) - Gr B
21" & 24" Cleanable Under-seat Splashguard	40	Solid Surface Arm Cap (per pair) - Gr C
Non-Marring Glide	37	Kinetic Back option (not available for 30" & 44")
Combination Upholstery - dual fabrics (per chair)	33	Ganging Bracket
Combination Upholstery - Three fabrics (per chair)	64	

Additional features and options information see page 43.

PRODUCT CODE KEY

Line	Series	Chair Type	Size	Arm Type
JOR Jordan	2 Chair	P Patient Seating	21	OPS Open Arm CLS Closed Arm Solid Surface Arm Cap
			24	OPU Open Arm Urethane Arm Cap CLU Closed Arm Urethane Arm Cap
			30	OSC Open Arm Solid Surface Arm Cap CSC Closed Arm Solid Surface Arm Cap

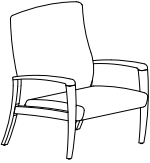
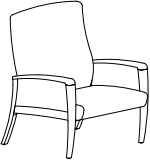
DESCRIPTION/MODEL	Species	COM		COL		FABRIC GRADES			LEATHER			
		1	2	3	4	5	6	7	8	9		
	30" Open Arm											
	JOR2-P30OPS	Beech	1755	1886	2023	2253	2483	2714	2943	3173	3517	
	JOR2-P30OPS	Maple	1852	1985	2118	2348	2579	2808	3038	3269	3613	
	30" Open Arm Urethane Cap											
JOR2-P30OPU	Beech	1894	2030	2164	2391	2623	2852	3082	3313	3656		
JOR2-P30OPU	Maple	1989	2124	2256	2488	2717	2948	3179	3409	3753		
	30" Closed Arm											
	JOR2-P30CLS	Beech	1879	2011	2145	2376	2607	2835	3067	3294	3639	
	JOR2-P30CLS	Maple	1971	2107	2240	2471	2699	2929	3161	3390	3736	
	30" Closed Arm Urethane Cap											
JOR2-P30CLU	Beech	2017	2148	2283	2515	2744	2972	3206	3433	3781		
JOR2-P30CLU	Maple	2117	2244	2381	2609	2839	3070	3299	3532	3874		





Jordan Option Upcharges

	\$ List	\$ List
CAL 133 & Moisture Barrier (per yard)	64	Solid Surface Arm Cap (per pair) - Gr A White
Guest chair - Removable Seat Cover (per seat)	90	Solid Surface Arm Cap (per pair) - Gr A Color
30" - Removable Back Cover (per back)	90	Solid Surface Arm Cap (per pair) - Gr B
30" Cleanable Under-seat Splashguard	48	Solid Surface Arm Cap (per pair) - Gr C
Non-Marring Glide	37	Kinetic Back option (not available for 30" & 44")
Combination Upholstery - dual fabrics (per chair)	33	Ganging Bracket
Combination Upholstery - Three fabrics (per chair)	64	

Additional features and options information see page 43.

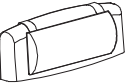









PRODUCT CODE KEY

Line	Series	Chair Type	Size	Arm Type
JOR	2	P	21	OPS
Jordan	Chair	Patient Seating		Open Arm
			24	OPU
				Open Arm
				Urethane Arm Cap
			30	OSC
				Open Arm
				Solid Surface
				Arm Cap
				CLS
				Closed Arm
				Solid Surface Arm Cap
				CLU
				Closed Arm
				Urethane Arm Cap
				CSC
				Closed Arm
				Solid Surface
				Arm Cap





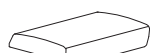

DESCRIPTION/MODEL	COM		COL	FABRIC GRADES			LEATHER		Fabric Yardage	Shipping Weight	Cubes			
	1	2		4	5	6	7	8				9		
	21" Adjustable Headrest													
	JOR2-RHR21	327	376	405	433	460	491	517	546	586	0.9	2.3	0.9	
	24" Adjustable Headrest													
	JOR2-RHR24	359	411	444	477	509	540	570	601	644	0.9	2.3	0.9	
	30" Plus Patient Headrest													
	JOR2-RHR30	429	491	530	565	602	642	678	716	766	0.9	2.3	0.9	
	Ottoman													
	JOR-5	Beech	670	701	730	760	785	816	853	873	921	0.66	14	5
		Maple	729	747	779	806	835	865	892	921	971	0.66	14	5

ORDERING NOTE: Ottoman is not available on *KrugExpress*.

JORDAN | REPLACEMENT COMPONENTS

DESCRIPTION/MODEL	COM	COL	3	FABRIC GRADES			LEATHER			Yds	Weight	Cube
	1	2		4	5	6	7	8	9			
 21" Replaceable Patient Backs JOR2-RBP21	560	617	674	754	845	927	1016	1131	1244	1.9	19	3.8
 24" Replaceable Patient Backs JOR2-RBP24	585	642	699	779	870	952	1041	1155	1269	1.9	21	3.8
 30" Replaceable Patient Backs JOR2-RBP30	637	699	769	864	968	1062	1168	1302	1434	2.21	24	4.8
 21" Replaceable Patient Back Cover JOR2-RBCP21	234	291	348	428	518	599	690	805	917	1.9	2.5	0.8
 24" Replaceable Patient Back Cover JOR2-RBCP24	238	295	352	432	446	603	695	809	929	1.9	2.7	0.8
 30" Replaceable Patient Back Cover JOR2-RBCP30	255	320	387	479	585	678	784	916	1048	2.21	3	0.8
 21" Replacement Seat JOR2-RS21	394	416	444	481	523	562	606	661	715	.9	9	2.7
 24" Replacement Seat JOR2-RS24	410	437	465	502	544	584	627	680	735	.9	10	2.7
 30" Replacement Seat JOR2-RS30	502	537	569	615	667	715	767	833	898	.9	12	3.4
 44" Replacement Seat JOR2-RS44	663	695	729	774	827	873	928	992	1059	.9	14	4.8
	Replacement Splash Guard											
	JOR2-RSG21	90									1	.3
	JOR2-RSG24	110									2	.4
	JOR2-RSG30	154									3	.5
JOR2-RSG44	166									4	.6	

JORDAN | REPLACEMENT COMPONENTS

DESCRIPTION/MODEL	COM			COL			FABRIC GRADES				LEATHER		Yds	Weight	Cube
	1	2	3	4	5	6	7	8	9						
 21" Replacement Seat Cover JOR2-RSC21	78	155	182	218	261	301	344	397	452	1.0	1.6	.8			
 24" Replacement Guest Seat Cover JOR2-RSC24	82	159	186	223	267	304	347	403	455	1.0	1.7	.8			
 30" Replacement Seat Cover JOR2-RSC30	144	179	212	258	310	358	409	477	541	1.0	2	.8			
 44" Replacement Seat Cover JOR2-RSC44	149	183	216	261	315	361	413	480	544	1.0	2.5	.8			
 Replacement Closed Arm Panel JOR2-RCA	218	232	245	265	286	305	327	354	407	0.9	6.0	.8			
	Replacement Side Frame - Start - Beech JOR2-RSFS 264										7.5	1.4			
	Replacement Side Frame - Start - Maple JOR2-RSFS 328										7.5	1.4			
	Replacement Side Frame - End - Beech JOR2-RSFE 264										7.5	1.4			
	Replacement Side Frame - End - Maple JOR2-RSFE 328										7.5	1.4			
	Replacement Side Frame with Urethane Cap - Start - Beech JOR2-RSFSAC 308										7.5	1.4			
	Replacement Side Frame with Urethane Cap - Start - Maple JOR2-RSFSAC 372										7.5	1.4			
	Replacement Side Frame with Urethane Cap - End - Beech JOR2-RSFEAC 308										7.5	1.4			
	Replacement Side Frame with Urethane Cap - End - Maple JOR2-RSFEAC 372										7.5	1.4			
	Replacement Arm Cap - Urethane JOR2-RUA 71										1.5	.2			
	Replacement Arm Cap-Solid Surface JOR2-RACSS										Grade A- White 238	Grade A- Color 240	Grade- B 250	Grade- C 264	2

MULTIPLE SEATING

80 Cressida

96 Solis

114 Faeron Wood

128 Faeron Metal

143 Jordan

CRESSIDA | MULTIPLE SEATING INSTRUCTIONS

To aid you in the process of specifying and ordering Cressida Multiple Seating, we have compiled the following summary. It explains the three different types of Cressida Multiple Seating – (a) Pre-Configured, (b) Start, Center & End Units and (c) the Freespan Multiple Units – including the features and considerations of each type, to assist in selecting the one that best suits each application. It is a requirement for all Cressida Multiple Seating orders, a drawing or plan view layout must accompany the order, so that we can verify that the specification is correct.

When building your multiple seating layout, please note that your order should start from left to right as you are facing the configuration.

Pre-Configured Multiple Units

Pre-Configured Multiple Units are designed to be used when you have seating configurations that are 2-3 chair units in size (see picture below).

Two-Seat

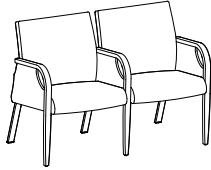

Considerations if choosing to use Pre-Configured Units:

- Linking tables can be joined to either end of a Pre-Configured Multiple Unit, but not in-between
- There are no limitations to the number of Pre-Configured Multiple units that can be ganged together with the Cressida Linking Tables
- Pre-Configured Multiple Units are not available in 30" or 44" plus widths
- Pre-Configured Multiple Units are not designed to work with other multiple seating (Start, Center, End Units or Freespan Units) unless a Cressida Linking Table or linking brackets are used in-between the different types of multiple seating.
- Pre-Configured Multiple Units are built from Start, Center and End Units and therefore, can be reconfigured to singular or two-seat units. However, you may have to purchase additional components (arms, etc...) to be able to do this. See line drawings below for possible configurations that can be made from taking apart the Pre-Configured Multiple Units.

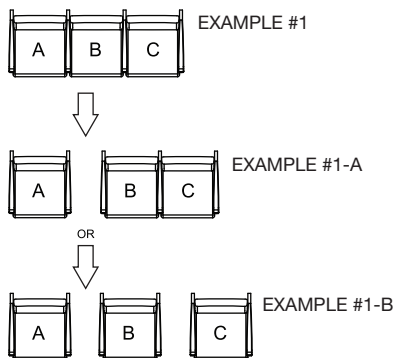

*Please note:

Example #1-A requires an additional end unit arm for chair A, and a start unit arm for chair B.

Example #1-B requires an additional end unit arm for chair A, a start and end unit arm for chair B, and a start unit arm for chair C.

Start, Center and End Multiple Seating Units

Start, Center and End Multiple Units are designed to be used when you have seating configurations that are greater than three chair units in size, and/or include 30" or 44" units (see picture below). Also, before you start to build your multiple seating layout, please note that your order should start from left to right as you are facing the chair, therefore begin the configuration with a Start Unit, then move to a Center Unit and finish with an End Unit.

Considerations if choosing to use Start, Center and End Multiple Units:

- Start, Center and End units are available in widths - Guest (21", 24", 30" & 44") and Patient - (21", 24" & 30")
- There are no limitations to the amount of center units that can be ganged to a start or an end unit
- Cressida Linking Tables can be joined to any Cressida Start or End unit only (this is because the units are engineered with the finished arms)

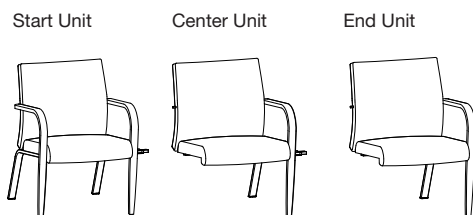

CRESSIDA | MULTIPLE SEATING INSTRUCTIONS

See below for sample configurations of when you would use Start, Center and End Multiple Units.

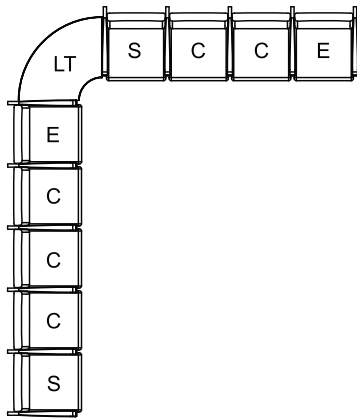

Freespan Multiple Units

Freespan Multiple Units are designed to be used when you have seating configurations that are 2-3 chair units in size and a reduced number of legs are desirable. (see picture below).

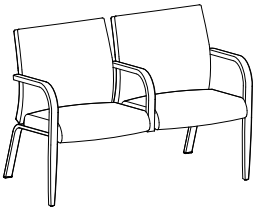

Considerations if choosing to use Freespan Multiple Units:

- The unit with the center arm increases the overall width of the unit by 1" per arm
- Linking tables can be joined to either side of a Freespan Multiple Unit, but not in-between
- There are no limitations to the number of Freespan Multiple units that can be ganged together with the Cressida Linking Tables or linking brackets.
- Freespan Multiple Units are not available in 30" or 44" plus widths
- Freespan Multiple Units are not designed to work with other multiple seating (Start, Center, End Units or Freespan Units) unless a Cressida Linking Table or linking brackets are used in-between the different types of multiple seating.

Below illustrates possible configurations when you could use all three types of Cressida Multiple Seating together.

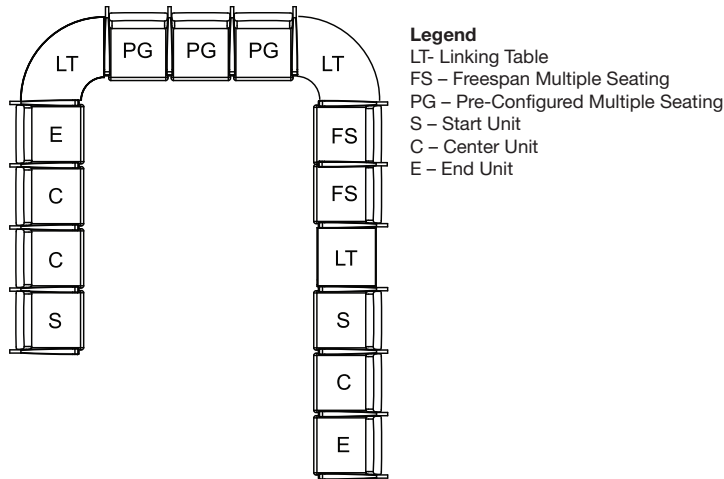

Legend

- LT- Linking Table
- FS - Freespan Multiple Seating
- PG - Pre-Configured Multiple Seating
- S - Start Unit
- C - Center Unit
- E - End Unit

For more information on how to specify Cressida Multiple Seating, please contact Customer Service directly at 1-888-578-5784.

CRESSIDA | MULTIPLE SEATING - PRE-CONFIGURED UNITS

DIMENSIONS & COM REQUIREMENTS

	Overall Width	Overall Depth	Overall Height	Seat Height	Height of Arms from Floor	Width Between Arms	Seat Depth	Shipping Weight	Shipping Cube	COM Seat & Back Yardage	COM Fabric Seat Yardage	COM Fabric Back Yardage	COM Fabric Closed Arm Panel Yardage
PCG21X2	47.25	28.5	33.75	18.5	26	21	18.75	82	30	2.6	1.2	1.4	0.4
PCP21X2	47.25	28.5	43.5	18.5	26	21	18.75	88	38	3.2	1.2	2	0.4
PCG21X3	70	28.5	33.75	18.5	26	21	18.75	117	44	4.08	2	2.08	0.4
PCP21X3	70	28.5	43.5	18.5	26	21	18.75	125	56	5	2	3	0.4
PCG24X2	53.25	28.5	33.75	18.5	26	24	18.75	85	34	3.3	1.2	2.08	0.4
PCP24X2	53.25	28.5	43.5	18.5	26	24	18.75	95	43	4.14	1.2	3	0.4
PCG24X3	79	28.5	33.75	18.5	26	24	18.75	121	50	5.05	2	3.48	0.4
PCP24X3	79	28.5	43.5	18.5	26	24	18.75	135	63	6.25	2	4.9	0.4

Note: Some vinyls, leathers & upholsteries are not suitable for application on Cressida seating. Please refer to page 628 for C.O.M approval process.

Cressida Option Upcharges \$ List

Moisture Barrier (per yard)	64
Removable Seat Cover (per seat)	85
Guest Removeable 21" & 24" Back Covers (per back)	54
Patient Removeable 21" & 24" Back Covers (per back)	85
21" & 24" Cleanable Under-Seat Splashguard (per seat)	59
Combination Upholstery - dual fabrics (per chair)	33
Combination Upholstery - Three fabrics (per chair)	64

ORDERING NOTES:

A drawing showing the configuration of the multiple seating and tables is required with each purchase order.

Replacement seat and back covers can be quickly installed on Cressida products that were originally ordered with the Removeable cover option. Replacement seat and back covers can also be installed on Cressida products that were not originally ordered with the Removeable cover option, with some simple staple removal on the original seats and backs.

Patient backs are available on multiple units, please change the model number CRE2-PCG to CRE2-PCP, CRE2-PCG to CRE2-PCP, CRE2-PCG to CRE2-PCP and add the following upcharges per back:

	Grade 1	Grade 2	Grade 3	Grade 4	Grade 5	Grade 6	Grade 7	Grade 8	Grade 9
21" Chairs	82	95	108	126	148	164	186	213	239
24" Chairs	94	107	120	138	159	178	199	226	250

WEIGHT CAPACITIES

Cressida weight capacities are as follows:

Pre-configured - 350 lbs per seat

PRE-CONFIGURED MULTIPLE UNITS

Two-Seat

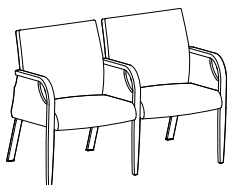

Three-Seat

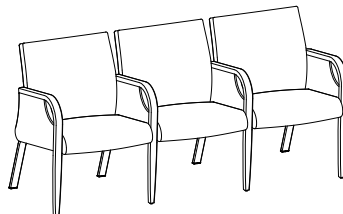

CRESSIDA | MULTIPLE SEATING - PRE-CONFIGURED UNITS

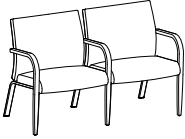
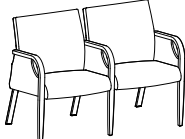
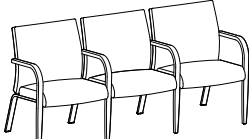
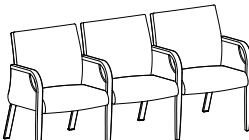
DESCRIPTION	MODEL	SPECIES	COM		COL			FABRIC GRADES		LEATHER		
			1	2	3	4	5	6	7	8	9	
	2 Seat - 21" Open Arm Pre-configured Unit, Guest Backs											
	CRE2-PCG21X2OPS	Beech, Maple	2024	2126	2227	2368	2529	2670	2831	3035	3236	
	CRE2-PCG21X2OPP		2059	2161	2261	2403	2563	2705	2866	3069	3270	
	2 Seat - 21" Closed Arm Pre-configured Unit, Guest Backs											
	CRE2-PCG21X2CLS	Beech, Maple	2451	2614	2753	2949	3172	3369	3592	3873	4152	
	CRE2-PCG21X2CLP		2487	2650	2789	2985	3208	3404	3627	3907	4185	
	3 Seat - 21" Open Arm Pre-configured Unit, Guest Backs											
	CRE2-PCG21X3OPS	Beech, Maple	2898	3058	3217	3439	3697	3919	4173	4491	4813	
	CRE2-PCG21X3OPP		2946	3104	3265	3488	3742	3965	4219	4539	4859	
	3 Seat - 21" Closed Arm Pre-configured Unit, Guest Backs											
	CRE2-PCG21X3CLS	Beech, Maple	3469	3711	3921	4216	4555	4848	5187	5609	6031	
	CRE2-PCG21X3CLP		3516	3759	3969	4264	4602	4898	5233	5657	6078	

ORDERING NOTES:

A drawing showing the configuration of the multiple seating and tables is required with each purchase order.

Replacement seat and back covers can be quickly installed on Cressida products that were originally ordered with the Removeable cover option. Replacement seat and back covers can also be installed on Cressida products that were not originally ordered with the Removeable cover option, with some simple staple removal on the original seats and backs.

Cressida Option Upcharges	\$ List		\$ List
Moisture Barrier (per yard)	64	21" & 24" Cleanable Under-Seat Splashguard (per seat)	59
Removable Seat Cover (per seat)	85	Combination Upholstery - dual fabrics (per chair)	33
Guest Removeable 21" & 24" Back Covers (per back)	54	Combination Upholstery - Three fabrics (per chair)	64
Patient Removeable 21" & 24" Back Covers (per back)	85		

Additional features and options information see page 19.

PRODUCT CODE KEY

Line	Series	Chair Style	Size	Arm Style
CRE Cressida	2 Chair	PCG Pre-configured Guest	21x2	OPS Open Arm
		PCP Pre-configured Patient	21x3	OPP Open Arm Polymer Arm Cap
			24x2	CLS Closed Arm
			24x3	CLP Closed Arm Polymer Arm Cap

CRESSIDA | MULTIPLE SEATING - PRE-CONFIGURED UNITS

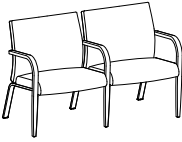
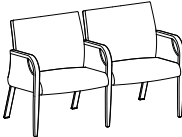
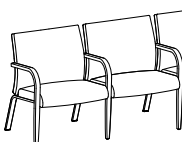
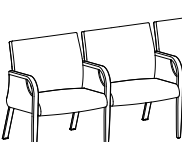
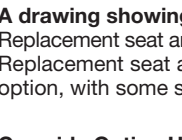
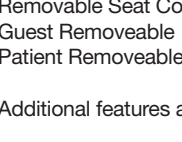
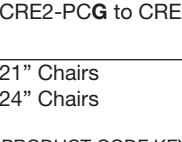
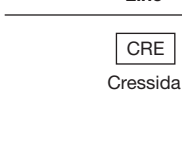
DESCRIPTION	MODEL	SPECIES	COM		COL		FABRIC GRADES			LEATHER	
			1	2	3	4	5	6	7	8	9
	2 Seat - 24" Open Arm Pre-configured Unit, Guest Backs										
	CRE2-PCG24X2OPS	Beech, Maple	2088	2191	2293	2433	2593	2736	2896	3099	3303
	2 Seat - 24" Open Arm with arm cap Pre-configured Unit, Guest Backs										
	CRE2-PCG24X2OPP		2126	2223	2326	2466	2629	2769	2932	3134	3339
	2 Seat - 24" Closed Arm Pre-configured Unit, Guest Backs										
	CRE2-PCG24X2CLS	Beech, Maple	2517	2681	2819	3015	3238	3433	3661	3936	4215
	2 Seat - 24" Closed Arm with arm cap Pre-configured Unit, Guest Backs										
	CRE2-PCG24X2CLP		2552	2715	2853	3052	3271	3469	3693	3972	4249
	3 Seat - 24" Open Arm Pre-configured Unit, Guest Backs										
	CRE2-PCG24X3OPS	Beech, Maple	3021	3181	3341	3562	3817	4040	4294	4614	4931
	3 Seat - 24" Open Arm with arm cap Pre-configured Unit, Guest Backs										
	CRE2-PCG24X3OPP		3068	3224	3385	3608	3864	4088	4341	4663	4978
	3 Seat - 24" Closed Arm Pre-configured Unit, Guest Backs										
	CRE2-PCG24X3CLS	Beech, Maple	3592	3831	4042	4339	4678	4971	5309	5730	6154
	3 Seat - 24" Closed Arm with arm cap Pre-configured Unit, Guest Backs										
	CRE2-PCG24X3CLP		3639	3880	4090	4387	4723	5017	5359	5649	6199

ORDERING NOTES:

A drawing showing the configuration of the multiple seating and tables is required with each purchase order.

Replacement seat and back covers can be quickly installed on Cressida products that were originally ordered with the Removeable cover option. Replacement seat and back covers can also be installed on Cressida products that were not originally ordered with the Removeable cover option, with some simple staple removal on the original seats and backs.

Cressida Option Upcharges	\$ List	\$ List
Moisture Barrier (per yard)	64	21" & 24" Cleanable Under-Seat Splashguard (per seat)
Removable Seat Cover (per seat)	85	Combination Upholstery - dual fabrics (per chair)
Guest Removeable 21" & 24" Back Covers (per back)	54	Combination Upholstery - Three fabrics (per chair)
Patient Removeable 21" & 24" Back Covers (per back)	85	

Additional features and options information see page 19.

Patient backs are available on multiple units, please change the model number CRE2-PCG to CRE2-PCP, CRE2-PCG to CRE2-PCP, CRE2-PCG to CRE2-PCP and add the following upcharges per back:

	Grade 1	Grade 2	Grade 3	Grade 4	Grade 5	Grade 6	Grade 7	Grade 8	Grade 9
21" Chairs	82	95	108	126	148	164	186	213	239
24" Chairs	94	107	120	138	159	178	199	226	250

PRODUCT CODE KEY

Line	Series	Chair Style	Size	Arm Style
CRE Cressida	2 Chair	PCG Pre-configured Guest	21x2	OPS Open Arm
		PCP Pre-configured Patient	21x3	OPP Open Arm Polymer Arm Cap
			24x2	CLS Closed Arm
			24x3	CLP Closed Arm Polymer Arm Cap

CRESSIDA | MULTIPLE SEATING - START, CENTER & END UNITS

DIMENSIONS & COM REQUIREMENTS

CRESSIDA START UNITS

	Overall Width	Overall Depth	Overall Height	Seat Height	Height of Arms from Floor	Width Between Arms	Seat Depth	Shipping Weight	Cube	COM Seat & Back Yardage	COM Fabric Seat Yardage	COM Fabric Back Yardage	COM Fabric Closed Arm Panel (1 Arm) Yardage	COM Fabric Closed Arm Panel (2 Arms) Yardage
SG21	24.5	28.5	33.75	18.5	26	21	18.75	47	14	1.4	0.8	0.7	0.4	0.8
SP21	24.5	28.5	43.75	18.5	26	21	18.75	49	17	1.8	0.8	1	0.4	0.8
SG24	27.5	28.5	33.75	18.5	26	24	18.75	52	19	1.4	0.8	0.7	0.4	0.8
SP24	27.5	28.5	43.75	18.5	26	24	18.75	55	22	1.8	0.8	1.95	0.4	0.8
SG30	33.5	28.5	33.75	18.5	26	30	18.75	61	20	2.5	1.1	1.4	0.4	0.8
SP30	33.5	28.5	43.75	18.5	26	30	18.75	64	28	3.15	1.1	1.95	0.4	0.8
SG44	47.5	28.5	33.75	18.5	26	44	18.75	73	28	2.5	1.1	1.4	0.4	0.8

CRESSIDA CENTER UNITS

	Overall Width	Overall Depth	Overall Height	Seat Height	Height of Arms from Floor	Width Between Arms	Seat Depth	Shipping Weight	Cube	COM Seat & Back Yardage	COM Fabric Seat Yardage	COM Fabric Back Yardage	COM Fabric Closed Arm Panel Yardage
CG21	22.75	28.5	33.75	18.5	26	21	18.75	41	14	1.4	0.8	0.7	0.4
CP21	22.75	28.5	43.75	18.5	26	21	18.75	44	17	1.8	0.8	1	0.4
CG24	25.75	28.5	33.75	18.5	26	24	18.75	45	19	1.4	0.8	0.7	0.4
CP24	25.75	28.5	43.75	18.5	26	24	18.75	50	22	1.8	0.8	1.95	0.4
CG30	31.75	28.5	33.75	18.5	26	30	18.75	54	20	2.5	1.1	1.4	0.4
CP30	31.75	28.5	43.75	18.5	26	30	18.75	56	28	3.15	1.1	1.95	0.4
CG44	45.75	28.5	33.75	18.5	26	44	18.75	67	28	2.5	1.1	1.4	0.4

CRESSIDA END UNITS

	Overall Width	Overall Depth	Overall Height	Seat Height	Height of Arms from Floor	Width Between Arms	Seat Depth	Shipping Weight	Cube	COM Seat & Back Yardage	COM Fabric Seat Yardage	COM Fabric Back Yardage	COM Fabric Closed Arm Panel Yardage
EG21	22.75	28.5	33.75	18.5	26	21	18.75	38	14	1.4	0.8	0.7	0.4
EP21	22.75	28.5	43.75	18.5	26	21	18.75	41	17	1.8	0.8	1	0.4
EG24	25.75	28.5	33.75	18.5	26	24	18.75	41	19	1.4	0.8	0.7	0.4
EP24	25.75	28.5	43.75	18.5	26	24	18.75	46	22	1.8	0.8	1.85	0.4
EG30	31.75	28.5	33.75	18.5	26	30	18.75	51	20	2.5	1.1	1.4	0.4
EP30	31.75	28.5	43.75	18.5	26	30	18.75	53	28	3.15	1.1	1.95	0.4
EG44	45.75	28.5	33.75	18.5	26	44	18.75	63	28	2.5	1.1	1.4	0.4

When ordering more than one Start, Center or End unit, please refer to COM yardage requirements for guest chairs or COM yardage requirements for patient chairs.

WEIGHT CAPACITIES

Cressida weight capacities are as follows:
Multiple Seating & Pre-configured - 350 lbs per seat

ORDERING NOTES: A drawing showing the configuration of the multiple seating and tables is required with each purchase order. Replacement seat and back covers can be quickly installed on Cressida products that were originally ordered with the Removeable cover option. Replacement seat and back covers can also be installed on Cressida products that were not originally ordered with the Removeable cover option, with some simple staple removal on the original seats and backs.



Cressida Option Upcharges	\$ List	Cressida Option Upcharges	\$ List
Moisture Barrier (per yard)	64	Patient Removeable 21" & 24" Back Covers	85
Removable Seat Cover (per seat)	85	Patient Removeable 30" Back Covers	137
Guest Removeable 21" & 24" Back Covers (per back)	54	21" & 24" Cleanable Under-Seat Splashguard	59
Guest Removeable 30" & 44" Back Covers (per back)	85	30" Cleanable Under-Seat Splashguard	67
Combination Upholstery - dual fabrics (per chair)	33	44" Cleanable Under-Seat Splashguard	80
Combination Upholstery - Three fabrics (per chair)	64		

Additional features and options information see page 19.

Patient backs are available on multiple units, please change the model number CRE2-SG to CRE2-SP, CRE2-CG to CRE2-CP, CRE2-EG to CRE2-EP and add the following upcharges per back:

	Grade 1	Grade 2	Grade 3	Grade 4	Grade 5	Grade 6	Grade 7	Grade 8	Grade 9
21" Chairs	82	95	108	126	148	164	186	213	239
24" Chairs	94	107	120	138	159	178	199	226	250
30" Chairs	134	151	168	190	217	240	268	302	336

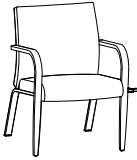
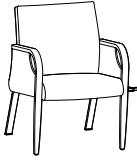
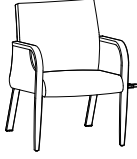
CRESSIDA | MULTIPLE SEATING - START, CENTER & END UNITS

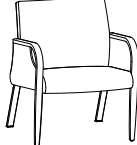
DESCRIPTION	MODEL	SPECIES	COM		COL			FABRIC GRADES			LEATHER	
			1	2	3	4	5	6	7	8	9	
Start												
	21" Open Arm Start Unit, Guest Back CRE2-SG21OPS	Beech, Maple	1106	1164	1222	1304	1394	1479	1569	1688	1804	
	21" Open Arm with arm cap Start Unit, Guest Back CRE2-SG21OPP		1126	1185	1268	1327	1417	1501	1593	1709	1827	
	21" Closed Arm Start Unit, Guest Back CRE2-SG21CLS	Beech, Maple	1389	1488	1570	1691	1825	1944	2079	2244	2413	
	21" Closed Arm with arm cap Start Unit, Guest Back CRE2-SG21CLP		1412	1512	1594	1714	1846	1965	2103	2268	2436	
	21" Closed Arm / Open Center Arm Start Unit, Guest Back CRE2-SG21COS	Beech, Maple	1246	1327	1395	1497	1609	1712	1823	1966	2109	
	21" Closed Arm with arm cap / Open Center Arm with arm cap Start Unit, Guest Back CRE2-SG21COP		1270	1348	1419	1519	1632	1734	1845	1989	2133	
	24" Open Arm Start Unit, Guest Back CRE2-SG24OPS	Beech, Maple	1152	1210	1268	1351	1443	1527	1618	1735	1854	
	24" Open Arm with arm cap Start Unit, Guest Back CRE2-SG24OPP		1173	1232	1290	1374	1465	1548	1640	1756	1875	
	24" Closed Arm Start Unit, Guest Back CRE2-SG24CLS	Beech, Maple	1439	1536	1620	1741	1872	1990	2126	2295	2462	
	24" Closed Arm with arm cap Start Unit, Guest Back CRE2-SG24CLP		1461	1559	1643	1764	1896	2014	2149	2318	2486	
	24" Closed Arm / Open Center Arm Start Unit, Guest Back CRE2-SG24COS	Beech, Maple	1295	1374	1445	1545	1660	1756	1871	2014	2247	
	24" Closed Arm with arm cap / Open Center Arm with arm cap Start Unit, Guest Back CRE2-SG24COP		1317	1395	1466	1567	1680	1779	1894	2035	2269	

ORDERING NOTES: A drawing showing the configuration of the multiple seating and tables is required with each purchase order.
Additional features and options information see page 19, options upcharges page 85.

PRODUCT CODE KEY

Line	Series	Chair Style	Size	Arm Style
CRE Cressida	2 Chair	SG Start Unit Guest Multiple Seating	21	OPS Open Arm
		CG Center Unit Multiple Seating	24	OPP Open Arm Polymer Arm Cap
		EG End Unit Multiple Seating	30	COS Closed Arm/Open Center Arm
			44	COP Closed Arm/Open Center Arm Polymer Arm Cap
				CLS Closed Arm
				CLP Closed Arm Polymer Arm Cap

CRESSIDA | MULTIPLE SEATING - START, CENTER & END UNITS

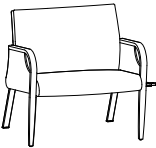
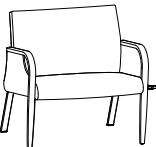
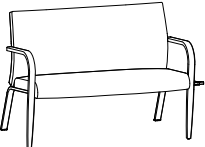
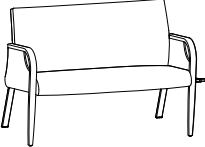
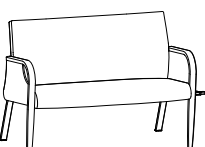



DESCRIPTION	MODEL	SPECIES	COM		COL			FABRIC GRADES			LEATHER	
			1	2	3	4	5	6	7	8	9	
	30" Open Arm Start Unit, Guest Back CRE2-SG30OPS	Beech, Maple	1391	1474	1559	1667	1796	1908	2037	2196	2359	
	30" Open Arm with arm cap Start Unit, Guest Back CRE2-SG30OPP		1415	1495	1581	1690	1817	1929	2031	2219	2383	
	30" Closed Arm Start Unit, Guest Back CRE2-SG30CLS	Beech, Maple	1678	1801	1907	2056	2223	2374	2545	2757	2969	
	30" Closed Arm with arm cap Start Unit, Guest Back CRE2-SG30CLP		1703	1822	1928	2079	2247	2396	2567	2779	2991	
	30" Closed Arm/Open Center Arm Start Unit, Guest Back CRE2-SG30COS	Beech, Maple	1536	1638	1730	1861	2011	2140	2291	2478	2637	
	30" Closed Arm with arm cap/Open Center Arm with arm cap Start Unit, Guest Back CRE2-SG30COP		1559	1661	1752	1884	2033	2165	2313	2500	2659	
	44" Open Arm Start Unit, Guest Back CRE2-SG44OPS	Beech, Maple	1905	2010	2098	2196	2361	2486	2625	2802	2978	
	44" Open Arm with arm cap Start Unit, Guest Back CRE2-SG44OPP		1926	2031	2119	2219	2385	2506	2646	2823	2999	
	44" Closed Arm Start Unit, Guest Back CRE2-SG44CLS	Beech, Maple	2209	2337	2449	2610	2791	2949	3133	3358	3588	
	44" Closed Arm with arm cap Start Unit, Guest Back CRE2-SG44CLP		2230	2357	2472	2632	2815	2971	3156	3382	3609	
	44" Closed Arm/Open Center Arm Start Unit, Guest Back CRE2-SG44COS	Beech, Maple	2064	2172	2274	2577	2560	2717	2880	3080	3280	
	44" Closed Arm with arm cap/Open Center Arm with arm cap Start Unit, Guest Back CRE2-SG44COP		2087	2195	2297	2597	2584	2741	2902	3103	3304	

ORDERING NOTES: A drawing showing the configuration of the multiple seating and tables is required with each purchase order.
Additional features and options information see page 19, options upcharges page 85.

PRODUCT CODE KEY

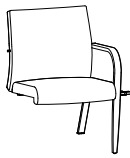
Line	Series	Chair Style	Size	Arm Style
CRE Cressida	2 Chair	SG Start Unit Guest Multiple Seating	21	OPS Open Arm
		CG Center Unit Multiple Seating	24	OPP Open Arm Polymer Arm Cap
		EG End Unit Multiple Seating	30	COS Closed Arm/Open Center Arm
			44	COP Closed Arm/Open Center Arm Polymer Arm Cap
				CLS Closed Arm
				CLP Closed Arm Polymer Arm Cap

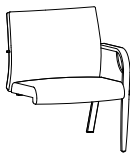
CRESSIDA | MULTIPLE SEATING - START, CENTER & END UNITS





DESCRIPTION	MODEL	SPECIES	COM		COL			FABRIC GRADES			LEATHER	
			1	2	3	4	5	6	7	8	9	
Center 	21" Open Arm Center Unit, Guest Back CRE2-CG21OPS	Beech, Maple	1039	1096	1155	1239	1331	1414	1505	1622	1741	
	21" Open Arm with arm cap Center Unit, Guest Back CRE2-CG21OPP		1053	1110	1168	1251	1342	1423	1515	1634	1751	
	21" Closed Arm Center Unit, Guest Back CRE2-CG21CLS	Beech, Maple	1180	1262	1332	1431	1545	1644	1758	1899	2043	
	21" Closed Arm with arm cap Center Unit, Guest Back CRE2-CG21CLP		1194	1272	1345	1443	1558	1659	1772	1913	2056	
	24" Open Arm Center Unit, Guest Back CRE2-CG24OPS	Beech, Maple	1093	1151	1209	1290	1384	1465	1559	1676	1792	
	24" Open Arm with arm cap Center Unit, Guest Back CRE2-CG24OPP		1107	1164	1223	1304	1395	1479	1569	1689	1804	
	24" Closed Arm Center Unit, Guest Back CRE2-CG24CLS	Beech, Maple	1236	1315	1386	1484	1598	1698	1813	1955	2098	
	24" Closed Arm with arm cap Center Unit, Guest Back CRE2-CG24CLP		1246	1328	1396	1497	1612	1712	1825	1966	2109	
	30" Open Arm Center Unit, Guest Back CRE2-CG30OPS	Beech, Maple	1292	1373	1453	1566	1693	1808	1935	2098	2257	
	30" Open Arm with arm cap Center Unit, Guest Back CRE2-CG30OPP		1305	1384	1465	1579	1706	1818	1947	2109	2271	
	30" Closed Arm Center Unit, Guest Back CRE2-CG30CLS	Beech, Maple	1437	1536	1631	1760	1909	2040	2191	2377	2505	
	30" Closed Arm with arm cap Center Unit, Guest Back CRE2-CG30CLP		1447	1548	1642	1773	1922	2054	2201	2387	2518	

ORDERING NOTES: A drawing showing the configuration of the multiple seating and tables is required with each purchase order.
Additional features and options information see page 19, options upcharges page 85.

PRODUCT CODE KEY

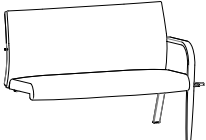
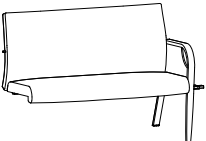
Line	Series	Chair Style	Size	Arm Style
CRE Cressida	2 Chair	SG Start Unit Guest Multiple Seating	21	OPS Open Arm
		CG Center Unit Multiple Seating	24	OPP Open Arm Polymer Arm Cap
		EG End Unit Multiple Seating	30	COS Closed Arm/Open Center Arm
			44	COP Closed Arm/Open Center Arm Polymer Arm Cap
				CLS Closed Arm
				CLP Closed Arm Polymer Arm Cap

CRESSIDA | MULTIPLE SEATING - START, CENTER & END UNITS

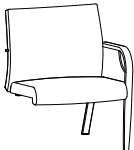

DESCRIPTION	MODEL	SPECIES	COM		COL			FABRIC GRADES			LEATHER	
			1	2	3	4	5	6	7	8	9	
	44" Open Arm Center Unit, Guest Back CRE2-CG44OPS	Beech, Maple	1563	1668	1753	1880	2019	2143	2282	2460	2636	
	44" Open Arm with arm cap Center Unit, Guest Back CRE2-CG44OPP		1573	1680	1768	1892	2031	2157	2295	2471	2646	
	44" Closed Arm Center Unit, Guest Back CRE2-CG44CLS	Beech, Maple	1723	1833	1932	2073	2236	2376	2536	2739	2942	
	44" Closed Arm with arm cap Center Unit, Guest Back CRE2-CG44CLP		1735	1842	1945	2086	2247	2386	2551	2747	2954	
End 	21" Open Arm End Unit, Guest Back CRE2-EG21OPS	Beech, Maple	989	1046	1107	1187	1283	1360	1456	1570	1689	
	21" Open Arm with arm cap End Unit, Guest Back CRE2-EG21OPP		1002	1060	1118	1199	1294	1374	1467	1585	1699	
	21" Closed Arm End Unit, Guest Back CRE2-EG21CLS	Beech, Maple	1135	1209	1284	1383	1495	1594	1709	1852	1993	
	21" Closed Arm with arm cap End Unit, Guest Back CRE2-EG21CLP		1143	1223	1295	1394	1508	1607	1720	1862	2006	
	24" Open Arm End Unit, Guest Back CRE2-EG24OPS	Beech, Maple	1043	1102	1162	1241	1334	1416	1509	1624	1744	
	24" Open Arm with arm cap End Unit, Guest Back CRE2-EG24OPP		1056	1114	1171	1253	1347	1428	1522	1638	1753	
	24" Closed Arm End Unit, Guest Back CRE2-EG24CLS	Beech, Maple	1185	1265	1335	1434	1548	1646	1764	1905	2046	
	24" Closed Arm with arm cap End Unit, Guest Back CRE2-EG24CLP		1198	1275	1348	1446	1560	1661	1774	1915	2059	

ORDERING NOTES: A drawing showing the configuration of the multiple seating and tables is required with each purchase order.
Additional features and options information see page 19, options upcharges page 85.

PRODUCT CODE KEY

Line	Series	Chair Style	Size	Arm Style
CRE Cressida	2 Chair	SG Start Unit Guest Multiple Seating	21	OPS Open Arm
		CG Center Unit Multiple Seating	24	OPP Open Arm Polymer Arm Cap
		EG End Unit Multiple Seating	30	COS Closed Arm/Open Center Arm
			44	COP Closed Arm/Open Center Arm Polymer Arm Cap
				CLS Closed Arm
				CLP Closed Arm Polymer Arm Cap

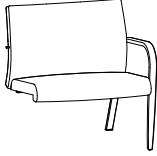
CRESSIDA | MULTIPLE SEATING - START, CENTER & END UNITS

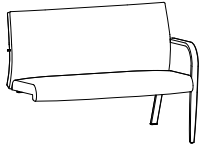
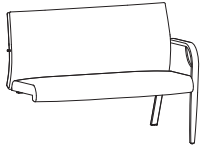
DESCRIPTION	MODEL	SPECIES	COM		COL			FABRIC GRADES			LEATHER	
			1	2	3	4	5	6	7	8	9	
	30" Open Arm End Unit, Guest Back CRE2-EG30OPS	Beech, Maple	1243	1320	1404	1515	1644	1756	1886	2046	2210	
	30" Open Arm with arm cap End Unit, Guest Back CRE2-EG30OPP		1254	1334	1416	1529	1659	1771	1898	2034	2220	
	30" Closed Arm End Unit, Guest Back CRE2-EG30CLS	Beech, Maple	1386	1485	1579	1712	1860	1990	2139	2326	2513	
	30" Closed Arm with arm cap End Unit, Guest Back CRE2-EG30CLP		1396	1499	1590	1723	1871	2003	2149	2340	2526	
	44" Open Arm End Unit, Guest Back CRE2-EG44OPS	Beech, Maple	1530	1618	1706	1828	1968	2090	2234	2408	2585	
	44" Open Arm with arm cap End Unit, Guest Back CRE2-EG44OPP		1540	1631	1717	1840	1982	2105	2244	2419	2595	
	44" Closed Arm End Unit, Guest Back CRE2-EG44CLS	Beech, Maple	1672	1780	1883	2023	2186	2326	2487	2688	2890	
	44" Closed Arm with arm cap End Unit, Guest Back CRE2-EG44CLP		1686	1795	1894	2034	2196	2340	2497	2701	2902	

ORDERING NOTES: A drawing showing the configuration of the multiple seating and tables is required with each purchase order.
Additional features and options information see page 19, options upcharges page 85.

Patient backs are available on multiple units, please change the model number CRE2-SG to CRE2-SP, CRE2-CG to CRE2-CP, CRE2-EG to CRE2-EP and add the following upcharges per back:

	Grade 1	Grade 2	Grade 3	Grade 4	Grade 5	Grade 6	Grade 7	Grade 8	Grade 9
21" Chairs	82	95	108	126	148	164	186	213	239
24" Chairs	94	107	120	138	159	178	199	226	250
30" Chairs	134	151	168	190	217	240	268	302	336

PRODUCT CODE KEY

Line	Series	Chair Style	Size	Arm Style
CRE Cressida	2 Chair	SG Start Unit Guest Multiple Seating	21	OPS Open Arm
		CG Center Unit Multiple Seating	24	OPP Open Arm Polymer Arm Cap
		EG End Unit Multiple Seating	30	COS Closed Arm/Open Center Arm
			44	COP Closed Arm/Open Center Arm Polymer Arm Cap
				CLS Closed Arm
				CLP Closed Arm Polymer Arm Cap

CRESSIDA | MULTIPLE SEATING - FREESPAN UNITS

DIMENSIONS & COM REQUIREMENTS

UNIT WITH CENTER ARM												
	Overall Width	Overall Depth	Overall Height	Seat Height	Height of Arms from Floor	Width Between Arms	Seat Depth	Shipping Weight	Cube	COM Seat & Back Yardage	COM Fabric Seat Yardage	COM Fabric Back Yardage
PCFG21X2B	47.25	28.5	33.75	18.5	26	21	18.75	97	30	2.6	1.2	1.4
PCFP21X2B	47.25	28.5	43.5	18.5	26	21	18.75	103	38	3.19	1.2	2
PCFG21X3B	70	28.5	33.75	18.5	26	21	18.75	135	44	4.08	2	2.08
PCFP21X3B	70	28.5	43.5	18.5	26	21	18.75	145	56	5	2	3
PCFG24X2B	53.25	28.5	33.75	18.5	26	24	18.75	104	34	3.3	1.2	2.08
PCFP24X2B	53.25	28.5	43.5	18.5	26	24	18.75	111	43	4.2	1.2	2.95
PCFG24X3B	79	28.5	33.75	18.5	26	24	18.75	147	50	5.1	2	3.48
PCFP24X3B	79	28.5	43.5	18.5	26	24	18.75	157	63	6.24	2	4.9

UNIT WITH CENTER ARM, GUEST AND PATIENT BACKS			
Unit With Center Arm (Continued)	COM Fabric Closed Arm Panels (2 Arms)	COM Fabric Closed Arm Panels (3 Arms)	COM Fabric Closed Arm Panels (4 Arms)
PCF21X2B	.8	1.2	1.6
PCF21X3B	.8	1.2	1.6
PCF24X2B	.8	1.2	1.6
PCF24X3B	.8	1.2	1.6

Note: Some vinyls, leathers & upholsteries are not suitable for application on Cressida seating.

The approval process is as follows:

1. A sample of the COM must be provided to Krug Customer Service prior to or at the time of order.
2. The sample will be reviewed and the customer advised if the fabric is unsuitable.
3. The COM fabric or leather will be inspected when received at the factory, to identify any further concerns with its suitability.

WEIGHT CAPACITIES

Cressida weight capacities are as follows:

Multiple Seating & Pre-configured - 350 lbs per seat

ORDERING NOTES: A drawing showing the configuration of the multiple seating and tables is required with each purchase order.

Replacement seat and back covers can be quickly installed on Cressida products that were originally ordered with the Removeable cover option. Replacement seat and back covers can also be installed on Cressida products that were not originally ordered with the Removeable cover option, with some simple staple removal on the original seats and backs.

Cressida Option Upcharges	\$ List	\$ List
Moisture Barrier (per yard)	64	
Removable Seat Cover (per seat)	85	Combination Upholstery - dual fabrics (per chair) 33
Guest Removeable 21" & 24" Back Covers (per back)	54	Combination Upholstery - Three fabrics (per chair) 64
Patient Removeable 21" & 24" Back Covers (per back)	85	21" & 24" Cleanable Under-Seat Splashguard 59

Additional features and options information see page 19.

Patient backs are available on multiple units, please change the model number CRE2-SG to CRE2-SP, CRE2-CG to CRE2-CP, CRE2-EG to CRE2-EP and add the following upcharges per back:

	Grade 1	Grade 2	Grade 3	Grade 4	Grade 5	Grade 6	Grade 7	Grade 8	Grade 9
21" Chairs	82	95	108	126	148	164	186	213	239
24" Chairs	94	107	120	138	159	178	199	226	250

CRESSIDA | MULTIPLE SEATING - FREESPAN UNITS WITH CENTER ARMS

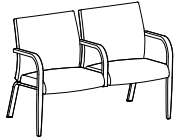
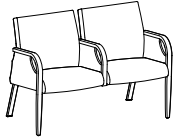
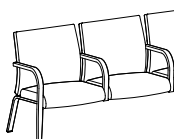
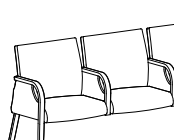
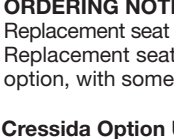
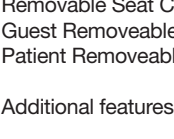
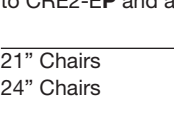
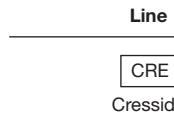
DESCRIPTION	MODEL	SPECIES	COM		COL			FABRIC GRADES		LEATHER		
			1	2	3	4	5	6	7	8	9	
	21" Pre-Configured Freespan Center Arm Unit - Open Arm 2 Seat, Guest Backs											
	CRE2-PCFG21X2OPS	Beech, Maple	2255	2373	2488	2652	2837	3001	3187	3423	3654	
	21" Pre-Configured Freespan Center Arm Unit - Open Arm with arm cap 2 Seat, Guest Backs											
	CRE2-PCFG21X2OPP		2291	2407	2523	2685	2872	3036	3221	3456	3688	
	21" Pre-Configured Freespan Center Arm Unit - Closed Arm 2 Seat, Guest Backs											
	CRE2-PCFG21X2CLS	Beech, Maple	2683	2861	3016	3235	3484	3701	3950	4258	4570	
	21" Pre-Configured Freespan Center Arm Unit - Closed Arm with arm cap 2 Seat, Guest Backs											
	CRE2-PCFG21X2CLP		2717	2896	3053	3269	3517	3736	3983	4292	4604	
	21" Pre-Configured Freespan Center Arm Unit - Open Arm 3 Seat, Guest Backs											
	CRE2-PCFG21X3OPS	Beech, Maple	3390	3564	3740	3984	4265	4509	4789	5140	5490	
	21" Pre-Configured Freespan Center Arm Unit - Open Arm with arm cap 3 Seat, Guest Backs											
	CRE2-PCFG21X3OPP		3435	3610	3787	4033	4312	4557	4837	5187	5536	
	21" Pre-Configured Freespan Center Arm Unit - Closed Arm 3 Seat, Guest Backs											
	CRE2-PCFG21X3CLS	Beech, Maple	3961	4217	4444	5063	5122	5441	5802	6255	6709	
	21" Pre-Configured Freespan Center Arm Unit - Closed Arm with arm cap 3 Seat, Guest Backs											
	CRE2-PCFG21X3CLP		4007	4265	4490	5110	5170	5488	5849	6300	6754	

ORDERING NOTES: A drawing showing the configuration of the multiple seating and tables is required with each purchase order. Replacement seat and back covers can be quickly installed on Cressida products that were originally ordered with the Removeable cover option. Replacement seat and back covers can also be installed on Cressida products that were not originally ordered with the Removeable cover option, with some simple staple removal on the original seats and backs.

Cressida Option Upcharges	\$ List	\$ List
Moisture Barrier (per yard)	64	Combination Upholstery - dual fabrics (per chair)
Removable Seat Cover (per seat)	85	Combination Upholstery - Three fabrics (per chair)
Guest Removeable 21" & 24" Back Covers (per back)	54	21" & 24" Cleanable Under-Seat Splashguard
Patient Removeable 21" & 24" Back Covers (per back)	85	

Additional features and options information see page 19.

Patient backs are available on multiple units, please change the model number CRE2-SG to CRE2-SP, CRE2-CG to CRE2-CP, CRE2-EG to CRE2-EP and add the following upcharges per back:

	Grade 1	Grade 2	Grade 3	Grade 4	Grade 5	Grade 6	Grade 7	Grade 8	Grade 9
21" Chairs	82	95	108	126	148	164	186	213	239
24" Chairs	94	107	120	138	159	178	199	226	250

PRODUCT CODE KEY

Line	Series	Chair Style	Size	Arm Style
CRE Cressida	2 Chair	PCFG Pre-configured Freespan Guest	21x2	OPS Open Arm
			21x3	OPP Open Arm Polymer Arm Cap
			24x2	CLS Closed Arm
			24x3	CLP Closed Arm Polymer Arm Cap

CRESSIDA | MULTIPLE SEATING - FREESPAN UNITS WITH CENTER ARMS

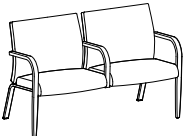
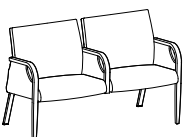
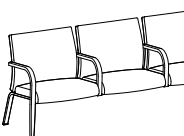
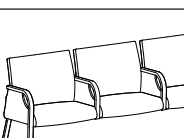
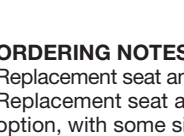
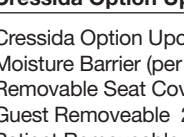
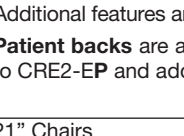
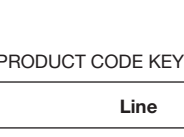
DESCRIPTION	MODEL	SPECIES	COM		COL				FABRIC GRADES			LEATHER	
			1	2	3	4	5	6	7	8	9		
	24" Pre-Configured Freespan Center Arm Unit - Open Arm 2 Seat, Guest Backs												
	CRE2-PCFG24X2OPS	Beech, Maple	2357	2476	2590	2753	2942	3103	3290	3522			
	24" Pre-Configured Freespan Center Arm Unit - Open Arm with arm cap 2 Seat, Guest Backs												
	CRE2-PCFG24X2OPP		2391	2508	2625	2789	2973	3137	3323	3559			
	24" Pre-Configured Freespan Center Arm Unit - Closed Arm 2 Seat, Guest Backs												
	CRE2-PCFG24X2CLS	Beech, Maple	2787	2964	3120	3340	3583	3803	4053	4361			
	24" Pre-Configured Freespan Center Arm Unit - Closed Arm with arm cap 2 Seat, Guest Backs												
	CRE2-PCFG24X2CLP		2820	2999	3156	3373	3619	3839	4086	4395			
	24" Pre-Configured Freespan Center Arm Unit - Open Arm 3 Seat, Guest Backs												
	CRE2-PCFG24X3OPS	Beech, Maple	3542	3715	3892	4138	4418	4663	4942	5292			
	24" Pre-Configured Freespan Center Arm Unit - Open Arm with arm cap 3 Seat, Guest Backs												
	CRE2-PCFG24X3OPP		3589	3763	3937	4184	4462	4708	4988	5338			
	24" Pre-Configured Freespan Center Arm Unit - Closed Arm 3 Seat, Guest Backs												
	CRE2-PCFG24X3CLS	Beech, Maple	4113	4370	4596	4915	5275	5593	5955	6408			
	24" Pre-Configured Freespan Center Arm Unit - Closed Arm with arm cap 3 Seat, Guest Backs												
	CRE2-PCFG24X3CLP		4160	4418	4643	4961	5322	5638	6000	6454			

ORDERING NOTES: A drawing showing the configuration of the multiple seating and tables is required with each purchase order. Replacement seat and back covers can be quickly installed on Cressida products that were originally ordered with the Removeable cover option. Replacement seat and back covers can also be installed on Cressida products that were not originally ordered with the Removeable cover option, with some simple staple removal on the original seats and backs.

Cressida Option Upcharges	\$ List		\$ List
Cressida Option Upcharges	64	Combination Upholstery - dual fabrics (per chair)	33
Moisture Barrier (per yard)	85	Combination Upholstery - Three fabrics (per chair)	64
Removable Seat Cover (per seat)	54	21" & 24" Cleanable Under-Seat Splashguard	59
Guest Removeable 21" & 24" Back Covers (per back)	85		
Patient Removeable 21" & 24" Back Covers (per back)			

Additional features and options information see page 19.





Patient backs are available on multiple units, please change the model number CRE2-SG to CRE2-SP, CRE2-CG to CRE2-CP, CRE2-EG to CRE2-EP and add the following upcharges per back:

	Grade 1	Grade 2	Grade 3	Grade 4	Grade 5	Grade 6	Grade 7	Grade 8	Grade 9
21" Chairs	82	95	108	126	148	164	186	213	239
24" Chairs	94	107	120	138	159	178	199	226	250



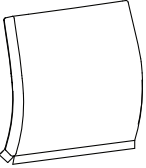
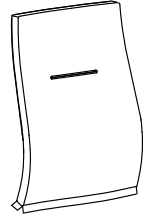

PRODUCT CODE KEY

Line	Series	Chair Style	Size	Arm Style
CRE Cressida	2 Chair	PCFG Pre-configured Freespan Guest	21x2	OPS Open Arm
			21x3	OPP Open Arm Polymer Arm Cap
			24x2	CLS Closed Arm
			24x3	CLP Closed Arm Polymer Arm Cap

CRESSIDA | GUEST & PATIENT REPLACEMENT COMPONENTS

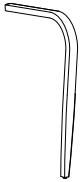
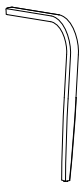
DESCRIPTION	MODEL	COM			COL			FABRIC GRADES			LEATHER			WEIGHT	CUBE
		1	2	3	4	5	6	7	8	9					
	21" Replacement Guest Back Cover CRE2-RBCG21	193	224	264	309	350	397	454	512				2	0.8	
	24" Replacement Guest Back Cover CRE2-RBCG24	195	224	265	309	350	397	454	513				2.3	0.8	
	30" Replacement Guest Back Cover CRE2-RBCG30	276	328	399	481	555	634	737	840				2.6	0.8	
	44" Replacement Guest Back Cover CRE2-RBCG44	290	339	411	492	565	648	751	852				3.5	0.8	
	21" Replacement Patient Back Cover CRE2-RBCP21	291	340	411	493	567	648	751	852				1.9	1.0	
	24" Replacement Patient Back Cover CRE2-RBCP24	302	353	424	509	580	661	763	868				2.7	1.0	
	30" Replacement Patient Back Cover CRE2-RBCP30	345	412	509	614	708	815	952	1084				3	1.0	
	21" Replacement Guest & Patient Seat CRE2-RS21	408	438	485	536	580	630	695	759				9.5	2.7	
	24" Replacement Guest & Patient Seat CRE2-RS24	441	473	516	567	613	664	727	791				10	2.7	
	30" Replacement Guest & Patient Seat CRE2-RS30	487	517	564	614	659	710	774	838				11.5	3.4	
	44" Replacement Guest & Patient Seat CRE2-RS44	598	637	695	760	815	879	959	1042				16.5	4.8	
	21" Replacement Guest & Patient Seat Cover CRE2-RSC21	198	229	273	322	368	420	483	546				1.6	0.8	
	24" Replacement Guest & Patient Seat Cover CRE2-RSC24	198	229	273	326	368	420	485	546				1.7	0.8	
	30" Replacement Guest & Patient Seat Cover CRE2-RSC30	199	231	274	327	369	422	485	547				2	1.0	
	44" Replacement Guest & Patient Seat Cover CRE2-RSC44	228	268	322	388	444	510	590	669				2.5	1.0	
	Replacement Guest & Patient Closed Arm Panel CRE2-RCAL	322	350	386	429	468	511	564	589				8	.5	
	CRE2-RCAR														
	CRE2-RCAC														
	CRE2-RCACPCF														

CRESSIDA | GUEST & PATIENT REPLACEMENT COMPONENTS

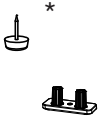
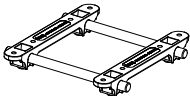
DESCRIPTION	MODEL	SPECIES	PRICE	WEIGHT CUBE	
	Replacement Guest & Patient Front Start Arm & Leg Open Arm				
	CRE2-RLFSOPS	Beech, Maple	169	4.0	1.3
	Open Arm Polymer Cap				
	CRE2-RLFSOPP	Beech, Maple	193	4.0	1.3
	Replacement Guest & Patient Front Center Arm & Leg Open Arm				
	CRE2-RLFCOPS	Beech, Maple	169	4.0	1.3
	Open Arm Polymer Cap				
	CRE2-RLFCOPP	Beech, Maple	193	4.0	1.3
	Replacement Guest & Patient Front End Arm & Leg Open Arm				
	CRE2-RLFEOPS	Beech, Maple	169	4.0	1.3
	Open Arm Polymer Cap				
	CRE2-RLFEOPP	Beech, Maple	193	4.0	1.3
	Replacement Polymer Arm Cap Black		26	1.0	.3
	CRE2-RACB				
	Replacement Polymer Arm Cap Grey		26		
	CRE2-RACG				
	Replacement Guest & Patient Center Freespan Arm Open Arm				
	CRE2-FFLOA	Beech, Maple	173	3.0	1.0
	Replacement Guest & Patient Back Leg		96	6.0	1.2
	CRE2-RLBS - Start				
	CRE2-RLBC - Center CRE2-RLBE -End				
	Replaceable Glide - Front* (1)		18	.25	.2
	CRE2-RGF				
	Replaceable Glide - Back** (1)		19	.25	.2
	CRE2-RGB				
	Replaceable Glide - Set of 4		22	1.0	.3
	CRE2-RG4				
	Chair to Chair Linking Bracket		67	1.5	5
	CRE2-RCCLKB				

SOLIS | MULTIPLE SEATING - GUEST BACKS

DIMENSIONS & COM. REQUIREMENTS - PRE-CONFIGURED UNITS

	Overall Width	Overall Depth	Overall Height	Seat Height	Height of Arms from Floor	Width Between Arms	Seat Depth	Shipping Weight	Cube	COM. Seat & Back Yardage	COM. Fabric Seat Yardage	COM. Fabric Back Yardage	COM. Fabric Closed Arm Panel Yardage
MESH BACK													
PCGM21X2	47	28	34.5	18.5	26	20	20	90	30	-	1.3	-	1.2
PCGM21X3	69.5	28	34.5	18.5	26	20	20	126	44	-	2.1	-	1.6
PCGM24X2	53	28	34.5	18.5	26	23	20	96	34	-	1.3	-	1.2
PCGM24X3	78.5	28	34.5	18.5	26	23	20	135	50	-	2.1	-	1.6
UPHOLSTERED BACK													
PCGU21X2	47	28	34.5	18.5	26	20	20	94	30	3.1	1.3	2.3	1.2
PCGU21X3	69.5	28	34.5	18.5	26	20	20	132	44	4.7	2.1	3.1	1.6
PCGU24X2	53	28	34.5	18.5	26	23	20	102	34	3.1	1.3	2.3	1.2
PCGU24X3	78.5	28	34.5	18.5	26	23	20	144	50	4.7	2.1	3.1	1.6

DIMENSIONS & COM. REQUIREMENTS - START UNITS

	Overall Width	Overall Depth	Overall Height	Seat Height	Height of Arms from Floor	Width Between Arms	Seat Depth	Shipping Weight	Cube	COM. Seat & Back Yardage	COM. Fabric Seat Yardage	COM. Fabric Back Yardage	COM. Fabric Closed Arm Panel (1 Arm) Yardage	COM. Fabric Closed Arm Panel (2 Arms) Yardage
MESH BACK														
SGM21	25	28	34.5	18.5	26	20	20	41	16	-	0.9	-	0.4	0.8
SGM24	28	28	34.5	18.5	26	23	20	44	18	-	0.9	-	0.4	0.8
UPHOLSTERED BACK														
SGU21	25	28	34.5	18.5	26	20	20	43	16	1.6	0.9	1.6	0.4	0.8
SGU24	28	28	34.5	18.5	26	23	20	47	18	1.6	0.9	1.6	0.4	0.8
SGU30	34	28	34.5	18.5	26	29	20	52	22	2.5	0.9	1.6	0.4	0.8
SGU44	48	28	34.5	18.5	26	43	20	66	31	3.2	1.1	2.5	0.4	0.8

DIMENSIONS & COM. REQUIREMENTS - CENTER UNITS

	Overall Width	Overall Depth	Overall Height	Seat Height	Height of Arms from Floor	Width Between Arms	Seat Depth	Shipping Weight	Cube	COM. Seat & Back Yardage	COM. Fabric Seat Yardage	COM. Fabric Back Yardage	COM. Fabric Closed Arm Panel Yardage
MESH BACK													
CGM21	23	28	34.5	18.5	26	20	20	35	16	-	0.9	-	0.4
CGM24	26	28	34.5	18.5	26	23	20	38	18	-	0.9	-	0.4
UPHOLSTERED BACK													
CGU21	23	28	34.5	18.5	26	20	20	37	16	1.6	0.9	1.6	0.4
CGU24	26	28	34.5	18.5	26	23	20	41	19	1.6	0.9	1.6	0.4
CGU30	32	28	34.5	18.5	26	29	20	46	22	2.5	0.9	1.6	0.4
CGU44	46	28	34.5	18.5	26	43	20	60	31	3.2	1.1	2.5	0.4

DIMENSIONS & COM. REQUIREMENTS - END UNITS

	Overall Width	Overall Depth	Overall Height	Seat Height	Height of Arms from Floor	Width Between Arms	Seat Depth	Shipping Weight	Cube	COM. Seat & Back Yardage	COM. Fabric Seat Yardage	COM. Fabric Back Yardage	COM. Fabric Closed Arm Panel Yardage
MESH BACK													
EGM21	23	28	34.5	18.5	26	20	20	35	16	-	0.9	-	0.4
EGM24	26	28	34.5	18.5	26	23	20	38	18	-	0.9	-	0.4
UPHOLSTERED BACK													
EGU21	23	28	34.5	18.5	26	20	20	37	16	1.6	0.9	1.6	0.4
EGU24	26	28	34.5	18.5	26	23	20	41	18	1.6	0.9	1.6	0.4
EGU30	32	28	34.5	18.5	26	29	20	46	22	2.5	0.9	1.6	0.4
EGU44	46	28	34.5	18.5	26	43	20	60	31	3.2	1.1	2.5	0.4

SOLIS | MULTIPLE SEATING - GUEST BACKS

DIMENSIONS & COM. REQUIREMENTS - FREESPAN WITH NO CENTER ARM

	Overall Width	Overall Depth	Overall Height	Seat Height	Height of Arms from Floor	Width Between Arms	Seat Depth	Shipping Weight	Cube	COM. Seat & Back Yardage	COM. Fabric Seat Yardage	COM. Fabric Back Yardage	COM. Fabric Closed Arm Panel Yardage
MESH BACK													
PCFGM21X2A	46.5	28	34.5	18.5	26	41.5	20	85	30	-	1.3	-	0.8
PCFGM21X3A	68	28	34.5	18.5	26	63	20	114	44	-	2.1	-	0.8
PCFGM24X2A	52.25	28	34.5	18.5	26	47.5	20	92	34	-	1.3	-	0.8
PCFGM24X3A	77	28	34.5	18.5	26	72	20	124	50	-	2.1	-	0.8
UPHOLSTERED BACK													
PCFGU21X2A	46.5	28	34.5	18.5	26	41.5	20	89	30	3.1	1.3	2.3	0.8
PCFGU21X3A	68	28	34.5	18.5	26	63	20	120	44	4.7	2.1	3.1	0.8
PCFGU24X2A	52.25	28	34.5	18.5	26	47.5	20	96	34	3.1	1.3	2.3	0.8
PCFGU24X3A	77	28	34.5	18.5	26	72	20	131	50	4.7	2.1	3.1	0.8

DIMENSIONS & COM. REQUIREMENTS - FREESPAN WITH CENTER ARM

	Overall Width	Overall Depth	Overall Height	Seat Height	Height of Arms from Floor	Width Between Arms	Seat Depth	Shipping Weight	Cube	COM. Seat & Back Yardage	COM. Fabric Seat Yardage	COM. Fabric Back Yardage
MESH BACK												
PCFGM21X2B	47.25	28	34.5	18.5	26	20	20	93	30	-	1.3	-
PCFGM21X3B	69.5	28	34.5	18.5	26	20	20	130	44	-	2.1	-
PCFGM24X2B	53.25	28	34.5	18.5	26	23	20	100	34	-	1.3	-
PCFGM24X3B	78.5	28	34.5	18.5	26	23	20	140	50	-	2.1	-
UPHOLSTERED BACK												
PCFGU21X2B	47.25	28	34.5	18.5	26	20	20	97	30	3.1	1.3	2.3
PCFGU21X3B	69.5	28	34.5	18.5	26	20	20	136	44	4.7	2.1	3.1
PCFGU24X2B	53.25	28	34.5	18.5	26	23	20	104	34	3.1	1.3	2.3
PCFGU24X3B	78.5	28	34.5	18.5	26	23	20	147	50	4.7	2.1	3.1
	COM. Fabric Closed Arm Panels (2 Arms)		COM. Fabric Closed Arm Panels (3 Arms)			COM. Fabric Closed Arm Panels (4 Arms)						
PCFG21X2B	0.8		1.2									
PCFG21X3B	0.8					1.6						
PCFG24X2B	0.8		1.2									
PCFG24X3B	0.8					1.6						

ORDERING NOTES: A drawing showing the configuration of the multiple seating and tables is required with each purchase order. Complete Mesh backs (21" & 24") can be ordered and field replaced.





Solis Pre-configured Guest Option Upcharges	\$ List	\$ List
CAL 133 & Moisture Barrier (per yard)	64	Maple Arm upgrade per arm (add to beech price)
Kinetic Back option (not available for 30" & 44")	120	Beech Wood Side Rails Upgrade (per chair)
Guest chair - Removable Seat Cover (per seat)	90	Solid Surface Arm (per pair) - Gr A White
21" & 24" - Removable Back Covers (per back)	58	Solid Surface Arm (per pair) - Gr A Color
30" & 44" - Removable Back Covers	90	Solid Surface Arm (per pair) - Gr B
Combination Upholstery - dual fabrics (per chair)	33	Solid Surface Arm (per pair) - Gr C
Combination Upholstery - Three fabrics (per chair)	64	Solid Surface Arm (per arm) - Gr A White
Beech Wood Side Rails Upgrade (per chair)	127	Solid Surface Arm (per arm) - Gr A Color
Maple wood Side Rails Upgrade (per chair)	159	Solid Surface Arm (per arm) - Gr B
21" & 24" Cleanable Under-seat Splashguard	40	Solid Surface Arm (per arm) - Gr C
30" Cleanable Under-seat Splashguard	48	Soft Casters (21" & 24" chairs) -4 set
44" Cleanable Under-seat Splashguard	64	Soft Casters (21" & 24" chairs) -2 set
Non-Marring Glide	37	Non-locking Casters (21" & 24" chairs) -4 set
Additional features and options information see page 24.		Non-locking Casters (21" & 24" chairs) -2 set

Note: Locking casters are available, clearly mark on the purchase order.

Closed Arm Panels (per chair) - please add the following up charges for closed arm panels.

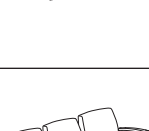
Fabric Grades	(COM) 1	2	(COL) 3	4	5	6	7	8	9
1 ARM	208	224	238	267	294	321	350	379	435
2 ARMS	418	448	477	531	588	643	699	757	869
3 ARMS	627	669	710	796	879	963	1048	1135	1304
4 ARMS	835	890	948	1061	1172	1285	1335	1510	1736

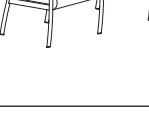
SOLIS | MULTIPLE SEATING - PRE-CONFIGURED GUEST UNITS

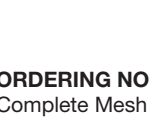
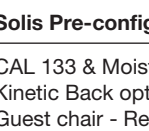
DESCRIPTION/MODEL	Arm Type	COM		COL		FABRIC GRADES			LEATHER		
		1	2	3	4	5	6	7	8	9	
	2 Seat - 21" Open Arm Pre-configured Guest Unit, Mesh Back										
	SOL2-PCGM21X2OPU	Urethane	1907	1971	2037	2170	2303	2436	2569	2701	2908
	SOL2-PCGM21X2OPW	Beech	2094	2163	2228	2360	2493	2628	2760	2891	3097
	2 Seat - 21" Open Arm Pre-configured Guest Unit, Upholstered Back										
	SOL2-PCGU21X2OPU	Urethane	2002	2110	2217	2432	2642	2859	3073	3289	3714
	SOL2-PCGU21X2OPW	Beech	2192	2301	2407	2621	2835	3052	3265	3479	3904
	3 Seat - 21" Open Arm Pre-configured Guest Unit, Mesh Back										
	SOL2-PCGM21X3OPU	Urethane	2735	2833	2933	3133	3330	3532	3731	3930	4237
	SOL2-PCGM21X3OPW	Beech	2987	3087	3186	3384	3582	3784	3982	4182	4488
	3 Seat - 21" Open Arm Pre-configured Guest Unit, Upholstered Back										
	SOL2-PCGU21X3OPU	Urethane	2874	3036	3194	3516	3839	4160	4480	4799	5443
	SOL2-PCGU21X3OPW	Beech	3129	3289	3449	3768	4089	4414	4734	5054	5695
	2 Seat - 24" Open Arm Pre-configured Guest Unit, Mesh Back										
	SOL2-PCGM24X2OPU	Urethane	1959	2026	2091	2223	2357	2489	2623	2756	2962
	SOL2-PCGM24X2OPW	Beech	2147	2215	2281	2415	2548	2681	2812	2946	3148
	2 Seat - 24" Open Arm Pre-configured Guest Unit, Upholstered Back										
	SOL2-PCGU24X2OPU	Urethane	2059	2166	2273	2487	2701	2916	3132	3345	3772
	SOL2-PCGU24X2OPW	Beech	2249	2356	2463	2678	2891	3104	3320	3535	3961
	3 Seat - 24" Open Arm Pre-configured Guest Unit, Mesh Back										
	SOL2-PCGM24X3OPU	Urethane	2818	2917	3016	3215	3414	3613	3814	4011	4319
	SOL2-PCGM24X3OPW	Beech	3070	3169	3269	3469	3668	3867	4066	4265	4573
	3 Seat - 24" Open Arm Pre-configured Guest Unit, Upholstered Back										
	SOL2-PCGU24X3OPU	Urethane	2963	3120	3279	3592	3906	4221	4534	4853	5479
	SOL2-PCGU24X3OPW	Beech	3215	3374	3533	3845	4160	4473	4788	5106	5734

ORDERING NOTES: A drawing showing the configuration of the multiple seating and tables is required with each purchase order. Complete Mesh backs (21" & 24") can be ordered and field replaced.

Solis Pre-configured Guest Option Upcharges

	\$ List
CAL 133 & Moisture Barrier (per yard)	64
Kinetic Back option (not available for 30" & 44")	120
Guest chair - Removable Seat Cover (per seat)	90
21" & 24" - Removeable Back Covers (per back)	58
Combination Upholstery - dual fabrics (per chair)	33
Combination Upholstery - Three fabrics (per chair)	64
Beech Wood Side Rails Upgrade (per chair)	127
Maple wood Side Rails Upgrade (per chair)	159
21" & 24" Cleanable Under-seat Splashguard	40
Non-Marring Glide	37
Maple Arm upgrade per arm (add to beech price)	80

Additional features and options information see page 24, closed arm panels page 97.

\$ List





	\$ List
Solid Surface Arm (per pair) - Gr A White	488
Solid Surface Arm (per pair) - Gr A Color	505
Solid Surface Arm (per pair) - Gr B	542
Solid Surface Arm (per pair) - Gr C	586
Solid Surface Arm (per arm) - Gr A White	244
Solid Surface Arm (per arm) - Gr A Color	253
Solid Surface Arm (per arm) - Gr B	271
Solid Surface Arm (per arm) - Gr C	293
Soft Casters (21" & 24" chairs) -4 set	64
Soft Casters (21" & 24" chairs) -2 set	33
Non-locking Casters (21" & 24" chairs) -4 set	120
Non-locking Casters (21" & 24" chairs) -2 set	80

Note: Locking casters are available, clearly mark on the purchase order.

PRODUCT CODE KEY

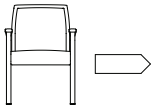
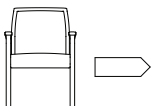
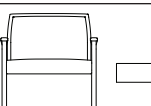
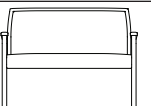
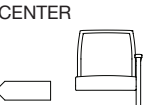
Line	Series	Chair Type	Back Type	Size	Arm Type
SOL	2	PCG	U	21X2	OPW CLW
Solis	Chair	Pre-configured Guest Multiple Unit	Upholstered Back		Open Arm - Wood Arm Closed Arm - Urethane Arm
			M	21X3	OPU CLU
			Mesh Back		Open Arm - Urethane Arm Closed Arm - Wood Arm
				24X2	OSA CSA
					Open Arm - Solid Surface Arm Closed Arm - Solid Surface Arm
				24X3	

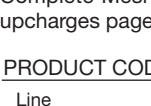
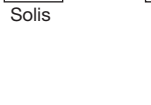
SOLIS | MULTIPLE SEATING - START, CENTER & END GUEST UNITS

DESCRIPTION/MODEL	Arm Type	COM		COL		FABRIC GRADES			LEATHER		
		1	2	3	4	5	6	7	8	9	
START											
21" Open Arm Start Guest Unit, Mesh Back											
	SOL2-SGM21OPU	Urethane	1012	1044	1080	1142	1209	1276	1342	1409	1512
	SOL2-SGM21OPW	Beech	1138	1170	1203	1270	1336	1403	1467	1536	1639
21" Open Arm Start Guest Unit, Upholstered Back											
	SOL2-SGU21OPU	Urethane	1063	1117	1170	1279	1384	1492	1598	1705	1920
	SOL2-SGU21OPW	Beech	1191	1244	1297	1404	1510	1618	1727	1833	2046
24" Open Arm Start Guest Unit, Mesh Back											
	SOL2-SGM24OPU	Urethane	1053	1086	1118	1185	1251	1316	1384	1451	1555
	SOL2-SGM24OPW	Beech	1178	1212	1245	1311	1377	1445	1510	1578	1678
24" Open Arm Start Guest Unit, Upholstered Back											
	SOL2-SGU24OPU	Urethane	1106	1158	1213	1317	1425	1534	1640	1747	1962
	SOL2-SGU24OPW	Beech	1230	1284	1340	1446	1555	1662	1767	1872	2088
30" Open Arm Start Guest Unit, Upholstered Back											
	SOL2-SGU30OPU	Urethane	1286	1372	1456	1622	1790	1957	2124	2294	2629
	SOL2-SGU30OPW	Beech	1415	1497	1584	1748	1915	2085	2250	2419	2754
44" Open Arm Start Guest Unit, Upholstered Back											
	SOL2-SGU44OPU	Urethane	1491	1572	1659	1822	1991	2160	2327	2493	2828
	SOL2-SGU44OPW	Beech	1617	1699	1782	1949	2118	2283	2453	2620	2956
CENTER											
21" Open Arm Center Guest Unit, Mesh Back											
	SOL2-CGM21OPU	Urethane	909	941	976	1039	1108	1172	1240	1307	1409
	SOL2-CGM21OPW	Beech	973	1004	1037	1106	1170	1237	1304	1371	1473
21" Open Arm Center Guest Unit, Upholstered Back											
	SOL2-CGU21OPU	Urethane	955	1008	1062	1169	1276	1383	1487	1597	1810
	SOL2-CGU21OPW	Beech	1017	1068	1124	1231	1340	1446	1554	1662	1872
24" Open Arm Center Guest Unit, Mesh Back											
	SOL2-CGM24OPU	Urethane	932	967	1001	1065	1134	1199	1266	1332	1434
	SOL2-CGM24OPW	Beech	997	1031	1063	1128	1195	1263	1330	1394	1497
24" Open Arm Center Guest Unit, Upholstered Back											
	SOL2-CGU24OPU	Urethane	983	1036	1090	1195	1304	1411	1518	1623	1839
	SOL2-CGU24OPW	Beech	1045	1097	1153	1260	1369	1477	1583	1688	1902

ORDERING NOTES: A drawing showing the configuration of the multiple seating and tables is required with each purchase order. Complete Mesh backs (21" & 24") can be ordered and field replaced. Additional features and options information see page 24, option upcharges page 97.

PRODUCT CODE KEY

Line	Series	Chair Type	Back Type	Size	Arm Type
SOL	2	SG	U	21	OPW
Solis	Chair	Start Unit Guest Multiple Seating	Upholstered Back		Open Arm - Wood Arm
		CG	M	24	OPU
		Center Unit Guest Multiple Seating	Mesh Back 21" & 24" Only		Open Arm - Urethane Arm
		EG		30	OSA
		End Unit Guest Multiple Seating			Open Arm - Solid Surface Arm
				44	CSA
					Closed Arm - Solid Surface Arm
					COW
					Closed Start Arm / Open Center Arm - Wood Arm
					COU
					Closed Arm / Open Center Arm - Urethane Arm

SOLIS | MULTIPLE SEATING - CENTER & END GUEST UNITS

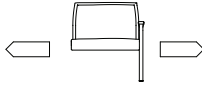
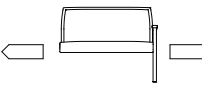
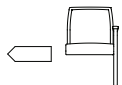
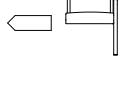
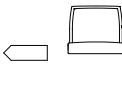
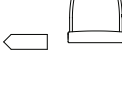
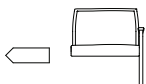
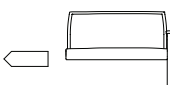



DESCRIPTION/MODEL	Arm Type	COM		COL		FABRIC GRADES			LEATHER	
		1	2	3	4	5	6	7	8	9
 30" Open Arm Center Guest Unit, Upholstered Back SOL2-CGU30OPU SOL2-CGU30OPW	Urethane	1147	1230	1314	1483	1647	1817	1985	2148	2486
	Beech	1212	1294	1377	1547	1713	1881	2048	2214	2549
 44" Open Arm Center Guest Unit, Upholstered Back SOL2-CGU44OPU SOL2-CGU44OPW	Urethane	1341	1425	1509	1676	1844	2010	2177	2345	2681
	Beech	1404	1491	1570	1741	1908	2072	2241	2408	2743
END  21" Open Arm End Guest Unit, Mesh Back SOL2-EGM21OPU SOL2-EGM21OPW	Urethane	909	941	976	1039	1108	1172	1240	1307	1409
	Beech	973	1004	1037	1106	1170	1237	1304	1371	1473
 21" Open Arm End Guest Unit, Upholstered Back SOL2-EGU21OPU SOL2-EGU21OPW	Urethane	955	1008	1062	1169	1276	1383	1487	1597	1810
	Beech	1017	1068	1124	1231	1340	1446	1554	1662	1872
 24" Open Arm End Guest Unit, Mesh Back SOL2-EGM24OPU SOL2-EGM24OPW	Urethane	932	967	1001	1065	1134	1199	1266	1332	1434
	Beech	997	1031	1063	1128	1195	1263	1330	1394	1497
 24" Open Arm End Guest Unit, Upholstered Back SOL2-EGU24OPU SOL2-EGU24OPW	Urethane	983	1036	1090	1195	1304	1411	1518	1623	1839
	Beech	1045	1097	1153	1260	1369	1477	1583	1688	1902
 30" Open Arm End Guest Unit, Upholstered Back SOL2-EGU30OPU SOL2-EGU30OPW	Urethane	1147	1230	1314	1483	1647	1817	1985	2148	2486
	Beech	1212	1294	1377	1547	1713	1881	2048	2214	2549
 44" Open Arm End Guest Unit, Upholstered Back SOL2-EGU44OPU SOL2-EGU44OPW	Urethane	1341	1428	1509	1676	1844	2010	2177	2345	2681
	Beech	1404	1491	1570	1741	1908	2072	2241	2408	2743

ORDERING NOTES: A drawing showing the configuration of the multiple seating and tables is required with each purchase order. Complete Mesh backs (21" & 24") can be ordered and field replaced. Additional features and options information see page 24, option upcharges page 97.

PRODUCT CODE KEY

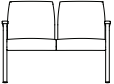
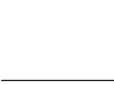
Line	Series	Chair Type	Back Type	Size	Arm Type	
SOL	2	SG	U	21	OPW	CLW
Solis	Chair	Start Unit Guest Multiple Seating	Upholstered Back		Open Arm - Wood Arm	Closed Arm - Wood Arm
		CG	M	24	OPU	CLU
		Center Unit Guest Multiple Seating	Mesh Back 21" & 24" Only		Open Arm - Urethane Arm	Closed Arm Urethane Arm
		EG		30	OSA	CSA
		End Unit Guest Multiple Seating			Open Arm - Solid Surface Arm	Closed Arm - Solid Surface Arm
				44		

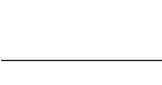
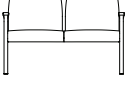
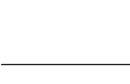
SOLIS | PRE-CONFIGURED FREESPAN MULTIPLE SEATING GUEST UNIT WITHOUT CENTER ARM

DESCRIPTION/MODEL	Arm Type	COM		COL		FABRIC GRADES			LEATHER		
		1	2	3	4	5	6	7	8	9	
	21" Pre-Configured Freespan Guest Unit - Open Arm 2 Seat, Mesh Back										
	SOL2-PCFGM21X2AOPU	Urethane	1808	1855	1902	1997	2091	2188	2281	2377	2518
	SOL2-PCFGM21X2AOPW	Beech	1934	1981	2030	2124	2218	2313	2408	2503	2642
	21" Pre-Configured Freespan Guest Unit - Open Arm 2 Seat, Upholstered Back										
	SOL2-PCFGU21X2AOPU	Urethane	1902	2007	2114	2328	2542	2757	2970	3186	3613
	SOL2-PCFGU21X2AOPW	Beech	2030	2134	2241	2457	2669	2883	3097	3313	3741
	21" Pre-Configured Freespan Guest Unit - Open Arm 3 Seat, Mesh Back										
	SOL2-PCFGM21X3AOPU	Urethane	2527	2596	2669	2810	2954	3096	3238	3381	3594
	SOL2-PCFGM21X3AOPW	Beech	2654	2723	2794	2936	3080	3221	3364	3507	3718
	21" Pre-Configured Freespan Guest Unit - Open Arm 3 Seat, Upholstered Back										
	SOL2-PCFGU21X3AOPU	Urethane	2659	2819	2982	3301	3620	3941	4263	4584	5229
	SOL2-PCFGU21X3AOPW	Beech	2787	2946	3105	3428	3745	4068	4392	4710	5353
	24" Pre-Configured Freespan Guest Unit - Open Arm 2 Seat, Mesh Back										
	SOL2-PCFGM24X2AOPU	Urethane	1849	1896	1944	2037	2133	2228	2323	2418	2560
	SOL2-PCFGM24X2AOPW	Beech	1976	2023	2069	2165	2257	2355	2449	2543	2685
	24" Pre-Configured Freespan Guest Unit - Open Arm 2 Seat, Upholstered Back										
	SOL2-PCFGU24X2AOPU	Urethane	1944	2053	2158	2373	2587	2802	3014	3229	3656
	SOL2-PCFGU24X2AOPW	Beech	2069	2176	2282	2497	2714	2927	3141	3355	3784
	24" Pre-Configured Freespan Guest Unit - Open Arm 3 Seat, Mesh Back										
	SOL2-PCFGM24X3AOPU	Urethane	2589	2659	2732	2873	3014	3159	3299	3441	3655
	SOL2-PCFGM24X3AOPW	Beech	2715	2787	2857	2998	3141	3285	3427	3566	3783
	24" Pre-Configured Freespan Guest Unit - Open Arm 3 Seat, Upholstered Back										
	SOL2-PCFGU24X3AOPU	Urethane	2719	2882	3042	3364	3685	4007	4328	4646	5289
	SOL2-PCFGU24X3AOPW	Beech	2848	3009	3167	3490	3812	4133	4456	4774	5418

ORDERING NOTES: A drawing showing the configuration of the multiple seating and tables is required with each purchase order. Complete Mesh backs (21" & 24") can be ordered and field replaced.

Solis Pre-configured Guest Option Upcharges	\$ List	\$ List	
CAL 133 & Moisture Barrier (per yard)	64	Maple Arm upgrade per arm (add to beech price)	80
Kinetic Back option (not available for 30" & 44")	120	Solid Surface Arm (per pair) - Gr A White	488
Guest chair - Removable Seat Cover (per seat)	90	Solid Surface Arm (per pair) - Gr A Color	505
21" & 24" - Removeable Back Covers (per back)	58	Solid Surface Arm (per pair) - Gr B	542
Combination Upholstery - dual fabrics (per chair)	33	Solid Surface Arm (per pair) - Gr C	586
Combination Upholstery - Three fabrics (per chair)	64	Non-Marring Glide	37
Beech Wood Side Rails Upgrade (per chair)	127	Soft Casters (21" & 24" chairs) -4 set	64
Maple wood Side Rails Upgrade (per chair)	159	Soft Casters (21" & 24" chairs) -2 set	33
21" & 24" Cleanable Under-seat Splashguard	40	Non-locking Casters (21" & 24" chairs) -4 set	120
		Non-locking Casters (21" & 24" chairs) -2 set	80







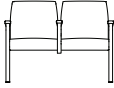

Note: Locking casters are available, clearly mark on the purchase order.

Additional features and options information see page 24, closed arm panels page 97.

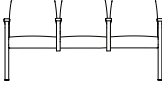
PRODUCT CODE KEY

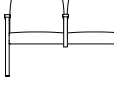
Line	Series	Chair Type	Back Type	Size	Unit Style	Arm Type
SOL	2	PCFG	U	21X2	A	OPW
Solis	Chair	Pre-Configured Freespan Multiple Guest Unit	Upholstered Back		Unit with no Center Arm	Open Arm
			M	21X3	B	OPU
			Mesh Back		Unit with Center Arm	Open Arm Urethane Arm
				24X2		CLW
						Closed Arm - Wood Arm
				24X3		CLU
						Closed Arm Urethane Arm

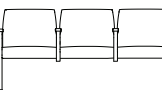
SOLIS | PRE-CONFIGURED FREESPAN MULTIPLE SEATING GUEST UNIT WITH CENTER ARM

DESCRIPTION/MODEL	Arm Type	COM		COL		FABRIC GRADES			LEATHER	
		1	2	3	4	5	6	7	8	9
	21" Pre-Configured Freespan Center Arm Guest Unit - Open Arm 2 Seat, Mesh Back									
	SOL2-PCFGM21X2BOPU Urethane	1951	1999	2046	2140	2237	2329	2423	2520	2663
	SOL2-PCFGM21X2BOPW Beech	2140	2190	2237	2329	2423	2520	2614	2712	2852
	21" Pre-Configured Freespan Center Arm Guest Unit - Open Arm 2 Seat, Upholstered Back									
	SOL2-PCFGU21X2BOPU Urethane	2053	2160	2266	2480	2694	2908	3120	3336	3763
	SOL2-PCFGU21X2BOPW Beech	2240	2347	2457	2669	2882	3097	3312	3528	3954
	21" Pre-Configured Freespan Center Arm Guest Unit - Open Arm 3 Seat, Mesh Back									
	SOL2-PCFGM21X3BOPU Urethane	2748	2822	2893	3036	3179	3320	3461	3605	3818
	SOL2-PCFGM21X3BOPW Beech	3004	3074	3145	3289	3430	3574	3714	3856	4070
	21" Pre-Configured Freespan Center Arm Guest Unit - Open Arm 3 Seat, Upholstered Back									
	SOL2-PCFGU21X3BOPU Urethane	2894	3055	3215	3535	3856	4179	4499	4821	5464
	SOL2-PCFGU21X3BOPW Beech	3146	3307	3469	3788	4111	4429	4752	5075	5717
	24" Pre-Configured Freespan Center Arm Guest Unit - Open Arm 2 Seat, Mesh Back									
	SOL2-PCFGM24X2BOPU Urethane	1990	2037	2086	2180	2277	2370	2464	2560	2701
	SOL2-PCFGM24X2BOPW Beech	2180	2228	2277	2370	2464	2560	2656	2747	2891
	24" Pre-Configured Freespan Center Arm Guest Unit - Open Arm 2 Seat, Upholstered Back									
	SOL2-PCFGU24X2BOPU Urethane	2091	2201	2307	2522	2736	2949	3163	3379	3806
	SOL2-PCFGU24X2BOPW Beech	2281	2390	2496	2713	2926	3140	3353	3566	3995
	24" Pre-Configured Freespan Center Arm Guest Unit - Open Arm 3 Seat, Mesh Back									
	SOL2-PCFGM24X3BOPU Urethane	2812	2883	2956	3097	3239	3382	3522	3666	3880
	SOL2-PCFGM24X3BOPW Beech	3067	3136	3208	3349	3491	3635	3776	3919	4132
	24" Pre-Configured Freespan Center Arm Guest Unit - Open Arm 3 Seat, Upholstered Back									
	SOL2-PCFGU24X3BOPU Urethane	2958	3117	3279	3599	3920	4243	4562	4885	5527
	SOL2-PCFGU24X3BOPW Beech	3210	3371	3533	3852	4173	4498	4815	5137	5781

ORDERING NOTES: A drawing showing the configuration of the multiple seating and tables is required with each purchase order. Complete Mesh backs (21" & 24") can be ordered and field replaced.

Solis Pre-configured Guest Option Upcharges	\$ List	\$ List
CAL 133 & Moisture Barrier (per yard)	64	Maple Arm upgrade per arm (add to beech price)
Kinetic Back option (not available for 30" & 44")	120	Solid Surface Arm (per pair) - Gr A White
Guest chair - Removable Seat Cover (per seat)	90	Solid Surface Arm (per pair) - Gr A Color
21" & 24" - Removeable Back Covers (per back)	58	Solid Surface Arm (per pair) - Gr B
Combination Upholstery - dual fabrics (per chair)	33	Solid Surface Arm (per pair) - Gr C
Combination Upholstery - Three fabrics (per chair)	64	Non-Marring Glide
Beech Wood Side Rails Upgrade (per chair)	127	Soft Casters (21" & 24" chairs) -4 set
Maple wood Side Rails Upgrade (per chair)	159	Soft Casters (21" & 24" chairs) -2 set
21" & 24" Cleanable Under-seat Splashguard	40	Non-locking Casters (21" & 24" chairs) -4 set
		Non-locking Casters (21" & 24" chairs) -2 set
		Note: Locking casters are available, clearly mark on the purchase order.

Additional features and options information see page 24, closed arm panels page 97.

PRODUCT CODE KEY

Line	Series	Chair Type	Back Type	Size	Unit Style	Arm Type
SOL	2	PCFG	U	21X2	A	OPW
Solis	Chair	Pre-Configured Freespan Multiple Guest Unit	Upholstered Back		Unit with no Center Arm	Open Arm - Wood Arm
			M	21X3	B	OPU
			Mesh Back		Unit with Center Arm	Open Arm Urethane Arm
				24X2		CLW
						Closed Arm - Wood Arm
				24X3		CLU
						Closed Arm Urethane Arm

SOLIS | MULTIPLE SEATING - PATIENT BACKS

DIMENSIONS & COM. REQUIREMENTS - PRE-CONFIGURED UNITS

	Overall Width	Overall Depth	Overall Height	Seat Height	Height of Arms from Floor	Width Between Arms	Seat Depth	Shipping Weight	Cube	COM. Seat & Back Yardage	COM. Fabric Seat Yardage	COM. Fabric Back Yardage	COM. Fabric Closed Arm Panel Yardage
MESH BACK													
PCPM21X2	47	28	43.75	18.5	26	20	20	92	38	-	1.3	-	1.2
PCPM21X3	69.5	28	43.75	18.5	26	20	20	129	56	-	2.1	-	1.6
PCPM24X2	53	28	43.75	18.5	26	23	20	98	43	-	1.3	-	1.2
PCPM24X3	78.5	28	43.75	18.5	26	23	20	138	46	-	2.1	-	1.6
UPHOLSTERED BACK													
PCPU21X2	47	28	43.75	18.5	26	20	20	100	38	4.0	1.3	3.1	1.2
PCPU21X3	69.5	28	43.75	18.5	26	20	20	141	56	6.1	2.1	4.2	1.6
PCPU24X2	53	28	43.75	18.5	26	23	20	108	43	4.0	1.3	3.1	1.2
PCPU24X3	78.5	28	43.75	18.5	26	23	20	153	63	6.1	2.1	4.2	1.6

DIMENSIONS & COM. REQUIREMENTS - START UNITS

	Overall Width	Overall Depth	Overall Height	Seat Height	Height of Arms from Floor	Width Between Arms	Seat Depth	Shipping Weight	Cube	COM. Seat & Back Yardage	COM. Fabric Seat Yardage	COM. Fabric Back Yardage	COM. Fabric Closed Arm Panel (1 Arm) Yardage	COM. Fabric Closed Arm Panel (2 Arms) Yardage
MESH BACK														
SPM21	25	28	43.75	18.5	26	20	20	42	21	-	0.9	-	0.4	0.8
SPM24	28	28	43.75	18.5	26	23	20	45	23	-	0.9	-	0.4	0.8
UPHOLSTERED BACK														
SPU21	25	28	43.75	18.5	26	20	20	46	21	2.1	0.9	2.0	0.4	0.8
SPU24	28	28	43.75	18.5	26	23	20	50	23	2.1	0.9	2.0	0.4	0.8
SPU30	34	28	43.75	18.5	26	29	20	56	28	3.1	0.9	2.2	0.4	0.8

DIMENSIONS & COM. REQUIREMENTS - CENTER UNITS

	Overall Width	Overall Depth	Overall Height	Seat Height	Height of Arms from Floor	Width Between Arms	Seat Depth	Shipping Weight	Cube	COM. Seat & Back Yardage	COM. Fabric Seat Yardage	COM. Fabric Back Yardage	COM. Fabric Closed Arm Panel Yardage
MESH BACK													
CPM21	23	28	43.75	18.5	26	20	20	36	21	-	0.9	-	0.4
CPM24	26	28	43.75	18.5	26	23	20	39	23	-	0.9	-	0.4
UPHOLSTERED BACK													
CPU21	23	28	43.75	18.5	26	20	20	40	21	2.1	0.9	2.0	0.4
CPU24	26	28	43.75	18.5	26	23	20	44	23	2.1	0.9	2.0	0.4
CPU30	32	28	43.75	18.5	26	29	20	50	28	3.1	0.9	2.2	0.4

DIMENSIONS & COM. REQUIREMENTS - END UNITS

	Overall Width	Overall Depth	Overall Height	Seat Height	Height of Arms from Floor	Width Between Arms	Seat Depth	Shipping Weight	Cube	COM. Seat & Back Yardage	COM. Fabric Seat Yardage	COM. Fabric Back Yardage	COM. Fabric Closed Arm Panel Yardage
MESH BACK													
EPM21	23	28	43.75	18.5	26	20	20	36	21	-	0.9	-	0.4
EPM24	26	28	43.75	18.5	26	23	20	38	23	-	0.9	-	0.4
UPHOLSTERED BACK													
EPU21	23	28	43.75	18.5	26	20	20	40	21	2.1	0.9	2.0	0.4
EPU24	26	28	43.75	18.5	26	23	20	44	23	2.1	0.9	2.0	0.4
EPU30	32	28	43.75	18.5	26	29	20	50	28	3.1	0.9	2.2	0.4

SOLIS | MULTIPLE SEATING - PATIENT BACKS

DIMENSIONS & COM. REQUIREMENTS - FREESPAN WITH NO CENTER ARM

	Overall Width	Overall Depth	Overall Height	Seat Height	Height of Arms from Floor	Width Between Arms	Seat Depth	Shipping Weight	Cube	COM. Seat & Back Yardage	COM. Fabric Seat Yardage	COM. Fabric Back Yardage	COM. Fabric Closed Arm Panel Yardage
MESH BACK													
PCFPM21X2A	46.5	28	43.75	18.5	26	41.5	20	87	38	-	1.3	-	0.8
PCFPM21X3A	68	28	43.75	18.5	26	63	20	118	56	-	2.1	-	0.8
PCFPM24X2A	52.25	28	43.75	18.5	26	47.5	20	94	43	-	1.3	-	0.8
PCFPM24X3A	77	28	43.75	18.5	26	72	20	128	63	-	2.1	-	0.8
UPHOLSTERED BACK													
PCFPU21X2A	46.5	28	43.75	18.5	26	41.5	20	95	38	4.0	1.3	3.1	0.8
PCFPU21X3A	68	28	43.75	18.5	26	63	20	129	56	6.1	2.1	4.2	0.8
PCFPU24X2A	52.25	28	43.75	18.5	26	47.5	20	103	43	4.0	1.3	3.1	0.8
PCFPU24X3A	77	28	43.75	18.5	26	72	20	141	63	6.1	2.1	4.2	0.8

DIMENSIONS & COM. REQUIREMENTS - FREESPAN WITH CENTER ARM

	Overall Width	Overall Depth	Overall Height	Seat Height	Height of Arms from Floor	Width Between Arms	Seat Depth	Shipping Weight	Cube	COM. Seat & Back Yardage	COM. Fabric Seat Yardage	COM. Fabric Back Yardage
MESH BACK												
PCFPM21X2B	47.25	28	43.75	18.5	26	20	20	96	38	-	1.3	-
PCFPM21X3B	69.5	28	43.75	18.5	26	20	20	134	56	-	2.1	-
PCFPM24X2B	53.25	28	43.75	18.5	26	23	20	102	43	-	1.3	-
PCFPM24X3B	78.5	28	43.75	18.5	26	23	20	144	63	-	2.1	-
UPHOLSTERED BACK3.4												
PCFPU21X2B	47.25	28	43.75	18.5	26	20	20	103	38	4.0	1.3	3.4
PCFPU21X3B	69.5	28	43.75	18.5	26	20	20	145	56	6.1	2.1	5.4
PCFPU24X2B	53.25	28	43.75	18.5	26	23	20	111	43	4.0	1.3	3.4
PCFPU24X3B	78.5	28	43.75	18.5	26	23	20	157	63	6.1	2.1	5.4

	COM. Fabric Closed Arm Panels (2 Arms)	COM. Fabric Closed Arm Panels (3 Arms)	COM. Fabric Closed Arm Panels (4 Arms)
PCFP21X2B	0.8	1.2	
PCFP21X3B	0.8		1.6
PCFP24X2B	0.8	1.2	
PCFP24X3B	0.8		1.6

ORDERING NOTES: A drawing showing the configuration of the multiple seating and tables is required with each purchase order. Complete Mesh backs (21" & 24") can be ordered and field replaced.

Solis Pre-configured Patient Option Upcharges	\$ List		\$ List
CAL 133 & Moisture Barrier (per yard)	64	Maple Arm upgrade per arm (add to beech price)	80
Kinetic Back option (not available for 30" & 44")	120	Beech Wood Side Rails Upgrade (per chair)	127
Patient chair - Removable Seat Cover (per seat)	90	Solid Surface Arm (per pair) - Gr A White	488
21" & 24" - Removeable Back Covers (per back)	61	Solid Surface Arm (per pair) - Gr A Color	505
30" & 44" - Removeable Back Covers	94	Solid Surface Arm (per pair) - Gr B	542
Combination Upholstery - dual fabrics (per chair)	33	Solid Surface Arm (per pair) - Gr C	586
Combination Upholstery - Three fabrics (per chair)	64	Non-Marring Glide	37
Beech Wood Side Rails Upgrade (per chair)	127	Soft Casters (21" & 24" chairs) -4 set	64
Maple wood Side Rails Upgrade (per chair)	159	Soft Casters (21" & 24" chairs) -2 set	33
21" & 24" Cleanable Under-seat Splashguard	40	Non-locking Casters (21" & 24" chairs) -4 set	120
30" Cleanable Under-seat Splashguard	48	Non-locking Casters (21" & 24" chairs) -2 set	80
44" Cleanable Under-seat Splashguard	64		





Note: Locking casters are available, clearly mark on the purchase order.

Additional features and options information see page 24.

Closed Arm Panels (per chair) - please add the following up charges for closed arm panels.

Fabric Grades	(COM) 1	2	(COL) 3	4	5	6	7	8	9
1 ARM	208	224	238	267	294	321	350	379	435
2 ARMS	418	448	477	531	588	643	699	757	869
3 ARMS	627	669	710	796	879	963	1048	1135	1304
4 ARMS	835	890	948	1061	1172	1285	1335	1510	1736

SOLIS | MULTIPLE SEATING - PRE-CONFIGURED PATIENT UNITS

DESCRIPTION/MODEL	Arm Type	COM		COL		FABRIC GRADES			LEATHER		
		1	2	3	4	5	6	7	8	9	
	2 Seat - 21" Open Arm Pre-configured Patient Unit, Mesh Back										
	SOL2-PCPM21X2OPU	Urethane	2104	2169	2237	2369	2502	2635	2767	2899	3104
	SOL2-PCPM21X2OPW	Beech	2294	2359	2423	2559	2692	2823	2957	3090	3294
	2 Seat - 21" Open Arm Pre-configured Patient Unit, Upholstered Back										
	SOL2-PCPU21X2OPU	Urethane	2211	2345	2480	2745	3014	3283	3547	3816	4352
	SOL2-PCPU21X2OPW	Beech	2401	2533	2669	2934	3206	3471	3739	4006	4540
	3 Seat - 21" Open Arm Pre-configured Patient Unit, Mesh Back										
	SOL2-PCPM21X3OPU	Urethane	3043	3144	3244	3444	3642	3843	4040	4239	4547
	SOL2-PCPM21X3OPW	Beech	3297	3403	3507	3697	3895	4093	4292	4491	4799
	3 Seat - 21" Open Arm Pre-configured Patient Unit, Upholstered Back										
	SOL2-PCPU21X3OPU	Urethane	3203	3408	3609	4020	4426	4861	5242	5650	6466
	SOL2-PCPU21X3OPW	Beech	3455	3661	3865	4271	4679	5113	5495	5904	6718
	2 Seat - 24" Open Arm Urethane Cap Pre-configured Patient Unit, Mesh Back										
	SOL2-PCPM24X2OPU	Urethane	2132	2196	2265	2396	2530	2663	2794	2928	3134
	SOL2-PCPM24X2OPW	Beech	2321	2387	2453	2587	2718	2852	2986	3117	3322
	2 Seat - 24" Open Arm Pre-configured Patient Unit, Upholstered Back										
	SOL2-PCPU24X2OPU	Urethane	2240	2376	2508	2778	3043	3313	3579	3847	4381
	SOL2-PCPU24X2OPW	Beech	2431	2564	2698	2966	3236	3501	3768	4038	4571
	3 Seat - 24" Open Arm Pre-configured Patient Unit, Mesh Back										
	SOL2-PCPM24X3OPU	Urethane	3102	3203	3301	3499	3699	3898	4098	4295	4606
	SOL2-PCPM24X3OPW	Beech	3355	3455	3554	3753	3953	4152	4350	4548	4859
	3 Seat - 24" Open Arm Pre-configured Patient Unit, Upholstered Back										
	SOL2-PCPU24X3OPU	Urethane	3260	3465	3669	4077	4486	4891	5302	5710	6527
	SOL2-PCPU24X3OPW	Beech	3513	3717	3921	4331	4738	5145	5554	5964	6780

ORDERING NOTES: A drawing showing the configuration of the multiple seating and tables is required with each purchase order. Complete Mesh backs (21" & 24") can be ordered and field replaced.

Solis Pre-configured Patient Option Upcharges	\$ List	\$ List	
CAL 133 & Moisture Barrier (per yard)	64	Beech Wood Side Rails Upgrade (per chair)	127
Kinetic Back option (not available for 30" & 44")	120	Solid Surface Arm (per pair) - Gr A White	488
Patient chair - Removable Seat Cover (per seat)	90	Solid Surface Arm (per pair) - Gr A Color	505
21" & 24" - Removeable Back Covers (per back)	61	Solid Surface Arm (per pair) - Gr B	542
Combination Upholstery - dual fabrics (per chair)	33	Solid Surface Arm (per pair) - Gr C	586
Combination Upholstery - Three fabrics (per chair)	64	Solid Surface Arm (per arm) - Gr A White	244
Beech Wood Side Rails Upgrade (per chair)	127	Solid Surface Arm (per arm) - Gr A Color	253
Maple wood Side Rails Upgrade (per chair)	159	Solid Surface Arm (per arm) - Gr B	271
21" & 24" Cleanable Under-seat Splashguard	40	Solid Surface Arm (per arm) - Gr C	293
Non-Marring Glide	37	Soft Casters (21" & 24" chairs) -4 set	64
Maple Arm upgrade per arm (add to beech price)	80	Soft Casters (21" & 24" chairs) -2 set	33
		Non-locking Casters (21" & 24" chairs) -4 set	120
		Non-locking Casters (21" & 24" chairs) -2 set	80

Additional features and options information see page 24, closed arm panel upcharges page 104.

Note: Locking casters are available, clearly mark on the purchase order.

PRODUCT CODE KEY

Line	Series	Chair Type	Back Type	Size	Arm Type
SOL	2	PCP	U	21X2	OPW
Solis	Chair	Pre-configured Patient Multiple Unit	Upholstered Back		Open Arm - Wood Arm
			M	21X3	OPU
			Mesh Back		Open Arm Urethane Arm
				24X2	CLW
					Closed Arm - Wood Arm
				24X3	CLU
					Closed Arm Urethane Arm

SOLIS | MULTIPLE SEATING - PATIENT START & CENTER UNITS

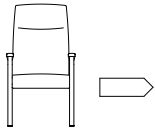
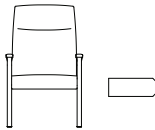
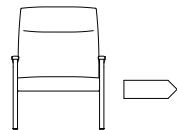
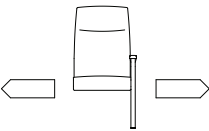
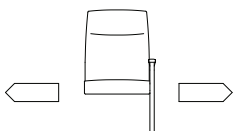
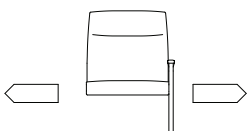
DESCRIPTION/MODEL	Arm Type	COM		COL		FABRIC GRADES			LEATHER		
		1	2	3	4	5	6	7	8	9	
	21" Open Arm Start Patient Unit, Mesh Back										
	SOL2-SPM21OPU	Urethane	1107	1139	1171	1239	1306	1372	1438	1504	1607
	SOL2-SPM21OPW	Beech	1231	1266	1298	1363	1431	1497	1563	1632	1732
	21" Open Arm Start Patient Unit, Upholstered Back										
	SOL2-SPU21OPU	Urethane	1163	1231	1304	1445	1584	1727	1863	2004	2285
	SOL2-SPU21OPW	Beech	1289	1358	1430	1569	1709	1853	1990	2132	2412
	24" Open Arm Start Patient Unit, Mesh Back										
	SOL2-SPM24OPU	Urethane	1143	1178	1212	1279	1345	1411	1479	1543	1645
	SOL2-SPM24OPW	Beech	1271	1306	1338	1404	1468	1537	1604	1669	1773
	24" Open Arm Start Patient Unit, Upholstered Back										
	SOL2-SPU24OPU	Urethane	1203	1275	1345	1484	1624	1765	1908	2048	2328
	SOL2-SPU24OPW	Beech	1331	1402	1468	1611	1752	1892	2033	2173	2457
	30" Open Arm Start Patient Unit, Upholstered Back										
	SOL2-SPU30OPU	Urethane	1494	1598	1702	1909	2117	2323	2531	2740	3155
	SOL2-SPU30OPW	Beech	1620	1727	1827	2034	2242	2451	2658	2864	3280
	21" Open Arm Center Patient Unit, Mesh Back										
	SOL2-CPM21OPU	Urethane	1003	1036	1067	1137	1241	1268	1335	1402	1504
	SOL2-CPM21OPW	Beech	1065	1097	1134	1199	1266	1332	1398	1464	1567
	21" Open Arm Center Patient Unit, Upholstered Back										
	SOL2-CPU21OPU	Urethane	1054	1124	1194	1335	1478	1615	1756	1897	2177
	SOL2-CPU21OPW	Beech	1117	1190	1257	1398	1538	1677	1819	1960	2241
	24" Open Arm Urethane Cap Center Patient Unit, Mesh Back										
	SOL2-CPM24OPU	Urethane	1030	1062	1094	1162	1228	1294	1359	1425	1529
	SOL2-CPM24OPW	Beech	1092	1124	1158	1224	1290	1357	1422	1491	1592
	24" Open Arm Center Patient Unit, Upholstered Back										
	SOL2-CPU24OPU	Urethane	1082	1152	1222	1361	1503	1643	1782	1924	2206
	SOL2-CPU24OPW	Beech	1142	1215	1284	1425	1565	1706	1845	1988	2269
	30" Open Arm Center Patient Unit, Upholstered Back										
	SOL2-CPU30OPU	Urethane	1355	1459	1560	1769	1976	2182	2390	2601	3013
	SOL2-CPU30OPW	Beech	1417	1522	1623	1833	2037	2244	2453	2663	3076

ORDERING NOTES: A drawing showing the configuration of the multiple seating and tables is required with each purchase order. Additional features and options information see page 24, closed arm panel upcharges page 104.

PRODUCT CODE KEY

Line	Series	Chair Type	Back Type	Size	Arm Type
SOL	2	SP	U	21	OPW
Solis	Chair	Start Unit Patient Multiple Seating	Upholstered Back		Open Arm - Wood Arm
		CP	M	24	OPU
		Center Unit Patient Multiple Seating	Mesh Back 21" & 24" Only		Open Arm Urethane Arm
		EP		30	CLW
		End Unit Patient Multiple Seating			Closed Arm - Wood Arm
				44	CLU
					Closed Arm Urethane Arm
					COW
					Closed Start Arm/Open Center Arm Wood Arm
					COU
					Closed Start Arm/Open Center Arm with Urethane Arm

SOLIS | MULTIPLE SEATING - PATIENT END UNITS

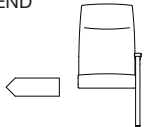
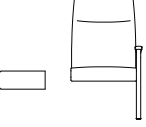
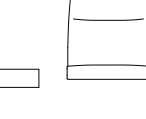
DESCRIPTION/MODEL	Arm Type	COM		COL		FABRIC GRADES			LEATHER		
		1	2	3	4	5	6	7	8	9	
 21" Open Arm End Patient Unit, Mesh Back SOL2-EPM21OPU SOL2-EPM21OPW 21" Open Arm End Patient Unit, Upholstered Back SOL2-EPU21OPU SOL2-EPU21OPW	Urethane	1003	1036	1067	1137	1202	1268	1335	1402	1504	
	Beech	1065	1097	1134	1199	1266	1332	1398	1464	1567	
	Urethane	1054	1124	1194	1335	1478	1615	1756	1897	2177	
	Beech	1117	1190	1257	1398	1538	1677	1819	1960	2241	
	 24" Open Arm End Patient Unit, Mesh Back SOL2-EPM24OPU SOL2-EPM24OPW 24" Open Arm End Patient Unit, Upholstered Back SOL2-EPU24OPU SOL2-EPU24OPW	Urethane	1030	1062	1094	1162	1228	1294	1359	1425	1529
		Beech	1092	1124	1158	1224	1290	1357	1422	1491	1592
Urethane		1082	1152	1222	1361	1503	1643	1782	1924	2206	
Beech		1142	1215	1284	1425	1565	1706	1846	1988	2269	
 30" Open Arm End Patient Unit, Upholstered Back SOL2-EPU30OPU SOL2-EPU30OPW		Urethane	1355	1459	1560	1769	1976	2182	2390	2601	3013
		Beech	1417	1522	1623	1833	2037	2244	2453	2663	3076

ORDERING NOTES: A drawing showing the configuration of the multiple seating and tables is required with each purchase order. Complete Mesh backs (21" & 24") can be ordered and field replaced.

Solis Pre-configured Patient Option Upcharges	\$ List	\$ List	
CAL 133 & Moisture Barrier (per yard)	64	Beech Wood Side Rails Upgrade (per chair)	127
Kinetic Back option (not available for 30" & 44")	120	Solid Surface Arm (per pair) - Gr A White	488
Patient chair - Removable Seat Cover (per seat)	90	Solid Surface Arm (per pair) - Gr A Color	505
21" & 24" - Removeable Back Covers (per back)	61	Solid Surface Arm (per pair) - Gr B	542
30" & 44" - Removeable Back Covers	94	Solid Surface Arm (per pair) - Gr C	586
Combination Upholstery - dual fabrics (per chair)	33	Solid Surface Arm (per arm) - Gr A White	244
Combination Upholstery - Three fabrics (per chair)	64	Solid Surface Arm (per arm) - Gr A Color	253
Beech Wood Side Rails Upgrade (per chair)	127	Solid Surface Arm (per arm) - Gr B	271
Maple wood Side Rails Upgrade (per chair)	159	Solid Surface Arm (per arm) - Gr C	293
21" & 24" Cleanable Under-seat Splashguard	40	Soft Casters (21" & 24" chairs) -4 set	64
30" Cleanable Under-seat Splashguard	48	Soft Casters (21" & 24" chairs) -2 set	33
44" Cleanable Under-seat Splashguard	64	Non-locking Casters (21" & 24" chairs) -4 set	120
Non-Marring Glide	37	Non-locking Casters (21" & 24" chairs) -2 set	80
Maple Arm upgrade per arm (add to beech price)	80		

Note: Locking casters are available, clearly mark on the purchase order.

Additional features and options information see page 24.



Closed Arm Panels (per chair) - please add the following up charges for closed arm panels.

Fabric Grades	(COM) 1	2	(COL) 3	4	5	6	7	8	9
1 ARM	208	224	238	267	294	321	350	379	435

PRODUCT CODE KEY

Line	Series	Chair Type	Back Type	Size	Arm Type
SOL	2	SP	U	21	OPW
Solis	Chair	Start Unit Patient Multiple Seating	Upholstered Back		Open Arm - Wood Arm
		CP	M	24	OPU
		Center Unit Patient Multiple Seating	Mesh Back 21" & 24" Only		Open Arm Urethane Arm
		EP		30	CLW
		End Unit Patient Multiple Seating			Closed Arm - Wood Arm
					CLU
					Closed Arm Urethane Arm

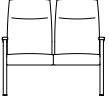
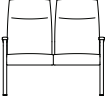
SOLIS | PRE-CONFIGURED FREESPAN MULTIPLE SEATING PATIENT UNIT WITHOUT CENTER ARM

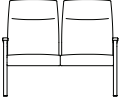
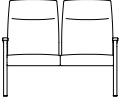
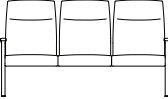
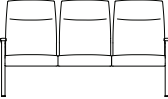
DESCRIPTION/MODEL	Arm Type	COM		COL		FABRIC GRADES			LEATHER		
		1	2	3	4	5	6	7	8	9	
	21" Pre-Configured Freespan Patient Unit - Open Arm 2 Seat, Mesh Back										
	SOL2-PCFPM21X2AOPU	Urethane	1997	2045	2091	2188	2281	2377	2471	2566	2710
	SOL2-PCFPM21X2AOPW	Beech	2124	2170	2218	2313	2408	2503	2596	2694	2835
	21" Pre-Configured Freespan Patient Unit - Open Arm 2 Seat, Upholstered Back										
	SOL2-PCFPU21X2AOPU	Urethane	2100	2239	2382	2661	2943	3222	3505	3786	4348
	SOL2-PCFPU21X2AOPW	Beech	2227	2364	2507	2788	3069	3349	3631	3914	4473
	21" Pre-Configured Freespan Patient Unit - Open Arm 3 Seat, Mesh Back										
	SOL2-PCFPM21X3AOPU	Urethane	2808	2881	2952	3095	3237	3379	3520	3663	3876
	SOL2-PCFPM21X3AOPW	Beech	2935	3008	3078	3220	3363	3505	3646	3789	4004
	21" Pre-Configured Freespan Patient Unit - Open Arm 3 Seat, Upholstered Back										
	SOL2-PCFPU21X3AOPU	Urethane	2957	3166	3379	3798	4221	4641	5063	5485	6328
	SOL2-PCFPU21X3AOPW	Beech	3082	3294	3505	3929	4348	4767	5190	5612	6455
	24" Pre-Configured Freespan Patient Unit - Open Arm 2 Seat, Mesh Back										
	SOL2-PCFPM24X2AOPU	Urethane	2034	2084	2131	2223	2319	2415	2508	2606	2745
	SOL2-PCFPM24X2AOPW	Beech	2163	2210	2255	2352	2447	2541	2636	2732	2873
	24" Pre-Configured Freespan Patient Unit - Open Arm Urethane Cap 2 Seat, Upholstered Back										
	SOL2-PCFPU24X2AOPU	Urethane	2140	2281	2421	2703	2986	3266	3545	3827	4392
	SOL2-PCFPU24X2AOPW	Beech	2268	2408	2549	2829	3112	3390	3671	3954	4515
	24" Pre-Configured Freespan Patient Unit - Open Arm 3 Seat, Mesh Back										
	SOL2-PCFPM24X3AOPU	Urethane	2870	2942	3011	3155	3295	3437	3580	3721	3935
	SOL2-PCFPM24X3AOPW	Beech	2995	3068	3137	3280	3424	3564	3708	3864	4063
	24" Pre-Configured Freespan Patient Unit - Open Arm 3 Seat, Upholstered Back										
	SOL2-PCFPU24X3AOPU	Urethane	3021	3231	3439	3862	4286	4707	5125	5548	6390
	SOL2-PCFPU24X3AOPW	Beech	3145	3356	3565	3988	4411	4833	5255	5675	6518

ORDERING NOTES: A drawing showing the configuration of the multiple seating and tables is required with each purchase order. Complete Mesh backs (21" & 24") can be ordered and field replaced.

Solis Pre-configured Patient Option Upcharges	\$ List	\$ List	
CAL 133 & Moisture Barrier (per yard)	64	Maple Arm upgrade per arm (add to beech price)	80
Kinetic Back option (not available for 30" & 44")	120	Beech Wood Side Rails Upgrade (per chair)	127
Patient chair - Removable Seat Cover (per seat)	90	Solid Surface Arm (per pair) - Gr A White	488
21" & 24" - Removeable Back Covers (per back)	61	Solid Surface Arm (per pair) - Gr A Color	505
Combination Upholstery - dual fabrics (per chair)	33	Solid Surface Arm (per pair) - Gr B	542
Combination Upholstery - Three fabrics (per chair)	64	Solid Surface Arm (per pair) - Gr C	586
Beech Wood Side Rails Upgrade (per chair)	127	Non-Marring Glide	37
Maple wood Side Rails Upgrade (per chair)	159	Soft Casters (21" & 24" chairs) -4 set	64
21" & 24" Cleanable Under-seat Splashguard	40	Soft Casters (21" & 24" chairs) -2 set	33
		Non-locking Casters (21" & 24" chairs) -4 set	120
		Non-locking Casters (21" & 24" chairs) -2 set	80

Additional features and options information see page 24, closed arm panel upcharges page 104.

Note: Locking casters are available, clearly mark on the purchase order.

PRODUCT CODE KEY

Line	Series	Chair Type	Back Type	Size	Unit Style	Arm Type
SOL	2	PCFP	U	21X2	A	OPW
Solis	Chair	Pre-configured Freespan Multiple Patient Unit	Upholstered Back		Unit with no Center Arm	Open Arm - Wood Arm
			M	21X3	B	OPU
			Mesh Back		Unit with Center Arm	Open Arm Urethane Arm
				24X2		CLW
						Closed Arm -Wood Arm
				24X3		CLU
						Closed Arm Urethane Arm

SOLIS | PRE-CONFIGURED FREESPAN MULTIPLE SEATING PATIENT UNIT WITH CENTER ARM

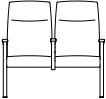
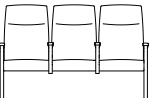
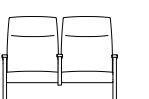
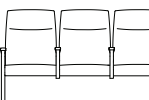
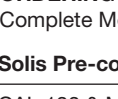
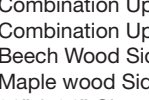
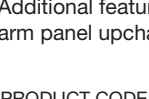
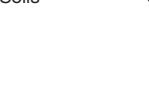
DESCRIPTION/MODEL	Arm Type	COM		COL		FABRIC GRADES			LEATHER		
		1	2	3	4	5	6	7	8	9	
	21" Pre-Configured Freespan Center Arm Patient Unit - Open Arm 2 Seat, Mesh Back										
	SOL2-PCFPM21X2BOPU	Urethane	2139	2188	2236	2328	2422	2518	2612	2710	2851
	SOL2-PCFPM21X2BOPW	Beech	2328	2377	2422	2518	2612	2710	2804	2898	3039
	21" Pre-Configured Freespan Center Arm Patient Unit - Open Arm 2 Seat, Upholstered Back										
	SOL2-PCFPU21X2BOPU	Urethane	2250	2388	2531	2810	3092	3374	3654	3935	4499
	SOL2-PCFPU21X2BOPW	Beech	2440	2579	2719	3001	3283	3563	3844	4128	4686
	21" Pre-Configured Freespan Center Arm Patient Unit - Open Arm 3 Seat, Mesh Back										
	SOL2-PCFPM21X3BOPU	Urethane	3036	3105	3179	3320	3461	3605	3745	3890	4103
	SOL2-PCFPM21X3BOPW	Beech	3289	3358	3430	3574	3714	3856	3999	4142	4354
	21" Pre-Configured Freespan Center Arm Patient Unit - Open Arm 3 Seat, Upholstered Back										
	SOL2-PCFPU21X3BOPU	Urethane	3192	3404	3613	4037	4457	4878	5300	5721	6565
	SOL2-PCFPU21X3BOPW	Beech	3445	3656	3867	4289	4709	5132	5553	5973	6817
	24" Pre-Configured Freespan Center Arm Patient Unit - Open Arm 2 Seat, Mesh Back										
	SOL2-PCFPM24X2BOPU	Urethane	2177	2227	2273	2369	2463	2559	2654	2746	2890
	SOL2-PCFPM24X2BOPW	Beech	2369	2417	2463	2559	2654	2746	2844	2936	3080
	24" Pre-Configured Freespan Center Arm Patient Unit - Open Arm 2 Seat, Upholstered Back										
	SOL2-PCFPU24X2BOPU	Urethane	2293	2432	2571	2853	3135	3414	3698	3979	4539
	SOL2-PCFPU24X2BOPW	Beech	2481	2621	2763	3042	3324	3605	3888	4169	4730
	24" Pre-Configured Freespan Center Arm Patient Unit - Open Arm 3 Seat, Mesh Back										
	SOL2-PCFPM24X3BOPU	Urethane	3096	3165	3238	3381	3521	3665	3809	3950	4162
	SOL2-PCFPM24X3BOPW	Beech	3348	3420	3490	3634	3774	3918	4060	4203	4416
	24" Pre-Configured Freespan Center Arm Patient Unit - Open Arm 3 Seat, Upholstered Back										
	SOL2-PCFPU24X3BOPU	Urethane	3257	3468	3678	4099	4521	4942	5363	5784	6627
	SOL2-PCFPU24X3BOPW	Beech	3510	3718	3931	4352	4774	5194	5614	6035	6879

ORDERING NOTES: A drawing showing the configuration of the multiple seating and tables is required with each purchase order.
Complete Mesh backs (21" & 24") can be ordered and field replaced.

Solis Pre-configured Patient Option Upcharges	\$ List		\$ List
CAL 133 & Moisture Barrier (per yard)	64	Beech Wood Side Rails Upgrade (per chair)	127
Kinetic Back option (not available for 30" & 44")	120	Solid Surface Arm (per pair) - Gr A White	488
Patient chair - Removable Seat Cover (per seat)	90	Solid Surface Arm (per pair) - Gr A Color	505
21" & 24" - Removeable Back Covers (per back)	61	Solid Surface Arm (per pair) - Gr B	542
Combination Upholstery - dual fabrics (per chair)	33	Solid Surface Arm (per pair) - Gr C	586
Combination Upholstery - Three fabrics (per chair)	64	Solid Surface Arm (per arm) - Gr A White	244
Beech Wood Side Rails Upgrade (per chair)	127	Solid Surface Arm (per arm) - Gr A Color	253
Maple wood Side Rails Upgrade (per chair)	159	Solid Surface Arm (per arm) - Gr B	271
21" & 24" Cleanable Under-seat Splashguard	40	Solid Surface Arm (per arm) - Gr C	293
Non-Marring Glide	37	Soft Casters (21" & 24" chairs) -4 set	64
Maple Arm upgrade per arm (add to beech price)	80	Soft Casters (21" & 24" chairs) -2 set	33
		Non-locking Casters (21" & 24" chairs) -4 set	120
		Non-locking Casters (21" & 24" chairs) -2 set	80





Additional features and options information see page 24, closed arm panel upcharges page 104.

Note: Locking casters are available, clearly mark on the purchase order.



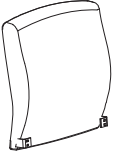
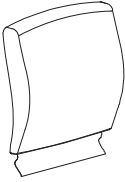

PRODUCT CODE KEY

Line	Series	Chair Type	Back Type	Size	Unit Style	Arm Type
SOL	2	PCFP	U	21X2	A	OPW
Solis	Chair	Pre-configured Freespan Multiple Patient Unit	Upholstered Back		Unit with no Center Arm	Open Arm - Wood Arm
			M	21X3	B	OPU
			Mesh Back		Unit with Center Arm	Open Arm Urethane Arm
				24X2		CLW
						Closed Arm -Wood Arm
				24X3		CLU
						Closed Arm Urethane Arm

SOLIS | REPLACEMENT COMPONENTS - MULTIPLE SEATING

Description	Model	COM		COL			FABRIC GRADES			LEATHER			Yardage	Weight	Cube
		1	2	3	4	5	6	7	8	9					
	21" Replacement Guest Upholstered Backs	SOL2-RBGU21	567	610	651	710	778	835	904	987	1071	1.5	14	2.7	
	21" Replacement Guest Mesh Backs	SOL2-RBGM21	477											10	2.7
	24" Replacement Guest Upholstered Backs	SOL2-RBGU24	581	621	664	722	790	849	916	1002	1086	1.5	15	2.8	
	24" Replacement Guest Mesh Backs	SOL2-RBGM24	497											11	2.8
	30" Replacement Guest Upholstered Backs	SOL2-RBGU30	632	679	727	795	871	938	1016	1111	1207	1.6	19	3.4	
	44" Replacement Guest Upholstered Backs	SOL2-RBGU44	794	843	889	957	1034	1102	1179	1273	1371	2.25	28	4.8	
	21" Replacement Guest Upholstered Back Cover	SOL2-RBCGU21	198	240	287	340	408	467	535	618	702	1.5	2	.8	
	24" Replacement Guest Upholstered Back Cover	SOL2-RBCGU24	198	240	282	340	408	467	535	618	702	1.5	2.3	.8	
	30" Replacement Guest Upholstered Back Cover	SOL2-RBCGU30	214	260	309	378	453	520	597	693	789	1.6	2.6	.8	
	44" Replacement Guest Upholstered Back Cover	SOL2-RBCGU44	218	267	315	382	458	527	602	697	795	2.25	3.5	.8	
	21" Replacement Patient Upholstered Backs	SOL2-RBPU21	673	732	793	877	973	1058	1152	1272	1393	2.0	21	3.8	
	21" Replacement Patient Mesh Backs	SOL2-RBPM21	451											15	3.8
	24" Replacement Patient Upholstered Backs	SOL2-RBPU24	711	771	832	915	1012	1095	1192	1312	1433	2.0	21	3.8	
	24" Replacement Patient Mesh Backs	SOL2-RBPM24	517											17	3.8
	30" Replacement Patient Upholstered Backs	SOL2-RBPU30	857	937	1015	1122	1247	1358	1483	1640	1794	2.2	24	4.8	
	21" Replacement Patient Upholstered Back Cover	SOL2-RBCPU21	253	312	372	456	554	636	732	852	973	2.0	2.5	.8	
	24" Replacement Patient Upholstered Back Cover	SOL2-RBCPU24	254	313	374	457	555	637	733	853	974	2.0	2.7	.8	
	30" Replacement Patient Upholstered Back Cover	SOL2-RBCPU30	306	386	464	571	697	807	932	1088	1244	2.2	3	.8	
	Replacement Mesh Back Top Bar														
	SOL2-RMBTB21	33											2.5	.5	
	SOL2-RMBTB24	34											3.0	.7	

SOLIS | REPLACEMENT COMPONENTS - MULTIPLE SEATING

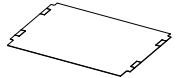

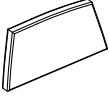

Description	Model	COM		COL	FABRIC GRADES			LEATHER			Yardage	Weight	Cube	
		1	2	3	4	5	6	7	8	9				
	21" Replacement Seat SOL2-RS21	389	418	443	481	523	561	605	659	715	.9	9	2.7	
	24" Replacement Seat SOL2-RS24	409	436	464	501	543	583	626	679	733	.9	10	2.7	
	30" Replacement Seat SOL2-RS30	487	513	540	577	620	659	702	756	809	.9	12	3.4	
	44" Replacement Seat SOL2-RS44	628	662	694	740	793	840	892	958	1022	1.1	14	4.8	
	21" Replacement Seat Cover SOL2-RSC21	130	159	185	223	267	304	374	403	455	1.0	1.6	.8	
	24" Replacement Seat Cover SOL2-RSC24	134	160	189	227	270	306	350	405	458	1.0	1.7	.8	
	30" Replacement Seat Cover SOL2-RSC30	136	161	189	227	270	306	350	405	458	1.0	2	.8	
	44" Replacement Seat Cover SOL2-RSC44	152	186	218	265	318	363	416	483	547	1.1	2.5	.8	
FREESPAN 	21" Replacement Freespan Seat - A Center SOL2-RS21A-C	396	423	451	488	532	567	612	665	720	0.9	9	2.7	
	21" Replacement Freespan Seat - A Left Facing SOL2-RS21A-L	392	420	448	486	530	564	610	663	718	0.9	9	2.7	
	21" Replacement Freespan Seat - A Right Facing SOL2-RS21A-R	392	420	448	486	530	564	610	663	718	0.9	9	2.7	
	21" Replacement Freespan Seat - B SOL2-RS21B	392	420	448	486	530	564	610	663	718	0.9	9	2.7	
	24" Replacement Freespan Seat - A Center SOL2-RS24A-C	415	443	469	509	552	589	633	687	740	0.9	9	2.7	
	24" Replacement Freespan Seat - A Left Facing SOL2-RS24A-L	412	441	467	507	547	586	630	685	738	0.9	9	2.7	
	24" Replacement Freespan Seat - A Right Facing SOL2-RS24A-R	412	441	467	507	547	586	630	685	738	0.9	9	2.7	
	24" Replacement Freespan Seat - B SOL2-RS24B	412	441	467	507	547	586	630	685	738	0.9	9	2.7	
		21" Replacement Freespan Seat Cover - A Center SOL2-RSC21A-C	130	159	185	223	267	304	347	403	455	0.9	9	2.7
		21" Replacement Freespan Seat Cover- A Left Facing SOL2-RSC21A-L	130	159	185	223	267	304	347	403	455	0.9	9	2.7
21" Replacement Freespan Seat Cover- A Right Facing SOL2-RSC21A-R		130	159	185	223	267	304	347	403	455	0.9	9	2.7	
21" Replacement Freespan Seat Cover- B SOL2-RSC21B		130	159	185	223	267	304	347	403	455	0.9	9	2.7	
24" Replacement Freespan Seat Cover- A Center SOL2-RSC24A-C		134	160	186	224	268	304	348	404	456	0.9	9	2.7	
24" Replacement Freespan Seat Cover- A Left Facing SOL2-RSC24A-L		134	160	186	224	268	304	348	404	456	0.9	9	2.7	
24" Replacement Freespan Seat Cover- A Right Facing SOL2-RSC24A-R		134	160	186	224	268	304	348	404	456	0.9	9	2.7	
24" Replacement Freespan Seat Cover- B SOL2-RSC24B		134	160	186	224	268	304	348	404	456	0.9	9	2.7	
		Replacement Splash Guard SOL2-RSG21	90										1	.3
	SOL2-RSG24	110										2	.4	
	SOL2-RSG30	154										3	.5	
	SOL2-RSG44	166										4	.6	

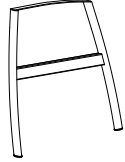
SOLIS | REPLACEMENT COMPONENTS - MULTIPLE SEATING

Description	Model	COM		COL			FABRIC GRADES			LEATHER			Yardage	Weight	Cube
		1	2	3	4	5	6	7	8	9					
	Replacement Closed Arm SOL2-RCA	207	218	231	247	267	283	303	327	350	0.4	6	.9		

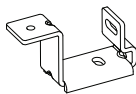
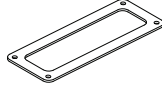
Description	Model	Price	Weight	Cubes					
	Replacement Side Frame - Interim SOL2-RSFIB	129	7	1.2					
	Replacement Side Frame - Interim - No Anti-Microbial SOL2-RSFIBX	118	7	1.2					
	Replacement Side Frame - Start SOL2-RSFS	134	9	1.5					
	Replacement Side Frame - Start - No Anti-Microbial SOL2-RSFSX	111	9	1.5					
	Replacement Side Frame - Center SOL2-RSFC	134	9	1.5					
	Replacement Side Frame - Center - No Anti-Microbial SOL2-RSFCX	111	9	1.5					
	Replacement Side Frame - End SOL2-RSFE	134	9	1.5					
	Replacement Side Frame - End - No Anti-Microbial SOL2-RSFEX	111	9	1.5					
	Replacement Side Frame - Start - 1 Glide, 1 Caster SOL2-RSFSC	172	9.5	1.5					
	Replacement Side Frame - Start - 1 Glide, 1 Caster- No Anti-Microbial SOL2-RSFSCX	138	9.5	1.5					
	Replacement Side Frame - End - 1 Glide, 1 Caster SOL2-RSFEC	172	9.5	1.5					
	Replacement Side Frame - End - 1 Glide, 1 Caster- No Anti-Microbial SOL2-RSFECX	138	9.5	1.5					
	Replacement Side Frame - Start - 2 Caster SOL2-RSFSC2	149	10	1.5					
	Replacement Side Frame - Start - 2 Caster- No Anti-Microbial SOL2-RSFSC2X	145	10	1.5					
	Replacement Side Frame - End - 2 Caster SOL2-RSFEC2	149	10	1.5					
	Replacement Side Frame - End - 2 Caster- No Anti-Microbial SOL2-RSFEC2X	145	10	1.5					
	Replacement Wood Side Rail Cover - Beech SOL2-RSRCB	180	1.0	.3					
	Replacement Wood Side Rail Cover - Maple SOL2-RSRCM	231							
	Replacement Arm Cap - Urethane SOL2-RACU	70	1.5	.2					
	Replacement Arm Cap - Beech SOL2-RACWB	213	1.0	.2					
	Replacement Arm Cap - Maple SOL2-RACWM	229	1.0	.2					
		Grade A- White	Grade A- Color	Grade- B	Grade- C				
	Replacement Arm Cap - Solid Surface SOL2-RACSS	256	261	282	304	2	.2		

SOLIS | REPLACEMENT COMPONENTS

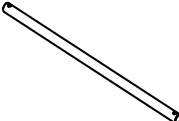
Description	Model	Price	Weight	Cubes
	Replacement Link/Ganging Brackets - Table to Chair SOL2-RLKB1	68	2.0	.2
	Replacement Link/Ganging Brackets - Chair to Chair SOL2-RLKB2	51	2.0	.2
	Replacement Link/Ganging Brackets - Chair to Chair (set of 10) SOL2-RLKB3	159	1.0	.2
  	Replacement Glide - Front SOL2-RGF	22	.5	.1
	Replacement Glide - Back SOL2-RGB	22	.5	.1
	Replacement Glide - Easy Access - Front SOL2-RGFEA	29	.5	.1
	Replacement Glide - Set of 4 SOL2-RGS4	24	2	.1
	Replacement Caster Glide - Front SOL2-RGFC	23	2	.1
	Replacement Caster Glide - Back SOL2-RGBC	23	2	.1
	Replacement Caster - Hard Wheel SOL2 - RCH	30	1.5	.3
	Replacement Caster - Soft Wheel SOL2 - RCS	33	1.5	.3
	Replacement Stretcher SOL2-RSTRETCHER21	182	1.0	.3
	SOL2-RSTRETCHER24	186	1.5	.4
	SOL2-RSTRETCHER21X	178	1.0	.5
	SOL2-RSTRETCHER24X	183	1.5	.6

FAERON WOOD | MULTIPLE SEATING INSTRUCTIONS

To aid you in the process of specifying and ordering Faeron Multiple Seating, we have compiled the following summary. It explains the three different types of Faeron Multiple Seating – (a) Pre-Configured, (b) Start, Center & End Units and (c) the Freespan Multiple Units – including the features and considerations of each type, to assist in selecting the one that best suits each application. It is a requirement for all Faeron Multiple Seating orders, a drawing or plan view layout must accompany the order, so that we can verify that the specification is correct.

When building your multiple seating layout, please note that your order should start from left to right as you are facing the configuration.

Pre-Configured Multiple Units

Pre-Configured Multiple Units are designed to be used when you have seating configurations that are 2-3 chair units in size.

Considerations if choosing to use Pre-Configured Units:

- Linking tables can be joined to either end of a Pre-Configured Multiple Unit, but not in-between
- There are no limitations to the number of Pre-Configured Multiple units that can be ganged together with the Faeron Linking Tables
- Pre-Configured Multiple Units are not available in 30" or 44" plus widths
- Pre-Configured Multiple Units are not designed to work with other multiple seating (Start, Center, End Units or Freespan Units) unless a Faeron Linking Table or linking brackets are used in-between the different types of multiple seating.
- Pre-Configured Multiple Units are built from Start, Center and End Units and therefore, can be reconfigured to singular or two-seat units. However, you may have to purchase additional components (arms, etc...) to be able to do this. See line drawings below for possible configurations that can be made from taking apart the Pre-Configured Multiple Units.

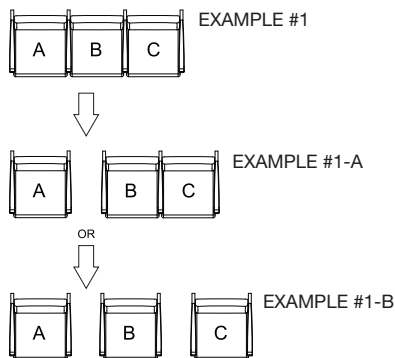

*Please note:

Example #1-A requires an additional end unit arm for chair A, and a start unit arm for chair B.

Example #1-B requires an additional end unit arm for chair A, a start and end unit arm for chair B, and a start unit arm for chair C.

Start, Center and End Multiple Seating Units

Start, Center and End Multiple Units are designed to be used when you have seating configurations that are greater than three chair units in size, and/or include 30" or 44" units. Also, before you start to build your multiple seating layout, please note that your order should start from left to right as you are facing the chair, therefore begin the configuration with a Start Unit, then move to a Center Unit and finish with an End Unit.

Considerations if choosing to use Start, Center and End Multiple Units:

- Start, Center and End units are available in all widths (21", 24", 30" & 44")
- There are no limitations to the amount of center units that can be ganged to a start or an end unit
- Faeron Linking Tables can be joined to any Faeron Start or End unit only (this is because the units are engineered with the finished arms)

FAERON WOOD | MULTIPLE SEATING INSTRUCTIONS

See below for sample configurations of when you would use Start, Center and End Multiple Units.

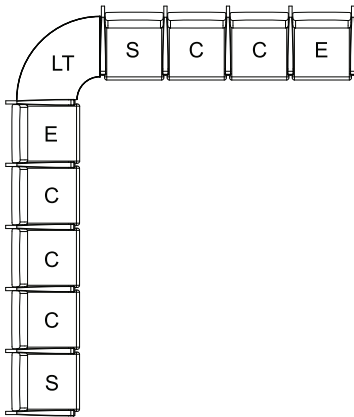

Freespan Multiple Units

Freespan Multiple Units are designed to be used when you have seating configurations that are 2-3 chair units in size and a reduced number of legs are desirable. (see picture below).



Considerations if choosing to use Freespan Multiple Units:

- Freespan Multiple Units come with a choice of a pre-configured unit with or without a center arm
- The unit with the center arm increases the overall width of the unit by 1" per arm
- Linking tables can be joined to either side of a Freespan Multiple Unit, but not in-between
- There are no limitations to the number of Freespan Multiple units that can be ganged together with the Faeron Linking Tables or linking brackets.
- Freespan Multiple Units are not available in 30" or 44" plus widths
- Freespan Multiple Units are not designed to work with other multiple seating (Start, Center, End Units or Freespan Units) unless a Faeron Linking Table or linking brackets are used in-between the different types of multiple seating.

Below illustrates possible configurations when you could use all three types of Faeron Multiple Seating together.

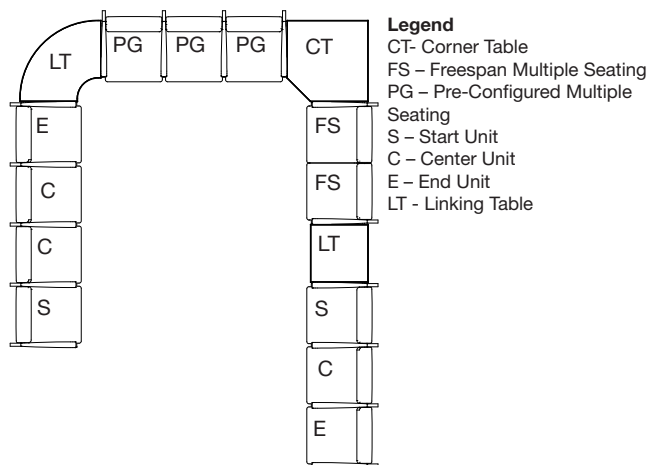

For more information on how to specify Faeron Multiple Seating, please contact Customer Service directly at 1-888-578-5784.

FAERON WOOD | MULTIPLE SEATING - PRECONFIGURED UNITS

DIMENSIONS & COM REQUIREMENTS

	Overall Width	Overall Depth	Overall Height	Seat Height	Height of Arms from Floor	Width Between Arms	Seat Depth	Shipping Weight	Cube	COM Seat & Back Yardage	COM Fabric Seat Yardage	COM Fabric Back Yardage	COM Fabric Closed Arm Panel Yardage
PCG21X2	48.3	26.3	34.5	19.0	25.0	21	19.5	76	28	3.0	1.5	2.1	1.2
PCP21X2	48.3	26.3	45.0	19.0	25.0	21	19.5	86	38	3.8	1.5	3.0	1.2
PCG21X3	71.5	26.3	34.5	19.0	25.0	21	19.5	109	41	4.6	2.4	3.5	1.6
PCP21X3	71.5	26.3	45.0	19.0	25.0	21	19.5	124	56	5.8	2.4	5.0	1.6
PCG24X2	54.3	26.3	34.5	19.0	25.0	24	19.5	83	31	3.0	1.5	2.1	1.2
PCP24X2	54.3	26.3	45.0	19.0	25.0	24	19.5	93	43	3.8	1.5	3.0	1.2
PCG24X3	80.5	26.3	34.5	19.0	25.0	24	19.5	121	46	4.6	2.4	3.5	1.6
PCP24X3	80.5	26.3	45.0	19.0	25.0	24	19.5	136	63	5.8	2.4	5.0	1.6

Note: Some vinyls, leathers & upholsteries are not suitable for application on Faeron seating. Please refer to page 628 for C.O.M approval process.

A drawing showing the configuration of the multiple seating and tables is required with each purchase order.

WEIGHT CAPACITIES



Faeron weight capacities are as follows:
 Guest & Patient Chairs (21" & 24") - 500 lbs

Faeron Option Upcharges	\$ List	\$ List
CAL 133 & Moisture Barrier (per yard)	64	
Combination Upholstery - dual fabrics (per chair)	33	Solid Surface Arm Cap (pair) - Gr A White 364
Combination Upholstery - Three fabrics (per chair)	64	Solid Surface Arm Cap (pair) - Gr A Color 376
Ganging Bracket	58	Solid Surface Arm Cap (pair) - Gr B 396
Kinetic Back (not available for Plus)	120	Solid Surface Arm Cap (pair) - Gr C 410
21" & 24" Under-seat Splashguard	58	
Removeable Seat Cover (per seat)	90	Solid Surface Arm (pair) - Gr A White 573
Removable Back Cover (per back)	58	Solid Surface Arm (pair) - Gr A Color 598
Urethane Arm Cap (each)	69	Solid Surface Arm (pair) - Gr C 678
Solid Surface Arm Cap (each) - Gr A White	182	Solid Surface Arm (pair) - Gr B 645
Solid Surface Arm Cap (each) - Gr A Color	187	See page 631 for color selection.
Solid Surface Arm Cap (each) - Gr B	198	
Solid Surface Arm Cap (each) - Gr C	205	Additional features and options information see page 31.
Solid Surface Arm (each) - Gr A White	287	
Solid Surface Arm (each) - Gr A Color	299	
Solid Surface Arm (each) - Gr B	321	
Solid Surface Arm (each) - Gr C	339	

Patient backs are available on multiple units, please change the model number FAE2-PCG to FAE2-PCP, and add the following upcharges per back:

	Grade 1	Grade 2	Grade 3	Grade 4	Grade 5	Grade 6	Grade 7	Grade 8	Grade 9
21" Chairs	63	74	90	114	138	164	189	215	265
24" Chairs	68	81	94	119	144	170	195	220	271

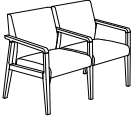
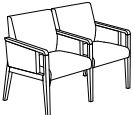
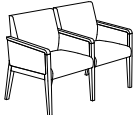
FAERON WOOD | MULTIPLE SEATING - PRECONFIGURED UNITS

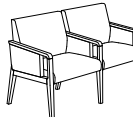
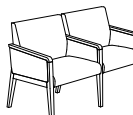
DESCRIPTION/MODEL	Species	COM		COL		FABRIC GRADES			LEATHER	
		1	2	3	4	5	6	7	8	9
 2 Seat - 21" Open Arm Pre-configured Unit, Guest Backs FAE2-PCG21X2ONC	Beech	2201	2303	2406	2609	2810	3013	3216	3418	3823
	Palette									
 2 Seat - 21" Semi Closed Arm Pre-configured Unit, Guest Backs FAE2-PCG21X2SNC	Beech	2912	3053	3190	3470	3748	4028	4308	4586	5142
	Palette									
 2 Seat - 21" Closed Arm Pre-configured Unit, Guest Backs FAE2-PCG21X2CNC	Beech	2940	3080	3219	3497	3776	4057	4335	4613	5170
	Palette									
 2 Seat - 24" Open Arm Pre-configured Unit, Guest Backs FAE2-PCG24X2ONC	Beech	2401	2502	2605	2805	3009	3210	3412	3617	4022
	Palette									
 2 Seat - 24" Semi Closed Arm Pre-configured Unit, Guest Backs FAE2-PCG24X2SNC	Beech	3111	3248	3388	3666	3948	4224	4504	4784	5340
	Palette									
 2 Seat - 24" Closed Arm Pre-configured Unit, Guest Backs FAE2-PCG24X2CNC	Beech	3137	3277	3415	3693	3975	4252	4531	4812	5367
	Palette									

ORDERING NOTES: Faeron chairs can be specified with Urethane Arm Caps (UC), Solid Surface Arm Caps (SC) or Solid Surface Arm (SA), replace "NC" in the model number with the **Arm Style** selection below and add the upcharge listed on page 116. Additional features and options information see page 31, Patient back option upcharge page 116.

PRODUCT CODE KEY

Line	Series	Chair Type	Back Type	Size	Arm Type	Arm Style
FAE	2	PC	G	21X2	O	NC
Faeron	Chair	Pre-configured Multiple Unit	Guest		Open Arm	No Cap
			P	24X2	S	UC
			Patient		Semi Closed Arm	Urethane Cap
				21X3	C	SC
					Closed Arm	Solid Surface Cap
				24X3		SA
						Solid Surface Arm

FAERON WOOD | MULTIPLE SEATING - PRECONFIGURED UNITS

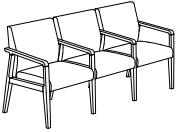
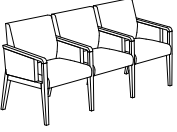
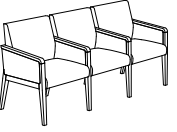
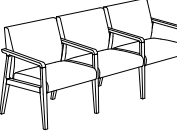
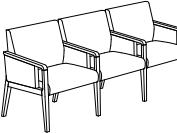
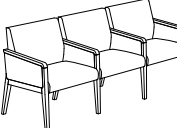
DESCRIPTION/MODEL	Species	COM		COL			FABRIC GRADES			LEATHER	
		1	2	3	4	5	6	7	8	9	
 3 Seat - 21" Open Arm Pre-configured Unit, Guest Backs FAE2-PCG21X3ONC	Beech	3131	3283	3433	3739	4042	4347	4652	4956	5562	
	Palette										
 3 Seat - 21" Semi Closed Arm Pre-configured Unit, Guest Backs FAE2-PCG21X3SNC	Beech	4097	4297	4503	4906	5315	5719	6124	6529	7342	
	Palette										
 3 Seat - 21" Closed Arm Pre-configured Unit, Guest Backs FAE2-PCG21X3CNC	Beech	4139	4340	4544	4948	5355	5761	6165	6571	7383	
	Palette										
 3 Seat - 24" Open Arm Pre-configured Unit, Guest Backs FAE2-PCG24X3ONC	Beech	3360	3459	3610	3917	4219	4525	4830	5134	5741	
	Palette										
 3 Seat - 24" Semi Closed Arm Pre-configured Unit, Guest Backs FAE2-PCG24X3SNC	Beech	4328	4478	4680	5085	5493	5896	6303	6708	7520	
	Palette										
 3 Seat - 24" Closed Arm Pre-configured Unit, Guest Backs FAE2-PCG24X3CNC	Beech	4370	4518	4721	5127	5532	5939	6344	6749	7561	
	Palette										

ORDERING NOTES: Faeron chairs can be specified with Urethane Arm Caps (UC), Solid Surface Arm Caps (SC) or Solid Surface Arm (SA), replace "NC" in the model number with the **Arm Style** selection below and add the upcharge listed on page 116. Additional features and options information see page 31, Patient back option upcharge page 116.

PRODUCT CODE KEY

Line	Series	Chair Type	Back Type	Size	Arm Type	Arm Style
FAE	2	PC	G	21X2	O	NC
Faeron	Chair	Pre-configured Multiple Unit	Guest		Open Arm	No Cap
			P	24X2	S	UC
			Patient		Semi Closed Arm	Urethane Cap
				21X3	C	SC
					Closed Arm	Solid Surface Cap
				24X3		SA
						Solid Surface Arm

FAERON WOOD | MULTIPLE SEATING - START, CENTER & END UNITS

DIMENSIONS & COM REQUIREMENTS

FAERON MULTIPLE START UNITS

	Overall Width	Overall Depth	Overall Height	Seat Height	Height of Arms from Floor	Width Between Arms	Seat Depth	Shipping Weight	Cube	COM Seat & Back Yardage	COM Fabric Seat Yardage	COM Fabric Back Yardage	COM Fabric Closed Arm Panel (Pair) Yardage
SG21	25	26.3	34.5	19	25	21	19.5	44	14	1.6	0.9	1.4	0.8
SP21	25	26.3	45	19	25	21	19.5	49	17	2.0	0.9	2.0	0.8
SG24	28	26.3	34.5	19	25	24	19.5	48	19	1.6	0.9	1.4	0.8
SP24	28	26.3	45	19	25	24	19.5	53	22	2.0	0.9	2.0	0.8
SG30	34	26.3	34.5	19	25	30	19.5	54	20	2.3	0.9	1.4	0.8
SP30	34	26.3	45	19	25	30	19.5	64	28	3.0	0.9	2.0	0.8
SG44	48	26.3	34.5	19	25	44	19.5	71	28	2.9	0.9	1.6	0.8

FAERON MULTIPLE CENTER UNITS

	Overall Width	Overall Depth	Overall Height	Seat Height	Height of Arms from Floor	Width Between Arms	Seat Depth	Shipping Weight	Cube	COM Seat & Back Yardage	COM Fabric Seat Yardage	COM Fabric Back Yardage	COM Fabric Closed Arm Panel Yardage
CG21	23	26.3	34.5	19	25	21	19.5	39	14	1.6	0.9	1.4	0.4
CP21	23	26.3	45	19	25	21	19.5	44	17	2.0	0.9	2.0	0.4
CG24	26	26.3	34.5	19	25	24	19.5	43	19	1.6	0.9	1.4	0.4
CP24	26	26.3	45	19	25	24	19.5	48	22	2.0	0.9	2.0	0.4
CG30	32	26.3	34.5	19	25	30	19.5	49	20	2.3	0.9	1.4	0.4
CP30	32	26.3	45	19	25	30	19.5	59	28	3.0	0.9	2.0	0.4
CG44	46	26.3	34.5	19	25	44	19.5	66	28	2.9	0.9	1.6	0.4

FAERON MULTIPLE END UNITS

	Overall Width	Overall Depth	Overall Height	Seat Height	Height of Arms from Floor	Width Between Arms	Seat Depth	Shipping Weight	Cube	COM Seat & Back Yardage	COM Fabric Seat Yardage	COM Fabric Back Yardage	COM Fabric Closed Arm Panel Yardage
EG21	23	26.3	34.5	19	25	21	19.5	39	14	1.6	0.9	1.4	0.4
EP21	23	26.3	45	19	25	21	19.5	44	17	2.0	0.9	2.0	0.4
EG24	26	26.3	34.5	19	25	24	19.5	43	19	1.6	0.9	1.4	0.4
EP24	26	26.3	45	19	25	24	19.5	48	22	2.0	0.9	2.0	0.4
EG30	32	26.3	34.5	19	25	30	19.5	49	20	2.3	0.9	1.4	0.4
EP30	32	26.3	45	19	25	30	19.5	59	28	3.0	0.9	2.0	0.4
EG44	46	26.3	34.5	19	25	44	19.5	66	28	2.9	0.9	1.6	0.4

ORDERING NOTES:

A drawing showing the configuration of the multiple seating and tables is required with each purchase order.

WEIGHT CAPACITIES

Faeron weight capacities are as follows:

Guest & Patient Chairs (21" & 24") - 500 lbs

Faeron Option Upcharges

	\$ List		\$ List
CAL 133 & Moisture Barrier (per yard)	64		
Combination Upholstery - dual fabrics (per chair)	33	Solid Surface Arm Cap (pair) - Gr A White	364
Combination Upholstery - Three fabrics (per chair)	64	Solid Surface Arm Cap (pair) - Gr A Color	376
Ganging Bracket	58	Solid Surface Arm Cap (pair) - Gr B	396
Kinetic Back (not available for Plus) (per chair)	120	Solid Surface Arm Cap (pair) - Gr C	410
21" & 24" Under-seat Splashguard (per seat)	58		
30" Under-seat Splashguard (per seat)	72	Solid Surface Arm (pair) - Gr A White	573
Removeable Seat Cover (per seat)	90	Solid Surface Arm (pair) - Gr A Color	598
Removable Back Cover (per back)	58	Solid Surface Arm (pair) - Gr C	678
Urethane Arm Cap (each)	69	Solid Surface Arm (pair) - Gr B	645
Solid Surface Arm Cap (each) - Gr A White	182	See page 631 for color selection.	
Solid Surface Arm Cap (each) - Gr A Color	187		
Solid Surface Arm Cap (each) - Gr B	198		
Solid Surface Arm Cap (each) - Gr C	205	Additional features and options information see page 31.	
Solid Surface Arm (each) - Gr A White	287		
Solid Surface Arm (each) - Gr A Color	299		
Solid Surface Arm (each) - Gr B	321		
Solid Surface Arm (each) - Gr C	339		

Patient backs are available on multiple units, please change the model number FAE2-PCG to FAE2-PCP, and add the following upcharges per back:

	Grade 1	Grade 2	Grade 3	Grade 4	Grade 5	Grade 6	Grade 7	Grade 8	Grade 9
21" Chairs	63	74	90	114	138	164	189	215	265
24" Chairs	68	81	94	119	144	170	195	220	271
30" Chairs	82	95	110	135	159	185	210	235	286

FAERON WOOD | MULTIPLE SEATING - START, CENTER & END UNITS

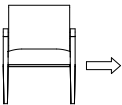
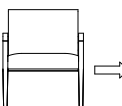
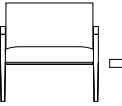
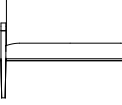
DESCRIPTION/MODEL	Species	COM		COL		FABRIC GRADES			LEATHER		
		1	2	3	4	5	6	7	8	9	
 Start	21" Open Arm Start Unit, Guest Back FAE2-SG21ONC	Beech Palette	1257	1309	1358	1460	1560	1663	1765	1865	2066
	21" Semi Closed Arm Start Unit, Guest Back FAE2-SG21SNC	Beech Palette	1712	1788	1862	2016	2167	2319	2472	2623	2928
	21" Closed Arm Start Unit, Guest Back FAE2-SG21CNC	Beech Palette	1724	1801	1878	2030	2182	2332	2486	2637	2942
	24" Open Arm Start Unit, Guest Back FAE2-SG24ONC	Beech Palette	1348	1399	1451	1552	1653	1753	1856	1956	2160
	24" Semi Closed Arm Start Unit, Guest Back FAE2-SG24SNC	Beech Palette	1802	1879	1954	2107	2257	2410	2563	2715	3017
	24" Closed Arm Start Unit, Guest Back FAE2-SG24CNC	Beech Palette	1816	1892	1967	2119	2272	2422	2577	2727	3032
	30" Open Arm Start Unit, Guest Back FAE2-SG30ONC	Beech Palette	1538	1611	1685	1831	1976	2121	2266	2412	2705
	30" Semi Closed Arm Start Unit, Guest Back FAE2-SG30SNC	Beech Palette	1991	2089	2189	2385	2581	2778	2972	3169	3563
	30" Closed Arm Start Unit, Guest Back FAE2-SG30CNC	Beech Palette	2006	2105	2201	2398	2594	2791	2987	3185	3578
	44" Open Arm Start Unit, Guest Back FAE2-SG44ONC	Beech Palette	1890	1981	2073	2256	2441	2625	2807	2992	3358
	44" Semi Closed Arm Start Unit, Guest Back FAE2-SG44SNC	Beech Palette	2343	2461	2579	2812	3047	3280	3515	3748	4219
	44" Closed Arm Start Unit, Guest Back FAE2-SG44CNC	Beech Palette	2357	2474	2591	2827	3059	3294	3530	3763	4234

ORDERING NOTES: Faeron chairs can be specified with Urethane Arm Caps (UC), Solid Surface Arm Caps (SC) or Solid Surface Arm (SA), replace "NC" in the model number with the **Arm Style** selection below and add the upcharge listed on page 119. Additional features and options information see page 31, Patient back option upcharge see page 119.

PRODUCT CODE KEY

Line	Series	Chair Type	Back Type	Size	Arm Type	Arm Style
FAE Faeron	2 Chair	S Start Unit Multiple Seating	G Guest	21	O Open Arm	NC No Cap
		C Center Unit Multiple Seating	P Patient	24	S Semi Closed Arm	UC Urethane Cap
		E End Unit Multiple Seating		30	C Closed Arm	SC Solid Surface Cap
						SA Solid Surface Arm

FAERON WOOD | MULTIPLE SEATING - START, CENTER & END UNITS

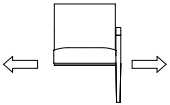
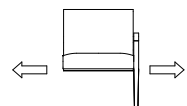
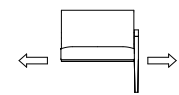
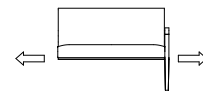

DESCRIPTION/MODEL	Species	COM		COL 3	FABRIC GRADES				LEATHER		
		1	2		4	5	6	7	8	9	
Center	21" Open Arm Center Unit, Guest Back FAE2-CG21ONC	Beech Palette	1155	1206	1257	1359	1460	1562	1663	1765	1967
	21" Semi Closed Arm Center Unit, Guest Back FAE2-CG21SNC	Beech Palette	1414	1478	1539	1667	1794	1920	2045	2172	2427
	21" Closed Arm Center Unit, Guest Back FAE2-CG21CNC	Beech Palette	1428	1491	1555	1680	1808	1934	2060	2188	2440
	24" Open Arm Center Unit, Guest Back FAE2-CG24ONC	Beech Palette	1247	1297	1348	1451	1552	1653	1753	1856	2059
	24" Semi Closed Arm Center Unit, Guest Back FAE2-CG24SNC	Beech Palette	1505	1567	1632	1757	1884	2011	2138	2265	2517
	24" Closed Arm Center Unit, Guest Back FAE2-CG24CNC	Beech Palette	1518	1582	1644	1772	1898	2026	2152	2279	2531
	30" Open Arm Center Unit, Guest Back FAE2-CG30ONC	Beech Palette	1437	1509	1583	1729	1872	2019	2166	2312	2605
	30" Semi Closed Arm Center Unit, Guest Back FAE2-CG30SNC	Beech Palette	1692	1779	1865	2035	2209	2378	2549	2719	3062
	30" Closed Arm Center Unit, Guest Back FAE2-CG30CNC	Beech Palette	1706	1794	1880	2051	2220	2391	2563	2735	3077
	44" Open Arm Center Unit, Guest Back FAE2-CG44ONC	Beech Palette	1789	1881	1972	2157	2340	2524	2709	2891	3260
	44" Semi Closed Arm Center Unit, Guest Back FAE2-CG44SNC	Beech Palette	2045	2148	2254	2463	2672	2881	3091	3299	3717
	44" Closed Arm Center Unit, Guest Back FAE2-CG44CNC	Beech Palette	2060	2164	2268	2478	2686	2894	3104	3314	3732

ORDERING NOTES: Faeron chairs can be specified with Urethane Arm Caps (UC), Solid Surface Arm Caps (SC) or Solid Surface Arm (SA), replace "NC" in the model number with the **Arm Style** selection below and add the upcharge listed on page 119. Additional features and options information see page 31, Patient back option upcharge see page 119.

PRODUCT CODE KEY

Line	Series	Chair Type	Back Type	Size	Arm Type	Arm Style
FAE Faeron	2 Chair	S Start Unit Multiple Seating	G Guest	21	O Open Arm	NC No Cap
		C Center Unit Multiple Seating	P Patient	24	S Semi Closed Arm	UC Urethane Cap
		E End Unit Multiple Seating		30	C Closed Arm	SC Solid Surface Cap
						SA Solid Surface Arm

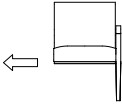
FAERON WOOD | MULTIPLE SEATING - START, CENTER & END UNITS

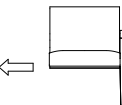
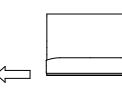
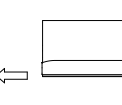
DESCRIPTION/MODEL	Species	COM 1	2	COL 3	4	FABRIC GRADES 5 6 7			LEATHER 8	9	
End 	21" Open Arm End Unit, Guest Back FAE2-EG21ONC	Beech Palette	1155	1206	1257	1359	1460	1562	1663	1765	1967
	21" Semi Closed Arm End Unit, Guest Back FAE2-EG21SNC	Beech Palette	1414	1478	1539	1667	1794	1920	2045	2172	2427
	21" Closed Arm End Unit, Guest Back FAE2-EG21CNC	Beech Palette	1428	1491	1555	1680	1808	1934	2060	2188	2440
	24" Open Arm End Unit, Guest Back FAE2-EG24ONC	Beech Palette	1247	1297	1348	1451	1552	1653	1753	1856	2059
	24" Semi Closed Arm End Unit, Guest Back FAE2-EG24SNC	Beech Palette	1505	1567	1632	1757	1884	2011	2138	2265	2517
	24" Closed Arm End Unit, Guest Back FAE2-EG24CNC	Beech Palette	1518	1582	1644	1772	1898	2026	2152	2279	2531
	30" Open Arm End Unit, Guest Back FAE2-EG30ONC	Beech Palette	1437	1509	1583	1729	1872	2019	2166	2312	2605
	30" Semi Closed Arm End Unit, Guest Back FAE2-EG30SNC	Beech Palette	1692	1779	1865	2035	2209	2378	2549	2719	3062
	30" Closed Arm End Unit, Guest Back FAE2-EG30CNC	Beech Palette	1706	1794	1880	2051	2220	2391	2563	2735	3077
	44" Open Arm End Unit, Guest Back FAE2-EG44ONC	Beech Palette	1789	1881	1972	2157	2340	2524	2709	2891	3260
	44" Semi Closed Arm End Unit, Guest Back FAE2-EG44SNC	Beech Palette	2045	2148	2254	2463	2672	2881	3091	3299	3717
	44" Closed Arm End Unit, Guest Back FAE2-EG44CNC	Beech Palette	2060	2164	2268	2478	2686	2894	3104	3314	3732

ORDERING NOTES: Faeron chairs can be specified with Urethane Arm Caps (UC), Solid Surface Arm Caps (SC) or Solid Surface Arm (SA), replace "NC" in the model number with the **Arm Style** selection below and add the upcharge listed on page 119. Additional features and options information see page 31, Patient back option upcharge see page 119.

PRODUCT CODE KEY

Line	Series	Chair Type	Back Type	Size	Arm Type	Arm Style
<input type="text" value="FAE"/> Faeron	<input type="text" value="2"/> Chair	<input type="text" value="S"/> Start Unit Multiple Seating	<input type="text" value="G"/> Guest	<input type="text" value="21"/>	<input type="text" value="O"/> Open Arm	<input type="text" value="NC"/> No Cap
		<input type="text" value="C"/> Center Unit Multiple Seating	<input type="text" value="P"/> Patient	<input type="text" value="24"/>	<input type="text" value="S"/> Semi Closed Arm	<input type="text" value="UC"/> Urethane Cap
		<input type="text" value="E"/> End Unit Multiple Seating		<input type="text" value="30"/>	<input type="text" value="C"/> Closed Arm	<input type="text" value="SC"/> Solid Surface Cap
						<input type="text" value="SA"/> Solid Surface Arm

FAERON WOOD | MULTIPLE SEATING - FREESPAN UNITS

DIMENSIONS & COM REQUIREMENTS

UNIT WITH NO CENTER ARM

	Overall Width	Overall Depth	Overall Height	Seat Height	Height of Arms from Floor	Width Between Arms	Seat Depth	Shipping Weight	Cube	COM Seat & Back Yardage	COM Fabric Seat Yardage	COM Fabric Back Yardage	COM Fabric Closed Arm Panel Yardage
PCFG21X2A	46.5	26.3	34.5	19	25.0	43.0	19.5	74	28	3.0	1.5	2.1	0.8
PCFP21X2A	46.5	26.3	45.0	19	25.0	43.0	19.5	84	37	3.8	1.5	3.0	0.8
PCFG21X3A	68.0	26.3	34.5	19	25.0	64.8	19.5	105	40	4.6	2.4	3.5	0.8
PCFP21X3A	68.0	26.3	45.0	19	25.0	64.8	19.5	120	54	5.8	2.4	5.0	0.8
PCFG24X2A	52.5	26.3	34.5	19	25.0	49.0	19.5	81	30	3.0	1.5	2.1	0.8
PCFP24X2A	52.5	26.3	45.0	19	25.0	49.0	19.5	91	42	3.8	1.5	3.0	0.8
PCFG24X3A	77.0	26.3	34.5	19	25.0	73.8	19.5	117	45	4.6	2.4	3.5	0.8
PCFP24X3A	77.0	26.3	45.0	19	25.0	73.8	19.5	132	61	5.8	2.4	5.0	0.8

UNIT WITH CENTER ARM

	Overall Width	Overall Depth	Overall Height	Seat Height	Height of Arms from Floor	Width Between Arms	Seat Depth	Shipping Weight	Cube	COM Seat & Back Yardage	COM Fabric Seat Yardage	COM Fabric Back Yardage
PCFG21X2B	48.3	26.3	34.5	19	25.0	21.5	19.5	77	28	3.0	1.5	2.1
PCFP21X2B	48.3	26.3	45.0	19	25.0	21.5	19.5	87	38	3.8	1.5	3.0
PCFG21X3B	71.5	26.3	34.5	19	25.0	21.5	19.5	111	40	4.6	2.4	3.5
PCFP21X3B	71.5	26.3	45.0	19	25.0	21.5	19.5	126	56	5.8	2.4	5.0
PCFG24X2B	54.3	26.3	34.5	19	25.0	24.5	19.5	84	30	3.0	1.5	2.1
PCFP24X2B	54.3	26.3	45.0	19	25.0	24.5	19.5	94	43	3.8	1.5	3.0
PCFG24X3B	80.5	26.3	34.5	19	25.0	24.5	19.5	123	45	4.6	2.4	3.5
PCFP24X3B	80.5	26.3	45.0	19	25.0	24.5	19.5	138	63	5.8	2.4	5.0

UNIT WITH CENTER ARM (CONTINUED), GUEST AND PATIENT BACKS

Unit With Center Arm (Continued)	COM Fabric Closed Arm Panels (2 Arms)	COM Fabric Closed Arm Panels (3 Arms)	COM Fabric Closed Arm Panels (4 Arms)
PCF21X2B	0.8	1.2	1.6
PCF21X3B	0.8	1.2	1.6
PCF24X2B	0.8	1.2	1.6
PCF24X3B	0.8	1.2	1.6

Note: Some vinyls, leathers & upholsteries are not suitable for application on Faeron seating.

The approval process is as follows:

1. A sample of the COM must be provided to Krug Customer Service prior to or at the time of order.
2. The sample will be reviewed and the customer advised if the fabric is unsuitable.
3. The COM fabric or leather will be inspected when received at the factory, to identify any further concerns with its suitability.

ORDERING NOTES:

A drawing showing the configuration of the multiple seating and tables is required with each purchase order.

WEIGHT CAPACITIES

Faeron weight capacities are as follows:

2-Seat Freespan - 525 lbs per unit

3-Seat Freespan - 750 lbs per unit

Faeron Option Upcharges	\$ List	\$ List
CAL 133 & Moisture Barrier (per yard)	64	
Combination Upholstery - dual fabrics (per chair)	33	Solid Surface Arm Cap (pair) - Gr A White 364
Combination Upholstery - Three fabrics (per chair)	64	Solid Surface Arm Cap (pair) - Gr A Color 376
Ganging Bracket	58	Solid Surface Arm Cap (pair) - Gr B 396
Kinetic Back (not available for Plus)	120	Solid Surface Arm Cap (pair) - Gr C 410
21" & 24" Under-seat Splashguard	58	
Removeable Seat Cover (per seat)	90	Solid Surface Arm (pair) - Gr A White 573
Removable Back Cover (per back)	58	Solid Surface Arm (pair) - Gr A Color 598
Urethane Arm Cap (each)	69	Solid Surface Arm (pair) - Gr C 678
		Solid Surface Arm (pair) - Gr B 645

Additional features and options information see page 31.

See page 631 for color selection.

Patient backs are available on multiple units, please change the model number FAE2-PCG to FAE2-PCP, and add the following upcharges per back:

	Grade 1	Grade 2	Grade 3	Grade 4	Grade 5	Grade 6	Grade 7	Grade 8	Grade 9
21" Chairs	63	74	90	114	138	164	189	215	265
24" Chairs	68	81	94	119	144	170	195	220	271

FAERON WOOD | MULTIPLE SEATING - FREESPAN UNITS WITHOUT CENTER ARMS

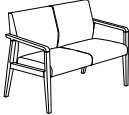
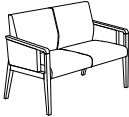
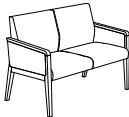
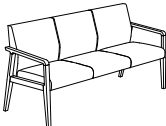
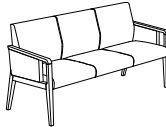
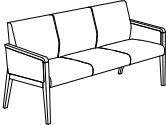
DESCRIPTION/MODEL	Species	COM		COL		FABRIC GRADES		LEATHER		
		1	2	3	4	5	6	7	8	9
 21" Pre-Configured Freespan Unit - Open Arm 2 Seat, Guest Back FAE2-PCFG21X2AONC	Beech	2037	2139	2240	2443	2643	2849	3053	3255	3661
	Palette									
 21" Pre-Configured Freespan Unit - Semi Closed Arm 2 Seat, Guest Back FAE2-PCFG21X2ASNC	Beech	2491	2616	2744	2998	3251	3507	3760	4013	4518
	Palette									
 21" Pre-Configured Freespan Unit - Closed Arm 2 Seat, Guest Back FAE2-PCFG21X2ACNC	Beech	2505	2632	2760	3012	3266	3519	3772	4027	4532
	Palette									
 21" Pre-Configured Freespan Unit - Open Arm 3 Seat, Guest Back FAE2-PCFG21X3AONC	Beech	2772	2924	3076	3381	3685	3988	4292	4596	5205
	Palette									
 21" Pre-Configured Freespan Unit - Semi Closed Arm 3 Seat, Guest Back FAE2-PCFG21X3ASNC	Beech	3224	3404	3580	3935	4290	4645	5000	5355	6064
	Palette									
 21" Pre-Configured Freespan Unit - Closed Arm 3 Seat, Guest Back FAE2-PCFG21X3ACNC	Beech	3239	3417	3594	3950	4305	4659	5012	5368	6079
	Palette									

ORDERING NOTES: Faeron chairs can be specified with Urethane Arm Caps (UC), Solid Surface Arm Caps (SC) or Solid Surface Arm (SA), replace "NC" in the model number with the **Arm Style** selection below and add the upcharge listed on page 123. Additional features and options information see page 31, Patient back option upcharge page 123.

PRODUCT CODE KEY

Line	Series	Chair Type	Back Type	Size	Unit Style	Arm Type	Arm Style
FAE	2	PCF	G	21X2	A	O	NC
Faeron	Chair	Pre-Configured Freespan Multiple Unit	Guest Back		Unit with no Center Arm	Open Arm	No Cap
			P	21X3	B	S	UC
			Patient Back		Unit with Center Arm	Semi Closed Arm	Urethane Cap
				24X2		C	SC
						Closed Arm	Solid Surface Cap
				24X3			SA
							Solid Surface Arm

FAERON WOOD | MULTIPLE SEATING - FREESPAN UNITS WITHOUT CENTER ARMS

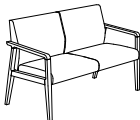
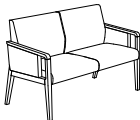
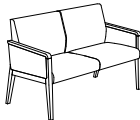
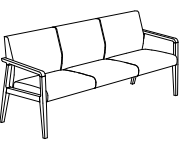
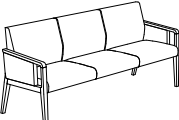
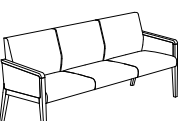
DESCRIPTION/MODEL	Species	COM		COL		FABRIC GRADES			LEATHER	
		1	2	3	4	5	6	7	8	9
 24" Pre-Configured Freespan Unit - Open Arm 2 Seat, Guest Back FAE2-PCFG24X2AONC	Beech	2212	2313	2413	2616	2820	3024	3224	3429	3834
	Palette									
 24" Pre-Configured Freespan Unit - Semi Closed Arm 2 Seat, Guest Back FAE2-PCFG24X2ASNC	Beech	2664	2791	2919	3172	3427	3680	3933	4186	4693
	Palette									
 24" Pre-Configured Freespan Unit - Closed Arm 2 Seat, Guest Back FAE2-PCFG24X2ACNC	Beech	2680	2805	2933	3186	3439	3692	3948	4200	4708
	Palette									
 24" Pre-Configured Freespan Unit - Open Arm 3 Seat, Guest Back FAE2-PCFG24X3AONC	Beech	3017	3172	3323	3628	3932	4236	4540	4844	5453
	Palette									
 24" Pre-Configured Freespan Unit - Semi Closed Arm 3 Seat, Guest Back FAE2-PCFG24X3ASNC	Beech	3472	3651	3828	4183	4537	4891	5247	5603	6312
	Palette									
 24" Pre-Configured Freespan Unit - Closed Arm 3 Seat, Guest Back FAE2-PCFG24X3ACNC	Beech	3487	3664	3843	4196	4553	4905	5261	5615	6325
	Palette									

ORDERING NOTES: Faeron chairs can be specified with Urethane Arm Caps (UC), Solid Surface Arm Caps (SC) or Solid Surface Arm (SA), replace "NC" in the model number with the **Arm Style** selection below and add the upcharge listed on page 123. Additional features and options information see page 31. Patient back option upcharge page 123.

PRODUCT CODE KEY

Line	Series	Chair Type	Back Type	Size	Unit Style	Arm Type	Arm Style
FAE	2	PCF	G	21X2	A	O	NC
Faeron	Chair	Pre-Configured Freespan Multiple Unit	Guest Back		Unit with no Center Arm	Open Arm	No Cap
			P	21X3	B	S	UC
			Patient Back		Unit with Center Arm	Semi Closed Arm	Urethane Cap
				24X2		C	SC
						Closed Arm	Solid Surface Cap
				24X3			SA
							Solid Surface Arm

FAERON WOOD | MULTIPLE SEATING - FREESPAN UNITS WITH CENTER ARMS

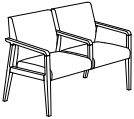
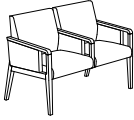
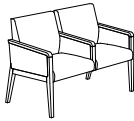
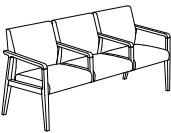
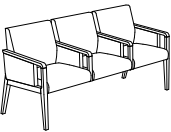
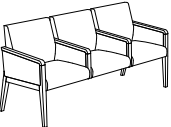

DESCRIPTION/MODEL	Species	COM		COL		FABRIC GRADES			LEATHER	
		1	2	3	4	5	6	7	8	9
 21" Pre-Configured Freespan Unit - Open Arm 2 Seat, Guest Back FAE2-PCFG21X2BONC	Beech	2628	2727	2829	3032	3236	3437	3641	3844	4248
	Palette									
 21" Pre-Configured Freespan Unit - Semi Closed Arm 2 Seat, Guest Back FAE2-PCFG21X2BSNC	Beech	3339	3477	3617	3894	4173	4454	4732	5009	5568
	Palette									
 21" Pre-Configured Freespan Unit - Closed Arm 2 Seat, Guest Back FAE2-PCFG21X2BCNC	Beech	3366	3505	3643	3921	4203	4481	4758	5036	5595
	Palette									
 21" Pre-Configured Freespan Unit - Open Arm 3 Seat, Guest Back FAE2-PCFG21X3BONC	Beech	3724	3877	4029	4335	4638	4943	5245	5552	6159
	Palette									
 21" Pre-Configured Freespan Unit - Semi Closed Arm 3 Seat, Guest Back FAE2-PCFG21X3BSNC	Beech	4692	4895	5097	5503	5911	6315	6718	7125	7938
	Palette									
 21" Pre-Configured Freespan Unit - Closed Arm 3 Seat, Guest Back FAE2-PCFG21X3BCNC	Beech	4734	4937	5139	5545	5949	6357	6762	7166	7978
	Palette									

ORDERING NOTES: Faeron chairs can be specified with Urethane Arm Caps (UC), Solid Surface Arm Caps (SC) or Solid Surface Arm (SA), replace "NC" in the model number with the **Arm Style** selection below and add the upcharge listed on page 123. Additional features and options information see page 31, Patient back option upcharge page 123.

PRODUCT CODE KEY

Line	Series	Chair Type	Back Type	Size	Unit Style	Arm Type	Arm Style
FAE	2	PCF	G	21X2	A	O	NC
Faeron	Chair	Pre-Configured Freespan Multiple Unit	Guest Back		Unit with no Center Arm	Open Arm	No Cap
			P	21X3	B	S	UC
			Patient Back		Unit with Center Arm	Semi Closed Arm	Urethane Cap
				24X2		C	SC
						Closed Arm	Solid Surface Cap
				24X3			SA
							Solid Surface Arm

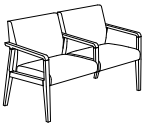
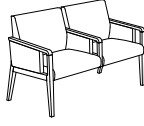
FAERON WOOD | MULTIPLE SEATING - FREESPAN UNITS WITH CENTER ARMS

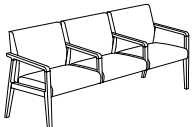
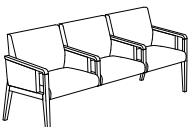
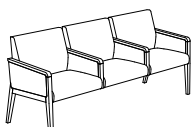
DESCRIPTION/MODEL	Species	COM		COL		FABRIC GRADES			LEATHER	
		1	2	3	4	5	6	7	8	9
 24" Pre-Configured Freespan Unit - Open Arm 2 Seat, Guest Back FAE2-PCFG24X2BONC	Beech	2802	2903	3004	3207	3409	3610	3815	4016	4423
	Palette									
 24" Pre-Configured Freespan Unit - Semi Closed Arm 2 Seat, Guest Back FAE2-PCFG24X2BSNC	Beech	3512	3651	3789	4068	4348	4626	4904	5185	5741
	Palette									
 24" Pre-Configured Freespan Unit - Closed Arm 2 Seat, Guest Back FAE2-PCFG24X2BCNC	Beech	3538	3679	3817	4097	4375	4654	4931	5213	5768
	Palette									
 24" Pre-Configured Freespan Unit - Open Arm 3 Seat, Guest Back FAE2-PCFG24X3BONC	Beech	3974	4125	4278	4581	4886	5190	5495	5797	6408
	Palette									
 24" Pre-Configured Freespan Unit - Semi Closed Arm 3 Seat, Guest Back FAE2-PCFG24X3BSNC	Beech	4942	5142	5345	5751	6157	6563	6968	7373	8185
	Palette									
 24" Pre-Configured Freespan Unit - Closed Arm 3 Seat, Guest Back FAE2-PCFG24X3BCNC	Beech	4981	5185	5388	5792	6198	6604	7009	7415	8227
	Palette									

ORDERING NOTES: Faeron chairs can be specified with Urethane Arm Caps (UC), Solid Surface Arm Caps (SC) or Solid Surface Arm (SA), replace "NC" in the model number with the **Arm Style** selection below and add the upcharge listed on page 123. Additional features and options information see page 31, Patient back option upcharge page 123.

PRODUCT CODE KEY

Line	Series	Chair Type	Back Type	Size	Unit Style	Arm Type	Arm Style
FAE	2	PCF	G	21X2	A	O	NC
Faeron	Chair	Pre-Configured Freespan Multiple Unit	Guest Back		Unit with no Center Arm	Open Arm	No Cap
			P	21X3	B	S	UC
			Patient Back		Unit with Center Arm	Semi Closed Arm	Urethane Cap
				24X2		C	SC
						Closed Arm	Solid Surface Cap
				24X3			SA
							Solid Surface Arm

FAERON METAL | MULTIPLE SEATING - PRECONFIGURED UNITS

DIMENSIONS & COM REQUIREMENTS

	Overall Width	Overall Depth	Overall Height	Seat Height	Height of Arms from Floor	Width Between Arms	Seat Depth	Shipping Weight	Cube	COM Seat & Back Yardage	COM Fabric Seat Yardage	COM Fabric Back Yardage	COM Fabric Closed Arm Panel Yardage
PCG21X2	48.3	26.3	34.5	19.0	25.0	21	19.5	95	28	3.0	1.5	2.1	1.44
PCP21X2	48.3	26.3	45.0	19.0	25.0	21	19.5	105	38	3.8	1.5	3.0	1.44
PCG21X3	71.5	26.3	34.5	19.0	25.0	21	19.5	134	41	4.6	2.4	3.5	1.92
PCP21X3	71.5	26.3	45.0	19.0	25.0	21	19.5	149	56	5.8	2.4	5.0	1.92
PCG24X2	54.3	26.3	34.5	19.0	25.0	24	19.5	102	31	3.0	1.5	2.1	1.44
PCP24X2	54.3	26.3	45.0	19.0	25.0	24	19.5	112	43	3.8	1.5	3.0	1.44
PCG24X3	80.5	26.3	34.5	19.0	25.0	24	19.5	146	46	4.6	2.4	3.5	1.92
PCP24X3	80.5	26.3	45.0	19.0	25.0	24	19.5	161	63	5.8	2.4	5.0	1.92

A drawing showing the configuration of the multiple seating and tables is required with each purchase order.

PRE-CONFIGURED MULTIPLE UNITS	SEAT	GUEST BACK	PATIENT BACK	CLOSED ARM PANEL
PC21x2	3.8	1.5	3.0	1.44
PC21x3	5.8	2.4	5.0	1.92
PC24X2	3.8	1.5	3.0	1.44
PC24X3	5.8	2.4	5.0	1.92

Note: Some vinyls, leathers & upholsteries are not suitable for application on Faeron Metal seating. Please refer to page 628 for C.O.M approval process.

Faeron Option Upcharges	\$ List	\$ List
CAL 133 & Moisture Barrier (per yard)	64	Solid Surface Arm (each) - Gr A White 287
Ganging Bracket	58	Solid Surface Arm (each) - Gr A Color 299
Kinetic Back (not available for Plus)	120	Solid Surface Arm (each) - Gr B 321
21" & 24" Under-seat Splashguard	58	Solid Surface Arm (each) - Gr C 339
Removeable Seat Cover (per seat)	90	
Removable Back Cover (per back)	58	Solid Surface Arm (pair) - Gr A White 573
Combination Upholstery - dual fabrics (per chair)	33	Solid Surface Arm (pair) - Gr A Color 598
Combination Upholstery - Three fabrics (per chair)	64	Solid Surface Arm (pair) - Gr B 645
Beech/Palette Wood Arm (each)	108	Solid Surface Arm (pair) - Gr C 678
Beech/Palette Wood Arm (per pair)	215	
Non-Marring Glide	16	See page 631 for color selection.

Additional features and options information see page 37.





Patient backs are available on multiple units, please change the model number FAE2-PCG to FAE2-PCP, and add the following upcharges per back:

	Grade 1	Grade 2	Grade 3	Grade 4	Grade 5	Grade 6	Grade 7	Grade 8	Grade 9
21" Chairs	63	74	90	114	138	164	189	215	265
24" Chairs	68	81	94	119	144	170	195	220	271

WEIGHT CAPACITIES

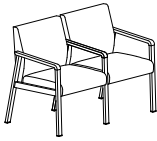
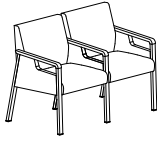
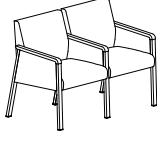
Faeron Metal weight capacities are as follows:
 Guest & Patient Chairs (21" & 24") - 500 lbs

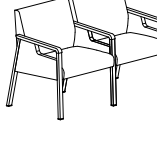
FAERON METAL | MULTIPLE SEATING - PRECONFIGURED UNITS

DESCRIPTION/MODEL	COM		COL	FABRIC GRADES			LEATHER		
	1	2	3	4	5	6	7	8	9
 2 Seat - 21" Open Polymer Arm Pre-configured Unit, Guest Backs, Silver Metallic Frame FAE2M-PCG21X2OPAS	1989	2087	2185	2377	2569	2763	2956	3147	3535
	2313	2410	2507	2699	2893	3087	3279	3472	3858
 2 Seat - 21" Semi Closed Polymer Arm Pre-configured Unit, Guest Backs, Silver Metallic Frame FAE2M-PCG21X2SPAS	2668	2800	2933	3197	3463	3730	3995	4260	4792
	2989	3121	3255	3520	3787	4053	4317	4583	5113
 2 Seat - 21" Closed Polymer Arm Pre-configured Unit, Guest Backs, Silver Metallic Frame FAE2M-PCG21X2CPAS	2694	2827	2958	3223	3490	3756	4021	4287	4817
	3015	3147	3281	3546	3814	4080	4343	4609	5140
 2 Seat - 24" Open Polymer Arm Pre-configured Unit, Guest Backs, Silver Metallic Frame FAE2M-PCG24X2OPAS	2178	2274	2371	2565	2759	2951	3143	3337	3723
	2503	2596	2695	2888	3081	3273	3468	3661	4047
 2 Seat - 24" Semi Closed Polymer Arm Pre-configured Unit, Guest Backs, Silver Metallic Frame FAE2M-PCG24X2SPAS	2854	2987	3119	3385	3652	3917	4183	4447	4979
	3179	3311	3444	3709	3975	4239	4505	4771	5302
 2 Seat - 24" Closed Polymer Arm Pre-configured Unit, Guest Backs, Silver Metallic Frame FAE2M-PCG24X2CPAS	2881	3013	3145	3411	3679	3943	4208	4474	5006
	3205	3337	3470	3735	4001	4266	4531	4797	5328

ORDERING NOTES:

Faeron Metal chairs can also be specified with a Wood Arm (WA) or a Solid Surface Arm (SA), replace "PA" in the model number with the **Arm Style** selection below and add the upcharge listed. Additional features and options information see page 37, option upcharges page 128.

Arm Style Option Upcharges

	\$ List
Solid Surface Arm (pair) - Gr A White	573
Solid Surface Arm (pair) - Gr A Color	598
Solid Surface Arm (pair) - Gr B	645
Solid Surface Arm (pair) - Gr C	678
Beech/Palette Wood Arm (per pair)	215

PRODUCT CODE KEY

Line	Series	Chair Type	Back Type	Size	Arm Type	Arm Style	Metal Finish
FAE	2M	UC	G	21X2	O	PA	S
Faeron	Chair	Pre-configured Multiple Unit	Guest		Open Arm	Polymer Arm	Silver Metallic
			P	24X2	S	WA	N
			Patient		Semi Closed Arm	Wood Arm	Brushed Nickel
				21X3	C	SA	
					Closed Arm	Solid Surface Arm	
				24X3			

FAERON METAL | MULTIPLE SEATING - PRECONFIGURED UNITS

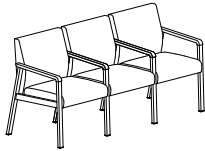
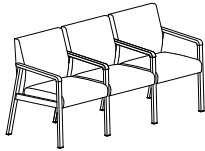
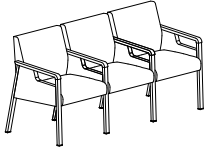
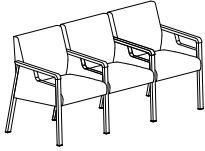
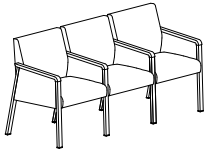
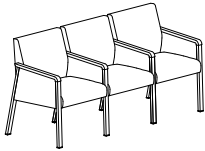
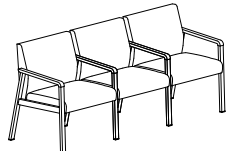
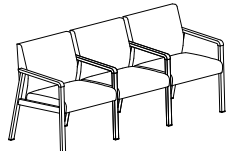
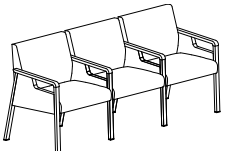
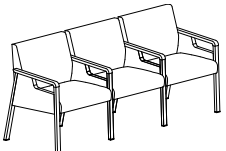
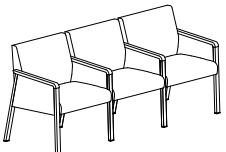
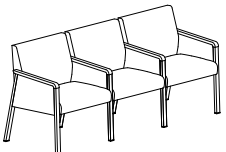
DESCRIPTION/MODEL	COM		COL	FABRIC GRADES			LEATHER		
	1	2	3	4	5	6	7	8	9
	3 Seat - 21" Open Polymer Arm Pre-configured Unit, Guest Backs, Silver Metallic Frame								
	FAE2M-PCG21X3OPAS	2838	2984	3129	3418	3709	3997	4288	4578
	3 Seat - 21" Open Polymer Arm Pre-configured Unit, Guest Backs, Brushed Nickel Frame								
	FAE2M-PCG21X3OPAN	3268	3414	3559	3848	4139	4427	4718	5008
	3 Seat - 21" Semi Closed Polymer Arm Pre-configured Unit, Guest Backs, Silver Metallic Frame								
	FAE2M-PCG21X3SPAS	3760	3953	4145	4531	4919	5305	5691	6077
	3 Seat - 21" Semi Closed Polymer Arm Pre-configured Unit, Guest Backs, Brushed Nickel Frame								
	FAE2M-PCG21X3SPAN	4190	4382	4576	4962	5348	5736	6121	6507
	3 Seat - 21" Closed Polymer Arm Pre-configured Unit, Guest Backs, Silver Metallic Frame								
	FAE2M-PCG21X3CPAS	3798	3993	4185	4571	4958	5344	5730	6115
	3 Seat - 21" Closed Polymer Arm Pre-configured Unit, Guest Backs, Brushed Nickel Frame								
	FAE2M-PCG21X3CPAN	4230	4422	4615	5002	5389	5773	6161	6545
	3 Seat - 24" Open Polymer Arm Pre-configured Unit, Guest Backs, Silver Metallic Frame								
	FAE2M-PCG24X3OPAS	3058	3155	3297	3587	3876	4167	4457	4746
	3 Seat - 24" Open Polymer Arm Pre-configured Unit, Guest Backs, Brushed Nickel Frame								
	FAE2M-PCG24X3OPAN	3489	3583	3728	4019	4308	4596	4887	5178
	3 Seat - 24" Semi Closed Polymer Arm Pre-configured Unit, Guest Backs, Silver Metallic Frame								
	FAE2M-PCG24X3SPAS	3980	4120	4315	4702	5087	5473	5860	6245
	3 Seat - 24" Semi Closed Polymer Arm Pre-configured Unit, Guest Backs, Brushed Nickel Frame								
	FAE2M-PCG24X3SPAN	4411	4553	4744	5131	5518	5904	6290	6676
	3 Seat - 24" Closed Polymer Arm Pre-configured Unit, Guest Backs, Silver Metallic Frame								
	FAE2M-PCG24X3CPAS	4020	4161	4354	4740	5128	5513	5898	6286
	3 Seat - 24" Closed Polymer Arm Pre-configured Unit, Guest Backs, Brushed Nickel Frame								
	FAE2M-PCG24X3CPAN	4449	4591	4785	5170	5558	5944	6331	6715

ORDERING NOTES:

Faeron Metal chairs can also be specified with a Wood Arm (WA) or a Solid Surface Arm (SA), replace "PA" in the model number with the **Arm Style** selection below and add the upcharge listed. Additional features and options information see page 37, option upcharges page 128.

Arm Style Option Upcharges

	\$ List
Solid Surface Arm (pair) - Gr A White	573
Solid Surface Arm (pair) - Gr A Color	598
Solid Surface Arm (pair) - Gr B	645
Solid Surface Arm (pair) - Gr C	678
Beech/Palette Wood Arm (per pair)	215

PRODUCT CODE KEY

Line	Series	Chair Type	Back Type	Size	Arm Type	Arm Style	Metal Finish
FAE	2M	PC	G	21X2	O	PA	S
Faeron	Chair	Pre-configured Multiple Unit	Guest		Open Arm	Polymer Arm	Silver Metallic
			P	24X2	S	WA	N
			Patient		Semi Closed Arm	Wood Arm	Brushed Nickel
				21X3	C	SA	
					Closed Arm	Solid Surface Arm	
				24X3			

FAERON METAL | MULTIPLE SEATING - START, CENTER & END UNITS

DIMENSIONS & COM REQUIREMENTS

FAERON METAL MULTIPLE START UNITS

	Overall Width	Overall Depth	Overall Height	Seat Height	Height of Arms from Floor	Width Between Arms	Seat Depth	Shipping Weight	Cube	COM Seat & Back Yardage	COM Fabric Seat Yardage	COM Fabric Back Yardage	COM Fabric Closed Arm Panel (Pair) Yardage
SG21	25	26.3	34.5	19	25	21	19.5	56	14	1.6	0.9	1.4	0.96
SP21	25	26.3	45	19	25	21	19.5	61	17	2.0	0.9	2.0	0.96
SG24	28	26.3	34.5	19	25	24	19.5	60	19	1.6	0.9	1.4	0.96
SP24	28	26.3	45	19	25	24	19.5	65	22	2.0	0.9	2.0	0.96
SG30	34	26.3	34.5	19	25	30	19.5	66	20	2.3	0.9	1.4	0.96
SP30	34	26.3	45	19	25	30	19.5	76	28	3.0	0.9	2.0	0.96
SG44	48	26.3	34.5	19	25	44	19.5	83	28	2.9	0.9	1.6	0.96

FAERON METAL MULTIPLE CENTER UNITS

	Overall Width	Overall Depth	Overall Height	Seat Height	Height of Arms from Floor	Width Between Arms	Seat Depth	Shipping Weight	Cube	COM Seat & Back Yardage	COM Fabric Seat Yardage	COM Fabric Back Yardage	COM Fabric Closed Arm Panel Yardage
CG21	23	26.3	34.5	19	25	21	19.5	46	14	1.6	0.9	1.4	0.48
CP21	23	26.3	45	19	25	21	19.5	51	17	2.0	0.9	2.0	0.48
CG24	26	26.3	34.5	19	25	24	19.5	50	19	1.6	0.9	1.4	0.48
CP24	26	26.3	45	19	25	24	19.5	55	22	2.0	0.9	2.0	0.48
CG30	32	26.3	34.5	19	25	30	19.5	56	20	2.3	0.9	1.4	0.48
CP30	32	26.3	45	19	25	30	19.5	66	28	3.0	0.9	2.0	0.48
CG44	46	26.3	34.5	19	25	44	19.5	73	28	2.9	0.9	1.6	0.48

FAERON METAL MULTIPLE END UNITS

	Overall Width	Overall Depth	Overall Height	Seat Height	Height of Arms from Floor	Width Between Arms	Seat Depth	Shipping Weight	Cube	COM Seat & Back Yardage	COM Fabric Seat Yardage	COM Fabric Back Yardage	COM Fabric Closed Arm Panel Yardage
EG21	23	26.3	34.5	19	25	21	19.5	46	14	1.6	0.9	1.4	0.48
EP21	23	26.3	45	19	25	21	19.5	51	17	2.0	0.9	2.0	0.48
EG24	26	26.3	34.5	19	25	24	19.5	50	19	1.6	0.9	1.4	0.48
EP24	26	26.3	45	19	25	24	19.5	55	22	2.0	0.9	2.0	0.48
EG30	32	26.3	34.5	19	25	30	19.5	56	20	2.3	0.9	1.4	0.48
EP30	32	26.3	45	19	25	30	19.5	66	28	3.0	0.9	2.0	0.48
EG44	46	26.3	34.5	19	25	44	19.5	73	28	2.9	0.9	1.6	0.48

ORDERING NOTES:

A drawing showing the configuration of the multiple seating and tables is required with each purchase order.

WEIGHT CAPACITIES

Faeron Metal weight capacities are as follows:

Guest & Patient Chairs (21" & 24") - 500 lbs

Faeron Option Upcharges

	\$ List		\$ List
CAL 133 & Moisture Barrier (per yard)	64	Beech/Palette Wood Arm (each)	108
Ganging Bracket	58	Beech/Palette Wood Arm (per pair)	215
Kinetic Back (not available for Plus)	120	Solid Surface Arm (each) - Gr A White	287
21" & 24" Under-seat Splashguard	58	Solid Surface Arm (each) - Gr A Color	299
30" Under-seat Splashguard	72	Solid Surface Arm (each) - Gr B	321
44" Under-seat Splashguard	91	Solid Surface Arm (each) - Gr C	339
Removeable Seat Cover (per seat)	90		
Removable Back Cover (per back)	58	Solid Surface Arm (pair) - Gr A White	573
Combination Upholstery - dual fabrics (per chair)	33	Solid Surface Arm (pair) - Gr A Color	598
Combination Upholstery - Three fabrics (per chair)	64	Solid Surface Arm (pair) - Gr B	645
Non-Marring Glide	16	Solid Surface Arm (pair) - Gr C	678

Additional features and options information see page 37.

See page 631 for color selection.

Patient backs are available on multiple units, please change the model number FAE2M-SG to FAE2M-SP and add the following upcharges per back:

	Grade 1	Grade 2	Grade 3	Grade 4	Grade 5	Grade 6	Grade 7	Grade 8	Grade 9
21" Chairs	63	74	90	114	138	164	189	215	265
24" Chairs	68	81	94	119	144	170	195	220	271
30" Chairs	82	95	110	135	159	185	210	235	286

FAERON METAL | MULTIPLE SEATING - START, CENTER & END UNITS

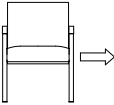
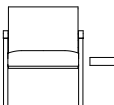
DESCRIPTION/MODEL	COM		COL		FABRIC GRADES			LEATHER			
	1	2	3	4	5	6	7	8	9		
	Start										
	21" Open Polymer Arm Start Unit, Guest Back, Silver Metallic Frame FAE2M-SG21OPAS		1126	1173	1222	1318	1415	1512	1610	1705	1898
	21" Open Polymer Arm Start Unit, Guest Back, Brushed Nickel Frame FAE2M-SG21OPAN		1341	1390	1437	1535	1631	1728	1823	1921	2113
	21" Semi Closed Polymer Arm Start Unit, Guest Back, Silver Metallic Frame FAE2M-SG21SPAS		1558	1631	1703	1848	1991	2136	2282	2428	2717
	21" Semi Closed Polymer Arm Start Unit, Guest Back, Brushed Nickel Frame FAE2M-SG21SPAN		1773	1845	1918	2063	2209	2353	2497	2641	2933
	21" Closed Polymer Arm Start Unit, Guest Back, Silver Metallic Frame FAE2M-SG21CPAS		1570	1643	1715	1861	2006	2149	2296	2440	2730
21" Closed Polymer Arm Start Unit, Guest Back, Brushed Nickel Frame FAE2M-SG21CPAN		1788	1858	1930	2077	2220	2366	2510	2656	2946	
<hr/>											
	Start										
	24" Open Polymer Arm Start Unit, Guest Back, Silver Metallic Frame FAE2M-SG24OPAS		1213	1262	1310	1405	1504	1598	1695	1792	1985
	24" Open Polymer Arm Start Unit, Guest Back, Brushed Nickel Frame FAE2M-SG24OPAN		1429	1478	1526	1620	1717	1815	1911	2007	2198
	24" Semi Closed Polymer Arm Start Unit, Guest Back, Silver Metallic Frame FAE2M-SG24SPAS		1644	1716	1790	1935	2080	2222	2369	2513	2804
	24" Semi Closed Polymer Arm Start Unit, Guest Back, Brushed Nickel Frame FAE2M-SG24SPAN		1860	1932	2004	2149	2295	2438	2585	2728	3017
	24" Closed Polymer Arm Start Unit, Guest Back, Silver Metallic Frame FAE2M-SG24CPAS		1659	1730	1802	1947	2091	2237	2383	2527	2817
24" Closed Polymer Arm Start Unit, Guest Back, Brushed Nickel Frame FAE2M-SG24CPAN		1872	1945	2017	2164	2307	2452	2596	2742	3032	

ORDERING NOTES:

Faeron Metal chairs can also be specified with a Wood Arm (WA) or a Solid Surface Arm (SA), replace "PA" in the model number with the **Arm Style** selection below and add the upcharge listed. Additional features and options information see page 37, option upcharges page 131.

Arm Style Option Upcharges

	\$ List
Solid Surface Arm (pair) - Gr A White	573
Solid Surface Arm (pair) - Gr A Color	598
Solid Surface Arm (pair) - Gr B	645
Solid Surface Arm (pair) - Gr C	678
Beech/Palette Wood Arm (per pair)	215

PRODUCT CODE KEY

Line	Series	Chair Type	Back Type	Size	Arm Type	Arm Style	Metal Finish
FAE	2M	S	G	21	O	PA	S
Faeron	Chair	Start Unit Multiple Seating	Guest		Open Arm	Polymer Arm	Silver Metallic
		C	P	24	S	WA	N
		Center Unit Multiple Seating	Patient		Semi Closed Arm	Wood Arm	Brushed Nickel
		E		30	C	SA	
		End Unit Multiple Seating		44	Closed Arm	Solid Surface Arm	

FAERON METAL | MULTIPLE SEATING - START, CENTER & END UNITS

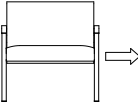
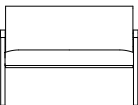
DESCRIPTION/MODEL	COM		COL		FABRIC GRADES			LEATHER	
	1	2	3	4	5	6	7	8	9
Start 	30" Open Polymer Arm Start Unit, Guest Back, Silver Metallic Frame								
FAE2M-SG30OPAS	1394	1462	1533	1670	1810	1949	2087	2227	2505
	30" Open Polymer Arm Start Unit, Guest Back, Brushed Nickel Frame								
FAE2M-SG30OPAN	1610	1677	1747	1885	2026	2165	2302	2441	2719
	30" Semi Closed Polymer Arm Start Unit, Guest Back, Silver Metallic Frame								
FAE2M-SG30SPAS	1825	1920	2012	2198	2386	2574	2761	2948	3322
	30" Semi Closed Polymer Arm Start Unit, Guest Back, Brushed Nickel Frame								
FAE2M-SG30SPAN	2041	2134	2228	2415	2602	2789	2977	3163	3537
	30" Closed Polymer Arm Start Unit, Guest Back, Silver Metallic Frame								
FAE2M-SG30CPAS	1839	1932	2026	2213	2399	2587	2773	2962	3336
	30" Closed Polymer Arm Start Unit, Guest Back, Brushed Nickel Frame								
FAE2M-SG30CPAN	2055	2147	2240	2429	2614	2803	2988	3177	3552
	44" Open Polymer Arm Start Unit, Guest Back, Silver Metallic Frame								
FAE2M-SG44OPAS	1729	1816	1904	2079	2254	2429	2605	2779	3129
	44" Open Polymer Arm Start Unit, Guest Back, Brushed Nickel Frame								
FAE2M-SG44OPAN	1944	2031	2118	2294	2470	2642	2818	2994	3343
	44" Semi Closed Polymer Arm Start Unit, Guest Back, Silver Metallic Frame								
FAE2M-SG44SPAS	2161	2272	2384	2608	2830	3054	3277	3499	3948
	44" Semi Closed Polymer Arm Start Unit, Guest Back, Brushed Nickel Frame								
FAE2M-SG44SPAN	2376	2487	2597	2822	3045	3268	3491	3714	4162
	44" Closed Polymer Arm Start Unit, Guest Back, Silver Metallic Frame								
FAE2M-SG44CPAS	2173	2285	2397	2619	2844	3067	3290	3513	3960
	44" Closed Polymer Arm Start Unit, Guest Back, Brushed Nickel Frame								
FAE2M-SG44CPAN	2388	2502	2612	2835	3058	3281	3505	3728	4176

ORDERING NOTES:

Faeron Metal chairs can also be specified with a Wood Arm (WA) or a Solid Surface Arm (SA), replace "PA" in the model number with the **Arm Style** selection below and add the upcharge listed. See page 631 for color selection. Additional features and options information see page 37, option upcharges page 131.

Arm Style Option Upcharges

	\$ List
Solid Surface Arm (pair) - Gr A White	573
Solid Surface Arm (pair) - Gr A Color	598
Solid Surface Arm (pair) - Gr B	645
Solid Surface Arm (pair) - Gr C	678
Beech/Palette Wood Arm (per pair)	215

PRODUCT CODE KEY

Line	Series	Chair Type	Back Type	Size	Arm Type	Arm Style	Metal Finish
FAE	2M	S	G	21	O	PA	S
Faeron	Chair	Start Unit Multiple Seating	Guest		Open Arm	Polymer Arm	Silver Metallic
		C	P	24	S	WA	N
		Center Unit Multiple Seating	Patient		Semi Closed Arm	Wood Arm	Brushed Nickel
		E		30	C	SA	
		End Unit Multiple Seating		44	Closed Arm	Solid Surface Arm	

FAERON METAL | MULTIPLE SEATING - START, CENTER & END UNITS

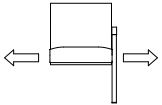
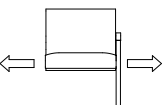
DESCRIPTION/MODEL	COM		COL			FABRIC GRADES			LEATHER										
	1	2	3	4	5	6	7	8	9										
	21" Open Polymer Arm Center Unit, Guest Back, Silver Metallic Frame FAE2M-CG21OPAS										1064	1113	1162	1258	1355	1452	1547	1644	1837
	21" Open Polymer Arm Center Unit, Guest Back, Brushed Nickel Frame FAE2M-CG21OPAN										1171	1221	1269	1367	1462	1559	1656	1752	1945
	21" Semi Closed Polymer Arm Center Unit, Guest Back, Silver Metallic Frame FAE2M-CG21SPAS										1310	1371	1431	1552	1671	1792	1912	2033	2274
	21" Semi Closed Polymer Arm Center Unit, Guest Back, Brushed Nickel Frame FAE2M-CG21SPAN										1417	1479	1538	1660	1779	1899	2019	2140	2383
	21" Closed Polymer Arm Center Unit, Guest Back, Silver Metallic Frame FAE2M-CG21CPAS										1323	1383	1443	1565	1686	1804	1926	2045	2287
	21" Closed Polymer Arm Center Unit, Guest Back, Brushed Nickel Frame FAE2M-CG21CPAN										1431	1491	1552	1671	1793	1912	2033	2154	2396
	24" Open Polymer Arm Center Unit, Guest Back, Silver Metallic Frame FAE2M-CG24OPAS										1152	1199	1247	1346	1440	1538	1634	1731	1924
	24" Open Polymer Arm Center Unit, Guest Back, Brushed Nickel Frame FAE2M-CG24OPAN										1260	1307	1356	1453	1548	1645	1743	1839	2032
	24" Semi Closed Polymer Arm Center Unit, Guest Back, Silver Metallic Frame FAE2M-CG24SPAS										1396	1458	1517	1639	1758	1880	2001	2121	2361
	24" Semi Closed Polymer Arm Center Unit, Guest Back, Brushed Nickel Frame FAE2M-CG24SPAN										1505	1565	1624	1746	1866	1987	2108	2229	2470
	24" Closed Polymer Arm Center Unit, Guest Back, Silver Metallic Frame FAE2M-CG24CPAS										1409	1468	1530	1651	1772	1893	2013	2134	2374
	24" Closed Polymer Arm Center Unit, Guest Back, Brushed Nickel Frame FAE2M-CG24CPAN										1517	1579	1639	1758	1880	2001	2121	2241	2482

ORDERING NOTES:

Faeron Metal chairs can also be specified with a Wood Arm (WA) or a Solid Surface Arm (SA), replace "PA" in the model number with the **Arm Style** selection below and add the upcharge listed. See page 631 for color selection. Additional features and options information see page 37, option upcharges page 131.

Arm Style Option Upcharges

\$ List

Solid Surface Arm (each) - Gr A White	287
Solid Surface Arm (each) - Gr A Color	299
Solid Surface Arm (each) - Gr B	321
Solid Surface Arm (each) - Gr C	339
Beech/Palette Wood Arm (each)	108

PRODUCT CODE KEY

Line	Series	Chair Type	Back Type	Size	Arm Type	Arm Style	Metal Finish
FAE Faeron	2M Chair	S Start Unit Multiple Seating	G Guest	21	O Open Arm	PA Polymer Arm	S Silver Metallic
		C Center Unit Multiple Seating	P Patient	24	S Semi Closed Arm	WA Wood Arm	N Brushed Nickel
		E End Unit Multiple Seating		30	C Closed Arm	SA Solid Surface Arm	
				44			

FAERON METAL | MULTIPLE SEATING - START, CENTER & END UNITS

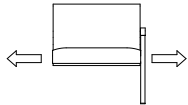
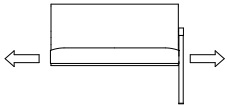
DESCRIPTION/MODEL	COM		COL	FABRIC GRADES			LEATHER		
	1	2	3	4	5	6	7	8	9
	30" Open Polymer Arm Center Unit, Guest Back, Silver Metallic Frame								
	FAE2M-CG30OPAS								
	1332	1402	1471	1611	1748	1886	2028	2166	2443
	30" Open Polymer Arm Center Unit, Guest Back, Brushed Nickel Frame								
	FAE2M-CG30OPAN								
	1439	1509	1580	1717	1856	1995	2134	2273	2551
30" Semi Closed Polymer Arm Center Unit, Guest Back, Silver Metallic Frame									
FAE2M-CG30SPAS									
1578	1660	1741	1904	2065	2229	2391	2554	2881	
30" Semi Closed Polymer Arm Center Unit, Guest Back, Brushed Nickel Frame									
FAE2M-CG30SPAN									
1685	1767	1848	2011	2173	2337	2500	2661	2988	
30" Closed Polymer Arm Center Unit, Guest Back, Silver Metallic Frame									
FAE2M-CG30CPAS									
1589	1671	1753	1915	2080	2241	2405	2567	2894	
30" Closed Polymer Arm Center Unit, Guest Back, Brushed Nickel Frame									
FAE2M-CG30CPAN									
1697	1779	1861	2024	2188	2348	2511	2674	3003	
	44" Open Polymer Arm Center Unit, Guest Back, Silver Metallic Frame								
	FAE2M-CG44OPAS								
	1667	1755	1842	2017	2192	2368	2542	2717	3068
	44" Open Polymer Arm Center Unit, Guest Back, Brushed Nickel Frame								
	FAE2M-CG44OPAN								
	1774	1862	1951	2124	2299	2476	2650	2824	3175
44" Semi Closed Polymer Arm Center Unit, Guest Back, Silver Metallic Frame									
FAE2M-CG44SPAS									
1912	2011	2110	2310	2509	2709	2907	3106	3505	
44" Semi Closed Polymer Arm Center Unit, Guest Back, Brushed Nickel Frame									
FAE2M-CG44SPAN									
2019	2118	2218	2418	2616	2816	3014	3215	3612	
44" Closed Polymer Arm Center Unit, Guest Back, Silver Metallic Frame									
FAE2M-CG44CPAS									
1926	2024	2123	2323	2523	2720	2921	3119	3517	
44" Closed Polymer Arm Center Unit, Guest Back, Brushed Nickel Frame									
FAE2M-CG44CPAN									
2033	2132	2232	2431	2631	2829	3029	3227	3626	

ORDERING NOTES:

Faeron Metal chairs can also be specified with a Wood Arm (WA) or a Solid Surface Arm (SA), replace "PA" in the model number with the **Arm Style** selection below and add the upcharge listed. See page 631 for color selection. Additional features and options information see page 37, option upcharges page 131.

Arm Style Option Upcharges

\$ List

Solid Surface Arm (each) - Gr A White	287
Solid Surface Arm (each) - Gr A Color	299
Solid Surface Arm (each) - Gr B	321
Solid Surface Arm (each) - Gr C	339
Beech/Palette Wood Arm (each)	108

PRODUCT CODE KEY

Line	Series	Chair Type	Back Type	Size	Arm Type	Arm Style	Metal Finish
FAE	2M	S	G	21	O	PA	S
Faeron	Chair	Start Unit Multiple Seating	Guest		Open Arm	Polymer Arm	Silver Metallic
		C	P	24	S	WA	N
		Center Unit Multiple Seating	Patient		Semi Closed Arm	Wood Arm	Brushed Nickel
		E		30	C	SA	
		End Unit Multiple Seating		44	Closed Arm	Solid Surface Arm	

FAERON METAL | MULTIPLE SEATING - START, CENTER & END UNITS

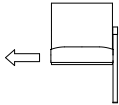
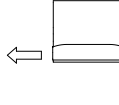
DESCRIPTION/MODEL	COM		COL		FABRIC GRADES			LEATHER	
	1	2	3	4	5	6	7	8	9
 End 21" Open Polymer Arm End Unit, Guest Back, Silver Metallic Frame FAE2M-EG21OPAS	1064	1113	1162	1258	1355	1452	1547	1644	1837
	1171	1221	1269	1367	1462	1559	1656	1752	1945
	1310	1371	1431	1552	1671	1792	1912	2033	2274
	1417	1479	1538	1660	1779	1899	2019	2140	2383
	1323	1383	1443	1565	1686	1804	1926	2045	2287
	1431	1491	1552	1671	1793	1912	2033	2154	2396
 24" Open Polymer Arm End Unit, Guest Back, Silver Metallic Frame FAE2M-EG24OPAS	1152	1199	1247	1346	1440	1538	1634	1731	1924
	1260	1307	1356	1453	1548	1645	1743	1839	2032
	1396	1458	1517	1639	1758	1880	2001	2121	2361
	1505	1565	1624	1746	1866	1987	2108	2229	2470
	1409	1468	1530	1651	1772	1893	2013	2134	2374
	1517	1579	1639	1758	1880	2001	2121	2241	2482

ORDERING NOTES:

Faeron Metal chairs can also be specified with a Wood Arm (WA) or a Solid Surface Arm (SA), replace "PA" in the model number with the **Arm Style** selection below and add the upcharge listed. See page 631 for color selection. Additional features and options information see page 37, option upcharges page 131.

Arm Style Option Upcharges

\$ List

Solid Surface Arm (each) - Gr A White	287
Solid Surface Arm (each) - Gr A Color	299
Solid Surface Arm (each) - Gr B	321
Solid Surface Arm (each) - Gr C	339
Beech/Palette Wood Arm (each)	108

PRODUCT CODE KEY

Line	Series	Chair Type	Back Type	Size	Arm Type	Arm Style	Metal Finish
FAE Faeron	2M Chair	S Start Unit Multiple Seating	G Guest	21	O Open Arm	PA Polymer Arm	S Silver Metallic
		C Center Unit Multiple Seating	P Patient	24	S Semi Closed Arm	WA Wood Arm	N Brushed Nickel
		E End Unit Multiple Seating		30	C Closed Arm	SA Solid Surface Arm	
				44			

FAERON METAL | MULTIPLE SEATING - START, CENTER & END UNITS

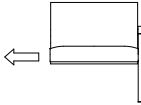
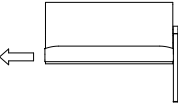
DESCRIPTION/MODEL	COM		COL	FABRIC GRADES			LEATHER		
	1	2	3	4	5	6	7	8	9
End 30" Open Polymer Arm End Unit, Guest Back, Silver Metallic Frame FAE2M-EG30OPAS	1332	1402	1471	1611	1748	1886	2028	2166	2443
 30" Open Polymer Arm End Unit, Guest Back, Brushed Nickel Frame FAE2M-EG30OPAN	1439	1509	1580	1717	1856	1995	2134	2273	2551
30" Semi Closed Polymer Arm End Unit, Guest Back, Silver Metallic Frame FAE2M-EG30SPAS	1578	1660	1741	1904	2065	2229	2391	2554	2881
30" Semi Closed Polymer Arm End Unit, Guest Back, Brushed Nickel Frame FAE2M-EG30SPAN	1685	1767	1848	2011	2173	2337	2500	2661	2988
30" Closed Polymer Arm End Unit, Guest Back, Silver Metallic Frame FAE2M-EG30CPAS	1589	1671	1753	1915	2080	2241	2405	2567	2894
30" Closed Polymer Arm End Unit, Guest Back, Brushed Nickel Frame FAE2M-EG30CPAN	1697	1779	1861	2024	2188	2348	2511	2674	3003
44" Open Polymer Arm End Unit, Guest Back, Silver Metallic Frame FAE2M-EG44OPAS	1667	1755	1842	2017	2192	2368	2542	2717	3068
 44" Open Polymer Arm End Unit, Guest Back, Brushed Nickel Frame FAE2M-EG44OPAN	1774	1862	1951	2124	2299	2476	2650	2824	3175
44" Semi Closed Polymer Arm End Unit, Guest Back, Silver Metallic Frame FAE2M-EG44SPAS	1912	2011	2110	2310	2509	2709	2907	3106	3505
44" Semi Closed Polymer Arm End Unit, Guest Back, Brushed Nickel Frame FAE2M-EG44SPAN	2019	2118	2218	2418	2616	2816	3014	3215	3612
44" Closed Polymer Arm End Unit, Guest Back, Silver Metallic Frame FAE2M-EG44CPAS	1926	2024	2123	2323	2523	2720	2921	3119	3517
44" Closed Polymer Arm End Unit, Guest Back, Brushed Nickel Frame FAE2M-EG44CPAN	2033	2132	2232	2431	2631	2829	3029	3227	3626

ORDERING NOTES:

Faeron Metal chairs can also be specified with a Wood Arm (WA) or a Solid Surface Arm (SA), replace "PA" in the model number with the **Arm Style** selection below and add the upcharge listed. See page 631 for color selection. Additional features and options information see page 37, option upcharges page 131.

Arm Style Option Upcharges

\$ List

Solid Surface Arm (each) - Gr A White	287
Solid Surface Arm (each) - Gr A Color	299
Solid Surface Arm (each) - Gr B	321
Solid Surface Arm (each) - Gr C	339
Beech/Palette Wood Arm (each)	108

PRODUCT CODE KEY

Line	Series	Chair Type	Back Type	Size	Arm Type	Arm Style	Metal Finish
FAE	2M	S	G	21	O	PA	S
Faeron	Chair	Start Unit Multiple Seating	Guest		Open Arm	Polymer Arm	Silver Metallic
		C	P	24	S	WA	N
		Center Unit Multiple Seating	Patient		Semi Closed Arm	Wood Arm	Brushed Nickel
		E		30	C	SA	
		End Unit Multiple Seating		44	Closed Arm	Solid Surface Arm	

FAERON METAL | MULTIPLE SEATING - FREESPAN UNITS

DIMENSIONS & COM REQUIREMENTS

UNIT WITH NO CENTER ARM

	Overall Width	Overall Depth	Overall Height	Seat Height	Height of Arms from Floor	Width Between Arms	Seat Depth	Shipping Weight	Cube	COM Seat & Back Yardage	COM Fabric Seat Yardage	COM Fabric Back Yardage	COM Fabric Closed Arm Panel Yardage
PCFG21X2A	46.5	26.3	34.5	19	25.0	43.0	19.5	86	28	3.0	1.5	2.1	0.96
PCFP21X2A	46.5	26.3	45.0	19	25.0	43.0	19.5	96	37	3.8	1.5	3.0	0.96
PCFG21X3A	68.0	26.3	34.5	19	25.0	64.8	19.5	117	40	4.6	2.4	3.5	0.96
PCFP21X3A	68.0	26.3	45.0	19	25.0	64.8	19.5	132	54	5.8	2.4	5.0	0.96
PCFG24X2A	52.5	26.3	34.5	19	25.0	49.0	19.5	93	30	3.0	1.5	2.1	0.96
PCFP24X2A	52.5	26.3	45.0	19	25.0	49.0	19.5	103	42	3.8	1.5	3.0	0.96
PCFG24X3A	77.0	26.3	34.5	19	25.0	73.8	19.5	129	45	4.6	2.4	3.5	0.96
PCFP24X3A	77.0	26.3	45.0	19	25.0	73.8	19.5	144	61	5.8	2.4	5.0	0.96

UNIT WITH CENTER ARM

	Overall Width	Overall Depth	Overall Height	Seat Height	Height of Arms from Floor	Width Between Arms	Seat Depth	Shipping Weight	Cube	COM Seat & Back Yardage	COM Fabric Seat Yardage	COM Fabric Back Yardage
PCFG21X2B	48.3	26.3	34.5	19	25.0	21.5	19.5	95	28	3.0	1.5	2.1
PCFP21X2B	48.3	26.3	45.0	19	25.0	21.5	19.5	105	38	3.8	1.5	3.0
PCFG21X3B	71.5	26.3	34.5	19	25.0	21.5	19.5	135	40	4.6	2.4	3.5
PCFP21X3B	71.5	26.3	45.0	19	25.0	21.5	19.5	150	56	5.8	2.4	5.0
PCFG24X2B	54.3	26.3	34.5	19	25.0	24.5	19.5	102	30	3.0	1.5	2.1
PCFP24X2B	54.3	26.3	45.0	19	25.0	24.5	19.5	112	43	3.8	1.5	3.0
PCFG24X3B	80.5	26.3	34.5	19	25.0	24.5	19.5	147	45	4.6	2.4	3.5
PCFP24X3B	80.5	26.3	45.0	19	25.0	24.5	19.5	162	63	5.8	2.4	5.0

UNIT WITH CENTER ARM (CONTINUED), GUEST AND PATIENT BACKS

Unit With Center Arm (Continued)	COM Fabric Closed Arm Panels (2 Arms)	COM Fabric Closed Arm Panels (3 Arms)	COM Fabric Closed Arm Panels (4 Arms)
PCF21X2B	0.96	1.44	1.92
PCF21X3B	0.96	1.44	1.92
PCF24X2B	0.96	1.44	1.92
PCF24X3B	0.96	1.44	1.92

Note: Some vinyls, leathers & upholsteries are not suitable for application on Faeron Metal seating.

The approval process is as follows:

1. A sample of the COM must be provided to Krug Customer Service prior to or at the time of order.
2. The sample will be reviewed and the customer advised if the fabric is unsuitable.
3. The COM fabric or leather will be inspected when received at the factory, to identify any further concerns with its suitability.

ORDERING NOTES: A drawing showing the configuration of the multiple seating and tables is required with each purchase order.

WEIGHT CAPACITIES

Faeron Metal weight capacities are as follows:

Guest & Patient Chairs (21" & 24") - 500 lbs





Faeron Option Upcharges	\$ List	\$ List
CAL 133 & Moisture Barrier (per yard)	64	Solid Surface Arm (pair) - Gr A White 573
Ganging Bracket	58	Solid Surface Arm (pair) - Gr A Color 598
Kinetic Back (not available for Plus)	120	Solid Surface Arm (pair) - Gr B 645
21" & 24" Under-seat Splashguard	58	Solid Surface Arm (pair) - Gr C 678
Removeable Seat Cover (per seat)	90	
Removable Back Cover (per back)	58	See page 631 for color selection.
Combination Upholstery - dual fabrics (per chair)	33	
Combination Upholstery - Three fabrics (per chair)	64	
Beech/Palette Wood Arm (per pair)	215	
Non-Marring Glide	16	

Additional features and options information see page 37.

Patient backs are available on multiple units, please change the model number FAE2-PCG to FAE2-PCP, and add the following upcharges per back:

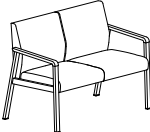
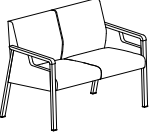
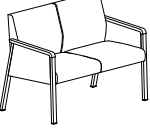
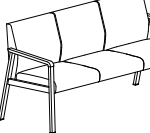
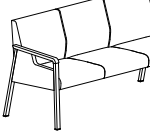
	Grade 1	Grade 2	Grade 3	Grade 4	Grade 5	Grade 6	Grade 7	Grade 8	Grade 9
21" Chairs	63	74	90	114	138	164	189	215	265
24" Chairs	68	81	94	119	144	170	195	220	271

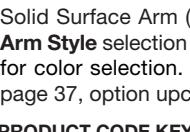
FAERON METAL | MULTIPLE SEATING - FREESPAN UNITS WITHOUT CENTER ARMS

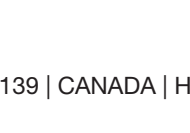
DESCRIPTION/MODEL	COM		COL		FABRIC GRADES			LEATHER	
	1	2	3	4	5	6	7	8	9
	2 Seat - 21" Open Polymer Arm Pre-configured Unit, Guest Backs, Silver Metallic Frame								
	FAE2M-PCFG21X2AOPAS	1869	1966	2062	2255	2448	2641	2835	3029
	2 Seat - 21" Open Polymer Arm Pre-configured Unit, Guest Backs, Brushed Nickel Frame								
	AE2M-PCFG21X2AOPAN	2085	2182	2278	2471	2663	2858	3052	3244
	2 Seat - 21" Semi Closed Polymer Arm Pre-configured Unit, Guest Backs, Silver Metallic Frame								
	FAE2M-PCFG21X2ASPAS	2301	2421	2542	2785	3027	3267	3509	3750
	2 Seat - 21" Semi Closed Polymer Arm Pre-configured Unit, Guest Backs, Brushed Nickel Frame								
	FAE2M-PCFG21X2ASPAN	2516	2637	2759	2999	3241	3483	3723	3965
	2 Seat - 21" Closed Polymer Arm Pre-configured Unit, Guest Backs, Silver Metallic Frame								
	FAE2M-PCFG21X2ACPAS	2315	2434	2555	2797	3038	3280	3521	3763
	2 Seat - 21" Closed Polymer Arm Pre-configured Unit, Guest Backs, Brushed Nickel Frame								
	FAE2M-PCFG21X2ACPAN	2530	2650	2770	3012	3253	3495	3738	3979
	3 Seat - 21" Open Polymer Arm Pre-configured Unit, Guest Backs, Silver Metallic Frame								
	FAE2M-PCFG21X3AOPAS	2568	2714	2858	3146	3437	3728	4016	4308
	3 Seat - 21" Open Polymer Arm Pre-configured Unit, Guest Backs, Brushed Nickel Frame								
	FAE2M-PCFG21X3AOPAN	2785	2928	3073	3364	3654	3943	4233	4522
	3 Seat - 21" Semi Closed Polymer Arm Pre-configured Unit, Guest Backs, Silver Metallic Frame								
	FAE2M-PCFG21X3ASPAS	3001	3169	3339	3678	4014	4353	4690	5030
	3 Seat - 21" Semi Closed Polymer Arm Pre-configured Unit, Guest Backs, Brushed Nickel Frame								
	FAE2M-PCFG21X3ASPAN	3216	3385	3554	3892	4230	4567	4905	5243
	3 Seat - 21" Closed Polymer Arm Pre-configured Unit, Guest Backs, Silver Metallic Frame								
	FAE2M-PCFG21X3ACPAS	3013	3184	3352	3690	4027	4366	4705	5042
	3 Seat - 21" Closed Polymer Arm Pre-configured Unit, Guest Backs, Brushed Nickel Frame								
	FAE2M-PCFG21X3ACPAN	3229	3398	3565	3906	4243	4581	4919	5258

ORDERING NOTES:

Faeron Metal chairs can also be specified with a Wood Arm (WA) or a Solid Surface Arm (SA), replace "PA" in the model number with the **Arm Style** selection below and add the upcharge listed. See page 631 for color selection. Additional features and options information see page 37, option upcharges page 138.



Arm Style Option Upcharges

	\$ List
Solid Surface Arm (pair) - Gr A White	573
Solid Surface Arm (pair) - Gr A Color	598
Solid Surface Arm (pair) - Gr B	645
Solid Surface Arm (pair) - Gr C	678
Beech/Palette Wood Arm (per pair)	215

PRODUCT CODE KEY

Line	Series	Chair Type	Back Type	Size	Unit Style	Arm Type	Arm Style	Metal Finish
FAE	2M	PCF	G	21X2	A	O	PA	S
Faeron	Chair	Pre-Configured Freespan Multiple Unit	Guest		Unit with no Center Arm	Open Arm	Polymer Arm	Silver Metallic
			P	21X3	B	S	WA	N
			Patient		Unit with Center Arm	Semi Closed Arm	Wood Arm	Brushed Nickel
				24X2		C	SA	
						Closed Arm	Solid Surface Arm	
				24X3				

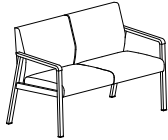
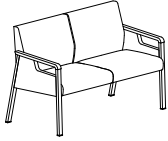
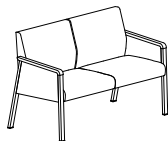
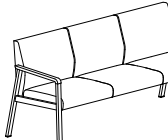
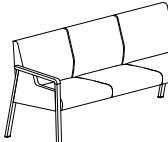
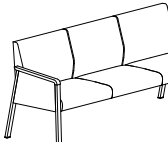
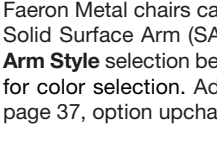
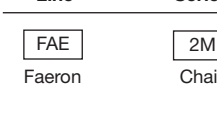
FAERON METAL | MULTIPLE SEATING - FREESPAN UNITS WITHOUT CENTER ARMS

DESCRIPTION/MODEL	COM		COL		FABRIC GRADES			LEATHER	
	1	2	3	4	5	6	7	8	9
	2 Seat - 24" Open Polymer Arm Pre-configured Unit, Guest Backs, Silver Metallic Frame								
	FAE2M-PCFG24X2AOPAS	2034	2132	2228	2421	2614	2807	3001	3193
	2 Seat - 24" Open Polymer Arm Pre-configured Unit, Guest Backs, Brushed Nickel Frame								
	FAE2M-PCFG24X2AOPAN	2250	2346	2443	2637	2830	3024	3216	3409
	2 Seat - 24" Semi Closed Polymer Arm Pre-configured Unit, Guest Backs, Silver Metallic Frame								
	FAE2M-PCFG24X2ASPAS	2465	2587	2709	2949	3190	3432	3672	3916
	2 Seat - 24" Semi Closed Polymer Arm Pre-configured Unit, Guest Backs, Brushed Nickel Frame								
	FAE2M-PCFG24X2ASPAN	2682	2803	2923	3164	3406	3647	3890	4131
	2 Seat - 24" Closed Polymer Arm Pre-configured Unit, Guest Backs, Silver Metallic Frame								
	FAE2M-PCFG24X2ACPAS	2480	2601	2720	2963	3205	3446	3687	3930
	2 Seat - 24" Closed Polymer Arm Pre-configured Unit, Guest Backs, Brushed Nickel Frame								
	FAE2M-PCFG24X2ACPAN	2695	2816	2936	3179	3419	3662	3903	4143
	3 Seat - 24" Open Polymer Arm Pre-configured Unit, Guest Backs, Silver Metallic Frame								
	FAE2M-PCFG24X3AOPAS	2804	2949	3093	3384	3671	3962	4252	4544
	3 Seat - 24" Open Polymer Arm Pre-configured Unit, Guest Backs, Brushed Nickel Frame								
	FAE2M-PCFG24X3AOPAN	3017	3164	3310	3599	3889	4179	4468	4758
	3 Seat - 24" Semi Closed Polymer Arm Pre-configured Unit, Guest Backs, Silver Metallic Frame								
	FAE2M-PCFG24X3ASPAS	3236	3405	3575	3911	4249	4588	4927	5263
	3 Seat - 24" Semi Closed Polymer Arm Pre-configured Unit, Guest Backs, Brushed Nickel Frame								
	FAE2M-PCFG24X3ASPAN	3452	3620	3789	4128	4466	4802	5141	5479
	3 Seat - 24" Closed Polymer Arm Pre-configured Unit, Guest Backs, Silver Metallic Frame								
	FAE2M-PCFG24X3ACPAS	3248	3418	3587	3924	4264	4602	4941	5277
	3 Seat - 24" Closed Polymer Arm Pre-configured Unit, Guest Backs, Brushed Nickel Frame								
	FAE2M-PCFG24X3ACPAN	3463	3634	3803	4140	4480	4816	5155	5493

ORDERING NOTES:

Faeron Metal chairs can also be specified with a Wood Arm (WA) or a Solid Surface Arm (SA), replace "PA" in the model number with the **Arm Style** selection below and add the upcharge listed. See page 631 for color selection. Additional features and options information see page 37, option upcharges page 138.



Arm Style Option Upcharges

	\$ List
Solid Surface Arm (pair) - Gr A White	573
Solid Surface Arm (pair) - Gr A Color	598
Solid Surface Arm (pair) - Gr B	645
Solid Surface Arm (pair) - Gr C	678
Beech/Palette Wood Arm (per pair)	215

PRODUCT CODE KEY

Line	Series	Chair Type	Back Type	Size	Unit Style	Arm Type	Arm Style	Metal Finish
FAE	2M	PCF	G	21X2	A	O	PA	S
Faeron	Chair	Pre-Configured Freespan Multiple Unit	Guest		Unit with no Center Arm	Open Arm	Polymer Arm	Silver Metallic
			P	21X3	B	S	WA	N
			Patient		Unit with Center Arm	Semi Closed Arm	Wood Arm	Brushed Nickel
				24X2		C	SA	
						Closed Arm	Solid Surface Arm	
				24X3				

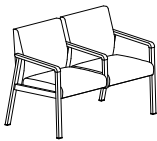
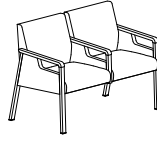
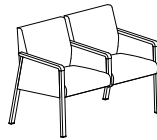
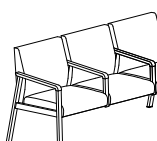
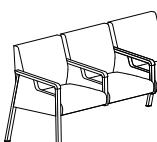
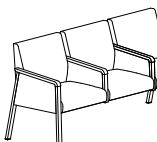
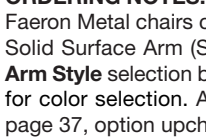
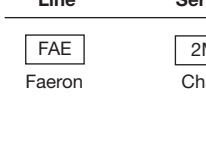
FAERON METAL | MULTIPLE SEATING - FREESPAN UNITS WITH CENTER ARMS

DESCRIPTION/MODEL	COM		COL		FABRIC GRADES			LEATHER	
	1	2	3	4	5	6	7	8	9
	2 Seat - 21" Open Polymer Arm Pre-configured Freespan Unit, Guest Backs, Silver Metallic Frame								
	FAE2M-PCFG21X2BOPAS	2394	2491	2587	2781	2973	3166	3360	3554
	2 Seat - 21" Open Polymer Arm Pre-configured Freespan Unit, Guest Backs, Brushed Nickel Frame								
	FAE2M-PCFG21X2BOPAN	2717	2815	2910	3104	3297	3490	3684	3876
	2 Seat - 21" Semi Closed Polymer Arm Pre-configured Freespan Unit, Guest Backs, Silver Metallic Frame								
	FAE2M-PCFG21X2BSPAS	3071	3205	3337	3603	3869	4133	4398	4664
	2 Seat - 21" Semi Closed Polymer Arm Pre-configured Freespan Unit, Guest Backs, Brushed Nickel Frame								
	FAE2M-PCFG21X2BSPAN	3395	3529	3661	3924	4191	4457	4721	4987
	2 Seat - 21" Closed Polymer Arm Pre-configured Freespan Unit, Guest Backs, Silver Metallic Frame								
	FAE2M-PCFG21X2BCPAS	3097	3231	3364	3628	3894	4160	4424	4690
	2 Seat - 21" Closed Polymer Arm Pre-configured Freespan Unit, Guest Backs, Brushed Nickel Frame								
	FAE2M-PCFG21X2BCPAN	3420	3554	3686	3952	4217	4483	4748	5012
	3 Seat - 21" Open Polymer Arm Pre-configured Freespan Unit, Guest Backs, Silver Metallic Frame								
	FAE2M-PCFG21X3BOPAS	3405	3552	3694	3984	4274	4564	4855	5143
	3 Seat - 21" Open Polymer Arm Pre-configured Freespan Unit, Guest Backs, Brushed Nickel Frame								
	FAE2M-PCFG21X3BOPAN	3836	3981	4127	4416	4707	4994	5285	5574
	3 Seat - 21" Semi Closed Polymer Arm Pre-configured Freespan Unit, Guest Backs, Silver Metallic Frame								
	FAE2M-PCFG21X3BSPAS	4327	4520	4712	5098	5485	5871	6258	6644
	3 Seat - 21" Semi Closed Polymer Arm Pre-configured Freespan Unit, Guest Backs, Brushed Nickel Frame								
	FAE2M-PCFG21X3BSPAN	4757	4949	5142	5529	5916	6303	6688	7073
	3 Seat - 21" Closed Polymer Arm Pre-configured Freespan Unit, Guest Backs, Silver Metallic Frame								
	FAE2M-PCFG21X3BCPAS	4366	4559	4752	5138	5525	5912	6296	6684
	3 Seat - 21" Closed Polymer Arm Pre-configured Freespan Unit, Guest Backs, Brushed Nickel Frame								
	FAE2M-PCFG21X3BCPAN	4796	4990	5183	5569	5956	6342	6729	7113

ORDERING NOTES:

Faeron Metal chairs can also be specified with a Wood Arm (WA) or a Solid Surface Arm (SA), replace "PA" in the model number with the **Arm Style** selection below and add the upcharge listed. See page 631 for color selection. Additional features and options information see page 37, option upcharges page 138.



Arm Style Option Upcharges

	\$ List
Solid Surface Arm (pair) - Gr A White	573
Solid Surface Arm (pair) - Gr A Color	598
Solid Surface Arm (pair) - Gr B	645
Solid Surface Arm (pair) - Gr C	678
Beech/Palette Wood Arm (per pair)	215

PRODUCT CODE KEY

Line	Series	Chair Type	Back Type	Size	Unit Style	Arm Type	Arm Style	Metal Finish
FAE	2M	PCF	G	21X2	A	O	PA	S
Faeron	Chair	Pre-Configured Freespan Multiple Unit	Guest		Unit with no Center Arm	Open Arm	Polymer Arm	Silver Metallic
			P	21X3	B	S	WA	N
			Patient		Unit with Center Arm	Semi Closed Arm	Wood Arm	Brushed Nickel
				24X2		C	SA	
						Closed Arm	Solid Surface Arm	
				24X3				

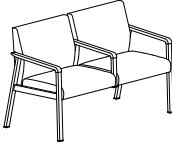
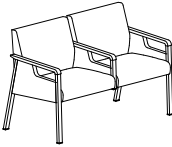
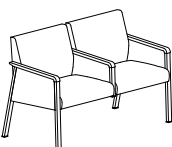
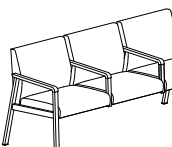
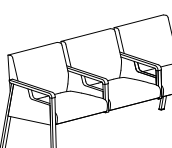
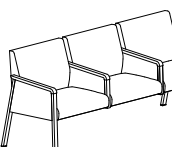
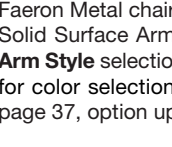
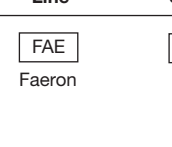
FAERON METAL | MULTIPLE SEATING - FREESPAN UNITS WITH CENTER ARMS

DESCRIPTION/MODEL	COM		COL		FABRIC GRADES			LEATHER		9
	1	2	3	4	5	6	7	8		
	2 Seat - 24" Open Polymer Arm Pre-configured Freespan Unit, Guest Backs, Silver Metallic Frame									
	FAE2M-PCFG24X2BOPAS	2562	2657	2754	2947	3140	3333	3528	3718	4107
	2 Seat - 24" Open Polymer Arm Pre-configured Freespan Unit, Guest Backs, Brushed Nickel Frame									
	FAE2M-PCFG24X2BOPAN	2883	2980	3077	3269	3462	3656	3848	4041	4428
	2 Seat - 24" Semi Closed Polymer Arm Pre-configured Freespan Unit, Guest Backs, Silver Metallic Frame									
	FAE2M-PCFG24X2BSPAS	3237	3369	3502	3768	4035	4297	4564	4831	5362
	2 Seat - 24" Semi Closed Polymer Arm Pre-configured Freespan Unit, Guest Backs, Brushed Nickel Frame									
	FAE2M-PCFG24X2BSPAN	3560	3692	3825	4090	4356	4622	4887	5154	5684
	2 Seat - 24" Closed Polymer Arm Pre-configured Freespan Unit, Guest Backs, Silver Metallic Frame									
	FAE2M-PCFG24X2BCPAS	3264	3396	3530	3795	4060	4324	4590	4857	5388
	2 Seat - 24" Closed Polymer Arm Pre-configured Freespan Unit, Guest Backs, Brushed Nickel Frame									
	FAE2M-PCFG24X2BCPAN	3586	3718	3851	4117	4382	4648	4914	5181	5710
	3 Seat - 24" Open Polymer Arm Pre-configured Freespan Unit, Guest Backs, Silver Metallic Frame									
	FAE2M-PCFG24X3BOPAS	3641	3786	3932	4219	4510	4799	5090	5380	5959
	3 Seat - 24" Open Polymer Arm Pre-configured Freespan Unit, Guest Backs, Brushed Nickel Frame									
	FAE2M-PCFG24X3BOPAN	4071	4216	4362	4652	4942	5232	5521	5810	6390
	3 Seat - 24" Semi Closed Polymer Arm Pre-configured Freespan Unit, Guest Backs, Silver Metallic Frame									
	FAE2M-PCFG24X3BSPAS	4562	4756	4948	5336	5720	6108	6494	6881	7654
	3 Seat - 24" Semi Closed Polymer Arm Pre-configured Freespan Unit, Guest Backs, Brushed Nickel Frame									
	FAE2M-PCFG24X3BSPAN	4993	5187	5380	5765	6153	6539	6924	7311	8083
	3 Seat - 24" Closed Polymer Arm Pre-configured Freespan Unit, Guest Backs, Silver Metallic Frame									
	FAE2M-PCFG24X3BCPAS	4603	4795	4988	5373	5761	6147	6534	6918	7691
	3 Seat - 24" Closed Polymer Arm Pre-configured Freespan Unit, Guest Backs, Brushed Nickel Frame									
	FAE2M-PCFG24X3BCPAN	5033	5227	5419	5806	6190	6579	6964	7348	8122

ORDERING NOTES:

Faeron Metal chairs can also be specified with a Wood Arm (WA) or a Solid Surface Arm (SA), replace "PA" in the model number with the **Arm Style** selection below and add the upcharge listed. See page 631 for color selection. Additional features and options information see page 37, option upcharges page 138.

Arm Style Option Upcharges

	\$ List
Solid Surface Arm (pair) - Gr A White	573
Solid Surface Arm (pair) - Gr A Color	598
Solid Surface Arm (pair) - Gr B	645
Solid Surface Arm (pair) - Gr C	678
Beech/Palette Wood Arm (per pair)	215

PRODUCT CODE KEY

Line	Series	Chair Type	Back Type	Size	Unit Style	Arm Type	Arm Style	Metal Finish
FAE	2M	PCF	G	21X2	A	O	PA	S
Faeron	Chair	Pre-Configured Freespan Multiple Unit	Guest		Unit with no Center Arm	Open Arm	Polymer Arm	Silver Metallic
			P	21X3	B	S	WA	N
			Patient		Unit with Center Arm	Semi Closed Arm	Wood Arm	Brushed Nickel
				24X2		C	SA	
						Closed Arm	Solid Surface Arm	
				24X3				

JORDAN | MULTIPLE SEATING INSTRUCTIONS

To aid you in the process of specifying and ordering Jordan Multiple Seating, we have compiled the following summary. It explains the three different types of Jordan Multiple Seating – (a) Pre-Configured, (b) Start, Center & End Units and (c) the Freespan Multiple Units – including the features and considerations of each type, to assist in selecting the one that best suits each application. It is a requirement for all Jordan Multiple Seating orders, a drawing or plan view layout must accompany the order, so that we can verify that the specification is correct.

When building your multiple seating layout, please note that your order should start from left to right as you are facing the configuration.

Pre-Configured Multiple Units

Pre-Configured Multiple Units are designed to be used when you have seating configurations that are 2-3 chair units in size (see picture below).

Two-Seat



Considerations if choosing to use Pre-Configured Units:

- Linking tables can be joined to either end of a Pre-Configured Multiple Unit, but not in-between
- There are no limitations to the number of Pre-Configured Multiple units that can be ganged together with the Jordan Linking Tables
- Pre-Configured Multiple Units are not available in 30" or 44" plus widths
- Pre-Configured Multiple Units are not designed to work with other multiple seating (Start, Center, End Units or Freespan Units) unless a Jordan Linking Table or linking brackets are used in-between the different types of multiple seating.
- Pre-Configured Multiple Units are built from Start, Center and End Units and therefore, can be reconfigured to singular or two-seater units. However, you may have to purchase additional components (arms, etc..) to be able to do this. See line drawings below for possible configurations that can be made from taking apart the Pre-Configured Multiple Units.

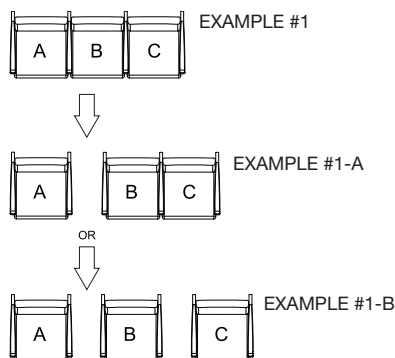

*Please note:

Example #1-A requires an additional end unit arm for chair A, and a start unit arm for chair B.

Example #1-B requires an additional end unit arm for chair A, a start and end unit arm for chair B, and a start unit arm for chair C.

Start, Center and End Multiple Seating Units

Start, Center and End Multiple Units are designed to be used when you have seating configurations that are greater than three chair units in size, and/or include 30" or 44" units (see picture below). Also, before you start to build your multiple seating layout, please note that your order should start from left to right as you are facing the chair, therefore begin the configuration with a Start Unit, then move to a Center Unit and finish with an End Unit.

Considerations if choosing to use Start, Center and End Multiple Units:

- Start, Center and End units are available in all widths (21", 24", 30" & 44")
- There are no limitations to the amount of center units that can be ganged to a start or an end unit
- Jordan Linking Tables can be joined to any Jordan Start or End unit only (this is because the units are engineered with the finished arms)



JORDAN | MULTIPLE SEATING INSTRUCTIONS

See below for sample configurations of when you would use Start, Center and End Multiple Units.

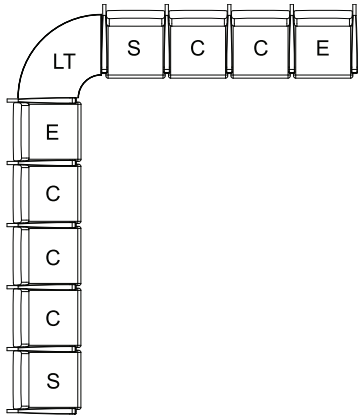

Freespan Multiple Units

Freespan Multiple Units are designed to be used when you have seating configurations that are 2-3 chair units in size and a reduced number of legs are desirable. (see picture below).



Considerations if choosing to use Freespan Multiple Units:

- Freespan Multiple Units come with a choice of a pre-configured unit with or without a center arm
- The unit with the center arm increases the overall width of the unit by 1" per arm
- Linking tables can be joined to either side of a Freespan Multiple Unit, but not in-between
- There are no limitations to the number of Freespan Multiple units that can be ganged together with the Jordan Linking Tables or linking brackets.
- Freespan Multiple Units are not available in 30" or 44" plus widths
- Freespan Multiple Units are not designed to work with other multiple seating (Start, Center, End Units or Freespan Units) unless a Jordan Linking Table or linking brackets are used in-between the different types of multiple seating.

Below illustrates possible configurations when you could use all three types of Jordan Multiple Seating together.

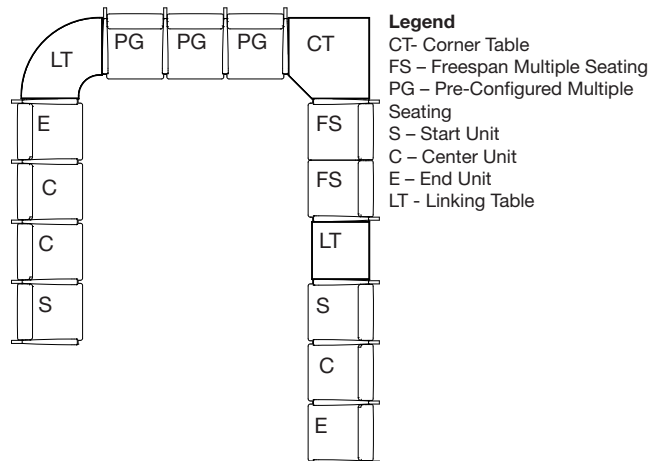

- Legend**
- CT- Corner Table
 - FS - Freespan Multiple Seating
 - PG - Pre-Configured Multiple Seating
 - S - Start Unit
 - C - Center Unit
 - E - End Unit
 - LT - Linking Table

For more information on how to specify Jordan Multiple Seating, please contact Customer Service directly at 1-888-578-5784.

JORDAN | MULTIPLE SEATING - PRECONFIGURED UNITS

DIMENSIONS & COM REQUIREMENTS

	Overall Width	Overall Depth	Overall Height	Seat Height	Height of Arms from Floor	Width Between Arms	Seat Depth	Shipping Weight	Cube	COM Seat & Back Yardage	COM Fabric Seat Yardage	COM Fabric Back Yardage	COM Fabric Closed Arm Panel Yardage
PCG21X2	47.75	27	34.25	18.5	26	20.5	19	72	28	3.2	1.8	2.8	1.35
PCP21X2	47.75	27	43.5	18.5	26	20.5	19	82	38	4.2	1.8	3.8	1.35
PCG21X3	70.5	27	34.25	18.5	26	20.5	19	103	41	4.8	2.7	4.2	1.8
PCP21X3	70.5	27	43.5	18.5	26	20.5	19	118	56	6.3	2.7	5.7	1.8
PCG24X2	53.75	27	34.25	18.5	26	23.5	19	79	31	3.8	1.8	2.8	1.35
PCP24X2	53.75	27	43.5	18.5	26	23.5	19	89	43	4.8	1.8	3.8	1.35
PCG24X3	79.5	27	34.25	18.5	26	23.5	19	115	46	5.7	2.7	4.2	1.8
PCP24X3	79.5	27	43.5	18.5	26	23.5	19	130	63	7.2	2.7	5.7	1.8

PRE-CONFIGURED MULTIPLE UNITS	SEAT	GUEST BACK	PATIENT BACK	CLOSED ARM PANEL
PC21x2	1.8	2.8	3.8	1.35
PC21x3	2.7	4.2	5.7	1.8
PC24X2	1.8	2.8	3.8	1.35
PC24X3	2.7	4.2	5.7	1.8

ORDERING NOTES: A drawing showing the configuration of the multiple seating and tables is required with each purchase order.

WEIGHT CAPACITIES

Jordan Pre-configured weight capacities are 500 lbs per seat

PRE-CONFIGURED MULTIPLE UNITS

Two-Seat



Three-Seat



Jordan Option Upcharges







	\$ List	\$ List
CAL 133 & Moisture Barrier (per yard)	64	Solid Surface Arm Cap (per arm) - Gr A White 238
Kinetic Back option	120	Solid Surface Arm Cap (per arm) - Gr A Color 240
Removable Seat Cover (per seat)	90	Solid Surface Arm Cap (per arm) - Gr B 250
21" & 24" Removeable Guest Back Covers (per back)	58	Solid Surface Arm Cap (per arm) - Gr C 264
21" & 24" Removeable Patient Back Covers (per back)	90	21" & 24" Cleanable Under-seat Splashguard 40
Combination Upholstery - dual fabrics (per chair)	33	Non-Marring Glide 37
Combination Upholstery - Three fabrics (per chair)	64	

Additional features and options information see page 43.

Patient backs are available on pre-configured units, please change the model number JOR2-PCG to JOR2-PCP and add the following upcharges per back:

Fabric Grades	(COM) 1	2	(COL) 3	4	5	6	7	8	9
21" Chair	269	318	365	477	569	633	711	791	870
24" Chair	284	340	384	509	591	679	760	853	941

JORDAN | MULTIPLE SEATING - PRECONFIGURED UNITS

DESCRIPTION/MODEL	Species	COM		COL	FABRIC GRADES			LEATHER			
		1	2	3	4	5	6	7	8	9	
	2 Seat - 21" Open Arm Pre-configured Unit, Guest Backs										
	JOR2-PCG21X2OPS	Beech	2130	2281	2434	2665	2894	3144	3395	3682	4198
	JOR2-PCG21X2OPS	Maple	2273	2427	2580	2808	3058	3316	3565	3854	4392
	21" Open Arm Urethane Cap Pre-configured Unit, Guest Backs										
	2 Seat - 21" Closed Arm Pre-configured Unit, Guest Backs										
	JOR2-PCG21X2CLS	Beech	2312	2464	2618	2848	3078	3327	3577	3865	4381
	JOR2-PCG21X2CLS	Maple	2457	2609	2763	2992	3242	3499	3746	4037	4573
	2 Seat - 21" Closed Arm Urethane Cap Pre-configured Unit, Guest Backs										
	2 Seat - 21" Closed Arm Urethane Cap Pre-configured Unit, Guest Backs										
	JOR2-PCG21X2CLU	Beech	2520	2672	2827	3057	3287	3536	3786	4072	4591
	JOR2-PCG21X2CLU	Maple	2665	2819	2971	3203	3453	3709	3959	4245	4782
	3 Seat - 21" Open Arm Pre-configured Unit, Guest Backs										
	3 Seat - 21" Open Arm Pre-configured Unit, Guest Backs										
	JOR2-PCG21X3OPS	Beech	3163	3395	3624	3960	4322	4678	5071	5510	6289
	JOR2-PCG21X3OPS	Maple	3384	3624	3854	4198	4581	4995	5407	5799	6575
	3 Seat - 21" Open Arm Urethane Cap Pre-configured Unit, Guest Backs										
	3 Seat - 21" Open Arm Urethane Cap Pre-configured Unit, Guest Backs										
	JOR2-PCG21X3OPU	Beech	3441	3671	3902	4238	4603	4957	5351	5792	6567
	JOR2-PCG21X3OPU	Maple	3663	3902	4132	4477	4861	5274	5685	6079	6854
	3 Seat - 21" Closed Arm Pre-configured Unit, Guest Backs										
	3 Seat - 21" Closed Arm Pre-configured Unit, Guest Backs										
	JOR2-PCG21X3CLS	Beech	3408	3638	3867	4205	4567	4921	5317	5757	6532
	JOR2-PCG21X3CLS	Maple	3628	3867	4098	4442	4826	5240	5649	6044	6819
	21" Closed Arm Urethane Cap Pre-configured Unit, Guest Backs										
	21" Closed Arm Urethane Cap Pre-configured Unit, Guest Backs										
	JOR2-PCG21X3CLU	Beech	3686	3917	4146	4484	4845	5201	5595	6034	6813
	JOR2-PCG21X3CLU	Maple	3907	4146	4377	4721	5106	5518	5929	6322	7095

ORDERING NOTES: A drawing showing the configuration of the multiple seating and tables is required with each purchase order.

Jordan Option Upcharges	\$ List	\$ List
CAL 133 & Moisture Barrier (per yard)	64	Solid Surface Arm Cap (per arm) - Gr A White
Kinetic Back option	120	Solid Surface Arm Cap (per arm) - Gr A Color
Removable Seat Cover (per seat)	90	Solid Surface Arm Cap (per arm) - Gr B
21" & 24" Removeable Guest Back Covers (per back)	58	Solid Surface Arm Cap (per arm) - Gr C
21" & 24" Removeable Patient Back Covers (per back)	90	21" & 24" Cleanable Under-seat Splashguard
Combination Upholstery - dual fabrics (per chair)	33	Non-Marring Glide
Combination Upholstery - Three fabrics (per chair)	64	

Additional features and options information see page 43.





Patient backs are available on pre-configured units, please change the model number JOR2-PCG to JOR2-PCP and add the following upcharges per back:

Fabric Grades	(COM) 1	2	(COL) 3	4	5	6	7	8	9
21" Chair	269	318	365	477	569	633	711	791	870
24" Chair	284	340	384	509	591	679	760	853	941

PRODUCT CODE KEY

Line	Series	Chair Type	Back Type	Size	Arm Type
JOR	2	PC	G	21X2	OPS
Jordan	Chair	Pre-configured Multiple Unit	Guest Back		Open Arm
			P	21X3	OPU
			Patient Back		Open Arm Urethane Arm Cap
				24X2	CLS
					Closed Arm
				24X3	CLU
					Closed Arm Urethane Arm Cap

JORDAN | MULTIPLE SEATING - PRECONFIGURED UNITS

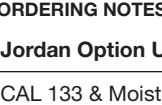
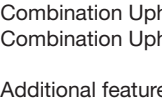
DESCRIPTION/MODEL	Species	COM		COL	FABRIC GRADES				LEATHER		
		1	2	3	4	5	6	7	8	9	
	2 Seat - 24" Open Arm Pre-configured Unit, Guest Backs										
	JOR2-PCG24X2OPS	Beech	2206	2359	2513	2742	2971	3241	3470	3759	4274
	JOR2-PCG24X2OPS	Maple	2369	2522	2673	2906	3158	3412	3662	3950	4486
	24" Open Arm Urethane Cap Pre-configured Unit, Guest Backs										
	JOR2-PCG24X2OPU	Beech	2415	2567	2719	2952	3181	3452	3680	3965	4485
	JOR2-PCG24X2OPU	Maple	2579	2734	2884	3114	3364	3622	3871	4160	4693
	2 Seat - 24" Closed Arm Pre-configured Unit, Guest Backs										
	JOR2-PCG24X2CLS	Beech	2387	2541	2695	2926	3158	3424	3654	3940	4458
	JOR2-PCG24X2CLS	Maple	2552	2705	2858	3090	3339	3595	3845	4132	4669
	24" Closed Arm Urethane Cap Pre-configured Unit, Guest Backs										
	JOR2-PCG24X2CLU	Beech	2596	2748	2904	3134	3364	3634	3862	4149	4667
	JOR2-PCG24X2CLU	Maple	2761	2913	3068	3297	3546	3806	4055	4340	4878
	3 Seat - 24" Open Arm Pre-configured Unit, Guest Backs										
	JOR2-PCG24X3OPS	Beech	3279	3508	3739	4074	4439	4793	5187	5629	6403
	JOR2-PCG24X3OPS	Maple	3519	3759	3988	4334	4715	5131	5539	5954	6710
	24" Open Arm Urethane Cap Pre-configured Unit, Guest Backs										
	JOR2-PCG24X3OPU	Beech	3559	3788	4016	4353	4718	5071	5465	5905	6683
	JOR2-PCG24X3OPU	Maple	3796	4037	4267	4611	4995	5408	5819	6232	6987
	3 Seat - 24" Closed Arm Pre-configured Unit, Guest Backs										
	JOR2-PCG24X3CLS	Beech	3521	3753	3982	4318	4683	5036	5429	5870	6647
	JOR2-PCG24X3CLS	Maple	3762	4001	4233	4576	4961	5370	5784	6196	6954
	24" Closed Arm Urethane Cap Pre-configured Unit, Guest Backs										
	JOR2-PCG24X3CLU	Beech	3803	4030	4261	4596	4962	5317	5710	6149	6925
	JOR2-PCG24X3CLU	Maple	4041	4282	4509	4857	5240	5650	6063	6475	7233

ORDERING NOTES: A drawing showing the configuration of the multiple seating and tables is required with each purchase order.

Jordan Option Upcharges	\$ List	\$ List
CAL 133 & Moisture Barrier (per yard)	64	Solid Surface Arm Cap (per arm) - Gr A White 238
Kinetic Back option	120	Solid Surface Arm Cap (per arm) - Gr A Color 240
Removable Seat Cover (per seat)	90	Solid Surface Arm Cap (per arm) - Gr B 250
21" & 24" Removeable Guest Back Covers (per back)	58	Solid Surface Arm Cap (per arm) - Gr C 264
21" & 24" Removeable Patient Back Covers (per back)	90	21" & 24" Cleanable Under-seat Splashguard 40
Combination Upholstery - dual fabrics (per chair)	33	Non-Marring Glide 37
Combination Upholstery - Three fabrics (per chair)	64	

Additional features and options information see page 43.

Patient backs are available on pre-configured units, please change the model number JOR2-PCG to JOR2-PCP and add the following upcharges per back:

Fabric Grades	(COM) 1	2	(COL) 3	4	5	6	7	8	9
21" Chair	269	318	365	477	569	633	711	791	870
24" Chair	284	340	384	509	591	679	760	853	941

PRODUCT CODE KEY

Line	Series	Chair Type	Back Type	Size	Arm Type
JOR	2	PC	G	21X2	OPS
Jordan	Chair	Pre-configured Multiple Unit	Guest Back		Open Arm
			P	21X3	OPU
			Patient Back		Open Arm Urethane Arm Cap
				24X2	CLS
					Closed Arm
				24X3	CLU
					Closed Arm Urethane Arm Cap

JORDAN | MULTIPLE SEATING - START, CENTER & END UNITS

DIMENSIONS & COM REQUIREMENTS

JORDAN MULTIPLE START UNITS

	Overall Width	Overall Depth	Overall Height	Seat Height	Height of Arms from Floor	Width Between Arms	Seat Depth	Shipping Weight	Cube	COM Seat & Back Yardage	COM Fabric Seat Yardage	COM Fabric Back Yardage	COM Fabric Closed Arm Panel (1 Arm) Yardage	COM Fabric Closed Arm Panel (2 Arms) Yardage
SG21	25	27	34.25	18.5	26	20.5	19	42	14	1.6	0.9	1.4	0.45	0.9
SP21	25	27	43.5	18.5	26	20.5	19	47	17	2.2	0.9	1.9	0.45	0.9
SG24	28	27	34.25	18.5	26	23.5	19	46	19	1.6	0.9	1.4	0.45	0.9
SP24	28	27	43.5	18.5	26	23.5	19	51	22	2.2	0.9	1.9	0.45	0.9
SG30	34	27	34.25	18.5	26	29.5	19	52	20	2.7	0.9	1.6	0.45	0.9
SP30	34	27	43.5	18.5	26	29.5	19	59	28	3.1	0.9	2.21	0.45	0.9
SG44	48	27	34.25	18.5	26	43.5	19	69	28	2.7	0.9	1.6	0.45	0.9

JORDAN MULTIPLE CENTER UNITS

	Overall Width	Overall Depth	Overall Height	Seat Height	Height of Arms from Floor	Width Between Arms	Seat Depth	Shipping Weight	Cube	COM Seat & Back Yardage	COM Fabric Seat Yardage	COM Fabric Back Yardage	COM Fabric Closed Arm Panel Yardage
CG21	22.75	27	34.25	18.5	26	20.5	19	40	14	1.6	0.9	1.4	0.45
CP21	22.75	27	43.5	18.5	26	20.6	19	42	17	2.2	0.9	1.9	0.45
CG24	25.75	27	34.25	18.5	26	23.5	19	45	19	1.6	0.9	1.4	0.45
CP24	25.75	27	43.5	18.5	26	23.5	19	46	22	2.2	0.9	1.9	0.45
CG30	31.75	27	34.25	18.5	26	29.5	19	50	20	2.7	0.9	1.6	0.45
CP30	31.75	27	43.5	18.5	26	29.5	19	54	28	3.1	0.9	2.21	0.45
CG44	45.75	27	34.25	18.5	26	43.5	19	69	28	2.7	0.9	1.6	0.45

JORDAN MULTIPLE END UNITS

	Overall Width	Overall Depth	Overall Height	Seat Height	Height of Arms from Floor	Width Between Arms	Seat Depth	Shipping Weight	Cube	COM Seat & Back Yardage	COM Fabric Seat Yardage	COM Fabric Back Yardage	COM Fabric Closed Arm Panel Yardage
EG21	22.75	27	34.25	18.5	26	20.5	19	40	14	1.6	0.9	1.4	0.45
EP21	22.75	27	43.5	18.5	26	20.5	19	42	17	2.2	0.9	1.9	0.45
EG24	25.75	27	34.25	18.5	26	23.5	19	45	19	1.6	0.9	1.4	0.45
EP24	25.75	27	43.5	18.5	26	23.5	19	46	22	2.2	0.9	1.9	0.45
EG30	31.75	27	34.25	18.5	26	29.5	19	50	20	2.7	0.9	1.6	0.45
EP30	31.75	27	43.5	18.5	26	29.5	19	54	28	3.1	0.9	2.21	0.45
EG44	45.75	27	34.25	18.5	26	43.5	19	69	28	2.7	0.9	1.6	0.45

ORDERING NOTES: A drawing showing the configuration of the multiple seating and tables is required with each purchase order.

WEIGHT CAPACITIES

Jordan weight capacities are as follows:
Multiple Seating & Pre-configured - 500 lbs per seat

START, CENTER, & END MULTIPLE UNITS

Start Unit Center Unit End Unit



Jordan Guest Option Upcharges

	\$ List
CAL 133 & Moisture Barrier (per yard)	64
Kinetic Back option (not available for 30" & 44")	120
Removable Seat Cover (per seat)	90
21" & 24" - Removeable Guest Back Covers (per back)	58
30" & 44" - Removeable Guest Back Covers (per back)	90
21" & 24" - Removeable Patient Back Covers (per back)	90
30" - Removeable Patient Back Covers (per back)	142
Combination Upholstery - dual fabrics (per chair)	33
Combination Upholstery - Three fabrics (per chair)	64







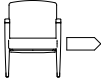
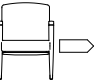
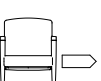

	\$ List
21" & 24" Cleanable Under-seat Splashguard	40
30" Cleanable Under-seat Splashguard	48
44" Cleanable Under-seat Splashguard	64
Solid Surface Arm Cap (per arm) - Gr A White	238
Solid Surface Arm Cap (per arm) - Gr A Color	240
Solid Surface Arm Cap (per arm) - Gr B	250
Solid Surface Arm Cap (per arm) - Gr C	264
Non-Marring Glide	37

Additional features and options information see page 43.

Patient backs are available on pre-configured units, please change the model number JOR2-PCG to JOR2-PCP and add the following upcharges per back:

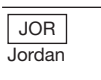
Fabric Grades	(COM) 1	2	(COL) 3	4	5	6	7	8	9
21" Chair	269	318	365	477	569	633	711	791	870
24" Chair	284	340	384	509	591	679	760	853	941

JORDAN | MULTIPLE SEATING - START, CENTER & END UNITS



DESCRIPTION/MODEL	Species	COM		COL			FABRIC GRADES			LEATHER	
		1	2	3	4	5	6	7	8	9	
Start	21" Open Arm Start Unit, Guest Back										
	JOR2-SG21OPS Beech	1170	1257	1342	1466	1603	1736	1880	2042	2329	
	JOR2-SG21OPS Maple	1257	1342	1430	1555	1698	1853	2004	2146	2434	
	21" Open Arm Urethane Cap Start Unit, Guest Back										
	JOR2-SG21OPU Beech	1310	1396	1482	1609	1743	1878	2019	2182	2470	
	JOR2-SG21OPU Maple	1396	1482	1568	1693	1837	1990	2144	2285	2574	
	21" Closed Arm Start Unit, Guest Back										
	JOR2-SG21CLS Beech	1292	1378	1464	1589	1724	1857	2002	2165	2452	
	JOR2-SG21CLS Maple	1378	1464	1554	1676	1819	1974	2129	2269	2557	
	21" Closed Arm Urethane Cap Start Unit, Guest Back										
	JOR2-SG21CLU Beech	1431	1518	1604	1730	1863	1997	2140	2304	2591	
	JOR2-SG21CLU Maple	1518	1604	1691	1816	1959	2112	2266	2410	2697	
	21" Closed Arm / Open Center Arm Start Unit, Guest Back										
	JOR2-SG21COS Beech	1229	1316	1404	1529	1664	1798	1941	2105	2391	
	JOR2-SG21COS Maple	1316	1404	1492	1615	1758	1912	2064	2210	2496	
	21" Closed Arm / Open Center Arm Urethane Cap Start Unit, Guest Back										
	JOR2-SG21COU Beech	1372	1459	1543	1668	1803	1938	2080	2242	2531	
	JOR2-SG21COU Maple	1459	1543	1632	1753	1898	2054	2206	2347	2636	
	24" Open Arm Start Unit, Guest Back										
	JOR2-SG24OPS Beech	1201	1285	1373	1495	1632	1765	1909	2070	2359	
	JOR2-SG24OPS Maple	1295	1380	1466	1592	1736	1887	2042	2188	2472	
	24" Open Arm Urethane Cap Start Unit, Guest Back										
	JOR2-SG24OPU Beech	1340	1423	1512	1636	1771	1905	2048	2211	2497	
	JOR2-SG24OPU Maple	1434	1521	1609	1731	1878	2029	2182	2326	2612	
	24" Closed Arm Start Unit, Guest Back										
	JOR2-SG24CLS Beech	1320	1408	1494	1618	1752	1885	2031	2193	2481	
	JOR2-SG24CLS Maple	1417	1503	1589	1714	1857	2011	2165	2308	2595	
	24" Closed Arm Urethane Cap Start Unit, Guest Back										
	JOR2-SG24CLU Beech	1461	1547	1634	1756	1892	2026	2170	2332	2620	
	JOR2-SG24CLU Maple	1558	1643	1730	1854	1997	2148	2304	2448	2736	
	24" Closed Arm / Open Center Arm Start Unit, Guest Back										
	JOR2-SG24COS Beech	1262	1346	1433	1558	1691	1823	1970	2132	2419	
	JOR2-SG24COS Maple	1357	1441	1529	1653	1798	1951	2105	2247	2533	
	24" Closed Arm / Open Center Arm Urethane Cap Start Unit, Guest Back										
	JOR2-SG24COU Beech	1401	1484	1570	1697	1833	1965	2109	2272	2559	
	JOR2-SG24COU Maple	1495	1583	1668	1791	1938	2090	2242	2386	2672	

ORDERING NOTES: A drawing showing the configuration of the multiple seating and tables is required with each purchase order. Additional features and options information see page 43, Option ucharges page 148.

PRODUCT CODE KEY

Line	Series	Chair Type	Back Type	Size	Arm Type
JOR	2	S	G	21	OPS
Jordan	Chair	Start Unit Multiple Seating	Guest Back		Open Arm
			P	24	OPU
			Patient Back (21" & 24" only)		Open Arm Urethane Arm Cap
				30	CLS
					Closed Arm
				44	CLU
					Closed Arm Urethane Arm Cap
					COS
					Closed Start Arm/ Open Center Arm
					COU
					Closed Start Arm/ Open Center Arm Urethane Arm Cap

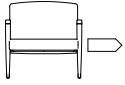
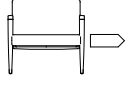
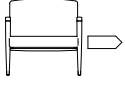
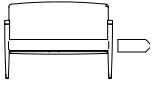
JORDAN | MULTIPLE SEATING - START, CENTER & END UNITS

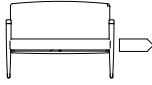





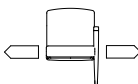
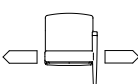

DESCRIPTION/MODEL	Species	COM		COL			FABRIC GRADES			LEATHER	
		1	2	3	4	5	6	7	8	9	
 30" Open Arm Start Unit, Guest Back	JOR2-SG30OPS	Beech	1563	1716	1853	2083	2312	2541	2772	3003	3366
	JOR2-SG30OPS	Maple	1678	1834	1987	2215	2447	2673	2906	3135	3499
30" Open Arm Urethane Cap Start Unit, Guest Back	JOR2-SG30OPU	Beech	1703	1856	1990	2220	2451	2682	2911	3141	3505
	JOR2-SG30OPU	Maple	1818	1971	2126	2355	2586	2817	3043	3274	3639
 30" Closed Arm Start Unit, Guest Back	JOR2-SG30CLS	Beech	1686	1839	1974	2205	2433	2664	2893	3126	3488
	JOR2-SG30CLS	Maple	1802	1955	2108	2339	2567	2798	3028	3259	3622
30" Closed Arm Urethane Cap Start Unit, Guest Back	JOR2-SG30CLU	Beech	1823	1979	2112	2343	2571	2804	3032	3265	3627
	JOR2-SG30CLU	Maple	1941	2092	2247	2479	2707	2936	3165	3397	3761
 30" Closed Arm/Open Center Arm Start Unit, Guest Back	JOR2-SG30COS	Beech	1624	1778	1912	2143	2374	2605	2833	3062	3428
	JOR2-SG30COS	Maple	1741	1893	2046	2278	2505	2738	2965	3195	3561
30" Closed Arm/Open Center Arm Urethane Cap Start Unit, Guest Back	JOR2-SG30COU	Beech	1765	1918	2054	2281	2513	2742	2971	3203	3565
	JOR2-SG30COU	Maple	1880	2033	2188	2417	2646	2877	3105	3336	3701
 44" Open Arm Start Unit, Guest Back	JOR2-SG44OPS	Beech	1870	2062	2223	2493	2772	3049	3327	3605	4037
	JOR2-SG44OPS	Maple	2012	2206	2378	2657	2934	3211	3489	3759	4198
44" Open Arm Urethane Cap Start Unit, Guest Back	JOR2-SG44OPU	Beech	2010	2201	2362	2634	2911	3187	3468	3743	4177
	JOR2-SG44OPU	Maple	2155	2345	2517	2794	3073	3352	3628	3896	4337
 44" Closed Arm Start Unit, Guest Back	JOR2-SG44CLS	Beech	1991	2185	2346	2614	2893	3169	3452	3727	4160
	JOR2-SG44CLS	Maple	2135	2327	2500	2778	3056	3333	3609	3880	4319
44" Closed Arm Urethane Cap Start Unit, Guest Back	JOR2-SG44CLU	Beech	2132	2324	2486	2754	3032	3312	3589	3866	4296
	JOR2-SG44CLU	Maple	2277	2465	2638	2919	3194	3472	3752	4020	4459
 44" Closed Arm/Open Center Arm Start Unit, Guest Back	JOR2-SG44COS	Beech	1932	2124	2283	2554	2833	3111	3388	3666	4098
	JOR2-SG44COS	Maple	2073	2266	2437	2717	2994	3271	3552	3819	4260
44" Closed Arm/Open Center Arm Urethane Cap Start Unit, Guest Back	JOR2-SG44COU	Beech	2070	2264	2423	2694	2971	3248	3529	3806	4237
	JOR2-SG44COU	Maple	2214	2406	2579	2857	3134	3412	3688	3958	4398

ORDERING NOTES: A drawing showing the configuration of the multiple seating and tables is required with each purchase order. Additional features and options information see page 43, Option ucharges page 148.

PRODUCT CODE KEY

Line	Series	Chair Type	Back Type	Size	Arm Type
JOR	2	S	G	21	OPS
Jordan	Chair	Start Unit Multiple Seating	Guest Back		Open Arm
			P	24	OPU
			Patient Back (21" & 24" only)		Open Arm Urethane Arm Cap
				30	CLS
					Closed Arm
				44	CLU
					Closed Arm Urethane Arm Cap
					COS
					Closed Start Arm/ Open Center Arm
					COU
					Closed Start Arm/ Open Center Arm Urethane Arm Cap

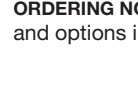
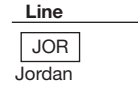
JORDAN | MULTIPLE SEATING - START, CENTER & END UNITS









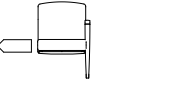

DESCRIPTION/MODEL	Species	COM		COL			FABRIC GRADES			LEATHER	
		1	2	3	4	5	6	7	8	9	
Center 	21" Open Arm Center Unit, Guest Back										
	JOR2-CG21OPS	Beech	1056	1141	1228	1355	1485	1620	1765	1927	2215
	JOR2-CG21OPS	Maple	1134	1228	1314	1439	1584	1736	1887	2033	2319
	21" Open Arm Urethane Cap Center Unit, Guest Back										
	JOR2-CG21OPU	Beech	1124	1212	1297	1422	1558	1691	1835	1997	2283
	JOR2-CG21OPU	Maple	1202	1297	1384	1509	1653	1806	1959	2104	2390
	21" Closed Arm Center Unit, Guest Back										
	JOR2-CG21CLS	Beech	1117	1203	1289	1415	1548	1683	1823	1989	2278
	JOR2-CG21CLS	Maple	1193	1289	1376	1499	1644	1798	1951	2092	2382
	21" Closed Arm Urethane Cap Center Unit, Guest Back										
	JOR2-CG21CLU	Beech	1187	1273	1358	1483	1618	1752	1894	2059	2346
	JOR2-CG21CLU	Maple	1263	1358	1446	1568	1714	1867	2020	2164	2451
	24" Open Arm Center Unit, Guest Back										
	JOR2-CG24OPS	Beech	1086	1170	1257	1380	1514	1646	1792	1956	2242
	JOR2-CG24OPS	Maple	1179	1266	1355	1479	1620	1765	1927	2070	2359
	24" Open Arm Urethane Cap Center Unit, Guest Back										
	JOR2-CG24OPU	Beech	1155	1240	1328	1451	1585	1717	1863	2026	2313
	JOR2-CG24OPU	Maple	1249	1336	1422	1547	1691	1835	1997	2140	2429
	24" Closed Arm Center Unit, Guest Back										
	JOR2-CG24CLS	Beech	1143	1230	1316	1441	1578	1712	1855	2018	2304
	JOR2-CG24CLS	Maple	1241	1328	1415	1537	1683	1823	1989	2132	2419
	24" Closed Arm Urethane Cap Center Unit, Guest Back										
	JOR2-CG24CLU	Beech	1215	1302	1389	1512	1645	1779	1924	2087	2376
	JOR2-CG24CLU	Maple	1311	1396	1483	1609	1752	1894	2059	2201	2488
	30" Open Arm Center Unit, Guest Back										
	JOR2-CG30OPS	Beech	1449	1603	1736	1967	2195	2427	2657	2886	3249
	JOR2-CG30OPS	Maple	1563	1716	1870	2103	2329	2562	2790	3022	3384
	30" Open Arm Urethane Cap Center Unit, Guest Back										
	JOR2-CG30OPU	Beech	1518	1670	1806	2035	2266	2496	2726	2957	3320
	JOR2-CG30OPU	Maple	1634	1788	1941	2170	2401	2632	2859	3091	3455
	30" Closed Arm Center Unit, Guest Back										
	JOR2-CG30CLS	Beech	1510	1664	1798	2028	2256	2487	2717	2947	3313
	JOR2-CG30CLS	Maple	1624	1778	1932	2163	2391	2621	2852	3081	3446
	30" Closed Arm Urethane Cap Center Unit, Guest Back										
	JOR2-CG30CLU	Beech	1581	1732	1867	2096	2327	2557	2788	3016	3382
	JOR2-CG30CLU	Maple	1695	1849	2002	2232	2462	2691	2921	3148	3516

ORDERING NOTES: A drawing showing the configuration of the multiple seating and tables is required with each purchase order. Additional features and options information see page 43, Option ucharges page 148.

PRODUCT CODE KEY

Line	Series	Chair Type	Back Type	Size	Arm Type
JOR	2	C	G	21	OPS
Jordan	Chair	Center Unit Multiple Seating	Guest Back		Open Arm
			P	24	OPU
			Patient Back (21" & 24" only)		Open Arm Urethane Arm Cap
				30	CLS
					Closed Arm
				44	CLU
					Closed Arm Urethane Arm Cap

JORDAN | MULTIPLE SEATING - START, CENTER & END UNITS







DESCRIPTION/MODEL	Species	COM		COL			FABRIC GRADES			LEATHER	
		1	2	3	4	5	6	7	8	9	
	44" Open Arm Center Unit, Guest Back										
	JOR2-CG44OPS	Beech	1755	1946	2109	2378	2657	2934	3211	3489	3921
	JOR2-CG44OPS	Maple	1898	2090	2264	2541	2819	3097	3374	3642	4083
	44" Open Arm Urethane Cap Center Unit, Guest Back										
	JOR2-CG44OPU	Beech	1823	2018	2177	2448	2726	3004	3283	3560	3993
	JOR2-CG44OPU	Maple	1968	2161	2332	2611	2888	3165	3445	3712	4153
	44" Closed Arm Center Unit, Guest Back										
	JOR2-CG44CLS	Beech	1817	2007	2170	2437	2717	2994	3271	3552	3982
	JOR2-CG44CLS	Maple	1959	2148	2324	2605	2880	3160	3434	3706	4145
	44" Closed Arm Urethane Cap Center Unit, Guest Back										
	JOR2-CG44CLU	Beech	1885	2079	2240	2507	2788	3066	3344	3620	4053
	JOR2-CG44CLU	Maple	2030	2220	2392	2671	2948	3229	3505	3773	4214
	21" Open Arm End Unit, Guest Back										
	JOR2-EG21OPS	Beech	1056	1141	1228	1355	1485	1620	1765	1927	2215
	JOR2-EG21OPS	Maple	1134	1228	1314	1439	1584	1736	1887	2033	2319
	21" Open Arm Urethane Cap End Unit, Guest Back										
	JOR2-EG21OPU	Beech	1124	1212	1297	1422	1558	1691	1835	1997	2283
	JOR2-EG21OPU	Maple	1202	1297	1384	1509	1653	1806	1959	2104	2390
	21" Closed Arm End Unit, Guest Back										
	JOR2-EG21CLS	Beech	1117	1203	1289	1415	1548	1683	1823	1989	2278
	JOR2-EG21CLS	Maple	1193	1289	1376	1499	1644	1798	1951	2092	2382
	21" Closed Arm Urethane Cap End Unit, Guest Back										
	JOR2-EG21CLU	Beech	1187	1273	1358	1483	1618	1752	1894	2059	2346
	JOR2-EG21CLU	Maple	1263	1358	1446	1568	1714	1867	2020	2164	2451
	24" Open Arm End Unit, Guest Back										
	JOR2-EG24OPS	Beech	1086	1170	1257	1380	1514	1647	1792	1956	2242
	JOR2-EG24OPS	Maple	1179	1266	1355	1479	1620	1765	1927	2070	2359
	24" Open Arm Urethane Cap End Unit, Guest Back										
	JOR2-EG24OPU	Beech	1155	1240	1328	1451	1585	1717	1863	2026	2313
	JOR2-EG24OPU	Maple	1249	1336	1422	1547	1691	1835	1997	2140	2429
	24" Closed Arm End Unit, Guest Back										
	JOR2-EG24CLS	Beech	1143	1230	1316	1441	1578	1712	1855	2018	2304
	JOR2-EG24CLS	Maple	1241	1328	1415	1537	1683	1823	1989	2132	2419
	24" Closed Arm Urethane Cap End Unit, Guest Back										
	JOR2-EG24CLU	Beech	1215	1302	1389	1512	1645	1779	1924	2087	2376
	JOR2-EG24CLU	Maple	1311	1396	1483	1609	1752	1894	2059	2201	2488
	30" Open Arm End Unit, Guest Back										
	JOR2-EG30OPS	Beech	1449	1603	1736	1967	2195	2427	2657	2886	3249
	JOR2-EG30OPS	Maple	1563	1716	1870	2103	2329	2562	2790	3022	3384
	30" Open Arm Urethane Cap End Unit, Guest Back										
	JOR2-EG30OPU	Beech	1518	1670	1806	2035	2266	2496	2726	2957	3320
	JOR2-EG30OPU	Maple	1634	1788	1941	2170	2401	2632	2859	3091	3455

ORDERING NOTES: A drawing showing the configuration of the multiple seating and tables is required with each purchase order. Additional features and options information see page 43, Option ucharges page 148.

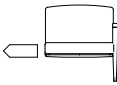
PRODUCT CODE KEY

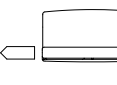
Line	Series	Chair Type	Back Type	Size	Arm Type
JOR	2	C	G	21	OPS
Jordan	Chair	Center Unit Multiple Seating	Guest Back		Open Arm
		E	P	24	OPU
			Patient Back (21" & 24" only)		Open Arm Urethane Arm Cap
				30	CLS
					Closed Arm
				44	CLU
					Closed Arm Urethane Arm Cap

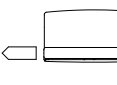
JORDAN | MULTIPLE SEATING - START, CENTER & END UNITS

DESCRIPTION/MODEL	Species	COM		COL	FABRIC GRADES				LEATHER		
		1	2	3	4	5	6	7	8	9	
	30" Closed Arm End Unit, Guest Back										
	JOR2-EG30CLS	Beech	1510	1664	1798	2028	2256	2487	2717	2947	3313
	JOR2-EG30CLS	Maple	1624	1778	1932	2163	2391	2621	2852	3081	3446
	30" Closed Arm Urethane Cap End Unit, Guest Back										
	JOR2-EG30CLU	Beech	1581	1732	1867	2096	2327	2557	2788	3016	3382
	JOR2-EG30CLU	Maple	1695	1849	2002	2232	2462	2691	2921	3148	3516
	44" Open Arm End Unit, Guest Back										
	JOR2-EG44OPS	Beech	1755	1946	2109	2378	2657	2934	3211	3489	3921
	JOR2-EG44OPS	Maple	1898	2090	2264	2541	2819	3097	3374	3642	4084
	44" Open Arm Urethane Cap End Unit, Guest Back										
	JOR2-EG44OPU	Beech	1823	2018	2177	2448	2726	3004	3283	3560	3993
	JOR2-EG44OPU	Maple	1968	2161	2332	2611	2888	3165	3445	3712	4153
	44" Closed Arm End Unit, Guest Back										
	JOR2-EG44CLS	Beech	1817	2007	2170	2437	2717	2994	3271	3552	3982
	JOR2-EG44CLS	Maple	1959	2148	2324	2605	2880	3160	3434	3706	4145
	44" Closed Arm Urethane Cap End Unit, Guest Back										
	JOR2-EG44CLU	Beech	1885	2079	2240	2507	2788	3066	3344	3620	4053
	JOR2-EG44CLU	Maple	2030	2220	2392	2671	2948	3229	3505	3773	4214

ORDERING NOTES: A drawing showing the configuration of the multiple seating and tables is required with each purchase order.

Jordan Guest Option Upcharges	\$ List	\$ List
CAL 133 & Moisture Barrier (per yard)	64	21" & 24" Cleanable Under-seat Splashguard
Kinetic Back option (not available for 30" & 44")	120	30" Cleanable Under-seat Splashguard
Removable Seat Cover (per seat)	90	44" Cleanable Under-seat Splashguard
21" & 24" - Removeable Guest Back Covers (per back)	58	Solid Surface Arm Cap (per arm) - Gr A White
30" & 44" - Removeable Guest Back Covers (per back)	90	Solid Surface Arm Cap (per arm) - Gr A Color
21" & 24" - Removeable Patient Back Covers (per back)	90	Solid Surface Arm Cap (per arm) - Gr B
30" - Removeable Patient Back Covers (per back)	142	Solid Surface Arm Cap (per arm) - Gr C
Combination Upholstery - dual fabrics (per chair)	33	Non-Marring Glide
Combination Upholstery - Three fabrics (per chair)	64	

Additional features and options information see page 43.

Patient backs are available on pre-configured units, please change the model number JOR2-PCG to JOR2-PCP and add the following upcharges per back:

Fabric Grades	(COM) 1	2	(COL) 3	4	5	6	7	8	9
21" Chair	269	318	365	477	569	633	711	791	870
24" Chair	284	340	384	509	591	679	760	853	941

PRODUCT CODE KEY

Line	Series	Chair Type	Back Type	Size	Arm Type
JOR	2	E	G	21	OPS
Jordan	Chair	End Unit Multiple Seating	Guest Back		Open Arm
			P	24	OPU
			Patient Back (21" & 24" only)		Open Arm Urethane Arm Cap
				30	CLS
					Closed Arm
				44	CLU
					Closed Arm Urethane Arm Cap

JORDAN | MULTIPLE SEATING - FREESPAN UNITS

DIMENSIONS & COM REQUIREMENTS

UNIT WITH NO CENTER ARM

	Overall Width	Overall Depth	Overall Height	Seat Height	Height of Arms from Floor	Width Between Arms	Seat Depth	Shipping Weight	Cube	COM Seat & Back Yardage	COM Fabric Seat Yardage	COM Fabric Back Yardage	COM Fabric Closed Arm Panel Yardage
PCFG21X2A	46.5	27	34.25	18.5	26	42	19	70	28	3.2	1.8	2.8	0.9
PCFP21X2A	46.5	27	43.5	18.5	26	42	19	80	37	4.2	1.8	3.8	0.9
PCFG21X3A	68	27	34.25	18.5	26	63.5	19	99	40	4.8	2.7	4.2	0.9
PCFP21X3A	68	27	43.5	18.5	26	63.5	19	114	54	6.3	2.7	5.7	0.9
PCFG24X2A	52.5	27	34.25	18.5	26	48	19	77	30	3.8	1.8	2.8	0.9
PCFP24X2A	52.5	27	43.5	18.5	26	48	19	87	42	4.8	1.8	3.8	0.9
PCFG24X3A	77	27	34.25	18.5	26	72.5	19	111	45	5.7	2.7	4.2	0.9
PCFP24X3A	77	27	43.5	18.5	26	72.5	19	126	61	7.2	2.7	5.7	0.9

UNIT WITH CENTER ARM

	Overall Width	Overall Depth	Overall Height	Seat Height	Height of Arms from Floor	Width Between Arms	Seat Depth	Shipping Weight	Cube	COM Seat & Back Yardage	COM Fabric Seat Yardage	COM Fabric Back Yardage
PCFG21X2B	47.5	27	34.5	18.5	26	20.5	19	73	28	3.2	1.8	2.4
PCFP21X2B	47.5	27	43.5	18.5	26	20.5	19	83	38	4.2	1.8	3.8
PCFG21X3B	70.5	27	34.5	18.5	26	20.5	19	105	40	4.8	2.7	3.8
PCFP21X3B	70.5	27	43.5	18.5	26	20.5	19	120	56	6.3	2.7	5.7
PCFG24X2B	53.5	27	34.5	18.5	26	23.5	19	80	30	3.8	1.8	2.4
PCFP24X2B	53.5	27	43.5	18.5	26	23.5	19	90	43	4.8	1.8	3.8
PCFG24X3B	79.5	27	34.5	18.5	26	23.5	19	117	45	5.7	2.7	3.8
PCFP24X3B	79.5	27	43.5	18.5	26	23.5	19	132	63	7.2	2.7	5.7

UNIT WITH CENTER ARM (CONTINUED), GUEST AND PATIENT BACKS

Unit With Center Arm (Continued)	COM Fabric Closed Arm Panels (2 Arms)	COM Fabric Closed Arm Panels (3 Arms)	COM Fabric Closed Arm Panels (4 Arms)
PCF21X2B	0.9	1.35	
PCF21X3B	0.9		1.8
PCF24X2B	0.9	1.35	
PCF24X3B	0.9		1.8

Note: Some vinyls, leathers & upholsteries are not suitable for application on Jordan seating.

The approval process is as follows:

1. A sample of the COM must be provided to Krug Customer Service prior to or at the time of order. For Maharam or Momentum, Krug will obtain the fabric sample.
2. The sample will be reviewed and the customer advised if the fabric is unsuitable.
3. The COM fabric or leather will be inspected when received at the factory, to identify any further concerns with its suitability.

ORDERING NOTES:

A drawing showing the configuration of the multiple seating and tables is required with each purchase order.

WEIGHT CAPACITIES

Jordan weight capacities are as follows:

2-Seat Freespan - 525 lbs per unit

3-Seat Freespan - 750 lbs per unit

Jordan Option Upcharges





	\$ List	\$ List
CAL 133 & Moisture Barrier (per yard)	64	Solid Surface Arm Cap (per arm) - Gr A White 238
Removable Seat Cover (per seat)	90	Solid Surface Arm Cap (per arm) - Gr A Color 240
21" & 24" - Removeable Back Covers (per back)	58	Solid Surface Arm Cap (per arm) - Gr B 250
21" & 24" - Removeable Patient Back Covers (per back)	90	Solid Surface Arm Cap (per arm) - Gr C 264
21" & 24" Cleanable Under-seat Splashguard (per seat)	40	Solid Surface Arm Cap (per pair) - Gr A White 452
Kinetic Back option (not available for 30" & 44")	120	Solid Surface Arm Cap (per pair) - Gr A Color 458
Combination Upholstery - dual fabrics (per chair)	33	Solid Surface Arm Cap (per pair) - Gr B 481
Combination Upholstery - Three fabrics (per chair)	64	Solid Surface Arm Cap (per pair) - Gr C 507
Ganging Bracket	58	Non-Marring Glide 37

Additional features and options information see page 43.

Patient backs are available on pre-configured units, please change the model number JOR2-PCG to JOR2-PCP and add the following upcharges per back:

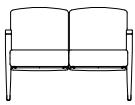
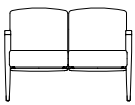
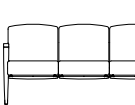
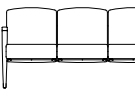
Fabric Grades	(COM) 1	2	(COL) 3	4	5	6	7	8	9
21" Chair	269	318	365	477	569	633	711	791	870
24" Chair	284	340	384	509	591	679	760	853	941

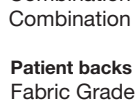
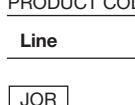
JORDAN | MULTIPLE SEATING - FREESPAN UNITS WITHOUT CENTER ARMS

DESCRIPTION/MODEL	Species	COM		COL		FABRIC GRADES			LEATHER		
		1	2	3	4	5	6	7	8	9	
	21" Pre-Configured Freespan Unit - Open Arm 2 Seat, Guest Back										
	JOR2-PCFG21X2AOPS	Beech	2012	2166	2319	2551	2779	3029	3279	3565	4084
	JOR2-PCFG21X2AOPS	Maple	2160	2312	2464	2695	2944	3203	3453	3739	4274
	21" Pre-Configured Freespan Unit - Open Arm Urethane Cap 2 Seat, Guest Back										
	JOR2-PCFG21X2AOPU	Beech	2155	2307	2460	2688	2920	3166	3418	3707	4222
	JOR2-PCFG21X2AOPU	Maple	2298	2451	2606	2835	3082	3342	3591	3877	4416
	21" Pre-Configured Freespan Unit - Closed Arm 2 Seat, Guest Back										
	JOR2-PCFG21X2ACLS	Beech	2135	2287	2443	2671	2903	3148	3399	3687	4206
	JOR2-PCFG21X2ACLS	Maple	2280	2433	2587	2818	3067	3322	3574	3859	4397
	21" Pre-Configured Freespan Unit - Closed Arm Urethane Cap 2 Seat, Guest Back										
	JOR2-PCFG21X2ACLU	Beech	2277	2429	2581	2810	3040	3291	3539	3827	4347
	JOR2-PCFG21X2ACLU	Maple	2419	2571	2726	2957	3206	3463	3712	3999	4536
	21" Pre-Configured Freespan Unit - Open Arm 3 Seat, Guest Backs										
	JOR2-PCFG21X3AOPS	Beech	2934	3163	3395	3731	4093	4447	4842	5284	6057
	JOR2-PCFG21X3AOPS	Maple	3158	3395	3624	3966	4352	4764	5176	5571	6344
	21" Pre-Configured Freespan Unit - Open Arm Urethane Cap 3 Seat, Guest Backs										
	JOR2-PCFG21X3AOPU	Beech	3073	3303	3534	3870	4235	4587	4980	5422	6196
	JOR2-PCFG21X3AOPU	Maple	3294	3534	3762	4108	4490	4903	5317	5710	6483
	21" Pre-Configured Freespan Unit - Closed Arm 3 Seat, Guest Backs										
	JOR2-PCFG21X3ACLS	Beech	3056	3286	3516	3852	4215	4570	4965	5404	6181
	JOR2-PCFG21X3ACLS	Maple	3277	3516	3744	4090	4473	4887	5299	5692	6466
	21" Pre-Configured Freespan Unit - Closed Arm Urethane Cap 3 Seat, Guest Backs										
	JOR2-PCFG21X3ACLU	Beech	3194	3425	3655	3993	4354	4709	5105	5544	6319
	JOR2-PCFG21X3ACLU	Maple	3417	3655	3885	4230	4613	5028	5439	5831	6607

ORDERING NOTES:

A drawing showing the configuration of the multiple seating and tables is required with each purchase order.

Jordan Option Upcharges

	\$ List	\$ List
CAL 133 & Moisture Barrier (per yard)	64	Solid Surface Arm Cap (per pair) - Gr A White
Removable Seat Cover (per seat)	90	Solid Surface Arm Cap (per pair) - Gr A Color
21" & 24" - Removeable Back Covers (per back)	58	Solid Surface Arm Cap (per pair) - Gr B
21" & 24" - Removeable Patient Back Covers (per back)	90	Solid Surface Arm Cap (per pair) - Gr C
21" & 24" Cleanable Under-seat Splashguard (per seat)	40	Ganging Bracket
Kinetic Back option (not available for 30" & 44")	120	Non-Marring Glide
Combination Upholstery - dual fabrics (per chair)	33	
Combination Upholstery - Three fabrics (per chair)	64	

Additional features and options information see page 43.

Patient backs are available on pre-configured units, please change the model number JOR2-PCG to JOR2-PCP and add the following upcharges per back:

Fabric Grades	(COM) 1	2	(COL) 3	4	5	6	7	8	9
21" Chair	269	318	365	477	569	633	711	791	870
24" Chair	284	340	384	509	591	679	760	853	941

PRODUCT CODE KEY

Line	Series	Chair Type	Back Type	Size	Unit Style	Arm Type
JOR	2	PCF	G	21X2	A	OPS
Jordan	Chair	Pre-Configured Freespan Multiple Unit	Guest Back		Unit with no Center Arm	Open Arm
			P	21X3	B	OPU
			Patient Back		Unit with Center Arm	Open Arm Urethane Arm Cap
				24X2		CLS
						Closed Arm
				24X3		CLU
						Closed Arm Urethane Arm Cap

JORDAN | MULTIPLE SEATING - FREESPAN UNITS WITHOUT CENTER ARMS

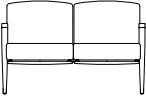
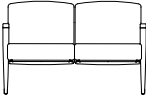
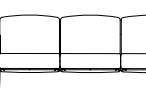
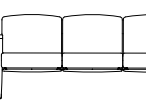
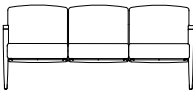
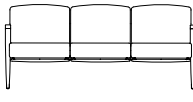
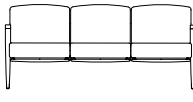
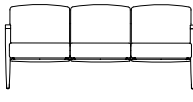
DESCRIPTION/MODEL	Species	COM		COL		FABRIC GRADES			LEATHER	
		1	2	3	4	5	6	7	8	9
	24" Pre-Configured Freespan Unit - Open Arm 2 Seat, Guest Backs									
	JOR2-PCFG24X2AOPS	Beech	2090	2242	2396	2628	2857	3127	3355	3642
JOR2-PCFG24X2AOPS	Maple	2254	2408	2562	2790	3039	3297	3546	3836	4370
	24" Pre-Configured Freespan Unit - Open Arm Urethane Cap 2 Seat, Guest Backs									
	JOR2-PCFG24X2AOPU	Beech	2230	2383	2535	2767	2995	3266	3495	3783
JOR2-PCFG24X2AOPU	Maple	2392	2548	2699	2929	3180	3435	3686	3975	4509
	24" Pre-Configured Freespan Unit - Closed Arm 2 Seat, Guest Backs									
	JOR2-PCFG24X2ACLS	Beech	2212	2364	2518	2747	2980	3247	3476	3763
JOR2-PCFG24X2ACLS	Maple	2377	2530	2683	2912	3162	3420	3669	3958	4491
	24" Pre-Configured Freespan Unit - Closed Arm Urethane Cap 2 Seat, Guest Backs									
	JOR2-PCFG24X2ACLU	Beech	2352	2504	2658	2888	3117	3386	3618	3904
JOR2-PCFG24X2ACLU	Maple	2516	2669	2822	3053	3301	3560	3810	4097	4632
	24" Pre-Configured Freespan Unit - Open Arm 3 Seat, Guest Backs									
	JOR2-PCFG24X3AOPS	Beech	3049	3279	3508	3845	4209	4562	4957	5395
JOR2-PCFG24X3AOPS	Maple	3289	3529	3759	4103	4486	4899	5309	5722	6478
	24" Pre-Configured Freespan Unit - Open Arm Urethane Cap 3 Seat, Guest Backs									
	JOR2-PCFG24X3AOPU	Beech	3187	3418	3648	3983	4349	4705	5096	5537
JOR2-PCFG24X3AOPU	Maple	3429	3668	3896	4242	4626	5037	5450	5863	6619
	24" Pre-Configured Freespan Unit - Closed Arm 3 Seat, Guest Backs									
	JOR2-PCFG24X3ACLS	Beech	3169	3399	3631	3965	4332	4685	5079	5519
JOR2-PCFG24X3ACLS	Maple	3411	3651	3880	4223	4609	5022	5430	5846	6602
	24" Pre-Configured Freespan Unit - Closed Arm Urethane Cap 3 Seat, Guest Backs									
	JOR2-PCFG24X3ACLU	Beech	3312	3539	3770	4105	4470	4823	5217	5659
JOR2-PCFG24X3ACLU	Maple	3552	3789	4020	4365	4748	5161	5572	5985	6739

ORDERING NOTES:

A drawing showing the configuration of the multiple seating and tables is required with each purchase order.

Jordan Option Upcharges	\$ List	\$ List
CAL 133 & Moisture Barrier (per yard)	64	Solid Surface Arm Cap (per pair) - Gr A White
Removable Seat Cover (per seat)	90	Solid Surface Arm Cap (per pair) - Gr A Color
21" & 24" - Removeable Back Covers (per back)	58	Solid Surface Arm Cap (per pair) - Gr B
21" & 24" - Removeable Patient Back Covers (per back)	90	Solid Surface Arm Cap (per pair) - Gr C
21" & 24" Cleanable Under-seat Splashguard (per seat)	40	Ganging Bracket
Kinetic Back option (not available for 30" & 44")	120	Non-Marring Glide
Combination Upholstery - dual fabrics (per chair)	33	
Combination Upholstery - Three fabrics (per chair)	64	

Additional features and options information see page 43.

Patient backs are available on pre-configured units, please change the model number JOR2-PCG to JOR2-PCP and add the following upcharges per back:

Fabric Grades	(COM) 1	2	(COL) 3	4	5	6	7	8	9
21" Chair	269	318	365	477	569	633	711	791	870
24" Chair	284	340	384	509	591	679	760	853	941

PRODUCT CODE KEY

Line	Series	Chair Type	Back Type	Size	Unit Style	Arm Type
JOR	2	PCF	G	21X2	A	OPS
Jordan	Chair	Pre-Configured Freespan Multiple Unit	Guest Back		Unit with no Center Arm	Open Arm
			P	21X3	B	OPU
			Patient Back		Unit with Center Arm	Open Arm Urethane Arm Cap
				24X2		CLS
						Closed Arm
				24X3		CLU
						Closed Arm Urethane Arm Cap

JORDAN | MULTIPLE SEATING - FREESPAN UNITS WITH CENTER ARMS

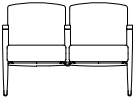
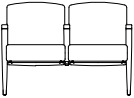
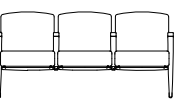
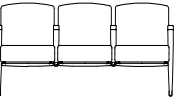
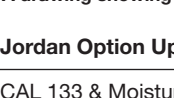
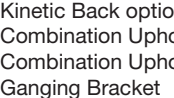
DESCRIPTION/MODEL	Species	COM		COL		FABRIC GRADES			LEATHER		
		1	2	3	4	5	6	7	8	9	
	21" Pre-Configured Freespan Center Arm Unit - Open Arm 2 Seat, Guest Backs										
	JOR2-PCFG21X2BOPS	Beech	2090	2242	2396	2628	2857	3105	3355	3642	4161
	JOR2-PCFG21X2BOPS	Maple	2236	2387	2541	2772	2892	3279	3529	3815	4352
	21" Pre-Configured Freespan Center Arm Unit - Open Arm Urethane Cap 2 Seat, Guest Backs										
	21" Pre-Configured Freespan Center Arm Unit - Closed Arm 2 Seat, Guest Backs										
	JOR2-PCFG21X2BCLU	Beech	2299	2452	2607	2837	3067	3315	3564	3852	4369
	JOR2-PCFG21X2BOPU	Maple	2444	2596	2748	2982	3231	3488	3738	4024	4561
	21" Pre-Configured Freespan Center Arm Unit - Closed Arm Urethane Cap 2 Seat, Guest Backs										
	21" Pre-Configured Freespan Center Arm Unit - Open Arm 3 Seat, Guest Backs										
	JOR2-PCFG21X3BOPS	Beech	3088	3316	3546	3882	4247	4602	4995	5437	6211
	JOR2-PCFG21X3BOPS	Maple	3311	3546	3776	4119	4505	4919	5329	5722	6497
	21" Pre-Configured Freespan Center Arm Unit - Open Arm Urethane Cap 3 Seat, Guest Backs										
	21" Pre-Configured Freespan Center Arm Unit - Open Arm Urethane Cap 3 Seat, Guest Backs										
	JOR2-PCFG21X3BOPU	Beech	3366	3595	3825	4162	4527	4879	5274	5716	6492
	JOR2-PCFG21X3BOPU	Maple	3588	3825	4058	4399	4784	5196	5609	6002	6779
	21" Pre-Configured Freespan Center Arm Unit - Closed Arm 3 Seat, Guest Backs										
	21" Pre-Configured Freespan Center Arm Unit - Closed Arm 3 Seat, Guest Backs										
	JOR2-PCFG21X3BCLS	Beech	3330	3561	3790	4129	4490	4844	5240	5679	6456
	JOR2-PCFG21X3BCLS	Maple	3553	3790	4021	4366	4749	5164	5573	5968	6743
	21" Pre-Configured Freespan Center Arm Unit - Closed Arm Urethane Cap 3 Seat, Guest Backs										
	21" Pre-Configured Freespan Center Arm Unit - Closed Arm Urethane Cap 3 Seat, Guest Backs										
	JOR2-PCFG21X3BCLU	Beech	3608	3841	4068	4405	4771	5122	5518	5958	6734
	JOR2-PCFG21X3BCLU	Maple	3829	4068	4297	4644	5030	5441	5852	6245	7020

ORDERING NOTES:

A drawing showing the configuration of the multiple seating and tables is required with each purchase order.

Jordan Option Upcharges





	\$ List	\$ List
CAL 133 & Moisture Barrier (per yard)	64	Solid Surface Arm Cap (per arm) - Gr A White
Removable Seat Cover (per seat)	90	Solid Surface Arm Cap (per arm) - Gr A Color
21" & 24" - Removeable Back Covers (per back)	58	Solid Surface Arm Cap (per arm) - Gr B
21" & 24" - Removeable Patient Back Covers (per back)	90	Solid Surface Arm Cap (per arm) - Gr C
21" & 24" Cleanable Under-seat Splashguard (per seat)	40	Solid Surface Arm Cap (per pair) - Gr A White
Kinetic Back option (not available for 30" & 44")	120	Solid Surface Arm Cap (per pair) - Gr A Color
Combination Upholstery - dual fabrics (per chair)	33	Solid Surface Arm Cap (per pair) - Gr B
Combination Upholstery - Three fabrics (per chair)	64	Solid Surface Arm Cap (per pair) - Gr C
Ganging Bracket	58	Non-Marring Glide

Additional features and options information see page 43, Patient back option upcharges page 154.

PRODUCT CODE KEY

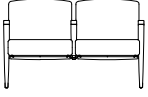
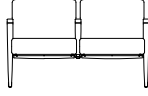
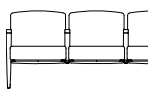
Line	Series	Chair Type	Back Type	Size	Unit Style	Arm Type
JOR	2	PCF	G	21X2	A	OPS
Jordan	Chair	Pre-Configured Freespan Multiple Unit	Guest Back		Unit with no Center Arm	Open Arm
			P	21X3	B	OPU
			Patient Back		Unit with Center Arm	Open Arm Urethane Arm Cap
				24X2		CLS
						Closed Arm
				24X3		CLU
						Closed Arm Urethane Arm Cap

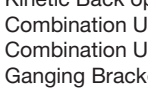
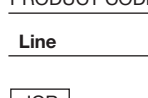
JORDAN | MULTIPLE SEATING - FREESPAN UNITS WITH CENTER ARMS

DESCRIPTION/MODEL	Species	COM		COL		FABRIC GRADES			LEATHER		
		1	2	3	4	5	6	7	8	9	
	24" Pre-Configured Freespan Center Arm Unit - Open Arm 2 Seat, Guest Backs										
	JOR2-PCFG24X2BOPS	Beech	2166	2319	2472	2703	2934	3203	3432	3718	4237
	JOR2-PCFG24X2BOPS	Maple	2329	2485	2637	2867	3115	3374	3624	3911	4447
	24" Pre-Configured Freespan Center Arm Unit - Open Arm Urethane Cap 2 Seat, Guest Backs										
	JOR2-PCFG24X2BOPU	Beech	2377	2530	2683	2912	3142	3411	3641	3930	4444
	JOR2-PCFG24X2BOPU	Maple	2539	2694	2847	3076	3326	3582	3830	4118	4656
	24" Pre-Configured Freespan Center Arm Unit - Closed Arm 2 Seat, Guest Backs										
	JOR2-PCFG24X2BCLS	Beech	2348	2503	2657	2886	3115	3384	3614	3902	4421
	JOR2-PCFG24X2BCLS	Maple	2515	2668	2820	3052	3299	3559	3809	4093	4631
	24" Pre-Configured Freespan Center Arm Unit - Closed Arm Urethane Cap 2 Seat, Guest Backs										
	JOR2-PCFG24X2BCLU	Beech	2559	2713	2866	3096	3326	3594	3823	4112	4630
	JOR2-PCFG24X2BCLU	Maple	2721	2877	3029	3260	3508	3767	4014	4305	4841
	24" Pre-Configured Freespan Center Arm Unit - Open Arm 3 Seat, Guest Backs										
	JOR2-PCFG24X3BOPS	Beech	3203	3432	3662	3997	4363	4715	5110	5549	6325
	JOR2-PCFG24X3BOPS	Maple	3441	3682	3911	4257	4639	5053	5464	5876	6632
	24" Pre-Configured Freespan Center Arm Unit - Open Arm Urethane Cap 3 Seat, Guest Backs										
	JOR2-PCFG24X3BOPU	Beech	3483	3711	3940	4278	4641	4995	5389	5830	6604
	JOR2-PCFG24X3BOPU	Maple	3720	3960	4189	4534	4919	5332	5742	6156	6912
	24" Pre-Configured Freespan Center Arm Unit - Closed Arm 3 Seat, Guest Backs										
	JOR2-PCFG24X3BCLS	Beech	3446	3673	3906	4242	4608	4961	5353	5794	6570
	JOR2-PCFG24X3BCLS	Maple	3686	3927	4154	4502	4885	5295	5708	6120	6875
	24" Pre-Configured Freespan Center Arm Unit - Closed Arm Urethane Cap 3 Seat, Guest Backs										
	JOR2-PCFG24X3BCLU	Beech	3723	3955	4184	4521	4886	5240	5633	6074	6849
	JOR2-PCFG24X3BCLU	Maple	3963	4205	4435	4780	5164	5576	5986	6399	7155

ORDERING NOTES:

A drawing showing the configuration of the multiple seating and tables is required with each purchase order.

Jordan Option Upcharges	\$ List	\$ List	
CAL 133 & Moisture Barrier (per yard)	64	Solid Surface Arm Cap (per arm) - Gr A White	238
Removable Seat Cover (per seat)	90	Solid Surface Arm Cap (per arm) - Gr A Color	240
21" & 24" - Removeable Back Covers (per back)	58	Solid Surface Arm Cap (per arm) - Gr B	250
21" & 24" - Removeable Patient Back Covers (per back)	90	Solid Surface Arm Cap (per arm) - Gr C	264
21" & 24" Cleanable Under-seat Splashguard (per seat)	40	Solid Surface Arm Cap (per pair) - Gr A White	452
Kinetic Back option (not available for 30" & 44")	120	Solid Surface Arm Cap (per pair) - Gr A Color	458
Combination Upholstery - dual fabrics (per chair)	33	Solid Surface Arm Cap (per pair) - Gr B	481
Combination Upholstery - Three fabrics (per chair)	64	Solid Surface Arm Cap (per pair) - Gr C	507
Ganging Bracket	58	Non-Marring Glide	37

Additional features and options information see page 43, Patient back option upcharges page 154.

PRODUCT CODE KEY

Line	Series	Chair Type	Back Type	Size	Unit Style	Arm Type
JOR	2	PCF	G	21X2	A	OPS
Jordan	Chair	Pre-Configured	Guest Back Freespan Multiple Unit		Unit with no	Open Arm Center Arm
			P	21X3	B	OPU
			Patient Back		Unit with Center Arm	Open Arm Urethane Arm Cap
				24X2		CLS
						Closed Arm
				24X3		CLU
						Closed Arm Urethane Arm Cap

EASY ACCESS CHAIRS AND STOOLS

- 160 Karma
- 163 Solis
- 165 Faeron Wood
- 168 Faeron Metal
- 171 Jordan
- 174 Corfu

LEED CI CREDITS



MATERIAL CONTENT:

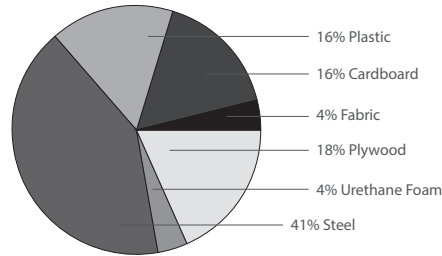

PRE-CONSUMER RECYCLED CONTENT = 5.51%

POST-CONSUMER RECYCLED CONTENT = 24.98%

Up to 73.47% of this Karma product is recyclable at the end of its useful life.

CONTRIBUTES TO

CREDIT 2.1 - 2.2	Construction Waste Management	1-2 point(s)
CREDIT 3.3	Resource Reuse	1 point
CREDIT 4.1	Recycled Content	1 point
CREDIT 4.2	Recycled Content	1 point
CREDIT 4.5	Low Emitting Materials, Systems & Seating	1 point
CREDIT 5.1	Regional Materials*	1 point
CREDIT 7	Certified Wood (MUST BE REQUESTED)	1 point(s)

*This credit is only applicable if in total 20% of the combined value of the procurement of construction materials and in the furniture are manufactured within a radius of 500 miles. This credit will apply if the installation of the finished product occurs within 500 miles of Kitchener, Ontario.

level® CERTIFICATION, AIR EMISSIONS AND FSC® CERTIFICATION



level® CERTIFICATION

BIFMA's e3 Furniture Sustainability Standard is a voluntary, multi-attribute standard that measures the degree of sustainability of furniture. This standard evaluates product and company environmental attributes and compliance systems in a wide range of elements which include Materials, Energy & Atmosphere, Human & Ecosystem Health and Social Responsibility. Karma products have earned level®, BIFMA's sustainability certification program for furniture, certification through third-party verification against the e3 standard.

AIR-EMISSIONS

All Karma products are supplied with air-emissions certified. Contact customer service for information.



FSC®

In 2005, Krug received Forest Stewardship Council® (FSC®) Chain-of-Custody certification for our manufacturing facilities. The FSC® Chain-of-Custody tracks certified wood from seedling to final sale. It verifies that the material for our FSC® certified products only come from well-managed, FSC®-certified forests and other controlled sources. FSC® is dedicated to the promotion of responsible forest management worldwide helping to take care of forests for future generations. Karma and other Krug products can be specified with FSC® Certification. Contact customer service for further information, pricing and lead times.



Architects, designers, and building professionals can specify FSC®-certified products in order to achieve a point from the U.S. Green Building Council's Leadership in Energy and Environmental Design (LEED) Rating System.

KARMA | EASY ACCESS CHAIR

DESCRIPTION/MODEL	COM		COL			FABRIC GRADES			LEATHER		
	1	2	3	4	5	6	7	8	9		



18.5" Easy Access Chair, Matte Black or Silver Metallic - Fully Upholstered, with Arm and Standard Dust Cover
 KAR2-18.5E_U_D 861 886 912 948 985 1021 1062 1114 1164

18.5" Easy Access Chair, Polished Chrome - Fully Upholstered, with Arm and Standard Dust Cover
 KAR2-18.5ECU_D 917 942 968 1004 1043 1081 1119 1169 1220



18.5" Easy Access Chair, Matte Black or Silver Metallic- Upholstered Seat & Wood Back, with Arm and Standard Dust Cover
 KAR2-18.5E_W_D 885 898 910 929 949 963 985 1012 1037

18.5" Easy Access Chair, Polished Chrome - Upholstered Seat & Wood Back, with Arm and Standard Dust Cover
 KAR2-18.5ECW_D 941 956 967 984 1006 1022 1043 1067 1094

ORDERING NOTES: When selecting Frame Color and Arm Style please see Product Code Key below. Karma chairs all include the Standard Dust Cover (select "D" below), for optional Polymer Shroud change "D" to "S" and add upcharge listed below.

DIMENSIONS:

All dimensions are in inches and approximate and are subject to change without notice. Contact Customer Service if dimensions are critical.

	Overall Width	Overall Depth	Overall Height	Seat Height	Arms From Floor	Between Arms	Seat Depth	Shipping Weight/box			COM YRD	Cubes
								1 Chair	2 Chairs	3 Chairs		
Easy Access or Counter Seat Upholstered												
Armless												
KAR2-18.5	20.2	21.9	39.9	24	n/a	n/a	17	43	-	-	1	20
with Arms												
KAR2-18.5	24.5	21.9	39.9	24	32.8	18.5	17	44.5	-	-	1	20
Easy Access or Counter Seat Wood Back												
Armless												
KAR2-18.5	20.2	21.9	39.9	24	n/a	n/a	17	43	-	-	1	20
with Arms												
KAR2-18.5	24.5	21.9	39.9	24	32.8	18.5	17	44.5	-	-	1	20

Karma Option Upcharges

\$ List



CAL 133 & Moisture Barrier (per yard)	64
Removable Seat Cover (per seat)	71
Removable Back Cover (per back)	71
Polymer Underseat Shroud 18.5"	47
Combination Upholstery - dual fabrics (per chair)	33

Additional features and options information see page 8.

PRODUCT CODE KEY

Line	Series	Frame Size	Frame Color	Style	Arm Style	Underseat Shroud
KAR	2	18.5E	B	U	AB	S
Karma	Chair	18.5" Easy Access Chair	Matte Black	Fully Upholstered	Black	Polymer Shroud
			S	W	AG	D
			Silver Metallic	Beech Wood Back	Grey	Standard Dust Cover
			C		AT	
			Polished Chrome		Taupe	

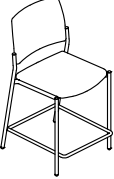
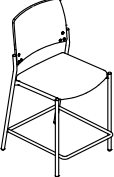
KARMA | COUNTER STOOL

DESCRIPTION/MODEL	Species	COM		COL			FABRIC GRADES		LEATHER	
		1	2	3	4	5	6	7	8	9
	18.5" Counter Height Stool, Matte Black or Silver Metallic - Fully Upholstered, No Arm, with Standard Dust Cover KAR2-18.5C_UNAD	642	667	693	727	767	804	843	892	942
	18.5" Counter Height Stool, Polished Chrome - Fully Upholstered, No Arm, with Standard Dust Cover KAR2-18.5CCUNAD	691	716	740	778	816	852	890	941	990
	18.5" Counter Height Stool, Matte Black or Silver Metallic- Upholstered Seat & Wood Back, No Arm, with Standard Dust Cover KAR2-18.5C_WNAD	673	688	699	717	738	756	778	804	829
	18.5" Counter Height Stool, Polished Chrome - Upholstered Seat & Wood Back, No Arm, with Standard Dust Cover KAR2-18.5CCWNAD	723	737	749	766	785	805	824	851	877
	18.5" Counter Height Stool, Matte Black or Silver Metallic - Fully Upholstered, with Arms, with Standard Dust Cover KAR2-18.5C_U_D	677	697	729	764	804	838	879	930	981
	18.5" Counter Height Stool, Polished Chrome - Fully Upholstered, with Arms, with Standard Dust Cover KAR2-18.5CCU_D	727	751	778	811	852	887	929	979	1030
	18.5" Counter Height Stool, Matte Black or Silver Metallic- Upholstered Seat & Wood Back, with Arms, with Standard Dust Cover KAR2-18.5C_W_D	701	715	727	744	765	782	804	829	853
	18.5" Counter Height Stool, Polished Chrome - Upholstered Seat & Wood Back, with Arms, with Standard Dust Cover KAR2-18.5CCW_D	751	764	778	794	812	832	852	878	905

ORDERING NOTES: When selecting Frame Color and Arm Style please see Product Code Key below. Karma chairs all include the Standard Dust Cover (select "D" below), for optional Polymer Shroud change "D" to "S" and add upcharge listed below.

Karma Option Upcharges	\$ List
CAL 133 & Moisture Barrier (per yard)	64
Removable Seat Cover (per seat)	71
Removable Back Cover (per back)	71
Polymer Underseat Shroud 18.5"	47
Combination Upholstery - dual fabrics (per chair)	33

Additional features and options information see page 8.

PRODUCT CODE KEY

Line	Series	Frame Size	Frame Color	Style	Arm Style	Underseat Shroud
<input type="text" value="KAR"/>	<input type="text" value="2"/>	<input type="text" value="18.5C"/>	<input type="text" value="B"/>	<input type="text" value="U"/>	<input type="text" value="NA"/>	<input type="text" value="S"/>
Karma	Chair	18.5" Counter Height Stool	Matte Black	Fully Upholstered	No Arm	Polymer Shroud
			<input type="text" value="S"/>	<input type="text" value="W"/>	<input type="text" value="AB"/>	<input type="text" value="D"/>
			Silver Metallic	Beech Wood Back	Black	Standard Dust Cover
			<input type="text" value="C"/>		<input type="text" value="AG"/>	
			Polished Chrome		Grey	
					<input type="text" value="AT"/>	
					Taupe	

SOLIS | ENVIRONMENTAL SUMMARY

LEED CI CREDITS



MATERIAL CONTENT:

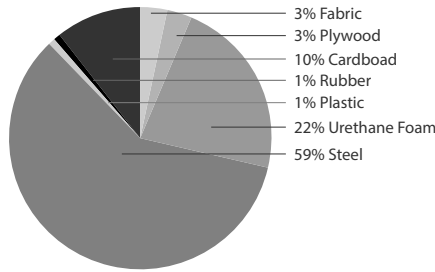

PRE-CONSUMER
RECYCLED CONTENT = 15.28%

POST-CONSUMER
RECYCLED CONTENT = 21.71%

Up to 45.76% of this Solis product is recyclable at the end of its useful life.

CONTRIBUTES TO

CREDIT 2.1 - 2.2	Construction Waste Management	1-2 point(s)
CREDIT 3.3	Resource Reuse	1 point
CREDIT 4.1	Recycled Content	1 point
CREDIT 4.2	Recycled Content	1 point
CREDIT 4.5	Low Emitting Materials, Systems & Seating	1 point
CREDIT 5.1	Regional Materials*	1 point
CREDIT 7	Certified Wood (MUST BE REQUESTED)	1 point(s)

*This credit is only applicable if in total 20% of the combined value of the procurement of construction materials and in the furniture are manufactured within a radius of 500 miles. This credit will apply if the installation of the finished product occurs within 500 miles of Kitchener, Ontario.

level® CERTIFICATION, AIR EMISSIONS AND FSC® CERTIFICATION



level® CERTIFICATION

BIFMA's e3 Furniture Sustainability Standard is a voluntary, multi-attribute standard that measures the degree of sustainability of furniture. This standard evaluates product and company environmental attributes and compliance systems in a wide range of elements which include Materials, Energy & Atmosphere, Human & Ecosystem Health and Social Responsibility. Solis products have earned level®, BIFMA's sustainability certification program for furniture, certification through third-party verification against the e3 standard.

AIR-EMISSIONS

All Solis products are supplied with air-emissions certified. Contact customer service for information.



FSC®

In 2005, Krug received Forest Stewardship Council® (FSC®) Chain-of-Custody certification for our manufacturing facilities. The FSC® Chain-of-Custody tracks certified wood from seedling to final sale. It verifies that the material for our FSC® certified products only come from well-managed, FSC®-certified forests and other controlled sources. FSC® is dedicated to the promotion of responsible forest management worldwide helping to take care of forests for future generations. Solis and other Krug products can be specified with FSC® Certification. Contact customer service for further information, pricing and lead times.









Architects, designers, and building professionals can specify FSC®-certified products in order to achieve a point from the U.S. Green Building Council's Leadership in Energy and Environmental Design (LEED) Rating System.

SOLIS | EASY ACCESS CHAIR

DIMENSIONS & COM. REQUIREMENTS

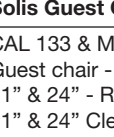
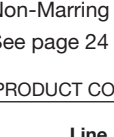
	Overall Width	Overall Depth	Overall Height	Seat Height	Height of Arms from Floor	Width Between Arms	Seat Depth	Shipping Weight	Cube	COM Yardage Seat & Back	COM Yardage Seat	COM Yardage Back
UPHOLSTERED GUEST BACK												
21" Seat	25	30.75	40.5	24.5	32	20	20	51	16	1.6	0.9	1.6
24" Seat	28	30.75	40.5	24.5	32	23	20	55	18	1.6	0.9	1.6
MESH GUEST BACK												
21" Seat	25	30.75	40.5	24.5	32	20	20	49	16	-	0.9	-
24" Seat	28	30.75	40.5	24.5	32	23	20	52	18	-	0.9	-
UPHOLSTERED PATIENT BACK												
21" Seat	25	30.75	49.75	24.5	32	20	20	54	21	2.1	0.9	2.0
24" Seat	28	30.75	49.75	24.5	32	23	20	58	23	2.1	0.9	2.0
MESH PATIENT BACK												
21" Seat	25	30.75	49.75	24.5	32	20	20	50	21	-	0.9	-
24" Seat	28	30.75	49.75	24.5	32	23	20	53	23	-	0.9	-
Footrest height (All Models) 7.25"												

DESCRIPTION/MODEL	Arm Type	COM.		COL			FABRIC GRADES			LEATHER	
		1	2	3	4	5	6	7	8	9	
	21" Guest, Open Arm, Mesh Back										
	SOL2-HGM21OPU Urethane	1460	1493	1527	1592	1661	1727	1791	1857	1960	
	SOL2-HGM21OPW Beech	1587	1619	1653	1717	1786	1853	1918	1985	2087	
	21" Guest, Open Arm, Upholstered Back										
	SOL2-HGU21OPU Urethane	1537	1592	1646	1758	1867	1979	2088	2196	2419	
	SOL2-HGU21OPW Beech	1664	1717	1774	1884	1993	2105	2215	2324	2545	
	24" Guest, Open Arm, Mesh Back										
	SOL2-HGM24OPU Urethane	1491	1524	1557	1622	1689	1755	1821	1886	1990	
	SOL2-HGM24OPW Beech	1617	1647	1683	1748	1816	1882	1947	2016	2117	
	24" Guest, Open Arm, Upholstered Back										
	SOL2-HGU24OPU Urethane	1568	1624	1680	1792	1908	2019	2131	2241	2466	
	SOL2-HGU24OPW Beech	1695	1752	1808	1920	2033	2145	2255	2369	2594	
	21" Patient, Open Arm, Mesh Back										
	SOL2-HPM21OPU Urethane	1569	1604	1638	1703	1771	1836	1902	1968	2070	
	SOL2-HPM21OPW Beech	1697	1730	1764	1832	1896	1962	2030	2094	2196	
	21" Patient, Open Arm, Upholstered Back										
	SOL2-HPU21OPU Urethane	1653	1728	1801	1947	2092	2241	2388	2539	2833	
	SOL2-HPU21OPW Beech	1778	1854	1926	2073	2219	2369	2516	2665	2959	
	24" Patient, Open Arm, Mesh Back										
	SOL2-HPM24OPU Urethane	1617	1647	1683	1748	1816	1882	1947	2016	2117	
	SOL2-HPM24OPW Beech	1744	1776	1809	1878	1942	2007	2073	2140	2242	
	24" Patient, Open Arm, Upholstered Back										
	SOL2-HPU24OPU Urethane	1702	1777	1854	2004	2158	2308	2460	2612	2917	
	SOL2-HPU24OPW Beech	1827	1905	1980	2132	2282	2434	2587	2741	3042	

Solis Guest Option Upcharges

	\$ List	\$ List
CAL 133 & Moisture Barrier (per yard)	64	
Guest chair - Removable Seat Cover (per seat)	90	Solid Surface Arm (per pair) - Gr A White
21" & 24" - Removeable Back Covers	58	Solid Surface Arm (per pair) - Gr A Color
21" & 24" Cleanable Under-seat Splashguard	40	Solid Surface Arm (per pair) - Gr B
Kinetic Back option	120	Solid Surface Arm (per pair) - Gr C
Combination upholstery - Dual	33	Maple Arm upgrade per arm (add to beech price)
Non-Marring Glide	36	Beech Wood Side Rails Upgrade (per chair)
		Maple wood Side Rails Upgrade (per chair)

See page 24 for Features and Options information.

PRODUCT CODE KEY

Line	Series	Chair Type	Style	Back Type	Size	Arm Type
SOL	2	H	G	U	21	OPW
Solis	Chair	Easy Access	Guest	Upholstered Back		Open Arm - Wood Cap
			P	M	24	OPU
			Patient	Mesh		Open Arm Urethane Arm Cap

FAERON WOOD | ENVIRONMENTAL SUMMARY

LEED CI CREDITS



MATERIAL CONTENT:

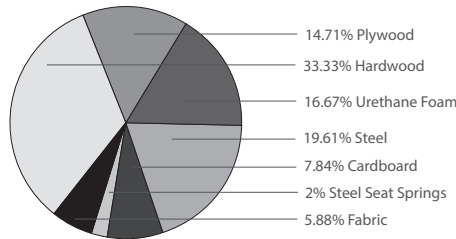

PRE-CONSUMER RECYCLED CONTENT = 5.39%

POST-CONSUMER RECYCLED CONTENT = 11.76%

Up to 27.45% of this Faeron product is recyclable at the end of its useful life.

CONTRIBUTES TO

CREDIT 2.1 - 2.2	Construction Waste Management	1-2 point(s)
CREDIT 3.3	Resource Reuse	1 point
CREDIT 4.1	Recycled Content	1 point
CREDIT 4.5	Low Emitting Materials, Systems & Seating	1 point
CREDIT 5.1	Regional Materials*	1 point
CREDIT 7	Certified Wood (MUST BE REQUESTED)	1 point(s)

*This credit is only applicable if in total 20% of the combined value of the procurement of construction materials and in the furniture are manufactured within a radius of 500 miles. This credit will apply if the installation of the finished product occurs within 500 miles of Kitchener, Ontario.

level® CERTIFICATION, AIR EMISSIONS AND FSC® CERTIFICATION



level® CERTIFICATION

BIFMA's e3 Furniture Sustainability Standard is a voluntary, multi-attribute standard that measures the degree of sustainability of furniture. This standard evaluates product and company environmental attributes and compliance systems in a wide range of elements which include Materials, Energy & Atmosphere, Human & Ecosystem Health and Social Responsibility. Faeron products have earned level®, BIFMA's sustainability certification program for furniture, certification through third-party verification against the e3 standard.

AIR-EMISSIONS

All Faeron products are supplied with air-emissions certified. Contact customer service for information.



FSC®

In 2005, Krug received Forest Stewardship Council® (FSC®) Chain-of-Custody certification for our manufacturing facilities. The FSC® Chain-of-Custody tracks certified wood from seedling to final sale. It verifies that the material for our FSC® certified products only come from well-managed, FSC®-certified forests and other controlled sources. FSC® is dedicated to the promotion of responsible forest management worldwide helping to take care of forests for future generations. Faeron and other Krug products can be specified with FSC® Certification. Contact customer service for further information, pricing and lead times.



Architects, designers, and building professionals can specify FSC®-certified products in order to achieve a point from the U.S. Green Building Council's Leadership in Energy and Environmental Design (LEED) Rating System.

FAERON WOOD | EASY ACCESS CHAIR

DIMENSIONS

	Overall Width	Overall Depth	Overall Height	Seat Height	Height of Arms from Floor	Footrest Height	Width Between Arms	Seat Depth	Shipping Weight	Cubes
21" Guest	25.0	29.75	40.0	25	30.5	6.75	21	19.5	51	21
24" Guest	28.0	29.75	40.0	25	30.5	6.75	24	19.5	55	26
21" Patient	25.0	29.75	50.5	25	30.5	6.75	21	19.5	56	26
24" Patient	28.0	29.75	50.5	25	30.5	6.75	24	19.5	61	30

COM YARDAGES

	COM Yardage Seat Only	COM Yardage Back Only	COM Yardage Seat & Back
21" & 24" Guest - One Chair	0.9	1.4	1.6
21" & 24" Patient - One Chair	0.9	2.0	2.0

WEIGHT CAPACITIES

Faeron weight capacities are as follows:
Easy Access Chairs (21" & 24") - 500 lbs





Faeron Option Upcharges	\$ List	\$ List
CAL 133 & Moisture Barrier (per yard)	64	Solid Surface Arm Cap (per pair) - Gr A White 364
Ganging Bracket	58	Solid Surface Arm Cap (per pair) - Gr A Color 376
Kinetic Back (not available for 30" & 44")	120	Solid Surface Arm Cap (per pair) - Gr B 396
21" & 24" Under-seat Splashguard	58	Solid Surface Arm Cap (per pair) - Gr C 410
Removeable Seat Cover (per seat)	90	Solid Surface Arm (per pair) - Gr A White 573
Removeable Back Cover (per back)(per back)	58	Solid Surface Arm (per pair) - Gr A Color 598
Urethane Arm Cap (per pair)	138	Solid Surface Arm (per pair) - Gr B 645
Combination upholstery - Dual	33	Solid Surface Arm (per pair) - Gr C 678
Combination upholstery - Three	64	See page 631 for color selection.

See page 31 for Features and Options information.

Patient backs are available on Easy Access units, please change the model number FAE-HG to FAE2-HP, and add the following upcharges per back:

	Grade 1	Grade 2	Grade 3	Grade 4	Grade 5	Grade 6	Grade 7	Grade 8	Grade 9
21" Chairs	63	74	90	114	138	164	189	215	265
24" Chairs	68	81	94	119	144	170	195	220	271

FAERON WOOD | EASY ACCESS CHAIR

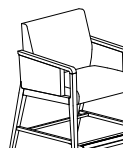
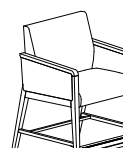
DESCRIPTION/MODEL	Species	COM		COL			FABRIC GRADES			LEATHER	
		1	2	3	4	5	6	7	8	9	
 21" Guest, Open Arm FAE2-HG21ONC	Beech Palette	1692	1744	1794	1896	1997	2098	2197	2301	2504	
 21" Guest, Semi Closed Arm FAE2-HG21SNC	Beech Palette	2146	2221	2298	2449	2605	2754	2906	3058	3363	
 21" Guest, Closed Arm FAE2-HG21CNC	Beech Palette	2161	2237	2312	2463	2615	2768	2920	3073	3376	
 24" Guest, Open Arm FAE2-HG24ONC	Beech Palette	1778	1831	1880	1981	2084	2185	2285	2386	2589	
 24" Guest, Semi Closed Arm FAE2-HG24SNC	Beech Palette	2232	2307	2384	2536	2688	2839	2992	3144	3449	
 24" Guest, Closed Arm FAE2-HG24CNC	Beech Palette	2244	2322	2397	2551	2701	2853	3008	3159	3462	

ORDERING NOTES: Faeron chairs can be specified with Urethane Arm Caps (UC), Solid Surface Arm Caps (SC) or Solid Surface Arm (SA), replace "NC" in the model number with the **Arm Style** selection below and add the upcharge listed on page 166 See page 631 for color selection. See page 31 for Features and Options information.

DESCRIPTION/MODEL	Price
 Metal Footrest Cap FAE2-RHFRC	80

PRODUCT CODE KEY

Line	Series	Chair Type	Size	Arm Type	Arm Cap
FAE Faeron	2 Chair	HG Easy Access Guest Chair	21	O Open Arm	NC No Cap
		HP Easy Access Patient Chair	24	S Semi Closed Arm	UC Urethane Cap
				C Closed Arm	SC Solid Surface Cap
					SA Solid Surface Arm

LEED CI CREDITS



MATERIAL CONTENT:

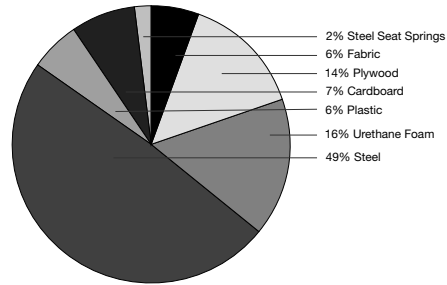

PRE-CONSUMER
RECYCLED CONTENT = 12.74%

POST-CONSUMER
RECYCLED CONTENT = 17.81%

Up to 56.6% of this Faeron Metal product is recyclable at the end of its useful life.

CONTRIBUTES TO

CREDIT 2.1 - 2.2	Construction Waste Management	1-2 point(s)
CREDIT 3.3	Resource Reuse	1 point
CREDIT 4.1	Recycled Content	1 point
CREDIT 4.2	Recycled Content	1 point
CREDIT 4.5	Low Emitting Materials, Systems & Seating	1 point
CREDIT 5.1	Regional Materials*	1 point
CREDIT 7	Certified Wood (MUST BE REQUESTED)	1 point(s)

*This credit is only applicable if in total 20% of the combined value of the procurement of construction materials and in the furniture are manufactured within a radius of 500 miles. This credit will apply if the installation of the finished product occurs within 500 miles of Kitchener, Ontario.

level® CERTIFICATION, AIR EMISSIONS AND FSC® CERTIFICATION



level® CERTIFICATION

BIFMA's e3 Furniture Sustainability Standard is a voluntary, multi-attribute standard that measures the degree of sustainability of furniture. This standard evaluates product and company environmental attributes and compliance systems in a wide range of elements which include Materials, Energy & Atmosphere, Human & Ecosystem Health and Social Responsibility. Faeron products have earned level®, BIFMA's sustainability certification program for furniture, certification through third-party verification against the e3 standard.

AIR-EMISSIONS

All Faeron products are supplied with air-emissions certified. Contact customer service for information.



FSC®

In 2005, Krug received Forest Stewardship Council® (FSC®) Chain-of-Custody certification for our manufacturing facilities. The FSC® Chain-of-Custody tracks certified wood from seedling to final sale. It verifies that the material for our FSC® certified products only come from well-managed, FSC®-certified forests and other controlled sources. FSC® is dedicated to the promotion of responsible forest management worldwide helping to take care of forests for future generations. Faeron and other Krug products can be specified with FSC® Certification. Contact customer service for further information, pricing and lead times.



Architects, designers, and building professionals can specify FSC®-certified products in order to achieve a point from the U.S. Green Building Council's Leadership in Energy and Environmental Design (LEED) Rating System.

FAERON METAL | EASY ACCESS CHAIR

DIMENSIONS

	Overall Width	Overall Depth	Overall Height	Seat Height	Height of Arms from Floor	Footrest Height	Width Between Arms	Seat Depth	Shipping Weight	Cubes
21" Guest	25.0	29.75	40.0	25.0	30.5	6.75	21	19.5	70	21
24" Guest	28.0	29.75	40.0	25.0	30.5	6.75	24	19.5	74	26
21" Patient	25.0	29.75	50.5	25.0	30.5	6.75	21	19.5	75	26
24" Patient	28.0	29.75	50.5	25.0	30.5	6.75	24	19.5	80	30

COM YARDAGES

	COM Yardage Seat Only	COM Yardage Back Only	COM Yardage Seat & Back	COM Yardage Closed Arm
21" & 24" Guest - One Chair	0.9	1.4	1.6	0.96
21" & 24" Patient - One Chair	0.9	2.0	2.0	0.96

WEIGHT CAPACITIES

Faeron Metal weight capacities are as follows:
 Guest & Patient Chairs (21" & 24") - 500 lbs

Faeron Metal Option Upcharges







	\$ List		\$ List
CAL 133 & Moisture Barrier (per yard)	64	Solid Surface Arm (per pair) - Gr A White	573
Ganging Bracket	58	Solid Surface Arm (per pair) - Gr A Color	598
Kinetic Back (not available for Plus)	120	Solid Surface Arm (per pair) - Gr B	645
21" & 24" Under-seat Splashguard	58	Solid Surface Arm (per pair) - Gr C	678
Removeable Seat Cover	90	Beech/Palette Wood Arm (per pair)	215
Removable Back Cover	58	See page 631 for color selection.	
Non-Marring Glides	16		
Combination upholstery - Dual	33		
Combination upholstery - Three	64		

See page 37 for Features and Options information.

Patient backs are available on Easy Access chairs, please change the model number FAE2M-HG to FAE2M-HP and add the following upcharges per back:

	Grade 1	Grade 2	Grade 3	Grade 4	Grade 5	Grade 6	Grade 7	Grade 8	Grade 9
21" Chairs	63	74	90	114	138	164	189	215	265
24" Chairs	68	81	94	119	144	170	195	220	271

FAERON METAL | EASY ACCESS CHAIR

DESCRIPTION/MODEL	COM		COL	FABRIC GRADES			LEATHER			
	1	2	3	4	5	6	7	8	9	
	21" Open Polymer Arm, Silver Metallic Frame FAE2M-HG21OPAS		1687	1735	1781	1879	1974	2070	2167	2263 2455
	21" Open Polymer Arm, Brushed Nickel Frame FAE2M-HG21OPAN		2235	2282	2329	2427	2522	2618	2715	2810 3003
	21" Semi Closed Polymer Arm, Silver Metallic Frame FAE2M-HG21SPAS		2118	2191	2263	2407	2552	2696	2840	2985 3273
	21" Semi Closed Polymer Arm, Brushed Nickel Frame FAE2M-HG21SPAN		2665	2739	2810	2955	3099	3244	3388	3533 3820
	21" Closed Polymer Arm, Silver Metallic Frame FAE2M-HG21CPAS		2132	2205	2277	2420	2565	2710	2853	2998 3287
	21" Closed Polymer Arm, Brushed Nickel Frame FAE2M-HG21CPAN		2680	2751	2823	2968	3113	3257	3402	3545 3834
	24" Open Polymer Arm, Silver Metallic Frame FAE2M-HG24OPAS		1717	1767	1816	1911	2007	2104	2197	2295 2487
	24" Open Polymer Arm, Brushed Nickel Frame FAE2M-HG24OPAN		2278	2326	2374	2471	2566	2661	2759	2853 3047
	24" Semi Closed Polymer Arm, Silver Metallic Frame FAE2M-HG24SPAS		2149	2221	2295	2438	2584	2727	2872	3015 3305
	24" Semi Closed Polymer Arm, Brushed Nickel Frame FAE2M-HG24SPAN		2710	2781	2853	2998	3142	3287	3431	3577 3865
	24" Closed Polymer Arm, Silver Metallic Frame FAE2M-HG24CPAS		2164	2236	2307	2452	2595	2741	2884	3030 3319
	24" Closed Polymer Arm, Brushed Nickel Frame FAE2M-HG24CPAN		2721	2794	2867	3011	3157	3299	3445	3588 3877

ORDERING NOTES:

Faeron Metal chairs can also be specified with a Wood Arm (WA) or a Solid Surface Arm (SA), replace "PA" in the model number with the **Arm Style** selection below and add the upcharge listed. See page 37 for Features and Options information.

Arm Style Option Upcharges

\$ List

Solid Surface Arm (per pair) - Gr A White	573
Solid Surface Arm (per pair) - Gr A Color	598
Solid Surface Arm (per pair) - Gr B	645
Solid Surface Arm (per pair) - Gr C	678
Beech/Palette Wood Arm (per pair)	215

PRODUCT CODE KEY

Line	Series	Chair Type	Size	Arm Type	Arm Style	Metal Finish
<input type="text" value="FAE"/> Faeron	<input type="text" value="2M"/> Chair	<input type="text" value="HG"/> Easy Access Guest Chair	<input type="text" value="21"/>	<input type="text" value="O"/> Open Arm	<input type="text" value="PA"/> Polymer Arm	<input type="text" value="S"/> Silver Metallic
		<input type="text" value="HP"/> Easy Access Patient Chair	<input type="text" value="24"/>	<input type="text" value="S"/> Semi Closed Arm	<input type="text" value="WA"/> Wood Arm	<input type="text" value="N"/> Brushed Nickel
				<input type="text" value="C"/> Closed Arm	<input type="text" value="SA"/> Solid Surface Arm	

JORDAN | ENVIRONMENTAL SUMMARY

LEED CI CREDITS



MATERIAL CONTENT:

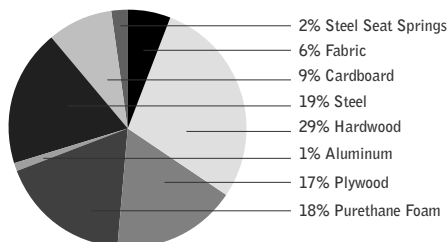

PRE-CONSUMER
RECYCLED CONTENT = 6%

POST-CONSUMER
RECYCLED CONTENT = 13%

Up to 28.7% of this Jordan product is recyclable at the end of its useful life.

CONTRIBUTES TO

CREDIT 2.1 - 2.2	Construction Waste Management	1-2 point(s)
CREDIT 3.3	Resource Reuse	1 point
CREDIT 4.1	Recycled Content	1 point
CREDIT 4.5	Low Emitting Materials, Systems & Seating	1 point
CREDIT 5.1	Regional Materials*	1 point
CREDIT 7	Certified Wood (MUST BE REQUESTED)	1 point(s)

*This credit is only applicable if in total 20% of the combined value of the procurement of construction materials and in the furniture are manufactured within a radius of 500 miles. This credit will apply if the installation of the finished product occurs within 500 miles of Kitchener, Ontario.

level® CERTIFICATION, AIR EMISSIONS AND FSC® CERTIFICATION



level® CERTIFICATION

BIFMA's e3 Furniture Sustainability Standard is a voluntary, multi-attribute standard that measures the degree of sustainability of furniture. This standard evaluates product and company environmental attributes and compliance systems in a wide range of elements which include Materials, Energy & Atmosphere, Human & Ecosystem Health and Social Responsibility. Jordan products have earned level®, BIFMA's sustainability certification program for furniture, certification through third-party verification against the e3 standard.

AIR-EMISSIONS

All Jordan products are supplied with air-emissions certified. Contact customer service for information.



FSC®

In 2005, Krug received Forest Stewardship Council® (FSC®) Chain-of-Custody certification for our manufacturing facilities. The FSC® Chain-of-Custody tracks certified wood from seedling to final sale. It verifies that the material for our FSC® certified products only come from well-managed, FSC®-certified forests and other controlled sources. FSC® is dedicated to the promotion of responsible forest management worldwide helping to take care of forests for future generations. Jordan and other Krug products can be specified with FSC® Certification. Contact customer service for further information, pricing and lead times.



Architects, designers, and building professionals can specify FSC®-certified products in order to achieve a point from the U.S. Green Building Council's Leadership in Energy and Environmental Design (LEED) Rating System.

JORDAN | EASY ACCESS CHAIR - DIMENSIONS & COM REQUIREMENTS

DIMENSIONS

	Overall Width	Overall Depth	Overall Height	Seat Height	Height of Arms from Floor	Footrest Height	Width Between Arms	Seat Depth	Shipping Weight	Cubes
21" Guest	25	28.25	40	24	32	6.75	20.5	19	49	21
24" Guest	28	28.25	40	24	32	6.75	23.5	19	53	21
21" Patient	25	28.25	49.25	24	32	6.75	20.5	19	54	26
24" Patient	28	28.25	49.25	24	32	6.75	23.5	19	58	26

COM YARDAGES - Guest Easy Access Chair

	COM Yardage Seat Only	COM Yardage Back Only	COM Yardage Seat & Back
21" & 24" Guest - One Chair	0.9	1.4	1.6
21" & 24" Guest - Two Chairs	1.3	2.8	3.2
21" & 24" Guest - Three Chairs	2.2	4.2	4.8
21" & 24" Guest - Four Chairs	2.6	5.6	6.4

COM YARDAGES - Patient Guest Easy Access Chair

	COM Yardage Seat Only	COM Yardage Back Only	COM Yardage Seat & Back
21" & 24" Patient - One Chair	0.9	1.9	2.2
21" & 24" Patient - Two Chairs	1.3	3.8	4.2
21" & 24" Patient - Three Chairs	2.2	5.7	6.3
21" & 24" Patient - Four Chairs	2.6	7.6	8.4

JORDAN | EASY ACCESS CHAIR

21" Guest

21" Patient



WEIGHT CAPACITIES

Jordan weight capacities are as follows:
Easy Access Chairs (21" & 24") - 350 lbs

Jordan Guest Option Upcharges

\$ List

\$ List

CAL 133 & Moisture Barrier (per yard)	64	Solid Surface Arm Cap (per pair) - Gr A White	452
Removable Seat Cover (per seat)	90	Solid Surface Arm Cap (per pair) - Gr A Color	458
21" & 24" Removeable Back Cover	58	Solid Surface Arm Cap (per pair) - Gr B	481
21" & 24" Cleanable Under-seat Splashguard	40	Solid Surface Arm Cap (per pair) - Gr C	507
21" & 24" Removeable Patient Back Cover	90		
Non-Marring Glide	37		
Combination upholstery - Dual	33		
Combination upholstery - Three	64		

See page 43 for Features and Options information.

JORDAN | EASY ACCESS CHAIR

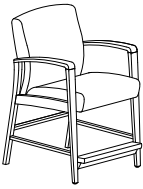
DESCRIPTION/MODEL	Species	COM		COL		FABRIC GRADES			LEATHER	
		1	2	3	4	5	6	7	8	9
	21" Guest, Open Arm									
	JOR2-HG21OPS Beech	1676	1724	1772	1872	1977	2080	2182	2283	2427
	JOR2-HG21OPS Maple	1788	1835	1882	1985	2087	2191	2294	2394	2538

	24" Guest, Open Arm									
	JOR2-HG24OPS Beech	1731	1778	1825	1928	2032	2134	2238	2341	2483
	JOR2-HG24OPS Maple	1835	1882	1928	2032	2134	2238	2341	2443	2586

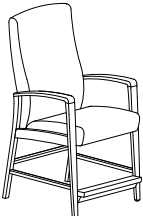
	21" Patient, Open Arm									
	JOR2-HP21OPS Beech	1803	1887	1977	2148	2324	2497	2671	2847	3099
	JOR2-HP21OPS Maple	1887	1977	2063	2238	2411	2586	2760	2933	3186

	24" Patient, Open Arm									
	JOR2-HP24OPS Beech	1852	1938	2024	2196	2373	2545	2718	2893	3145
	JOR2-HP24OPS Maple	1928	2017	2104	2278	2451	2625	2798	2971	3223

DESCRIPTION/MODEL	Price
 Metal Footrest Cap JOR2-RHFRC	80

ORDERING NOTES:

For **Urethane Arm Caps**, Please change the "S" in the model number to a "U" and add an upcharge of **\$130 list** per chair. See page 43 for Features and Options information, page 172 for option upcharges.

PRODUCT CODE KEY

Line	Series	Chair Type	Size	Arm Type
JOR Jordan	2 Chair	HG Easy Access Guest Chair	21	OPS Open Arm
		HP Easy Access Patient Chair	24	OPU Open Arm Urethane Arm Cap

LEED CI CREDITS



(COR5-11S)

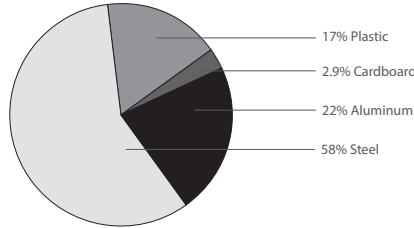

PRE-CONSUMER
RECYCLED CONTENT = 27.77%

POST-CONSUMER
RECYCLED CONTENT = 18.44%

Up to 86.71% of this Corfu product is recyclable at the end of its useful life.

CONTRIBUTES TO

CREDIT	CONTRIBUTES TO	POINTS
CREDIT 2.1 - 2.2	Construction Waste Management	1-2 point(s)
CREDIT 3.3	Resource Reuse	1 point
CREDIT 4.1	Recycled Content	1 point
CREDIT 4.2	Recycled Content	1 point
CREDIT 4.5	Low Emitting Materials, Systems & Seating	1 point
CREDIT 5.1	Regional Materials*	1 point
CREDIT 7	Certified Wood (MUST BE REQUESTED)	1 point(s)

*This credit is only applicable if in total 20% of the combined value of the procurement of construction materials and in the furniture are manufactured within a radius of 500 miles. This credit will apply if the installation of the finished product occurs within 500 miles of Kitchener, Ontario.

level® CERTIFICATION, AIR EMISSIONS AND FSC® CERTIFICATION



level® CERTIFICATION

BIFMA's e3 Furniture Sustainability Standard is a voluntary, multi-attribute standard that measures the degree of sustainability of furniture. This standard evaluates product and company environmental attributes and compliance systems in a wide range of elements which include Materials, Energy & Atmosphere, Human & Ecosystem Health and Social Responsibility. Corfu products have earned level®, BIFMA's sustainability certification program for furniture, certification through third-party verification against the e3 standard.

AIR-EMISSIONS

All Corfu products are supplied with air-emissions certified. Contact customer service for information.



FSC®

In 2005, Krug received Forest Stewardship Council® (FSC®) Chain-of-Custody certification for our manufacturing facilities. The FSC® Chain-of-Custody tracks certified wood from seedling to final sale. It verifies that the material for our FSC® certified products only come from well-managed, FSC®-certified forests and other controlled sources. FSC® is dedicated to the promotion of responsible forest management worldwide helping to take care of forests for future generations. Corfu and other Krug products can be specified with FSC® Certification. Contact customer service for further information, pricing and lead times.



Architects, designers, and building professionals can specify FSC®-certified products in order to achieve a point from the U.S. Green Building Council's Leadership in Energy and Environmental Design (LEED) Rating System.

CORFU | BARSTOOL - FEATURES & OPTIONS

SUSTAINABLE DESIGN

Corfu is made with recycled materials, with an overall recycled content of 40%. Many of these same materials are also recyclable. Corfu is air emissions certified.



WOOD FINISH

Krug's Enduraguard™ finish is a catalyzed conversion varnish topcoat, combined with a vinyl polymer-based sealer, that in independent testing has been shown to have exceptional durability characteristics in its resistance to scratching, marring, and degradation from cleaning materials and other substances.

BEECH PLYWOOD

Wood seats and backs are made with European Beech hardwood veneers, featuring nine (9) plies of cross grain for added strength and durability.

STEEL FRAME

Corfu seating is built with high strength steel castings and extrusions. Finish options are Silver Metallic and Chrome.



PLASTIC COMPONENTS

Polypropylene seats, backs and other components are injection molded, with pigment diffused throughout the mold, and featuring a compound that provides UV resistance to fading and brittleness from exposure to light. Seats and backs have a minimum wall thickness of 5 mm, providing excellent strength and shock resistance. Corfu (Plastic Seat & Back) is available in six different colors. Please specify a color when ordering.

Color Selection:

White, Black, Grey, Red, Blue, Sand



UNDER SEAT COVER

Each Corfu includes an under-seat system for stacking: a grey polypropylene seat pan that nests into the seat below and protects it from the frame above. It also provides for easy cleaning and maintenance by covering the underside of the chair.

OPTIONS

COMBINATION UPHOLSTERY OPTIONS

When combination upholstery is specified with fabric of the same grade or COM, an upcharge for dual fabrics is **\$33 list** per unit will be applied. When graded in combination upholstery is selected, use the highest grade upholstery selected or to obtain a quote for blended grading contact Customer Service (please provide the fabrics specified and location of where each fabric is to be applied on the product).

CAL 133 & MOISTURE BARRIER

California Technical Bulletin 133 is a flammability test for seating. Krug offers a compliance method which, in combination with non-flammable upholstery covers, may enable the products to meet certification requirements for this test. This process at the same time also provides the products with a Moisture Barrier - a treatment that helps to prevent the passage of liquids and moisture to inside of upholstered components - thereby conferring sanitary and anti-infection benefits. So when CAL 133 is specified, the product also automatically has a Moisture Barrier, and when a Moisture Barrier is specified, the product also features the compliance method and low flammability features of CAL 133. The application of this upcharge and the compliance method does not mean that the specific configuration of product and upholstery cover are tested and officially certified as being CAL 133 compliant. If official certification is required, Krug will provide this (through an independent certified testing laboratory) at a charge of \$917 per item, plus the cost of the product to be tested. Lead time for certification testing is typically 4-8 weeks. Krug assumes no responsibility for the testing of our products in combination with upholstery covers, or for the results of any testing conducted. Some specific configurations of product and upholstery have already been tested. Please contact Customer Service for additional information.

CORFU | BARSTOOL - DIMENSIONS & COM REQUIREMENTS

COM REQUIREMENTS

	COM Yardage Seat Pad Only	Yardage Per Chair - Seat Pad Only	COM Yardage Fully Upholstered Seat Only	Yardage Per Chair - Fully Upholstered Seat Only	COM Yardage Seat & Back Pads	Yardage Per Chair - Seat & Back Pads	COM Yardage Fully Upholstered Seat & Back	Yardage Per Chair - Fully Upholstered Seat & Back
One Chair	0.7	0.7	0.7	0.7	0.7	0.7	1	1
Two Chair	0.7	0.35	0.7	0.35	1.1	0.55	1.7	0.85
Three Chair	1.4	0.47	1.4	0.47	1.8	0.6	2.7	0.9
Four Chair	1.4	0.35	1.4	0.35	2.2	0.55	3.4	0.85

Note: Some vinyls, leathers & upholsteries are not suitable on Corfu seating.

The approval process is as follows:

1. A sample of the COM must be provided to Krug Customer Service prior to or at the time of order.
2. The sample will be reviewed and the customer advised if the upholstery cover is unsuitable.
3. The COM upholstery cover or leather will be inspected when received at the factory, to identify any further concerns with its suitability.





DIMENSIONS

	Overall Width	Overall Depth	Overall Height	Seat Height	Height of Arms from Floor	Width Between Arms	Seat Depth	Shipping Weight	Cube
COR5-10S	21.5	22.5	44.3	29.5	NA	NA	17.5	39	22
COR5-10C	21.5	22.5	44.3	29.5	NA	NA	17.5	39	22
COR5-11S	23	22.5	44.3	29.5	38.3	17.5	17.5	11	22
COR5-11C	23	22.5	44.3	29.5	38.3	17.5	17.5	11	22
COR5-20S	21.5	22.5	44.3	29.5	NA	NA	17.5	42	22
COR5-20C	21.5	22.5	44.3	29.5	NA	NA	17.5	42	22
COR5-21S	23	22.5	44.3	29.5	38.3	17.5	17.5	46	22
COR5-21C	23	22.5	44.3	29.5	38.3	17.5	17.5	46	22
COR5-30S	21.5	22.5	44.3	29.5	NA	NA	17.5	44	22
COR5-30C	21.5	22.5	44.3	29.5	NA	NA	17.5	44	22
COR5-31S	23	22.5	44.3	29.5	38.3	17.5	17.5	47	22
COR5-31C	23	22.5	44.3	29.5	38.3	17.5	17.5	47	22
COR5-40S	21.5	22.5	44.3	29.5	NA	NA	17.5	44	22
COR5-40C	21.5	22.5	44.3	29.5	NA	NA	17.5	44	22
COR5-41S	23	22.5	44.3	29.5	38.3	17.5	17.5	47	22
COR5-41C	23	22.5	44.3	29.5	38.3	17.5	17.5	47	22
COR5-50S	21.5	22.5	44.3	29.5	NA	NA	17.5	41	22
COR5-50C	21.5	22.5	44.3	29.5	NA	NA	17.5	41	22
COR5-51S	23	22.5	44.3	29.5	38.3	17.5	17.5	45	22
COR5-51C	23	22.5	44.3	29.5	38.3	17.5	17.5	45	22
COR5-60S	21.5	22.5	44.3	29.5	NA	NA	17.5	44	22
COR5-60C	21.5	22.5	44.3	29.5	NA	NA	17.5	44	22
COR5-61S	23	22.5	44.3	29.5	38.3	17.5	17.5	47	22
COR5-61C	23	22.5	44.3	29.5	38.3	17.5	17.5	47	22

WEIGHT CAPACITY

Corfu has been tested and complies with ANSI/BIFMA x5.1-2011 standards. Corfu has been load tested up to 350lbs.

CORFU | BARSTOOL

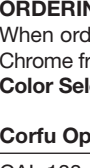
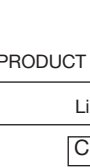
DESCRIPTION/MODEL	COM		COL		FABRIC GRADES			LEATHER	
	1	2	3	4	5	6	7	8	9
	Plastic Seat & Back, Armless, with Silver Metallic Frame								
	COR5-10S	878							
	Plastic Seat & Back, Armless, with Polished Chrome Frame								
	COR5-10C	1029							
	Plastic with Upholstered Seat & Back Pads, Armless, with Silver Metallic Frame								
	COR5-20S	1169	1186	1205	1242	1276	1314	1349	1386
	Plastic with Upholstered Seat & Back Pads, Armless, with Polished Chrome Frame								
	COR5-20C	1318	1335	1355	1391	1428	1463	1501	1536
	Plastic with Upholstered Seat & Back Pads, Plastic Arms, with Silver Metallic Frame								
	COR5-21S	1262	1281	1297	1333	1371	1407	1441	1480
	Plastic with Upholstered Seat & Back Pads, Polished Aluminum Arms, with Polished Chrome Frame								
	COR5-21C	1422	1440	1460	1494	1533	1567	1604	1641

ORDERING NOTES:

When ordering the Silver Metallic frame with Plastic Seat and Back, the arm color matches the seat and back. When ordering the Polished Chrome frame, arms are Polished Aluminum. Corfu (Plastic Seat & Back) is available in six different colors. Please specify a color when ordering.
Color Selection: White, Black, Grey, Red, Blue, Sand

Corfu Option Upcharges





\$ List

CAL 133 & Moisture Barrier (per yard)	64
Combination Upholstery - dual fabrics (per chair)	33

PRODUCT CODE KEY

Line	Series	Chair Style	Arm Style	Frame Finish
COR	5 Barstool	1 Plastic Seat & Back	0 Armless	S Silver Metallic
		2 Plastic with Upholstered Seat & Back Pads	1 Arms	C Polished Chrome
		3 Beech Wood Seat & Back		
		4 Fully Upholstered Seat & Back		
		5 Plastic Back, Plastic Seat with Upholstered Pad		
		6 Beech Wood Back, Fully Upholstered Seat		

CORFU | BARSTOOL

DESCRIPTION/MODEL	SPECIES	COM		COL			FABRIC GRADES			LEATHER	
		1	2	3	4	5	6	7	8	9	
	Plastic Back, Plastic Seat with Upholstered Pad, Armless, with Silver Metallic Frame COR5-50S	1116	1126	1137	1160	1180	1201	1222	1243	1285	
	Plastic Back, Plastic Seat with Upholstered Pad, Armless, with Polished Chrome Frame COR5-50C	1266	1275	1288	1309	1330	1351	1372	1393	1435	
	Plastic Back, Plastic Seat with Upholstered Pad, Plastic Arms with Silver Metallic Frame COR5-51S	1127	1138	1148	1169	1192	1213	1232	1254	1296	
	Plastic Back, Plastic Seat with Upholstered Pad, Polished Aluminum Arms, with Polished Chrome Frame COR5-51C	1371	1380	1391	1412	1434	1455	1477	1495	1539	
	Wood Seat & Back, Armless, with Silver Metallic Frame COR5-30S	Beech	1218								
	Wood Seat & Back, Armless, with Polished Chrome Frame COR5-30C	Beech	1292								
	Wood Seat & Back, Silver Metallic Arms, with Silver Metallic Frame COR5-31S	Beech	1342								
	Wood Seat & Back, Polished Aluminum Arms, with Polished Chrome Frame COR5-31C	Beech	1396								

ORDERING NOTES:

When ordering the Silver Metallic frame with Plastic Seat and Back, the arm color matches the seat and back. When ordering the Polished Chrome frame, arms are Polished Aluminum. Corfu (Plastic Seat & Back) is available in six different colors. Please specify a color when ordering.
Color Selection: White, Black, Grey, Red, Blue, Sand

Corfu Option Upcharges









\$ List

CAL 133 & Moisture Barrier (per yard)	64
Combination Upholstery - dual fabrics (per chair)	33

PRODUCT CODE KEY

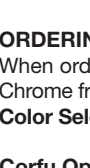
Line	Series	Chair Style	Arm Style	Frame Finish
COR	5 Barstool	1 Plastic Seat & Back	0 Armless	S Silver Metallic
		2 Plastic with Upholstered Seat & Back Pads	1 Arms	C Polished Chrome
		3 Beech Wood Seat & Back		
		4 Fully Upholstered Seat & Back		
		5 Plastic Back, Plastic Seat with Upholstered Pad		
		6 Beech Wood Back, Fully Upholstered Seat		

CORFU | BARSTOOL

DESCRIPTION/MODEL	SPECIES	COM		COL		FABRIC GRADES		LEATHER			
		1	2	3	4	5	6	7	8	9	
	Wood Back, Fully Upholstered Seat Armless, with Silver Metallic frame										
	COR5-60S Beech	1114	1127	1139	1163	1187	1212	1236	1260	1309	
	Wood Back, Fully Upholstered Seat Armless, with Polished Chrome frame										
	COR5-60C Beech	1190	1201	1213	1239	1262	1286	1310	1333	1381	
	Wood Back, Fully Upholstered Seat, Silver Metallic Arms, with Silver Metallic Frame										
	COR5-61S Beech	1240	1251	1263	1288	1311	1335	1359	1383	1433	
	Wood Back, Fully Upholstered Seat, Polished Aluminum Arms, with Polished Chrome Frame										
	COR5-61C Beech	1292	1306	1317	1341	1367	1390	1414	1438	1487	
	Fully Upholstered Seat & Back, Armless, with Silver Metallic Frame										
	COR5-40S	1124	1151	1177	1227	1281	1331	1381	1434	1536	
	Fully Upholstered Seat & Back, Armless, with Polished Chrome Frame										
	COR5-40C	1199	1224	1251	1303	1354	1404	1456	1507	1610	
	Fully Upholstered Seat & Back, Silver Metallic Arms, with Silver Metallic Frame										
	COR5-41S	1249	1273	1302	1352	1403	1455	1506	1557	1660	
	Fully Upholstered Seat & Back, Polished Aluminum Arms, with Polished Chrome Frame										
	COR5-41C	1304	1330	1355	1405	1458	1509	1560	1612	1714	

ORDERING NOTES:

When ordering the Silver Metallic frame with Plastic Seat and Back, the arm color matches the seat and back. When ordering the Polished Chrome frame, arms are Polished Aluminum. Corfu (Plastic Seat & Back) is available in six different colors. Please specify a color when ordering.
Color Selection: White, Black, Grey, Red, Blue, Sand

Corfu Option Upcharges \$ List

CAL 133 & Moisture Barrier (per yard)	64
Combination Upholstery - dual fabrics (per chair)	33

PRODUCT CODE KEY

Line	Series	Chair Style	Arm Style	Frame Finish
COR	5 Barstool	1 Plastic Seat & Back	0 Armless	S Silver Metallic
		2 Plastic with Upholstered Seat & Back Pads	1 Arms	C Polished Chrome
		3 Beech Wood Seat & Back		
		4 Fully Upholstered Seat & Back		
		5 Plastic Back, Plastic Seat with Upholstered Pad		
		6 Beech Wood Back, Fully Upholstered Seat		

LOUNGE SEATING

181 Cressida
191 Leyton
206 Zola
223 Zola Privacy
289 Faeron
314 Jordan
320 Carlyle

CRESSIDA | ENVIRONMENTAL SUMMARY

LEED CI CREDITS



MATERIAL CONTENT:

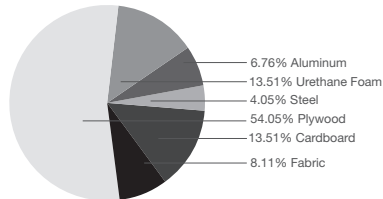

PRE-CONSUMER
RECYCLED CONTENT - 4.22%

POST-CONSUMER
RECYCLED CONTENT - 14.49%

Up to 24.32% of this Cressida product is recyclable at the end of its useful life.

CONTRIBUTES TO

CREDIT 2.1 - 2.2	Construction Waste Management	1-2 point(s)
CREDIT 3.3	Resource Reuse	1 point
CREDIT 4.1	Recycled Content	1 point
CREDIT 4.5	Low Emitting Materials, Systems & Seating	1 point
CREDIT 5.1	Regional Materials*	1 point
CREDIT 7	Certified Wood (MUST BE REQUESTED)	1 point(s)

level® CERTIFICATION, AIR EMISSIONS AND FSC® CERTIFICATION



level® CERTIFICATION

BIFMA's e3 Furniture Sustainability Standard is a voluntary, multi-attribute standard that measures the degree of sustainability of furniture. This standard evaluates product and company environmental attributes and compliance systems in a wide range of elements which include Materials, Energy & Atmosphere, Human & Ecosystem Health and Social Responsibility. Cressida products have earned level®, BIFMA's sustainability certification program for furniture, certification through third-party verification against the e3 standard.

AIR-EMISSIONS

All Cressida products are supplied with air-emissions certified. Contact customer service for information.



FSC®

In 2005, Krug received Forest Stewardship Council® (FSC®) Chain-of-Custody certification for our manufacturing facilities. The FSC® Chain-of-Custody tracks certified wood from seedling to final sale. It verifies that the material for our FSC® certified products only come from well-managed, FSC®-certified forests and other controlled sources. FSC® is dedicated to the promotion of responsible forest management worldwide helping to take care of forests for future generations. Cressida and other Krug products can be specified with FSC® Certification. Contact customer service for further information, pricing and lead times.



Architects, designers, and building professionals can specify FSC®-certified products in order to achieve a point from the U.S. Green Building Council's Leadership in Energy and Environmental Design (LEED) Rating System.

CRESSIDA | LOUNGE FEATURES & OPTIONS



CLEAN OUT

Cressida lounge seating models have a built-in clean out feature: a space at the back of the seat that allows dirt, debris and liquid to fall to the floor for easy clean up and maintenance - designed so that it does not detract from the comfort or appearance of the product.



ARMS AND ARMLESS

Cressida features five arm options; Armless, Open Arm, Open Arm Polymer Arm Cap, Closed Arm, Closed Arm Polymer Arm Cap. Polymer arm cap is available in Black or Grey.



POLYMER ARM CAP

Available in Grey and Black colors, the Arm Cap is field-replaceable if necessary.



PUSH BAR

This is an option on Cressida lounge when ordered with casters, ergonomically designed to assist care-giving staff in the movement and operation of the chair, and reduce back strain on the caregiver. The push bar is powder-coated steel in Silver Metallic finish.



TABLETS

Optional Tablets are available on the Cressida Lounge & Modular in veneer, glass, high pressure laminate, solid surface and palette finishes. The Cressida tablet can be fastened to the Cressida Lounge & Modular chairs by the Universal Tablet Mount (mounted left or right), to existing legs and features an elliptical shape of 16 1/2" x 11 1/2" x 3/4" in size. The Cressida Tablet has a turning radius of 360 degrees, which accommodates any worksurface angle.

PLUS UPGRADE

Cressida seating is available with optional Plus Upgrade. Plus Upgraded seating has been engineered to support higher weight capacities, accommodating a wider variety of users.

GLIDES

Cressida Lounge arm and armless versions are standard with nylon glides.

LATEX FREE

Krug products are made with latex-free materials to prevent the allergic reaction that latex causes in some people.

WEIGHT CAPACITIES

Cressida weight capacities are as follows:

- One-Seat-350 lbs
- One-Seat (Plus) - 750 lbs
- One-Seat Wide - 350lbs
- One-Seat Wide (Plus) - 750lbs
- Two-Seat - 525 lbs
- Two-Seat (Plus) - 975lbs
- Three-Seat - 850 lbs
- Three-Seat (Plus) - 1200 lbs

FINISH DURABILITY

The Krug Enduraguard finish, a proprietary catalyzed varnish formulation, has been repeatedly shown, through independent laboratory testing, to be the industry leader in durability and abrasion resistance. The Krug finish looks better longer than competitors, and is uniquely suited to the demands of healthcare environments.

REPLACEABLE COMPONENTS

Cressida Lounge chairs are uniquely designed to allow virtually all components to be field replaced, providing a very cost effective means to significantly extend the life of the product. Seats, backs and arms are field replaceable.

OPTIONS



CASTERS

Cressida Lounge is available with the option of casters. Caster option comes with the two rear casters locking as standard.

COMBINATION UPHOLSTERY OPTIONS

When combination upholstery is specified with fabric of the same grade or COM, an upcharge for dual fabrics is **\$33 list** per unit and **\$64 list** per unit for three fabrics will be applied. When graded in combination upholstery is selected, use the highest grade upholstery selected or to obtain a quote for blended grading contact Customer Service (please provide the fabrics specified and location of where each fabric is to be applied on the product).

MOISTURE BARRIER & CAL 133

California Technical Bulletin 133 is a flammability test for seating. Krug offers a compliance upholstery covers, may enable products to meet certification requirements for this test. This process at the same time also provides the products with a Moisture Barrier - a treatment that helps to prevent the passage of liquids and moisture to inside of the upholstered components - thereby conferring sanitary and anti-infection benefits. So when CAL 133 is specified, the product also automatically has a Moisture Barrier, and when a Moisture Barrier is specified, the product also features the compliance method and low flammability features of CAL 133. The application of this up-charge and the compliance method does not mean that the specific configuration of product and upholstery cover are tested and officially certified as being CAL133 compliant. If the official certification is required, Krug will provide this (through an independent certified testing laboratory) at a charge of \$917 per item, plus the cost of the product to be tested. Lead time for certification testing is typically 4-8 weeks. Moisture Barrier & CAL 133 is available for an upcharge of **\$64 list** per yard.

REMOVABLE AND REPLACEABLE COVERS

Cressida Lounge Chairs are available with removable seat and back covers.

Cressida Images | www.krug.ca

CRESSIDA | LOUNGE

DIMENSIONS & COM REQUIREMENTS

	Overall Width	Overall Depth	Overall Height	Seat Height	Height of Arms from Floor	Width Between Arms	Seat Depth	Shipping Weight Open Arm	Shipping Weight Closed Arm	Cube
WITH ARMS										
One-Seat	29.5	30.5	32.5	17.25	25.75	23	19.75	52	74	22
One-Seat Wide	36.5	30.5	32.5	17.25	25.75	30	19.75	62	84	34
Two-Seat	52.25	30.5	32.5	17.25	25.75	45.75	19.75	81	103	34
Three-Seat	75	30.5	32.5	17.25	25.75	68.5	19.75	104	126	49
ARMLESS										
One-Seat	23	30.5	32.5	17.25	-	-	19.75	47	-	22
One-Seat Wide	30	30.5	32.5	17.25	-	-	19.75	57	-	34
Two-Seat	45.75	30.5	32.5	17.25	-	-	19.75	76	-	34
Three-Seat	68.75	30.5	32.5	17.25	-	-	19.75	99	-	49

Note: Cressida plus two-seat and three-seat units have the same dimensions as the regular two-seat and three-seat units.

COM - YARDAGE REQUIREMENTS

	COM Yardage Seat, Back & Arms	COM Yardage Seat & Back	COM Yardage Seat Only	COM Yardage Back Only	COM Yardage Closed Arms (2) Only
One-Seat - One Chair	5	2.7	1.27	1.83	2.9
One-Seat - Two Chairs	9.7	5	2.03	2.7	5.8
One-Seat - Three Chairs	14.7	7.75	3.57	4.53	8.7
One-Seat - Four Chairs	15.4	10	4.06	5.4	11.6
One-Seat Wide - One Chair	6.4	3.5	1.64	1.9	2.9
One-Seat Wide - Two Chairs	12.8	7	3.28	3.8	5.8
One-Seat Wide - Three Chairs	19.2	10.5	4.92	5.7	8.7
One-Seat Wide - Four Chairs	25.6	14	6.56	7.6	11.6
Two-Seat - One Chair	6.4	4	1.7	2.7	2.9
Two-Seat - Two Chairs	12.8	8	3.4	4.6	5.8
Two-Seat - Three Chairs	19.2	12	5.1	7.3	8.7
Two-Seat - Four Chairs	25.6	16	6.8	9.2	11.6
Three-Seat - One Chair	7.6	5.5	2.6	3.4	2.9
Three-Seat - Two Chairs	15.2	11	4.6	6.4	5.8
Three-Seat - Three Chairs	22.8	16.5	7.2	9.8	8.7
Three-Seat - Four Chairs	30.4	22	9.2	12.8	11.6

Note: Some vinyls, leathers & upholsteries are not suitable for application on Cressida seating. Please refer to page 628 for C.O.M approval process.

Cressida Lounge Option Upcharges	\$ List	\$ List
Moisture Barrier (per yard)	64	One-Seat Removable Back Covers
Push Bar	64	One-Seat Wide Removable Back Covers
Caster Combination (2 legs & 2 rear casters)	152	Two-Seat Removable Back Covers
Castors (set of 4)	228	Three-Seat Removable Back Covers
One-Seat Removable Seat Covers	152	One-Seat - Plus Upgrade
One-Seat Wide Removable Seat Covers	228	One-Seat Wide - Plus Upgrade
Two-Seat Removable Seat Covers	302	Two-Seat - Plus Upgrade
Three-Seat Removable Seat Covers	453	Three-Seat - Plus Upgrade

NOTE: Caster options are available for One-Seat size only, and cannot be combined with the Plus Upgrade option.

CRESSIDA | LOUNGE

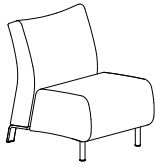
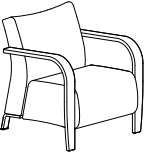
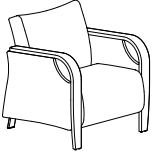
DESCRIPTION/MODEL/SPECIES	COM		COL	FABRIC GRADES			LEATHER		
	1	2	3	4	5	6	7	8	9
 One-Seat, Armless CRE3-F1ALS1 n/a	1566	1647	1747	1875	2018	2145	2287	2470	2650
 One-Seat, Open Arm CRE3-F1OPS1 Beech, Maple Palette	1801	1897	1988	2103	2252	2394	2536	2703	2891
One-Seat, Open Arm with arm cap CRE3-F1OPP1 Beech, Maple Palette	1875	1974	2063	2174	2326	2470	2612	2778	2966
 One-Seat, Closed Arm CRE3-F1CLS1 Beech, Maple Palette	2523	2686	2853	3088	3357	3591	3862	4203	4532
One-Seat, Closed Arm with arm cap CRE3-F1CLP1 Beech, Maple Palette	2596	2764	2928	3162	3432	3666	3936	4277	4608

ORDERING NOTES:

All Cressida lounge are capable of being upgraded to Plus weight capacity. To order please add a "B" after the 4th digit / before the size, and add appropriate upcharge below.

Example: One-Seat – Open Arm = CRE3-F10PS1, to upgrade to Plus add a "B" = CRE3-FB10PS1

Cressida Lounge Option Upcharges	\$ List		\$ List
Moisture Barrier (per yard)	64	One-Seat Removable Seat Covers	152
Push Bar	64	One-Seat Removable Back Covers	152
Caster Combination (2 legs & 2 rear casters)	152	One-Seat - Plus Upgrade	92
Casters (set of 4)	228		
Combination Upholstery - dual fabrics	33		
Combination Upholstery -Three fabrics	64		

NOTE: Caster options are available for One-Seat size only, and cannot be combined with the Plus Upgrade option.

PRODUCT CODE KEY

Line	Series	Chair Style	Size	Arm Style	Leg Style
CRE Cressida	3 Lounge	F Freestanding	1 One-Seat	ALS Armless	1 Legs
		FB Freestanding Plus	1.5 One-Seat Wide	OPS Open Arm	2 Casters
			2 Two-Seat	OPP Open Arm Polymer Arm Cap	3 Caster Combination 2 legs & 2 Rear Casters
			3 Three-Seat	CLS Closed Arm	
				CLP Closed Arm Polymer Arm Cap	

CRESSIDA | LOUNGE

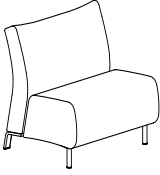
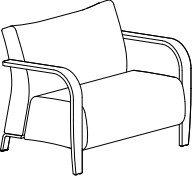
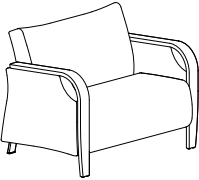
DESCRIPTION/MODEL/SPECIES	COM		COL	FABRIC GRADES			LEATHER		
	1	2	3	4	5	6	7	8	9
 One-Seat Wide, Armless CRE3-FB1.5ALS1 n/a	1657	1765	1872	2026	2198	2353	2527	2744	2963
 One-Seat Wide, Open Arm CRE3-FB1.5OPS1 Beech, Maple Palette	1923	2031	2140	2294	2466	2620	2794	3013	3232
One-Seat Wide, Open Arm with arm cap CRE3-FB1.5OPP1 Beech, Maple Palette	1998	2107	2217	2369	2542	2705	2870	3090	3307
 One-Seat Wide, Closed Arm CRE3-FB1.5CLS1 Beech, Maple Palette	2639	2824	3011	3271	3568	3829	4128	4494	5159
One-Seat Wide, Closed Arm with arm cap CRE3-FB1.5CLP1 Beech, Maple Palette	2715	2899	3088	3346	3644	3906	4204	4570	5235

ORDERING NOTES:

All Cressida lounge are capable of being upgraded to Plus weight capacity. To order please add a "B" after the 4th digit / before the size, and add appropriate upcharge below.

Example: One-Seat – Open Arm = CRE3-F10PS1, to upgrade to Plus add a "B" = CRE3-FB10PS1

Cressida Lounge Option Upcharges \$ List

Moisture Barrier (per yard)	64
One-Seat Wide - Plus Upgrade	121
One-Seat Wide Removable Seat Covers	228
One-Seat Wide Removable Back Covers	228
Combination Upholstery - dual fabrics	33
Combination Upholstery -Three fabrics	64

NOTE: One-Seat Wide Lounge is not available with caster options.

PRODUCT CODE KEY

Line	Series	Chair Style	Size	Arm Style	Leg Style
CRE Cressida	3 Lounge	F Freestanding	1 One-Seat	ALS Armless	1 Legs
		FB Freestanding Plus	1.5 One-Seat Wide	OPS Open Arm	
			2 Two-Seat	OPP Open Arm Polymer Arm Cap	
			3 Three-Seat	CLS Closed Arm	
				CLP Closed Arm Polymer Arm Cap	

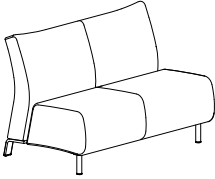
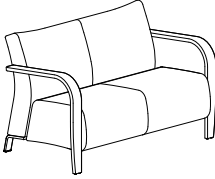
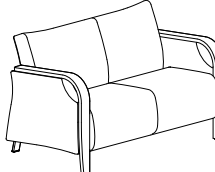
DESCRIPTION/MODEL/SPECIES	COM		COL	FABRIC GRADES			LEATHER		
	1	2	3	4	5	6	7	8	9
 Two-Seat, Armless CRE3-F2ALS1 n/a	2590	2726	2853	3049	3260	3448	3666	3931	4203
 Two-Seat, Open Arm CRE3-F2OPS1 Beech, Maple Palette	2823	2958	3095	3283	3499	3688	3899	4171	4442
Two-Seat, Open Arm with arm cap CRE3-F2OPP1 Beech, Maple Palette	2898	3035	3167	3357	3577	3763	3975	4245	4515
 Two-Seat, Closed Arm CRE3-F2CLS1 Beech, Maple Palette	3545	3757	3966	4261	4600	4893	5232	5660	6081
Two-Seat, Closed Arm with arm cap CRE3-F2CLP1 Beech, Maple Palette	3620	3830	4041	4336	4675	4968	5307	5738	6158

ORDERING NOTES:

All Cressida lounge are capable of being upgraded to Plus weight capacity. To order please add a "B" after the 4th digit / before the size, and add appropriate upcharge below.

Example: One-Seat – Open Arm = CRE3-F10PS1, to upgrade to Plus add a "B" = CRE3-FB10PS1

Cressida Lounge Option Upcharges \$ List

Moisture Barrier (per yard)	64
Two-Seat - Plus Upgrade	199
Two-Seat Removable Seat Covers	290
Two-Seat Removable Back Covers	290
Combination Upholstery - dual fabrics	33
Combination Upholstery -Three fabrics	64

NOTE: Two-Seat Lounge is not available with caster options

PRODUCT CODE KEY

Line	Series	Chair Style	Size	Arm Style	Leg Style
CRE Cressida	3 Lounge	F Freestanding	1 One-Seat	ALS Armless	1 Legs
		FB Freestanding Plus	1.5 One-Seat Wide	OPS Open Arm	
			2 Two-Seat	OPP Open Arm Polymer Arm Cap	
			3 Three-Seat	CLS Closed Arm	
				CLP Closed Arm Polymer Arm Cap	

CRESSIDA | LOUNGE

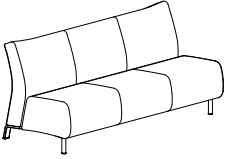
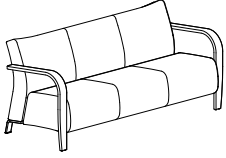
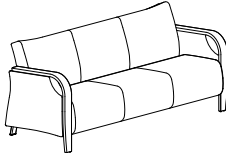
DESCRIPTION/MODEL/SPECIES	COM		COL	FABRIC GRADES			LEATHER		
	1	2	3	4	5	6	7	8	9
 Three-Seat, Armless CRE3-F3ALS1 n/a	3516	3706	3885	4141	4442	4697	4992	5361	5727
 Three-Seat, Open Arm CRE3-F3OPS1 Beech, Maple Palette	3757	3936	4127	4381	4675	4939	5232	5602	5969
Three-Seat, Open Arm with arm cap CRE3-F3OPP1 Beech, Maple Palette	3830	4011	4203	4381	4750	5012	5307	5677	6045
 Three-Seat, Closed Arm CRE3-F3CLS1 Beech, Maple Palette	4471	4735	4998	5361	5782	6149	6565	7091	7611
Three-Seat, Closed Arm with arm cap CRE3-F3CLP1 Beech, Maple Palette	4546	4812	5075	5436	5857	6225	6640	7164	7684

ORDERING NOTES:

All Cressida lounge are capable of being upgraded to Plus weight capacity. To order please add a "B" after the 4th digit / before the size, and add appropriate upcharge below.

Example: One-Seat – Open Arm = CRE3-F10PS1, to upgrade to Plus add a "B" = CRE3-FB10PS1

Cressida Lounge Option Upcharges \$ List

Moisture Barrier (per yard)	64
Three-Seat - Plus Upgrade	228
Three-Seat Removable Seat Covers	453
Three-Seat Removable Back Covers	453
Combination Upholstery - dual fabrics	33
Combination Upholstery -Three fabrics	64

NOTE: Three-Seat Lounge is not available with caster options



PRODUCT CODE KEY

Line	Series	Chair Style	Size	Arm Style	Leg Style
CRE Cressida	3 Lounge	F Freestanding	1 One-Seat	ALS Armless	1 Legs
		FB Freestanding Plus	1.5 One-Seat Wide	OPS Open Arm	
			2 Two-Seat	OPP Open Arm Polymer Arm Cap	
			3 Three-Seat	CLS Closed Arm	
				CLP Closed Arm Polymer Arm Cap	

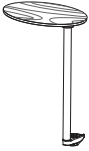
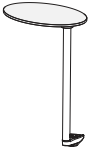
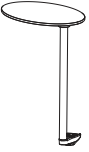
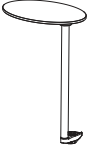

CRESSIDA | TABLET

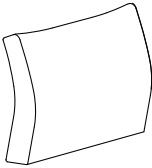
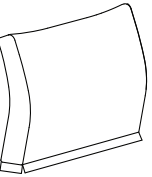
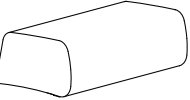
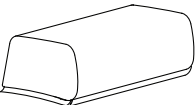
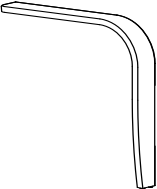
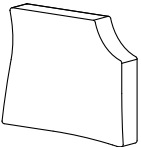
DESCRIPTION	MODEL	SPECIES	PRICE	WEIGHT	CUBE								
	Wood Tablet CRE3 T1	Beech/Maple	589	12	2								
	Tablet with Palette Finish CRE3 T2	n/a	437	12	2								
	Laminate Tablet CRE3 T4	n/a	589	12	2								
	ORDERING NOTES: The laminate tablet comes standard with a polymer edge. Please note Cressida Tablets need to be specified right or left when ordering.												
	Solid Surface Tablet CRE3 RT3		<table border="1"> <thead> <tr> <th>A-White</th> <th>Grades A-Color</th> <th>B</th> <th>C</th> </tr> </thead> <tbody> <tr> <td>673</td> <td>686</td> <td>721</td> <td>781</td> </tr> </tbody> </table>	A-White	Grades A-Color	B	C	673	686	721	781	12	2
A-White	Grades A-Color	B	C										
673	686	721	781										

CRESSIDA | REPLACEMENT LOUNGE COMPONENTS

DESCRIPTION	MODEL	COM		COL 3	FABRIC GRADES			LEATHER			WEIGHT	CUBE
		1	2		4	5	6	7	8	9		
	One-Seat Replacement Back CRE3-RB1	715	778	837	922	1021	1108	1205	1330	1451	23	4.2
	One-Seat Wide Replacement Back CRE3-RB1.5B	808	872	935	1026	1126	1215	1317	1446	1570	28	5.7
	Two-Seat Replacement Back CRE3-RB2	1058	1146	1237	1363	1509	1636	1779	1962	2143	38	8.8
	Three-Seat Replacement Back CRE3-RB3	1414	1528	1642	1802	1984	2143	2324	2554	2780	52	12
	One-Seat Replacement Back Cover CRE3-RBC1	290	348	410	494	595	679	780	901	1026	2.0	1.0
	One-Seat Wide Replacement Back Cover CRE3-RBC1.5	302	365	428	517	620	710	810	939	1065	2.5	1.2
	Two-Seat Replacement Back Cover CRE3-RBC2	403	492	584	710	853	982	1126	1307	1487	3.5	1.8
	Three-Seat Replacement Back Cover CRE3-RBC3	463	577	693	851	1033	1194	1376	1604	1833	5.0	2.5
	One-Seat Replacement Seat CRE3-RS1	603	648	693	752	821	883	954	1039	1126	28	9.5
	One-Seat Wide Replacement Seat CRE3-RS1.5	782	838	892	971	1060	1137	1226	1334	1446	35	12.0
	Two-Seat Replacement Seat CRE3-RS2	939	995	1054	1135	1224	1304	1394	1509	1622	53	18
	Three-Seat Replacement Seat CRE3-RS3	1257	1345	1431	1555	1691	1813	1954	2130	2302	79	24
	One-Seat Replacement Seat Cover CRE3-RSC1	208	253	297	357	427	487	559	644	731	2.0	1.0
	One-Seat Wide Replacement Seat Cover CRE3-RSC1.5	259	313	369	448	536	613	701	811	922	2.5	1.2
	Two-Seat Replacement Seat Cover CRE3-RSC2	276	334	390	471	561	641	732	846	959	3.5	1.8
	Three-Seat Replacement Seat Cover CRE3-RSC3	352	438	527	648	785	909	1048	1224	1396	5.0	2.5
	Replacement Lounge Front Arm & Leg Open Arm CRE3-LROPS Beech, Maple Palette	185									4.0	1.3
	Open Arm Polymer Cap CRE3-LROPP Beech, Maple Palette	223										
	Replacement Closed Arm Panel CRE3-RCA Beech, Maple	406	454	502	569	648	716	794	892	988	20	3.8
	Lounge Replacement Push-Bar CRE3-RPB	61									2	0.3

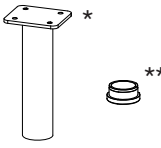
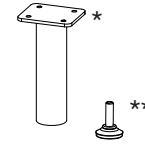
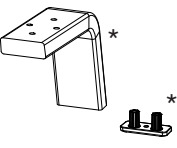
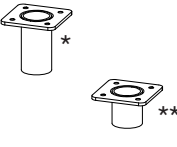
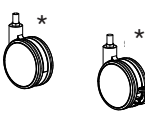
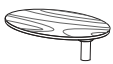
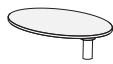
CRESSIDA | LOUNGE & TABLE REPLACEMENT COMPONENTS

DESCRIPTION	MODEL	PRICE	WEIGHT CUBE		
	Replacement Polymer Arm Cap Black CRE3-RACB	38	1.0	0.5	
	Replacement Polymer Arm Cap Grey CRE3-RACB	38			
	Lounge Replacement Front Leg (for armless version) CRE3-RLAF*	59	0.5	0.5	
	Lounge Replacement Front Leg (for armless version) Glide CRE3-RGAF**	18	0.1	0.2	
	Lounge Replacement Plus Upgrade Center Leg CRE3-RLC*	54	0.5	0.5	
	Lounge Replacement Plus Upgrade Center Leg Glide CRE3-RCG**	23	0.5	0.5	
	Lounge Replacement Back Leg CRE3-RLB*	78	1.8	0.5	
	Lounge Replacement Glide CRE3-RGB**	19	0.1	0.2	
	Lounge Replacement Front Leg (for caster version) CRE3-RLCF*	54	0.5	0.5	
	Lounge Replacement Back Leg (for caster version) CRE3-RLCB**	54	0.5	0.5	
	Replacement Casters Non-Locking CRE3-RC1*	74	.75	0.3	
	Replacement Casters Locking CRE3-RC2**	74	.75	0.3	
	Wood Tablet & Mounting Plate Only CRE3 RT1 Beech/Maple	397	5	0.32	
	Tablet with Palette finish & Mounting Plate Only CRE3 RT2 n/a	278	5	0.32	
	Tablet & Mounting Plate Only - Solid Surface CRE3 RT3 n/a	A-White	7	0.32	
		Grades A-Color			
		B	C		
		539	547	577	624
	Laminate Tablet & Mounting Plate Only CRE3 RT4 n/a	397	5	0.32	

LEYTON | ENVIRONMENTAL SUMMARY

LEED CI CREDITS



MATERIAL CONTENT:

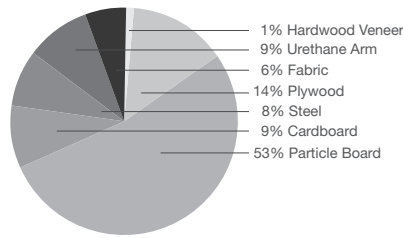

PRE-CONSUMER
RECYCLED CONTENT = 28.61%

POST-CONSUMER
RECYCLED CONTENT = 9.91%

Up to 8.81% of this Leyton product is recyclable at the end of its useful life.

CONTRIBUTES TO

CREDIT 2.1 - 2.2	Construction Waste Management	1-2 point(s)
CREDIT 3.3	Resource Reuse	1 point
CREDIT 4.1	Recycled Content	1 point
CREDIT 4.2	Recycled Content	1 point
CREDIT 4.5	Low Emitting Materials, Systems & Seating	1 point
CREDIT 5.1	Regional Materials*	1 point
CREDIT 7	Certified Wood (MUST BE REQUESTED)	1 point(s)

*This credit is only applicable if in total 20% of the combined value of the procurement of construction materials and in the furniture are manufactured within a radius of 500 miles. This credit will apply if the installation of the finished product occurs within 500 miles of Kitchener, Ontario.

level® CERTIFICATION, AIR EMISSIONS AND FSC® CERTIFICATION



level® CERTIFICATION

BIFMA's e3 Furniture Sustainability Standard is a voluntary, multi-attribute standard that measures the degree of sustainability of furniture. This standard evaluates product and company environmental attributes and compliance systems in a wide range of elements which include Materials, Energy & Atmosphere, Human & Ecosystem Health and Social Responsibility. Leyton products have earned level®, BIFMA's sustainability certification program for furniture, certification through third-party verification against the e3 standard.

AIR-EMISSIONS

All Leyton products are supplied with air-emissions certified. Contact customer service for information.



FSC®

In 2005, Krug received Forest Stewardship Council® (FSC®) Chain-of-Custody certification for our manufacturing facilities. The FSC® Chain-of-Custody tracks certified wood from seedling to final sale. It verifies that the material for our FSC® certified products only come from well-managed, FSC®-certified forests and other controlled sources. FSC® is dedicated to the promotion of responsible forest management worldwide helping to take care of forests for future generations. Leyton and other Krug products can be specified with FSC® Certification. Contact customer service for further information, pricing and lead times.



Architects, designers, and building professionals can specify FSC®-certified products in order to achieve a point from the U.S. Green Building Council's Leadership in Energy and Environmental Design (LEED) Rating System.

LEYTON | FINISHES & FEATURES

WOOD FINISHES

Standard wood finishes are:

SPECIES	FINISH
OAK	Light Oak
	SilverGrey on Oak
	Espresso Oak
	Harvest Oak
	Mahogany
Mellow oak	
MAPLE	Clear Maple
	Honey Maple
	Wheat Maple
WALNUT	Natural Walnut
	SilverGrey on Walnut
	Regular Walnut
	Dark Walnut
	Cordovan Walnut
CHERRY	Appalachian Cherry
	American Cherry
	Imperial Cherry
	Sable Cherry
	Light Cherry
	Medium Cherry
	Natural Cherry
	Standard Cherry
ANIGRE	Clear Anigre
	Medium Anigre
SYCAMORE	Clear Sycamore

Please note Cherry, Anigre and Sycamore species require a minimum quantity order, of 5 units for seating and 5 units for tables, per species.

PALETTE	
	Black
	White
	Sand
	Soft Green
	Steel Blue
	Slate

VENEERS

Leyton veneers are quarter cut, except for White Oak, which is rift cut - both quarter cut and rift cut veneers provide a straight grain appearance. The grain direction of the veneers on vertical faces is horizontal.

NON-STANDARD VENEER SPECIES

In addition to range of standard wood species, Leyton can be made with virtually any commercially available veneers. Please contact customer service for information and pricing on wood species not included in Leyton's standard offering.

NATURAL CHARACTERISTICS OF WOOD

Wood is a natural product with inherent color variations that will never be fully mitigated by the finishing process. Please anticipate variation in colors within a single unit, from piece to piece, and from Krug wood finish samples. If a very close match is required, a sample must be provided with the order and an upcharge will apply. Exact color matches are not possible.

CUSTOM WOOD FINISHES

Add 10% list to your order for special finishes, minimum upcharge is \$500 list per finish per order. (For example, on all orders up to \$5000 list, an upcharge of \$500 will apply, on orders \$5000 and up add 10% list to your order.)

For orders with special finishes, a sample that is a minimum 3" by 3" must be received with the order. Special finishes may add additional lead time to production schedules.

ENDURAGUARD FINISH

Leyton features the Krug finish, a proprietary catalyzed varnish formulation, that has repeatedly shown through independent laboratory testing to be the industry leader in durability and abrasion resistance. The Krug finish looks better longer than competitors and is uniquely suited to the demands of high traffic environments.

IN-STOCK LAMINATE

Krug's in-stock laminates are available on Leyton Table surfaces in 4 solid laminate selections. Laminate surfaces are self-edged.

SOLID LAMINATES

Designer White - Platinum - Earth - Charcoal

LEYTON | FEATURES



ARM STYLE

Leyton features four design styles Upholstered Armless, Upholstered Full Arm, Wood Surround Armless and Wood Surround Full Arm.

Upholstered Armless



Upholstered Full Arm



Wood Surround Armless



Wood Surround Full Arm

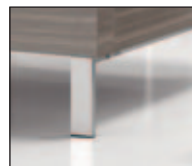

LEGS

Leyton Lounge and Tables feature Polished Chrome structural steel legs with Black glides. Non-marring glides are available upon request.

REPLACEABLE COMPONENTS

Leyton chairs are uniquely designed to allow major components to be field replaced, providing a very cost effective means to significantly extend the life of the product. Seats, backs, arms and frames are field replaceable, with the only exceptions being the Upholstered Armless, Upholstered Full Arm and Upholstered Front Panel as it is one piece.

WEIGHT CAPACITIES

All Leyton seating feature Plus Weight capacities.
 One-Seat - 750lbs
 One-seat Wide - 750lbs
 Two-Seat - 975lbs
 Three-Seat - 1200lbs
 Leyton has been tested to ANSI / BIFMA.

PLUS UPGRADE

Leyton models feature Plus Upgrade. Plus Upgraded seating has been engineered to support higher weight capacities, accommodating a wider variety of users.

LEYTON | OPTIONS

OPTIONS

Solid Surface Arm Cap

Leyton Lounge Full Arm version is available with an optional Solid Surface Arm Cap providing enhanced durability, protection and cleanability for the arms. This is field replaceable if it becomes damaged or degraded and is available in 8 standard colors.

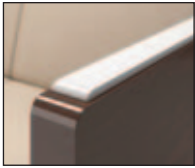

TABLET

Leyton Solid Surface tablet can be specified left or right as seated. The tablet can be used alone or with solid surface arm cap and is 1/2" thick.



PUSH BAR

This is an optional feature on Leyton One Seat lounge chairs, designed to assist caregiving staff in the movement and relocation of the chair. It is Silver Metallic in color and retractable for ease of use. The Push bar is field replaceable if necessary.

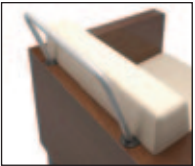

CASTERS

Optional on Leyton lounge chairs are four - 4" diameter soft wheel swivel locking casters, featuring a large, easy-access foot activation and release lever. The caster locks both directionally and rotationally, keeping the chair securely in place when locked. Note: lounge chairs with casters are not designed or intended as patient transport devices.



CLEAN OUT

Leyton lounge seating models have an optional built-in clean out feature: a space at the back of the seat that allows dirt debris and liquid to fall to the floor for easy clean up and maintenance - designed so that it does not detract from the comfort or appearance of the product. Clean Out option is available for an upcharge,



UNDER-MOUNT POWER

The Under-mount Power unit provides dual power/USB outlets for multiple devices. It can be located below seats and tables.



COMBINATION UPHOLSTERY OPTIONS

When combination upholstery is specified with fabric of the same grade or COM, an upcharge for dual fabrics is **\$33 list** per unit and **\$64 list** per unit for three fabrics will be applied. When graded in combination upholstery is selected, use the highest grade upholstery selected or to obtain a quote for blended grading contact Customer Service (please provide the fabrics specified and location of where each fabric is to be applied on the product).

REMOVABLE COVERS & REPLACEMENT COMPONENTS

Optional Removeable covers (with the exception of the Upholstered Armless, Upholstered Full Arm and Front panel) can be quickly installed on Leyton products that were originally ordered with the Removable cover option. Replacement covers (with the exception of the Upholstered Armless, Full Upholstered Arm and front panel) can also be installed on Leyton products that were not originally ordered with the Removable cover option, with some simple staple removal.

CAL 133 & MOISTURE BARRIER

California Technical Bulletin 133 is a flammability test for seating. Krug offers a compliance method which, in combination with non-flammable upholstery covers, may enable the products to meet certification requirements for this test. This process at the same time also provides the products with a Moisture Barrier - a treatment that helps to prevent the passage of liquids and moisture to inside of upholstered components - thereby conferring sanitary and anti-infection benefits. So when CAL 133 is specified, the product also automatically has a Moisture Barrier, and when a Moisture Barrier is specified, the product also features the compliance method and low flammability features of CAL 133. CAL 133 and Moisture Barrier are available for an upcharge.

The application of this upcharge and the compliance method does not mean that the specific configuration of product and upholstery cover are tested and officially certified as being CAL 133 compliant. If official certification is required, Krug will provide this (through an independent certified testing laboratory) at a charge of \$917 per item, plus the cost of the product to be tested. Lead time for certification testing is typically 4-8 weeks. Krug assumes no responsibility for the testing of our products in combination with upholstery covers, or for the results of any testing conducted. Some specific configurations of product and upholstery have already been tested. Please contact Customer Service for additional information.

LEYTON | DIMENSIONS, COM REQUIREMENTS, MOISTURE BARRIER & OPTION UPCHARGES

DIMENSIONS

	Overall Width	Overall Depth	Overall Height	Seat Height min/max	Height of Arms from Floor	Width between Arms	Seat Depth	Shipping Weight	Cube
LEY31UF	28.5	29.25	31	17.75	26.25	23.25	19.25	82	18.5
LEY31.5UF	35.5	29.25	31	17.75	26.25	30.25	19.25	107	25.2
LEY32UF	52	29.25	31	17.75	26.25	47	19.25	131	32.5
LEY33UF	75.75	29.25	31	17.75	26.25	70.5	19.25	179	46.5
LEY31UN	28.5	29.25	31	17.75	n/a	23.25	19.25	78	18.5
LEY31.5UN	35.5	29.25	31	17.75	n/a	30.25	19.25	103	25.2
LEY32UN	52	29.25	31	17.75	n/a	47	19.25	127	32.5
LEY33UN	75.75	29.25	31	17.75	n/a	70.5	19.25	175	46.5
LEY31WF	28.25	29.25	31	17.75	26.25	23.75	19.25	79	18.5
LEY31.5WF	35.25	29.25	31	17.75	26.25	30.25	19.25	104	25.2
LEY32WF	51.75	29.25	31	17.75	26.25	47.25	19.25	128	32.5
LEY33WF	75.5	29.25	31	17.75	26.25	71	19.25	176	46.5
LEY31WN	28.25	29.25	31	17.75	n/a	23.75	19.25	75	18.5
LEY31.5WN	35.25	29.25	31	17.75	n/a	30.25	19.25	100	25.2
LEY32WN	51.75	29.25	31	17.75	n/a	47.25	19.25	124	32.5
LEY33WN	75.5	29.25	31	17.75	n/a	71	19.25	172	46.5

All dimensions are in inches and approximate and are subject to change without notice. Contact Customer Service if dimensions are critical.

COM YARDAGE REQUIREMENTS

	Fully Upholstered (Complete Unit)	Wood Surround (Seat and Back only)	Seat Cushion only (Wood or Full Uph)	Back Cushion only (Wood or Full Uph)	Full Arm & front panel (Pair)	Armless panel & front panel (pair)	Back Panel only	Full body with arm, Front panel & Back panel
One-Seat - One Chair								
Armless	3.75	1.6	0.9	0.8		1.75	.75	2.5
Full Arm	4.6	1.6	0.9	0.8	2.6		.75	3.35
One & Half-Seat - One Chair								
Armless	5.2	2.3	1.3	1		2.1	.75	2.85
Full Arm	5.7	2.3	1.3	1	2.6		.75	3.35
Two-Seat - One Chair								
Armless	5.7	3	1.5	1.5		2	.75	2.75
Full Arm	6.3	3	1.5	1.5	2.6		.75	3.35
Three-Seat - One Chair								
Armless	8	4.6	2.4	2.2		2.3	1.5	3.8
Full Arm	8.7	4.6	2.4	2.2	3		1.5	4.5

COM APPROVAL PROCESS:

The approval process is as follows:

1. A sample of the COM fabric must be provided to Krug Customer Service prior to or at time of order.
2. The sample will be reviewed and the customer advised if the fabric is unsuitable.
3. The COM fabric will be inspected when received at the factory to identify any further concerns with its suitability.

CAL 133 MOISTURE BARRIER

Model	Upcharge	Model	Upcharge	Model	Upcharge	Model	Upcharge
LEY31UN	297	LEY32UN	436	LEY31.5UN	384	LEY33UN	740
LEY31UF	368	LEY32UF	512	LEY31.5UF	478	LEY33UF	810
LEY31WN	136	LEY32WN	208	LEY31.5WN	176	LEY33WN	457
LEY31WF	136	LEY32WF	208	LEY31.5WF	176	LEY33WF	457

Leyton Option Upcharges

	\$ List		\$ List
One-Seat Clean out	47	One-Seat Removable Seat & Back Covers	152
One & Half-Seat Clean out	68	One & Half-Seat Removable Seat & Back Covers	212
Two-Seat Clean out	92	Two-Seat Removable Seat & Back Covers	302
Three-Seat Clean out	137	Three-Seat Removable Seat & Back Covers	453
Solid Surface Arm Cap (per pair) - Gr A White	359	Seat or Back Cover only Upcharges	
Solid Surface Arm Cap (per pair) - Gr A Color	363	One-Seat	77
Solid Surface Arm Cap (per pair) - Gr B	368	One & Half-Seat	107
Solid Surface Arm Cap (per pair) - Gr C	404	Two-Seat	152
Solid Surface Tablet - Gr A White	539	Three-Seat	228
Solid Surface Tablet - Gr A Color	547		
Solid Surface Tablet - Gr B	577	Casters	180
Solid Surface Tablet - Gr C	624	Casters with Push bar	466

LEYTON

DESCRIPTION/MODEL	SPECIES	COM		COL	FABRIC GRADES			LEATHER		
		1	2	3	4	5	6	7	8	9

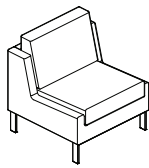

One-seat, Upholstered, Armless LEY31NUN	N/A	2056	2185	2304	2478	2681	2853	3049	3297	3545
--	-----	------	------	------	------	------	------	------	------	------

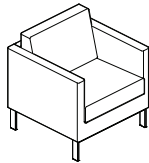

One-seat, Upholstered, Full Arm LEY31NUF	N/A	2185	2394	2590	2878	3200	3487	3811	4208	4622
---	-----	------	------	------	------	------	------	------	------	------

ORDERING NOTE: Leyton Lounge, Full Arm is available with an optional Solid Surface Arm Cap for upcharge see chart below, clearly note color selection and add an "S" to the end of the model number following the Arm Style. eg. LEY31NUFS

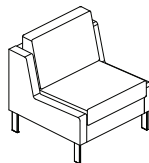

One-seat, Wood Surround, Armless LEY31NPN	Palette	2545	2596	2658	2735	2817	2891	2972	3088	3192
LEY31NWN	Oak, Maple Walnut,	2545	2596	2658	2735	2817	2891	2972	3088	3192
	Cherry, Anigre Sycamore,	3071	3126	3185	3260	3343	3418	3499	3613	3718

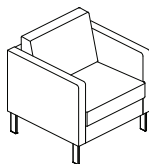

One-seat, Wood Surround, Full Arm LEY31NPF	Palette	2523	2576	2629	2703	2789	2867	2952	3057	3162
LEY31NWF	Oak, Maple Walnut, Palette	2523	2576	2629	2703	2789	2867	2952	3057	3162
	Cherry, Anigre Sycamore,	3049	3102	3156	3231	3315	3396	3479	3582	3688

ORDERING NOTE: Leyton Lounge, Full Arm is available with an optional Solid Surface Arm Cap for upcharge see chart below, clearly note color selection and add an "S" to the end of the model number following the Arm Style. eg. LEY31NUFS

Leyton Option Upcharges

	\$ List	\$ List
Casters	180	Solid Surface Arm Cap (per pair) - Gr A White
Casters with Pushbar	466	Solid Surface Arm Cap (per pair) - Gr A Color
One-Seat Clean out	47	Solid Surface Arm Cap (per pair) - Gr B
One-Seat Removable Seat & Back Covers	152	Solid Surface Arm Cap (per pair) - Gr C
		Solid Surface Tablet - Gr A White
Seat or Back Cover only Upcharges		Solid Surface Tablet - Gr A Color
One-Seat	77	Solid Surface Tablet - Gr B
		Solid Surface Tablet) - Gr C

ORDERING NOTES: Leyton Lounge is available with clean out option, to add this option change the first "N" to "C" and add an upcharge above. Please note Cherry, Anigre and Sycamore species require a minimum quantity order of 5 units per species.

LEYTON LOUNGE PRODUCT CODE KEY

Line	Series	Seat Count	Clean Out	Arm Style	Arm Cap Option (Full Arm Only)
LEY	3	1	N	UF	S
Leyton	Soft Seating	One-Seat	No Clean Out	Upholstered Full Arm	Solid Surface Full Arm Cap
		1.5	C	UN	
		One & Half-Seat	Clean Out	Upholstered Armless	
		2		WF	
		Two-Seat		Wood Surround Full Arm	
		3		WN	
		Three-Seat		Wood Surround Armless	
				PF	
				Pallet Finish Surround Full Arm	
				PN	
				Pallet Finish Surround Armless	

DESCRIPTION/MODEL	SPECIES	COM		COL			FABRIC GRADES			LEATHER	
		1	2	3	4	5	6	7	8	9	

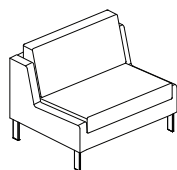

One & Half-seat, Upholstered, Armless LEY31.5NUN N/A	2639	2822	3004	3260	3553	3809	4099	4462	4830
---	------	------	------	------	------	------	------	------	------

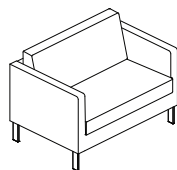

One & Half-seat, Upholstered, Full Arm LEY31.5NUF N/A	2772	2955	3136	3393	3684	3939	4234	4596	4962
--	------	------	------	------	------	------	------	------	------

ORDERING NOTE: Leyton Lounge, Full Arm is available with an optional Solid Surface Arm Cap for upcharge see chart below and clearly note color selection and add an "S" to the end of the model number following the Arm Style. eg. LEY31NUFS

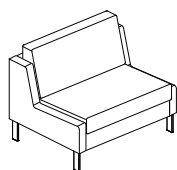

One & Half-seat, Wood Surround Armless LEY31.5NPN Palette	3025	3122	3220	3355	3512	3647	3803	3997	4192
LEY31.5NWN Oak, Maple Walnut, Palette	3025	3122	3220	3355	3512	3647	3803	3997	4192
Cherry, Anigre Sycamore	3552	3646	3743	3880	4037	4172	4328	4524	4718

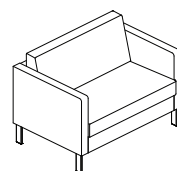

One & Half-seat, Wood Surround Full Arm LEY31.5NPF Palette	3001	3099	3195	3331	3488	3624	3781	3974	4169
LEY31.5NWF Oak, Maple Walnut, Palette	3001	3099	3195	3331	3488	3624	3781	3974	4169
Cherry, Anigre Sycamore	3529	3622	3720	3855	4011	4147	4306	4499	4692

ORDERING NOTE: Leyton Lounge, Full Arm is available with an optional Solid Surface Arm Cap for upcharge see chart below and clearly note color selection and add an "S" to the end of the model number following the Arm Style. eg. LEY31NUFS

Leyton Option Upcharges

	\$ List		\$ List
Casters	180	Solid Surface Arm Cap (per pair) - Gr A White	359
Casters with Pushbar	466	Solid Surface Arm Cap (per pair) - Gr A Color	363
One & Half-Seat Clean out	68	Solid Surface Arm Cap (per pair) - Gr B	368
One & Half-Seat Removable Seat & Back Covers	212	Solid Surface Arm Cap (per pair) - Gr C	404
		Solid Surface Tablet - Gr A White	539
Seat or Back Cover only Upcharges		Solid Surface Tablet - Gr A Color	547
One & Half-Seat	107	Solid Surface Tablet - Gr B	577
		Solid Surface Tablet) - Gr C	624

ORDERING NOTES: Leyton Lounge is available with clean out option, to add this option change the first "N" to "C" and add an upcharge above. Please note Cherry, Anigre and Sycamore species require a minimum quantity order of 5 units per species.

LEYTON LOUNGE PRODUCT CODE KEY

Line	Series	Seat Count	Clean Out	Arm Style	Arm Cap Option (Full Arm Only)
LEY	3	1	N	UF	S
Leyton	Soft Seating	One-Seat	No Clean Out	Upholstered Full Arm	Solid Surface Full Arm Cap
		1.5	C	UN	
		One & Half-Seat	Clean Out	Upholstered Armless	
		2		WF	
		Two-Seat		Wood Surround Full Arm	
		3		WN	
		Three-Seat		Wood Surround Armless	
				PF	
				Pallet Finish Surround Full Arm	
				PN	
				Pallet Finish Surround Armless	

LEYTON

DESCRIPTION/MODEL	SPECIES	COM		COL			FABRIC GRADES		LEATHER	
		1	2	3	4	5	6	7	8	9

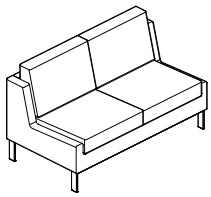

Two-seat, Upholstered, Armless LEY32NUN	N/A	3297	3487	3666	3921	4208	4471	4757	5125	5488
--	-----	------	------	------	------	------	------	------	------	------

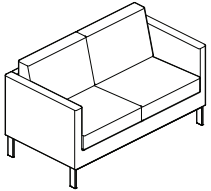

Two-seat, Upholstered, Full Arm LEY32NUF	N/A	3432	3682	3931	4277	4675	5022	5420	5917	6412
---	-----	------	------	------	------	------	------	------	------	------

ORDERING NOTE: Leyton Lounge, Full Arm is available with an optional Solid Surface Arm Cap for upcharge see chart below and clearly note color selection and add an "S" to the end of the model number following the Arm Style. eg. LEY31NUFS

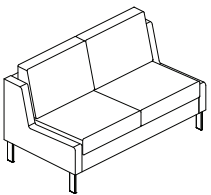

Two-seat, Wood Surround Armless LEY32NPN	Palette	3599	3697	3802	3936	4103	4245	4402	4608	4802
LEY32NWN	Oak, Maple Walnut, Palette	3599	3697	3802	3936	4103	4245	4402	4608	4802
	Cherry, Anigre Sycamore	4203	4296	4402	4539	4706	4846	5006	5210	5406

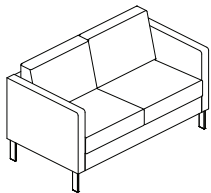

Two-seat, Wood Surround Full Arm LEY32NPF	Palette	3577	3672	3781	3915	4088	4222	4402	4576	4781
LEY32NWF	Oak, Maple Walnut, Palette	3577	3672	3781	3915	4088	4222	4402	4576	4781
	Cherry, Anigre, Sycamore	4179	4277	4381	4515	4690	4823	5006	5179	5384

ORDERING NOTE: Leyton Lounge, Full Arm is available with an optional Solid Surface Arm Cap for upcharge see chart below and clearly note color selection and add an "S" to the end of the model number following the Arm Style.

Leyton Option Upcharges

	\$ List		\$ List
Casters	180	Solid Surface Arm Cap (per pair) - Gr A White	359
Casters with Pushbar	466	Solid Surface Arm Cap (per pair) - Gr A Color	363
Two-Seat Clean out	92	Solid Surface Arm Cap (per pair) - Gr B	368
Two-Seat Removable Seat & Back Covers	302	Solid Surface Arm Cap (per pair) - Gr C	404
Seat or Back Cover only Upcharges		Solid Surface Tablet - Gr A White	539
Two-Seat	152	Solid Surface Tablet - Gr A Color	547
		Solid Surface Tablet - Gr B	577
		Solid Surface Tablet) - Gr C	624

ORDERING NOTES: Leyton Lounge is available with clean out option, to add this option change the first "N" to "C" and add an upcharge above. Please note Cherry, Anigre and Sycamore species require a minimum quantity order of 5 units per species.

LEYTON LOUNGE PRODUCT CODE KEY

Line	Series	Seat Count	Clean Out	Arm Style	Arm Cap Option (Full Arm Only)
LEY	3	1	N	UF	S
Leyton	Soft Seating	One-Seat	No Clean Out	Upholstered Full Arm	Solid Surface Full Arm Cap
		1.5	C	UN	
		One & Half-Seat	Clean Out	Upholstered Armless	
		2		WF	
		Two-Seat		Wood Surround Full Arm	
		3		WN	
		Three-Seat		Wood Surround Armless	
				PF	
				Pallet Finish Surround Full Arm	
				PN	
				Pallet Finish Surround Armless	

LEYTON

DESCRIPTION/MODEL	SPECIES	COM		COL			FABRIC GRADES			LEATHER	
		1	2	3	4	5	6	7	8	9	

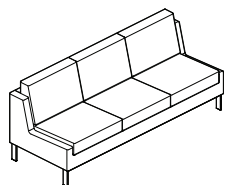

Three-seat, Upholstered, Armless LEY33NUN	N/A	4381	4608	4812	5125	5479	5787	6136	6571	7007
--	-----	------	------	------	------	------	------	------	------	------

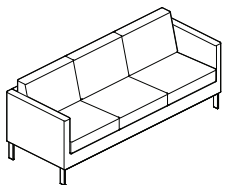

Three-seat, Upholstered, Full Arm LEY33NUF	N/A	4486	4757	5022	5395	5827	6203	6630	7164	7700
---	-----	------	------	------	------	------	------	------	------	------

ORDERING NOTE: Leyton Lounge, Full Arm is available with an optional Solid Surface Arm Cap for upcharge see chart below and clearly note color selection and add an "S" to the end of the model number following the Arm Style. eg. LEY31NUFS

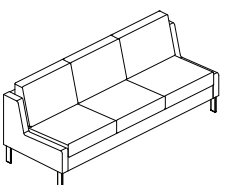

Three-seat, Wood Surround, Armless LEY3NPN	Palette	4697	4856	4998	5223	5466	5684	5932	6241	6549
LEY33NWN	Oak, Maple Walnut, Palette	4697	4856	4998	5223	5466	5684	5932	6241	6549
	Cherry, Anigre Sycamore	5373	5532	5677	5902	6141	6360	6609	6916	7227

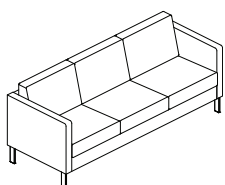

Three-seat, Wood Surround, Full Arm LEY3NPF	Palette	4675	4834	4992	5203	5450	5660	5910	6218	6527
LEY33NWF	Oak, Maple Walnut, Palette	4675	4834	4992	5203	5450	5660	5910	6218	6527
	Cherry, Anigre, Sycamore	5352	5509	5667	5878	6127	6337	6585	6895	7204

ORDERING NOTE: Leyton Lounge, Full Arm is available with an optional Solid Surface Arm Cap for upcharge see chart below and clearly note color selection and add an "S" to the end of the model number following the Arm Style.

Leyton Option Upcharges

	\$ List	\$ List
Casters	180	Solid Surface Arm Cap (per pair) - Gr A White
Casters with Pushbar	466	Solid Surface Arm Cap (per pair) - Gr A Color
Three-Seat Clean out	137	Solid Surface Arm Cap (per pair) - Gr B
Three-Seat Removable Seat & Back Covers	453	Solid Surface Arm Cap (per pair) - Gr C
		Solid Surface Tablet - Gr A White
Seat or Back Cover only Upcharges		Solid Surface Tablet - Gr A Color
Three-Seat	228	Solid Surface Tablet - Gr B
		Solid Surface Tablet) - Gr C

ORDERING NOTES: Leyton Lounge is available with clean out option, to add this option change the first "N" to "C" and add an upcharge above. Please note Cherry, Anigre and Sycamore species require a minimum quantity order of 5 units per species.

LEYTON LOUNGE PRODUCT CODE KEY

Line	Series	Seat Count	Clean Out	Arm Style	Arm Cap Option (Full Arm Only)
LEY	3	1	N	UF	S
Leyton	Soft Seating	One-Seat	No Clean Out	Upholstered Full Arm	Solid Surface Full Arm Cap
		1.5	C	UN	
		One & Half-Seat	Clean Out	Upholstered Armless	
		2		WF	
		Two-Seat		Wood Surround Full Arm	
		3		WN	
		Three-Seat		Wood Surround Armless	
				PF	
				Pallet Finish Surround Full Arm	
				PN	
				Pallet Finish Surround Armless	

LEYTON | SLED BASE

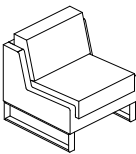
DESCRIPTION/MODEL	SPECIES	COM		COL		FABRIC GRADES			LEATHER		
		1	2	3	4	5	6	7	8	9	
	One-seat, No Clean Out, Upholstered, Armless with Sled Base										
	LEY31NUN1	N/A	2109	2231	2345	2510	2704	2868	3054	3290	3527

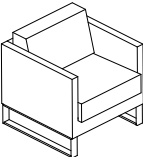
	One-seat, No Clean Out, Upholstered, Full Arm with Sled Base										
	LEY31NUF1	N/A	2231	2430	2617	2891	3198	3471	3780	4158	4552

ORDERING NOTE: Leyton Lounge, Full Arm is available with an optional Solid Surface Arm Cap for upcharge see chart below, clearly note color selection and add an "S" to the end of the model number following the Arm Style. eg. LEY31NUF1S

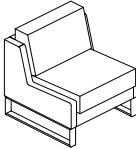
	One-seat, No Clean Out, Wood Surround, Armless with Sled Base										
	LEY31NPN1	Palette	2574	2623	2682	2755	2833	2904	2981	3091	3190
	LEY31NWN1	Oak, Maple Walnut,	2574	2623	2682	2755	2833	2904	2981	3091	3190
		Cherry, Anigre Sycamore,	3075	3128	3184	3255	3334	3406	3483	3591	3691

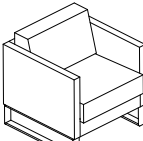
	One-seat, No Clean Out, Wood Surround, Full Arm with Sled Base										
	LEY31NPF1	Palette	2553	2604	2654	2725	2807	2881	2962	3062	3162
	LEY31NWF1	Oak, Maple Walnut, Palette	2553	2604	2654	2725	2807	2881	2962	3062	3162
		Cherry, Anigre Sycamore,	3054	3105	3156	3228	3308	3385	3464	3562	3663

ORDERING NOTE: Leyton Lounge, Full Arm is available with an optional Solid Surface Arm Cap for upcharge see chart below, clearly note color selection and add an "S" to the end of the model number following the Arm Style. eg. LEY31NUF1S

Leyton Option Upcharges	\$ List	\$ List
One-Seat Clean out	45	Solid Surface Arm Cap (per pair) - Gr A White
One-Seat Removable Seat & Back Covers	145	Solid Surface Arm Cap (per pair) - Gr A Color
Seat or Back Cover only Upcharges	74	Solid Surface Arm Cap (per pair) - Gr B
		Solid Surface Arm Cap (per pair) - Gr C
		Solid Surface Tablet - Gr A White
		Solid Surface Tablet - Gr A Color
		Solid Surface Tablet - Gr B
		Solid Surface Tablet) - Gr C

ORDERING NOTES: Leyton Lounge is available with clean out option, to add this option change the first "N" to "C" and add an upcharge above. Please note Cherry, Anigre and Sycamore species require a minimum quantity order of 5 units per species.

LEYTON LOUNGE PRODUCT CODE KEY

Line	Series	Seat Count	Clean Out	Arm Style	Base Type	Arm Cap Option (Full Arm Only)
LEY	3	1	N	UF	0	S
Leyton	Soft Seating	One-Seat	No Clean Out	Upholstered Full Arm	Leg Base	Solid Surface Full Arm Cap
		1.5	C	UN	1	
		One & Half-Seat	Clean Out	Upholstered Armless	Sled Base	
		2		WF		
		Two-Seat		Wood Surround Full Arm		
		3		WN		
		Three-Seat		Wood Surround Armless		
				PF		
				Pallet Finish Surround Full Arm		
				PN		
				Pallet Finish Surround Armless		

LEYTON | SLED BASE

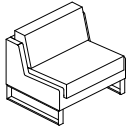
DESCRIPTION/MODEL	SPECIES	COM		COL	FABRIC GRADES			LEATHER		
		1	2	3	4	5	6	7	8	9
	One & Half-seat, No Clean Out, Upholstered, Armless with Sled Base									
	LEY31.5NUN1 N/A	2664	2838	3011	3255	3534	3778	4054	4400	4750

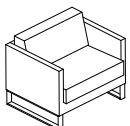
	One & Half-seat, No Clean Out, Upholstered, Full Arm with Sled Base									
	LEY31.5NUF1 N/A	2790	2965	3137	3382	3659	3902	4183	4528	4876

ORDERING NOTE: Leyton Lounge, Full Arm is available with an optional Solid Surface Arm Cap for upcharge see chart below and clearly note color selection and add an "S" to the end of the model number following the Arm Style. eg. LEY31.5NUF1S

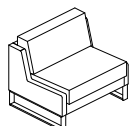
	One & Half-seat, No Clean Out, Wood Surround Armless with Sled Base										
	LEY31.5NPN1 Palette	3031	3124	3217	3346	3495	3624	3772	3957	4143	
	LEY31.5NWN1 Oak, Maple	3031	3124	3217	3346	3495	3624	3772	3957	4143	
	Walnut, Palette										
	Cherry, Anigre	3533	3623	3715	3846	3995	4124	4272	4459	4644	
Sycamore											

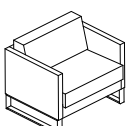
	One & Half-seat, No Clean Out, Wood Surround Full Arm with Sled Base										
	LEY31.5NPF1 Palette	3009	3102	3193	3323	3472	3602	3751	3935	4121	
	LEY31.5NWF1 Oak, Maple	3009	3102	3193	3323	3472	3602	3751	3935	4121	
	Walnut, Palette										
	Cherry, Anigre	3511	3600	3693	3822	3970	4100	4251	4435	4619	
Sycamore											

ORDERING NOTE: Leyton Lounge, Full Arm is available with an optional Solid Surface Arm Cap for upcharge see chart below and clearly note color selection and add an "S" to the end of the model number following the Arm Style. eg. LEY31.5NUF1S

Leyton Option Upcharges	\$ List	\$ List
One & Half-Seat Clean out	65	Solid Surface Arm Cap (per pair) - Gr A White 342
One & Half-Seat Removable Seat & Back Covers	202	Solid Surface Arm Cap (per pair) - Gr A Color 346
		Solid Surface Arm Cap (per pair) - Gr B 351
Seat or Back Cover only Upcharges		Solid Surface Arm Cap (per pair) - Gr C 385
One & Half-Seat	102	Solid Surface Tablet - Gr A White 514
		Solid Surface Tablet - Gr A Color 521
		Solid Surface Tablet - Gr B 550
		Solid Surface Tablet) - Gr C 595

ORDERING NOTES: Leyton Lounge is available with clean out option, to add this option change the first "N" to "C" and add an upcharge above. Please note Cherry, Anigre and Sycamore species require a minimum quantity order of 5 units per species.

LEYTON LOUNGE PRODUCT CODE KEY

Line	Series	Seat Count	Clean Out	Arm Style	Base Type	Arm Cap Option (Full Arm Only)
LEY	3	1	N	UF	0	S
Leyton	Soft Seating	One-Seat	No Clean Out	Upholstered Full Arm	Leg Base	Solid Surface Full Arm Cap
		1.5	C	UN	1	
		One & Half-Seat	Clean Out	Upholstered Armless	Sled Base	
		2		WF		
		Two-Seat		Wood Surround Full Arm		
		3		WN		
		Three-Seat		Wood Surround Armless		
				PF		
				Pallet Finish Surround Full Arm		
				PN		
				Pallet Finish Surround Armless		

LEYTON | SLED BASE

DESCRIPTION/MODEL	SPECIES	COM		COL	FABRIC GRADES			LEATHER		
		1	2	3	4	5	6	7	8	9

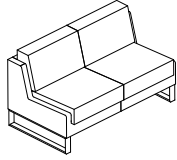

Two-seat, No Clean Out, Upholstered, Armless with Sled Base										
LEY32NUN1	N/A	3290	3471	3642	3885	4158	4409	4681	5031	5377

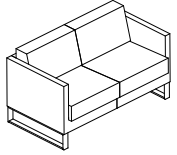

Two-seat, No Clean Out, Upholstered, Full Arm with Sled Base										
LEY32NUF1	N/A	3419	3657	3894	4224	4603	4933	5312	5786	6257

ORDERING NOTE: Leyton Lounge, Full Arm is available with an optional Solid Surface Arm Cap for upcharge see chart below and clearly note color selection and add an "S" to the end of the model number following the Arm Style. eg. LEY32NUF1S

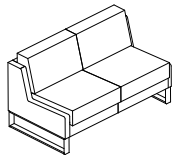

Two-seat, No Clean Out, Wood Surround Armless with Sled Base										
LEY32NPN1	Palette	3578	3671	3771	3899	4058	4193	4343	4539	4724
LEY32NWN1	Oak, Maple	3578	3671	3771	3899	4058	4193	4343	4539	4724
	Walnut, Palette									
	Cherry, Anigre	4153	4242	4343	4473	4632	4766	4918	5112	5299
	Sycamore									

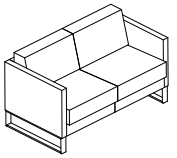

Two-seat, No Clean Out, Wood Surround Full Arm with Sled Base										
LEY32NPF1	Palette	3557	3648	3751	3879	4044	4171	4343	4509	4704
LEY32NWF1	Oak, Maple	3557	3648	3751	3879	4044	4171	4343	4509	4704
	Walnut, Palette									
	Cherry, Anigre,	4130	4224	4323	4450	4617	4744	4918	5083	5278
	Sycamore									

ORDERING NOTE: Leyton Lounge, Full Arm is available with an optional Solid Surface Arm Cap for upcharge see chart below and clearly note color selection and add an "S" to the end of the model number following the Arm Style. eg. LEY32NUF1S

Leyton Option Upcharges		\$ List	\$ List
Two-Seat Clean out		88	Solid Surface Arm Cap (per pair) - Gr A White
Two-Seat Removable Seat & Back Covers		288	Solid Surface Arm Cap (per pair) - Gr A Color
			Solid Surface Arm Cap (per pair) - Gr B
Seat or Back Cover only Upcharges			Solid Surface Arm Cap (per pair) - Gr C
Two-Seat		145	Solid Surface Tablet - Gr A White
			Solid Surface Tablet - Gr A Color
			Solid Surface Tablet - Gr B
			Solid Surface Tablet) - Gr C

ORDERING NOTES: Leyton Lounge is available with clean out option, to add this option change the first "N" to "C" and add an upcharge above. Please note Cherry, Anigre and Sycamore species require a minimum quantity order of 5 units per species.

LEYTON LOUNGE PRODUCT CODE KEY

Line	Series	Seat Count	Clean Out	Arm Style	Base Type	Arm Cap Option (Full Arm Only)
LEY	3	1	N	UF	0	S
Leyton	Soft Seating	One-Seat	No Clean Out	Upholstered Full Arm	Leg Base	Solid Surface Full Arm Cap
		1.5	C	UN	1	
		One & Half-Seat	Clean Out	Upholstered Armless	Sled Base	
		2		WF		
		Two-Seat		Wood Surround Full Arm		
		3		WN		
		Three-Seat		Wood Surround Armless		
				PF		
				Pallet Finish Surround Full Arm		
				PN		
				Pallet Finish Surround Armless		

LEYTON | SLED BASE

DESCRIPTION/MODEL	SPECIES	COM		COL		FABRIC GRADES			LEATHER	
		1	2	3	4	5	6	7	8	9

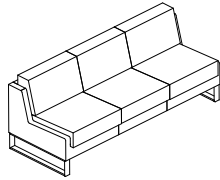

Three-seat, No Clean Out, Upholstered Armless with Sled Base LEY33NUN1	N/A	4323	4539	4733	5031	5369	5662	5994	6409	6824
---	-----	------	------	------	------	------	------	------	------	------

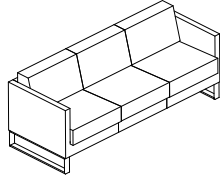

Three-seat, No Clean Out, Upholstered Full Arm with Sled Base LEY33NUF1	N/A	4423	4681	4933	5289	5700	6058	6465	6973	7484
--	-----	------	------	------	------	------	------	------	------	------

ORDERING NOTE: Leyton Lounge, Full Arm is available with an optional Solid Surface Arm Cap for upcharge see chart below and clearly note color selection and add an "S" to the end of the model number following the Arm Style. eg. LEY33NUF1S

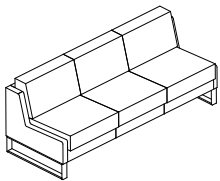

Three-seat, No Clean Out, Wood Surround Armless with Sled Base LEY33NPN1	Palette	4624	4775	4910	5125	5356	5564	5800	6094	6388
LEY33NWN1	Oak, Maple Walnut, Palette	4624	4775	4910	5125	5356	5564	5800	6094	6388
	Cherry, Anigre Sycamore	2109	2231	2345	2510	2704	2868	3054	3290	3527

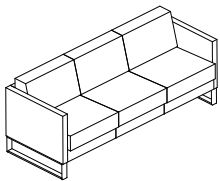

Three-seat, No Clean Out, Wood Surround Full Arm with Sled Base LEY33NPF1	Palette	2109	2231	2345	2510	2704	2868	3054	3290	3527
LEY33NWF1	Oak, Maple Walnut, Palette	2109	2231	2345	2510	2704	2868	3054	3290	3527
	Cherry, Anigre, Sycamore	2109	2231	2345	2510	2704	2868	3054	3290	3527

ORDERING NOTE: Leyton Lounge, Full Arm is available with an optional Solid Surface Arm Cap for upcharge see chart below and clearly note color selection and add an "S" to the end of the model number following the Arm Style. eg. LEY33NUF1S

Leyton Option Upcharges

	\$ List	\$ List
Three-Seat Clean out	131	Solid Surface Arm Cap (per pair) - Gr A White
Three-Seat Removable Seat & Back Covers	432	Solid Surface Arm Cap (per pair) - Gr A Color
		Solid Surface Arm Cap (per pair) - Gr B
Seat or Back Cover only Upcharges		Solid Surface Arm Cap (per pair) - Gr C
Three-Seat	218	Solid Surface Tablet - Gr A White
		Solid Surface Tablet - Gr A Color
		Solid Surface Tablet - Gr B
		Solid Surface Tablet) - Gr C

ORDERING NOTES: Leyton Lounge is available with clean out option, to add this option change the first "N" to "C" and add an upcharge above. Please note Cherry, Anigre and Sycamore species require a minimum quantity order of 5 units per species.

LEYTON LOUNGE PRODUCT CODE KEY

Line	Series	Seat Count	Clean Out	Arm Style	Base Type	Arm Cap Option (Full Arm Only)
LEY	3	1	N	UF	0	S
Leyton	Soft Seating	One-Seat	No Clean Out	Upholstered Full Arm	Leg Base	Solid Surface Full Arm Cap
		1.5	C	UN	1	
		One & Half-Seat	Clean Out	Upholstered Armless	Sled Base	
		2		WF		
		Two-Seat		Wood Surround Full Arm		
		3		WN		
		Three-Seat		Wood Surround Armless		
				PF		
				Pallet Finish Surround Full Arm		
				PN		
				Pallet Finish Surround Armless		



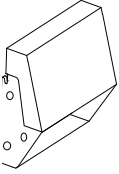
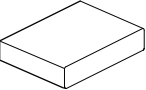
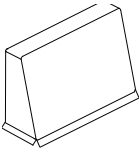
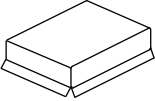
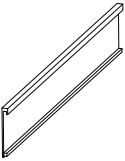

LEYTON | REPLACEMENT COMPONENTS

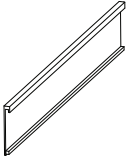
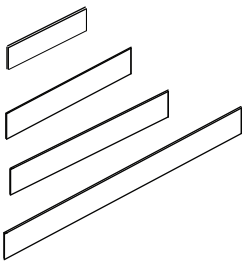
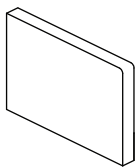
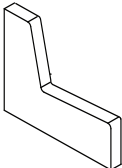
DESCRIPTION	MODEL	COM			COL			FABRIC GRADES			LEATHER			WEIGHTS	CUBES
		1	2	3	4	5	6	7	8	9					
	Replacement Back LEY3RB	485	511	535	569	610	644	687	735	784	12	3.5			
	One & Half-Seat Replacement Back LEY3R1.5B	527	560	592	637	689	735	785	851	916	15	4.5			
	Replacement Seat LEY3RS	695	725	756	796	845	887	935	995	1058	11	2.5			
	One & Half-Seat Replacement Seat LEY3R1.5S	799	843	887	952	1021	1084	1155	1244	1333	14	4			
	Replacement Back Cover LEY3RBC	250	278	302	338	380	412	454	507	556	1	0.75			
	One & Half-Seat Replacement Back Cover LEY3R1.5BC	284	319	350	397	449	493	544	611	676	1.25	1			
	Replacement Seat Cover LEY3RSC	253	280	309	350	394	435	481	538	596	1.25	0.75			
	One & Half-Seat Replacement Seat Cover LEY3R1.5SC	319	363	408	470	541	602	669	764	852	1.5	1			
	One-Seat - Replacement Upholstered Outside Back Panel LEY3R1OBPU	245	271	297	333	372	408	449	497	547	10	1.5			
	One-Seat - Replacement Upholstered Outside Back Panel for Push bar option LEY3R1OBPUPB	259	282	308	343	383	418	457	511	560	10	1.5			
	One & Half-Seat - Replacement Upholstered Outside Back Panel LEY3R1.5OBPU	273	299	321	359	402	434	477	522	573	13	2.5			
	One & Half-Seat - Replacement Upholstered Outside Back Panel for Push bar option LEY3R1.5OBPUPB	283	309	336	369	410	446	486	536	586	13	2.5			
	Two-Seat - Replacement Upholstered Outside Back Panel LEY3R2OBPU	315	340	365	403	438	478	516	567	617	19	3.5			
	Three-Seat - Replacement Upholstered Outside Back Panel LEY3R3OBPU	415	464	515	585	666	737	816	916	1018	28	5			

LEYTON | REPLACEMENT COMPONENTS

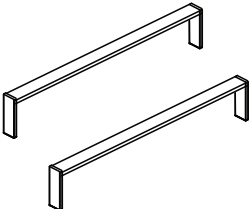
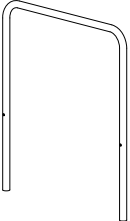
DESCRIPTION	MODEL	OAK	CHERRY	WEIGHTS	CUBES	
		MAPLE WALNUT PALETTE	ANIGRE SYCAMORE			
	One-Seat - Replacement Wood Outside Back Panel LEY3R1OBPW	334	397	10	1.5	
	One-Seat - Replacement Wood Outside Back Panel for Push bar option LEY3R1OBPWPB	352	415	10	1.5	
	One & Half-Seat - Replacement Wood Outside Back Panel LEY3R1.5OBPW	410	508	13	2.5	
	One & Half-Seat - Replacement Wood Outside Back Panel for Push bar option LEY3R1.5OBPWPB	428	521	13	2.5	
	Two-Seat - Replacement Wood Outside Back Panel LEY3R2OBPW	458	584	19	3.5	
	Three-Seat - Replacement Wood Outside Back Panel LEY3R3OBPW	501	688	28	5	
	One-Seat - Replacement Wood Front Panel LEY3R1FP	226	258	4	0.75	
	One & Half-Seat - Replacement Wood Front Panel LEY3R1.5FP	258	278	5	1	
	Two-Seat - Replacement Wood Front Panel LEY3R2FP	287	350	6	1.25	
	Three-Seat - Replacement Wood Front Panel LEY3R3FP	319	412	8	2	
	Replacement Wood Surround Full Arm with arm cap (Left, right specified as seated) LEY3RWFL LEY3RWFLR	610	822	30	1.5	
	Replacement Wood Surround Full Arm with caster (Left, right specified as seated) LEY3RWFCL LEY3RWFCLR	768	983	30	1.5	
	Replacement Wood Surround Full Arm with cup holder (Left, right specified as seated) LEY3RWFCHL LEY3RWFCHR	789	1003	30	1.5	
	Replacement Wood Surround Full Arm with Integrated cup holder (Left, right specified as seated) LEY3RWFICHL LEY3RWFICHR	820	1033	30	1.5	
	Replacement Wood Surround Full Arm Tablet (Left, right specified as seated) LEY3RWFTL LEY3RWFTL	878	1092	30	1.5	
	Replacement Wood Surround Full Arm Integrated Tablet (Left, right specified as seated) LEY3RWFITL LEY3RWFITR	984	1198	30	1.5	
		Replacement Wood Surround Armless (Left, right specified as seated) LEY3RWNLL LEY3RWNLR	620	833	26	1.5
		Replacement Wood Surround Armless with casters (Left, right specified as seated) LEY3RWNCL LEY3RWNCR	780	990	26	1.5

LEYTON | REPLACEMENT COMPONENTS

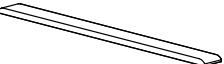
DESCRIPTION	MODEL	PRICE	WEIGHTS	CUBES			
	One-Seat Replacement Leg set (pair) LEY3R1L	180	8	1.25			
	One-Seat Wide Replacement Leg set (pair) LEY3R1.5L	214	10	1.5			
	Two-Seat Replacement Leg set (pair) LEY3R2L	238	13	2.5			
	Three-Seat Replacement Leg set (pair) LEY3R3L	358	22	3			
	Push bar - One-Seat LEY3RPB-1	70	2.0	1.8			
	Push bar - One-Seat Wide LEY3RPB-1.5	78	2.5	2.0			
	Push bar Grommet (pair) LEY3RPBG	10	.2	.1			
Note: Pushbar option is available on One-Seat and One-Seat Wide only.							
	Caster LEY3RC	81	3.4	0.2			
	Replacement Glides - Lounge & Table (set of four) LEY3RG	18	1	.25			
	LEY3-POWERDOC - Undermount	570	3	0.375			
Can be field installed to the underside of Seats and Tables as a replacement part or installed on units not previously specified with a PowerDoc. Standard with 2 Power and 2 USB outlets. PowerDoc's have a 10' cord.							
Solid Surface		Grade A- White	Grade A- Color	Grade- B	Grade- C		
	Replacement Tablet with Mounting Plate - Solid Surface LEY3RT	539	547	577	624	5.0	.7
	Replacement Arm Cap - Solid Surface (to be used with tablet) LEY3TAC	114	116	119	137	1	.3
	Replacement Arm Cap - Solid Surface LEY3RAC	180	182	185	202	1	.25
	ORDERING NOTE: Please note Replacement Arm Cap can only be installed on product originally ordered with the Solid Surface Arm Cap option.						

LEED CI CREDITS



MATERIAL CONTENT

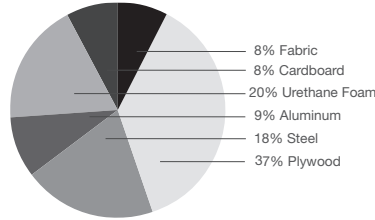

PRE-CONSUMER
RECYCLED CONTENT = 6%

POST-CONSUMER
RECYCLED CONTENT = 12.12%

Up to 35.11% of Zola Modular product is recyclable at the end of its useful life.

CONTRIBUTES TO

CREDIT 2.1 - 2.2	Construction Waste Management	1-2 point(s)
CREDIT 3.3	Resource Reuse	1 point
CREDIT 4.1	Recycled Content	1 point
CREDIT 4.5	Low Emitting Materials, Systems & Seating	1 point
CREDIT 5.1	Regional Materials*	1 point
CREDIT 7	Certified Wood (MUST BE REQUESTED)	1 point(s)

*This credit is only applicable if in total 20% of the combined value of the procurement of construction materials and in the furniture are manufactured within a radius of 500 miles. This credit will apply if the installation of the finished product occurs within 500 miles of Kitchener, Ontario.

level® CERTIFICATION, AIR EMISSIONS AND FSC® CERTIFICATION



level® CERTIFICATION

BIFMA's e3 Furniture Sustainability Standard is a voluntary, multi-attribute standard that measures the degree of sustainability of furniture. This standard evaluates product and company environmental attributes and compliance systems in a wide range of elements which include Materials, Energy & Atmosphere, Human & Ecosystem Health and Social Responsibility. Zola products have earned level®, BIFMA's sustainability certification program for furniture, certification through third-party verification against the e3 standard.

AIR-EMISSIONS

All Zola products are supplied with air-emissions certified. Contact customer service for information.



FSC®

In 2005, Krug received Forest Stewardship Council® (FSC®) Chain-of-Custody certification for our manufacturing facilities. The FSC® Chain-of-Custody tracks certified wood from seedling to final sale. It verifies that the material for our FSC® certified products only come from well-managed, FSC®-certified forests and other controlled sources. FSC® is dedicated to the promotion of responsible forest management worldwide helping to take care of forests for future generations. Zola and other Krug products can be specified with FSC® Certification. Contact customer service for further information, pricing and lead times.



Architects, designers, and building professionals can specify FSC®-certified products in order to achieve a point from the U.S. Green Building Council's Leadership in Energy and Environmental Design (LEED) Rating System.

ZOLA | FEATURES & OPTIONS



INTENSIVE USE ENVIRONMENTS

Zola has been designed for healthcare and other intensive use environments, with some important features: removable and replaceable upholstery covers, an anti-microbial finish, the option of a urethane arm cap and a standard clean-out between the seat and back. Modular construction allows for complete cleaning and disinfecting of the entire unit, and air emissions certification, make Zola an excellent solution for healthy spaces and caregiving environments.



ZOLA LOUNGE & ZOLA MODULAR

Zola Lounge chairs are pre-assembled at Krug and cannot be reconfigured into Modular units. Arms and backs cannot be removed from the seat.



RECONFIGURABILITY

Zola Modular is designed to enable change: components are inter-changeable, reconfigurable, and replaceable. Metal-to-metal bracketry is designed for fast, easy reconfiguring, that does not damage or degrade the product, and new components can be added and added with ease. Both backs and arms can be reconfigured to either side of the unit. Its unique leveller provides exceptional leveling capability over large spans, and on uneven floors. Heavy duty casters provide seating with mobility.



LINKING BRACKET

The Zola seat-to-seat linking bracket is made of sturdy, powder-coated steel construction in a black finish. This linking bracket is fastened with metal to metal connections from the seat to another seat with hardened steel bolts to ensure exceptional durability and strength. Brackets mount underneath, and do not mar or damage the tables or seats. This feature is not available on the Lounge version.



REPLACEABILITY

Zola is built to last: its heavy-duty structure is designed for intensive use environments. When any component is damaged or degraded, it can be easily changed out on its own, instead of having to replace or repair an entire unit. Along with its use of recycled and recyclable materials, the replaceability of components means Zola can provide exceptional long term value, and be an investment in sustainability.



FINISH DURABILITY

The Krug's finish a proprietary catalyzed varnish formulation, has been repeatedly shown, through independent laboratory testing, to be the industry leader in durability and abrasion resistance. The Krug finish looks better longer than competitors, and is uniquely suited to the demands of high traffic environments.



WALL SAVER

The angle of the Zola Lounge back is designed to keep the back away from the wall, to prevent wear and damage to both the chairs and to the walls of the room. Zola upholstered chairs are built with a 1/2" clearance between the top of the back and the wall for the wall saver design. Please note wall saver is not a feature on the wood back versions.



CLEAN OUT

Zola chairs have a built-in clean out feature: a space at the back of the seat that allows dirt and debris to fall to the floor for easy clean up and maintenance. The clean out feature was designed so that it does not detract from the comfort or appearance of the product.



CASTERS

Optional on the Zola Lounge are the choice of:
a) Four - 3 1/4" dia hard wheel casters, consisting of two non braking on the front, and two braking on the back. Braking casters have a large, easy access foot activation lever.
b) Two non braking casters on the back, and two legs on the front. Casters are NOT available on the Plus product(s)



LEGS

Zola legs are Silver Metallic or Matte Black and feature and feature glides that are adjustable up to 1.25", which provide leveling capability over longer spans.



URETHANE ARM CAP

The optional urethane arm cap provides enhanced durability and protection for the arms. Urethane arm caps are available in two color options; Grey and Taupe. The urethane arm cap is field replaceable if damaged or degraded with the assistance of a skilled upholsterer.



SOLID SURFACE ARM CAP

The optional Solid Surface Arm Cap provides enhanced durability, protection and cleanability for the arms. This is field replaceable if this becomes damaged or degraded and is available in 8 standard colors.



FULL DEPTH BENCHES

Modular Curved Benches are offered in two depths. For a flush edge when joining a Modular Curved Bench to Modular seat with back choose the Full Depth.

PLUS UPGRADE

Zola seating is available with optional Plus Upgrade. Plus Seating has been engineered to support higher weight capacities, accommodating a wider variety of users.

WEIGHT CAPACITIES

Zola weight capacities are as follows:

One-Seat (Straight or curved)	- 300 lbs
One-Seat Plus	- 750 lbs
Two-seat (Straight or curved)	- 525lbs
Two-seat Plus	- 975 lbs
Three-seat	- 750 lbs
Three-seat Plus	- 1150 lbs



TABLETS

Optional Tablets are available on the Zola Lounge & Modular in veneer, clear glass, solid surface, high pressure laminate and palette finishes. The Zola tablet can be fastened to the Zola Lounge & Modular chairs by the Universal Tablet Mount (mounted left or right), to existing legs and features an elliptical shape of 16 1/2" x 11 1/2" x 3/4" in size. The Zola Tablet has a turning radius of 360 degrees, which accommodates any worksurface angle.



TABLES MATERIALS OPTION

Tables are available in veneer, plastic laminate, and Palette finishes - and an optional Solid Surface top. Tables feature leveling glides on every leg. See 373.



SOLID SURFACE TOPS

The Solid Surface Top option features Solid Surface material: composed of minerals, acrylic resins and colors, it is a non-porous, scratch and dent-resistant material that does not stain, and does not allow microbes and bacteria to penetrate the surface. Color is throughout the material, so surface scratches are not as visible.



LINKING TABLES

Zola Linking Tables can be fastened in the field to Zola Modular and Zola Benches with the table to seat bracket without compromising the upholstery. Zola Middle tables have the ability to be easily reconfigured, as they are universal and non-handed. They can be moved to a reverse position in almost any configuration to provide a high level of flexibility when specifying.



LINKING BRACKETS

The Zola table to seat bracket is made of sturdy, powder-coated steel construction in a Silver Metallic finish to match the legs and casters. This linking bracket is fastened with metal to metal connections from the seat to the table with hardened steel bolts to ensure exceptional durability and strength. Brackets mount underneath, and do not mar or damage the tables or seats. This feature is not available on the Lounge version.



POWER

The flush-mounted Power unit provides dual power/USB outlets for multiple devices. It can be located on either side of the seat, seat front, (not available on curved fronts) as well as on the front face of tables as standard. See page 226 for locations and page 287 for pricing.



UNDER-MOUNT POWER

The Under-mount Power unit provides dual power/USB outlets for multiple devices. It can be located below seats and tables. See page 287 for pricing.



COMBINATION UPHOLSTERY OPTIONS

When combination upholstery is specified with fabric of the same grade or COM, an upcharge for dual fabrics is **\$33 list** per unit and **\$64 list** per unit for three fabrics will be applied. When graded in combination upholstery is selected, use the highest grade upholstery selected or to obtain a quote for blended grading contact Customer Service (please provide the fabrics specified and location of where each fabric is to be applied on the product).

REPLACEMENT UPHOLSTERY COVERS

Replacement upholstery covers can be easily fitted onto Zola Modular components (with the exception of Zola Curve backs) originally ordered with Removable Upholstery Covers. It is possible to use replacement covers on modular components originally ordered with standard upholstery covers, but this requires some removal of staples and other basic upholstery. Please note that the tailoring of replacement upholstery covers can be less exact and refined in appearance as original upholstery.

REMOVABLE UPHOLSTERY COVERS

Removable Upholstery Covers are available on most Zola Modular upholstered components, (with the exception of Zola Curve backs) at an upcharge. This feature allows for upholstery covers to be cleaned and disinfected, and allows them to be field-replaced with replacement upholstery covers. Please note that the tailoring of Removable Upholstery Covers can be less exact and refined in appearance than standard upholstery. Replacement and removeable covers, (supplied with Velcro) will tailor differently than the permanently stapled upholstery. Overall form and fit is identical, however minor dimensional build up due to the thickness of the velcro can occur. The velcro fastening build up is directed to the least noticeable face (usually the bottom edge of a component) where ever possible.

MOISTURE BARRIER & CAL 133

California Technical Bulletin 133 is a flammability test for seating. Krug offers a compliance method, in combination with non-flammable upholstery covers, may enable products to meet certification requirements for this test. This process at the same time also provides the products with a Moisture Barrier - a treatment that helps to prevent the passage of liquids and moisture to inside of the upholstered components - thereby conferring sanitary and anti-infection benefits. So when CAL 133 is specified, the product also automatically has a Moisture Barrier, and when a Moisture Barrier is specified, the product also features the compliance method and low flammability features of CAL 133.

The application of this up-charge and the compliance method does not mean that the specific configuration of product and upholstery cover are tested and officially certified as being CAL133 compliant. If the official certification is required, Krug will provide this (through an independent certified testing laboratory) at a charge of \$917 per item, plus the cost of the product to be tested. Lead time for certification testing is typically 4-8 weeks. Krug assumes no responsibility for the testing of our products in combination with upholstery covers, or for the results of any testing conducted. Some specific configurations of products and upholstery have already been tested. Please contact Customer Service for additional information.

ZOLA | RECONFIGURABILITY

Zola is designed to enable change: components are inter-changeable, reconfigurable, and replaceable. Metal to metal bracketry and frames are designed for fast, easy reconfiguring, and new components can be added at any time. Its unique leveller provides exceptional levelling capability over large spans, and on uneven floors. Heavy duty casters provide seating with mobility. Each of the 6 sample configurations shown here use exactly the same components - highlighting Zola Modular has the ability to reconfigure again and again, in a myriad of different ways. Joining bracketry is underneath seats and backs, so no surfaces are marred or damaged when connected, and re-connected.

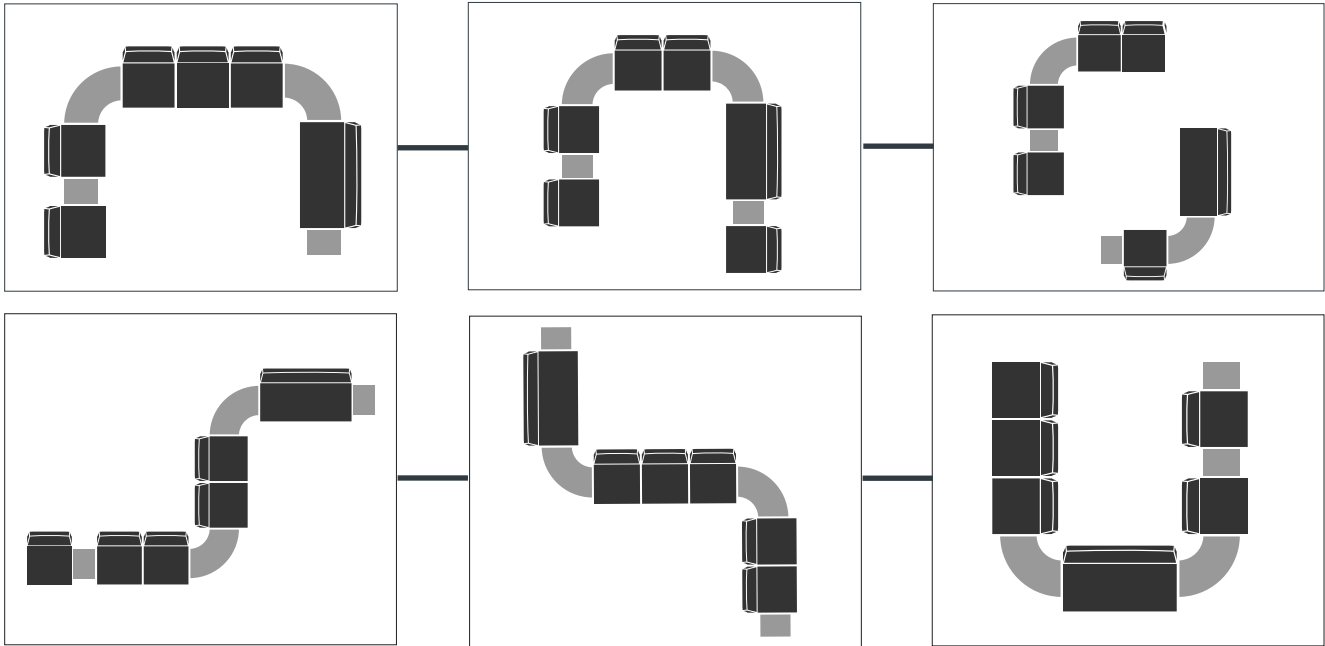

ZOLA | SEAM LOCATIONS

Due to the curved geometry of the upholstered backs, vertical seams are necessary for quality tailoring of the unit. Patterned Fabrics with "Distinctive details" - such as stripes, squares, straight lines and/or large details, will have noticeable changes in regards to the alignment of the patterns. 90 Degree units -both inside and outside curves are most noticeable. 60, 45 and 30 degree are also subject to this.

Approximate Dimensional Distortions on Patterns:

	Inside Curve	Outside Curve
30 Deg	1 ½"	1"
45 Deg	2"	1 ½"
60 Deg	2 ½"	2"
90 Deg	3"	2 ½"



Zola seat photo indicates location of seam.

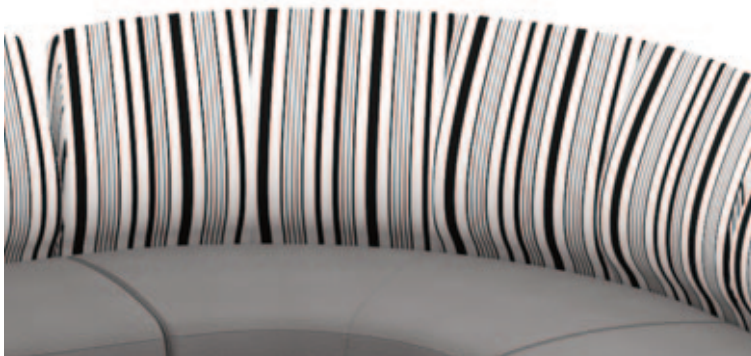

Inside Curve

Showing colliding stripes at the lumbar portion of the back, and opening stripes at the top and bottom.



Outside Curve

Showing colliding stripes at the upper and lower portion of the back, with opening stripes at the lumbar.

ZOLA | SAMPLE CONFIGURATIONS

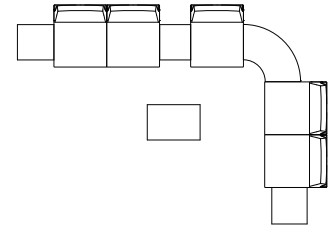
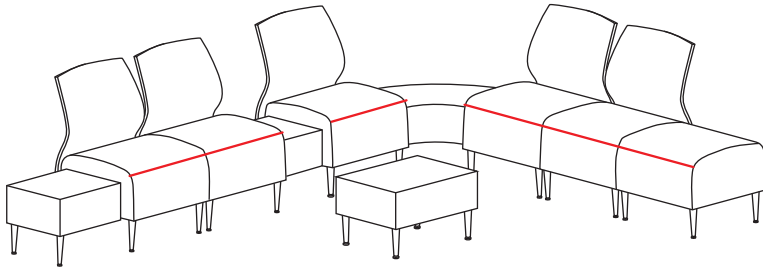

Model	Qty	Price (\$)	Beech
ZOL3 M1201	5	1377	
ZOL3 MS1S1	1	871	
ZOL4 LKM12	1	988	
ZOL4 LKE18	1	1098	
ZOL4 LKC90	1	1283	
ZOL4 241815	1	1187	
Total List		\$12,312	

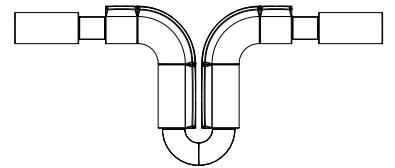
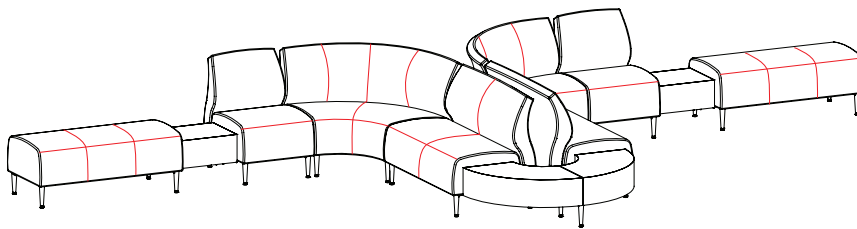

Model	Qty.	Price (\$)
ZOL3 MS2F1	2	1420
ZOL4 LKM18	2	1044
ZOL3 M1101	2	1518
ZOL3 MCIS90D	2	3487
ZOL3 M2101	2	2657
ZOL4 LKC90X2	1	2548
Total List		\$22,800

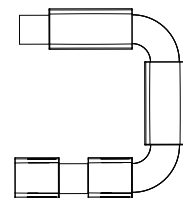
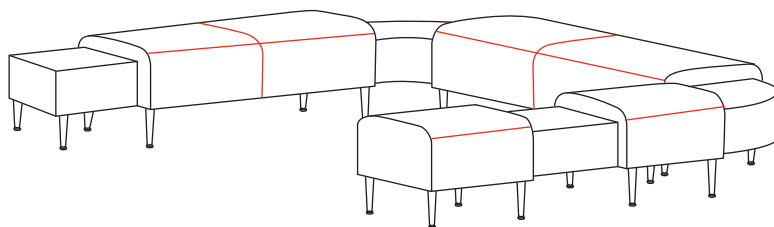

Model	Qty.	Price (\$)
ZOL3 MS1S1	2	871
ZOL3 MS21	2	1218
ZOL4 LKC90	2	1283
ZOL4 LKM18	2	1044
Total List		\$8,832

ZOLA | LOUNGE

DIMENSIONS

	Overall Width	Overall Depth	Overall Height	Seat Height	Height of Arms From Floor	Width Between Arms	Seat Depth	Shipping Weight	Cubes
One-Seat	29.25	27	34	18.5	26.75	23	19.25	67	21.5
Two-seat	52.25	27	34	18.5	26.75	46	19.25	90	38
Three-seat	75.25	27	34	18.5	26.75	69	19.25	116	54.5
One-Seat (Plus)	36.25	27	34	18.5	26.75	30	19.25	72	22.6

COM YARDAGES (Lounge Product Only Available with Arms)

	COM Entire Unit	COM 2 Entire Units	COM 3 Entire Units	COM 4 Entire Units
One-Seat	4	7.25	11.5	14.5
Two-seat	5.5	11	16	21.70
Three-seat	7.1	13.25	19	28
One-Seat (Plus)	4.5	9	13.5	18

COM YARDAGES (Individual Components)

	COM Yardage Per Seat	COM Yardage Per 2 Seats	COM Yardage Per 3 Seats	COM Yardage Per 4 Seats	COM Yardage Per Back	COM Yardage Per 2 Backs	COM Yardage Per 3 Backs
One-Seat	1.25	2.1	3.35	4.2	1.75	2.75	3.5
Two-seat	1.75	3.4	5.1	6.5	2.5	4.54	6.08
Three-seat	2.5	4.6	7	9	3.5	6.25	9
One-Seat (Plus)	1.25	2.5	3.75	5	1.75	3.5	5.25

COM YARDAGES (Individual Components)

	COM Yardage Per 4 Backs	COM Yardage Per Arm	COM Yardage Per 2 Arms	COM Yardage Per 3 Arms	COM Yardage Per 4 Arms
One-Seat	5.25	1.5	1.90	2.61	3.3
Two-seat	8.5	1.5	1.90	2.61	3.3
Three-seat	12.5	1.5	1.90	2.61	3.3
One-Seat (Plus)	7	1.5	1.90	2.61	3.3

To calculate the COM Yardage for more than 4 units, take the largest multiple (4 units) and add the closest remainder. See below for example calculations.

5 Units = Take the yardage for 4 units and add the yardage for 1 unit

6 Units = Take the yardage for 4 units and add the yardage for 2 units

7 Units = Take the yardage for 4 units and add the yardage for 3 units

8 Units = Take the yardage for 4 units and multiply by 2

9 Units = Take the yardage for 4 units, multiply by 2, add yardage for 1 unit

10 Units = Take the yardage for 4 units, multiply by 2, add yardage for 2 units

20 Units = Take the yardage for 4 units, multiply by 5

67 Units = Take the yardage for 4 units, multiply by 16, add yardage for 3 units

COMBINATION UPHOLSTERY OPTIONS

When combination upholstery is specified with fabric of the same grade or COM, an upcharge for dual fabrics is **\$33 list** per unit and **\$64 list** per unit for three fabrics will be applied. When graded in combination upholstery is selected, use the highest grade upholstery selected or to obtain a quote for blended grading contact Customer Service (please provide the fabrics specified and location of where each fabric is to be applied on the product).

ORDERING NOTES:

Please note, Zola Lounge chairs are pre-assembled at Krug and cannot be reconfigured into Modular units. Arms and backs cannot be removed from the seat. Zola Lounge chairs cannot be used in conjunction with Zola Linking Tables. Zola Plus Lounge Two-Seats and Three-Seats units have the same dimensions as the Regular Lounge Two-Seats and Three-seats. Zola Lounge chairs are not available with replacement components or covers. These options are only available on the Modular product.

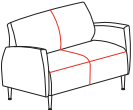
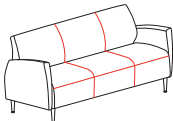
DESCRIPTION/MODEL	COM		COL	FABRIC GRADES			LEATHER			
	1	2	3	4	5	6	7	8	9	
	One-Seat ZOL3 F1111	2182	2301	2419	2625	2830	3036	3242	3283	3745
	One-Seat Plus ZOL3 FB1111	2419	2536	2657	2861	3068	3273	3479	3684	3983
NOTE: One-Seat Plus is 30" wide between arms.										
	Two-seat ZOL3 F2111	3223	3376	3517	3739	3960	4182	4401	4623	4971
	Two-seat Plus ZOL3 FB2111	3313	3462	3605	3825	4045	4268	4488	4710	5059
NOTE: The Two-Seat Plus comes standard with a fifth leg for extra support.										
	Three-seat ZOL3 F3111	4379	4602	4821	5263	5708	6149	6594	7036	7793
	Three-seat Plus ZOL3 FB3111	4483	4705	4924	5366	5810	6253	6692	7136	7896
NOTE: The Three-Seat Plus comes standard with a fifth leg for extra support.										

Zola Option Upcharges

Option	List	Option	A-White	Grades A-Color	B	C
4 Casters (#2 Leg Type below)	107	Solid Surface Arm Cap (per pair)	454	464	489	514
2 Casters/2 Legs (#3 Leg Type below)	77					
Urethane Arm Caps (pair)	242					

ORDERING NOTES: See below for caster and arm option selections, please clearly note Urethane or Solid Surface color on the purchase order. See page 207 for more information on Zola options and features. Plus versions are not available with Caster options.

PRODUCT CODE KEY

Line	Series	Chair Type	Seat Count	Back Type	Arm Type	Leg Type
ZOL Zola	3 Soft Seating	F Freestanding	1 One-Seat	1 Fully Uph Back	1 Uph Arm	1 Standard Leg + Glide
		FB Freestanding Plus Upgrade	2 Two-seat		2 Urethane Arm Cap	2 Casters
			3 Three-seat		3 Solid Surface Arm Cap	3 Combination 2 Front Standard Legs & 2 Rear Casters

ZOLA | MODULAR

DIMENSIONS - ARMLESS UNITS

	Overall Width	Overall Depth Uph. Back	Overall Depth Wood Back	Overall Height	Seat Height	Seat Depth	Shipping Weight	Cubes
One-Seat	23	27	24	34	18.5	19.25	57	9.75
Two-seat	46	27	24	34	18.5	19.25	89	17.6
Three-seat	69	27	24	34	18.5	19.25	122	26.3
One-Seat (Plus)	30	27	24	34	18.5	19.25	62	11.5

DIMENSIONS - WITH ARMS

	Overall Width	Overall Depth	Overall Height	Seat Height	Seat Depth	Shipping Weight	Cubes
One-Seat	29	27	34	18.5	19.25	88	9.75
Two-seat	52	27	34	18.5	19.25	120	17.6
Three-seat	75	27	34	18.5	19.25	154	26.3
One-Seat (Plus)	36	27	34	18.5	19.25	96	11.5

COM YARDAGES - ARMLESS UNITS

	COM Yardage Entire Unit wo/ Arms	COM Yardage 2 Entire Units wo/ Arms	COM Yardage 3 Entire Units wo/ Arms	COM Yardage 4 Entire Units wo/ Arms
One-Seat	2.2	4.6	6.38	8.8
Two-seat	3.8	7.9	10.75	14.5
Three-seat	5.75	11	16	22
One-Seat (Plus)	3.0	6.3	9.5	13.86

COM YARDAGES - WITH ARMS

	COM Yardage Entire Unit w/ Arms	COM Yardage 2 Entire Units w/ Arms	COM Yardage 3 Entire Units w/ Arms	COM Yardage 4 Entire Units w/ Arms
One-Seat	4	7.25	11.5	14.5
Two-seat	5.5	11	16	21.7
Three-seat	7.1	13.25	19	28
One-Seat (Plus)	4.5	9	13.5	18.3

COM YARDAGES - Individual Components

	COM Arms (Left & Right)	COM Yardage Per Back	COM Yardage Per 2 Backs	COM Yardage Per 3 Backs	COM Yardage Per 4 Backs	COM Yardage Per Seat	COM Yardage Per 2 Seats	COM Yardage Per 3 Seats	COM Yardage Per 4 Seats
One-Seat	1.90	1.75	2.75	3.5	5.25	1.25	2.1	3.4	4.2
Two-seat	1.90	2.5	4.5	6.08	8.5	1.7	3.4	5.1	6.5
Three-seat	1.90	3.5	6.25	9	12.5	2.5	4.6	7	9
One-Seat (Plus)	1.90	1.8	3.5	5.25	7	1.25	2.6	3.75	5.5

To calculate the COM Yardage for more than 4 units, take the largest multiple (4 units) and add the closest remainder. See below for example calculations.

- 5 Units = Take the yardage for 4 units and add the yardage for 1 unit
- 6 Units = Take the yardage for 4 units and add the yardage for 2 units
- 7 Units = Take the yardage for 4 units and add the yardage for 3 units
- 8 Units = Take the yardage for 4 units and multiple by 2
- 9 Units = Take the yardage for 4 units, multiply by 2, add yardage for 1 unit
- 10 Units = Take the yardage for 4 units, multiply by 2, add yardage for 2 units
- 20 Units = Take the yardage for 4 units, multiply by 5
- 67 Units = Take the yardage for 4 units, multiply by 16, add yardage for 3 units

Zola Modular Plus Two-Seats and Three-Seats units have the same dimensions as the Regular Modular Two-Seats and Three-seats.

COMBINATION UPHOLSTERY

When combination upholstery is with upholstery of the same grade or COM, an upcharge for dual fabrics is **\$33 list** per unit and **\$64 list** per unit for three fabrics will be applied. When graded in combination upholstery is selected, use the highest upholstery selected or contact Customer Service for a quote (please provide the fabrics specified and a description of where each fabric is to be applied on the product in order to obtain a quote)

PACKAGING

All Modular Units, and tables will be shipped KD (Knocked Down)

Upcharge for Removable Upholstery Covers:

Option Upcharge	\$ List	Option Upcharge	\$ List
Arms (Right or Left)	77	One-Seat - seat	47
Interim Arm	61	Two-seat - seat	68
One-Seat - back	68	Three-seat - seat	85
Two-seat - back	97	One-Seat Plus - seat	61
Three-seat - back	121		
One-Seat Plus - back	77		

FEATURES: For a complete listing of features see 208.

For pricing information on Zola Tables see page 544, Zola Benches see page 329 and Zola Tablets see page 218.

ZOLA | MODULAR -WOOD BACK



DESCRIPTION/MODEL/SPECIES	COM		COL		FABRIC GRADES				LEATHER		
	1	2	3	4	5	6	7	8	9		
	One-Seat, Wood or Palette Back, Armless										
	ZOL3 MW1201	Beech	1377	1409	1440	1504	1566	1631	1692	1755	1852
		Maple/Cherry	1416	1447	1480	1540	1606	1668	1732	1796	1890
		Palette	1377	1409	1440	1504	1566	1631	1692	1755	1852

	One-Seat, Wood or Palette Back w/ Upholstered Pad, Armless										
	ZOL3 MW1301	Beech	1597	1644	1676	1755	1818	1883	1946	2010	2135
		Maple/Cherry	1638	1685	1715	1796	1858	1922	1985	2048	2173
		Palette	1597	1644	1676	1755	1818	1883	1946	2010	2135

ORDERING NOTE: Zola Modular seating with wood backs are designed to be Armless. Zola Modular Arms can be specified on units wood back only as a special, please contact customer service for assistance.

ZOLA OPTION UPCHARGES	\$ List
4 Casters (#2 Leg Type below)	107
2 Casters/2 Legs (#3 Leg Type below)	77
Combination Upholstery - dual fabrics	33

ORDERING NOTES: Please note when Zola Modular Chairs are ordered, each chair is automatically supplied with two seat to seat brackets (ZOL3 RLKB2). All Modular Units, and tables will be shipped KD (knocked down).

DESCRIPTION/MODEL	SPECIES	COM		COL		FABRIC GRADES				LEATHER		COM SHIPPING		
		1	2	3	4	5	6	7	8	9	YARDAGE	WEIGHT	CUBES	
	One-Seat Wood/Palette Back w/ UPH Pad													
	ZOL3 MB13	Beech	619	633	648	680	714	744	778	0.6	808	21	853	3.1
		Maple/Cherry	665	680	696	729	760	791	808	0.6	840	21	904	3.1
		Palette	619	633	648	680	714	744	778	0.6	808	25	853	3.1
	One-Seat Wood/Palette Back													
	ZOL3 MB12	Beech	428								-	19	3.1	
		Maple/Cherry	468								-	19	3.1	
		Palette	428								-	23	3.1	

PRODUCT CODE KEY

Line	Series	Chair Type	Seat Count	Back Type	Arm Type	Leg Type
ZOL Zola	3 Soft Seating	MW Modular Wood Back	1 One-Seat	2 Wood Back	0 Armless	1 Standard Leg + Glide
				3 Wood Back with Uph Pad		2 Casters
						3 Combination 2 Front Standard Legs & 2 Rear Casters

ZOLA | MODULAR

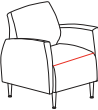
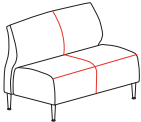
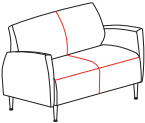
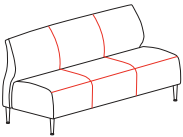
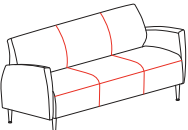
DESCRIPTION/MODEL	COM		COL	FABRIC GRADES			LEATHER				
	1	2	3	4	5	6	7	8	9		
	One-Seat, Upholstered Back Armless										
	ZOL3 M1101	n/a	1518	1597	1676	1818	1960	2105	2244	2387	2640
	One-Seat Plus, Upholstered Back, Armless										
ZOL3 MB1101	n/a	1644	1692	1772	1914	2056	2197	2341	2483	2738	
ORDERING NOTES: One-Seat Plus seat is 30" wide.											
	One-Seat, Upholstered Back with Arms										
	ZOL3 M1111		2324	2443	2554	2760	2964	3167	3376	3580	3890
	One-Seat Plus, Upholstered Back with Arms										
ZOL3 MB1111		2451	2568	2681	2884	3092	3294	3501	3708	4014	
ORDERING NOTES: One-Seat Plus is 30" wide between the arms.											
	Two-seat, Upholstered Back Armless										
	ZOL3 M2101	n/a	2657	2806	2948	3167	3390	3610	3831	4057	4401
	Two-seat Plus, Upholstered Back, Armless										
ZOL3 MB2101	n/a	2743	2893	3036	3257	3477	3699	3920	4142	4488	
	Two-seat, Upholstered Back with Arms										
	ZOL3 M2111		3462	3610	3756	3977	4197	4420	4639	4861	5210
	Two-seat Plus, Upholstered Back with Arms										
ZOL3 MB2111		3547	3699	3843	4064	4286	4505	4728	4948	5296	
	Three-seat, Upholstered Back Armless										
	ZOL3 M3101		3812	4033	4252	4694	5139	5581	6023	6466	7225
	Three-seat Plus Upholstered Back Armless										
ZOL3 MB3101		3914	4133	4355	4796	5241	5684	6124	6568	7327	
	Three-seat, Upholstered Back with Arms										
	ZOL3 M3111	n/a	4615	4838	5059	5502	5943	6387	6829	7270	8031
	Three-seat Plus Upholstered Back with Arms										
ZOL3 MB3111	n/a	4719	4941	5160	5604	6046	6491	6931	7373	8131	

ORDERING NOTES: See below for caster and arm option selections, please clearly note Urethane or Solid Surface color selection on the purchase order. Two-seat & Three-seat Plus versions are with a fifth leg or support. Plus versions are not available with Caster options. Please note when Zola Modular Chairs are ordered, each chair is automatically supplied with two seat to seat brackets (ZOL3 RLKB2). All Modular Units, and tables will be shipped KD (knocked down).

Zola Option Upcharges	List	Option	Grades			
			A-White	A-Color	B	C
4 Casters (#2 Leg Type below)	107	Solid Surface Arm Cap (per arm)	227	231	244	257
2 Casters/2 Legs (#3 Leg Type below)	77	Solid Surface Arm Cap (per pair)	454	464	489	514
Urethane Arm Caps (pair)	242	Solid Surface Arm Cap - Interim (per arm)	185	186	189	193

PRODUCT CODE KEY

Line	Series	Chair Type	Seat Count	Back Type	Arm Type	Leg Type
ZOL	3	M	1	1	0	1
Zola	Lounge	Modular	One-Seat	Fully Uph Back	Armless	Standard Leg + Glide
		MB	2		1	2
		Modular Plus Upgrade	Two-seat		Uph Arm	4 Casters
			3		2	3
			Three-seat		Urethane Arm Cap	Combination
					3	2 Front Standard Legs & 2 Rear Casters
					Solid Surface Arm Cap	

ZOLA | MODULAR BACKS & ARMS

DESCRIPTION/MODEL	COM		COL	FABRIC GRADES			LEATHER			COM YARDAGE	SHIPPING	
	1	2	3	4	5	6	7	8	9		WEIGHT	CUBES
 Left, Right, or Interim Arm ZOL3 MAL ZOL3 MAR ZOL3 MAI	491	532	569	651	729	808	886	963	1074	1.5	19	3.1
	348	365	381	411	444	477	509	538	586	0.33	13	1.8
	Left, Right, or Interim Arm - Urethane Cap											
ZOL3 MALU	619	658	696	778	853	934	1014	1092	1202	1.5	20.5	3
ZOL3 MARU												
ZOL3 MAIU	443	457	476	497	537	568	599	632	678	0.33	13	1.8

ORDERING NOTES:

The Interim Arm was designed to fit in between two seating units and therefore shortens the width between arms by 1" per seating unit. The interim Arm does not compromise the overall width of the combined benches. Zola Arms (left or right) are specified when seated. To specify Solid Surface Arm Cap add a "3" to the end of the model above, example ZOL3 MAL3, and clearly state color choice. (See page 631 for color selection)

Option	Grades			
	A-White	A-Color	B	C
Solid Surface Arm Cap (per arm)	227	231	244	257
Solid Surface Arm Cap (per pair)	454	464	489	514
Solid Surface Arm Cap - Interim (per arm)	185	186	189	193

DESCRIPTION/MODEL	SPECIES	COM		COL	FABRIC GRADES			LEATHER			COM YARDAGE	SHIPPING	
		1	2	3	4	5	6	7	8	9		WEIGHT	CUBES
 UPH Back ZOL3 MB11* ZOL3 MB21 ZOL3 MB31 ZOL3 MBB11		783	846	910	1036	1164	1289	1572	1699	1852	1.75	23	5.2
		1030	1116	1202	1377	1551	1724	1897	2072	2278	2.5	39	9.4
		1251	1359	1473	1692	1913	2135	2356	2579	2847	3.5	54	14
		871	934	997	1122	1251	1377	1504	1631	1796	2	28	6.1

ORDERING NOTES: The Two-seat & Three-seat Upholstered Backs are used for the Two-seat & Three-seat Plus units as well. Only Upholstered Backs can be used on Plus units.

ZOLA | SEATABLES

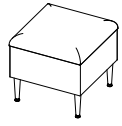
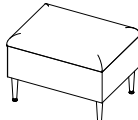
DESCRIPTION	MODEL	COM		COL	FABRIC GRADES			LEATHER			COM YARDAGE	WEIGHT	CUBE
		1	2	3	4	5	6	7	8	9			
 Round Seatable ZOL5-18D ZOL5-24D ZOL5-30D		693	716	739	771	809	843	879	928	974	1.3	18	5.2
		894	943	994	1064	1143	1215	1297	1396	1497	1.5	26	8.5
		1124	1181	1240	1318	1412	1492	1583	1695	1810	1.7	38	10.5
 Square Seatable ZOL5-1818 ZOL5-2424		759	805	848	912	984	1048	1120	1210	1303	1.3	27	5.2
		905	956	1004	1074	1155	1227	1307	1408	1508	1.5	38	8.5
 Rectangular Seatable ZOL5-2418 ZOL5-4824		832	875	921	985	1059	1120	1194	1284	1374	1.3	31	6.6
		1178	1240	1303	1389	1487	1572	1672	1798	1922	2.4	62	12.6

ORDERING NOTES: Height from floor is 17.5 inches.

ZOLA | MODULAR - REPLACEMENT COMPONENTS

DESCRIPTION/MODEL	SPECIES	COM		COL			FABRIC GRADES			LEATHER			COM YARDAGE	SHIPPING WEIGHT	CUBES
		1	2	3	4	5	6	7	8	9					



Replacement Modular One-Seat Wood Back

ZOL3 RBM12	Beech	365										-	19	3.1
	Maple/Cherry	405										-	19	3.1
	Palette	365										-	23	3.1



Replacement Modular One-Seat Wood Back w/ Upholstered Pad

ZOL3 RBM13	Beech	556	569	586	619	651	680	714	744	791	0.6	21	3.1
	Maple/Cherry	601	619	633	665	696	729	744	778	840	0.6	21	3.1
	Palette	556	569	586	619	651	680	714	744	791	0.6	25	3.1
ZOL3 RP	Replacement Back Pad -only	223	239	255	284	318	348	381	411	458	0.6	1.6	2



Replacement Upholstered Back

ZOL3 RBM11*		721	783	846	974	1098	1227	1510	1638	1788	1.75	23	5.2
ZOL3 RBM21		963	1053	1139	1314	1485	1662	1835	2010	2214	2.5	39	9.4
ZOL3 RBM31		1187	1297	1409	1631	1852	2072	2294	2516	2781	3.5	54	14
ZOL3 RBBM11		808	871	934	1061	1187	1314	1440	1566	1732	2	28	6.1

ORDERING NOTES: Modular Upholstered Replacement Backs are supplied with velcro upholstery that allows for assembly of existing "L" brackets on site prior to assembly to the bench. Replacement Backs do not include mounting brackets and legs and Replacement Seat/Benches do not include legs and joining brackets. The hardware can be transferred from the original component to the replacement component. If new hardware is required, Modular Arms/Backs/Benches should be ordered.



Right or Left Replacement Upholstered Arm

ZOL3 RAMR		435	477	514	595	672	752	832	910	1019	1.5	14	3
ZOL3 RAML													
ZOL3 RAMRU		562	601	641	721	799	878	957	1036	1146	1.5	15.5	3
ZOL3 RAMLU													

ORDERING NOTES: Zola Replacement arms (left or right) are specified when seated. Replacement Modular Arms are sent without modular hardware. Replacement Arms do not include mounting brackets. ZOL3 RAMRU & ZOL3 RAMLU are replacement arms with urethane cap. Zola replacement arms are available with Solid Surface Arm Caps, see option upcharge chart on page 216. Wood back units are not designed to be specified with standard Zola arms. Arms can be specified on wood back units only as a special - please contact Customer Service for assistance.



Replacement Upholstered Seat

ZOL3 RSM1*		778	822	871	957	1044	1134	1218	1305	1482	1.33	25	5.2
ZOL3 RSM2		1122	1178	1232	1354	1473	1589	1708	1827	2024	1.75	39	9.4
ZOL3 RSM3		1463	1540	1620	1788	1954	2118	2283	2451	2657	2.5	50	14
ZOL3 RSMB1		1004	1053	1098	1195	1289	1384	1480	1572	1715	1.75	26	6.1
ZOL3 RSMB2		1202	1266	1330	1447	1566	1685	1803	1922	2118	1.75	39	9.4
ZOL3 RSMB3		1755	1835	1914	2056	2197	2341	2483	2625	2847	2.5	50	14



Back Cover

ZOL3 RCB1*		302	365	428	556	680	808	934	1061	1266	2	2.8	1.7
ZOL3 RCB2		411	509	601	791	982	1170	1359	1551	1788	3	3.6	1.7
ZOL3 RCB3		509	633	760	1014	1266	1518	1772	2024	2341	3.75	4.3	1.7
ZOL3 RCBB1		336	397	458	586	714	840	963	1092	1283	2	2.8	1.7



Arm Covers Right, Left or Interim

ZOL3 RCAR		270	318	365	458	556	651	744	840	963	1.5	2.5	1.7
ZOL3 RCAL													
ZOL3 RCAI		176	190	207	239	270	302	334	365	405	0.33	1.5	1.7
ZOL3 RCARU		270	318	365	458	556	651	744	840	963	1.5	2.5	1.7
ZOL3 RCALU													





ORDERING NOTES: Replacement Arm Covers (left or right) are specified as seated. ZOL3 RCARU & ZOL3 RCALU are arm covers for arms with the urethane arm cap option.



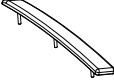

Seat Cover

ZOL3 RCS1*		270	318	365	458	556	651	744	840	982	1.33	2.3	1.7
ZOL3 RCS2		348	411	477	601	729	853	982	1108	1314	1.75	2.6	1.7
ZOL3 RCS3		444	521	601	680	760	840	916	997	1122	2.5	3.8	1.7
ZOL3 RCSB1		411	468	521	633	744	853	963	1074	1232	1.75	2.6	1.7

ZOLA | MODULAR - REPLACEMENT COMPONENTS & TABLETS

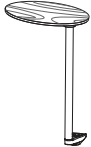
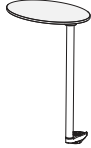
DESCRIPTION/MODEL	PRICE	SHIPPING			
		WEIGHT	CUBES		
 Caster Without Brake ZOL3 RC1	58	0.4	0125		
ORDERING NOTE: Casters cannot be ordered as replacement items for plus units.					
 Caster With Brake ZOL3 RC2	70	0.4	0.125		
ORDERING NOTE: Casters cannot be ordered as replacement items for plus units.					
	Urethane Arm Cap ZOL3 AUR	127	1.5	0.3	
	ZOL3 AUL		1.5	0.3	
	Urethane Arm Cap - Interim Arm ZOL3 AIU	94	1.0	0.3	
		Grades			
		A-White	A-Color	B	C
	Solid Surface Arm Cap (per arm) ZOL3 ASR	227	231	244	257
	ZOL3 ASL				
	Solid Surface Arm Cap - Interim (per arm) ZOL3 ASI	185	186	189	193
		1.5	0.3		
		1.0	0.3		

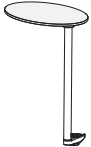
DESCRIPTION	MODEL	SPECIES	PRICE	WEIGHT	CUBE
	Wood Tablet ZOL3 T1	Beech Maple /Cherry	514 538	12	2
	Tablet with Palette Finish ZOL3 T2	n/a	411	12	2
	Clear Glass Tablet ZOL3 T3	n/a	783	13	2
	Laminate Tablet ZOL3 T4	n/a	532	12	2
ORDERING NOTES: The laminate tablet comes standard with a polymer edge. Please note Zola Tablets are universally handed and do not need to be specified right or left when ordering.					
	Solid Surface Tablet - Grade A White ZOL3 T5AW	n/a	641	14	2
	Solid Surface Tablet - Grade A Color ZOL3 T5AC	n/a	651	14	2
	Solid Surface Tablet - Grade B ZOL3 T5B	n/a	686	14	2
	Solid Surface Tablet - Grade C ZOL3 T5C	n/a	741	14	2

ZOLA | MODULAR CURVE

DIMENSIONS INSIDE CURVE

	Overall Width	Overall Depth	Overall Height	Seat Height	Seat Depth	Shipping Weight	Cubes
Single seat							
30°	36	28.5	34	18.5	22.5	50	18
45°	42	29	34	18.5	22.5	54	19
60°	48	29	34	18.5	22.5	57	22
90°	59	31	34	18.5	22.5	69	26
Double seat							
30°	58	30	34	18.5	22.5	90	32
45°	64	31	34	18.5	22.5	97.2	33
60°	70	33	34	18.5	22.5	102.6	39
90°	81	36	34	18.5	22.5	124.2	46

COM Yardages

	COM Yardage Entire Unit	COM Yardage 2 Entire Units	COM Yardage 3 Entire Units	COM Yardage 4 Entire Units
Single seat				
30°	3.70	7.4	11.1	14.8
45°	4.40	8.8	13.2	17.6
60°	4.40	8.8	13.2	17.6
90°	4.61	9.2	13.83	18.44
Double seat				
30°	6.3	12.6	18.9	25.2
45°	6.4	12.8	19.2	25.6
60°	8.2	16.4	24.6	32.8
90°	8.2	16.4	24.6	32.8

COM Yardages - Individual Components

	COM Yardage Per Back	COM Yardage Per 2 Backs	COM Yardage Per 3 Backs	COM Yardage Per 4 Backs	COM Yardage Per Seat	COM Yardage Per 2 Seats	COM Yardage Per 3 Seats	COM Yardage Per 4 Seats
Single seat								
30°	1.9	3.8	5.7	7.6	1.8	3.6	5.4	7.2
45°	2.6	5.2	7.8	10.4	1.8	3.6	5.4	7.2
60°	2.6	5.2	7.8	10.4	1.8	3.6	5.4	7.2
90°	2.8	5.6	8.4	11.2	1.8	3.6	5.4	7.2
Double seat								
30°	2.9	5.8	8.7	11.6	3.4	6.8	10.2	13.6
45°	3	6.0	9.0	12.0	3.4	6.8	10.2	13.6
60°	4.8	8.8	13.5	17.4	3.4	6.8	10.2	13.6
90°	4.8	8.8	13.5	17.4	3.4	6.8	10.2	13.6

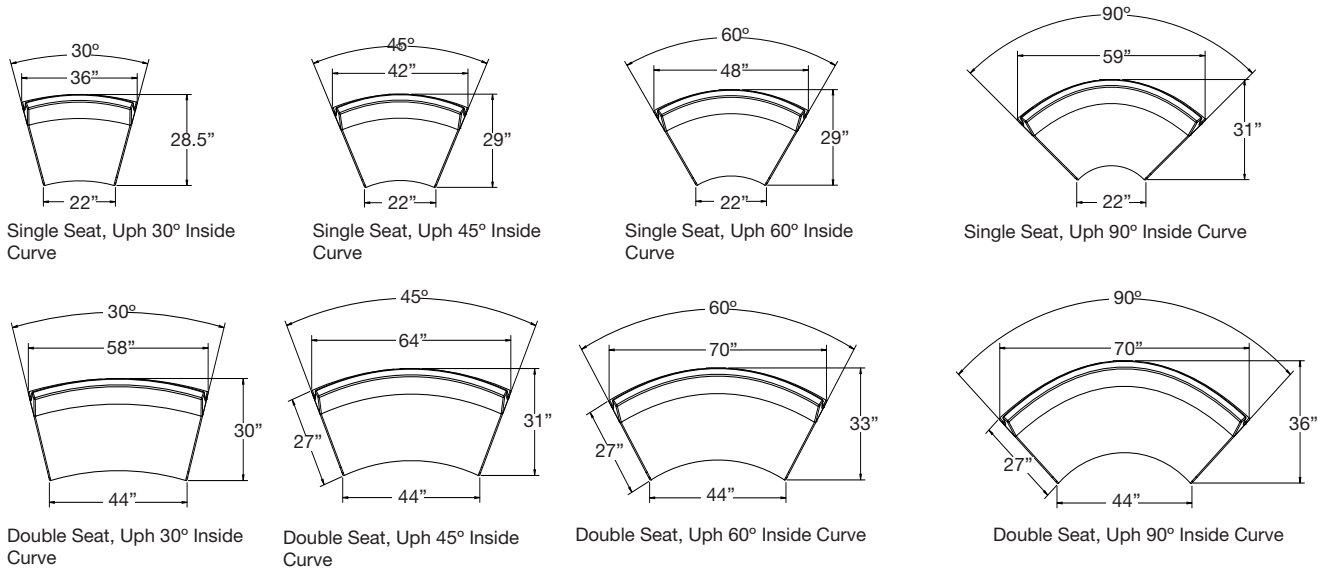

Upcharge for Removable Upholstery Covers:

Option	\$ List	Option	\$ List
Single-seat curve 30° seat	61	Double-seat curve 30° seat	93
Single-seat curve 45° seat	64	Double-seat curve 45° seat	101
Single-seat curve 60° seat	86	Double-seat curve 60° seat	123
Single-seat curve 90° seat	113	Double-seat curve 90° seat	127

DIMENSIONS OUTSIDE CURVE

	Overall Width	Overall Depth	Overall Height	Seat Height	Seat Depth	Shipping Weight	Cubes
Single seat							
30°	33.75	28.25	34	18.5	22.5	48	23
45°	38.75	28.75	34	18.5	22.5	49	24
60°	43.5	29.25	34	18.5	22.5	50	29
90°	52	29.75	34	18.5	22.5	51	34
Double seat							
30°	55.75	29.75	34	18.5	22.5	83	36
45°	60.75	31	34	18.5	22.5	84	40
60°	65.75	32.25	34	18.5	22.5	86	45
90°	74	34.5	34	18.5	22.5	96	56

COM Yardages

	COM Yardage Entire Unit	COM Yardage 2 Entire Units	COM Yardage 3 Entire Units	COM Yardage 4 Entire Units
Single seat				
30°	3.32	6.14	9.46	12.28
45°	3.32	6.14	9.46	12.28
60°	3.32	6.14	9.46	12.28
90°	3.32	6.14	9.46	12.28
Double seat				
30°	6.50	13.0	19.5	26.0
45°	6.50	13.0	19.5	26.0
60°	6.50	13.0	19.5	26.0
90°	6.50	13.0	19.5	26.0

COM Yardages - Individual Components

	COM Yardage Per Back	COM Yardage Per 2 Backs	COM Yardage Per 3 Backs	COM Yardage Per 4 Backs	COM Yardage Per Seat	COM Yardage Per 2 Seats	COM Yardage Per 3 Seats	COM Yardage Per 4 Seats
Single seat								
30°	1.7	2.95	4.65	5.9	1.8	3.6	5.4	7.2
45°	1.7	2.95	4.65	5.9	1.8	3.6	5.4	7.2
60°	1.7	2.95	4.65	5.9	1.8	3.6	5.4	7.2
90°	1.7	2.95	4.65	5.9	1.8	3.6	5.4	7.2
Double seat								
30°	3.1	6.2	9.3	12.4	3.4	6.8	10.2	13.6
45°	3.1	6.2	9.3	12.4	3.4	6.8	10.2	13.6
60°	3.1	6.2	9.3	12.4	3.4	6.8	10.2	13.6
90°	3.1	6.2	9.3	12.4	3.4	6.8	10.2	13.6
6.8	10.2	13.6						

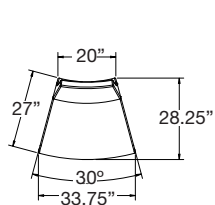

Single Seat, Uph 30° Outside Curve

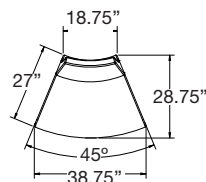

Single Seat, Uph 45° Outside Curve

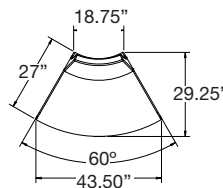

Single Seat, Uph 60° Outside Curve

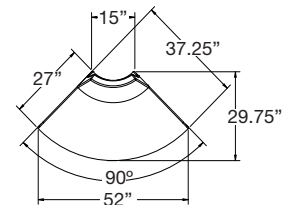

Single Seat, Uph 90° Outside Curve

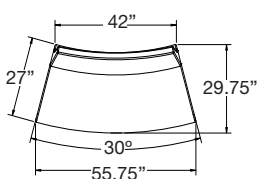

Double Seat, Uph 30° Outside Curve

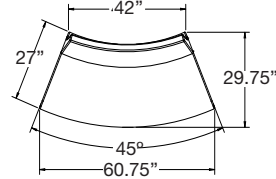

Double Seat, Uph 45° Outside Curve

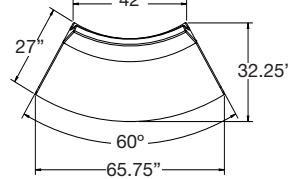

Double Seat, Uph 60° Outside Curve

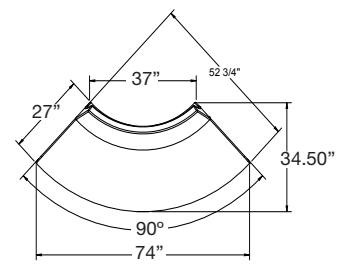





Double Seat, Uph 90° Outside Curve

Upcharge for Removable Upholstery Covers:

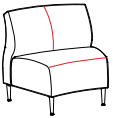
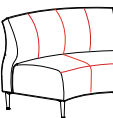
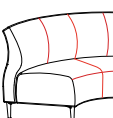
Option	\$ List	Option	\$ List
Single-seat curve 30° seat	61	Double-seat curve 30° seat	93
Single-seat curve 45° seat	64	Double-seat curve 45° seat	101
Single-seat curve 60° seat	86	Double-seat curve 60° seat	123
Single-seat curve 90° seat	113	Double-seat curve 90° seat	127

ZOLA | MODULAR CURVE

DESCRIPTION/MODEL	COM		COL		FABRIC GRADES			LEATHER		
	1	2	3	4	5	6	7	8	9	
	Single-Seat, 30° Inside Curve ZOL3 MCIS30D1	2302	2432	2559	2741	2947	3131	3336	3592	3851
	Single-Seat, 30° Inside Curve Plus ZOL3 MCBIS30D1	2399	2530	2657	2838	3045	3226	3432	3691	3949
	Single-Seat, 45° Inside Curve ZOL3 MCIS45D1	2709	2873	3038	3271	3538	3770	4037	4369	4704
	Single-Seat, 45° Inside Curve Plus ZOL3 MCBIS45D1	2818	2984	3147	3383	3648	3880	4146	4480	4813
	Single-Seat, 60° Inside Curve ZOL3 MCIS60D1	3069	3235	3399	3634	3899	4131	4397	4730	5063
	Single-Seat, 60° Inside Curve Plus ZOL3 MCBIS60D1	3193	3358	3523	3759	4024	4257	4522	4855	5188
	Single-Seat, 90° Inside Curve ZOL3 MCIS90D1	3487	3696	3904	4196	4530	4821	5155	5574	5993
	Single-Seat, 90° Inside Curve Plus ZOL3 MCBIS90D1	3652	3862	4068	4362	4694	4987	5320	5740	6159
	Single-Seat, 30° Outside Curve ZOL3 MCOS30D1	2072	2190	2304	2465	2654	2817	3001	3235	3465
	Single-Seat, 30° Outside Curve Plus ZOL3 MCBOS30D1	2169	2286	2403	2564	2748	2913	3097	3331	3562
	Single-Seat, 45° Outside Curve ZOL3 MCOS45D1	2436	2586	2738	2946	3185	3395	3634	3934	4233
	Single-Seat, 45° Outside Curve Plus ZOL3 MCBOS45D1	2546	2696	2847	3056	3294	3505	3743	4044	4341
	Single-Seat, 60° Outside Curve ZOL3 MCOS60D1	2763	2911	3061	3270	3510	3718	3958	4258	4557
	Single-Seat, 60° Outside Curve Plus ZOL3 MCBOS60D1	2888	3036	3187	3396	3635	3844	4083	4381	4681
	Single-Seat, 90° Outside Curve ZOL3 MCOS90D1	3137	3323	3513	3774	4077	4340	4641	5017	5393
	Single-Seat, 90° Outside Curve Plus ZOL3 MCBOS90D1	3303	3489	3679	3940	4242	4506	4809	5183	5559

ORDERING NOTES: Please note when Zola Modular Chairs are ordered, each chair is automatically supplied with two seat to seat brackets (ZOL3 RLKB2). All Modular Units, and tables will be shipped KD (knocked down).

PRODUCT CODE KEY

Line	Series	Chair Type	Curve Style	Seat Count	Seat Degree	Leg Type
ZOL	3	MC	I	S	30D	1
Zola	Soft Seating	Modular	Inside Curve	Single	30 Degree	Standard Leg + Glide
		MCB	O	D	45D	
		Modular Plus Upgrade	Outside Curve	Double	45 Degree	
					60D	
					60 Degree	
					90D	
					90 Degree	

ZOLA | MODULAR CURVE

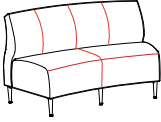
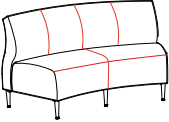
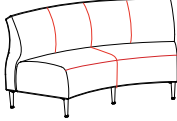
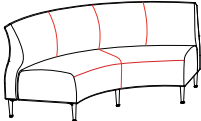
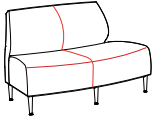
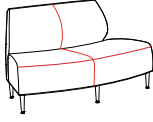
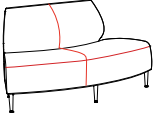
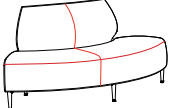
DESCRIPTION/MODEL	COM		COL		FABRIC GRADES			LEATHER		
	1	2	3	4	5	6	7	8	9	
	Double-Seat, 30° Inside Curve ZOL3 MCID30D1	4028	4252	4481	4795	5157	5473	5836	6289	6739
	Double-Seat, 30° Inside Curve Plus ZOL3 MCBID30D1	4182	4405	4633	4947	5309	5628	5989	6441	6893
	Double-Seat, 45° Inside Curve ZOL3 MCID45D1	4736	5028	5318	5722	6188	6598	7064	7644	8225
	Double-Seat, 45° Inside Curve Plus ZOL3 MCBID45D1	4917	5209	5497	5903	6369	6778	7242	7822	8406
	Double-Seat, 60° Inside Curve ZOL3 MCID60D1	5367	5659	5948	6357	6821	7229	7696	8276	8858
	Double-Seat, 60° Inside Curve Plus ZOL3 MCBID60D1	5560	5852	6141	6549	7016	7421	7888	8469	9051
	Double-Seat, 90° Inside Curve ZOL3 MCID90D1	6099	6465	6831	7342	7925	8438	9022	9755	10485
	Double-Seat, 90° Inside Curve Plus ZOL3 MCBID90D1	6319	6686	7049	7564	8146	8658	9244	9975	10705
	Double-Seat, 30° Outside Curve ZOL3 MCOD30D1	3626	3828	4033	4316	4643	4928	5254	5659	6069
	Double-Seat, 30° Outside Curve Plus ZOL3 MCBOD30D1	3777	3980	4185	4468	4795	5080	5405	5811	6221
	Double-Seat, 45° Outside Curve ZOL3 MCOD45D1	4263	4525	4786	5152	5571	5938	6357	6881	7402
	Double-Seat, 45° Outside Curve Plus ZOL3 MCBOD45D1	4442	4706	4966	5331	5751	6117	6536	7060	7582
	Double-Seat, 60° Outside Curve ZOL3 MCOD60D1	4831	5093	5355	5720	6139	6506	6925	7447	7971
	Double-Seat, 60° Outside Curve Plus ZOL3 MCBOD60D1	5023	5286	5548	5914	6333	6699	7119	7641	8164
	Double-Seat, 90° Outside Curve ZOL3 MCOD90D1	5488	5819	6146	6607	7134	7594	8121	8781	9438
	Double-Seat, 90° Outside Curve Plus ZOL3 MCBOD90D1	5708	6039	6366	6828	7356	7815	8342	8999	9657

ORDERING NOTES: Please note when Zola Modular Chairs are ordered, each chair is automatically supplied with two seat to seat brackets (ZOL3 RLKB2). All Modular Units, and tables will be shipped KD (knocked down).

PRODUCT CODE KEY

Line	Series	Chair Type	Curve Style	Seat Count	Seat Degree	Leg Type
ZOL	3	MC	I	S	30D	1
Zola	Soft Seating	Modular	Inside Curve	Single	30 Degree	Standard Leg + Glide
		MCB	O	D	45D	
		Modular Plus Upgrade	Outside Curve	Double	45 Degree	
					60D	
					60 Degree	
					90D	
					90 Degree	

ZOLA PRIVACY | ENVIRONMENTAL SUMMARY

LEED CI CREDIT



MATERIAL CONTENT:

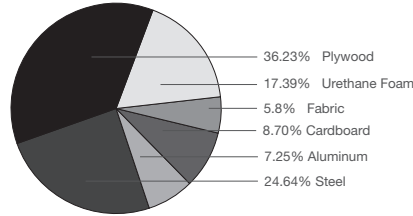

PRE-CONSUMER
RECYCLED CONTENT = 6.34%

POST-CONSUMER
RECYCLED CONTENT = 14.09%

Up to 40.58% of this Zola product is recyclable at the end of its useful life.

CONTRIBUTES TO

CREDIT 2.1 - 2.2	Construction Waste Management	1-2 point(s)
CREDIT 3.3	Resource Reuse	1 point
CREDIT 4.1	Recycled Content	1 point
CREDIT 4.5	Low Emitting Materials, Systems & Seating	1 point
CREDIT 5.1	Regional Materials*	1 point
CREDIT 7	Certified Wood (MUST BE REQUESTED)	1 point(s)

*This credit is only applicable if in total 20% of the combined value of the procurement of construction materials and in the furniture are manufactured within a radius of 500 miles. This credit will apply if the installation of the finished product occurs within 500 miles of Kitchener, Ontario.

level® CERTIFICATION, AIR EMISSIONS AND FSC® CERTIFICATION



level® CERTIFICATION

BIFMA's e3 Furniture Sustainability Standard is a voluntary, multi-attribute standard that measures the degree of sustainability of furniture. This standard evaluates product and company environmental attributes and compliance systems in a wide range of elements which include Materials, Energy & Atmosphere, Human & Ecosystem Health and Social Responsibility. Zola products have earned level®, BIFMA's sustainability certification program for furniture, certification through third-party verification against the e3 standard.

AIR-EMISSIONS

All Zola products are supplied with air-emissions certified. Contact customer service for information.



FSC®

In 2005, Krug received Forest Stewardship Council® (FSC®) Chain-of-Custody certification for our manufacturing facilities. The FSC® Chain-of-Custody tracks certified wood from seedling to final sale. It verifies that the material for our FSC® certified products only come from well-managed, FSC®-certified forests and other controlled sources. FSC® is dedicated to the promotion of responsible forest management worldwide helping to take care of forests for future generations. Zola and other Krug products can be specified with FSC® Certification. Contact customer service for further information, pricing and lead times.



Architects, designers, and building professionals can specify FSC®-certified products in order to achieve a point from the U.S. Green Building Council's Leadership in Energy and Environmental Design (LEED) Rating System.

ZOLA PRIVACY | FEATURES & OPTIONS



REPLACEABILITY

Zola is built to last: its heavy-duty structure is designed for intensive use environments. When any component is damaged or degraded, it can be easily changed out on its own, instead of having to replace or repair an entire unit. Along with its use of recycled and recyclable materials, the replaceability of components means Zola can provide exceptional long-term value, and be an investment in sustainability.

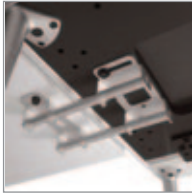

RECONFIGURABILITY

Zola is designed to enable change: components are inter-changeable, reconfigurable, and replaceable. Metal-to-metal brackets are designed for fast, easy reconfiguring, that does not damage or degrade the product, and new components can be added and added with ease. Arms can be added and reconfigured to either side of the unit. Its unique leveler provides exceptional leveling capability over large spans, and on uneven floors.



PRECONFIGURED

Zola Privacy can be specified in select preconfigured stand-alone arrangements. The offering includes one, two and three seat units in both Mid Height and Full Height styles. The units are pre-assembled with either full depth or semi-private side panels.



INTENSIVE USE ENVIRONMENTS

Zola has been designed for healthcare and other intensive use environments, with some important features: removable and replaceable upholstery covers, an anti-microbial finish, the option of a urethane arm cap and a standard clean-out between the seat and back. Modular construction allows for complete cleaning and disinfecting of the entire unit, and air emissions certification, make Zola an excellent solution for healthy spaces and care-giving environments. Plus styles are included in the offering.



BACK CONNECTION

The Zola Privacy back linking connectors are made of sturdy steel construction. It is a two part bracket fastened with metal-to-metal connections. Brackets are not visible when units are linked. Linked backs can only be reconfigured in the same start/center/end positions.



LINKING SEAT-TO-SEAT

The Zola seat-to-seat linking bracket is powder-coated steel construction in a black finish. This linking bracket is fastened with metal-to-metal connections from the seat to another seat with hardened steel bolts to ensure exceptional durability and strength. Brackets mount underneath, and do not mar or damage the tables or seats.

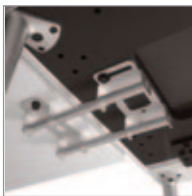

LINKING TABLE-TO-SEAT

The Zola table-to-seat bracket is powder-coated steel in a Silver Metallic finish to match the legs and casters. This linking bracket is fastened with metal-to-metal connections from the seat to the table.

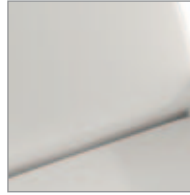

CLEAN OUT

Zola Lounge chairs have a built-in clean out feature: a space at the back of the seat that allows liquid, dirt and debris to fall to the floor for easy clean up and maintenance. The clean out feature was designed so that it does not detract from the comfort or appearance of the product.



LEGS

The legs offered on Zola Lounge are Silver Metallic or Matte Black and feature and feature glides that are adjustable up to 1.25", which provide leveling capability over longer spans. Caster leg is not available.



TWIN BACK

Zola Privacy is available in unique Twin Back models for both straight and curves styles. The one piece back-to-back design provides a clean, minimal solution for space division and maximizing seating.



COMBINATION UPHOLSTERY OPTIONS

When combination upholstery is specified with fabric of the same grade or COM, an upcharge for dual fabrics is **\$33 list** per unit and **\$64 list** per unit for three fabrics will be applied. When graded in combination upholstery is selected, use the highest grade upholstery selected or to obtain a quote for blended grading contact Customer Service (please provide the fabrics specified and location of where each fabric is to be applied on the product).



ANTI-MICROBIAL FINISH

Zola wood surfaces come with an anti-microbial finish that inhibits the growth of some molds and mildews. Surfaces coated in this finish support the reduction of fungal growth, and spores from germs, microbes and bacteria.

FINISH DURABILITY

Krug's finish, a proprietary catalyzed varnish formulation, has been repeatedly shown, through independent laboratory testing, to be the industry leader in durability and abrasion resistance. The Krug finish looks better longer than competitors, and is uniquely suited to the demands of high traffic environments.

PLUS UPGRADE

Zola seating is available with optional Plus Upgrade. Plus Seating has been engineered to support higher weight capacities, accommodating a wider variety of users.

WEIGHT CAPACITIES

Zola weight capacities are as follows:

One-Seat (Straight or curved)	- 300 lbs
One-Seat plus	- 750 lbs
Two-seat (Straight or curved)	- 525lbs
Two-seat plus	- 975 lbs
Three-seat	- 750 lbs
Three-seat plus	- 1150 lbs

ZOLA PRIVACY | OPTIONS



PRIVACY SCREEN

Zola Privacy Screens are made of durable frosted acrylic and can be mounted to both mid and full height backs. Steel mounting hardware enables screens to be replaced in the field.



TABLET

Optional Tablets are available in veneer, clear glass, laminate, and palette finishes. The Zola can be fastened by the Universal Tablet Mount (mounted left or right), to the single Zola leg, it is not able to mount on the Zola dual leg. The Zola Tablet has a turning radius of 360 degrees.



TABLES

Tables are available in veneer, high pressure laminate or Palette finishes - and an optional solid surface top. An optional flush-mounted Table PowerDoc provides dual power/USB outlets for multiple devices can be located on the front face of Middle or End Tables (not available on curvilinear models). PowerDoc's have a 10' cord.



MODULAR ARM

Modular arms can attach to the left or right ends of seating units as well as interim locations between units. They are fully upholstered and can optionally be trimmed with urethane or solid surface arm caps.



URETHANE ARM CAP

The optional urethane arm cap provides enhanced durability and protection for the arms. Urethane arm caps are available in two color options; Grey and Taupe. The urethane arm cap is field replaceable if damaged or degraded.



SOLID SURFACE ARM CAP

The optional Solid Surface Arm Cap provides enhanced durability, protection and cleanability for the arms. This is field replaceable if this becomes damaged or degraded and is available in 8 standard colors.



SHELVES & POWER

Back-mounted shelves can be specified in either 30", 36" or 42" and are available in veneer, laminate and Palette finishes (Solid surface overlay also available - contact customer service) The surface-mounted Shelf PowerDoc provides dual power/USB outlets for multiple devices. Units with Shelf Power are not available with Removable Cover option.



SEAT POWER

The flush-mounted power unit provides dual power/USB outlets for multiple devices. It can be located on either side of the seat, or on the seat front (not available on curved fronts). See page 287 for pricing. Power unit color is white. Units with Seat Power are not available with Removable Cover option.



PRIVATE MODULAR SIDE PANEL

Side Panels can be specified (in either of two heights) as Start, Center and End locations of configurations to provide an additional degree of privacy and enclosure, and a resting corner position for users - a beneficial element in study, work and waiting area settings. Side Panels will only connect to Center seating units.



SEMI-PRIVATE MODULAR SIDE PANEL

Semi-Private Side Panels are shallower in depth than standard Side Panels and available in Mid and Full Height back styles. They are specified as Start, Center and Ends and only connect to Center seating units.

In configurations such as banquette settings with tables, they can offer users privacy while still permitting side entry to the seating.



REPLACEMENT UPHOLSTERY COVERS

Replacement upholstery covers can be easily fitted onto Zola Modular components (with the exception of Zola Curve backs) originally ordered with Removable Upholstery Covers. It is possible to use replacement covers on modular components originally ordered with standard upholstery covers, but this requires some removal of staples and other basic upholstery. Please note that the tailoring of replacement upholstery covers can be less exact and refined in appearance than original upholstery.



REMOVABLE UPHOLSTERY COVERS

Removable Upholstery Covers are available on most Zola Modular upholstered components, (with the exception of Zola Curve backs) at an upcharge. This feature allows for upholstery covers to be cleaned and disinfected, and allows them to be field-replaced with replacement upholstery covers. Please note that the tailoring of Removable Upholstery Covers can be less exact and refined in appearance than standard upholstery. Replacement and removable covers, (supplied with Velcro) will tailor differently than the permanently stapled upholstery. Overall form and fit is identical, however minor dimensional build up due to the thickness of the Velcro can occur. The Velcro fastening build up is directed to the least noticeable face (usually the bottom edge of a component) where ever possible.

MOISTURE BARRIER & CAL 133

California Technical Bulletin 133 is a flammability test for seating. Krug offers a compliance method, in combination with non-flammable upholstery covers, may enable products to meet certification requirements for this test. This process at the same time also provides the products with a Moisture Barrier - a treatment that helps to prevent the passage of liquids and moisture to inside of the upholstered components - thereby conferring sanitary and anti-infection benefits. So when CAL 133 is specified, the product also automatically has a Moisture Barrier, and when a Moisture Barrier is specified, the product also features the compliance method and low flammability features of CAL 133.

The application of this up-charge and the compliance method does not mean that the specific configuration of product and upholstery cover are tested and officially certified as being CAL133 compliant. If the official certification is required, Krug will provide this (through an independent certified testing laboratory) at a charge of \$917 per item, plus the cost of the product to be tested. Lead time for certification testing is typically 4-8 weeks.

Krug assumes no responsibility for the testing of our products in combination with upholstery covers, or for the results of any testing conducted. Some specific configurations of products and upholstery have already been tested. Please contact Customer Service for additional information.

ZOLA PRIVACY | POWER LOCATIONS

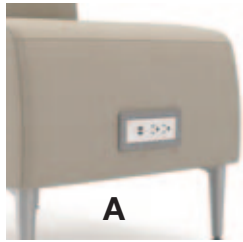

Seat Power

When ordering Seat Power clearly indicate required location using:

A - for front center of seat (not available on curved fronts)

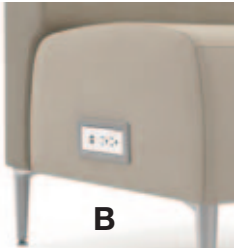

B - for left side of seat (facing)

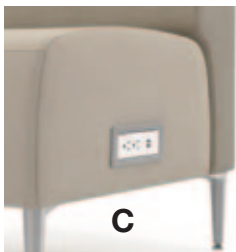

C - for right side of seat (facing)

D - for both left and right of seat

Units with Power are not available with Removable Cover option.



Shelf Power

Located mid-position on the shelf surface. Units with Shelf Power are not available with Removable Cover option.



Table Power

Located on the front face of the table as standard. To specify, clearly mark on the order and add **\$589 list**.



Under-mount Power

The Under-mount Power unit provides dual power/USB outlets for multiple devices. It can be located below seats and tables.

ZOLA PRIVACY | CONNECTING MULTIPLE UNITS

SEATING

Start, Center and End multiple units are used to configure continuous runs of seating. Units are specified from left to right (facing). Configurations must include one Start Unit and one End Unit and can be connected to any number of Center Units. Back connecting hardware is concealed once connected to the adjoining unit.

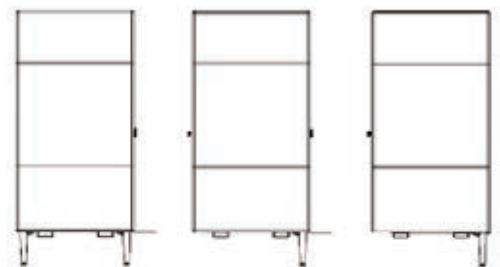

SIDE PANELS

Start, Center and End Panels are configured in combination with Center Seating only. Start and Center Panel kits contain additional legs which connect to the Center Seat Unit.

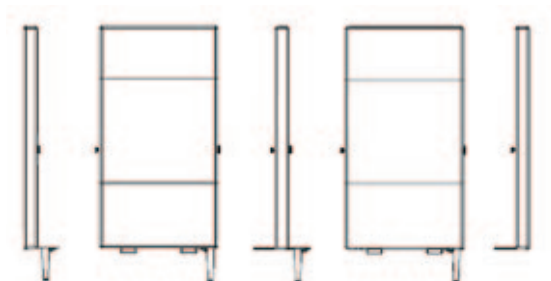

ZOLA PRIVACY | SAMPLE CONFIGURATIONS & PRICING

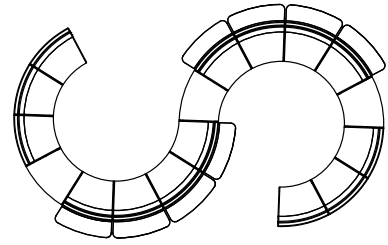
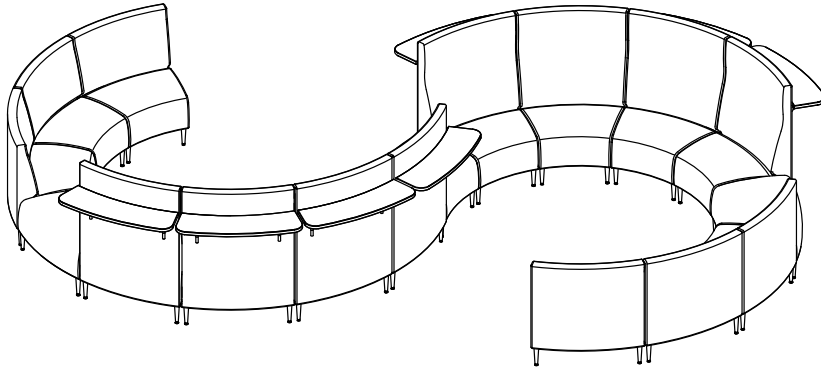

Model	Qty	Price (ea)
ZOP3-MCIS30DM0E	2	3273
ZOP3-MCIS30DM0C	2	3273
ZOP3-MCIS30DM0S	2	3273
ZOL3-MCS30DF1	3	1376
ZOP3-MCIS30DF1E	2	4047
ZOP3-MCIS30DF1C	4	4047
ZOP3-MCIS30DF1S	2	4047

Total \$56,142

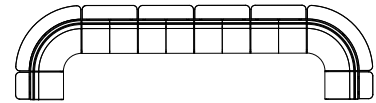
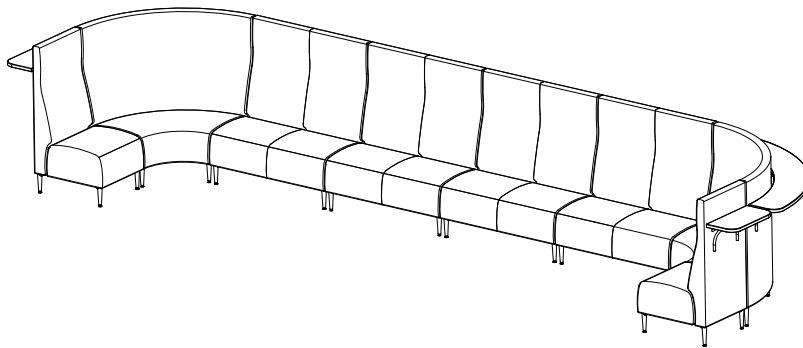

Model	Qty	Price (ea)
ZOP3-M1F1S	1	2364
ZOP3-MCIS90DF1C	2	5866
ZOP3-M2F1C	4	3563
ZOP3-M1F1S	1	2364

Total \$30,712

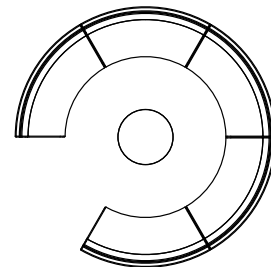
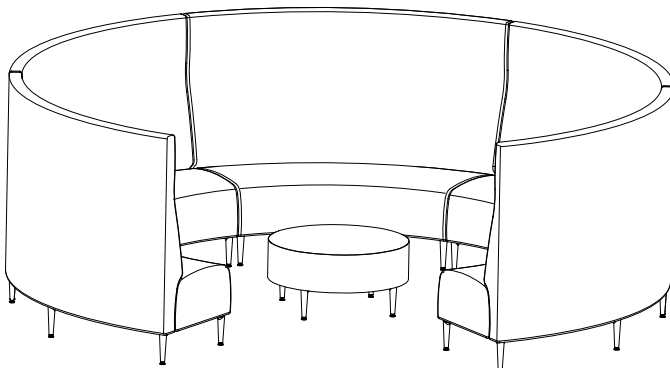

Model	Qty	Price (ea)
ZOP3-MCID60DF0S	1	5910
ZOP3-MCID60DF0C	3	5910
ZOP3-MCID60DF0E	1	5910
ZOL4-30D15	1	1391

Total \$30,941

ZOLA PRIVACY | SAMPLE CONFIGURATIONS & PRICING

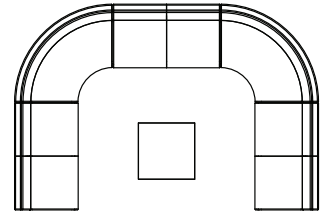
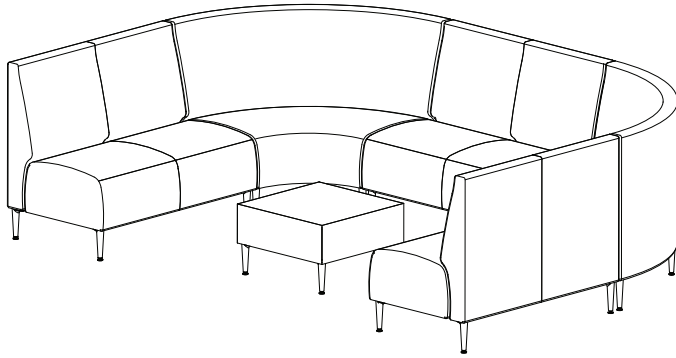

Model	Qty	Price (\$)
ZOP3-M2M0S	1	2595
ZOP3-MCIS90DM0C	2	4571
ZOP3-M2M0C	1	2595
ZOP3-M2M0E	1	2595
ZOL4-242415	1	1187

Total \$18,114

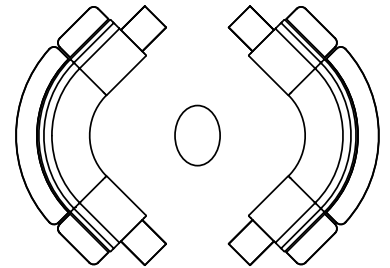
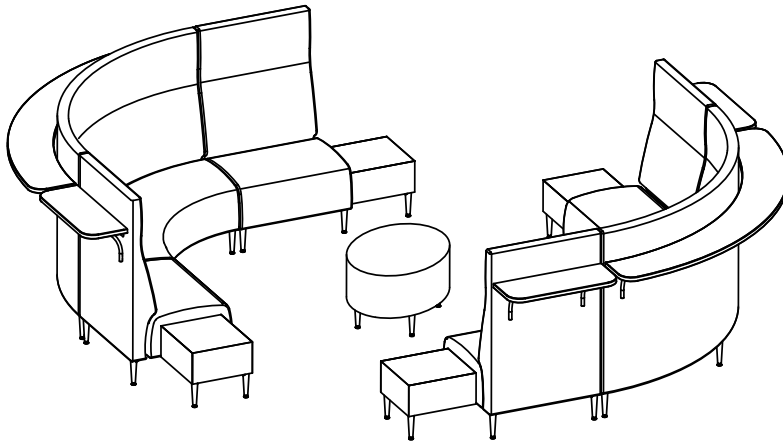

Model	Qty	Price (\$)
ZOL4-LKE18	4	1098
ZOP3-MB1F1S	2	2866
ZOP3-MCID90DF1C	2	7873
ZOP3-MB1F1E	2	2866
ZOL4 E482915	1	2016

Total \$33,618

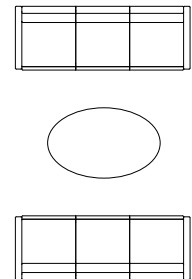
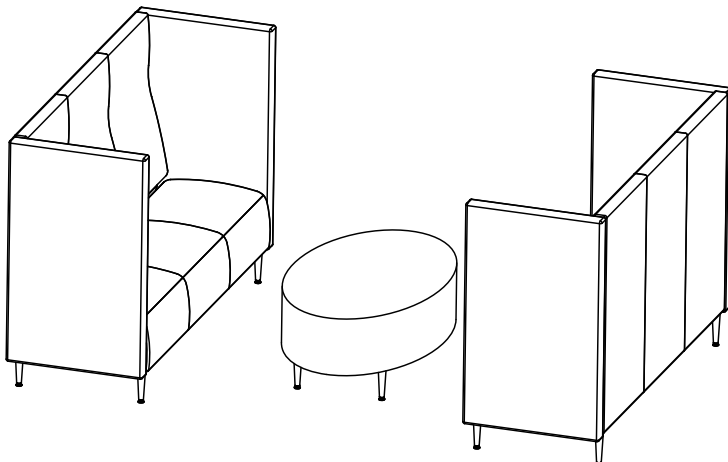

Model	Qty	Price (\$)
ZOP3-MPF0S	2	946
ZOP3-M3F0C	2	3972
ZOP3-MPF0E	2	946
ZOP4-E482915	1	2016

Total \$13,744

ZOLA PRIVACY | PRECONFIGURED - DIMENSIONS & COM REQUIREMENTS

DIMENSIONS

	Overall Width	Width Between Panels	Overall Depth	Overall Height	Seat Height	Seat Depth	Shipping Weight	Cubes
Preconfigured Full Height Back								
One-Seat Plus	36	30	27	50	18.5	19.25	134	28.3
Two-seat	52	46	27	50	18.5	19.25	161	40.4
Three-seat	75	69	27	50	18.5	19.25	194	57.5
Preconfigured Mid Height Back								
One-Seat Plus	36	30	27	37.5	18.5	19.25	114	20.4
Two-seat	52	46	27	37.5	18.5	19.25	141	29.1
Three-seat	75	69	27	37.5	18.5	19.25	174	41.3

COM YARDAGES

	Yardage Entire Unit	Yardage 2 Entire Units	Yardage 3 Entire Units	Yardage 4 Entire Units
Preconfigured Full Height Back/Privacy Panel				
One-Seat Plus	9.59	13.78	17.97	22.16
Two-seat	11.48	16.13	20.83	26.56
Three-seat	13.56	21.32	29.38	37.04
Preconfigured Mid Height Back/Privacy Panel				
One-Seat Plus	7.31	10.96	14.61	18.26
Two-seat	8.49	12.22	16.72	21.20
Three-seat	10.60	18.36	26.42	34.08
Preconfigured Full Height Back/Semi-Private Panel				
One-Seat Plus	6.63	10.82	15.01	19.20
Two-seat	8.52	13.17	17.87	23.60
Three-seat	10.60	18.36	25.42	34.08
Preconfigured Mid Height Back/Semi-Private Panel				
One-Seat Plus	5.41	9.06	12.71	16.36
Two-seat	6.59	10.32	14.82	19.30
Three-seat	8.48	14.80	21.42	27.20

ZOLA PRIVACY | PRECONFIGURED

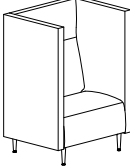
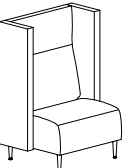
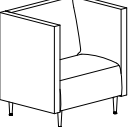
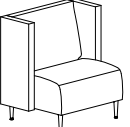
DESCRIPTION/MODEL	COM		COL		FABRIC GRADES			LEATHER	
	1	2	3	4	5	6	7	8	9
 One-Seat Plus with Private Modular Side Panel and Full Height Back ZOP3-PCB1MPF0	3956	4268	4583	5132	5708	6258	6835	7463	8461
 One-Seat Plus with Semi-Private Modular Side Panel and Full Height Back ZOP3-PCB1SMPF0	3229	3455	3683	4059	4461	4838	5241	5695	6347
 One-Seat Plus with Private Modular Side Panel and Mid Height Back ZOP3-PCB1MPPM0	3489	3717	3943	4339	4752	5142	5559	6014	6715
 One-Seat Plus with Semi-Private Modular Side Panel and Mid Height Back ZOP3-PCB1SMPM0	2983	3166	3354	3663	3994	4302	4634	5005	5539

ORDERING NOTES:

Zola Privacy Preconfigured is available in straight units with upholstered side panels. The One-Seat size is offered in 30" only, Plus upgrade is included (23" is not available). PowerDoc is optional on seat front only please mark clearly on the order and add upcharge listed below. PowerDoc's have a 10' cord.



ZOLA PRIVACY OPTION UPCHARGES \$ List

CAL 133 & Moisture Barrier (per yard)	64
Seat Power (per power unit)	641
Plus Upgrade option	included
Combination Upholstery - dual fabrics	33
Combination Upholstery -Three fabrics	64

PRODUCT CODE KEY

Line	Series	Type	Seat	Side Panel	Height
ZOP	3	PCB	1	MP	F0
Zola Privacy	Lounge	Pre-Configured Plus	One-Seat (30")	Private Modular Side Panel	Full Height
			2	SMP	M0
			Two-Seat	Semi-Private Modular Side Panel	Mid Height
			3		
			Three-Seat		

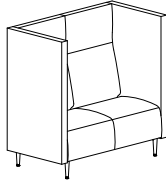
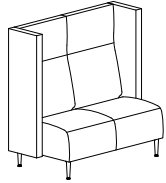
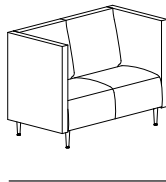
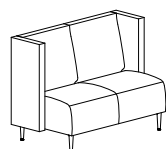
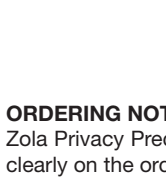
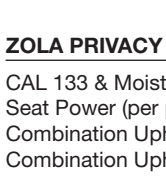
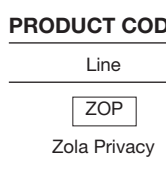
ZOLA PRIVACY | PRECONFIGURED

DESCRIPTION/MODEL	COM		COL		FABRIC GRADES			LEATHER	
	1	2	3	4	5	6	7	8	9
	Two-Seat with Private Modular Side Panel and Full Height Back								
	ZOP3-PC2MPF0	4571	4947	5327	5970	6653	7295	7977	8739
	Two-Seat Plus with Private Modular Side Panel and Full Height Back								
	ZOP3-PCB2MPF0	4702	5078	5456	6099	6783	7424	8107	8868
	Two-Seat with Semi-Private Modular Side Panel and Full Height Back								
	ZOP3-PC2SMPF0	3843	4134	4426	4897	5407	5876	6386	6970
	Two-Seat Plus with Semi-Private Modular Side Panel and Full Height Back								
	ZOP3-PCB2SMPF0	3972	4265	4557	5027	5537	6007	6515	7101
	Two-Seat with Private Modular Side Panel and Mid Height Back								
	ZOP3-PC2MPM0	3780	4059	4337	4811	5307	5775	6276	6836
	Two-Seat Plus with Private Modular Side Panel and Mid Height Back								
	ZOP3-PCB2MPM0	3909	4189	4467	4941	5437	5905	6406	6965
	Two-Seat with Semi-Private Modular Side Panel and Mid Height Back								
	ZOP3-PC2SMPM0	3271	3510	3746	4133	4548	4933	5349	5825
	Two-Seat Plus with Semi-Private Modular Side Panel and Mid Height Back								
	ZOP3-PCB2SMPM0	3403	3640	3877	4264	4679	5064	5481	5956

ORDERING NOTES:

Zola Privacy Preconfigured is available in straight units with upholstered side panels. PowerDoc is optional on seat front only please mark clearly on the order and add upcharge listed below. PowerDoc's have a 10' cord.



ZOLA PRIVACY OPTION UPCHARGES \$ List

CAL 133 & Moisture Barrier (per yard)	64
Seat Power (per power unit)	641
Combination Upholstery - dual fabrics	33
Combination Upholstery -Three fabrics	64

PRODUCT CODE KEY

Line	Series	Type	Seat	Side Panel	Height
ZOP	3	PC	1	MP	F0
Zola Privacy	Lounge	Pre-Configured	One-Seat (30")	Private Modular Side Panel	Full Height
		PCB	2	SMP	M0
		Pre-Configured Plus Upgrade	Two-Seat	Semi-Private Modular Side Panel	Mid Height
			3		
			Three-Seat		

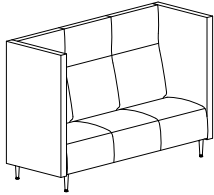
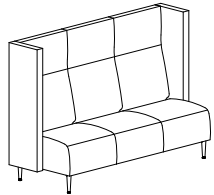
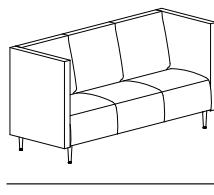
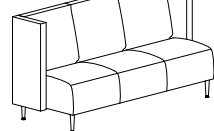
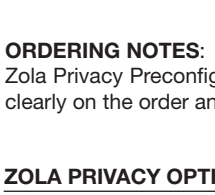
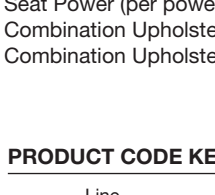
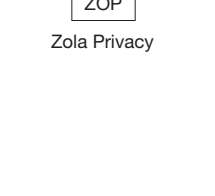
ZOLA PRIVACY | PRECONFIGURED

DESCRIPTION/MODEL	COM		COL		FABRIC GRADES			LEATHER	
	1	2	3	4	5	6	7	8	9
	Three-Seat with Private Modular Side Panel and Full Height Back								
	ZOP3-PC3MPF0	5495	5940	6390	7131	7923	8663	9457	10354
	Three-Seat Plus with Private Modular Side Panel and Full Height Back								
	ZOP3-PCB3MPF0	5691	6136	6585	7327	8119	8859	9652	10548
	Three-Seat with Semi-Private Modular Side Panel and Full Height Back								
	ZOP3-PC3SMPF0	4768	5128	5488	6057	6678	7243	7864	8587
	Three-Seat Plus with Semi-Private Modular Side Panel and Full Height Back								
	ZOP3-PCB3SMPF0	4964	5322	5684	6253	6872	7441	8059	8783
	Three-Seat with Private Modular Side Panel and Mid Height Back								
	ZOP3-PC3MPM0	4903	5244	5584	6148	6750	7309	7911	8595
	Three-Seat Plus with Private Modular Side Panel and Mid Height Back								
	ZOP3-PCB3MPM0	5098	5441	5781	6344	6945	7504	8107	8790
	Three-Seat with Semi-Private Modular Side Panel and Mid Height Back								
	ZOP3-PC3SMPM0	4396	4696	4995	5471	5990	6466	6985	7586
	Three-Seat Plus with Semi-Private Modular Side Panel and Mid Height Back								
	ZOP3-PCB3SMPM0	4591	4891	5191	5666	6185	6662	7180	7781

ORDERING NOTES:

Zola Privacy Preconfigured is available in straight units with upholstered side panels. PowerDoc is optional on seat front only please mark clearly on the order and add upcharge listed below. PowerDoc's have a 10' cord.

ZOLA PRIVACY OPTION UPCHARGES

\$ List

CAL 133 & Moisture Barrier (per yard)	64
Seat Power (per power unit)	641
Combination Upholstery - dual fabrics	33
Combination Upholstery -Three fabrics	64

PRODUCT CODE KEY

Line	Series	Type	Seat	Side Panel	Height
ZOP	3	PC	1	MP	F0
Zola Privacy	Lounge	Pre-Configured	One-Seat (30")	Private Modular Side Panel	Full Height
		PCB	2	SMP	M0
		Pre-Configured Plus Upgrade	Two-Seat	Semi-Private Modular Side Panel	Mid Height
			3		
			Three-Seat		

ZOLA PRIVACY | MODULAR - DIMENSIONS & COM REQUIREMENTS

DIMENSIONS

	Overall Width	Overall Depth	Depth w/ Shelf	Overall Height	Height w/Screen	Overall Seat Height	Seat Depth	Shipping Weight	Cubes
Full Height Back									
One-Seat	23	27	39	50	62.5	18.5	20.25	69	10.6
Two-seat	46	27	39	50	62.5	18.5	20.25	114	20.8
Three-seat	69	27	39	50	62.5	18.5	20.25	165	31.0
One-Seat (Plus)	30	27	39	50	62.5	18.5	20.25	81	13.8
Mid Height Back									
One-Seat	23	27	39	37.5	50	18.5	20.25	65	9.8
Two-seat	46	27	39	37.5	50	18.5	20.25	107	19.1
Three-seat	69	27	39	37.5	50	18.5	20.25	154	28.5
One-Seat (Plus)	30	27	39	37.5	50	18.5	20.25	76	12.6
Modular Corner Seat with Full Height Back									
One-Seat	27	27	40	50	62.5	18.5	20.25	104	26
One-Seat (Plus)	27	27	40	50	62.5	18.5	20.25	104	26
Modular Corner Seat with Mid Height Back									
One-Seat	27	27	40	37.5	50	18.5	20.25	93	26
One-Seat (Plus)	27	27	40	37.5	50	18.5	20.25	93	26

COM YARDAGES

	Yardage Entire Unit	Yardage 2 Entire Units	Yardage 3 Entire Units	Yardage 4 Entire Units	Yardage per Back	Yardage per 2 Backs	Yardage per 3 Backs	Yardage per 4 Backs	Yardage per Seat	Yardage per 2 Seats	Yardage per 3 Seats	Yardage per 4 Seats
Full Height Back												
One-Seat	4.1	6.45	10.55	12.9	2.85	4.35	7.2	8.7	1.25	2.1	3.35	4.2
Two-seat	6.08	10.73	16.76	21.16	4.33	7.33	11.66	14.66	1.75	3.4	5.1	6.5
Three-seat	8.16	15.92	23.98	31.64	5.66	11.32	16.98	22.64	2.5	4.6	7	9
One-Seat (Plus)	4.19	8.38	12.57	16.76	2.94	5.88	8.82	11.76	1.25	2.5	3.75	5
Mid Height Back												
One-Seat	3.25	5.2	8.45	10.4	2	3.1	4.2	6.2	1.25	2.1	3.35	4.2
Two-seat	4.83	8.56	13.34	16.82	3.08	5.16	8.24	10.32	1.75	3.4	5.1	6.5
Three-seat	6.72	13.04	19.66	25.88	4.22	8.44	12.66	16.88	2.5	4.6	7	9
One-Seat (Plus)	3.65	7.3	10.95	14.6	2.4	4.8	7.2	9.6	1.25	2.5	3.75	5
Modular Corner Seat with Full Height Back												
One-Seat	7.79	12	18	24	5.70	11.4	16.9	22.4	2.00	4	6	8
One-Seat (Plus)	7.79	12	18	24	5.70	11.4	16.9	22.4	2.00	4	6	8
Modular Corner Seat with Mid Height Back												
One-Seat	6.40	12	18	24	4.00	8	12	18	2.00	4	6	8
One-Seat (Plus)	6.40	12	18	24	4.00	8	12	18	2.00	4	6	8

ZOLA PRIVACY PLUS OPTION UPCHARGES

\$ List

Plus Upgrade Two-Seat	129
Plus Upgrade Three-Seat	195

NOTE: One-Seat Plus pricing includes Plus Upgrade, for Two-Seat and Three-Seat add a "B" to the model number and the option upcharge (per power unit) above.

ZOLA PRIVACY | MODULAR - PANELS & ARMS -DIMENSIONS & COM REQUIREMENTS

DIMENSIONS & COM REQUIREMENTS

		Overall Width	Overall Depth	Overall Height	Shipping Weight	Cubes	COM 1-unit	COM 2-units	COM 3-units	COM 4-units	COM 5-units	COM 6-units
Side Panel, Single, Full Height No Screen												
ZOP3-MPF0S	Start	2.75	27	43.90	38	3	2.7	5.38	8.06	10.75	13.44	16.13
ZOP3-MPF0C	Center	2.75	27	43.90	38	3	2.7	5.38	8.06	10.75	13.44	16.13
ZOP3-MPF0E	End	2.75	27	43.90	38	3	2.7	5.38	8.06	10.75	13.44	16.13
Side Panel, Single, Full Height with Screen												
ZOP3-MPF2S	Start	2.75	27	56.5	40	3	2.7	5.38	8.06	10.75	13.44	16.13
ZOP3-MPF2C	Center	2.75	27	56.5	40	3	2.7	5.38	8.06	10.75	13.44	16.13
ZOP3-MPF2E	End	2.75	27	56.5	40	3	2.7	5.38	8.06	10.75	13.44	16.13
Side Panel, Single, Mid Height No Screen												
ZOP3-MPM0S	Start	2.75	27	31.38	26	2	1.99	3.99	5.98	7.97	9.97	11.96
ZOP3-MPM0C	Center	2.75	27	31.38	26	2	1.99	3.99	5.98	7.97	9.97	11.96
ZOP3-MPM0E	End	2.75	27	31.38	26	2	1.99	3.99	5.98	7.97	9.97	11.96
Side Panel, Single, Mid Height with Screen												
ZOP3-MPM2S	Start	2.75	27	43.88	28	2	1.99	3.99	5.98	7.97	9.97	11.96
ZOP3-MPM2C	Center	2.75	27	43.88	28	2	1.99	3.99	5.98	7.97	9.97	11.96
ZOP3-MPM2E	End	2.75	27	43.88	28	2	1.99	3.99	5.98	7.97	9.97	11.96
Semi-Private Side Panel, Single, Full Height												
ZOP3-MSPF0S	Start	2.75	14.25	44	26	1.5	1.27	2.55	3.83	5.11	6.39	7.67
ZOP3-MSPF0C	Center	2.75	14.25	44	26	1.5	1.27	2.55	3.83	5.11	6.39	7.67
ZOP3-MSPF0E	End	2.75	14.25	44	21	1.5	1.27	2.55	3.83	5.11	6.39	7.67
Semi-Private Side Panel, Single, Mid Height												
ZOP3-MSPM0S	Start	2.75	14.25	31.4	19	1	.88	1.99	2.92	3.72	4.65	5.56
ZOP3-MSPM0C	Center	2.75	14.25	31.4	23	1	.88	1.99	2.92	3.72	4.65	5.56
ZOP3-MSPM0E	End	2.75	14.25	31.4	19	1	.88	1.99	2.92	3.72	4.65	5.56
Modular Upholstered Arm												
ZOP3-MAUPLH*		3	14.5	19.75	25	1.1	1.33	2.11	2.8	3.56	4.44	5
ZOP3-MAUPHR		3	14.5	19.75	25	1.1	1.33	2.11	2.8	3.56	4.44	5
ZOP3-MAUPHC		3	14.5	19.75	25	1.1	1.33	2.11	2.8	3.56	4.44	5
Modular Upholstered Arm w/Urethane Cap												
ZOP3-MAUREL		3	14.5	20.25	28	1.1	1.33	2.11	2.8	3.56	4.44	5
ZOP3-MAURER*		3	14.5	20.25	28	1.1	1.33	2.11	2.8	3.56	4.44	5
ZOP3-MAUREC		3	14.5	20.25	28	1.1	1.33	2.11	2.8	3.56	4.44	5
Modular Upholstered Arm w/Solid Surface Cap												
ZOP3-MASSCL		3	14.5	20.25	28	1.1	1.33	2.11	2.8	3.56	4.44	5
ZOP3-MASSCR		3	14.5	20.25	28	1.1	1.33	2.11	2.8	3.56	4.44	5
ZOP3-MASSCI*		3	14.5	20.25	28	1.1	1.33	2.11	2.8	3.56	4.44	5

ZOLA PRIVACY | MODULAR

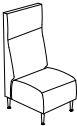
DESCRIPTION/MODEL/SPECIES	COM		COL	FABRIC GRADES			LEATHER		
	1	2	3	4	5	6	7	8	9
 One-Seat, Full Height Back ZOP3-M1F0F	1924	2060	2195	2388	2610	2804	3025	3294	3581

 One-Seat, Full Height Back with Shelf Option ZOP3-M1F1_ Beech/Laminate	2364	2500	2636	2829	3052	3244	3463	3736	4022
Maple/Palette	2460	2594	2732	2924	3144	3340	3560	3829	4116

ORDERING NOTES: When ordering units with shelf option please clearly specify on your order the required shelf height - 42", 36" or 30". Freestanding, Start and End units with the shelf option require counterbalance weight added to each seat unit, please add **\$303 list** upcharge per unit. Units with shelf option are not available with Removable Back Cover option.

 One-Seat, Full Height Back with Privacy Screen Option ZOP3-M1F2F	2209	2342	2479	2671	2892	3087	3307	3578	3865
---	------	------	------	------	------	------	------	------	------

ORDERING NOTES: Units with Privacy Screen Option are not available with Removable Back Cover option.

 One-Seat, Mid Height Back ZOP3-M1M0F	1811	1918	2026	2176	2348	2502	2673	2888	3109
---	------	------	------	------	------	------	------	------	------

 One-Seat, Mid Height Back with Shelf Option ZOP3-M1M1_ Beech/Laminate	2252	2357	2464	2615	2789	2942	3114	3327	3547
Maple/Palette	2346	2452	2560	2713	2883	3036	3209	3424	3643

ORDERING NOTES: When ordering units with shelf option please clearly specify on your order the required shelf height - 42", 36" or 30". Freestanding, Start and End units with the shelf option require counterbalance weight added to each seat unit, please add **\$303 list** upcharge per unit. Units with shelf option are not available with Removable Back Cover option.

 One-Seat, Mid Height Back with Privacy Screen Option ZOP3-M1M2F	2092	2198	2307	2460	2632	2783	2957	3169	3390
--	------	------	------	------	------	------	------	------	------

ORDERING NOTES: Units with Privacy Screen Option are not available with Removable Back Cover option.

Zola Privacy Option Upcharges

	\$ List	\$ List
Moisture Barrier & CAL 133(per yard)	64	Seat Power (per unit)
Removable Seat Covers One-Seat	47	Shelf Power
Removable Back Covers One-Seat	68	Table Power
Dual Leg (for Multiple unit configurations)	80	Combination Upholstery - dual fabrics
		33

PRODUCT CODE KEY

Line	Series	Chair Type	Seat Count	Back Type	Leg Type
ZOP Zola	3 Lounge	M Modular	1 One Seat	F0 Full Height Back	F Freestanding Unit
			2 Two Seat	F1 Full Height Back with Shelf Option	S Start Unit
			3 Three Seat	F2 Full Height Back with Privacy Screen Option	C Center Unit
				M0 Mid Height Back	E End Unit
				M1 Mid Height Back with Shelf Option	
				M2 Mid Height Back with Privacy Screen Option	

ZOLA PRIVACY | MODULAR

DESCRIPTION/MODEL/SPECIES	COM		COL	FABRIC GRADES			LEATHER		
	1	2	3	4	5	6	7	8	9



One-Seat Plus, Full Height Back
ZOP3-MB1F0F

2413	2549	2684	2879	3099	3292	3513	3785	4070
------	------	------	------	------	------	------	------	------



One-Seat Plus, Full Height Back with Shelf Option

ZOP3-MB1F1_ Beech/Laminate
Maple/Palette

2866	3001	3137	3330	3553	3744	3965	4237	4525
2963	3097	3235	3428	3647	3843	4063	4334	4618

ORDERING NOTES: When ordering units with shelf option please clearly specify on your order the required shelf height - 42", 36" or 30". Freestanding, Start and End units with the shelf option require counterbalance weight added to each seat unit, please add **\$303 list** upcharge per unit. Units with shelf option are not available with Removable Back Cover option.



One-Seat Plus, Full Height Back with Privacy Screen Option

ZOP3-MB1F2F

2770	2906	3040	3236	3456	3648	3870	4141	4427
------	------	------	------	------	------	------	------	------

ORDERING NOTES: Units with Privacy Screen Option are not available with Removable Back Cover option.



One-Seat Plus, Mid Height Back

ZOP3-MB1M0F

2304	2411	2518	2670	2844	2994	3166	3382	3603
------	------	------	------	------	------	------	------	------



One-Seat Plus, Mid Height Back with Shelf Option

ZOP3-MB1M1_ Beech/Laminate
Maple/Palette

2757	2863	2970	3122	3294	3448	3620	3834	4057
2853	2959	3068	3219	3390	3542	3715	3931	4152

ORDERING NOTES: When ordering units with shelf option please clearly specify on your order the required shelf height - 42", 36" or 30". Freestanding, Start and End units with the shelf option require counterbalance weight added to each seat unit, please add **\$303 list** upcharge per unit. Units with shelf option are not available with Removable Back Cover option.



One-Seat Plus, Mid Height Back with Privacy Screen Option

ZOP3-MB1M2F

2661	2768	2877	3028	3200	3352	3523	3739	3959
------	------	------	------	------	------	------	------	------

ORDERING NOTES: Units with Privacy Screen Option are not available with Removable Back Cover option.

Zola Privacy Option Upcharges

\$ List

\$ List

Moisture Barrier & CAL 133(per yard)	64	Seat Power (per unit)	641
Removable Seat Covers One-Seat	47	Shelf Power	599
Removable Back Covers One-Seat	68	Table Power	589
Dual Leg (for Multiple unit configurations)	80	Combination Upholstery - dual fabrics	33

PRODUCT CODE KEY

Line	Series	Chair Type	Seat Count	Back Type	Leg Type
ZOP	3	M	1	F0	F
Zola	Lounge	Modular	One Seat	Full Height Back	Freestanding Unit
		MB	2	F1	S
		Modular Plus Upgrade	Two Seat	Full Height Back with Shelf Option	Start Unit
			3	F2	C
			Three Seat	Full Height Back with Privacy Screen Option	Center Unit
				M0	E
				Mid Height Back	End Unit
				M1	
				Mid Height Back with Shelf Option	
				M2	
				Mid Height Back with Privacy Screen Option	

ZOLA PRIVACY | MODULAR

DESCRIPTION/MODEL/SPECIES	COM		COL	FABRIC GRADES			LEATHER		
	1	2	3	4	5	6	7	8	9



Two-Seat, Full Height Back ZOP3-M2F0F	3029	3231	3430	3717	4044	4334	4658	5061	5490
--	------	------	------	------	------	------	------	------	------



Two-Seat, Full Height Back Shelf Option ZOP3-M2F1_ Beech/Laminate	3563	3763	3963	4252	4580	4867	5192	5595	6023
Maple/Palette	3663	3864	4064	4352	4679	4967	5292	5693	6122

ORDERING NOTES: When ordering units with shelf option please clearly specify on your order the required shelf height - 42", 36" or 30". Freestanding, Start and End units with the shelf option require counterbalance weight added to each seat unit, please add **\$303 list** upcharge per unit. Units with shelf option are not available with Removable Back Cover option.



Two-Seat, Full Height Back with Privacy Screen Option ZOP3-M2F2F	3519	3718	3920	4207	4534	4822	5006	5549	5978
---	------	------	------	------	------	------	------	------	------

ORDERING NOTES: Units with Privacy Screen Option are not available with Removable Back Cover option.



Two-Seat, Mid Height Back ZOP3-M2M0F	2595	2754	2913	3141	3399	3628	3886	4205	4537
---	------	------	------	------	------	------	------	------	------



Two-Seat, Mid Height Back with Shelf Option ZOP3-M2M1_ Beech/Laminate	3132	3290	3449	3678	3934	4162	4421	4738	5072
Maple/Palette	3231	3388	3546	3774	4035	4261	4520	4838	5171

ORDERING NOTES: When ordering units with shelf option please clearly specify on your order the required shelf height - 42", 36" or 30". Freestanding, Start and End units with the shelf option require counterbalance weight added to each seat unit, please add **\$303 list** upcharge per unit. Units with shelf option are not available with Removable Back Cover option.



Two-Seat, Mid Height Back with Privacy Screen Option ZOP3-M2M2F	3087	3245	3404	3633	3891	4117	4377	4693	5030
--	------	------	------	------	------	------	------	------	------

ORDERING NOTES: Units with Privacy Screen Option are not available with Removable Back Cover option.

Zola Privacy Option Upcharges	\$ List		\$ List
Moisture Barrier & CAL 133(per yard)	64	Seat Power (per unit)	641
Removable Seat Covers One-Seat	68	Shelf Power	599
Removable Back Covers One-Seat	97	Table Power	589
Dual Leg (for Multiple unit configurations)	80	Plus Upgrade Two-Seat (B)	129
Combination Upholstery - dual fabrics	33		

PRODUCT CODE KEY

Line	Series	Chair Type	Seat Count	Back Type	Leg Type
ZOP Zola	3 Lounge	M Modular	1 One Seat	F0 Full Height Back	F Freestanding Unit
		MB Modular Plus Upgrade	2 Two Seat	F1 Full Height Back with Shelf Option	S Start Unit
			3 Three Seat	F2 Full Height Back with Privacy Screen Option	C Center Unit
				M0 Mid Height Back	E End Unit
				M1 Mid Height Back with Shelf Option	
				M2 Mid Height Back with Privacy Screen Option	

ZOLA PRIVACY | MODULAR

DESCRIPTION/MODEL/SPECIES	COM		COL	FABRIC GRADES			LEATHER		
	1	2	3	4	5	6	7	8	9
 Three-Seat, Full Height Back ZOP3-M3F0F	3983	4252	4524	4906	5345	5730	6166	6707	7271

	Three-Seat, Full Height Back Shelf Option										
	ZOP3-M3F1_	Beech/Laminate	4610	4879	5149	5534	5971	6358	6793	7332	7899
		Maple/Palette	4713	4984	5255	5638	6077	6463	6897	7437	8005

ORDERING NOTES: When ordering units with shelf option please clearly specify on your order the required shelf height - 42", 36" or 30". Freestanding, Start and End units with the shelf option require counterbalance weight added to each seat unit, please add **\$303 list** upcharge per unit. Units with shelf option are not available with Removable Back Cover option.

	Three-Seat, Full Height Back with Privacy Screen Option									
	ZOP3-M3F2F		4683	4952	5220	5608	6045	6431	6867	7405

ORDERING NOTES: Units with Privacy Screen Option are not available with Removable Back Cover option.

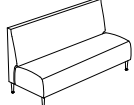
	Three-Seat, Mid Height Back									
ZOP3-M3M0F		3748	3972	4192	4510	4870	5190	5552	5994	6466

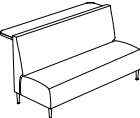
	Three-Seat, Mid Height Back Shelf Option										
	ZOP3-M3M1_	Beech/Laminate	4377	4599	4818	5138	5498	5815	6180	6621	7092
		Maple/Palette	4481	4705	4923	5242	5604	5920	6284	6725	7197

ORDERING NOTES: When ordering units with shelf option please clearly specify on your order the required shelf height - 42", 36" or 30". Freestanding, Start and End units with the shelf option require counterbalance weight added to each seat unit, please add **\$303 list** upcharge per unit. Units with shelf option are not available with Removable Back Cover option.

	Three-Seat, Mid Height Back with Privacy Screen Option									
	ZOP3-M3M2F		4449	4670	4891	5211	5572	5890	6252	6692







ORDERING NOTES: Units with Privacy Screen Option are not available with Removable Back Cover option.

Zola Privacy Option Upcharges	\$ List		\$ List
Moisture Barrier & CAL 133(per yard)	64	Seat Power (per unit)	641
Removable Seat Covers Three-Seat	85	Shelf Power	599
Removable Back Covers Three-Seat	121	Table Power	589
Dual Leg (for Multiple unit configurations)	80	Plus Upgrade Three-Seat (B)	195
Combination Upholstery - dual fabrics	33		

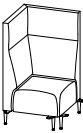
PRODUCT CODE KEY

Line	Series	Chair Type	Seat Count	Back Type	Leg Type
ZOP	3	M	1	F0	F
Zola	Lounge	Modular	One Seat	Full Height Back	Freestanding Unit
		MB	2	F1	S
		Modular Plus Upgrade	Two Seat	Full Height Back with Shelf Option	Start Unit
			3	F2	C
			Three Seat	Full Height Back with Privacy Screen Option	Center Unit
				M0	E
				Mid Height Back	End Unit
				M1	
				Mid Height Back with Shelf Option	
				M2	
				Mid Height Back with Privacy Screen Option	

ZOLA PRIVACY | MODULAR

DESCRIPTION/MODEL/SPECIES	COM		COL	FABRIC GRADES			LEATHER			
	1	2	3	4	5	6	7	8	9	
 Modular Corner Seat with Full Height Back ZOP3-MCF0	4058	4290	4522	4846	5219	5546	5917	6382	6848	
 Modular Corner Seat, Full Height Back with Shelves ZOP3-MCF1LR	Beech/Laminate	4937	5169	5403	5727	6099	6424	6796	7262	7729
	Maple/Palette	5033	5264	5497	5823	6196	6521	6893	7358	7822
 Modular Corner Seat, Full Height Back with single shelf left* ZOP3-MCF1L	Beech/Laminate	4744	4988	5233	5574	5966	6308	6697	7185	7333
	Maple/Palette	4749	4992	5236	5579	5970	6312	6703	7190	7337
 Modular Corner Seat, Full Height Back with single shelf right ZOP3-MCF1R	Beech/Laminate	4744	4988	5233	5574	5966	6308	6697	7185	7333
	Maple/Palette	4749	4992	5236	5579	5970	6312	6703	7190	7337
 Modular Corner Seat, Full Height Back with Privacy Screens ZOP3-MCF2LR	4624	4857	5089	5414	5787	6113	6484	6948	7416	
 Modular Corner Seat, Full Height Back with Privacy Screen Left ZOP3-MCF2L	4573	4816	5061	5404	5793	6136	6524	7015	7161	
	Modular Corner Seat, Full Height Back with Privacy Screen Right ZOP3-MCF2R	4573	4816	5061	5404	5793	6136	6524	7015	7161

Zola Privacy Option Upcharges







\$ List

Moisture Barrier & CAL 133(per yard)	64
Shelf Power	599
Dual Leg (for Multiple unit configurations)	80
Plus Upgrade- Corner Seat	64
Combination Upholstery - dual fabrics	33

PRODUCT CODE KEY

Line	Series	Chair Type	Back Type	Shelf/Screen
ZOP Zola	3 Lounge	MC Modular Corner Seat	F0 Full Height Back	L Left Side
		MCB Modular Corner Seat Plus	F1 Full Height Back with Shelf Option	R Right Side
			F2 Full Height Back with Privacy Screen Option	LR Left & Right Sides

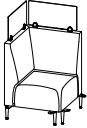
ZOLA PRIVACY | MODULAR

DESCRIPTION/MODEL/SPECIES	COM		COL	FABRIC GRADES			LEATHER		
	1	2	3	4	5	6	7	8	9
 Modular Corner Seat with Mid Height Back ZOP3-MCM0	3263	3455	3646	3916	4222	4491	4798	5183	5568
 Modular Corner Seat, Mid Height Back with Shelves ZOP3-MCM1LR	Beech/Laminate 4141	4335	4527	4795	5103	5370	5679	6061	6447
	Maple/Palette 4237	4429	4622	4890	5197	5468	5773	6158	6542
 Modular Corner Seat, Mid Height Back with Single Shelf left ZOP3-MCM1L	Beech/Laminate 3909	4112	4313	4595	4919	5201	5524	5925	6052
	Maple/Palette 3914	4116	4385	4600	4922	5205	5528	5929	6055
 Modular Corner Seat, Mid Height Back with Single Shelf Right* ZOP3-MCM1R	Beech/Laminate 3909	4112	4313	4595	4919	5201	5524	5925	6052
	Maple/Palette 3914	4116	4385	4600	4922	5205	5528	5929	6055
 Modular Corner Seat, Mid Height Back with Privacy Screens ZOP3-MCM2LR	3829	4022	4214	4483	4790	5059	5366	5748	6135
 Modular Corner Seat, Full Height Back with Privacy Screen Left* ZOP3-MCM2L	3738	3940	4141	4423	4746	5030	5351	5755	5880
 Modular Corner Seat, Full Height Back with Privacy Screen Right ZOP3-MCM2R	3738	3940	4141	4423	4746	5030	5351	5755	5880

Zola Privacy Option Upcharges





\$ List

Moisture Barrier & CAL 133(per yard)	64
Shelf Power	599
Dual Leg (for Multiple unit configurations)	80
Plus Upgrade- Corner Seat	64
Combination Upholstery - dual fabrics	33

PRODUCT CODE KEY

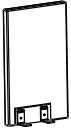
Line	Series	Chair Type	Back Type	Shelf/Screen
ZOP	3	MC	M0	L
Zola	Lounge	Modular Corner Seat	Mid Height Back	Left Side
		MCB	M1	R
		Modular Corner Seat Plus	Mid Height Back with Shelf Option	Right Side
			M2	LR
			Mid Height Back with Privacy Screen Option	Left & Right Sides

ZOLA PRIVACY | SIDE PANELS

DESCRIPTION/MODEL	COM		COL			FABRIC GRADES			LEATHER		
	1	2	3	4	5	6	7	8	9		
	Side Panel, Single, Full Height No Screen										
	ZOP3-MPF0S	Start	948	1036	1124	1304	1481	1660	1836	2016	2370
	ZOP3-MPF0C	Center	1222	1310	1398	1578	1753	1932	2109	2286	2642
	ZOP3-MPF0E	End	948	1036	1124	1304	1481	1660	1836	2016	2370
	Side Panel, Single, Full Height with Screen										
	ZOP3-MPF2S	Start	1243	1332	1420	1597	1776	1954	2132	2310	2665
	ZOP3-MPF2C	Center	1515	1606	1693	1871	2051	2228	2406	2584	2938
	ZOP3-MPF2E	End	1243	1332	1420	1597	1776	1954	2132	2310	2665
	Side Panel, Single, Mid Height No Screen										
	ZOP3-MPM0S	Start	767	829	888	1011	1131	1251	1372	1492	1732
	ZOP3-MPM0C	Center	1052	1110	1170	1290	1412	1533	1653	1773	2016
	ZOP3-MPM0E	End	767	829	888	1011	1131	1251	1372	1492	1732
	Side Panel, Single, Mid Height with Screen										
	ZOP3-MPM2S	Start	1063	1122	1183	1306	1425	1547	1667	1788	2029
	ZOP3-MPM2C	Center	1346	1405	1465	1587	1706	1827	1947	2066	2310
	ZOP3-MPM2E	End	1063	1122	1183	1306	1425	1547	1667	1788	2029

ORDERING NOTE: Side Panels will only connect to Center seating units. Units with Privacy Screen Option are not available with Removable Back Cover (per backoption).

PRODUCT CODE KEY

Line	Series	Chair Type	Height	Position
ZOP	3	MP	F0	S
Zola	Lounge	Modular Side Panel	Full Height	Start
			F2	C
			Full Height with Privacy Screen Option	Center
			M0	E
			Mid Height	End
			M2	
			Mid Height with Privacy Screen Option	

ZOLA PRIVACY | SEMI-PRIVATE SIDE PANELS & MODULAR ARMS

DESCRIPTION/MODEL	COM		COL			FABRIC GRADES			LEATHER		
	1	2	3	4	5	6	7	8	9		
	Semi-Private Side Panel, Single, Full Height										
	ZOP3-MSPF0S	Start	583	628	674	765	856	949	1039	1132	1314
	ZOP3-MSPF0C	Center	857	905	952	1041	1134	1224	1315	1407	1589
	ZOP3-MSPF0E	End	583	628	674	765	856	949	1039	1132	1314

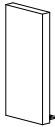
	Semi-Private Side Panel, Single, Mid Height										
	ZOP3-MSPM0S	Start	514	555	592	672	751	829	909	987	1143
	ZOP3-MSPM0C	Center	796	835	875	955	1033	1111	1191	1269	1428
	ZOP3-MSPM0E	End	514	555	592	672	751	829	909	987	1143

ORDERING NOTE: Semi-Private Side Panels will only connect to Center seating units.

PRODUCT CODE KEY

Line	Series	Chair Type	Height	Position
ZOP Zola	3 Lounge	MSP Modular Semi-Private Side Panel	F0 Full Height M0 Mid Height	S Start C Center E End

ZOLA PRIVACY | MODULAR ARMS

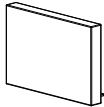
DESCRIPTION/MODEL	COM		COL			FABRIC GRADES			LEATHER		
	1	2	3	4	5	6	7	8	9		
	Modular Upholstered Arm										
	ZOP3-MAUPHL*		702	740	778	853	930	1004	1081	1155	1307
	ZOP3-MAUPHR		702	740	778	853	930	1004	1081	1155	1307
	ZOP3-MAUPHC		784	823	859	935	1012	1087	1163	1239	1390

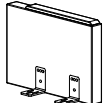
	Modular Upholstered Arm w/Urethane Cap										
	ZOP3-MAUREL		840	878	914	990	1066	1141	1218	1292	1445
	ZOP3-MAURER*		840	878	914	990	1066	1141	1218	1292	1445
	ZOP3-MAUREC		906	942	981	1058	1134	1207	1284	1358	1510

ORDERING NOTE: To specify Solid Surface Arm Caps on Modular Upholstered Arms, please add upcharge below and change UPH in the model number to SSC.

Zola Option Upcharges	Grades			
	A-White	A-Color	B	C
Solid Surface Arm Cap (per arm)	129	136	151	157

PRODUCT CODE KEY

Line	Series	Type	Arm	Position
ZOP Zola	3 Lounge	MA Modular Arm	UPH Upholstered URE Upholstered Arm w/Urethane Cap SSC Upholstered Arm w/Solid Surface Cap	L Left Hand Facing R Right Hand facing C Center

ZOLA PRIVACY | TWIN - DIMENSIONS & COM REQUIREMENTS

DIMENSIONS

	Overall Width	Width with Arms	Overall Depth	Depth w/ Shelf	Overall Height	Overall Height w/Screen	Seat Height	Seat Depth	Shipping Weight	Cubes
Twin Full Height Back										
One-Seat	23	29	52	n/a	50	62.5	18.5	20.25	102	21.0
Two-seat	46	52	52	n/a	50	62.5	18.5	20.25	171	41.2
Three-seat	69	75	52	n/a	50	62.5	18.5	20.25	241	61.3
One-Seat (Plus)	30	36	52	n/a	50	62.5	18.5	20.25	128	27.1
Twin Mid Height Back										
One-Seat	23	29	52	n/a	37.5	50	18.5	20.25	99	15.1
Two-seat	46	52	52	n/a	37.5	50	18.5	20.25	166	29.6
Three-seat	69	75	52	n/a	37.5	50	18.5	20.25	234	44.1
One-Seat (Plus)	30	36	52	n/a	37.5	50	18.5	20.25	124	19.5

COM YARDAGES

	Yardage Entire Unit	Yardage 2 Entire Units	Yardage 3 Entire Units	Yardage 4 Entire Units	Yardage per Back	Yardage per 2 Backs	Yardage per 3 Backs	Yardage per 4 Backs	Yardage per Seat	Yardage per 2 Seats	Yardage per 3 Seats	Yardage per 4 Seats
Twin Full Height Back												
One-Seat	5.03	8.73	13.76	17.46	2.93	4.53	7.46	9.06	2.1	4.2	6.3	8.4
Two-seat	7.93	14.23	22.16	28.46	4.53	7.73	12.26	15.46	3.4	6.5	9.9	13
Three-seat	10.48	20.76	31.24	41.52	5.88	11.76	17.64	23.52	4.6	9	13.6	18
One-Seat (Plus)	5.6	11.2	16.8	22.4	3.1	6.2	9.3	12.4	2.5	5	7.5	10
Twin Mid Height Back												
One-Seat	4.3	7.52	11.82	15.04	2.2	3.32	5.52	6.64	2.1	4.2	6.3	8.4
Two-seat	6.84	12.38	19.22	24.76	3.44	5.88	9.32	11.76	3.4	6.5	9.9	13
Three-seat	8.9	17.6	26.5	35.2	4.3	8.6	12.9	17.2	4.6	9	13.6	18
One-Seat (Plus)	5	10	15	20	2.5	5	7.5	10	2.5	5	7.5	10

ZOLA PRIVACY PLUS UPGRADE OPTION UPCHARGES

	\$ List
Plus Upgrade Twin Two-Seat	259
Plus Upgrade Twin Three-Seat	388







NOTE: Twin One-Seat Plus pricing includes Plus Upgrade, for Two-Seat and Three-Seat add a "B" to the model number and the option upcharge (per unit) above.

ZOLA PRIVACY | TWIN MODULAR PANELS & MODULAR ARMS

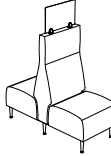
DIMENSIONS & COM REQUIREMENTS

		Overall Width	Overall Depth	Overall Height	Shipping Weight	Cubes	COM 1-unit	COM 2-units	COM 3-units	COM 4-units	COM 5-units	COM 6-units
Side Panel, Single, Full Height No Screen												
ZOP3-MPTF0U	Universal	2.75	51.5	43.9	66	6	4	5.5	9.34	12.03	14.72	18.7
ZOP3-MPTF0C	Center	2.75	51.5	43.9	66	6	4	5.5	9.34	12.03	14.72	18.7
Side Panel, Single, Full Height with Screen												
ZOP3-MPTF2U	Universal	2.75	51.5	56.4	68	6	4	5.5	9.34	12.03	14.72	18.7
ZOP3-MPTF2C	Center	2.75	51.5	56.4	68	6	4	5.5	9.34	12.03	14.72	18.7
Side Panel, Single, Mid Height No Screen												
ZOP3-MPTM0U	Universal	2.75	51.5	31.38	46	4	2.92	4.92	6.91	8.90	10.9	13.82
ZOP3-MPTM0C	Center	2.75	51.5	31.38	46	4	2.92	4.92	6.91	8.90	10.9	13.82
Side Panel, Single, Mid Height with Screen												
ZOP3-MPTM2U	Universal	2.75	51.5	43.88	48	4	2.92	4.92	6.91	8.90	10.9	13.82
ZOP3-MPTM2C	Center	2.75	51.5	43.88	48	4	2.92	4.92	6.91	8.90	10.9	13.82
Twin Semi-Private Side Panel, Single, Full Height												
ZOP3-MSPTF0U	Universal	2.75	26.5	44	43	2.5	2.69	5.38	8.06	10.75	13.44	16.13
ZOP3-MSPTF0C	Center	2.75	26.5	44	52	2.5	2.69	5.38	8.06	10.75	13.44	16.13
Twin Semi-Private Side Panel, Single, Mid Height												
ZOP3-MSPTM0U	Universal	2.75	26.5	31.4	32	1.7	1.75	3.99	5.98	7.97	9.97	11.96
ZOP3-MSPTM0C	Center	2.75	26.5	31.4	39	1.7	1.75	3.99	5.98	7.97	9.97	11.96
Twin Modular Upholstered Arm												
ZOP3-MATUPHU		3	14.5	19.75	22	2.5	2.11	3.56	5	6.5	7.9	9.33
ZOP3-MATUPHC		3	14.5	19.75	22	2.5	2.11	3.56	5	6.5	7.9	9.33
Twin Modular Upholstered Arm w/Urethane Cap												
ZOP3-MATUREU		3	14.5	20.25	16	1.8	2.11	3.56	5	6.5	7.9	9.33
ZOP3-MATUREC		3	14.5	20.25	16	1.8	2.11	3.56	5	6.5	7.9	9.33
Twin Modular Upholstered Arm w/Solid Surface Cap												
ZOP3-MATSSCU		3	14.5	20.25	16	1.8	2.11	3.56	5	6.5	7.9	9.33
ZOP3-MATSSCC		3	14.5	20.25	16	1.8	2.11	3.56	5	6.5	7.9	9.33

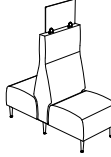



ZOLA PRIVACY | TWIN SEATS

DESCRIPTION/MODEL	COM		COL			FABRIC GRADES			LEATHER	
	1	2	3	4	5	6	7	8	9	
 Twin One-Seat, Full Height Back ZOP3-MT1F0F	2851	3016	3184	3424	3691	3932	4203	4533	4888	
 Twin One-Seat, Full Height Back with Privacy Screen Option ZOP3-MT1F2F	3134	3299	3465	3707	3975	4214	4484	4816	5170	
ORDERING NOTES: Units with Privacy Screen Option are not available with Removable Back Cover option.										
 Twin One-Seat, Mid Height Back ZOP3-MT1M0F	2713	2853	2995	3200	3430	3635	3866	4149	4454	
 Twin One-Seat, Mid Height Back with Privacy Screen Option ZOP3-MT1M2F	2994	3136	3278	3483	3712	3918	4147	4432	4735	
ORDERING NOTES: Units with Privacy Screen Option are not available with Removable Back Cover option.										
 Twin One-Seat Plus, Full Height Back ZOP3-MBT1F0F	3816	3982	4147	4389	4656	4897	5167	5498	5853	
 Twin One-Seat Plus, Full Height Back with Privacy Screen Option ZOP3-MBT1F2F	4172	4339	4505	4744	5012	5255	5524	5856	6210	
ORDERING NOTES: Units with Privacy Screen Option are not available with Removable Back Cover option.										
 Twin One-Seat Plus, Mid Height Back ZOP3-MBT1M0F	3664	3806	3949	4152	4381	4587	4817	5103	5404	
 Twin One-Seat Plus, Mid Height Back with Privacy Screen Option ZOP3-MBT1M2F	4021	4162	4306	4507	4738	4944	5174	5457	5761	
ORDERING NOTES: Units with Privacy Screen Option are not available with Removable Back Cover option.										

PRODUCT CODE KEY

Line	Series	Chair Type	Seat Count	Back Type	Leg Type
ZOP Zola	3 Lounge	MT Modular Twin	1 One Seat	F0 Full Height Back	F Freestanding Unit
		MTB Modular Twin Plus Upgrade (page 243)	2 Two Seat	F2 Full Height Back with Privacy Screen Option	S Start Unit
			3 Three Seat	M0 Mid Height Back	C Center Unit
				M2 Mid Height Back with Privacy Screen Option	E End Unit

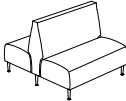

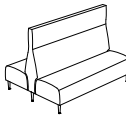
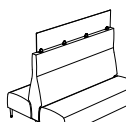
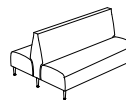
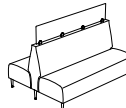
ZOLA PRIVACY | TWIN SEATS

DESCRIPTION/MODEL	COM		COL			FABRIC GRADES			LEATHER	
	1	2	3	4	5	6	7	8	9	
 Twin Two-Seat, Full Height Back ZOP3-MT2F0F	4235	4496	4756	5143	5578	5966	6399	6921	7516	
 Twin Two-Seat, Full Height Back Privacy Screen Option ZOP3-MT2F2F	4723	4986	5245	5635	6069	6456	6889	7411	8008	
ORDERING NOTES: Units with Privacy Screen Option are not available with Removable Back Cover option.										
 Twin Two-Seat, Mid Height Back ZOP3-MT2M0F	4029	4256	4480	4809	5174	5502	5868	6318	6808	
 Twin Two-Seat, Mid Height Back with Privacy Screen Option ZOP3-MT2M2F	4520	4744	4970	5296	5664	5992	6359	6808	7298	
ORDERING NOTES: Units with Privacy Screen Option are not available with Removable Back Cover option.										
 Twin Three-Seat, Full Height Back ZOP3-MT3F0F	5819	6155	6489	6962	7504	7977	8516	9186	9878	
 Twin Three-Seat, Full Height Back Privacy Screen Option ZOP3-MT3F2F	6518	6854	7186	7660	8203	8678	9217	9885	10575	
ORDERING NOTES: Units with Privacy Screen Option are not available with Removable Back Cover option.										
 Twin Three-Seat, Mid Height Back ZOP3-MT3M0F	5355	5649	5941	6363	6839	7260	7735	8324	8944	
 Twin Three-Seat, Mid Height Back with Privacy Screen Option ZOP3-MT3M2F	6054	6348	6641	7064	7539	7961	8435	9023	9645	
ORDERING NOTES: Units with Privacy Screen Option are not available with Removable Back Cover option.										

PRODUCT CODE KEY

Line	Series	Chair Type	Seat Count	Back Type	Leg Type
ZOP Zola	3 Lounge	MT Modular Twin	1 One Seat	F0 Full Height Back	F Freestanding Unit
		MTB Modular Twin Plus Upgrade (page 243)	2 Two Seat	F2 Full Height Back with Privacy Screen Option	S Start Unit
			3 Three Seat	M0 Mid Height Back	C Center Unit
				M2 Mid Height Back with Privacy Screen Option	E End Unit

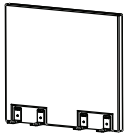
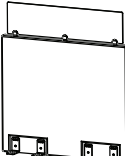
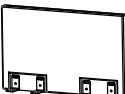
ZOLA PRIVACY | TWIN - SIDE PANELS

DESCRIPTION/MODEL	COM		COL			FABRIC GRADES			LEATHER		
	1	2	3	4	5	6	7	8	9		
 Twin Side Panel, Full Height No Screen ZOP3-MPTF0U Universal End ZOP3-MPTF0C Center	1428	1559	1691	1955	2218	2483	2745	3010	3536		
	2139	2272	2405	2668	2932	3193	3457	3720	4248		
 Twin Side Panel,, Full Height with Screen ZOP3-MPTF2U Universal End ZOP3-MPTF2C Center	2006	2138	2271	2533	2798	3061	3324	3589	4114		
	2718	2851	2984	3246	3510	3772	4037	4297	4828		
 Twin Side Panel, Med. Height No Screen - ZOP3-MPTM0U Universal End ZOP3-MPTM0C Center	1187	1275	1363	1543	1720	1898	2077	2254	2610		
	1897	1988	2077	2254	2432	2610	2788	2965	3322		
 Twin Side Panel, Med. Height with Screen ZOP3-MPTM2U Universal End ZOP3-MPTM2C Center	1767	1855	1944	2122	2301	2479	2657	2833	3188		
	2478	2567	2657	2833	3011	3188	3367	3543	3902		

ORDERING NOTE: Side Panels will only connect to Center seating units. Units with Privacy Screen Option are not available with Removable Back Cover option. See page 244 for dimensions and COM.

PRODUCT CODE KEY

Line	Series	Chair Type	Height	Position
ZOP	3	MPT	F0	U
Zola	Lounge	Modular Side Panel Twin	Full Height	Universal (S or E)
			F2	C
			Full Height with Privacy Screen Option	Center /Interim
			M0	
			Mid Height	
			M2	
			Mid Height with Privacy Screen Option	

ZOLA PRIVACY | TWIN SEMI-PRIVATE SIDE PANELS & MODULAR ARMS

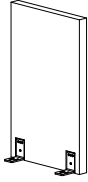
DESCRIPTION/MODEL	COM		COL			FABRIC GRADES			LEATHER		
	1	2	3	4	5	6	7	8	9		
	Twin Semi-Private Side Panel, Single, Full Height										
	ZOP3-MSPTF0U	Universal	1012	1092	1172	1286	1415	1528	1659	1819	1981
	ZOP3-MSPTF0C	Center	1724	1804	1885	1999	2129	2240	2370	2532	2694

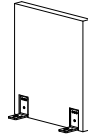
DESCRIPTION/MODEL	COM		COL			FABRIC GRADES			LEATHER		
	1	2	3	4	5	6	7	8	9		
	Twin Semi-Private Side Panel, Single, Mid Height										
	ZOP3-MSPTM0U	Universal	868	919	973	1045	1131	1203	1288	1393	1497
	ZOP3-MSPTM0C	Center	1581	1633	1686	1758	1842	1915	2001	2106	2211

ORDERING NOTE: Semi-Private Side Panels will only connect to Center seating units. See page 244 for dimensions and COM.

PRODUCT CODE KEY

Line	Series	Type	Height	Position
ZOP	3	MSPT	F0	U
Zola	Lounge	Modular Arm Twin	Full Height	Universal (S or E)
			M0	C
			Mid Height	Center /Interim

ZOLA PRIVACY | TWIN MODULAR ARMS

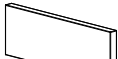
DESCRIPTION/MODEL	COM		COL			FABRIC GRADES			LEATHER		
	1	2	3	4	5	6	7	8	9		
	Twin Modular Upholstered Arm										
	ZOP3-MATUPHU		1120	1197	1262	1349	1451	1539	1641	1768	1894
	ZOP3-MATUPHC		1846	1909	1974	2062	2164	2253	2354	2481	2608

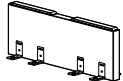
DESCRIPTION/MODEL	COM		COL			FABRIC GRADES			LEATHER		
	1	2	3	4	5	6	7	8	9		
	Twin Modular Upholstered Arm w/Urethane Cap										
	ZOP3-MATUREU		1252	1329	1393	1481	1582	1670	1772	1899	2026
	ZOP3-MATUREC		1979	2041	2106	2193	2295	2384	2485	2612	2739

ORDERING NOTE: To specify Solid Surface Arm Caps on Modular Upholstered Arms, please add upcharge below and change UPH in the model number to SSC.

Zola Option Upcharges	Grades			
	A-White	A-Color	B	C
Solid Surface Arm Cap (per arm)	276	288	318	328

PRODUCT CODE KEY

Line	Series	Type	Arm	Position
ZOP	3	MAT	UPH	U
Zola	Lounge	Modular Arm Twin	Upholstered	Universal (S or E)
			URE	C
			Upholstered Arm w/Urethane Cap	Center /Interim
			SSC	
			Upholstered Arm w/Solid Surface Cap	

ZOLA PRIVACY | CURVED - DIMENSIONS

DIMENSIONS

	Overall Width	Width with Arms	Overall Depth	Depth w/ Shelf	Overall Height	Overall Height w/Screen	Seat Height	Seat Depth	Shipping Weight	Cubes
Curved Single-Seat - Full Height Back										
30° Inside Curve	36	42	28.5	40.5	50	62.5	18.5	20.25	73	15
45° Inside Curve	42.5	48.5	29	41	50	62.5	18.5	20.25	81	19
60° Inside Curve	48.5	54.5	30	42	50	62.5	18.5	20.25	89	24
90° Inside Curve	59	65	31.5	43.5	50	62.5	18.5	20.25	111	36
30° Outside Curve	33.5	39.5	28.5	40.5	50	62.5	18.5	20.25	65	12
45° Outside Curve	39	45	29	41	50	62.5	18.5	20.25	67	13
60° Outside Curve	43.5	49.5	29	41	50	62.5	18.5	20.25	70	15
90° Outside Curve	52	58	30	42	50	62.5	18.5	20.25	75	16
Curved Single-Seat - Mid Height Back										
30° Inside Curve	36	42	28.5	40.5	37.5	50	18.5	20.25	68	13
45° Inside Curve	42.5	48.5	29	41	37.5	50	18.5	20.25	76	16
60° Inside Curve	48.5	54.5	30	42	37.5	50	18.5	20.25	83	20
90° Inside Curve	59	65	31.5	43.5	37.5	50	18.5	20.25	103	28
30° Outside Curve	33.5	39.5	28.5	40.5	37.5	50	18.5	20.25	62	10
45° Outside Curve	39	45	29	41	37.5	50	18.5	20.25	64	12
60° Outside Curve	43.5	49.5	29	42	37.5	50	18.5	20.25	67	13
90° Outside Curve	52	58	30	43.5	37.5	50	18.5	20.25	73	14
Curved Double-Seat - Full Height Back										
30° Inside Curve	58	64	30	42	50	62.5	18.5	20.25	117	28
45° Inside Curve	64.5	70.5	31.5	43.5	50	62.5	18.5	20.25	124	37
60° Inside Curve	70.5	76.5	33	45	50	62.5	18.5	20.25	132	46
90° Inside Curve	81	87	36	48	50	62.5	18.5	20.25	151	65
30° Outside Curve	55.5	61.5	29.5	41.5	50	62.5	18.5	20.25	101	24
45° Outside Curve	61	67	31	43	50	62.5	18.5	20.25	104	28
60° Outside Curve	65.5	71.5	32	44	50	62.5	18.5	20.25	110	32
90° Outside Curve	74.5	80.5	34.5	46.5	50	62.5	18.5	20.25	121	37
Curved Double-Seat - Mid Height Back										
30° Inside Curve	58	64	30	42	37.5	50	18.5	20.25	110	24
45° Inside Curve	64.5	70.5	31.5	43.5	37.5	50	18.5	20.25	116	31
60° Inside Curve	70.5	76.5	33	45	37.5	50	18.5	20.25	123	38
90° Inside Curve	81	87	36	48	37.5	50	18.5	20.25	141	52
30° Outside Curve	55.5	61.5	29.5	41.5	37.5	50	18.5	20.25	96	21
45° Outside Curve	61	67	31	43	37.5	50	18.5	20.25	99	25
60° Outside Curve	65.5	71.5	32	44	37.5	50	18.5	20.25	105	28
90° Outside Curve	74.5	80.5	34.5	46.5	37.5	50	18.5	20.25	115	32

Upcharge for Plus Upgrade Option:

Option	\$ List	Option	\$ List
Plus Upgrade -Single-seat curve 30° seat	96	Plus Upgrade -Double-seat curve 30° seat	152
Plus Upgrade -Single-seat curve 45° seat	111	Plus Upgrade -Double-seat curve 45° seat	180
Plus Upgrade -Single-seat curve 60° seat	123	Plus Upgrade -Double-seat curve 60° seat	193
Plus Upgrade -Single-seat curve 90° seat	165	Plus Upgrade -Double-seat curve 90° seat	220

ZOLA PRIVACY | CURVED - COM REQUIREMENTS







COM YARDAGES

	Yardage Entire Unit	Yardage 2 Entire Units	Yardage 3 Entire Units	Yardage 4 Entire Units	Yardage per Back	Yardage per 2 Backs	Yardage per 3 Backs	Yardage per 4 Backs	Yardage per Seat	Yardage per 2 Seats	Yardage per 3 Seats	Yardage per 4 Seats
Curved Single-Seat - Full Height Back												
30° Inside Curve	5.2	10.4	15.6	20.8	3.4	6.8	10.2	13.6	1.8	3.6	5.4	7.2
45° Inside Curve	6.3	11.1	15.9	22.2	4.5	7.5	10.5	15	1.8	3.6	5.4	7.2
60° Inside Curve	6.7	12.2	17.67	24.37	4.9	8.6	12.27	17.17	1.8	3.6	5.4	7.2
90° Inside Curve	8.3	16.6	24.9	33.2	6.5	13	19.5	26	1.8	3.6	5.4	7.2
30° Outside Curve	5.3	9.2	13.1	18.4	3.5	5.6	7.7	11.2	1.8	3.6	5.4	7.2
45° Outside Curve	5.3	9.2	13.1	18.4	3.5	5.6	7.7	11.2	1.8	3.6	5.4	7.2
60° Outside Curve	5.3	9.2	13.1	18.4	3.5	5.6	7.7	11.2	1.8	3.6	5.4	7.2
90° Outside Curve	5.3	9.2	13.1	18.4	3.5	5.6	7.7	11.2	1.8	3.6	5.4	7.2
Curved Single-Seat - Mid Height Back												
30° Inside Curve	4.6	9.2	13.8	18.4	2.8	5.6	8.4	11.2	1.8	3.6	5.4	7.2
45° Inside Curve	5.1	9.1	13.15	18.7	3.3	5.5	7.75	11.5	1.8	3.6	5.4	7.2
60° Inside Curve	5.68	10.5	15.2	20.91	3.88	6.9	9.8	13.71	1.8	3.6	5.4	7.2
90° Inside Curve	6.5	13	19.5	26	4.7	9.4	14.1	18.8	1.8	3.6	5.4	7.2
30° Outside Curve	4.7	8.5	12.3	17	2.9	4.9	6.9	9.8	1.8	3.6	5.4	7.2
45° Outside Curve	4.7	8.5	12.3	17	2.9	4.9	6.9	9.8	1.8	3.6	5.4	7.2
60° Outside Curve	4.7	8.5	12.3	17	2.9	4.9	6.9	9.8	1.8	3.6	5.4	7.2
90° Outside Curve	4.7	8.5	12.3	17	2.9	4.9	6.9	9.8	1.8	3.6	5.4	7.2
Curved Double-Seat - Full Height Back												
30° Inside Curve	8.67	17.34	26.01	34.68	5.27	10.54	15.81	21.08	3.4	6.8	10.2	13.6
45° Inside Curve	9.37	18.74	28.11	37.48	5.97	11.94	17.91	23.88	3.4	6.8	10.2	13.6
60° Inside Curve	10.73	20.13	29.53	40.26	7.33	13.33	19.33	26.66	3.4	6.8	10.2	13.6
90° Inside Curve	11.15	20.93	30.73	41.88	7.75	14.13	20.53	28.28	3.4	6.8	10.2	13.6
30° Outside Curve	8.15	14.88	21.61	29.76	4.75	8.08	11.41	16.16	3.4	6.8	10.2	13.6
45° Outside Curve	8.15	14.88	21.61	29.76	4.75	8.08	11.41	16.16	3.4	6.8	10.2	13.6
60° Outside Curve	8.15	14.88	21.45	29.6	4.75	8.08	11.25	16	3.4	6.8	10.2	13.6
90° Outside Curve	8.15	14.88	21.61	29.76	4.75	8.08	11.41	16.16	3.4	6.8	10.2	13.6
Curved Double-Seat - Mid Height Back												
30° Inside Curve	7.8	15.6	23.4	31.2	4.4	8.8	13.2	17.6	3.4	6.8	10.2	13.6
45° Inside Curve	8.09	16.18	24.27	32.36	4.69	9.38	14.07	18.76	3.4	6.8	10.2	13.6
60° Inside Curve	8.9	16.8	24.7	33.6	5.5	10	14.5	20	3.4	6.8	10.2	13.6
90° Inside Curve	8.9	16.8	24.7	33.6	5.5	10	14.5	20	3.4	6.8	10.2	13.6
30° Outside Curve	7.15	13.25	19.7	26.5	3.75	6.45	9.5	12.9	3.4	6.8	10.2	13.6
45° Outside Curve	7.15	13.25	19.7	26.5	3.75	6.45	9.5	12.9	3.4	6.8	10.2	13.6
60° Outside Curve	6.8	12.6	18.4	25.2	3.4	5.8	8.2	11.6	3.4	6.8	10.2	13.6
90° Outside Curve	7.15	13.25	19.7	26.5	3.75	6.45	9.5	12.9	3.4	6.8	10.2	13.6

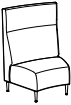
Upcharge for Removable Upholstery Covers:

Option	\$ List	Option	\$ List
Single-seat curve 30° seat	61	Double-seat curve 30° seat	93
Single-seat curve 45° seat	64	Double-seat curve 45° seat	101
Single-seat curve 60° seat	86	Double-seat curve 60° seat	123
Single-seat curve 90° seat	113	Double-seat curve 90° seat	127

ZOLA PRIVACY | CURVED

DESCRIPTION/MODEL/SPECIES	COM		COL	FABRIC GRADES			LEATHER			
	1	2	3	4	5	6	7	8	9	
 Single-Seat, 30° Inside Curve, Full Height Back ZOP3-MCIS30DF0F	3430	3618	3806	4068	4369	4634	4931	5308	5684	
 Single-Seat, 30° Inside Curve, Full Height Back with Shelf ZOP3-MCIS30DF1_	Beech/Laminate	4047	4236	4423	4686	4987	5250	5549	5925	6300
	Maple/Palette	4141	4328	4515	4781	5080	5344	5642	6019	6394
ORDERING NOTE: When ordering a back with Shelf option please clearly specify on your order the required Shelf Height - 42", 36" or 30" and chose required leg type below. Freestanding, Start and End units with the shelf option require counterbalance weight added to each seat unit, please add \$303 list upcharge per unit.										
 Single-Seat, 30° Inside Curve, Full Height Back with Privacy Screen ZOP3-MCIS30DF2F	4023	4212	4398	4664	4962	5227	5527	5902	6277	
 Single-Seat, 30° Inside Curve, Mid Height Back ZOP3-MCIS30DM0F	3273	3437	3604	3834	4098	4328	4592	4922	5250	
 Single-Seat, 30° Inside Curve, Mid Height Back with Shelf ZOP3-MCIS30DM1_	Beech/Laminate	3892	4058	4221	4454	4715	4946	5211	5539	5868
	Maple/Palette	3984	4149	4315	4545	4811	5038	5303	5634	5962
ORDERING NOTE: When ordering a back with Shelf option please clearly specify on your order the required Shelf Height - 36" or 30" and chose required leg type below. Freestanding, Start and End units with the shelf option require counterbalance weight added to each seat unit, please add \$303 list upcharge per unit.										
 Single-Seat, 30° Inside Curve, Mid Height Back with Privacy Screen Option ZOP3-MCIS30DM2F	3867	4033	4197	4427	4691	4922	5187	5516	5844	







Zola Privacy Option Upcharges

	\$ List	\$ List
Moisture Barrier & CAL 133(per yard)	64	Plus Upgrade - Single-Seat, 30° Curve
Seat Power (per unit)	641	Dual Leg (for Multiple unit configurations)
Shelf Power	599	Removable Seat Covers -Single-Seat, 30° Curve
Table Power	589	Note: Removable back covers are not available on curved backs
Combination Upholstery - dual fabrics	33	

PRODUCT CODE KEY

Line	Series	Chair Type	Curve Style	Seat Degree	Back Type	Leg Type
ZOP	3	MC	IS	30D	F0	F
Zola	Lounge	Modular Curve	Inside Curve -Single		Full Height Back	Freestanding Unit
		MCB	ID	45D	F1	S
		Modular Curve Plus	Inside Curve -Double		Full Height Back with Shelf Option	Start Unit
			OS	60D	F2	C
			Outside Curve -Single		Full Height Back with Privacy Screen Option	Center Unit
			OD	90D	M0	E
			Outside Curve -Double		Mid Height Back	End Unit
					M1	
					Mid Height Back with Shelf Option	
					M2	
					Mid Height Back with Privacy Screen Options	

ZOLA PRIVACY | CURVED

DESCRIPTION/MODEL/SPECIES	COM		COL		FABRIC GRADES			LEATHER	
	1	2	3	4	5	6	7	8	9
 Single-Seat, 45° Inside Curve, Full Height Back ZOP3-MCIS45DF0F	3847	4057	4263	4565	4904	5209	5548	5964	6418
 Single-Seat, 45° Inside Curve, Full Height Back with Shelf ZOP3-MCIS45DF1_ Beech/Laminate	4483	4690	4898	5201	5539	5841	6184	6599	7051
Maple/Palette	4576	4785	4993	5295	5635	5938	6280	6691	7148
ORDERING NOTE: When ordering a back with Shelf option please clearly specify on your order the required Shelf Height - 42", 36" or 30" and chose required leg type below. Freestanding, Start and End units with the shelf option require counterbalance weight added to each seat unit, please add \$303 list upcharge per unit.									
 Single-Seat, 45° Inside Curve, Full Height Back with Privacy Screen ZOP3-MCIS45DF2F	4447	4655	4863	5167	5506	5809	6149	6565	7018
 Single-Seat, 45° Inside Curve, Mid Height Back ZOP3-MCIS45DM0F	3642	3811	3979	4215	4486	4722	4994	5329	5673
 Single-Seat, 45° Inside Curve, Mid Height Back with Shelf ZOP3-MCIS45DM1_ Beech/Laminate	4278	4444	4614	4848	5121	5360	5631	5965	6307
Maple/Palette	4371	4539	4709	4945	5216	5453	5722	6059	6402
ORDERING NOTE: When ordering a back with Shelf option please clearly specify on your order the required Shelf Height - 36" or 30" and chose required leg type below. Freestanding, Start and End units with the shelf option require counterbalance weight added to each seat unit, please add \$303 list upcharge per unit.									
 Single-Seat, 45° Inside Curve, Mid Height Back with Privacy Screen Option ZOP3-MCIS45DM2F	4243	4411	4580	4816	5086	5323	5595	5931	6271







Zola Privacy Option Upcharges

	\$ List	\$ List
Moisture Barrier & CAL 133(per yard)	64	Plus Upgrade -Single-Seat, 45° Curve
Seat Power (per unit)	641	Dual Leg (for Multiple unit configurations)
Shelf Power	599	Removable Seat Covers -Single-Seat, 45° Curve
Table Power	589	Note: Removable back covers are not available on curved backs
Combination Upholstery - dual fabrics	33	

PRODUCT CODE KEY

Line	Series	Chair Type	Curve Style	Seat Degree	Back Type	Leg Type
ZOP	3	MC	IS	30D	F0	F
Zola	Lounge	Modular Curve	Inside Curve -Single		Full Height Back	Freestanding Unit
		MCB	ID	45D	F1	S
		Modular Curve Plus	Inside Curve -Double		Full Height Back with Shelf Option	Start Unit
			OS	60D	F2	C
			Outside Curve -Single		Full Height Back with Privacy Screen Option	Center Unit
			OD	90D	M0	E
			Outside Curve -Double		Mid Height Back	End Unit
					M1	
					Mid Height Back with Shelf Option	
					M2	
					Mid Height Back with Privacy Screen Options	

ZOLA PRIVACY | CURVED

DESCRIPTION/MODEL/SPECIES	COM		COL		FABRIC GRADES			LEATHER	
	1	2	3	4	5	6	7	8	9
 Single-Seat, 60° Inside Curve, Full Height Back ZOP3-MCIS60DF0F	4371	4634	4891	5267	5696	6067	6492	7012	7567
 Single-Seat, 60° Inside Curve, Full Height Back with Shelf ZOP3-MCIS60DF1_ Beech/Laminate	5185	5444	5705	6080	6504	6879	7303	7822	8380
Maple/Palette	5281	5541	5800	6179	6600	6974	7399	7920	8474
ORDERING NOTE: When ordering a back with Shelf option please clearly specify on your order the required Shelf Height - 42", 36" or 30" and chose required leg type below. Freestanding, Start and End units with the shelf option require counterbalance weight added to each seat unit, please add \$303 list upcharge per unit.									
 Single-Seat, 60° Inside Curve, Full Height Back with Privacy Screen ZOP3-MCIS60DF2F	4974	5236	5496	5870	6293	6670	7093	7615	8169
 Single-Seat, 60° Inside Curve, Mid Height Back ZOP3-MCIS60DM0F	4164	4350	4537	4801	5103	5364	5664	6039	6416
 Single-Seat, 60° Inside Curve, Mid Height Back with Shelf ZOP3-MCIS60DM1_ Beech/Laminate	4977	5164	5351	5614	5914	6179	6477	6852	7229
Maple/Palette	5072	5259	5447	5712	6009	6271	6574	6946	7324
ORDERING NOTE: When ordering a back with Shelf option please clearly specify on your order the required Shelf Height - 36" or 30" and chose required leg type below. Freestanding, Start and End units with the shelf option require counterbalance weight added to each seat unit, please add \$303 list upcharge per unit.									
 Single-Seat, 60° Inside Curve, Mid Height Back with Privacy Screen Option ZOP3-MCIS60DM2F	4767	4953	5141	5406	5705	5968	6268	6642	7019

Zola Privacy Option Upcharges

	\$ List		\$ List
Moisture Barrier & CAL 133 (per yard)	64	Plus Upgrade - Single-Seat, 60° Curve	123
Seat Power (per unit)	641	Dual Leg (for Multiple unit configurations)	80
Shelf Power	599	Removable Seat Covers -Single-Seat, 60° Curve	86
Table Power	589	Note: Removable Back Cover are not available on curved backs	
Combination Upholstery - dual fabrics	33		

PRODUCT CODE KEY

Line	Series	Chair Type	Curve Style	Seat Degree	Back Type	Leg Type
ZOP Zola	3 Lounge	MC Modular Curve	IS Inside Curve -Single	30D	F0 Full Height Back	F Freestanding Unit
		MCB Modular Curve Plus	ID Inside Curve -Double	45D	F1 Full Height Back with Shelf Option	S Start Unit
			OS Outside Curve -Single	60D	F2 Full Height Back with Privacy Screen Option	C Center Unit
			OD Outside Curve -Double	90D	M0 Mid Height Back	E End Unit
					M1 Mid Height Back with Shelf Option	
					M2 Mid Height Back with Privacy Screen Options	

ZOLA PRIVACY | CURVED

DESCRIPTION/MODEL/SPECIES	COM		COL	FABRIC GRADES			LEATHER		
	1	2	3	4	5	6	7	8	9



Single-Seat, 90° Inside Curve, Full Height Back ZOP3-MCIS90DF0F	4992	5263	5538	5920	6359	6742	7180	7728	8275
--	------	------	------	------	------	------	------	------	------



Single-Seat, 90° Inside Curve, Full Height Back with Shelf ZOP3-MCIS90DF1_ Beech/Laminate	5866	6139	6412	6795	7234	7616	8055	8599	9147
Maple/Palette	5964	6237	6511	6894	7331	7713	8152	8698	9246

ORDERING NOTE: When ordering a back with Shelf option please clearly specify on your order the required Shelf Height - 42", 36" or 30" and chose required leg type below. Freestanding, Start and End units with the shelf option require counterbalance weight added to each seat unit, please add **\$303 list** upcharge per unit.



Single-Seat, 90° Inside Curve, Full Height Back with Privacy Screen ZOP3-MCIS90DF2F	5943	6216	6492	6872	7311	7695	8131	8679	9225
--	------	------	------	------	------	------	------	------	------



Single-Seat, 90° Inside Curve, Mid Height Back ZOP3-MCIS90DM0F	4571	4786	5000	5299	5641	5943	6286	6713	7144
---	------	------	------	------	------	------	------	------	------

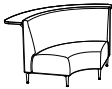

Single-Seat, 90° Inside Curve, Mid Height Back with Shelf ZOP3-MCIS90DM1_ Beech/Laminate	5444	5660	5873	6174	6516	6818	7159	7587	8015
Maple/Palette	5544	5758	5971	6270	6612	6914	7258	7684	8115

ORDERING NOTE: When ordering a back with Shelf option please clearly specify on your order the required Shelf Height - 36" or 30" and chose required leg type below. Freestanding, Start and End units with the shelf option require counterbalance weight added to each seat unit, please add **\$303 list** upcharge per unit.



Single-Seat, 90° Inside Curve, Mid Height Back with Privacy Screen Option ZOP3-MCIS90DM2F	5524	5739	5953	6252	6595	6895	7237	7662	8093
--	------	------	------	------	------	------	------	------	------







Zola Privacy Option Upcharges

	\$ List		\$ List
Moisture Barrier & CAL 133 (per yard)	64	Plus Upgrade - Single-Seat, 90° Curve	165
Seat Power (per unit)	641	Dual Leg (for Multiple unit configurations)	80
Shelf Power	599	Removable Seat Covers -Single-Seat, 90° Curve	113
Table Power	589	Note: Removable Back Cover are not available on curved backs	
Combination Upholstery - dual fabrics	33		

PRODUCT CODE KEY

Line	Series	Chair Type	Curve Style	Seat Degree	Back Type	Leg Type
ZOP	3	MC	IS	30D	F0	F
Zola	Lounge	Modular Curve	Inside Curve -Single		Full Height Back	Freestanding Unit
		MCB	ID	45D	F1	S
		Modular Curve Plus	Inside Curve -Double		Full Height Back with Shelf Option	Start Unit
			OS	60D	F2	C
			Outside Curve -Single		Full Height Back with Privacy Screen Option	Center Unit
			OD	90D	M0	E
			Outside Curve -Double		Mid Height Back	End Unit
					M1	
					Mid Height Back with Shelf Option	
					M2	
					Mid Height Back with Privacy Screen Options	

ZOLA PRIVACY | CURVED

DESCRIPTION/MODEL/SPECIES	COM		COL	FABRIC GRADES			LEATHER		
	1	2	3	4	5	6	7	8	9
 Single-Seat, 30° Outside Curve, Full Height Back ZOP3-MCOS30DF0F	3252	3431	3609	3859	4145	4395	4680	5036	5392
 Single-Seat, 30° Outside Curve, Full Height Back with Shelf ZOP3-MCOS30DF1_ Beech/Laminate	3554	3732	3910	4160	4444	4693	4979	5337	5692
Maple/Palette	3642	3819	3999	4248	4533	4784	5068	5425	5782
ORDERING NOTE: When ordering a back with Shelf option please clearly specify on your order the required Shelf Height - 42", 36" or 30" and chose required leg type below. Freestanding, Start and End units with the shelf option require counterbalance weight added to each seat unit, please add \$303 list upcharge per unit.									
 Single-Seat, 30° Outside Curve, Full Height Back with Privacy Screen ZOP3-MCOS30DF2F	3607	3786	3963	4214	4500	4749	5034	5391	5746
 Single-Seat, 30° Outside Curve, Mid Height Back ZOP3-MCOS30DM0F	3135	3290	3445	3664	3914	4131	4380	4690	5007
 Single-Seat, 30° Outside Curve, Mid Height Back with Shelf ZOP3-MCOS30DM1_ Beech/Laminate	3433	3589	3743	3962	4213	4429	4680	4990	5307
Maple/Palette	3522	3679	3831	4053	4299	4520	4769	5079	5394
ORDERING NOTE: When ordering a back with Shelf option please clearly specify on your order the required Shelf Height - 36" or 30" and chose required leg type below. Freestanding, Start and End units with the shelf option require counterbalance weight added to each seat unit, please add \$303 list upcharge per unit.									
 Single-Seat, 30° Outside Curve, Mid Height Back with Privacy Screen Option ZOP3-MCOS30DM2F	3489	3643	3797	4019	4267	4485	4735	5043	5362







Zola Privacy Option Upcharges

	\$ List		\$ List
Moisture Barrier & CAL 133 (per yard)	64	Plus Upgrade - Single-Seat, 30° Curve	96
Seat Power (per unit)	641	Dual Leg (for Multiple unit configurations)	80
Shelf Power	599	Removable Seat Covers -Single-Seat, 30° Curve	61
Table Power	589	Note: Removable back covers are not available on curved backs	
Combination Upholstery - dual fabrics	33		

PRODUCT CODE KEY

Line	Series	Chair Type	Curve Style	Seat Degree	Back Type	Leg Type
ZOP	3	MC	IS	30D	F0	F
Zola	Lounge	Modular Curve	Inside Curve -Single		Full Height Back	Freestanding Unit
		MCB	ID	45D	F1	S
		Modular Curve Plus	Inside Curve -Double		Full Height Back with Shelf Option	Start Unit
			OS	60D	F2	C
			Outside Curve -Single		Full Height Back with Privacy Screen Option	Center Unit
			OD	90D	M0	E
			Outside Curve -Double		Mid Height Back	End Unit
					M1	
					Mid Height Back with Shelf Option	
					M2	
					Mid Height Back with Privacy Screen Options	

ZOLA PRIVACY | CURVED

DESCRIPTION/MODEL/SPECIES	COM		COL		FABRIC GRADES			LEATHER	
	1	2	3	4	5	6	7	8	9
 Single-Seat, 45° Outside Curve, Full Height Back ZOP3-MCOS45DF0F	3508	3685	3864	4113	4398	4648	4932	5288	5646
 Single-Seat, 45° Outside Curve, Full Height Back with Shelf ZOP3-MCOS45DF1_ Beech/Laminate	3803	3981	4158	4407	4693	4944	5230	5584	5941
Maple/Palette	3892	4068	4247	4499	4784	5033	5318	5674	6031
ORDERING NOTE: When ordering a back with Shelf option please clearly specify on your order the required Shelf Height - 42", 36" or 30" and chose required leg type below. Freestanding, Start and End units with the shelf option require counterbalance weight added to each seat unit, please add \$303 list upcharge per unit.									
 Single-Seat, 45° Outside Curve, Full Height Back with Privacy Screen ZOP3-MCOS45DF2F	3859	4038	4215	4466	4752	5002	5286	5641	5999
 Single-Seat, 45° Outside Curve, Mid Height Back ZOP3-MCOS45DM0F	3382	3536	3690	3909	4158	4378	4628	4937	5254
 Single-Seat, 45° Outside Curve, Mid Height Back with Shelf ZOP3-MCOS45DM1_ Beech/Laminate	3678	3830	3985	4205	4455	4672	4922	5232	5547
Maple/Palette	3766	3920	4074	4292	4542	4762	5010	5320	5636
ORDERING NOTE: When ordering a back with Shelf option please clearly specify on your order the required Shelf Height - 36" or 30" and chose required leg type below. Freestanding, Start and End units with the shelf option require counterbalance weight added to each seat unit, please add \$303 list upcharge per unit.									
 Single-Seat, 45° Outside Curve, Mid Height Back with Privacy Screen Option ZOP3-MCOS45DM2F	3735	3890	4042	4261	4510	4730	4979	5288	5605







Zola Privacy Option Upcharges

	\$ List		\$ List
Moisture Barrier & CAL 133 (per yard)	64	Plus Upgrade - Single-Seat, 45° Curve	111
Seat Power (per unit)	641	Dual Leg (for Multiple unit configurations)	80
Shelf Power	599	Removable Seat Covers -Single-Seat, 45° Curve	64
Table Power	589	Note: Removable back covers are not available on curved backs	
Combination Upholstery - dual fabrics	33		

PRODUCT CODE KEY

Line	Series	Chair Type	Curve Style	Seat Degree	Back Type	Leg Type
ZOP	3	MC	IS	30D	F0	F
Zola	Lounge	Modular Curve	Inside Curve -Single		Full Height Back	Freestanding Unit
		MCB	ID	45D	F1	S
		Modular Curve Plus	Inside Curve -Double		Full Height Back with Shelf Option	Start Unit
			OS	60D	F2	C
			Outside Curve -Single		Full Height Back with Privacy Screen Option	Center Unit
			OD	90D	M0	E
			Outside Curve -Double		Mid Height Back	End Unit
					M1	
					Mid Height Back with Shelf Option	
					M2	
					Mid Height Back with Privacy Screen Options	

ZOLA PRIVACY | CURVED

DESCRIPTION/MODEL/SPECIES	COM		COL	FABRIC GRADES			LEATHER		
	1	2	3	4	5	6	7	8	9
 Single-Seat, 60° Outside Curve, Full Height Back ZOP3-MCOS60DF0F	3655	3831	4011	4261	4546	4795	5082	5437	5793
 Single-Seat, 60° Outside Curve, Full Height Back with Shelf ZOP3-MCOS60DF1_ Beech/Laminate	3948	4125	4305	4553	4838	5086	5370	5727	6083
Maple/Palette	4036	4213	4393	4641	4927	5176	5463	5815	6174
ORDERING NOTES: When ordering a back with Shelf option please clearly specify on your order the required Shelf Height - 42", 36" or 30" and chose required leg type below. Freestanding, Start and End units with the shelf option require counterbalance weight added to each seat unit, please add \$303 list upcharge per unit.									
 Single-Seat, 60° Outside Curve, Full Height Back with Privacy Screen ZOP3-MCOS60DF2F	3988	4168	4347	4595	4882	5131	5416	5769	6127
 Single-Seat, 60° Outside Curve, Mid Height Back ZOP3-MCOS60DM0F	3535	3690	3846	4064	4313	4532	4781	5091	5407
 Single-Seat, 60° Outside Curve, Mid Height Back with Shelf ZOP3-MCOS60DM1_ Beech/Laminate	3825	3982	4138	4354	4604	4822	5071	5384	5696
Maple/Palette	3915	4070	4224	4443	4692	4914	5160	5471	5786
ORDERING NOTE: When ordering a back with Shelf option please clearly specify on your order the required Shelf Height - 36" or 30" and chose required leg type below. Freestanding, Start and End units with the shelf option require counterbalance weight added to each seat unit, please add \$303 list upcharge per unit.									
 Single-Seat, 60° Outside Curve, Mid Height Back with Privacy Screen Option ZOP3-MCOS60DM2F	3869	4024	4180	4397	4646	4866	5113	5425	5741







Zola Privacy Option Upcharges

	\$ List		\$ List
Moisture Barrier & CAL 133 (per yard)	64	Plus Upgrade - Single-Seat, 60° Curve	123
Seat Power (per unit)	641	Dual Leg (for Multiple unit configurations)	80
Shelf Power	599	Removable Seat Covers -Single-Seat, 60° Curve	86
Table Power	589	Note: Removable back covers are not available on curved backs	
Combination Upholstery - dual fabrics	33		

PRODUCT CODE KEY

Line	Series	Chair Type	Curve Style	Seat Degree	Back Type	Leg Type
ZOP	3	MC	IS	30D	F0	F
Zola	Lounge	Modular Curve	Inside Curve -Single		Full Height Back	Freestanding Unit
		MCB	ID	45D	F1	S
		Modular Curve Plus	Inside Curve -Double		Full Height Back with Shelf Option	Start Unit
			OS	60D	F2	C
			Outside Curve -Single		Full Height Back with Privacy Screen Option	Center Unit
			OD	90D	M0	E
			Outside Curve -Double		Mid Height Back	End Unit
					M1	
					Mid Height Back with Shelf Option	
					M2	
					Mid Height Back with Privacy Screen Options	

ZOLA PRIVACY | CURVED

DESCRIPTION/MODEL/SPECIES	COM		COL	FABRIC GRADES			LEATHER		
	1	2	3	4	5	6	7	8	9
 Single-Seat, 90° Outside Curve, Full Height Back ZOP3-MCOS90DF0F	4405	4586	4763	5011	5298	5547	5833	6188	6545
 Single-Seat, 90° Outside Curve, Full Height Back with Shelf ZOP3-MCOS90DF1_ Beech/Laminate	4686	4866	5043	5293	5579	5828	6113	6470	6828
Maple/Palette	4773	4952	5131	5381	5664	5914	6199	6556	6913
ORDERING NOTE: When ordering a back with Shelf option please clearly specify on your order the required Shelf Height - 42", 36" or 30" and chose required leg type below. Freestanding, Start and End units with the shelf option require counterbalance weight added to each seat unit, please add \$303 list upcharge per unit.									
 Single-Seat, 90° Outside Curve, Full Height Back with Privacy Screen ZOP3-MCOS90DF2F	4737	4918	5095	5344	5631	5878	6163	6520	6877
 Single-Seat, 90° Outside Curve, Mid Height Back ZOP3-MCOS90DM0F	3949	4103	4258	4477	4725	4944	5192	5503	5821
 Single-Seat, 90° Outside Curve, Mid Height Back with Shelf ZOP3-MCOS90DM1_ Beech/Laminate	4229	4382	4537	4757	5007	5223	5473	5784	6102
Maple/Palette	4315	4469	4623	4843	5093	5310	5560	5869	6186
ORDERING NOTE: When ordering a back with Shelf option please clearly specify on your order the required Shelf Height - 36" or 30" and chose required leg type below. Freestanding, Start and End units with the shelf option require counterbalance weight added to each seat unit, please add \$303 list upcharge per unit.									
 Single-Seat, 90° Outside Curve, Mid Height Back with Privacy Screen Option ZOP3-MCOS90DM2F	4279	4433	4588	4810	5057	5275	5525	5834	6153

Zola Privacy Option Upcharges

	\$ List		\$ List
Moisture Barrier & CAL 133 (per yard)	64	Plus Upgrade - Single-Seat, 90° Curve	165
Seat Power (per unit)	641	Dual Leg (for Multiple unit configurations)	80
Shelf Power	599	Removable Seat Covers -Single-Seat, 90° Curve	113
Table Power	589	Note: Removable back covers are not available on curved backs	
Combination Upholstery - dual fabrics	33		

PRODUCT CODE KEY

Line	Series	Chair Type	Curve Style	Seat Degree	Back Type	Leg Type
ZOP	3	MC	IS	30D	F0	F
Zola	Lounge	Modular Curve	Inside Curve -Single		Full Height Back	Freestanding Unit
		MCB	ID	45D	F1	S
		Modular Curve Plus	Inside Curve -Double		Full Height Back with Shelf Option	Start Unit
			OS	60D	F2	C
			Outside Curve -Single		Full Height Back with Privacy Screen Option	Center Unit
			OD	90D	M0	E
			Outside Curve -Double		Mid Height Back	End Unit
					M1	
					Mid Height Back with Shelf Option	
					M2	
					Mid Height Back with Privacy Screen Options	

ZOLA PRIVACY | CURVED

DESCRIPTION/MODEL/SPECIES	COM		COL		FABRIC GRADES			LEATHER	
	1	2	3	4	5	6	7	8	9

	Double-Seat, 30° Inside Curve, Full Height Back ZOP3-MCID30DF0F	4943	5245	5548	5973	6461	6884	7368	7973	8581
--	--	------	------	------	------	------	------	------	------	------

	Double-Seat, 30° Inside Curve, Full Height Back with Shelf ZOP3-MCID30DF1_									
	Beech/Laminate	5715	6017	6319	6745	7230	7655	8141	8745	9353
	Maple/Palette	5811	6114	6418	6842	7329	7754	8236	8843	9447

ORDERING NOTE: When ordering a back with Shelf option please clearly specify on your order the required Shelf Height - 42", 36" or 30" and chose required leg type below. Freestanding, Start and End units with the shelf option require counterbalance weight added to each seat unit, please add **\$303 list** upcharge per unit.

	Double-Seat, 30° Inside Curve, Full Height Back with Privacy Screen ZOP3-MCID30DF2F	5888	6190	6494	6918	7403	7829	8312	8918	9525
--	--	------	------	------	------	------	------	------	------	------

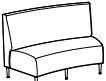
	Double-Seat, 30° Inside Curve, Mid Height Back ZOP3-MCID30DM0F	4678	4932	5191	5552	5964	6322	6734	7248	7762
--	---	------	------	------	------	------	------	------	------	------

	Double-Seat, 30° Inside Curve, Mid Height Back with Shelf ZOP3-MCID30DM1_									
	Beech/Laminate	5448	5705	5964	6322	6734	7093	7506	8017	8535
	Maple/Palette	5546	5802	6060	6420	6832	7191	7603	8117	8632

ORDERING NOTE: When ordering a back with Shelf option please clearly specify on your order the required Shelf Height - 36" or 30" and chose required leg type below. Freestanding, Start and End units with the shelf option require counterbalance weight added to each seat unit, please add **\$303 list** upcharge per unit.





	Double-Seat, 30° Inside Curve, Mid Height Back with Privacy Screen Option ZOP3-MCID30DM2F	5620	5878	6137	6496	6909	7267	7680	8193	8706
--	--	------	------	------	------	------	------	------	------	------

Zola Privacy Option Upcharges	\$ List	\$ List
Moisture Barrier & CAL 133 (per yard)	64	Plus Upgrade - Double-Seat, 30° Curve
Seat Power (per unit)	641	Dual Leg (for Multiple unit configurations)
Shelf Power	599	Removable Seat Covers -Double-Seat, 30° Curve
Table Power	589	Note: Removable back covers are not available on curved backs
Combination Upholstery - dual fabrics	33	

PRODUCT CODE KEY

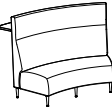
Line	Series	Chair Type	Curve Style	Seat Degree	Back Type	Leg Type
ZOP	3	MC	IS	30D	F0	F
Zola	Lounge	Modular Curve	Inside Curve -Single		Full Height Back	Freestanding Unit
		MCB	ID	45D	F1	S
		Modular Curve Plus	Inside Curve -Double		Full Height Back with Shelf Option	Start Unit
			OS	60D	F2	C
			Outside Curve -Single		Full Height Back with Privacy Screen Option	Center Unit
			OD	90D	M0	E
			Outside Curve -Double		Mid Height Back	End Unit
					M1	
					Mid Height Back with Shelf Option	
					M2	
					Mid Height Back with Privacy Screen Options	

ZOLA PRIVACY | CURVED





DESCRIPTION/MODEL/SPECIES	COM		COL		FABRIC GRADES			LEATHER	
	1	2	3	4	5	6	7	8	9
 Double-Seat, 45° Inside Curve, Full Height Back ZOP3-MCID45DF0F	5360	5666	5975	6411	6909	7343	7839	8457	9086
 Double-Seat, 45° Inside Curve, Full Height Back with Shelf ZOP3-MCID45DF1_ Beech/Laminate	6161	6469	6779	7214	7711	8146	8643	9261	9887
Maple/Palette	6260	6568	6877	7314	7809	8247	8741	9359	9988
ORDERING NOTE: When ordering a back with Shelf option please clearly specify on your order the required Shelf Height - 42", 36" or 30" and chose required leg type below. Freestanding, Start and End units with the shelf option require counterbalance weight added to each seat unit, please add \$303 list upcharge per unit.									
 Double-Seat, 45° Inside Curve, Full Height Back with Privacy Screen ZOP3-MCID45DF2F	6313	6621	6931	7367	7863	8298	8792	9412	10041
 Double-Seat, 45° Inside Curve, Mid Height Back ZOP3-MCID45DM0F	5103	5367	5635	6014	6444	6822	7255	7787	8340
 Double-Seat, 45° Inside Curve, Mid Height Back with Shelf ZOP3-MCID45DM1_ Beech/Laminate	5904	6170	6438	6817	7248	7625	8056	8590	9143
Maple/Palette	6003	6269	6537	6914	7345	7725	8155	8688	9241
ORDERING NOTE: When ordering a back with Shelf option please clearly specify on your order the required Shelf Height - 36" or 30" and chose required leg type below. Freestanding, Start and End units with the shelf option require counterbalance weight added to each seat unit, please add \$303 list upcharge per unit.									
 Double-Seat, 45° Inside Curve, Mid Height Back with Privacy Screen Option ZOP3-MCID45DM2F	6055	6322	6587	6968	7399	7778	8207	8741	9295

Zola Privacy Option Upcharges	\$ List	\$ List
Moisture Barrier & CAL 133 (per yard)	64	Plus Upgrade - Double-Seat, 45° Curve
Seat Power (per unit)	641	Dual Leg (for Multiple unit configurations)
Shelf Power	599	Removable Seat Covers -Double-Seat, 45° Curve
Table Power	589	Note: Removable back covers are not available on curved backs
Combination Upholstery - dual fabrics	33	

PRODUCT CODE KEY

Line	Series	Chair Type	Curve Style	Seat Degree	Back Type	Leg Type
ZOP	3	MC	IS	30D	F0	F
Zola	Lounge	Modular Curve	Inside Curve -Single		Full Height Back	Freestanding Unit
		MCB	ID	45D	F1	S
		Modular Curve Plus	Inside Curve -Double		Full Height Back with Shelf Option	Start Unit
			OS	60D	F2	C
			Outside Curve -Single		Full Height Back with Privacy Screen Option	Center Unit
			OD	90D	M0	E
			Outside Curve -Double		Mid Height Back	End Unit
					M1	
					Mid Height Back with Shelf Option	
					M2	
					Mid Height Back with Privacy Screen Options	

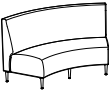
ZOLA PRIVACY | CURVED

DESCRIPTION/MODEL/SPECIES	COM		COL			FABRIC GRADES			LEATHER	
	1	2	3	4	5	6	7	8	9	
 Double-Seat, 60° Inside Curve, Full Height Back ZOP3-MCID60DF0F	5910	6263	6616	7127	7704	8215	8791	9499	10262	
 Double-Seat, 60° Inside Curve, Full Height Back with Shelf ZOP3-MCID60DF1_										
Beech/Laminate	6766	7122	7476	7986	8563	9074	9652	10358	11121	
Maple/Palette	6867	7219	7573	8085	8662	9172	9751	10458	11219	
ORDERING NOTE: When ordering a back with Shelf option please clearly specify on your order the required Shelf Height - 42", 36" or 30" and chose required leg type below. Freestanding, Start and End units with the shelf option require counterbalance weight added to each seat unit, please add \$303 list upcharge per unit.										
 Double-Seat, 60° Inside Curve, Full Height Back with Privacy Screen ZOP3-MCID60DF2F	6869	7222	7577	8088	8666	9174	9754	10460	11224	
 Double-Seat, 60° Inside Curve, Mid Height Back ZOP3-MCID60DM0F	5588	5884	6175	6595	7069	7487	7963	8548	9161	
 Double-Seat, 60° Inside Curve, Mid Height Back with Shelf ZOP3-MCID60DM1_										
Beech/Laminate	6447	6742	7035	7452	7927	8344	8820	9408	10020	
Maple/Palette	6545	6840	7132	7550	8026	8445	8918	9506	10120	
ORDERING NOTE: When ordering a back with Shelf option please clearly specify on your order the required Shelf Height - 36" or 30" and chose required leg type below. Freestanding, Start and End units with the shelf option require counterbalance weight added to each seat unit, please add \$303 list upcharge per unit.										
 Double-Seat, 60° Inside Curve, Mid Height Back with Privacy Screen Option ZOP3-MCID60DM2F	6549	6842	7135	7553	8029	8447	8920	9508	10123	

Zola Privacy Option Upcharges	\$ List		\$ List
Moisture Barrier & CAL 133 (per yard)	64	Plus Upgrade - Double-Seat, 60° Curve	183
Seat Power (per unit)	641	Dual Leg (for Multiple unit configurations)	80
Shelf Power	599	Removable Seat Covers -Double-Seat, 60° Curve	123
Table Power	589	Note: Removable back covers are not available on curved backs	
Combination Upholstery - dual fabrics	33		

PRODUCT CODE KEY

Line	Series	Chair Type	Curve Style	Seat Degree	Back Type	Leg Type
ZOP	3	MC	IS	30D	F0	F
Zola	Lounge	Modular Curve	Inside Curve -Single		Full Height Back	Freestanding Unit
		MCB	ID	45D	F1	S
		Modular Curve Plus	Inside Curve -Double		Full Height Back with Shelf Option	Start Unit
			OS	60D	F2	C
			Outside Curve -Single		Full Height Back with Privacy Screen Option	Center Unit
			OD	90D	M0	E
			Outside Curve -Double		Mid Height Back	End Unit
					M1	
					Mid Height Back with Shelf Option	
					M2	
					Mid Height Back with Privacy Screen Options	

ZOLA PRIVACY | CURVED

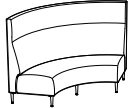
DESCRIPTION/MODEL/SPECIES	COM		COL		FABRIC GRADES			LEATHER		
	1	2	3	4	5	6	7	8	9	
 Double-Seat, 90° Inside Curve, Full Height Back ZOP3-MCID90DF0F	6937	7303	7673	8211	8813	9354	9959	10694	11512	

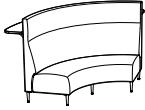
 Double-Seat, 90° Inside Curve, Full Height Back with Shelf ZOP3-MCID90DF1_ Beech/Laminate	7873	8239	8610	9147	9753	10291	10895	11630	12448
Maple/Palette	7973	8341	8709	9249	9853	10390	10994	11732	12549

ORDERING NOTE: When ordering a back with Shelf option please clearly specify on your order the required Shelf Height - 42", 36" or 30" and chose required leg type below. Freestanding, Start and End units with the shelf option require counterbalance weight added to each seat unit, please add **\$303 list** upcharge per unit.

 Double-Seat, 90° Inside Curve, Full Height Back with Privacy Screen ZOP3-MCID90DF2F	7942	8308	8678	9217	9818	10358	10963	11699	12514
--	------	------	------	------	------	-------	-------	-------	-------

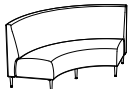
 Double-Seat, 90° Inside Curve, Mid Height Back ZOP3-MCID90DM0F	6441	6735	7028	7446	7921	8340	8813	9403	10014
---	------	------	------	------	------	------	------	------	-------

 Double-Seat, 90° Inside Curve, Mid Height Back with Shelf ZOP3-MCID90DM1_ Beech/Laminate	7379	7674	7966	8385	8859	9277	9753	10339	10953
Maple/Palette	7480	7773	8067	8485	8959	9379	9853	10440	11051

ORDERING NOTE: When ordering a back with Shelf option please clearly specify on your order the required Shelf Height - 36" or 30" and chose required leg type below. Freestanding, Start and End units with the shelf option require counterbalance weight added to each seat unit, please add **\$303 list** upcharge per unit.

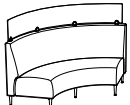
 Double-Seat, 90° Inside Curve, Mid Height Back with Privacy Screen Option ZOP3-MCID90DM2F	7446	7740	8033	8450	8925	9342	9818	10408	11018
--	------	------	------	------	------	------	------	-------	-------

Zola Privacy Option Upcharges	\$ List	\$ List
Moisture Barrier & CAL 133 (per yard)	64	Plus Upgrade - Double-Seat, 90° Curve
Seat Power (per unit)	641	Dual Leg (for Multiple unit configurations)
Shelf Power	599	Removable Seat Covers - Double-Seat, 90° Curve
Table Power	589	Note: Removable back covers are not available on curved backs
Combination Upholstery - dual fabrics	33	

PRODUCT CODE KEY

Line	Series	Chair Type	Curve Style	Seat Degree	Back Type	Leg Type
ZOP	3	MC	IS	30D	F0	F
Zola	Lounge	Modular Curve	Inside Curve -Single		Full Height Back	Freestanding Unit
		MCB	ID	45D	F1	S
		Modular Curve Plus	Inside Curve -Double		Full Height Back with Shelf Option	Start Unit
			OS	60D	F2	C
			Outside Curve -Single		Full Height Back with Privacy Screen Option	Center Unit
			OD	90D	M0	E
			Outside Curve -Double		Mid Height Back	End Unit
					M1	
					Mid Height Back with Shelf Option	
					M2	
					Mid Height Back with Privacy Screen Options	

ZOLA PRIVACY | CURVED

DESCRIPTION/MODEL/SPECIES	COM		COL			FABRIC GRADES			LEATHER	
	1	2	3	4	5	6	7	8	9	



Double-Seat, 30° Outside Curve, Full Height Back ZOP3-MCOD30DFOF	4593	4879	5166	5563	6020	6419	6873	7445	8015
---	------	------	------	------	------	------	------	------	------



Double-Seat, 30° Outside Curve, Full Height Back with Shelf ZOP3-MCOD30DF1_ Beech/Laminate	5155	5441	5726	6126	6582	6981	7437	8008	8579
Maple/Palette	5248	5534	5821	6219	6676	7073	7531	8099	8670

ORDERING NOTES: When ordering a back with Shelf option please clearly specify on your order the required Shelf Height - 42", 36" or 30" and chose required leg type below. Freestanding, Start and End units with the shelf option require counterbalance weight added to each seat unit, please add **\$303 list** upcharge per unit.



Double-Seat, 30° Outside Curve, Full Height Back with Privacy Screen ZOP3-MCOD30DF2F	5192	5478	5764	6163	6620	7018	7474	8044	8615
---	------	------	------	------	------	------	------	------	------



Double-Seat, 30° Outside Curve, Mid Height Back ZOP3-MCOD30DMOF	4398	4637	4873	5206	5586	5918	6296	6770	7245
--	------	------	------	------	------	------	------	------	------



Double-Seat, 30° Outside Curve, Mid Height Back with Shelf ZOP3-MCOD30DM1_ Beech/Laminate	4961	5199	5436	5767	6147	6480	6859	7333	7808
Maple/Palette	5054	5292	5529	5861	6242	6574	6953	7427	7900

ORDERING NOTES: When ordering a back with Shelf option please clearly specify on your order the required Shelf Height - 36" or 30" and chose required leg type below. Freestanding, Start and End units with the shelf option require counterbalance weight added to each seat unit, please add **\$303 list** upcharge per unit.



Double-Seat, 30° Outside Curve, Mid Height Back with Privacy Screen Option ZOP3-MCOD30DM2F	4998	5236	5472	5806	6185	6518	6896	7371	7844
---	------	------	------	------	------	------	------	------	------

Zola Privacy Option Upcharges

	\$ List		\$ List
Moisture Barrier & CAL 133 (per yard)	64	Plus Upgrade - Double-Seat, 30° Curve	152
Seat Power (per unit)	641	Dual Leg (for Multiple unit configurations)	80
Shelf Power	599	Removable Seat Covers -Double-Seat, 30° Curve	93
Table Power	589	Note: Removable back covers are not available on curved backs	
Combination Upholstery - dual fabrics	33		

PRODUCT CODE KEY

Line	Series	Chair Type	Curve Style	Seat Degree	Back Type	Leg Type
ZOP	3	MC	IS	30D	F0	F
Zola	Lounge	Modular Curve	Inside Curve -Single		Full Height Back	Freestanding Unit
		MCB	ID	45D	F1	S
		Modular Curve Plus	Inside Curve -Double		Full Height Back with Shelf Option	Start Unit
			OS	60D	F2	C
			Outside Curve -Single		Full Height Back with Privacy Screen Option	Center Unit
			OD	90D	M0	E
			Outside Curve -Double		Mid Height Back	End Unit
					M1	
					Mid Height Back with Shelf Option	
					M2	
					Mid Height Back with Privacy Screen Options	

ZOLA PRIVACY | CURVED

DESCRIPTION/MODEL/SPECIES	COM		COL	FABRIC GRADES			LEATHER		
	1	2	3	4	5	6	7	8	9
 Double-Seat, 45° Outside Curve, Full Height Back ZOP3-MCOD45DFOF	4798	5084	5368	5767	6225	6624	7080	7651	8221

 Double-Seat, 45° Outside Curve, Full Height Back with Shelf ZOP3-MCOD45DF1_ Beech/Laminate	5362	5646	5932	6331	6788	7185	7642	8212	8784
	Maple/Palette	5454	5740	6024	6422	6881	7281	7734	8306

ORDERING NOTE: When ordering a back with Shelf option please clearly specify on your order the required Shelf Height - 42", 36" or 30" and chose required leg type below. Freestanding, Start and End units with the shelf option require counterbalance weight added to each seat unit, please add **\$303 list** upcharge per unit.

 Double-Seat, 45° Outside Curve, Full Height Back with Privacy Screen ZOP3-MCOD45DF2F	5397	5684	5969	6366	6823	7222	7680	8250	8820
---	------	------	------	------	------	------	------	------	------

 Double-Seat, 45° Outside Curve, Mid Height Back ZOP3-MCOD45DMOF	4581	4817	5056	5388	5766	6099	6478	6954	7428
--	------	------	------	------	------	------	------	------	------

 Double-Seat, 45° Outside Curve, Mid Height Back with Shelf ZOP3-MCOD45DM1_ Beech/Laminate	5142	5381	5616	5947	6330	6661	7042	7515	7989
	Maple/Palette	5236	5472	5712	6043	6421	6754	7134	7609

ORDERING NOTE: When ordering a back with Shelf option please clearly specify on your order the required Shelf Height - 36" or 30" and chose required leg type below. Freestanding, Start and End units with the shelf option require counterbalance weight added to each seat unit, please add **\$303 list** upcharge per unit.

 Double-Seat, 45° Outside Curve, Mid Height Back with Privacy Screen Option ZOP3-MCOD45DM2F	5181	5418	5656	5986	6365	6697	7079	7552	8028
---	------	------	------	------	------	------	------	------	------







Zola Privacy Option Upcharges

	\$ List	\$ List
Moisture Barrier & CAL 133 (per yard)	64	Plus Upgrade - Double-Seat, 45° Curve
Seat Power (per unit)	641	Dual Leg (for Multiple unit configurations)
Shelf Power	599	Removable Seat Covers - Double-Seat, 45° Curve
Table Power	589	Note: Removable back covers are not available on curved backs
Combination Upholstery - dual fabrics	33	

PRODUCT CODE KEY

Line	Series	Chair Type	Curve Style	Seat Degree	Back Type	Leg Type
ZOP	3	MC	IS	30D	F0	F
Zola	Lounge	Modular Curve	Inside Curve -Single		Full Height Back	Freestanding Unit
		MCB	ID	45D	F1	S
		Modular Curve Plus	Inside Curve -Double		Full Height Back with Shelf Option	Start Unit
			OS	60D	F2	C
			Outside Curve -Single		Full Height Back with Privacy Screen Option	Center Unit
			OD	90D	M0	E
			Outside Curve -Double		Mid Height Back	End Unit
					M1	
					Mid Height Back with Shelf Option	
					M2	
					Mid Height Back with Privacy Screen Options	

ZOLA PRIVACY | CURVED







DESCRIPTION/MODEL/SPECIES	COM		COL	FABRIC GRADES			LEATHER		
	1	2	3	4	5	6	7	8	9
 Double-Seat, 60° Outside Curve, Full Height Back ZOP3-MCOD60DFOF	5050	5336	5619	6019	6474	6873	7331	7900	8471
 Double-Seat, 60° Outside Curve, Full Height Back with Shelf ZOP3-MCOD60DF1_ Beech/Laminate	5609	5894	6181	6579	7035	7435	7890	8460	9028
Maple/Palette	5702	5986	6270	6670	7125	7524	7982	8552	9120
ORDERING NOTE: When ordering a back with Shelf option please clearly specify on your order the required Shelf Height - 42", 36" or 30" and chose required leg type below. Freestanding, Start and End units with the shelf option require counterbalance weight added to each seat unit, please add \$303 list upcharge per unit.									
 Double-Seat, 60° Outside Curve, Full Height Back with Privacy Screen ZOP3-MCOD60DF2F	5647	5933	6218	6616	7072	7472	7928	8499	9067
 Double-Seat, 60° Outside Curve, Mid Height Back ZOP3-MCOD60DMOF	4798	5035	5274	5607	5985	6317	6696	7173	7646
 Double-Seat, 60° Outside Curve, Mid Height Back with Shelf ZOP3-MCOD60DM1_ Beech/Laminate	5360	5595	5833	6164	6543	6875	7257	7731	8205
Maple/Palette	5450	5686	5924	6256	6634	6968	7346	7821	8296
ORDERING NOTE: When ordering a back with Shelf option please clearly specify on your order the required Shelf Height - 36" or 30" and chose required leg type below. Freestanding, Start and End units with the shelf option require counterbalance weight added to each seat unit, please add \$303 list upcharge per unit.									
 Double-Seat, 60° Outside Curve, Mid Height Back with Privacy Screen Option ZOP3-MCOD60DM2F	5395	5634	5870	6206	6582	6914	7294	7768	8241

Zola Privacy Option Upcharges	\$ List		\$ List
Moisture Barrier & CAL 133 (per yard)	64	Plus Upgrade - Double-Seat, 60° Curve	193
Seat Power (per unit)	641	Dual Leg (for Multiple unit configurations)	80
Shelf Power	599	Removable Seat Covers - Double-Seat, 60° Curve	123
Table Power	589	Note: Removable back covers are not available on curved backs	
Combination Upholstery - dual fabrics	33		

PRODUCT CODE KEY

Line	Series	Chair Type	Curve Style	Seat Degree	Back Type	Leg Type
ZOP Zola	3 Lounge	MC Modular Curve	IS Inside Curve -Single	30D	F0 Full Height Back	F Freestanding Unit
		MCB Modular Curve Plus	ID Inside Curve -Double	45D	F1 Full Height Back with Shelf Option	S Start Unit
			OS Outside Curve -Single	60D	F2 Full Height Back with Privacy Screen Option	C Center Unit
			OD Outside Curve -Double	90D	M0 Mid Height Back	E End Unit
					M1 Mid Height Back with Shelf Option	
					M2 Mid Height Back with Privacy Screen Options	

ZOLA PRIVACY | CURVED

DESCRIPTION/MODEL/SPECIES	COM		COL		FABRIC GRADES			LEATHER	
	1	2	3	4	5	6	7	8	9
 Double-Seat, 90° Outside Curve, Full Height Back ZOP3-MCOD90DF0F	5659	5944	6229	6628	7084	7484	7940	8511	9080
 Double-Seat, 90° Outside Curve, Full Height Back with Shelf ZOP3-MCOD90DF1_ Beech/Laminate	6212	6497	6784	7182	7638	8038	8493	9064	9632
Maple/Palette	6304	6587	6873	7271	7730	8129	8584	9157	9725
ORDERING NOTES: When ordering a back with Shelf option please clearly specify on your order the required Shelf Height - 42", 36" or 30" and chose required leg type below. Freestanding, Start and End units with the shelf option require counterbalance weight added to each seat unit, please add \$303 list upcharge per unit.									
 Double-Seat, 90° Outside Curve, Full Height Back with Privacy Screen ZOP3-MCOD90DF2F	6247	6534	6819	7216	7674	8073	8529	9099	9668
 Double-Seat, 90° Outside Curve, Mid Height Back ZOP3-MCOD90DM0F	5507	5833	6159	6663	7216	7722	8276	8930	9737
 Double-Seat, 90° Outside Curve, Mid Height Back with Shelf ZOP3-MCOD90DM1_ Beech/Laminate	6060	6387	6713	7216	7770	8276	8830	9482	10291
Maple/Palette	6154	6477	6805	7310	7863	8367	8919	9573	10382
ORDERING NOTES: When ordering a back with Shelf option please clearly specify on your order the required Shelf Height - 36" or 30" and chose required leg type below. Freestanding, Start and End units with the shelf option require counterbalance weight added to each seat unit, please add \$303 list upcharge per unit.									
 Double-Seat, 90° Outside Curve, Mid Height Back with Privacy Screen Option ZOP3-MCOD90DM2F	6097	6421	6749	7255	7807	8310	8865	9517	10328





Zola Privacy Option Upcharges

	\$ List		\$ List
Moisture Barrier & CAL 133 (per yard)	64	Plus Upgrade - Double-Seat, 90° Curve	220
Seat Power (per unit)	641	Dual Leg (for Multiple unit configurations)	80
Shelf Power	599	Removable Seat Covers - Double-Seat, 90° Curve	127
Table Power	589	Note: Removable back covers are not available on curved backs	
Combination Upholstery - dual fabrics	33		

PRODUCT CODE KEY

Line	Series	Chair Type	Curve Style	Seat Degree	Back Type	Leg Type
ZOP	3	MC	IS	30D	F0	F
Zola	Lounge	Modular Curve	Inside Curve -Single		Full Height Back	Freestanding Unit
		MCB	ID	45D	F1	S
		Modular Curve Plus	Inside Curve -Double		Full Height Back with Shelf Option	Start Unit
			OS	60D	F2	C
			Outside Curve -Single		Full Height Back with Privacy Screen Option	Center Unit
			OD	90D	M0	E
			Outside Curve -Double		Mid Height Back	End Unit
					M1	
					Mid Height Back with Shelf Option	
					M2	
					Mid Height Back with Privacy Screen Options	

ZOLA PRIVACY | SIDE PANELS

DESCRIPTION/MODEL/SPECIES	COM		COL			FABRIC GRADES			LEATHER		
	1	2	3	4	5	6	7	8	9		
	Side Panel, Single, Full Height No Screen										
	ZOP3-MPF0S	Start	948	1036	1124	1304	1481	1660	1836	2016	2370
	ZOP3-MPF0C	Center	1222	1310	1398	1578	1753	1932	2109	2286	2642
	ZOP3-MPF0E	End	948	1036	1124	1304	1481	1660	1836	2016	2370
	Side Panel, Single, Full Height with Screen										
	ZOP3-MPF2S	Start	1243	1332	1420	1597	1776	1954	2132	2310	2665
	ZOP3-MPF2C	Center	1515	1606	1693	1871	2051	2228	2406	2584	2938
	ZOP3-MPF2E	End	1243	1332	1420	1597	1776	1954	2132	2310	2665
	Side Panel, Single, Mid Height No Screen										
	ZOP3-MPM0S	Start	767	829	888	1011	1131	1251	1372	1492	1732
	ZOP3-MPM0C	Center	1052	1110	1170	1290	1412	1533	1653	1773	2016
	ZOP3-MPM0E	End	767	829	888	1011	1131	1251	1372	1492	1732
	Side Panel, Single, Mid Height with Screen										
	ZOP3-MPM2S	Start	1063	1122	1183	1306	1425	1547	1667	1788	2029
	ZOP3-MPM2C	Center	1346	1405	1465	1587	1706	1827	1947	2066	2310
	ZOP3-MPM2E	End	1063	1122	1183	1306	1425	1547	1667	1788	2029

ORDERING NOTE: Side Panels will only connect to Center seating units. Units with Privacy Screen Option are not available with Removable Back Cover (per back)option. See page 234 for Dimensions and COM.

PRODUCT CODE KEY

Line	Series	Chair Type	Height	Position
ZOP	3	MP	F0	S
Zola	Lounge	Modular Side Panel	Full Height	Start
			F2	C
			Full Height with Privacy Screen Option	Center
			M0	E
			Mid Height	End
			M2	
			Mid Height with Privacy Screen Option	

ZOLA PRIVACY | SEMI-PRIVATE SIDE PANELS & MODULAR ARMS

DESCRIPTION/MODEL	COM		COL			FABRIC GRADES			LEATHER		
	1	2	3	4	5	6	7	8	9		
	Semi-Private Side Panel, Single, Full Height										
	ZOP3-MSPF0S	Start	583	628	674	765	856	949	1039	1132	1314
	ZOP3-MSPF0C	Center	857	905	952	1041	1134	1224	1315	1407	1589
	ZOP3-MSPF0E	End	583	628	674	765	856	949	1039	1132	1314

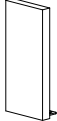
	Semi-Private Side Panel, Single, Mid Height										
	ZOP3-MSPM0S	Start	514	555	592	672	751	829	909	987	1143
	ZOP3-MSPM0C	Center	796	835	875	955	1033	1111	1191	1269	1428
	ZOP3-MSPM0E	End	514	555	592	672	751	829	909	987	1143

ORDERING NOTE: Semi-Private Side Panels will only connect to Center seating units.

PRODUCT CODE KEY

Line	Series	Chair Type	Height	Position
ZOP Zola	3 Lounge	MSP Modular Semi-Private Side Panel	F0 Full Height M0 Mid Height	S Start C Center E End

ZOLA PRIVACY | MODULAR ARMS

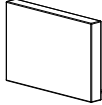
DESCRIPTION/MODEL	COM		COL			FABRIC GRADES			LEATHER		
	1	2	3	4	5	6	7	8	9		
	Modular Upholstered Arm										
	ZOP3-MAUPLH*		702	740	778	853	930	1004	1081	1155	1307
	ZOP3-MAUPHR		702	740	778	853	930	1004	1081	1155	1307
	ZOP3-MAUPHC		784	823	859	935	1012	1087	1163	1239	1390

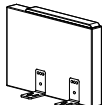
	Modular Upholstered Arm w/Urethane Cap										
	ZOP3-MAUREL		840	878	914	990	1066	1141	1218	1292	1445
	ZOP3-MAURER*		840	878	914	990	1066	1141	1218	1292	1445
	ZOP3-MAUREC		906	942	981	1058	1134	1207	1284	1358	1510

ORDERING NOTE: To specify Solid Surface Arm Caps on Modular Upholstered Arms, please add upcharge below and change UPH in the model number to SSC.

Zola Option Upcharges	Grades			
	A-White	A-Color	B	C
Solid Surface Arm Cap (per arm)	129	136	151	157

PRODUCT CODE KEY

Line	Series	Type	Arm	Position
ZOP Zola	3 Lounge	MA Modular Arm	UPH Upholstered URE Upholstered Arm w/Urethane Cap SSC Upholstered Arm w/Solid Surface Cap	L Left Hand Facing R Right Hand facing C Center

ZOLA PRIVACY | TWIN CURVED - DIMENSIONS & COM REQUIREMENTS

DIMENSIONS

	Overall Width	Width with Arms	Overall Depth	Overall Height	Height w/Screen	Overall Seat Height	Seat Depth	Shipping Weight	Cubes
Twin Curved Single-Seat - Full Height Back									
30° Curve	49	55	53.5	50	62.5	18.5	20.25	127	31
45° Curve	61.5	67.5	54	50	62.5	18.5	20.25	146	42
60° Curve	73.5	79.5	55	50	62.5	18.5	20.25	164	55
90° Curve	94.5	100.5	56.5	50	62.5	18.5	20.25	207	79
Twin Curved Single-Seat - Mid Height Back									
30° Curve	49	55	53.5	37.5	50	18.5	20.25	122	27
45° Curve	61.5	67.5	54	37.5	50	18.5	20.25	140	37
60° Curve	73.5	79.5	55	37.5	50	18.5	20.25	158	48
90° Curve	94.5	100.5	56.5	37.5	50	18.5	20.25	200	68
Twin Curved Double-Seat - Full Height Back									
30° Curve	71	77	55	50	62.5	18.5	20.25	199	55
45° Curve	83.5	89.5	56	50	62.5	18.5	20.25	215	73
60° Curve	95.5	101.5	58	50	62.5	18.5	20.25	237	92
Twin Curved Double-Seat - Mid Height Back									
30° Curve	71	77	55	37.5	50	18.5	20.25	199	48
45° Curve	83.5	89.5	56	37.5	50	18.5	20.25	215	64
60° Curve	95.5	101.5	58	37.5	50	18.5	20.25	237	81

COM YARDAGES

	Yardage Entire Unit	Yardage 2 Entire Units	Yardage 3 Entire Units	Yardage 4 Entire Units	Yardage per Back	Yardage per 2 Backs	Yardage per 3 Backs	Yardage per 4 Backs
Curved Single-Seat - Full Height Back								
30° Curve	8.6	15.6	24.2	31.2	4.8	8	12.8	16
45° Curve	9.6	17.6	27.2	35.2	4.8	8	12.8	16
60° Curve	11.53	20.8	31.2	41.6	6.33	10.4	15.6	20.8
90° Curve	11.83	24.50	36.75	48.70	6.33	13.5	20.25	27
Curved Single-Seat - Mid Height Back								
30° Curve	7.63	13.85	21.48	27.7	3.83	6.25	10.08	12.5
45° Curve	8.63	15.85	24.48	31.7	3.83	6.25	10.08	12.5
60° Curve	10.2	18.4	27.6	36.8	5	8	12	16
90° Curve	10.5	21	31.5	41.7	5	10	15	20
Curved Double-Seat - Full Height Back								
30° Curve	12.96	27.1	40.65	54.2	6.16	13.5	20.25	27
45° Curve	13.13	27.1	40.65	54.2	6.33	13.5	20.25	27
60° Curve	13.23	27.3	40.95	54.6	6.33	13.5	20.25	27
90° Curve								
Curved Double-Seat - Mid Height Back								
30° Curve	11.63	23.60	35.4	47.2	4.83	10	15	20
45° Curve	11.8	23.6	35.4	47.2	5	10	15	20
60° Curve	11.9	23.8	35.7	47.6	5	10	15	20

ZOLA PRIVACY | TWIN CURVED - COM REQUIREMENTS

	Yardage 1 Seat-Small Seat	Yardage 2 Seat-Small Seats	Yardage 3 Seat-Small Seats	Yardage 4 Seat-Small Seats	Yardage 1 Seat-Large Seat	Yardage 2 Seat-Large Seats	Yardage 3 Seat-Large Seats	Yardage 4 Seat-Large Seats
Curved Single-Seat - Full Height Back								
30° Curve	1.8	3.6	5.4	7.2	2	4	6	8
45° Curve	1.8	3.6	5.4	7.2	3	6	9	12
60° Curve	1.8	3.6	5.4	7.2	3.4	6.8	10.2	13.6
90° Curve	1.8	3.6	5.4	7.2	3.7	7.4	11.10	14.5
Curved Single-Seat - Mid Height Back								
30° Curve	1.8	3.6	5.4	7.2	2	4	6	8
45° Curve	1.8	3.6	5.4	7.2	3	6	9	12
60° Curve	1.8	3.6	5.4	7.2	3.4	6.8	10.2	13.6
90° Curve	1.8	3.6	5.4	7.2	3.7	7.4	11.1	14.5
Curved Double-Seat - Full Height Back								
30° Curve	3.4	6.8	10.2	13.6	3.4	6.8	10.2	13.6
45° Curve	3.4	6.8	10.2	13.6	3.4	6.8	10.2	13.6
60° Curve	3.4	6.8	10.2	13.6	3.5	7	10.5	14
Curved Double-Seat - Mid Height Back								
30° Curve	3.4	6.8	10.2	13.6	3.4	6.8	10.2	13.6
45° Curve	3.4	6.8	10.2	13.6	3.4	6.8	10.2	13.6
60° Curve	3.4	6.8	10.2	13.6	3.4	7	10.5	14

ZOLA PRIVACY | TWIN CURVED

DESCRIPTION/MODEL	COM		COL	FABRIC GRADES			LEATHER		
	1	2	3	4	5	6	7	8	9

	Twin Single-Seat, 30° Curve, Full Height Back ZOP3-MCTS30DF0F	5204	5517	5830	6268	6767	7208	7709	8335	8960
--	--	------	------	------	------	------	------	------	------	------

	Twin Single-Seat, 30° Curve, Full Height Back with Privacy Screen Option ZOP3-MCTS30DF2F	5796	6111	6422	6862	7362	7800	8302	8930	9555
--	---	------	------	------	------	------	------	------	------	------

	Twin Single-Seat, 30° Curve, Mid Height Back ZOP3-MCTS30DM0F	4930	5213	5494	5888	6336	6731	7180	7741	8305
--	---	------	------	------	------	------	------	------	------	------

	Twin Single-Seat, 30° Curve, Mid Height Back with Privacy Screen Option ZOP3-MCTS30DM2F	5525	5806	6085	6480	6931	7323	7773	8337	8896
--	--	------	------	------	------	------	------	------	------	------

	Twin Single-Seat, 45° Curve, Full Height Back ZOP3-MCTS45DF0F	5867	6191	6519	6977	7498	7953	8477	9130	9781
--	--	------	------	------	------	------	------	------	------	------







	Twin Single-Seat, 45° Curve, Full Height Back with Privacy Screen Option ZOP3-MCTS45DF2F	6468	6793	7120	7577	8098	8555	9079	9730	10382
--	---	------	------	------	------	------	------	------	------	-------

Zola Privacy Option Upcharges	\$ List	\$ List
Moisture Barrier & CAL 133 (per yard)	64	Plus Upgrade - Twin Single-Seat, 30° Curve 287
Seat Power (per unit)	641	Plus Upgrade - Twin Single-Seat, 45° Curve 345
Shelf Power	599	Removable Seat Covers -Twin Single-Seat, 30° Curve 155
Table Power	589	Removable Seat Covers -Twin Single-Seat, 45° Curve 166
Dual Leg (for Multiple unit configurations)	80	Note: Removable back covers are not available on curved backs

PRODUCT CODE KEY

Line	Series	Chair Type	Curve Style	Seat Degree	Back Type	Leg Type
ZOP Zola	3 Lounge	MCT Modular Curve Twin	S Small Radius- Single Width	30D	F0 Full Height Back	F Freestanding Unit
		MCTB Modular Curve Twin Plus	D Small Radius- Double Width	45D	F2 Full Height Back with Privacy Screen Option	S Start Unit
				60D	M0 Mid Height Back	C Center Unit
				90D	M2 Mid Height Back with Privacy Screen Options	E End Unit

ZOLA PRIVACY | TWIN CURVED

DESCRIPTION/MODEL	COM		COL	FABRIC GRADES			LEATHER		
	1	2	3	4	5	6	7	8	9
 Twin Single-Seat, 45° Curve, Mid Height Back ZOP3-MCTS45DMOF	5556	5850	6142	6556	7027	7438	7909	8499	9087
 Twin Single-Seat, 45° Curve, Mid Height Back with Privacy Screen Option ZOP3-MCTS45DM2F	5531	5812	6093	6489	6938	7331	7781	8342	8905
 Twin Single-Seat, 60° Curve, Full Height Back ZOP3-MCTS60DFOF	6662	7045	7430	7966	8580	9116	9729	10495	11261
 Twin Single-Seat, 60° Curve, Full Height Back with Privacy Screen Option ZOP3-MCTS60DF2F	7266	7649	8033	8569	9184	9719	10333	11098	11866
 Twin Single-Seat, 60° Curve, Mid Height Back ZOP3-MCTS60DMOF	6304	6644	6983	7460	8002	8477	9020	9697	10379
 Twin Single-Seat, 60° Curve, Mid Height Back with Privacy Screen Option ZOP3-MCTS60DM2F	7480	7913	8345	8955	9650	10259	10953	11820	12688

Zola Privacy Option Upcharges

	\$ List		\$ List
Moisture Barrier & CAL 133 (per yard)	64	Plus Upgrade - Twin Single-Seat, 45° Curve	345
Seat Power (per unit)	641	Plus Upgrade - Twin Single-Seat, 60° Curve	404
Shelf Power	599	Removable Seat Covers -Twin Single-Seat, 45° Curve	166
Table Power	589	Removable Seat Covers -Twin Single-Seat, 60° Curve	212
Dual Leg (for Multiple unit configurations)	80	Note: Removable back covers are not available on curved backs	

PRODUCT CODE KEY

Line	Series	Chair Type	Curve Style	Seat Degree	Back Type	Leg Type
ZOP Zola	3 Lounge	MCT Modular Curve Twin	S Small Radius- Single Width	30D	F0 Full Height Back	F Freestanding Unit
		MCTB Modular Curve Twin Plus	D Small Radius- Double Width	45D	F2 Full Height Back with Privacy Screen Option	S Start Unit
				60D	M0 Mid Height Back	C Center Unit
				90D	M2 Mid Height Back with Privacy Screen Options	E End Unit

ZOLA PRIVACY | TWIN CURVED

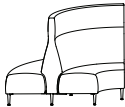
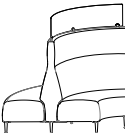
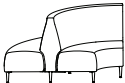
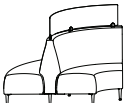

DESCRIPTION/MODEL/SPECIES	COM		COL	FABRIC GRADES			LEATHER		
	1	2	3	4	5	6	7	8	9
 Twin Single-Seat, 90° Curve, Full Height Back ZOP3-MCTS90DF0F	8312	8702	9091	9644	10270	10818	11446	12225	13017
 Twin Single-Seat, 90° Curve, Full Height Back with Privacy Screen Option ZOP3-MCTS90DF2F	9265	9654	10044	10594	11223	11769	12396	13175	13969
 Twin Single-Seat, 90° Curve, Mid Height Back ZOP3-MCTS90DM0F	7814	8159	8506	8994	9550	10040	10594	11286	11991
 Twin Single-Seat, 90° Curve, Mid Height Back with Privacy Screen Option ZOP3-MCTS90DM2F	7447	7838	8230	8775	9398	9945	10570	11349	12130

Zola Privacy Option Upcharges	\$ List	\$ List
Moisture Barrier & CAL 133 (per yard)	64	Plus Upgrade - Twin Single-Seat, 90° Curve 516
Seat Power (per unit)	641	Dual Leg (for Multiple unit configurations) 80
Shelf Power	599	Removable Seat Covers -Twin Single-Seat, 90° Curve 240
Table Power	589	Note: Removable back covers are not available on curved backs

PRODUCT CODE KEY

Line	Series	Chair Type	Curve Style	Seat Degree	Back Type	Leg Type
ZOP Zola	3 Lounge	MCT Modular Curve Twin	S Small Radius- Single Width	30D	F0 Full Height Back	F Freestanding Unit
		MCTB Modular Curve Twin Plus	D Small Radius- Double Width	45D	F2 Full Height Back with Privacy Screen Option	S Start Unit
				60D	M0 Mid Height Back	C Center Unit
				90D	M2 Mid Height Back with Privacy Screen Options	E End Unit

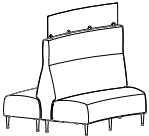
ZOLA PRIVACY | TWIN CURVED

DESCRIPTION/MODEL/SPECIES	COM		COL		FABRIC GRADES			LEATHER	
	1	2	3	4	5	6	7	8	9
 Twin Double-Seat, 30° Curve, Full Height Back ZOP3-MCTD30DF0F	6875	7311	7743	8350	9046	9654	10348	11216	12086
 Twin Double-Seat, 30° Curve, Full Height Back with Privacy Screen Option ZOP3-MCTD30DF2F	7820	8256	8688	9296	9991	10598	11293	12163	13029
 Twin Double-Seat, 30° Curve, Mid Height Back ZOP3-MCTD30DM0F	6496	6886	7279	7822	8447	8993	9619	10399	11179
 Twin Double-Seat, 30° Curve, Mid Height Back with Privacy Screen Option ZOP3-MCTD30DM2F	7441	7833	8222	8768	9393	9938	10564	11344	12122





Zola Privacy Option Upcharges

	\$ List	\$ List
Moisture Barrier & CAL 133 (per yard)	64	Plus Upgrade - Twin Double-Seat, 30° Curve 404
Seat Power (per unit)	641	Dual Leg (for Multiple unit configurations) 80
Shelf Power	599	Removable Seat Covers -Twin Double-Seat, 30° Curve 186
Table Power	589	Note: Removable back covers are not available on curved backs

PRODUCT CODE KEY

Line	Series	Chair Type	Curve Style	Seat Degree	Back Type	Leg Type
ZOP Zola	3 Lounge	MCT Modular Curve Twin	S Small Radius- Single Width	30D	F0 Full Height Back	F Freestanding Unit
		MCTB Modular Curve Twin Plus	D Small Radius- Double Width	45D	F2 Full Height Back with Privacy Screen Option	S Start Unit
				60D	M0 Mid Height Back	C Center Unit
				90D	M2 Mid Height Back with Privacy Screen Options	E End Unit

ZOLA PRIVACY | TWIN CURVED

DESCRIPTION/MODEL/SPECIES	COM		COL	FABRIC GRADES			LEATHER		
	1	2	3	4	5	6	7	8	9
 Twin Double-Seat, 45° Curve, Full Height Back ZOP3-MCTD45DF0F	7754	8198	8645	9269	9983	10606	11320	12211	13105
 Twin Double-Seat, 45° Curve, Full Height Back with Privacy Screen Option ZOP3-MCTD45DF2F	8706	9156	9600	10222	10937	11561	12274	13167	14058
 Twin Double-Seat, 45° Curve, Mid Height Back ZOP3-MCTD45DM0F	7346	7750	8152	8715	9358	9919	10564	11367	12171
 Twin Double-Seat, 45° Curve, Mid Height Back with Privacy Screen Option ZOP3-MCTD45DM2F	8304	8703	9108	9668	10312	10875	11517	12320	13127

ORDERING NOTES:

The 90° size is not available in a Double-Seat unit, order two 45° degree single units.



Zola Privacy Option Upcharges

	\$ List		\$ List
Moisture Barrier & CAL 133 (per yard)	64	Plus Upgrade - Twin Double-Seat, 45° Curve	458
Seat Power (per unit)	641	Dual Leg (for Multiple unit configurations)	80
Shelf Power	599	Removable Seat Covers - Twin Double-Seat, 45° Curve	204
Table Power	589	Note: Removable back covers are not available on curved backs	

PRODUCT CODE KEY

Line	Series	Chair Type	Curve Style	Seat Degree	Back Type	Leg Type
ZOP Zola	3 Lounge	MCT Modular Curve Twin	S Small Radius- Single Width	30D	F0 Full Height Back	F Freestanding Unit
		MCTB Modular Curve Twin Plus	D Small Radius- Double Width	45D	F2 Full Height Back with Privacy Screen Option	S Start Unit
				60D	M0 Mid Height Back	C Center Unit
				90D	M2 Mid Height Back with Privacy Screen Options	E End Unit

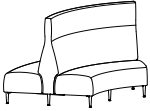
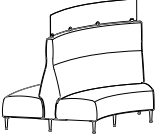
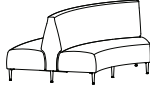
ZOLA PRIVACY | TWIN CURVED

DESCRIPTION/MODEL/SPECIES	COM		COL	FABRIC GRADES			LEATHER		
	1	2	3	4	5	6	7	8	9
 Twin Double-Seat, 60° Curve, Full Height Back ZOP3-MCTD60DF0F	8458	8912	9363	9996	10721	11353	12079	12983	13887
 Twin Double-Seat, 60° Curve, Full Height Back with Privacy Screen Option ZOP3-MCTD60DF2F	9418	9873	10324	10958	11680	12315	13038	13944	14848
 Twin Double-Seat, 60° Curve, Mid Height Back ZOP3-MCTD60DM0F	7994	8404	8811	9383	10039	10609	11264	12083	12897
 Twin Double-Seat, 60° Curve, Mid Height Back with Privacy Screen Option ZOP3-MCTD60DM2F	8955	9363	9772	10344	10995	11568	12225	13042	13858



Zola Privacy Option Upcharges

	\$ List		\$ List
Moisture Barrier & CAL 133 (per yard)	64	Plus Upgrade - Twin Double-Seat, 60° Curve	543
Seat Power (per unit)	641	Dual Leg (for Multiple unit configurations)	80
Shelf Power	599	Removable Seat Covers -Twin Double-Seat, 60° Curve	248
Table Power	589	Note: Removable back covers are not available on curved backs	

PRODUCT CODE KEY

Line	Series	Chair Type	Curve Style	Seat Degree	Back Type	Leg Type
ZOP Zola	3 Lounge	MCT Modular Curve Twin	S Small Radius- Single Width	30D	F0 Full Height Back	F Freestanding Unit
		MCTB Modular Curve Twin Plus	D Small Radius- Double Width	45D	F2 Full Height Back with Privacy Screen Option	S Start Unit
				60D	M0 Mid Height Back	C Center Unit
				90D	M2 Mid Height Back with Privacy Screen Options	E End Unit

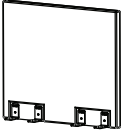
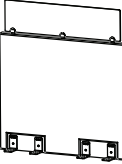
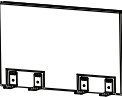
ZOLA PRIVACY | TWIN SIDE PANELS

DESCRIPTION/MODEL	COM		COL		FABRIC GRADES			LEATHER		
	1	2	3	4	5	6	7	8	9	
 Twin Side Panel, Full Height No Screen ZOP3-MPTF0U Universal End ZOP3-MPTF0C Center	1428	1559	1691	1955	2218	2483	2745	3010	3536	
	2139	2272	2405	2668	2932	3193	3457	3720	4248	
	<hr/>									
 Twin Side Panel, Full Height with Screen ZOP3-MPTF2U Universal End ZOP3-MPTF2C Center	2006	2138	2271	2533	2798	3061	3324	3589	4114	
	2718	2851	2984	3246	3510	3772	4037	4297	4828	
	<hr/>									
 Twin Side Panel, Med. Height No Screen - ZOP3-MPTM0U Universal End ZOP3-MPTM0C Center	1187	1275	1363	1543	1720	1898	2077	2254	2610	
	1897	1988	2077	2254	2432	2610	2788	2965	3322	
	<hr/>									
 Twin Side Panel, Med. Height with Screen ZOP3-MPTM2U Universal End ZOP3-MPTM2C Center	1767	1855	1944	2122	2301	2479	2657	2833	3188	
	2478	2567	2657	2833	3011	3188	3367	3543	3902	

ORDERING NOTE: Side Panels will only connect to Center seating units. Units with Privacy Screen Option are not available with Removable Back Cover option. See page 234 for dimensions & C.O.M.

PRODUCT CODE KEY

Line	Series	Chair Type	Height	Position
ZOP	3	MPT	F0	U
Zola	Lounge	Modular Side Panel Twin	Full Height	Universal (S or E)
			F2	C
			Full Height with Privacy Screen Option	Center /Interim
			M0	
			Mid Height	
			M2	
			Mid Height with Privacy Screen Option	

ZOLA PRIVACY | TWIN SEMI-PRIVATE SIDE PANELS & MODULAR ARMS

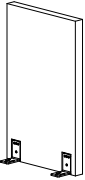
DESCRIPTION/MODEL	COM		COL	FABRIC GRADES			LEATHER				
	1	2	3	4	5	6	7	8	9		
	Twin Semi-Private Side Panel, Single, Full Height										
	ZOP3-MSPTF0U	Universal	1012	1092	1172	1286	1415	1528	1659	1819	1981
	ZOP3-MSPTF0C	Center	1724	1804	1885	1999	2129	2240	2370	2532	2694

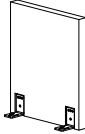
	Twin Semi-Private Side Panel, Single, Mid Height										
	ZOP3-MSPTM0U	Universal	868	919	973	1045	1131	1203	1288	1393	1497
	ZOP3-MSPTM0C	Center	1581	1633	1686	1758	1842	1915	2001	2106	2211

ORDERING NOTE: Semi-Private Side Panels will only connect to Center seating units. See page 244 for dimensions and COM.

PRODUCT CODE KEY

Line	Series	Type	Height	Position
ZOP	3	MSPT	F0	U
Zola	Lounge	Modular Arm Twin	Full Height	Universal (S or E)
			M0	C
			Mid Height	Center /Interim

ZOLA PRIVACY | TWIN MODULAR ARMS

DESCRIPTION/MODEL	COM		COL	FABRIC GRADES			LEATHER				
	1	2	3	4	5	6	7	8	9		
	Twin Modular Upholstered Arm										
	ZOP3-MATUPHU		1120	1197	1262	1349	1451	1539	1641	1768	1894
	ZOP3-MATUPHC		1846	1909	1974	2062	2164	2253	2354	2481	2608

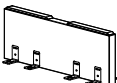
	Twin Modular Upholstered Arm w/Urethane Cap										
	ZOP3-MATUREU		1252	1329	1393	1481	1582	1670	1772	1899	2026
	ZOP3-MATUREC		1979	2041	2106	2193	2295	2384	2485	2612	2739



ORDERING NOTE: To specify Solid Surface Arm Caps on Modular Upholstered Arms, please add upcharge below and change UPH in the model number to SSC.

Zola Option Upcharges	Grades			
	A-White	A-Color	B	C
Solid Surface Arm Cap (per arm)	276	288	318	328

PRODUCT CODE KEY

Line	Series	Type	Arm	Position
ZOP	3	MAT	UPH	U
Zola	Lounge	Modular Arm Twin	Upholstered	Universal (S or E)
			URE	C
			Upholstered Arm w/Urethane Cap	Center /Interim
			SSC	
			Upholstered Arm w/Solid Surface Cap	

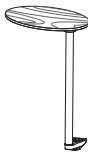
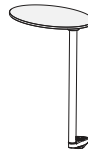
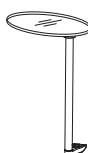
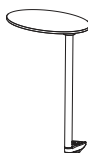
ZOLA PRIVACY | TABLETS

DESCRIPTION	MODEL	SPECIES	PRICE	WEIGHT	CUBE
	Wood Tablet				
	ZOL3 T1	Beech Maple /Cherry	514 538	12	2
	Tablet with Palette Finish				
ZOL3 T2	n/a	411	12	2	
	Clear Glass Tablet				
ZOL3 T3	n/a	783	13	2	
	Laminate Tablet				
ZOL3 T4	n/a	532	12	2	
ORDERING NOTES: The laminate tablet comes standard with a polymer edge. Please note Zola Tablets are universally handed and do not need to be specified right or left when ordering.					
	Solid Surface Tablet - Grade A White				
	ZOL3 T5AW	n/a	641	14	2
	Solid Surface Tablet - Grade A Color				
	ZOL3 T5AC	n/a	651	14	2
Solid Surface Tablet - Grade B					
ZOL3 T5B	n/a	686	14	2	
Solid Surface Tablet - Grade C					
ZOL3 T5C	n/a	741	14	2	

ZOLA PRIVACY | INLINE WALLS | FEATURES & OPTIONS



RECONFIGURABILITY

Inline Walls can be reconfigured within Zola Privacy seating configurations. Inline walls are comprised of 3 module types, a left and a right corner unit plus a center unit and are available in two depths - Inline Wall at 12 inches and Inline Table Wall at 28 inches. Inline Wall corner units and Inline Table Walls must connect to Start, Center or End seating unit.



BACK CONNECTION

Inline Corner Walls and Inline Tables connect to Zola Privacy seating using steel brackets. Seating must be specified as start, center or ends.



LEGS

The legs offered on Zola Lounge are Silver Metallic or Matte Black and feature and feature glides that are adjustable up to 1.25", which provide leveling capability over longer spans. Caster leg is not available.

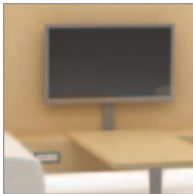

MEDIA & POWER

Inline walls can be optioned with Media provisions and Powerdocs.



RUNOFF TABLES

Run-off tables are used in combination with Inline Walls and provide a fixed occasional height table between two seating units. They feature a single tapered metal leg with adjustable glide.



LAMINATE OR WOOD OPTIONS

Inline walls are offered in wood and laminate surfaces. They create a straight wall partition between two opposing seating units. Walls are available in Mid and Full Height back styles and are 12" in depth at the base.



SOLID SURFACE OVERLAY

The Solid Surface top option is priced as an upcharge to existing table price. Zola Solid Surface tables have a 1/2" thickness on top of the existing table, with a 1 mm overhang (soft radius vertical edge). Please see page 631 for color options.

ZOLA PRIVACY | INLINE WALLS | SAMPLE CONFIGURATIONS

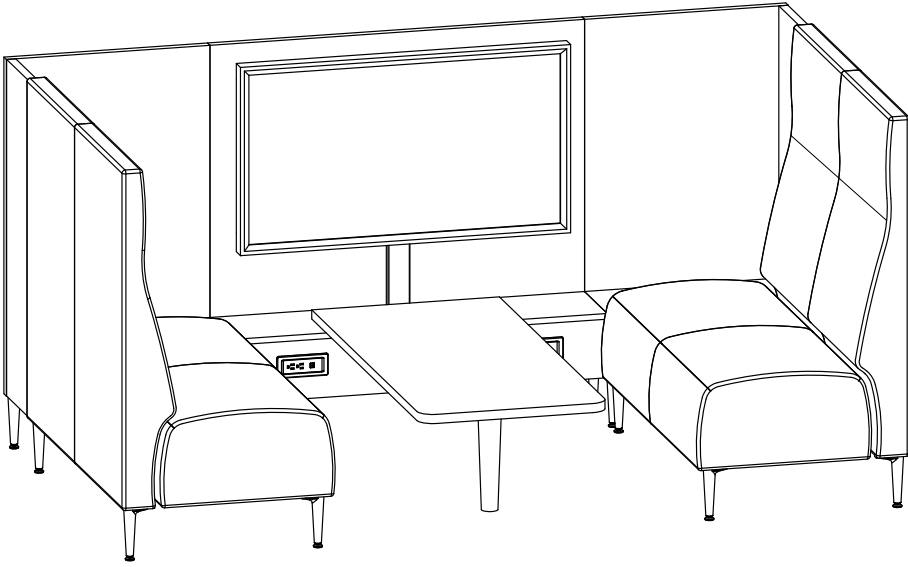

Model	Qty	Price (\$)
ZOP3-M2F0F	2	3029
ZOP3-IWF048MP	1	2404
ZOP3-ICWF0L	1	1697
ZOP3-ICWF0R	1	1697
ZOP3-RO48532416	1	1066
Total		\$12,922

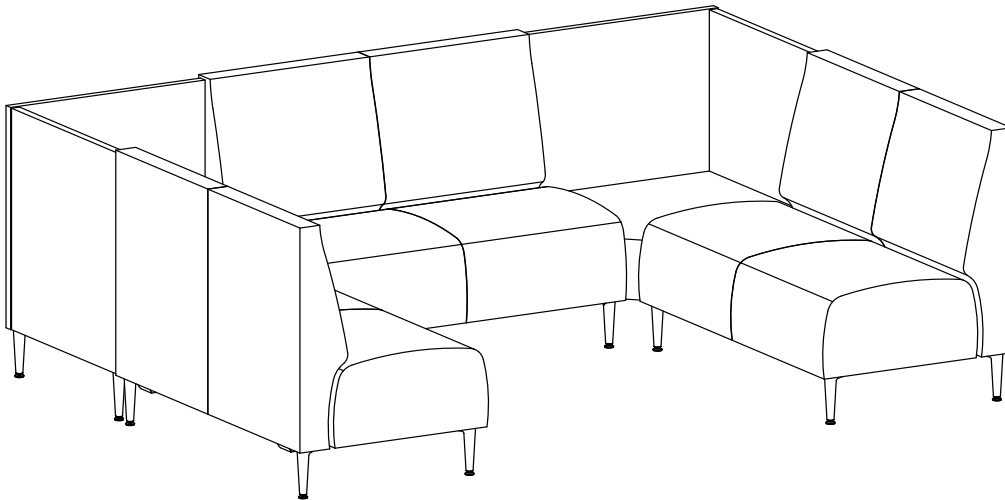

Model	Qty	Price (\$)
ZOP3-M2M0F	3	2595
ZOP3-ICTWM0L	1	1715
ZOP3-ICTWM0R	1	1715
Total		\$11,215

ZOLA PRIVACY | INLINE WALLS

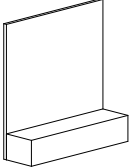
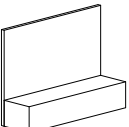
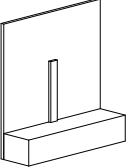
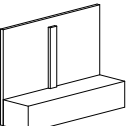
DESCRIPTION/MODEL	THERMOFUSED LAMINATE	HIGH PRESSURE LAMINATE	CHERRY MAPLE BEECH	W	D	H	WEIGHT CUBE		
	Inline Wall, Full Height 42" ZOP3-IWF042N	1172	1985	1673	42	12	50	107	19
	Inline Wall, Full Height 48" ZOP3-IWF048N	1262	2167	1774	48	12	50	121	21.5
	Inline Wall, Full Height 54" ZOP3-IWF054N	1349	2255	1875	54	12	50	135	24
	Inline Wall, Full Height 60" ZOP3-IWF060N	1437	2343	1974	60	12	50	147	26.5
	Inline Wall, Mid Height 42" ZOP3-IWM042N	1095	1683	1588	42	12	37	92	13.5
	Inline Wall, Mid Height 48" ZOP3-IWM048N	1184	1863	1688	48	12	37	102	15.25
	Inline Wall, Mid Height 54" ZOP3-IWM054N	1271	1953	1789	54	12	37	116	17
	Inline Wall, Mid Height 60" ZOP3-IWM060N	1359	2040	1886	60	12	37	126	18.75
	Inline Wall Media, Full Height 42" ZOP3-IWF042M	1318	2131	1820	42	12	50	107	19
	Inline Wall Media, Full Height 48" ZOP3-IWF048M	1407	2313	1921	48	12	50	121	21.5
	Inline Wall Media, Full Height 54" ZOP3-IWF054M	1494	2401	2019	54	12	50	135	24
	Inline Wall Media, Full Height 60" ZOP3-IWF060M	1583	2488	2119	60	12	50	147	26.5
	Inline Wall Media, Mid Height 42" ZOP3-IWM042M	1242	1827	1734	42	12	37	92	13.5
	Inline Wall Media, Mid Height 48" ZOP3-IWM048M	1330	2010	1834	48	12	37	102	15.25
	Inline Wall Media, Mid Height 54" ZOP3-IWM054M	1417	2096	1934	54	12	37	116	17
	Inline Wall Media, Mid Height 60" ZOP3-IWM060M	1506	2186	2033	60	12	37	126	18.75

ORDERING NOTE: Inline Walls only connect to Inline Corner Walls.

PRODUCT CODE KEY

Line	Series	Chair Type	Height	Size	Power/Media
ZOP	3	IW	F0	42	N
Zola	Lounge	Inline Wall	Full Height	42"	None
			M0	48	P
			Mid Height	48"	PowerDoc
				54	M
				54"	Media
				60	MP
				60"	PowerDoc & Media

ZOLA PRIVACY | INLINE WALLS WITH POWER

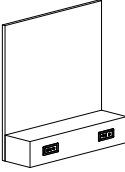
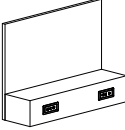
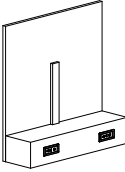
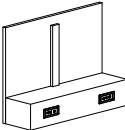
DESCRIPTION/MODEL	THERMOFUSED LAMINATE	HIGH PRESSURE LAMINATE	CHERRY MAPLE BEECH	W	D	H	WEIGHT CUBE		
	Inline Wall w/Power Docs, Full Height 42" ZOP3-IWF042P	2169	2982	2671	42	12	50	150	19
	Inline Wall w/Power Docs, Full Height 48" ZOP3-IWF048P	2257	3163	2770	48	12	50	212	21.5
	Inline Wall w/Power Docs, Full Height 54" ZOP3-IWF054P	2345	3251	2870	54	12	50	135	24
	Inline Wall w/Power Docs, Full Height 60" ZOP3-IWF060P	2433	3340	2970	60	12	50	147	26.5
	Inline Wall w/Power Docs, Mid Height 42" ZOP3-IWM042P	2091	2678	2585	42	12	37	92	13.5
	Inline Wall w/Power Docs, Mid Height 48" ZOP3-IWM048P	2180	2860	2684	48	12	37	102	15.5
	Inline Wall w/Power Docs, Mid Height 54" ZOP3-IWM054P	2268	2948	2785	54	12	37	116	17
	Inline Wall w/Power Docs, Mid Height 60" ZOP3-IWM060P	2356	3036	2883	60	12	37	126	18.75
	Inline Wall Media w/Power Docs, Full Height 42" ZOP3-IWF042MP	2316	3127	2817	42	12	50	150	19
	Inline Wall Media w/Power Docs, Full Height 48" ZOP3-IWF048MP	2404	3310	2917	48	12	50	212	21.5
	Inline Wall Media w/Power Docs, Full Height 54" ZOP3-IWF054MP	2491	3397	3015	54	12	50	135	24
	Inline Wall Media w/Power Docs, Full Height 60" ZOP3-IWF060MP	2580	3486	3116	60	12	50	147	26.5
	Inline Wall Media w/Power Docs, Mid Height 42" ZOP3-IWM042MP	2238	2823	2730	42	12	37	92	13.5
	Inline Wall Media w/Power Docs, Mid Height 48" ZOP3-IWM048MP	2326	3007	2830	48	12	37	102	15.5
	Inline Wall Media w/Power Docs, Mid Height 54" ZOP3-IWM054MP	2413	3093	2929	54	12	37	116	17
	Inline Wall Media w/Power Docs, Mid Height 60" ZOP3-IWM060MP	2503	3182	3030	60	12	37	126	18.75

ORDERING NOTE: Inline Walls only connect to Inline Corner Walls.

PRODUCT CODE KEY

Line	Series	Chair Type	Height	Size	Power/Media
ZOP	3	IW	F0	42	N
Zola	Lounge	Inline Wall	Full Height	42"	None
			M0	48	P
			Mid Height	48"	PowerDoc
				54	M
				54"	Media
				60	MP
				60"	PowerDoc & Media

ZOLA PRIVACY | INLINE CORNER WALLS

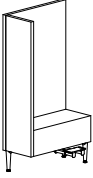
DESCRIPTION/MODEL	THERMOFUSED LAMINATE	HIGH PRESSURE LAMINATE	CHERRY MAPLE BEECH	W	D	H	WEIGHT CUBE	
 Inline Corner Wall, Full Height ZOP3-ICWF0L ZOP3-ICWF0R	1697	2388	2045	26.5	12	50	85	14.75
	1697	2388	2045	26.5	12	50	85	14.75

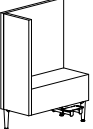
 Inline Corner Wall, Mid Height ZOP3-ICWM0L ZOP3-ICWM0R	1638	2278	1976	26.5	12	37	70	11
	1638	2278	1976	26.5	12	37	70	11

ZOLA INLINE WALLS SOLID SURFACE OVERLAY UPCHARGES

Option	Grades			
	A-White	A-Color	B	C
ZOP3-IWF042N	427	446	556	662
ZOP3-IWF048N	478	500	622	745
ZOP3-IWF054N	530	555	693	829
ZOP3-IWF060N	555	607	761	913

ORDERING NOTES:

The Solid Surface top option is priced as an upcharge to existing table price. Please add a "S" to the end of the model number and the upcharge listed below. Zola Solid Surface tables have a 1/2" thickness on top of the existing table, with a 1 mm overhang (soft radius vertical edge). Please see page 631 for color options.

ORDERING NOTE: Inline Walls only connect to Inline Corner Walls.

PRODUCT CODE KEY

Line	Series	Chair Type	Height	Position
ZOP	3	ICW	F0	L
Zola	Lounge	Inline Corner Wall	Full Height	Left
			M0	R
			Mid Height	Right

ZOLA PRIVACY | INLINE TABLE WALLS

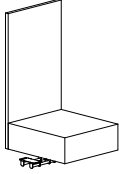
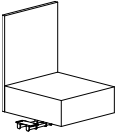
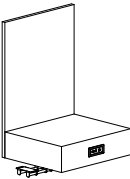
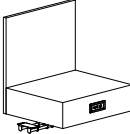
DESCRIPTION/MODEL	THERMOFUSED LAMINATE	HIGH PRESSURE LAMINATE	CHERRY MAPLE BEECH	W	D	H	WEIGHT	CUBE
	Inline Table Wall, Full Height 23" ZOP3-ITWF023N	987	1582	1494	23	25.7	50	100 21
	Inline Table Wall, Full Height 30" ZOP3-ITWF030N	1163	1946	1684	30	25.7	50	125 26.5
	Inline Table Wall, Mid Height 23" ZOP3-ITWM023N	910	1279	1408	23	25.7	37	90 15
	Inline Table Wall, Mid Height 30" ZOP3-ITWM030N	1086	1643	1596	30	25.7	37	115 18.5
	Inline Table Wall w/Power Docs, Full Height 23" ZOP3-ITWF023P	1984	2579	2491	23	25.7	50	100 21
	Inline Table Wall w/Power Docs, Full Height 30" ZOP3-ITWF030P	2160	2943	2680	30	25.7	50	125 26.5
	Inline Table Wall w/Power Docs, Mid Height 23" ZOP3-ITWM023P	1906	2274	2405	23	25.7	37	90 15
	Inline Table Wall w/Power Docs, Mid Height 30" ZOP3-ITWM030P	2083	2639	2592	30	25.7	37	115 18.5

ORDERING NOTE: For reverse grain direction on table surfaces use list price and note Reverse Grain on p.o.

PRODUCT CODE KEY

Line	Series	Chair Type	Height	Size	Power/Media
ZOP	3	ITW	F0	23	N
Zola	Lounge	Inline Table Wall	Full Height	23"	None
			M0	30	P
			Mid Height	30"	Power

ZOLA PRIVACY | INLINE CORNER TABLE WALLS & INLINE RUN-OFF TABLES

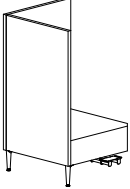
DESCRIPTION/MODEL	THERMOFUSED LAMINATE	HIGH PRESSURE LAMINATE	CHERRY MAPLE BEECH	W	D	H	WEIGHT	CUBE
 Inline Corner Table Wall, Full Height ZOP3-ICTWF0L ZOP3-ICTWF0R	1776	2678	2178	28	28	50	140	31
	1776	2678	2178	28	28	50	140	31

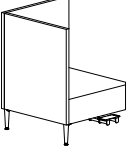
 Inline Corner Table Wall, Mid Height ZOP3-ICTWM0L ZOP3-ICTWM0R	1715	2566	2108	28	28	37	127	23
	1715	2566	2108	28	28	37	127	23

ZOLA INLINE TABLE WALLS SOLID SURFACE OVERLAY UPCHARGES

Option	Grades			
	A-White	A-Color	B	C
ZOP3-ITWF023N	483	508	632	756
ZOP3-ITWF030N	605	635	796	957
ZOP3-ITWM023N	483	508	632	756
ZOP3-ITWM030N	605	635	796	957
ZOP3-ITWF023P	483	508	632	756
ZOP3-ITWF030P	605	635	796	957
ZOP3-ITWM023P	483	508	632	756
ZOP3-ITWM030P	605	635	796	957
ZOP3-ICTWF0	607	637	801	961
ZOP3-ICTWM0	607	637	801	961

ORDERING NOTES:

The Solid Surface top option is priced as an upcharge to existing table price. Please add a "S" to the end of the model number and the upcharge listed below. Zola Solid Surface tables have a 1/2" thickness on top of the existing table, with a 1 mm overhang (soft radius vertical edge). Please see page 631 for color options.





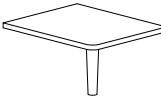

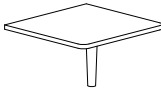



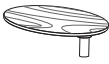
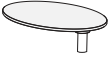

PRODUCT CODE KEY

Line	Series	Chair Type	Height	Position
ZOP	3	ICTW	F0	L
Zola	Lounge	Inline Corner Table Wall	Full Height	Left
			M0	R
			Mid Height	Right



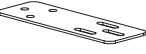
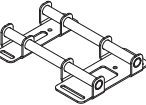

DESCRIPTION/MODEL	THERMOFUSED LAMINATE	HIGH PRESSURE LAMINATE	CHERRY MAPLE BEECH	W	D	H	WEIGHT	CUBE
 Run-off Table for 48" Inline Wall ZOL4-RO48-302416 ZOL4-RO48-372416 ZOL4-RO48-532416 ZOL4-RO48-762416	904	1279	1389	30	24	16	25	3.75
	954	1380	1455	37	24	16	30	4.5
	1066	1615	1603	53	24	16	40.5	5.75
	1231	1953	1818	76	24	16	56	7.5

 Run-off Table for 54" Inline Wall ZOL4-RO54-303016 ZOL4-RO54-373016 ZOL4-RO54-533016 ZOL4-RO54-763016	957	1252	1459	30	30	16	35	4.25
	1018	1379	1540	37	30	16	41	5.25
	1163	1671	1728	53	30	16	54	6.75
	1370	2092	1995	76	30	16	74	8.75

ZOLA | COLLECTION COMPONENTS

DESCRIPTION/MODEL	PRICE	WEIGHT	CUBE
 Wood Tablet & Mounting Plate Only ZOL3 RT1	Beech 381	5	0.32
	Maple /Cherry 405	5	0.32
 Painted Tablet & Mounting Plate Only ZOL3 RT2	n/a 278	5	0.32
 Clear Glass Tablet & Mounting Plate Only ZOL3 RT3	n/a 651	6	0.32
 Laminate Tablet & Mounting Plate Only ZOL3 RT4	n/a 397	5	0.32
 Solid Surface Tablet & Mounting Plate Only ZOL3 RT5	Grade - A-White 539		
	Grade - A-Color 547		
	Grade - B 577		
	Grade - C 624		
ORDERING NOTES: The Zola replacement tablets on this page include the top with mounting plate only.			
 Leg ZOL3 RLS	58	1	0.125
 Caster Leg ZOL3 RLC	39	0.4	0.125
 Dual leg ZOL3 RDL	100	1	0.125
 Leg Glide (4) ZOL3 RLG	24	0.2	0.01
 Replacement Seat-to-Seat Bracket ZOL3 RLKB2	95	1	0.125
NOTE: Zola Modular Seats are ordered, each seat is automatically supplied with two seat to seat brackets			
 Replacement Table-to-Seat Bracket ZOL3 RLKB1	114	3	0.125
 ZOL3-POWERDOC1 - Undermount	570	3	0.375
Can be field installed to the underside of Seats and Tables as a replacement part or installed on units not previously specified with a Powerdoc. Standard with 2 Power and 2 USB outlets. PowerDoc's have a 10' cord.			
 ZOL3-POWERDOC2	647	3	0.375
Replacement unit only for Seats, Benches or Square/Rectangular tables which were originally ordered with this power option. Standard with 2 Power and 2 USB outlets. PowerDoc's have a 10' cord.			
 Wire Manager Shroud ZOL3 WM10	120	1	0.375
ORDERING NOTES: Comes in a 10' length when ordered. Can be cut to size on site.			

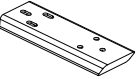
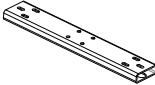
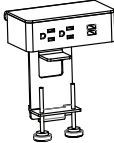
ZOLA PRIVACY | COMPONENTS

DESCRIPTION/MODEL	PRICE	WEIGHT	CUBE
 <p>Replacement Shelf Support Bracket Kit (includes 90deg bracket, curved bracket, fasteners) ZOP3-RSSB</p>	67	2	0.32
 <p>Back Alignment Hardware Kit (includes male & female bracket, fasteners) ZOP3-LKBC</p>	58	2	0.32
 <p>Privacy Screen Hardware (includes bracket, fasteners) ZOP3-RSH</p>	74	2	0.32
 <p>Back-to-Seat Linking hardware ZOP3-RLKS</p>	169	3	0.32
 <p>Twin Back-to-Seat Linking Hardware ZOP3-RLKT</p>	187	4	0.32
 <p>ZOP3-POWERDOC3 - Shelves only Replacement unit only for Shelves which were originally ordered with this power option. Standard with 2 Power and 2 USB outlets.</p>	661	3	0.375
 <p>Wire Manager for Inline Media Wall ZOL3 WM</p>	187	1	0.375

FAERON WOOD LOUNGE | ENVIRONMENTAL SUMMARY

LEED CI CREDITS



MATERIAL CONTENT:

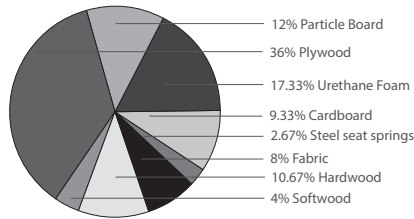

PRE-CONSUMER RECYCLED CONTENT = 12.67%

POST-CONSUMER RECYCLED CONTENT = 9.40%

Up to 18.93% of this Faeron product is recyclable at the end of its useful life.

CONTRIBUTES TO

CREDIT	CONTRIBUTES TO	POINTS
CREDIT 2.1 - 2.2	Construction Waste Management	1-2 point(s)
CREDIT 3.3	Resource Reuse	1 point
CREDIT 4.1	Recycled Content	1 point
CREDIT 4.5	Low Emitting Materials, Systems & Seating	1 point
CREDIT 5.1	Regional Materials*	1 point
CREDIT 7	Certified Wood (MUST BE REQUESTED)	1 point(s)

*This credit is only applicable if in total 20% of the combined value of the procurement of construction materials and in the furniture are manufactured within a radius of 500 miles. This credit will apply if the installation of the finished product occurs within 500 miles of Kitchener, Ontario.

level® CERTIFICATION, AIR EMISSIONS AND FSC® CERTIFICATION



level® CERTIFICATION

BIFMA's e3 Furniture Sustainability Standard is a voluntary, multi-attribute standard that measures the degree of sustainability of furniture. This standard evaluates product and company environmental attributes and compliance systems in a wide range of elements which include Materials, Energy & Atmosphere, Human & Ecosystem Health and Social Responsibility. Faeron products have earned level®, BIFMA's sustainability certification program for furniture, certification through third-party verification against the e3 standard.

AIR-EMISSIONS

All Faeron products are supplied with air-emissions certified. Contact customer service for information.



FSC®

In 2005, Krug received Forest Stewardship Council® (FSC®) Chain-of-Custody certification for our manufacturing facilities. The FSC® Chain-of-Custody tracks certified wood from seedling to final sale. It verifies that the material for our FSC® certified products only come from well-managed, FSC®-certified forests and other controlled sources. FSC® is dedicated to the promotion of responsible forest management worldwide helping to take care of forests for future generations. Faeron and other Krug products can be specified with FSC® Certification. Contact customer service for further information, pricing and lead times.



Architects, designers, and building professionals can specify FSC®-certified products in order to achieve a point from the U.S. Green Building Council's Leadership in Energy and Environmental Design (LEED) Rating System.

FAERON WOOD LOUNGE | DIMENSIONS & COM

DIMENSIONS & COM REQUIREMENTS

	Overall Width	Overall Depth	Overall Height	Seat Height	Height of Arms from Floor	Width Between Arms	Seat Depth	Shipping Weight	Cube	COM Yardage Entire Unit	COM Yardage Seat Only	COM Yardage Back Only	COM Yardage Arm Only
One-Seat - wood arm													
lounge	27	28.5	31.5	17.8	24	23	21	55	20	4.2	1.3	1.7	1.2
high back	27	28.5	41.5	17.8	24	23	21	59	24	4.8	1.3	2.3	1.2
One-Seat - armless													
lounge	23	28.5	31.5	17.8	-	-	21	52	20	3	1.3	1.7	-
high back	23	28.5	41.5	17.8	-	-	21	55	24	3.6	1.3	2.3	-
One-Seat - upholstered arm													
lounge	28	28.5	31.5	17.8	24	23	21	75	20	5.9	1.3	1.7	2.9
high back	28	28.5	41.5	17.8	24	23	21	79	24	6.5	1.3	2.3	2.9
wingback	32	28.5	42.5	17.8	24	23	21	84	27	7.5	1.3	3.3	2.9
One-Seat wide - wood arm													
lounge	34	28.5	31.5	17.8	24	30	21	64	23	4.4	1.5	1.7	1.2
high back	34	28.5	41.5	17.8	24	30	21	68	27	5	1.5	2.3	1.2
One-Seat wide - armless													
lounge	30	28.5	31.5	17.8	-	-	21	61	23	3.2	1.5	1.7	-
high back	30	28.5	41.5	17.8	-	-	21	65	27	3.8	1.5	2.3	-
One-Seat wide - upholstered arm													
lounge	35	28.5	31.5	17.8	24	30	21	84	23	6.1	1.5	1.7	2.9
high back	35	28.5	41.5	17.8	24	30	21	88	27	6.7	1.5	2.3	2.9
wingback	39	28.5	42.5	17.8	24	30	21	93	30	7.5	1.3	3.3	2.9
Two-seat - wood arm													
lounge	50	28.5	31.5	17.8	24	46	21	88	36	5.5	1.7	2.6	1.2
high back	50	28.5	41.5	17.8	24	46	21	95	43	6.4	1.7	3.5	1.2
Two-seat - armless													
lounge	46	28.5	31.5	17.8	-	-	21	87	36	4.3	1.7	2.6	-
high back	46	28.5	41.5	17.8	-	-	21	94	43	5.2	1.7	3.5	-
Two-seat - upholstered arm													
lounge	51	28.5	31.5	17.8	24	46	21	108	36	7.2	1.7	2.6	2.9
high back	51	28.5	41.5	17.8	24	46	21	115	43	8.1	1.7	3.5	2.9
wingback	55	28.5	42.5	17.8	24	46	21	120	46	9.1	1.7	4.5	2.9
Three-seat - wood arm													
lounge	73	28.5	31.5	17.8	24	69	21	120	52	7.1	2.5	3.4	1.2
high back	73	28.5	41.5	17.8	24	69	21	130	61	8.4	2.5	4.7	1.2
Three-seat - armless													
lounge	69	28.5	31.5	17.8	-	-	21	122	52	5.9	2.5	3.4	-
high back	69	28.5	41.5	17.8	-	-	21	132	61	7.2	2.5	4.7	-
Three-seat - upholstered arm													
lounge	74	28.5	31.5	17.8	24	69	21	140	52	8.8	2.5	3.4	2.9
high back	74	28.5	41.5	17.8	24	69	21	150	61	10.1	2.5	4.7	2.9
wingback	78	28.5	42.5	17.8	24	69	21	155	64	10.3	1.7	5.7	2.9

ORDERING NOTES:

CONTRASTING BACKS, SEATS & CLOSED ARMS

Combination upholstery (more than one upholstery cover within the same unit) is an option on all Faeron upholstered products. When combination upholstery is with upholstery of the same grade or COM, an upcharge for dual fabrics is **\$33 list** per unit and **\$64 list** per unit for three fabrics. When graded in combination upholstery is selected, use the highest grade upholstery selected or contact Customer Service for a quote -please provide the fabrics specified and a description of where each fabric is to be applied on the product in order to obtain a quote. Note: Some vinyls, leathers & upholsteries are not suitable for application on Faeron seating. Please refer to page 628 for C.O.M approval process.

WEIGHT CAPACITIES

Faeron weight capacities are as follows:

- One -Seat - 500 lbs
- One -Seat - Plus - 750 lbs
- One-Seat Wide - 500 lbs
- One-Seat Wide Plus - 750 lbs
- Two- Seat - 625 lbs
- Two- Seat Plus- 975 lbs
- Three - Seat - 850 lbs
- Three - Seat Plus- 1200 lbs

Faeron Option Upcharges

	\$ List		\$ List
CAL 133 & Moisture Barrier (per yard)	64	Solid Surface Arm Cap (per pair) - Gr A White	384
One-Seat Removable Back Covers	152	Solid Surface Arm Cap (per pair) - Gr A Color	397
One-Seat Wide Removable Back Covers	228	Solid Surface Arm Cap (per pair) - Gr B	422
Two-Seat Removable Back Covers	302	Solid Surface Arm Cap (per pair) - Gr C	435
Three-Seat Removable Back Covers	453	Solid Surface Arm (per pair) - Gr A White	677
One-Seat Removable Seat Covers	152	Solid Surface Arm (per pair) - Gr A Color	708
One-Seat Wide Removable Seat Covers	228	Solid Surface Arm (per pair) - Gr B	768
Two-Seat Removable Seat Covers	302	Solid Surface Arm (per pair) - Gr C	810
Three-Seat Removable Seat Covers	453	Urethane Arm Cap (per pair)	152
		Upholstered Lounge Wood Arm Cap (per pair)	193

FAERON WOOD | LOUNGE FEATURES & OPTIONS



WOOD ARM

Faeron Wood Arm Lounge chairs are available with optional Arm Caps in Urethane and Solid Surface. As well as a Solid Surface Arm.



ARMLESS

Faeron Armless Lounge seating can be specified with a full wood base providing an enhanced base profile.



UPHOLSTERED ARM

Faeron Upholstered arm lounge chairs are available with optional arm caps in Wood, Solid Surface and Urethane (Wingback lounge is not available with Urethane cap).



ARM PANEL

Arm Panels are available on Faeron Wood Arm Lounge seating in semi and fully closed styles for optimum design flexibility.



BEECH WOOD LEGS

Faeron Lounge legs and bases are solid Beech available in 22 finish selections.



METAL LEGS

Faeron Upholstered Arm models are also available with Metal Legs; Silver Metallic or Brushed Nickel finish.



LOUNGE WALL SAVER

Faeron Lounge models include a wall saver feature in which the angle of the back and the rear legs are designed to keep the back away from the wall, to prevent wear and damage to both the chair and the wall. Not included for Faeron High Back Lounge or Faeron Wingback Lounge due to back height.



CLEAN OUT

All Faeron Lounge seating has a built-in clean out feature: a space at the back of the seat that allows dirt, debris and liquid to fall to the floor for easy clean up and maintenance - designed so that it does not detract from the comfort or appearance of the product.

[Faeron Lounge Images | www.krug.ca](http://www.krug.ca)

OPTIONS

URETHANE ARM CAP

The optional Urethane Arm Cap is available on Wood Arm Lounge and Upholstered Arm Lounge and provides enhanced durability and protection for the arms. This is field replaceable if this becomes damaged or degraded and is available in three colors; Black, Grey and Taupe.



WOOD ARM CAP

The optional Solid Beech Arm Cap is available on Upholstered Arm and Wingback Lounge. This is field replaceable if this becomes damaged or degraded.



SOLID SURFACE ARM CAP

The optional Solid Surface Arm Cap is available on Wood Arm Lounge and Upholstered Arm Lounge and provides enhanced durability, protection and cleanability for the arms. This is field replaceable if this becomes damaged or degraded and is available in 8 standard colors.



SOLID SURFACE ARM

The optional Solid Surface Arm is available on Wood Arm Lounge and provides a fully seamless armrest for enhanced durability, protection and cleanability. It is available in 8 standard colors and replaceable as a full side frame if it becomes damaged or degraded.



COMBINATION UPHOLSTERY OPTIONS

When combination upholstery is specified with fabric of the same grade or COM, an upcharge for dual fabrics is **\$33 list** per unit and **\$64 list** per unit for three fabrics will be applied. When graded in combination upholstery is selected, use the highest grade upholstery selected or to obtain a quote for blended grading contact Customer Service (please provide the fabrics specified and location of where each fabric is to be applied on the product).







MOISTURE BARRIER & CAL 133

California Technical Bulletin 133 is a flammability test for seating. Krug offers a compliance method, in combination with non-flammable upholstery covers, that may enable products to meet certification requirements for this test. This process at the same time also provides the products with a Moisture Barrier - a treatment that helps to prevent the passage of liquids and moisture to inside of the upholstered components - thereby conferring sanitary and anti-infection benefits. So when CAL133 is specified, the product also automatically has a Moisture Barrier, and when a Moisture Barrier is specified, the product also features the compliance method and low flammability features of CAL 133. The application of this up-charge and the compliance method does not mean that the specific configuration of product and upholstery cover are tested and officially certified as being CAL133 compliant. If the official certification is required, Krug will provide this (through an independent certified testing laboratory) at a charge of \$917 per item, plus the cost of the product to be tested. Lead time for certification testing is typically 4-8 weeks.

REMOVABLE AND REPLACEABLE COVERS

Faeron Lounge Chairs are available with a Removable Seat & Back Covers. See page 290 for upcharges.



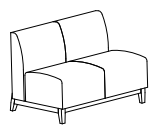
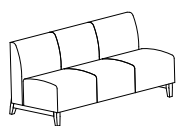
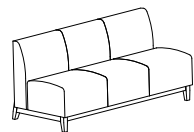



FAERON WOOD | ARMLESS LOUNGE

DESCRIPTION/MODEL	Species	COM		COL		FABRIC GRADES			LEATHER			
		1	2	3	4	5	6	7	8	9		
	One-Seat, Armless Lounge, Standard Base	FAE3-AL1S	Beech	2020	2103	2180	2339	2496	2656	2815	2971	3290
	One-Seat Plus Armless Lounge, Standard Base	FAE3-ALB1S	Beech	2096	2176	2255	2413	2571	2732	2890	3048	3366
	One-Seat, Armless Lounge, Full Wood Base	FAE3-AL1F	Beech	2186	2264	2343	2502	2659	2818	2977	3135	3453
	One-Seat Plus, Armless Lounge, Full Wood Base	FAE3-ALB1F	Beech	2261	2340	2419	2577	2736	2893	3053	3210	3529
	One-Seat Wide, Armless Lounge, Standard Base	FAE3-AL1+S	Beech	2283	2391	2502	2716	2932	3145	3363	3578	4008
	One-Seat Wide Plus, Armless Lounge, Standard Base	FAE3-ALB1+S	Beech	2367	2474	2583	2797	3013	3229	3444	3661	4089
	One-Seat Wide, Armless Lounge, Full Wood Base	FAE3-AL1+F	Beech	2493	2602	2712	2926	3140	3356	3573	3787	4217
	One-Seat Wide Plus, Armless Lounge, Full Wood Base	FAE3-ALB1+F	Beech	2577	2684	2791	3008	3222	3437	3654	3870	4297
	Two-Seat, Armless Lounge, Standard Base	FAE3-AL2S	Beech	2863	2984	3102	3340	3578	3815	4053	4290	4765
	Two-Seat Plus, Armless Lounge, Standard Base	FAE3-ALB2S	Beech	2982	3099	3217	3455	3692	3931	4169	4405	4882
	Two-Seat, Armless Lounge, Full Wood Base	FAE3-AL2F	Beech	3159	3278	3397	3634	3872	4110	4348	4586	5061
	Two-Seat Plus, Armless Lounge, Full Wood Base	FAE3-ALB2F	Beech	3273	3395	3513	3748	3987	4224	4462	4702	5176
	Three-Seat, Armless Lounge, Standard Base	FAE3-AL3S	Beech	3796	3984	4176	4557	4937	5317	5696	6078	6837
	Three-Seat Plus, Armless Lounge, Standard Base	FAE3-ALB3S	Beech	3988	4180	4370	4750	5131	5510	5891	6271	7031
	Three-Seat, Armless Lounge, Full Wood Base	FAE3-AL3F	Beech	4184	4373	4564	4945	5324	5705	6083	6465	7227
	Three-Seat Plus, Armless Lounge, Full Wood Base	FAE3-ALB3F	Beech	4378	4567	4758	5139	5519	5898	6280	6660	7420

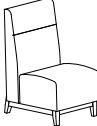
PRODUCT CODE KEY

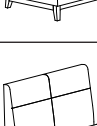
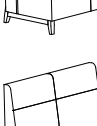
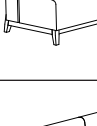
Line	Series	Chair Type	Size		Base
FAE Faeron	3-A Lounge Seating	L Lounge	1 One-Seat	B1 One-Seat Plus	S Standard Base
		H High Back Lounge	1+ One-Seat Wide	B1+ One-Seat Wide Plus	F Full Wood Base
			2 Two-Seat	B2 Two-Seat Plus	
			3 Three-Seat	B3 Three-Seat Plus	

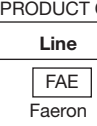

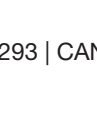



FAERON WOOD | ARMLESS HIGH BACK LOUNGE

DESCRIPTION/MODEL	Species	COM		COL		FABRIC GRADES			LEATHER	
		1	2	3	4	5	6	7	8	9
 One-Seat, Armless High back Lounge, Standard Base FAE3-AH1S	Beech	2271	2368	2464	2658	2852	3045	3239	3432	3819
 One-Seat Plus, Armless High back Lounge, Standard Base FAE3-AHB1S	Beech	2346	2444	2541	2735	2928	3120	3315	3509	3895
 One-Seat, Armless High back Lounge, Full Wood Base FAE3-AH1F	Beech	2434	2531	2629	2822	3014	3209	3403	3596	3983
 One-Seat Plus, Armless High back Lounge, Full Wood Base FAE3-AHB1F	Beech	2510	2608	2703	2898	3091	3286	3478	3671	4060
 One-Seat Wide, Armless High back Lounge, Standard Base FAE3-AH1+S	Beech	2552	2678	2803	3054	3304	3555	3806	4057	4558
 One-Seat Wide Plus, Armless High back Lounge, Standard Base FAE3-AHB1+S	Beech	2635	2761	2884	3135	3385	3636	3888	4139	4639
 One-Seat Wide, Armless High back Lounge, Full Wood Base FAE3-AH1+F	Beech	2762	2886	3012	3264	3514	3765	4015	4266	4767
 One-Seat Wide Plus, Armless High back Lounge, Full Wood Base FAE3-AHB1+F	Beech	2845	2969	3095	3344	3595	3846	4097	4348	4847
 Two-Seat, Armless High back Lounge, Standard Base FAE3-AH2S	Beech	3052	3187	3323	3596	3870	4142	4416	4686	5233
 Two-Seat Plus, Armless High back Lounge, Standard Base FAE3-AHB2S	Beech	3165	3303	3439	3712	3984	4259	4531	4802	5347
 Two-Seat, Armless High back Lounge, Full Wood Base FAE3-AH2F	Beech	3345	3483	3619	3892	4164	4437	4709	4981	5528
 Two-Seat Plus, Armless High back Lounge, Full Wood Base FAE3-AHB2F	Beech	3461	3598	3735	4007	4281	4554	4826	5097	5642
Three-Seat, Armless High back Lounge, Standard Base FAE3-AH3S	Beech	4055	4281	4505	4956	5407	5857	6308	6759	7659
Three-Seat Plus, Armless High back Lounge, Standard Base FAE3-AHB3S	Beech	4248	4474	4698	5150	5602	6052	6501	6954	7855
Three-Seat, Armless High back Lounge, Full Wood Base FAE3-AH3F	Beech	4443	4667	4893	5344	5794	6245	6696	7147	8046
Three-Seat Plus, Armless High back Lounge, Full Wood Base FAE3-AHB3F	Beech	4637	4862	5087	5538	5990	6439	6889	7340	8240

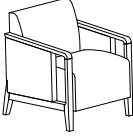
PRODUCT CODE KEY

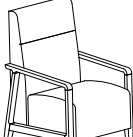
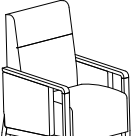
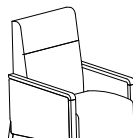
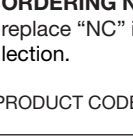
Line	Series	Chair Type	Size		Base
FAE Faeron	3-A Armless Lounge Seating	L Lounge	1 One-Seat	B1 One-Seat Plus	S Standard Base
		H High Back Lounge	1+ One-Seat Wide	B1+ One-Seat Wide Plus	F Full Wood Base
			2 Two-Seat	B2 Two-Seat Plus	
			3 Three-Seat	B3 Three-Seat Plus	

FAERON WOOD | LOUNGE & HIGH BACK LOUNGE

DESCRIPTION/MODEL	Species	COM		COL		FABRIC GRADES			LEATHER		
		1	2	3	4	5	6	7	8	9	
	One-Seat, Wood Arm Lounge, Open Arm										
	FAE3-WL1ONC Beech	2134	2214	2294	2451	2610	2768	2927	3084	3403	
	One-Seat Plus, Wood Arm Lounge, Open Arm										
	FAE3-WL1BONC Beech	2211	2291	2368	2527	2685	2845	3003	3161	3478	
	One-Seat Wood Arm Lounge, Semi Closed Arm										
	FAE3-WL1SNC Beech	2724	2844	2959	3193	3429	3663	3896	4131	4600	
	One-Seat Plus Wood Arm Lounge, Semi Closed Arm										
	FAE3-WL1BSNC Beech	2802	2919	3036	3269	3505	3739	3974	4207	4677	
	One-Seat Wood Arm Lounge, Closed Arm										
	FAE3-WL1CNC Beech	2746	2864	2983	3216	3452	3685	3919	4154	4623	
	One-Seat Plus Wood Arm Lounge, Closed Arm										
	FAE3-WL1BCNC Beech	2823	2940	3057	3292	3528	3761	3995	4230	4698	
	One-Seat Wood Arm High Back Lounge, Open Arm										
	FAE3-WH1ONC Beech	2385	2481	2579	2772	2965	3160	3353	3546	3934	
	One-Seat Plus Wood Arm High Back Lounge, Open Arm										
	FAE3-WH1BONC Beech	2461	2557	2655	2848	3040	3236	3429	3622	4009	
	One-Seat Wood Arm High Back Lounge, Semi Closed Arm										
	FAE3-WH1SNC Beech	2973	3111	3244	3514	3785	4053	4322	4592	5132	
	One-Seat Plus Wood Arm High Back Lounge, Semi Closed Arm										
	FAE3-WH1BSNC Beech	3052	3186	3320	3589	3859	4129	4398	4668	5209	
	One-Seat Wood Arm High Back Lounge, Closed Arm										
	FAE3-WH1CNC Beech	2996	3133	3266	3536	3806	4074	4345	4615	5154	
	One-Seat Plus Wood Arm High Back Lounge, Closed Arm										
	FAE3-WH1BCNC Beech	3073	3208	3342	3610	3881	4152	4421	4691	5231	

ORDERING NOTES: Faeron chairs can be specified with Urethane Arm Caps (UC), Solid Surface Arm Caps (SC) or Solid Surface Arm (SA), replace "NC" in the model number with the **Arm Style** selection below and add the upcharge listed on page 290. See page 631 for color selection.

PRODUCT CODE KEY

Line	Series	Chair Type	Size	Arm Style	Arm Cap	
FAE Faeron	3-W Wood Arm Lounge Seating	L Lounge	1 One-Seat	B1 One-Seat Plus	O Open Arm	NC No Cap
		H High Back Lounge	1+ One-Seat Wide	B1+ One-Seat Wide Plus	S Semi Closed Arm	UC Urethane Cap
			2 Two-Seat	B2 Two-Seat Plus	C Closed Arm	SC Solid Surface Cap
			3 Three-Seat	B3 Three-Seat Plus		SA Solid Surface Arm

FAERON WOOD | LOUNGE & HIGH BACK LOUNGE

DESCRIPTION/MODEL	Species	COM		COL		FABRIC GRADES			LEATHER		
		1	2	3	4	5	6	7	8	9	
	One-Seat Wide Wood Arm Lounge, Open Wood Arm FAE3-WL1+ONC	Beech	2345	2452	2560	2774	2991	3207	3423	3638	4067
	One-Seat Wide Plus Wood Arm Lounge, Open Arm FAE3-WLB1+ONC	Beech	2427	2533	2640	2858	3073	3289	3505	3718	4152
	One-Seat Wide Wood Arm Lounge, Semi Closed Arm FAE3-WL1+SNC	Beech	2935	3081	3224	3517	3810	4102	4393	4684	5267
	One-Seat Wide Plus Wood Arm Lounge, Semi Closed Arm FAE3-WLB1+SNC	Beech	3015	3162	3308	3599	3892	4183	4474	4765	5347
	One-Seat Wide Wood Arm Lounge, Closed Arm FAE3-WL1+CNC	Beech	2957	3103	3247	3539	3830	4124	4415	4707	5288
	One-Seat Wide Plus Wood Arm Lounge, Closed Arm FAE3-WLB1+CNC	Beech	3038	3185	3330	3621	3914	4205	4498	4788	5369
	One-Seat Wide Wood Arm High Back Lounge, Open Arm FAE3-WH1+ONC	Beech	2612	2739	2863	3114	3364	3614	3866	4116	4617
	One-Seat Wide Plus Wood Arm High Back Lounge, Open Arm FAE3-WHB1+ONC	Beech	2694	2819	2944	3194	3446	3697	3949	4197	4698
	One-Seat Wide Wood Arm High Back Lounge, Semi Closed Arm FAE3-WH1+SNC	Beech	3203	3366	3530	3855	4183	4509	4837	5162	5814
	One-Seat Wide Plus Wood Arm High Back Lounge, Semi Closed Arm FAE3-WHB1+SNC	Beech	3285	3448	3609	3936	4264	4590	4918	5243	5897
	One-Seat Wide Wood Arm High Back Lounge, Closed Arm FAE3-WH1+CNC	Beech	3223	3386	3552	3877	4205	4531	4859	5185	5838
	One-Seat Wide Plus Wood Arm High Back Lounge, Closed Arm FAE3-WHB1+CNC	Beech	3305	3470	3633	3959	4287	4613	4942	5267	5919

ORDERING NOTES: Faeron chairs can be specified with Urethane Arm Caps (UC), Solid Surface Arm Caps (SC) or Solid Surface Arm (SA), replace "NC" in the model number with the **Arm Style** selection below and add the upcharge listed on page 290. See page 631 for color selection.

PRODUCT CODE KEY

Line	Series	Chair Type	Size	Arm Style	Arm Cap	
FAE Faeron	3-W Wood Arm Lounge Seating	L Lounge	1 One-Seat	B1 One-Seat Plus	O Open Arm	NC No Cap
		H High Back Lounge	1+ One-Seat Wide	B1+ One-Seat Wide Plus	S Semi Closed Arm	UC Urethane Cap
			2 Two-Seat	B2 Two-Seat Plus	C Closed Arm	SC Solid Surface Cap
			3 Three-Seat	B3 Three-Seat Plus		SA Solid Surface Arm

FAERON WOOD | LOUNGE & HIGH BACK LOUNGE

DESCRIPTION/MODEL	Species	COM		COL			FABRIC GRADES			LEATHER	
		1	2	3	4	5	6	7	8	9	
	Two-Seat Wood Arm Lounge, Open Arm										
	FAE3-WL2ONC Beech	2955	3073	3190	3430	3666	3906	4142	4379	4856	
	Two-Seat Plus Wood Arm Lounge, Open Arm										
	FAE3-WLB2ONC Beech	3042	3161	3280	3517	3757	3994	4231	4469	4945	
	Two-Seat Wood Arm Lounge, Semi Closed Arm										
	FAE3-WL2SNC Beech	3543	3701	3858	4171	4485	4798	5112	5425	6054	
	Two-Seat Plus Wood Arm Lounge, Semi Closed Arm										
	FAE3-WLB2SNC Beech	3633	3789	3948	4261	4573	4888	5201	5516	6141	
	Two-Seat Wood Arm Lounge, Closed Arm										
	FAE3-WL2CNC Beech	3565	3723	3880	4193	4507	4819	5135	5449	6077	
	Two-Seat Plus Wood Arm Lounge, Closed Arm										
	FAE3-WLB2CNC Beech	3655	3812	3969	4284	4595	4911	5221	5537	6164	
	Two-Seat Wood Arm High Back Lounge, Open arm										
	FAE3-WH2ONC Beech	3140	3277	3412	3686	3959	4233	4505	4778	5323	
	Two-Seat Plus Wood Arm High back Lounge, Open arm										
	FAE3-WHB2ONC Beech	3231	3367	3501	3773	4047	4319	4592	4866	5412	
	Two-Seat Wood Arm High Back Lounge, Semi Closed Arm										
	FAE3-WH2SNC Beech	3731	3906	4080	4427	4778	5127	5474	5824	6521	
	Two-Seat Plus Wood Arm High Back Lounge, Semi Closed Arm										
	FAE3-WHB2SNC Beech	3819	3994	4169	4517	4866	5215	5562	5913	6610	
	Two-Seat Wood Arm High Back Lounge, Closed Arm										
	FAE3-WH2CNC Beech	3753	3929	4102	4452	4799	5149	5497	5846	6543	
	Two-Seat Plus Wood Arm High Back Lounge, Closed Arm										
	FAE3-WHB2CNC Beech	3843	4015	4190	4539	4888	5236	5586	5935	6632	

ORDERING NOTES: Faeron chairs can be specified with Urethane Arm Caps (UC), Solid Surface Arm Caps (SC) or Solid Surface Arm (SA), replace "NC" in the model number with the **Arm Style** selection below and add the upcharge listed on page 290. See page 631 for color selection.

PRODUCT CODE KEY

Line	Series	Chair Type	Size	Arm Style	Arm Cap	
FAE Faeron	3-W Wood Arm Lounge Seating	L Lounge	1 One-Seat	B1 One-Seat Plus	O Open Arm	NC No Cap
		H High Back Lounge	1+ One-Seat Wide	B1+ One-Seat Wide Plus	S Semi Closed Arm	UC Urethane Cap
			2 Two-Seat	B2 Two-Seat Plus	C Closed Arm	SC Solid Surface Cap
			3 Three-Seat	B3 Three-Seat Plus		SA Solid Surface Arm

FAERON WOOD | LOUNGE & HIGH BACK LOUNGE

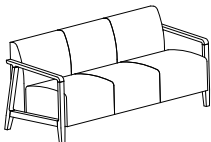
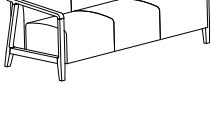
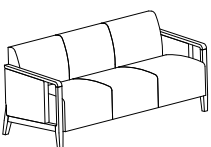
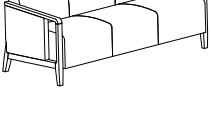
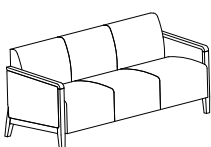
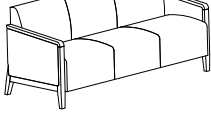
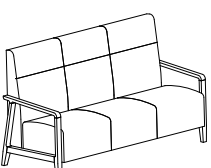
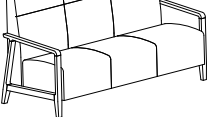
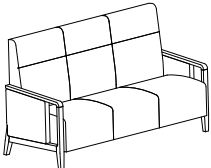
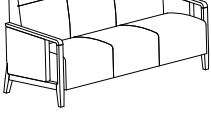
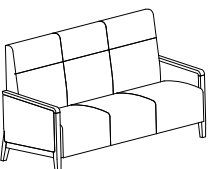
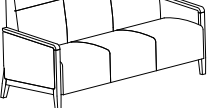
DESCRIPTION/MODEL	Species	COM		COL		FABRIC GRADES			LEATHER	
		1	2	3	4	5	6	7	8	9
	Three-Seat Wood Arm Lounge, Open Arm									
	FAE3-WL3ONC Beech	3797	3985	4177	4558	4939	5318	5698	6079	6839
	Three-Seat Plus Wood Arm Lounge, Open Arm									
	FAE3-WLB3ONC Beech	3953	4142	4334	4712	5093	5472	5853	6233	6995
	Three-Seat Wood Arm Lounge, Semi Closed Arm									
	FAE3-WL3SNC Beech	4389	4615	4843	5300	5757	6212	6668	7125	8038
	Three-Seat Plus Wood Arm Lounge, Semi Closed Arm									
	FAE3-WLB3SNC Beech	4542	4771	4998	5454	5912	6366	6822	7281	8193
	Three-Seat Wood Arm Lounge, Closed Arm									
	FAE3-WL3CNC Beech	4410	4637	4866	5322	5780	6235	6690	7148	8059
	Three-Seat Plus Wood Arm Lounge, Closed Arm									
	FAE3-WLB3CNC Beech	4564	4793	5021	5477	5933	6389	6846	7302	8213
	Three-Seat Wood Arm High Back Lounge, Open Arm									
	FAE3-WH3ONC Beech	4057	4282	4506	4957	5408	5859	6310	6760	7660
	Three-Seat Plus Wood Arm High Back Lounge, Open Arm									
	FAE3-WHB3ONC Beech	4212	4436	4663	5111	5561	6014	6464	6914	7816
	Three-Seat Wood Arm High Back Lounge, Semi Closed Arm									
	FAE3-WH3SNC Beech	4645	4908	5171	5698	6227	6753	7281	7807	8859
	Three-Seat Plus Wood Arm High Back Lounge, Semi Closed Arm									
	FAE3-WHB3SNC Beech	4801	5064	5328	5854	6381	6909	7435	7961	9014
	Three-Seat Wood Arm High Back Lounge, Closed Arm									
	FAE3-WH3CNC Beech	4667	4930	5194	5721	6247	6775	7302	7829	8881
	Three-Seat Plus Wood Arm High Back Lounge, Closed Arm									
	FAE3-WHB3CNC Beech	4822	5086	5349	5876	6403	6930	7457	7984	9037

ORDERING NOTES: Faeron chairs can be specified with Urethane Arm Caps (UC), Solid Surface Arm Caps (SC) or Solid Surface Arm (SA), replace "NC" in the model number with the **Arm Style** selection below and add the upcharge listed on page 290. See page 631 for color selection.

PRODUCT CODE KEY

Line	Series	Chair Type	Size	Arm Style	Arm Cap	
FAE Faeron	3-W Wood Arm Lounge Seating	L Lounge	1 One-Seat	B1 One-Seat Plus	O Open Arm	NC No Cap
		H High Back Lounge	1+ One-Seat Wide	B1+ One-Seat Wide Plus	S Semi Closed Arm	UC Urethane Cap
			2 Two-Seat	B2 Two-Seat Plus	C Closed Arm	SC Solid Surface Cap
			3 Three-Seat	B3 Three-Seat Plus		SA Solid Surface Arm

FAERON METAL LOUNGE | ENVIRONMENTAL SUMMARY

LEED CI CREDITS



MATERIAL CONTENT:

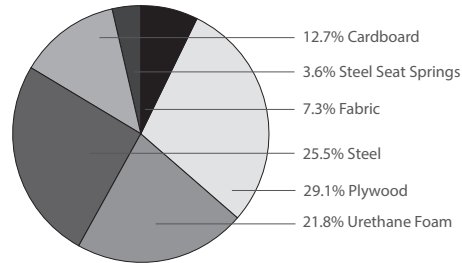

PRE-CONSUMER
RECYCLED CONTENT = 7.27%

POST-CONSUMER
RECYCLED CONTENT = 17.97%

Up to 38.18% of this Faeron product is recyclable at the end of its useful life.

CONTRIBUTES TO

CREDIT 2.1 - 2.2	Construction Waste Management	1-2 point(s)
CREDIT 3.3	Resource Reuse	1 point
CREDIT 4.1	Recycled Content	1 point
CREDIT 4.2	Recycled Content	1 point
CREDIT 4.5	Low Emitting Materials, Systems & Seating	1 point
CREDIT 5.1	Regional Materials*	1 point
CREDIT 7	Certified Wood (MUST BE REQUESTED)	1 point(s)

*This credit is only applicable if in total 20% of the combined value of the procurement of construction materials and in the furniture are manufactured within a radius of 500 miles. This credit will apply if the installation of the finished product occurs within 500 miles of Kitchener, Ontario.

level® CERTIFICATION, AIR EMISSIONS AND FSC® CERTIFICATION



level® CERTIFICATION

BIFMA's e3 Furniture Sustainability Standard is a voluntary, multi-attribute standard that measures the degree of sustainability of furniture. This standard evaluates product and company environmental attributes and compliance systems in a wide range of elements which include Materials, Energy & Atmosphere, Human & Ecosystem Health and Social Responsibility. Faeron products have earned level®, BIFMA's sustainability certification program for furniture, certification through third-party verification against the e3 standard.

AIR-EMISSIONS

All Faeron products are supplied with air-emissions certified. Contact customer service for information.



FSC®

In 2005, Krug received Forest Stewardship Council® (FSC®) Chain-of-Custody certification for our manufacturing facilities. The FSC® Chain-of-Custody tracks certified wood from seedling to final sale. It verifies that the material for our FSC® certified products only come from well-managed, FSC®-certified forests and other controlled sources. FSC® is dedicated to the promotion of responsible forest management worldwide helping to take care of forests for future generations. Faeron and other Krug products can be specified with FSC® Certification. Contact customer service for further information, pricing and lead times.



Architects, designers, and building professionals can specify FSC®-certified products in order to achieve a point from the U.S. Green Building Council's Leadership in Energy and Environmental Design (LEED) Rating System.

FAERON METAL | DIMENSIONS & COM

DIMENSIONS & COM REQUIREMENTS

	Overall Width	Overall Depth	Overall Height	Seat Height	Height of Arms from Floor	Width Between Arms	Seat Depth	Shipping Weight	Cube	COM Yardage Entire Unit	COM Yardage Seat Only	COM Yardage Back Only	COM Yardage Arm Only
One-seat - metal arm													
lounge	27	28.5	31.5	17.8	24	23	21	67	20	4.2	1.3	1.7	1.2
high back	27	28.5	41.5	17.8	24	23	21	71	24	4.8	1.3	2.3	1.2
One-seat - armless													
lounge	23	28.5	31.5	17.8	-	-	21	52	20	3	1.3	1.7	-
high back	23	28.5	41.5	17.8	-	-	21	55	24	3.6	1.3	2.3	-
One-seat - upholstered arm													
lounge	28	28.5	31.5	17.8	24	23	21	75	20	5.9	1.3	1.7	2.9
high back	28	28.5	41.5	17.8	24	23	21	79	24	6.5	1.3	2.3	2.9
wingback	32	28.5	42.5	17.8	24	23	21	84	27	7.5	1.3	3.3	2.9
One-seat wide - metal arm													
lounge	34	28.5	31.5	17.8	24	30	21	66	23	4.4	1.5	1.7	1.2
high back	34	28.5	41.5	17.8	24	30	21	80	27	5	1.5	2.3	1.2
One-seat wide - armless													
lounge	30	28.5	31.5	17.8	-	-	21	61	23	3.2	1.5	1.7	-
high back	30	28.5	41.5	17.8	-	-	21	65	27	3.8	1.5	2.3	-
One-seat wide - upholstered arm													
lounge	35	28.5	31.5	17.8	24	30	21	84	23	6.1	1.5	1.7	2.9
high back	35	28.5	41.5	17.8	24	30	21	88	27	6.7	1.5	2.3	2.9
wingback	39	28.5	42.5	17.8	24	30	21	93	30	7.5	1.3	3.3	2.9
Two-seat - metal arm													
lounge	50	28.5	31.5	17.8	24	46	21	100	36	5.5	1.7	2.6	1.2
high back	50	28.5	41.5	17.8	24	46	21	107	43	6.4	1.7	3.5	1.2
Two-seat - armless													
lounge	46	28.5	31.5	17.8	-	-	21	87	36	4.3	1.7	2.6	-
high back	46	28.5	41.5	17.8	-	-	21	94	43	5.2	1.7	3.5	-
Two-seat - upholstered arm													
lounge	51	28.5	31.5	17.8	24	46	21	108	36	7.2	1.7	2.6	2.9
high back	51	28.5	41.5	17.8	24	46	21	115	43	8.1	1.7	3.5	2.9
wingback	55	28.5	42.5	17.8	24	46	21	120	46	9.1	1.7	4.5	2.9
Three-seat - metal arm													
lounge	73	28.5	31.5	17.8	24	69	21	142	52	7.1	2.5	3.4	1.2
high back	73	28.5	41.5	17.8	24	69	21	149	61	8.4	2.5	4.7	1.2
Three-seat - armless													
lounge	69	28.5	31.5	17.8	-	-	21	122	52	5.9	2.5	3.4	-
high back	69	28.5	41.5	17.8	-	-	21	129	61	7.2	2.5	4.7	-
Three-seat - upholstered arm													
lounge	74	28.5	31.5	17.8	24	69	21	140	52	8.8	2.5	3.4	2.9
high back	74	28.5	41.5	17.8	24	69	21	147	61	10.1	2.5	4.7	2.9
wingback	78	28.5	42.5	17.8	24	69	21	145	64	10.3	1.7	5.7	2.9

ORDERING NOTES:

Faeron seating. Please refer to page 628 for C.O.M approval process.

WEIGHT CAPACITIES

Faeron weight capacities are as follows:

- One -Seat - 500 lbs
- One -Seat - Plus - 750 lbs
- One-seat Wide - 500 lbs
- One-seat Wide Plus - 750 lbs
- Two- Seat - 625 lbs
- Two- Seat Plus- 975 lbs
- Three - Seat - 850 lbs
- Three - Seat Plus- 1200 lbs

Faeron Option Upcharges

	\$ List		\$ List
CAL 133 & Moisture Barrier (per yard)	64	Beech Wood Arm (per pair)	126
One-Seat Removable Back Cover (per back)	152	Solid Surface Arm (per pair) - Gr A White	677
One-Seat wide Removable Back Cover (per back)	228	Solid Surface Arm (per pair) - Gr A Color	708
Two-Seat Removable Back Cover (per back)	302	Solid Surface Arm (per pair) - Gr B	768
Three-Seat Removable Back Cover (per back)	453	Solid Surface Arm (per pair) - Gr C	810
One-Seat Removable Seat Cover (per seat)	152	See page 631 for color selection.	
One-Seat wide Removable Seat Cover (per seat)	228		
Two-Seat Removable Seat Cover (per seat)	302		
Three-Seat Removable Seat Cover (per seat)	453		
Non-Marring Glides	16		

FAERON METAL | LOUNGE FEATURES & OPTIONS



POLYMER ARM

Faeron arms are durable, comfortable, and long lasting. They are made with injected polymer that is a solid color throughout the arm and are available in three color options: Black, Grey and Taupe.



ARMLESS

Faeron Armless Lounge seating features a metal base available in 2 finish selections; Silver Metallic or Brushed Nickel.



ARM PANELS

Arm Panels are available on Faeron Metal Lounge seating in semi closed and fully closed styles for optimum design flexibility.



METAL ARM FRAME

Faeron Metal Lounge chairs are available in Silver Metallic and Brushed Nickel featuring Polymer Arm. Can be specified with optional Solid Surface or Beech wood.



LOUNGE WALL SAVER

Faeron Lounge models include a wall saver feature in which the angle of the back and the rear legs are designed to keep the back away from the wall, to prevent wear and damage to both the chair and the wall. Not included for Faeron High Back Lounge or Faeron Wingback Lounge due to back height.



CLEAN OUT

All Faeron Lounge seating has a built-in clean out feature: a space at the back of the seat that allows dirt, debris and liquid to fall to the floor for easy clean up and maintenance - designed so that it does not detract from the comfort or appearance of the product.

OPTIONS

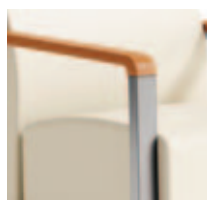

WOOD ARM

Wood arms are solid Beech and available in standard and custom finishes. Krug's wood finish is a proprietary high-durability formulation that has been shown to be an industry leader in abrasion resistance. Arms can be replaced if they do become damaged or degraded.



SOLID SURFACE ARM

The optional Solid Surface Arm provides a fully seamless armrest for enhanced durability, protection and cleanability. It is available in 8 standard Corian colors, and custom colors (at an upcharge). Arms are replaceable as a full side frame if they become damaged or degraded.

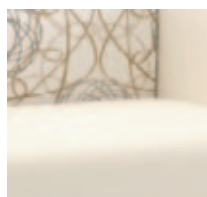

COMBINATION UPHOLSTERY OPTIONS

When combination upholstery is specified with fabric of the same grade or COM, an upcharge for dual fabrics is **\$33 list** per unit and **\$64 list** per unit for three fabrics will be applied. When graded in combination upholstery is selected, use the highest grade upholstery selected or to obtain a quote for blended grading contact Customer Service (please provide the fabrics specified and location of where each fabric is to be applied on the product).

METAL FINISH OPTIONS

Silver Metallic frames are available with an anti-microbial finish for an upcharge of **\$64 list** per arm frame pair or table. Additional Frame Finishes, which include anti-microbial finish, are available for an upcharge of **\$64 list** per per arm frame pair or table. Available colors are: White, Parchment, Sand, Taupe, Warm Grey, Cool Grey or Black. For all metal finishes other than Silver Metallic Standard, there is a minimum order quantity of 30 units per color. Upcharges for order quantities less than 30 units per color or custom metal finishes, please contact Customer Service to obtain a quote.





MOISTURE BARRIER & CAL 133

California Technical Bulletin 133 is a flammability test for seating. Krug offers a compliance method, in combination with non-flammable upholstery covers, that may enable products to meet certification requirements for this test. This process at the same time also provides the products with a Moisture Barrier - a treatment that helps to prevent the passage of liquids and moisture to inside of the upholstered components - thereby conferring sanitary and anti-infection benefits. So when CAL133 is specified, the product also automatically has a Moisture Barrier, and when a Moisture Barrier is specified, the product also features the compliance method and low flammability features of CAL 133. The application of this up-charge and the compliance method does not mean that the specific configuration of product and upholstery cover are tested and officially certified as being CAL133 compliant. If the official certification is required, Krug will provide this (through an independent certified testing laboratory) at a charge of \$917 per item, plus the cost of the product to be tested. Lead time for certification testing is typically 4-8 weeks.

REMOVABLE AND REPLACEABLE COVERS

Faeron Lounge Chairs are available with a Removable Seat & Back Covers. See page 299 for upcharges.

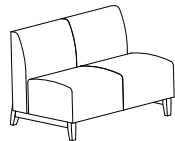
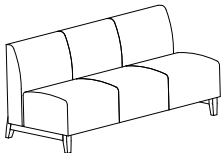
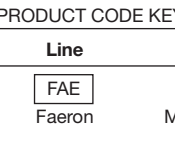
FAERON METAL | ARMLESS LOUNGE

DESCRIPTION/MODEL	COM		COL		FABRIC GRADES			LEATHER		
	1	2	3	4	5	6	7	8	9	
	One-Seat, Armless, with Silver Metallic Metal Base									
	FAE3-MAL1S	1815	1891	1966	2116	2266	2418	2532	2719	3022
	One-Seat Plus, Armless, with Silver Metallic Metal Base									
	FAE3-MALB1S	1886	1964	2039	2189	2340	2491	2606	2791	3095
	One-Seat, Armless, with Brushed Nickel Metal Base									
	FAE3-MAL1N	1967	2043	2118	2268	2419	2570	2684	2872	3175
	One-Seat Plus, Armless, with Brushed Nickel Metal Base									
	FAE3-MALB1N	2040	2116	2191	2341	2492	2642	2758	2944	3247
	One-Seat Wide, Armless, with Silver Metallic Metal Base									
	FAE3-MAL1+S	2064	2167	2271	2476	2681	2886	3091	3295	3708
	One-Seat Wide Plus, Armless, with Silver Metallic Metal Base									
	FAE3-MALB1+S	2144	2244	2347	2553	2760	2965	3167	3374	3785
	One-Seat Wide, Armless, with Brushed Nickel Metal Base									
	FAE3-MAL1+N	2217	2319	2422	2629	2833	3038	3244	3448	3860
	One-Seat Wide Plus, Armless, with Brushed Nickel Metal Base									
	FAE3-MALB1+N	2296	2398	2502	2705	2912	3117	3321	3529	3937
	Two-Seat, Armless, with Silver Metallic Metal Base									
	FAE3-MAL2S	2615	2731	2844	3070	3295	3521	3748	3975	4427
	Two-Seat Plus, Armless, with Silver Metallic Metal Base									
	FAE3-MALB2S	2728	2840	2954	3180	3406	3633	3860	4085	4539
	Two-Seat, Armless, with Brushed Nickel Metal Base									
	FAE3-MAL2N	2768	2883	2995	3222	3448	3673	3902	4128	4580
	Two-Seat Plus, Armless, with Brushed Nickel Metal Base									
	FAE3-MALB2N	2881	2993	3105	3333	3559	3785	4013	4237	4691
	Three-Seat, Armless, with Silver Metallic Metal Base									
	FAE3-MAL3S	3505	3685	3866	4229	4591	4952	5316	5678	6400
	Three-Seat Plus, Armless, with Silver Metallic Metal Base									
	FAE3-MALB3S	3688	3870	4051	4414	4777	5138	5499	5863	6586
	Three-Seat, Armless, with Brushed Nickel Metal Base									
	FAE3-MAL3N	3877	4058	4238	4602	4964	5324	5688	6050	6773
	Three-Seat Plus, Armless, with Brushed Nickel Metal Base									
	FAE3-MALB3N	4061	4243	4423	4786	5149	5510	5872	6235	6959

PRODUCT CODE KEY

Line	Series	Chair Type	Size		Base
FAE	3-MA	L	1	B1	S
Faeron	Metal Lounge Seating	Lounge	One-Seat	One-Seat Plus	Silver Metallic Base
		H	1+	B1+	N
		High Back Lounge	One-Seat Wide	One-Seat Wide Plus	Brushed Nickel
			2	B2	
			Two-Seat	Two-Seat Plus	
			3	B3	
			Three-Seat	Three-Seat Plus	

FAERON METAL | ARMLESS HIGH BACK LOUNGE

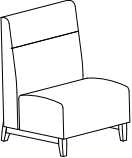
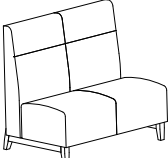
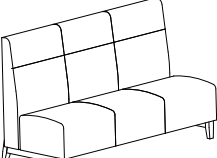
DESCRIPTION/MODEL	Species	COM		COL		FABRIC GRADES			LEATHER	
		1	2	3	4	5	6	7	8	9
	One-Seat, Armless, High back, with Silver Metallic Metal Base FAE3-MAH1S	2053	2145	2237	2420	2607	2789	2973	3159	3529
	One-Seat Plus, Armless, High back, with Silver Metallic Metal Base FAE3-MAHB1S	2124	2217	2310	2493	2679	2862	3047	3231	3599
	One-Seat, Armless, High back, with Brushed Nickel Metal Base FAE3-MAH1N	2206	2297	2389	2572	2759	2942	3127	3311	3680
	One-Seat Plus, Armless, High, with Brushed Nickel Metal Base FAE3-MAHB1N	2278	2369	2462	2646	2831	3014	3200	3384	3753
	One-Seat Wide, Armless, High back, with Silver Metallic Metal Base FAE3-MAH1+S	2319	2440	2559	2797	3036	3274	3515	3753	4230
	One-Seat Wide Plus, Armless, High back, with Silver Metallic Metal Base FAE3-MAHB1+S	2398	2518	2637	2874	3114	3353	3591	3831	4309
	One-Seat Wide, Armless, High back, with Brushed Nickel Metal Base FAE3-MAH1+N	2472	2592	2712	2949	3188	3428	3667	3906	4382
	One-Seat Wide Plus, Armless, High back, with Brushed Nickel Metal Base FAE3-MAHB1+N	2551	2671	2789	3028	3266	3505	3743	3983	4461
	Two-Seat, Armless, High back, with Silver Metallic Metal Base FAE3-MAH2S	2797	2924	3055	3314	3575	3834	4095	4353	4873
	Two-Seat Plus, Armless, High back, with Silver Metallic Metal Base FAE3-MAHB2S	2905	3035	3164	3425	3685	3944	4205	4464	4983
	Two-Seat, Armless, High back, with Brushed Nickel Metal Base FAE3-MAH2N	2949	3077	3207	3468	3728	3987	4247	4505	5024
	Two-Seat Plus, Armless, High back, with Brushed Nickel Metal Base FAE3-MAHB2N	3057	3187	3316	3578	3837	4097	4357	4616	5135
	Three-Seat, Armless, High back, with Silver Metallic Metal Base FAE3-MAH3S	3752	3965	4180	4609	5038	5468	5896	6328	7184
	Three-Seat Plus, Armless, High back with Silver Metallic Metal Base FAE3-MAHB3S	3936	4152	4365	4794	5223	5653	6081	6512	7369
	Three-Seat, Armless, High back, with Brushed Nickel Metal Base FAE3-MAH3N	4124	4338	4553	4981	5411	5840	6269	6699	7556
	Three-Seat Plus, Armless, High back with Brushed Nickel Metal Base FAE3-MAHB3N	4309	4524	4737	5167	5596	6024	6454	6884	7742

PRODUCT CODE KEY

Line	Series	Chair Type	Size	Base	
FAE	3-MA	L	1	B1	S
Faeron	Metal Lounge Seating	Lounge	One-Seat	One-Seat Plus	Silver Metallic Base
		H	1+	B1+	N
		High Back Lounge	One-Seat Wide	One-Seat Wide Plus	Brushed Nickel
			2	B2	
			Two-Seat	Two-Seat Plus	
			3	B3	
			Three-Seat	Three-Seat Plus	

FAERON METAL | LOUNGE

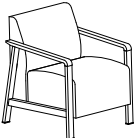
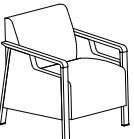
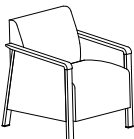
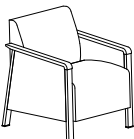
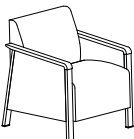
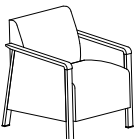
DESCRIPTION/MODEL	COM		COL	FABRIC GRADES			LEATHER			
	1	2	3	4	5	6	7	8	9	
	One-Seat, with Open Arm, Silver Metallic									
	FAE3-ML1OPAS	1966	2042	2117	2266	2418	2569	2720	2870	3173
	One-Seat Plus, with Open Arm, Silver Metallic									
	FAE3-MLB1OPAS	2039	2114	2189	2340	2491	2641	2791	2943	3246
	One-Seat, with Open Arm, Brushed Nickel									
	FAE3-ML1OPAN	2762	2838	2913	3062	3215	3366	3517	3667	3970
	One-Seat Plus, with Open Arm, Brushed Nickel									
	FAE3-MLB1OPAN	2835	2911	2985	3136	3287	3439	3588	3740	4042
	One-Seat, with Semi Closed Arm, Silver Metallic									
	FAE3-ML1SPAS	2560	2671	2780	2979	3185	3384	3589	3809	4180
	One-Seat Plus, with Semi Closed Arm, Silver Metallic									
	FAE3-MLB1SPAS	2632	2743	2851	3052	3257	3456	3662	3881	4252
	One-Seat, with Semi Closed Arm, Brushed Nickel									
	FAE3-ML1SPAN	3356	3468	3577	3774	3981	4180	4385	4605	4977
	One-Seat Plus, with Semi Closed Arm, Brushed Nickel									
	FAE3-MLB1SPAN	3429	3539	3647	3847	4054	4252	4458	4678	5049
	One-Seat, with Closed Arm, Silver Metallic									
	FAE3-ML1CPAS	2581	2692	2802	2999	3206	3405	3610	3830	4202
	One-Seat Plus, with Closed Arm, Silver Metallic									
	FAE3-MLB1CPAS	2654	2764	2872	3072	3279	3477	3683	3903	4273
	One-Seat, with Closed Arm, Brushed Nickel									
	FAE3-ML1CPAN	3378	3489	3597	3796	4003	4202	4407	4626	4996
	One-Seat Plus, with Closed Arm, Brushed Nickel									
	FAE3-MLB1CPAN	3449	3561	3668	3869	4074	4273	4480	4698	5069

ORDERING NOTES: Faeron chairs can be specified with Solid Surface Arm (SA) or Wood Arm (WA), replace “PA” in the model number with the **Arm Style** selection below and add the upcharge listed on [page 299](#). See page 631 for color selection.

PRODUCT CODE KEY

Line	Series	Chair Type	Size	Arm Type	Arm Style	Frame	
FAE Faeron	3-M Metal Lounge Seating	L Lounge	1 One-Seat	B1 One-Seat Plus	O Open Arm	PA Polymer Arm	S Silver Metallic
		H High Back Lounge	1+ One-Seat Wide	B1+ One-Seat Wide Plus	S Semi Closed Arm	WA Wood Arm	N Brushed Nickel
			2 Two-Seat	B2 Two-Seat Plus	C Closed Arm	SA Solid Surface Arm	
			3 Three-Seat	B3 Three-Seat Plus			

FAERON METAL | HIGH BACK LOUNGE

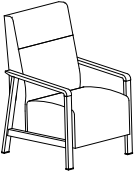
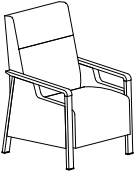
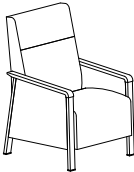
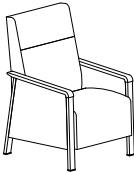
DESCRIPTION/MODEL	COM		COL		FABRIC GRADES			LEATHER		
	1	2	3	4	5	6	7	8	9	
	One-Seat, High back, with Open Arm, Silver Metallic									
	FAE3-MH1OPAS	2206	2296	2388	2572	2758	2942	3126	3311	3680
	One-Seat Plus, High back, with Open Arm, Silver Metallic									
	FAE3-MHB1OPAS	2278	2368	2461	2646	2830	3014	3198	3384	3753
	One-Seat, High back, with Semi Closed Arm, Silver Metallic									
	FAE3-MH1SPAS	2798	2924	3052	3285	3522	3756	3995	4248	4686
	One-Seat Plus, High back, with Semi Closed Arm, Silver Metallic									
	FAE3-MHB1SPAS	2870	2996	3122	3357	3596	3829	4067	4321	4758
	One-Seat, High back, with Closed Arm, Silver Metallic									
	FAE3-MH1CPAS	2819	2946	3072	3307	3544	3777	4016	4269	4708
	One-Seat Plus, High back, with Closed Arm, Silver Metallic									
	FAE3-MHB1PAS	2892	3017	3144	3379	3618	3849	4088	4341	4780
	One-Seat, High back, with Closed Arm, Brushed Nickel									
	FAE3-MH1CPAN	3617	3742	3869	4103	4340	4573	4813	5066	5504
	One-Seat Plus, High back, with Closed Arm, Brushed Nickel									
	FAE3-MHB1CPAN	3688	3815	3940	4174	4414	4646	4885	5139	5576

ORDERING NOTES: Faeron chairs can be specified with Solid Surface Arm (SA) or Wood Arm (WA), replace “PA” in the model number with the **Arm Style** selection below and add the upcharge listed on page 299. See page 631 for color selection.

PRODUCT CODE KEY

Line	Series	Chair Type	Size		Arm Type	Arm Style	Frame
FAE Faeron	3-M Metal Lounge Seating	L Lounge	1 One-Seat	B1 One-Seat Plus	O Open Arm	PA Polymer Arm	S Silver Metallic
		H High Back Lounge	1+ One-Seat Wide	B1+ One-Seat Wide Plus	S Semi Closed Arm	WA Wood Arm	N Brushed Nickel
			2 Two-Seat	B2 Two-Seat Plus	C Closed Arm	SA Solid Surface Arm	
			3 Three-Seat	B3 Three-Seat Plus			

FAERON METAL | LOUNGE

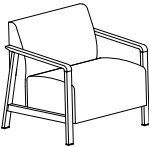
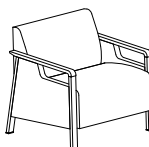
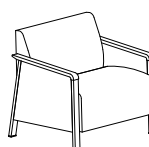
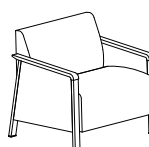
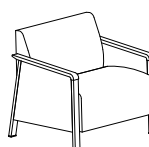
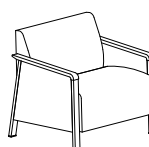
DESCRIPTION/MODEL	COM		COL		FABRIC GRADES			LEATHER		
	1	2	3	4	5	6	7	8	9	
	One-Seat Wide, with Open Arm, Silver Metallic									
	FAE3-ML1+OPAS	2167	2268	2370	2576	2783	2987	3192	3397	3807
	One-Seat Wide Plus, with Open Arm, Silver Metallic									
	FAE3-MLB1+OPAS	2242	2345	2448	2655	2860	3066	3270	3474	3887
	One-Seat Wide, with Open Arm, Brushed Nickel									
	FAE3-ML1+OPAN	2964	3066	3166	3371	3579	3784	3988	4193	4604
	One-Seat Wide Plus, with Open Arm, Brushed Nickel									
	FAE3-MLB1+OPAN	3039	3142	3245	3452	3656	3861	4067	4271	4683
	One-Seat Wide, with Semi Closed Arm, Silver Metallic									
	FAE3-ML1+SPAS	2761	2896	3033	3287	3547	3802	4061	4335	4814
	One-Seat Wide Plus, with Semi Closed Arm, Silver Metallic									
	FAE3-MLB1+SPAS	2837	2973	3112	3366	3626	3878	4140	4413	4891
	One-Seat Wide, with Semi Closed Arm, Brushed Nickel									
	FAE3-ML1+SPAN	3558	3693	3830	4084	4345	4596	4858	5131	5611
	One-Seat Wide Plus, with Semi Closed Arm, Brushed Nickel									
	FAE3-MLB1+SPAN	3634	3771	3908	4162	4422	4675	4936	5210	5689
	One-Seat Wide, with Closed Arm, Silver Metallic									
	FAE3-ML1+CPAS	2783	2919	3055	3309	3568	3822	4083	4356	4835
	One-Seat Wide Plus, with Closed Arm, Silver Metallic									
	FAE3-MLB1+CPAS	2859	2995	3133	3387	3647	3899	4161	4435	4914
	One-Seat Wide, with Closed Arm, Brushed Nickel									
	FAE3-ML1+CPAN	3579	3714	3851	4105	4366	4618	4879	5153	5632
	One-Seat Wide Plus, with Closed Arm, Brushed Nickel									
	FAE3-MLB1+CPAN	3655	3792	3930	4184	4443	4696	4958	5231	5710

ORDERING NOTES: Faeron chairs can be specified with Solid Surface Arm (SA) or Wood Arm (WA), replace "PA" in the model number with the **Arm Style** selection below and add the upcharge listed on page 299. See page 631 for color selection.

PRODUCT CODE KEY

Line	Series	Chair Type	Size		Arm Type	Arm Style	Frame
FAE Faeron	3-M Metal Lounge Seating	L Lounge	1 One-Seat	B1 One-Seat Plus	O Open Arm	PA Polymer Arm	S Silver Metallic
		H High Back Lounge	1+ One-Seat Wide	B1+ One-Seat Wide Plus	S Semi Closed Arm	WA Wood Arm	N Brushed Nickel
			2 Two-Seat	B2 Two-Seat Plus	C Closed Arm	SA Solid Surface Arm	
			3 Three-Seat	B3 Three-Seat Plus			

FAERON METAL | HIGH BACK LOUNGE

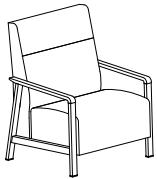
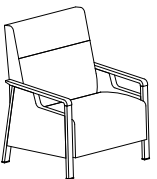
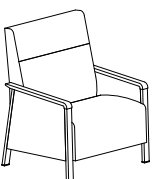
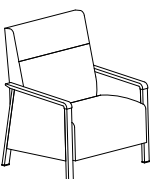
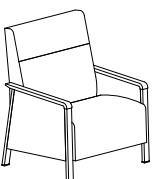
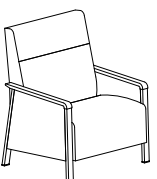
DESCRIPTION/MODEL	COM		COL		FABRIC GRADES			LEATHER		
	1	2	3	4	5	6	7	8	9	
	One-Seat Wide, High back, with Open Arm, Silver Metallic									
	FAE3-MH1+OPAS	2420	2541	2659	2898	3136	3376	3614	3854	4332
	One-Seat Wide Plus, High back, with Open Arm, Silver Metallic									
	FAE3-MHB1+OPAS	2497	2618	2738	2977	3215	3455	3693	3932	4410
	One-Seat Wide, High back, with Open Arm, Brushed Nickel									
	FAE3-MH1+OPAN	3217	3337	3456	3694	3933	4172	4412	4649	5128
	One-Seat Wide Plus, High back, with Open Arm, Brushed Nickel									
	FAE3-MHB1+OPAN	3294	3414	3534	3772	4011	4251	4489	4728	5205
	One-Seat Wide, High back, with Semi Closed Arm, Silver Metallic									
	FAE3-MH1+SPAS	3014	3169	3322	3609	3903	4190	4484	4792	5338
	One-Seat Wide Plus, High back, with Semi Closed Arm, Silver Metallic									
	FAE3-MHB1+SPAS	3092	3247	3399	3687	3981	4268	4562	4868	5414
	One-Seat Wide, High back, with Semi Closed Arm, Brushed Nickel									
	FAE3-MH1+SPAN	3811	3965	4118	4406	4698	4987	5280	5588	6135
	One-Seat Wide Plus, High back, with Semi Closed Arm, Brushed Nickel									
	FAE3-MHB1+SPAN	3889	4043	4196	4484	4778	5065	5360	5664	6211
	One-Seat Wide, High back, with Closed Arm, Silver Metallic									
	FAE3-MH1+CPAS	3036	3190	3343	3631	3922	4212	4505	4813	5360
	One-Seat Wide Plus, High back, with Closed Arm, Silver Metallic									
	FAE3-MHB1+CPAS	3114	3268	3420	3709	4003	4290	4584	4889	5436
	One-Seat Wide, High back, with Closed Arm, Brushed Nickel									
	FAE3-MH1+CPAN	3832	3987	4140	4427	4720	5008	5302	5609	6156
	One-Seat Wide Plus, High back, with Closed Arm, Brushed Nickel									
	FAE3-MHB1+CPAN	3910	4065	4217	4505	4798	5086	5381	5686	6232

ORDERING NOTES: Faeron chairs can be specified with Solid Surface Arm (SA) or Wood Arm (WA), replace "PA" in the model number with the **Arm Style** selection below and add the upcharge listed on page 299. See page 631 for color selection.

PRODUCT CODE KEY

Line	Series	Chair Type	Size		Arm Type	Arm Style	Frame
FAE Faeron	3-M Metal Lounge Seating	L Lounge	1 One-Seat	B1 One-Seat Plus	O Open Arm	PA Polymer Arm	S Silver Metallic
		H High Back Lounge	1+ One-Seat Wide	B1+ One-Seat Wide Plus	S Semi Closed Arm	WA Wood Arm	N Brushed Nickel
			2 Two-Seat	B2 Two-Seat Plus	C Closed Arm	SA Solid Surface Arm	
			3 Three-Seat	B3 Three-Seat Plus			

FAERON METAL | LOUNGE

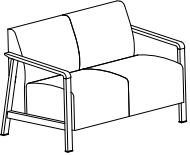
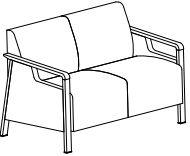
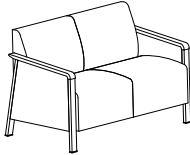

DESCRIPTION/MODEL	COM		COL		FABRIC GRADES			LEATHER			
	1	2	3	4	5	6	7	8	9		
	Two-Seat, with Open Arm, Silver Metallic FAE3-ML2OPAS		2746	2860	2971	3200	3425	3652	3878	4104	4558
	Two-Seat Plus, with Open Arm, Silver Metallic FAE3-MLB2OPAS		2831	2943	3057	3283	3512	3736	3962	4190	4643
	Two-Seat, with Open Arm, Brushed Nickel FAE3-ML2OPAN		3543	3656	3768	3996	4221	4447	4675	4900	5353
	Two-Seat Plus, with Open Arm, Brushed Nickel FAE3-MLB2OPAN		3627	3740	3854	4081	4308	4532	4758	4987	5439
	Two-Seat, with Semi Closed Arm, Silver Metallic FAE3-ML2SPAS		3341	3489	3635	3911	4191	4466	4748	5041	5563
	Two-Seat Plus, with Semi Closed Arm, Silver Metallic FAE3-MLB2SPAS		3425	3573	3720	3995	4278	4549	4832	5128	5649
	Two-Seat, with Semi Closed Arm, Brushed Nickel FAE3-ML2SPAN		4138	4286	4432	4708	4988	5262	5544	5838	6360
	Two-Seat Plus, with Semi Closed Arm, Brushed Nickel FAE3-MLB2SPAN		4221	4369	4516	4792	5073	5346	5629	5924	6445
	Two-Seat, with Closed Arm, Silver Metallic FAE3-ML2CPAS		3363	3510	3656	3933	4213	4487	4769	5063	5586
	Two-Seat Plus, with Closed Arm, Silver Metallic FAE3-MLB2CPAS		3446	3594	3741	4016	4297	4571	4854	5149	5671
	Two-Seat, with Closed Arm, Brushed Nickel FAE3-ML2CPAN		4159	4307	4454	4729	5009	5284	5566	5859	6381
	Two-Seat Plus, with Closed Arm, Brushed Nickel FAE3-MLB2CPAN		4243	4391	4537	4813	5095	5367	5649	5945	6466

ORDERING NOTES: Faeron chairs can be specified with Solid Surface Arm (SA) or Wood Arm (WA), replace "PA" in the model number with the **Arm Style** selection below and add the upcharge listed on page 299. See page 631 for color selection.

PRODUCT CODE KEY

Line	Series	Chair Type	Size		Arm Type	Arm Style	Frame
FAE Faeron	3-M Metal Lounge Seating	L Lounge	1 One-Seat	B1 One-Seat Plus	O Open Arm	PA Polymer Arm	S Silver Metallic
		H High Back Lounge	1+ One-Seat Wide	B1+ One-Seat Wide Plus	S Semi Closed Arm	WA Wood Arm	N Brushed Nickel
			2 Two-Seat	B2 Two-Seat Plus	C Closed Arm	SA Solid Surface Arm	
			3 Three-Seat	B3 Three-Seat Plus			

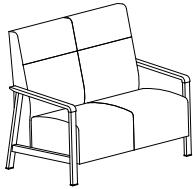
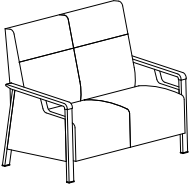
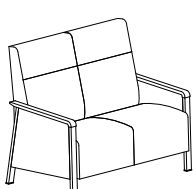
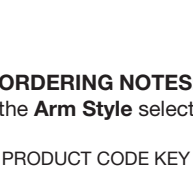
FAERON METAL | HIGH BACK LOUNGE

DESCRIPTION/MODEL	COM		COL		FABRIC GRADES			LEATHER		
	1	2	3	4	5	6	7	8	9	
	Two-Seat, High back, with Open Arm, Silver Metallic									
	FAE3-MH2OPAS	2923	3054	3184	3444	3704	3963	4223	4484	5005
	Two-Seat Plus, High back, with Open Arm, Silver Metallic									
	FAE3-MHB2OPAS	3010	3140	3267	3529	3787	4047	4308	4567	5087
	Two-Seat, High back, with Open Arm, Brushed Nickel									
	FAE3-MH2OPAN	3720	3849	3980	4239	4500	4759	5020	5280	5800
	Two-Seat Plus, High back, with Open Arm, Brushed Nickel									
	FAE3-MHB2OPAN	3806	3936	4064	4323	4584	4843	5105	5364	5884
	Two-Seat, High back, with Semi Closed Arm, Silver Metallic									
	FAE3-MH2SPAS	3517	3683	3846	4155	4469	4778	5093	5421	6010
	Two-Seat Plus, High back, with Semi Closed Arm, Silver Metallic									
	FAE3-MHB2SPAS	3604	3768	3931	4238	4554	4861	5176	5506	6094
	Two-Seat, High back, with Semi Closed Arm, Brushed Nickel									
	FAE3-MH2SPAN	4313	4480	4643	4951	5265	5573	5889	6218	6807
	Two-Seat Plus, High back, with Semi Closed Arm, Brushed Nickel									
	FAE3-MHB2SPAN	4399	4565	4727	5035	5349	5658	5972	6302	6891
	Two-Seat, High back, with Closed Arm, Silver Metallic									
	FAE3-MH2CPAS	3538	3704	3867	4176	4490	4798	5113	5442	6032
	Two-Seat Plus, High back, with Closed Arm, Silver Metallic									
	FAE3-MHB2CPAS	3624	3789	3952	4260	4574	4883	5197	5527	6115
	Two-Seat, High back, with Closed Arm, Brushed Nickel									
	FAE3-MH2CPAN	4335	4500	4664	4972	5287	5595	5911	6240	6828
	Two-Seat Plus, High back, with Closed Arm, Brushed Nickel									
	FAE3-MHB2CPAN	4421	4587	4748	5056	5370	5679	5993	6322	6912

ORDERING NOTES: Faeron chairs can be specified with Solid Surface Arm (SA) or Wood Arm (WA), replace "PA" in the model number with the **Arm Style** selection below and add the upcharge listed on page 299. See page 631 for color selection.

PRODUCT CODE KEY

Line	Series	Chair Type	Size		Arm Type	Arm Style	Frame
FAE Faeron	3-M Metal Lounge Seating	L Lounge	1 One-Seat	B1 One-Seat Plus	O Open Arm	PA Polymer Arm	S Silver Metallic
		H High Back Lounge	1+ One-Seat Wide	B1+ One-Seat Wide Plus	S Semi Closed Arm	WA Wood Arm	N Brushed Nickel
			2 Two-Seat	B2 Two-Seat Plus	C Closed Arm	SA Solid Surface Arm	
			3 Three-Seat	B3 Three-Seat Plus			

FAERON METAL | LOUNGE

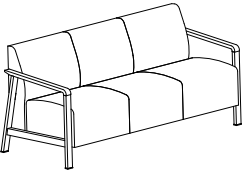
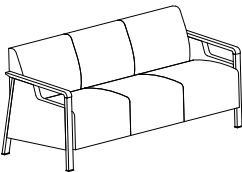
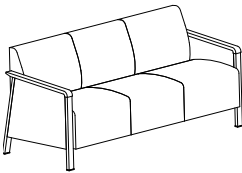
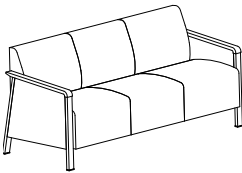
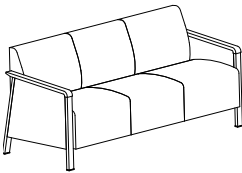
DESCRIPTION/MODEL	COM		COL	FABRIC GRADES			LEATHER			
	1	2	3	4	5	6	7	8	9	
	Three-Seat, with Open Arm, Silver Metallic									
	FAE3-ML3OPAS	3550	3730	3786	4273	4636	4996	5361	5722	6447
	Three-Seat Plus, with Open Arm, Silver Metallic									
	FAE3-MLB3OPAS	3697	3878	4060	4421	4784	5145	5508	5870	6595
	Three-Seat, with Semi Closed Arm, Silver Metallic									
	FAE3-ML3SPAS	4143	4358	4447	4986	5404	5811	6229	6661	7453
	Three-Seat Plus, with Semi Closed Arm, Silver Metallic									
	FAE3-MLB3SPAS	4291	4507	4722	5132	5549	5959	6377	6808	7599
	Three-Seat, with Semi Closed Arm, Brushed Nickel									
	FAE3-ML3SPAN	4941	5155	5244	5782	6199	6608	7025	7458	8249
	Three-Seat Plus, with Semi Closed Arm, Brushed Nickel									
	FAE3-MLB3SPAN	5087	5304	5518	5929	6346	6756	7173	7605	8396
	Three-Seat, with Closed Arm, Silver Metallic									
	FAE3-ML3CPAS	4164	4380	4469	5007	5424	5833	6250	6683	7474
	Three-Seat Plus, with Closed Arm, Silver Metallic									
	FAE3-MLB3CPAS	4312	4529	4743	5154	5571	5980	6397	6829	7621
	Three-Seat, with Closed Arm, Brushed Nickel									
	FAE3-ML3CPAN	4962	5176	5265	5804	6221	6629	7046	7479	8270
	Three-Seat Plus, with Closed Arm, Brushed Nickel									
	FAE3-MLB3CPAN	5109	5324	5540	5949	6367	6777	7194	7625	8417

ORDERING NOTES: Faeron chairs can be specified with Solid Surface Arm (SA) or Wood Arm (WA), replace "PA" in the model number with the **Arm Style** selection below and add the upcharge listed on page 299. See page 631 for color selection.

PRODUCT CODE KEY

Line	Series	Chair Type	Size		Arm Type	Arm Style	Frame
FAE Faeron	3-M Metal Lounge Seating	L Lounge	1 One-Seat	B1 One-Seat Plus	O Open Arm	PA Polymer Arm	S Silver Metallic
		H High Back Lounge	1+ One-Seat Wide	B1+ One-Seat Wide Plus	S Semi Closed Arm	WA Wood Arm	N Brushed Nickel
			2 Two-Seat	B2 Two-Seat Plus	C Closed Arm	SA Solid Surface Arm	
			3 Three-Seat	B3 Three-Seat Plus			

FAERON METAL | HIGH BACK LOUNGE

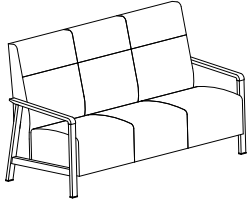
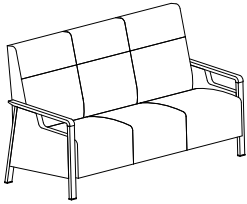
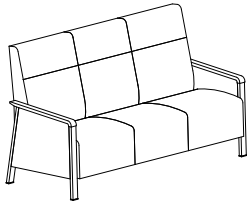



DESCRIPTION/MODEL	COM		COL		FABRIC GRADES			LEATHER		
	1	2	3	4	5	6	7	8	9	
	Three-Seat, High back, with Open Arm, Silver Metallic FAE3-MH3OPAS	3796	4011	4224	4654	5084	5513	5941	6372	7229
	Three-Seat Plus, High back, with Open Arm, Silver Metallic FAE3-MHB3OPAS	3943	4158	4373	4801	5231	5660	6090	6518	7377
	Three-Seat, High back, with Open Arm, Brushed Nickel FAE3-MH3OPAN	4592	4809	5021	5450	5881	6310	6737	7168	8026
	Three-Seat Plus, High back, with Open Arm, Brushed Nickel FAE3-MHB3OPAN	4740	4953	5170	5597	6028	6456	6885	7314	8173
	Three-Seat, High back, with Semi Closed Arm, Silver Metallic FAE3-MH3SPAS	4391	4639	4887	5365	5850	6328	6810	7310	8236
	Three-Seat Plus, High back, with Semi Closed Arm, Silver Metallic FAE3-MHB3SPAS	4537	4786	5036	5513	5995	6474	6958	7457	8384
	Three-Seat, High back, with Semi Closed Arm, Brushed Nickel FAE3-MH3SPAN	5187	5436	5684	6162	6646	7123	7608	8106	9032
	Three-Seat Plus, High back, with Semi Closed Arm, Brushed Nickel FAE3-MHB3SPAN	5334	5583	5833	6310	6793	7270	7755	8253	9180
	Three-Seat, High back, with Closed Arm, Silver Metallic FAE3-MH3CPAS	4412	4662	4908	5387	5871	6347	6832	7331	8257
	Three-Seat Plus, High back, with Closed Arm, Silver Metallic FAE3-MHB3CPAS	4559	4809	5057	5534	6017	6495	6980	7478	8405
	Three-Seat, High back, with Closed Arm, Brushed Nickel FAE3-MH3CPAN	5209	5457	5705	6183	6668	7145	7629	8128	9054
	Three-Seat Plus, High back, with Closed Arm, Brushed Nickel FAE3-MHB3CPAN	5355	5604	5854	6331	6814	7292	7775	8272	9201

ORDERING NOTES: Faeron chairs can be specified with Solid Surface Arm (SA) or Wood Arm (WA), replace "PA" in the model number with the **Arm Style** selection below and add the upcharge listed on page 299. See page 631 for color selection.

PRODUCT CODE KEY

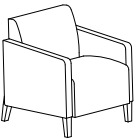
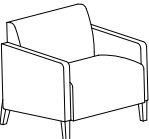
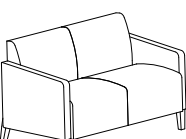
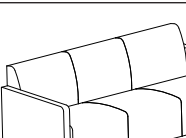
Line	Series	Chair Type	Size		Arm Type	Arm Style	Frame
FAE Faeron	3-M Metal Lounge Seating	L Lounge	1 One-Seat	B1 One-Seat Plus	O Open Arm	PA Polymer Arm	S Silver Metallic
		H High Back Lounge	1+ One-Seat Wide	B1+ One-Seat Wide Plus	S Semi Closed Arm	WA Wood Arm	N Brushed Nickel
			2 Two-Seat	B2 Two-Seat Plus	C Closed Arm	SA Solid Surface Arm	
			3 Three-Seat	B3 Three-Seat Plus			

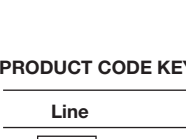
FAERON UPHOLSTERED | LOUNGE

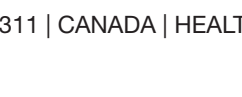

DESCRIPTION/MODEL	COM		COL		FABRIC GRADES		LEATHER		
	1	2	3	4	5	6	7	8	9
	One-Seat Upholstered Arm Lounge, No Arm Cap, Beech Wood leg								
	FAE3-UL1NCW	2899	3070	3241	3583	3927	4267	4611	4952
	One-Seat Plus Upholstered Arm Lounge, No arm cap, Wood leg								
	FAE3-ULB1NCW	2973	3145	3316	3661	4003	4343	4686	5030
	One-Seat Wide Upholstered Arm Lounge, No arm cap, Wood leg								
	FAE3-UL1+NCW	3109	3308	3509	3908	4308	4707	5107	5504
	One-Seat Wide Plus Upholstered Arm Lounge, No arm cap, Wood leg								
	FAE3-ULB1+NCW	3190	3390	3589	3988	4391	4788	5188	5587
	Two-seat Upholstered Arm Lounge, No arm cap, Wood leg								
	FAE3-UL2NCW	3718	3930	4140	4561	4983	5406	5825	6246
	Two-seat Plus Upholstered Arm Lounge, No arm cap, Wood leg								
	FAE3-ULB2NCW	3809	4019	4230	4649	5071	5494	5915	6335
	Three-seat Upholstered Arm Lounge, No arm cap, Wood leg								
	FAE3-UL3NCW	4561	4843	5125	5691	6254	6818	7382	7945
	Three-seat Plus Upholstered Arm Lounge, No arm cap, Wood leg								
	FAE3-ULB3NCW	4718	4998	5281	5844	6409	6972	7537	8100

ORDERING NOTES: Faeron upholstered chairs can be specified with Urethane Arm Caps (UC), Solid Surface Arm Caps (SC), or Wood Arm Caps (WC), replace “NC” in the model number with the **Arm Style** selection below and add the upcharge listed on page 299. To specify the Metal Leg option below, replace “W” in the above model number with “S” for Silver Metallic or “N” for Brushed Nickel.

PRODUCT CODE KEY

Line	Series	Chair Type	Size	Arm Cap	Leg Type	
FAE Faeron	3-U Upholstered Arm Lounge Seating	L Lounge	1 One-Seat	B1 One-Seat Plus	NC No Cap	W Beech Wood Leg
		H High Back Lounge	1+ One-Seat Wide	B1+ One-Seat Wide Plus	UC Urethane Cap	S Silver Metallic Leg
			2 Two-Seat	B2 Two-Seat Plus	SC Solid Surface Cap	N Brushed Nickel Leg
			3 Three-Seat	B3 Three-Seat Plus	WC Wood Arm Cap	

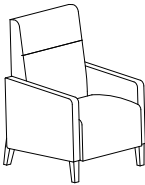
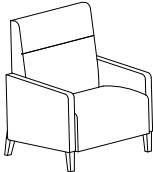
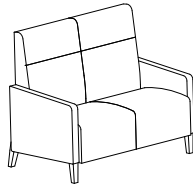
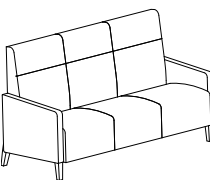
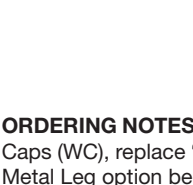
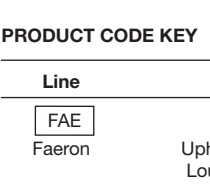
FAERON UPHOLSTERED | HIGH BACK LOUNGE

DESCRIPTION/MODEL	COM		COL		FABRIC GRADES			LEATHER	
	1	2	3	4	5	6	7	8	9
	One-Seat Upholstered Arm High Back Lounge, No Arm Cap, Wood leg								
	FAE3-UH1NCW	3147	3339	3528	3904	4282	4659	5035	5413
	One-Seat Plus, Upholstered Arm High Back Lounge, No Arm Cap, Wood leg								
	FAE3-UHB1NCW	3223	3412	3603	3980	4357	4735	5112	5490
	One-Seat Wide, Upholstered Arm High Back Lounge, No Arm Cap, Wood leg								
	FAE3-UH1+NCW	3378	3594	3812	4245	4680	5113	5549	5985
	One-Seat Wide Plus, Upholstered Arm High Back Lounge, No Arm Cap, Wood leg								
	FAE3-UHB1+NCW	3458	3678	3893	4327	4763	5196	5632	6064
	Two-seat, Upholstered Arm High Back Lounge, No Arm Cap, Wood leg								
	FAE3-UH2NCW	3906	4133	4362	4817	5275	5733	6187	6646
	Two-seat Plus, Upholstered Arm High Back Lounge, No Arm Cap, Wood leg								
	FAE3-UHB2NCW	3994	4222	4452	4906	5364	5821	6277	6734
	Three-seat, Upholstered Arm High Back Lounge, No Arm Cap, Wood leg								
	FAE3-UH3NCW	4819	5138	5454	6088	6723	7358	7992	8627
	Three-seat Plus, Upholstered Arm High Back Lounge, No Arm Cap, Wood leg								
	FAE3-UHB3NCW	4974	5292	5611	6244	6879	7512	8148	8783

ORDERING NOTES: Faeron upholstered chairs can be specified with Urethane Arm Caps (UC), Solid Surface Arm Caps (SC), or Wood Arm Caps (WC), replace "NC" in the model number with the **Arm Style** selection below and add the upcharge listed on page 299. To specify the Metal Leg option below, replace "W" in the above model number with "S" for Silver Metallic or "N" for Brushed Nickel.

PRODUCT CODE KEY

Line	Series	Chair Type	Size	Arm Style	Leg Type
FAE Faeron	3-U Upholstered Arm Lounge Seating	L Lounge	1 One-Seat	NC No Cap	W Beech Wood Leg
		H High Back Lounge	1+ One-Seat Wide	UC Urethane Cap	S Silver Metallic
			2 Two-Seat	SC Solid Surface Cap	N Brushed Nickel
			3 Three-Seat	WC Wood Arm Cap	
				B1 One-Seat Plus	
				B1+ One-Seat Wide Plus	
				B2 Two-Seat Plus	
				B3 Three-Seat Plus	

FAERON UPHOLSTERED | WINGBACK LOUNGE

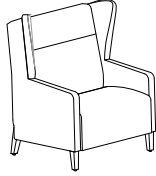
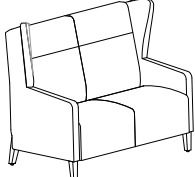
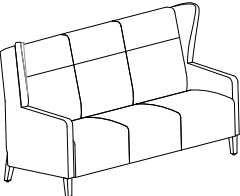
DESCRIPTION/MODEL	COM		COL		FABRIC GRADES			LEATHER	
	1	2	3	4	5	6	7	8	9
 One-Seat Upholstered Arm Wingback, No Arm Cap, Wood leg FAE3-UW1NCW	3589	3780	3966	4345	4721	5098	5477	5854	6608
	3665	3854	4042	4421	4796	5174	5553	5931	6685
 One-Seat Wide Upholstered Arm Wingback, No Arm Cap, Wood leg FAE3-UW1+NCW	3817	4036	4251	4685	5121	5556	5990	6422	7293
	3898	4116	4335	4768	5203	5636	6072	6506	7374
 Two-seat Upholstered Arm Wingback, No Arm Cap, Wood leg FAE3-UW2NCW	4345	4573	4802	5259	5716	6171	6629	7085	7998
	4435	4663	4890	5346	5806	6262	6716	7174	8088
 Three-seat Upholstered Arm Wingback, No Arm Cap, Wood leg FAE3-UW3NCW	5260	5579	5895	6529	7163	7799	8433	9067	10336
	5416	5734	6050	6685	7318	7953	8589	9222	10490

ORDERING NOTES: Faeron upholstered chairs can be specified with Urethane Arm Caps (UC), Solid Surface Arm Caps (SC), or Wood Arm Caps (WC), replace "NC" in the model number with the **Arm Style** selection below and add the upcharge listed on page 299. To specify the Metal Leg option below, replace "W" in the above model number with "S" for Silver Metallic or "N" for Brushed Nickel.

PRODUCT CODE KEY

Line	Series	Chair Type	Size	Arm Cap	Leg Type
FAE Faeron	3-U Upholstered Arm Lounge Seating	W Wingback	1 One-Seat	NC No Cap	W Beech Wood Leg
			1+ One-Seat Wide	WC Wood Arm Cap	S Silver Metallic
			2 Two-Seat	SC Solid Surface Cap	N Brushed Nickel
			3 Three-Seat		

LEED CI CREDITS



MATERIAL CONTENT:

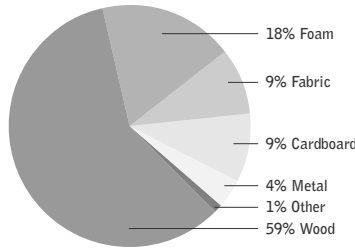

PRE-CONSUMER
RECYCLED CONTENT = 2%

POST-CONSUMER
RECYCLED CONTENT = 12%

CONTRIBUTES TO

CREDIT 2.1 - 2.2	Construction Waste Management	1-2 point(s)
CREDIT 3.3	Resource Reuse	1 point
CREDIT 4.1	Recycled Content	1 point
CREDIT 4.5	Low Emitting Materials, Systems & Seating	1 point
CREDIT 5.1	Regional Materials*	1 point
CREDIT 7	Certified Wood (MUST BE REQUESTED)	1 point(s)

*This credit is only applicable if in total 20% of the combined value of the procurement of construction materials and in the furniture are manufactured within a radius of 500 miles. This credit will apply if the installation of the finished product occurs within 500 miles of Kitchener, Ontario.

level® CERTIFICATION, AIR EMISSIONS AND FSC® CERTIFICATION



level® CERTIFICATION

BIFMA's e3 Furniture Sustainability Standard is a voluntary, multi-attribute standard that measures the degree of sustainability of furniture. This standard evaluates product and company environmental attributes and compliance systems in a wide range of elements which include Materials, Energy & Atmosphere, Human & Ecosystem Health and Social Responsibility. Jordan products have earned level®, BIFMA's sustainability certification program for furniture, certification through third-party verification against the e3 standard.

AIR-EMISSIONS

All Jordan products are supplied with air-emissions certified. Contact customer service for information.



FSC®

In 2005, Krug received Forest Stewardship Council® (FSC®) Chain-of-Custody certification for our manufacturing facilities. The FSC® Chain-of-Custody tracks certified wood from seedling to final sale. It verifies that the material for our FSC® certified products only come from well-managed, FSC®-certified forests and other controlled sources. FSC® is dedicated to the promotion of responsible forest management worldwide helping to take care of forests for future generations. Jordan and other Krug products can be specified with FSC® Certification. Contact customer service for further information, pricing and lead times.



Architects, designers, and building professionals can specify FSC®-certified products in order to achieve a point from the U.S. Green Building Council's Leadership in Energy and Environmental Design (LEED) Rating System.

JORDAN | LOUNGE - DIMENSIONS & COM REQUIREMENTS

DIMENSIONS & COM REQUIREMENTS

	Overall Width	Overall Depth	Overall Height	Seat Height	Height of Arms from Floor	Width Between Arms	Seat Depth	Shipping Weight	Cube
One-Seater	29	30.5	34.5	17.25	26	23	20	78	22
Two-seater	52	30.5	34.5	17.25	26	46	20	106	34
Three-seater	75	30.5	34.5	17.25	26	69	20	131	49

COM - YARDAGE REQUIREMENTS

	COM Yardage Entire Unit	COM Yardage Seat Only	COM Yardage Back Only	COM Yardage Arms Only	COM Yardage Kickplate
One-Seat - One Chair	4.6	1.1	1.7	2.9	0.3
One-Seat - Two Chairs	9.2	1.9	2.6	5.8	0.3
One-Seat - Three Chairs	13.8	2.9	4.3	8.7	0.6
One-Seat - Four Chairs	18.4	3.8	5.2	11.6	0.6
Two-Seat - One Chair	6	1.5	2.5	2.9	0.3
Two-Seat - Two Chairs	12	2.94	4.3	5.8	0.6
Two-Seat - Three Chairs	18	4.38	6.8	8.7	0.9
Two-Seat - Four Chairs	24	5.9	8.6	11.6	1.2
Three-Seat - One Chair	7.6	2.1	3.4	2.9	0.6
Three-Seat - Two Chairs	15.2	4.2	6.1	5.8	0.9
Three-Seat - Three Chairs	22.8	6.3	9.5	8.7	1.4
Three-Seat - Four Chairs	30.4	8.4	12.2	11.6	1.7

Note: Some vinyls, leathers & upholsteries are not suitable for application on Jordan seating. Please refer to page 628 for C.O.M approval process.

WEIGHT CAPACITIES

Jordan weight capacities are as follows:

- One -Seat - 350 lbs
- Two- Seat - 525 lbs
- Three - Seat - 750 lbs

Jordan Option Upcharges	\$ List		\$ List
CAL 133 & Moisture Barrier (per yard)	64	Removeable Back Covers - One Seat	159
Removable Seat Cover - one seat	159	Removeable Back Covers - Two Seat	318
Removable Seat Cover - two seat	318	Removeable Back Covers - Three Seat	477
Removable Seat Cover - three seat	477	Solid Surface Arm Cap (per pair) - Gr A White	517
Non-Marring Glide	37	Solid Surface Arm Cap (per pair) - Gr A Color	527
Combination Upholstery - dual fabrics	33	Solid Surface Arm Cap (per pair) - Gr B	548
Combination Upholstery -Three fabrics	64	Solid Surface Arm Cap (per pair) - Gr C	577

JORDAN | LOUNGE - FEATURES & OPTIONS



CLEAN OUT

Jordan lounge seating models have a built-in clean out feature: a space at the back of the seat that allows dirt debris and liquid to be forced through and fall to the floor for easy clean up and maintenance - designed so that it does not detract from the comfort or appearance of the product.



GLIDES

Jordan Lounge is available with two options for glides - the stainless steel glide, or the white nylon glide. The white nylon glide is ideal on flooring that is easily marked. The stainless comes standard unless the white nylon glide is specified when ordering.



FULL URETHANE ARMS

Jordan full urethane arms have a soft outer skin that enhances comfort and provides excellent grip for safety of ingress and egress. They are highly durable, easy to clean and maintain, and will retain a like-new look even with intensive use. They are available in three colors; Taupe, Grey and Black.



LEGS

Jordan Lounge are available with wood legs - in either Beech or Maple, as well as in three urethane color options; Black, Grey and Taupe. Two options exist for glides on the Jordan Lounge. The white nylon glides are ideal for use on flooring that is easily marked. The stainless steel glides should be utilized for all other types floor surfaces.

WEIGHT CAPACITIES

Jordan weight capacities are as follows:

One -Seat - 350 lbs

Two- Seat - 525 lbs

Three - Seat - 750 lbs

CUSTOM CAPABILITIES

Modifications in dimension, seat and back shape or thickness, and other modifications are possible with Krug's capability to customize for specific requirements and needs. We can also provide custom finishes.

LATEX FREE

Krug products are made with latex-free materials to prevent the allergic reaction that latex causes in some people.

OPTIONS

SOLID SURFACE ARM CAP

The optional Solid Surface Arm Cap provides enhanced durability, protection and cleanability for the arms. This is field replaceable if this becomes damaged or degraded and is available in 8 standard colors. See [page 551](#) for color selection.

COMBINATION UPHOLSTERY OPTIONS

When combination upholstery is specified with fabric of the same grade or COM, an upcharge for dual fabrics is **\$33 list** per unit and **\$64 list** per unit for three fabrics will be applied. When graded in combination upholstery is selected, use the highest grade upholstery selected or to obtain a quote for blended grading contact Customer Service (please provide the fabrics specified and location of where each fabric is to be applied on the product).

MOISTURE BARRIER & CAL 133





California Technical Bulletin 133 is a flammability test for seating. Krug offers a compliance method, in combination with non-flammable upholstery covers, may enable products to meet certification requirements for this test. This process at the same time also provides the products with a Moisture Barrier - a treatment that helps to prevent the passage of liquids and moisture to inside of the upholstered components - thereby conferring sanitary and anti-infection benefits. So when CAL 133 is specified, the product also automatically has a Moisture Barrier, and when a Moisture Barrier is specified, the product also features the compliance method and low flammability features of CAL 133.

The application of this up-charge and the compliance method does not mean that the specific configuration of product and upholstery cover are tested and officially certified as being CAL133 compliant. If the official certification is required, Krug will provide this (through an independent certified testing laboratory) at a charge of \$917 per item, plus the cost of the product to be tested. Lead time for certification testing is typically 4-8 weeks.

REMOVABLE AND REPLACEABLE COVERS

Jordan Lounge Chairs are available with a Removable Seat & Back Covers.

JORDAN | LOUNGE

DESCRIPTION/MODEL	Species	COM		COL			FABRIC GRADES			LEATHER	
		1	2	3	4	5	6	7	8	9	
	One-Seat, Upholstered Arm										
	JOR3-1UPH	Beech/Urethane	1898	2090	2341	2779	3241	3701	4161	4620	5367
	JOR3-1UPH	Maple	1956	2146	2396	2838	3297	3759	4216	4678	5425
	One-Seat, Upholstered Arm with Urethane Arm Cap										
	JOR3-1UUR	Beech/Urethane	1996	2189	2439	2877	3339	3799	4259	4718	5465
	JOR3-1UUR	Maple	2054	2243	2494	2936	3395	3856	4314	4776	5523
	One-Seat, Full Urethane Arm										
	JOR3-1FUR	Beech/Urethane	2018	2211	2461	2899	3361	3822	4281	4740	5487
	JOR3-1FUR	Maple	2063	2265	2516	2958	3417	3878	4336	4798	5545
	One-Seat, Wood Arm										
	JOR3-1WOD	Beech/Urethane	2123	2316	2566	3004	3466	3927	4385	4844	5592
	JOR3-1WOD	Maple	2180	2370	2620	3062	3521	3983	4441	4903	5650
	One-Seat, Wood Arm with Urethane Arm Cap										
	JOR3-1URE	Beech/Urethane	2252	2444	2695	3133	3595	4055	4515	4973	5721
	JOR3-1URE	Maple	2310	2500	2749	3192	3650	4112	4570	5032	5779

Jordan Option Upcharges

	\$ List		\$ List
CAL 133 & Moisture Barrier (per yard)	64	Solid Surface Arm Cap (per pair) - Gr A White	517
Removable Seat Cover (per seat) - One-seat	159	Solid Surface Arm Cap (per pair) - Gr A Color	527
Removeable Back Covers - One-seat	159	Solid Surface Arm Cap (per pair) - Gr B	548
Non-Marring Glide	37	Solid Surface Arm Cap (per pair) - Gr C	577
Combination Upholstery - dual fabrics	33		
Combination Upholstery -Three fabrics	64		

ORDERING NOTES:

Jordan lounge chairs are available with Black, Grey or Taupe Urethane legs at no additional charge.

PRODUCT CODE KEY

Line	Series	Size	Arm Types	
JOR	3	1	UPH	USS
Jordan	Lounge Seating	One-Seat	Upholstered Arm	Upholstered Arm with Solid Surface Arm Cap
			UUR	SSC
			Upholstered Arm with Urethane Arm Cap	Wood Arm with Solid Surface Arm Cap
			FUR	
			Full Urethane Arm	
			WOD	
			Wood Arm	
			URE	
			Wood Arm with Urethane Arm Cap	

JORDAN | LOUNGE

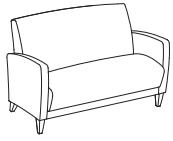
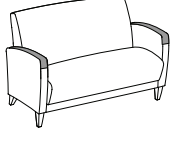
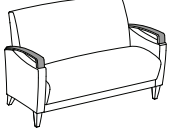
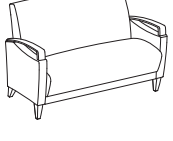
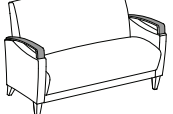
DESCRIPTION/MODEL	Species	COM		COL			FABRIC GRADES			LEATHER	
		1	2	3	4	5	6	7	8	9	
	Two-Seat, Upholstered Arm										
	JOR3-2UPH Beech/Urethane	2657	2926	3374	3911	4447	4984	5523	6057	6998	
	JOR3-2UPH Maple	2695	2963	3412	3950	4486	5023	5559	6097	7036	
	Two-Seat, Upholstered Arm with Urethane Arm Cap										
	JOR3-2UUR Beech/Urethane	2756	3025	3472	4008	4546	5082	5620	6156	7095	
	JOR3-2UUR Maple	2793	3060	3511	4047	4584	5121	5657	6196	7133	
	Two-Seat, Full Urethane Arm										
	JOR3-2FUR Beech/Urethane	2778	3047	3494	4030	4568	5104	5642	6178	7117	
	JOR3-2FUR Maple	2815	3082	3533	4069	4606	5143	5679	6218	7155	
	Two-Seat, Wood Arm										
	JOR3-2WOD Beech/Urethane	2882	3151	3599	4135	4672	5209	5747	6282	7222	
	JOR3-2WOD Maple	2920	3187	3638	4174	4711	5248	5784	6322	7260	
	Two-Seat, Wood Arm with Urethane Arm Cap										
	JOR3-2URE Beech/Urethane	3011	3280	3728	4265	4801	5338	5876	6411	7352	
	JOR3-2URE Maple	3049	3316	3766	4303	4840	5377	5913	6451	7389	

Jordan Option Upcharges	\$ List	\$ List
CAL 133 & Moisture Barrier (per yard)	64	Solid Surface Arm Cap (per pair) - Gr A White
Removable Seat Cover - Two-seat	318	Solid Surface Arm Cap (per pair) - Gr A Color
Removeable Back Covers - Two-Seat	318	Solid Surface Arm Cap (per pair) - Gr B
Non-Marring Glide	37	Solid Surface Arm Cap (per pair) - Gr C
Combination Upholstery - dual fabrics	33	
Combination Upholstery -Three fabrics	64	

ORDERING NOTES:

Jordan lounge chairs are available with Black, Grey or Taupe Urethane legs at no additional charge.

PRODUCT CODE KEY

Line	Series	Size	Arm Types
JOR	3	2	UPH
Jordan	Lounge Seating	Two-Seat	Upholstered Arm
			UUR
			Upholstered Arm with Urethane Arm Cap
			FUR
			Full Urethane Arm
			WOD
			Wood Arm
			URE
			Wood Arm with Urethane Arm Cap
			USS
			Upholstered Arm with Solid Surface Arm Cap
			SSC
			Wood Arm with Solid Surface Arm Cap

JORDAN | LOUNGE

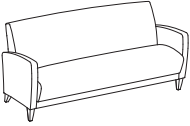
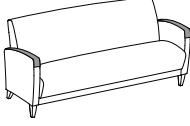
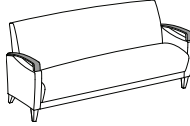
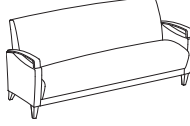
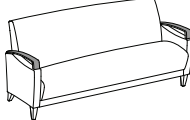
DESCRIPTION/MODEL	Species	COM		COL			FABRIC GRADES			LEATHER		
		1	2	3	4	5	6	7	8	9		
	Three-Seat, Upholstered Arm											
	JOR3-3UPH Beech/Urethane	3825	4198	4639	5407	6211	7017	7820	8624	9947		
	JOR3-3UPH Maple	3882	4257	4697	5464	6269	7073	7879	8683	10007		
	Three-Seat, Upholstered Arm with Urethane Arm Cap											
	JOR3-3UUR Beech/Urethane	3922	4296	4737	5505	6310	7114	7919	8722	10045		
	JOR3-3UUR Maple	3980	4355	4795	5562	6367	7172	7976	8782	10106		
	Three-Seat, Full Urethane Arm											
	JOR3-3FUR Beech/Urethane	3944	4318	4759	5527	6332	7136	7941	8744	10067		
	JOR3-3FUR Maple	4002	4377	4817	5584	6389	7194	7998	8804	10128		
	Three-Seat, Wood Arm											
	JOR3-3WOD Beech/Urethane	4049	4423	4864	5632	6436	7241	8045	8849	10172		
	JOR3-3WOD Maple	4107	4482	4922	5689	6494	7299	8103	8909	10233		
	Three-Seat, Wood Arm with Urethane Arm Cap											
	JOR3-3URE Beech/Urethane	4179	4552	4993	5761	6565	7371	8174	8978	10301		
	JOR3-3URE Maple	4236	4611	5051	5818	6623	7427	8233	9037	10361		

Jordan Option Upcharges	\$ List	\$ List
CAL 133 & Moisture Barrier (per yard)	64	Solid Surface Arm Cap (per pair) - Gr A White
Removable Seat Cover - Two-seat	318	Solid Surface Arm Cap (per pair) - Gr A Color
Removeable Back Covers - Two-Seat	318	Solid Surface Arm Cap (per pair) - Gr B
Non-Marring Glide	37	Solid Surface Arm Cap (per pair) - Gr C
Combination Upholstery - dual fabrics	33	
Combination Upholstery -Three fabrics	64	

ORDERING NOTES:

Jordan lounge chairs are available with Black, Grey or Taupe Urethane legs at no additional charge.

PRODUCT CODE KEY

Line	Series	Size	Arm Types
JOR	3	3	UPH
Jordan	Lounge Seating	Three-Seat	Upholstered Arm
			UUR
			Upholstered Arm with Urethane Arm Cap
			FUR
			Full Urethane Arm
			WOD
			Wood Arm
			URE
			Wood Arm with Urethane Arm Cap
			USS
			Upholstered Arm with Solid Surface Arm Cap
			SSC
			Wood Arm with Solid Surface Arm Cap

LEED CI CREDITS



MATERIAL CONTENT:

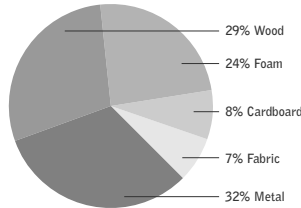

PRE-CONSUMER
RECYCLED CONTENT = 3.96%

POST-CONSUMER
RECYCLED CONTENT = 14.38%

Up to 37.5% of Carlyle product is recyclable at the end of its useful life.

CONTRIBUTES TO

CREDIT 2.1 - 2.2	Construction Waste Management	1-2 point(s)
CREDIT 3.3	Resource Reuse	1 point
CREDIT 4.1	Recycled Content	1 point
CREDIT 4.5	Low Emitting Materials, Systems & Seating	1 point
CREDIT 5.1	Regional Materials*	1 point
CREDIT 7	Certified Wood (MUST BE REQUESTED)	1 point(s)

*This credit is only applicable if in total 20% of the combined value of the procurement of construction materials and in the furniture are manufactured within a radius of 500 miles. This credit will apply if the installation of the finished product occurs within 500 miles of Kitchener, Ontario.

level® CERTIFICATION, AIR EMISSIONS AND FSC® CERTIFICATION



level® CERTIFICATION

BIFMA's e3 Furniture Sustainability Standard is a voluntary, multi-attribute standard that measures the degree of sustainability of furniture. This standard evaluates product and company environmental attributes and compliance systems in a wide range of elements which include Materials, Energy & Atmosphere, Human & Ecosystem Health and Social Responsibility. Carlyle products have earned level®, BIFMA's sustainability certification program for furniture, certification through third-party verification against the e3 standard.

AIR-EMISSIONS

All Carlyle products are supplied with air-emissions certified. Contact customer service for information.



FSC®

In 2005, Krug received Forest Stewardship Council® (FSC®) Chain-of-Custody certification for our manufacturing facilities. The FSC® Chain-of-Custody tracks certified wood from seedling to final sale. It verifies that the material for our FSC® certified products only come from well-managed, FSC®-certified forests and other controlled sources. FSC® is dedicated to the promotion of responsible forest management worldwide helping to take care of forests for future generations. Carlyle and other Krug products can be specified with FSC® Certification. Contact customer service for further information, pricing and lead times.



Architects, designers, and building professionals can specify FSC®-certified products in order to achieve a point from the U.S. Green Building Council's Leadership in Energy and Environmental Design (LEED) Rating System.

CARLYLE | LOUNGE

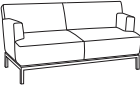
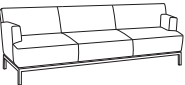
DESCRIPTION/MODEL/FINISHES	COM		COL		FABRIC GRADES			LEATHER			
	1	2	3	4	5	6	7	8	9		
	ONE-SEAT CAR311	Cherry, Maple, Walnut, Anigre	3519	3633	3742	3962	4183	4406	4631	5035	5729
	CAR312	Silver Metallic	3519	3633	3742	3962	4183	4406	4631	5035	5729
	TWO-SEAT CAR321	Cherry, Maple, Walnut, Anigre	4752	4919	5083	5363	5640	5918	6192	6795	7915
	CAR322	Silver Metallic	4752	4919	5083	5363	5640	5918	6192	6795	7915
	THREE-SEAT CAR331	Cherry, Maple, Walnut, Anigre	6406	6611	6814	7184	7556	7924	8296	9037	10424
	CAR332	Silver Metallic	6406	6611	6814	7184	7556	7924	8296	9037	10424

DIMENSIONS & COM REQUIREMENTS

	Overall Width	Overall Depth	Overall Height	Seat Height	Height of Arms from Floor	Width between Arms	Seat Depth	Shipping Weight	Cube	COM Yardage
CAR311	33	30	32	17.5	26	20	22	60	24	4.5
CAR312	33	30	32	17.5	26	20	22	60	24	4.5
CAR321	59.5	30	32	17.5	26	47	22	94	43	7.25
CAR322	59.5	30	32	17.5	26	47	22	94	43	7.25
CAR331	84	30	32	17.5	26	70.5	22	135	62	9.0
CAR332	84	30	32	17.5	26	70.5	22	135	62	9.0

ORDERING NOTES

Carlyle Lounge Chairs are available with a removable upholstered seat cover at an upcharge of **\$159 list** per one-seater chair, **\$318 list** per two-seater chair and **\$477 list** per three-seater chair.

PRODUCT CODE KEY

Line	Series	Seat Count	Base Style
CAR	3	1	1
Carlyle	Soft Seating	One-Seat	Wood Base & Legs
		2	2
		Two-Seat	Metal Base & Legs
		3	
		Three-Seat	

STANDARD FINISHES

For a complete list of standard wood finishes please see page 630.

CARLYLE LOUNGE

Carlyle is available in both wood base and Silver Metallic base versions.

MOISTURE BARRIER & CAL 133

Moisture Barrier & CAL 133 is available for an upcharge of **\$64 list** per yard.

BENCHES

323 Tate
329 Zola
339 Jordan
342 Carlyle

TATE BENCH | ENVIRONMENTAL SUMMARY

LEED CI CREDITS

MATERIAL CONTENT:

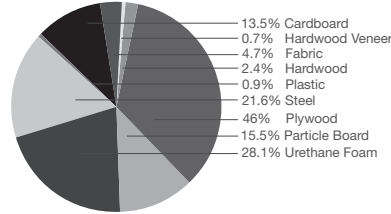

PRE-CONSUMER
RECYCLED CONTENT = 9.09%

POST-CONSUMER
RECYCLED CONTENT = 24.26%

Up to 26.97% of this Tate product is recyclable at the end of its useful life.

CONTRIBUTES TO

CREDIT 2.1 - 2.2	Construction Waste Management	1-2 point(s)
CREDIT 3.3	Resource Reuse	1 point
CREDIT 4.1	Recycled Content	1 point
CREDIT 4.2	Recycled Content	1 point
CREDIT 4.5	Low Emitting Materials, Systems & Seating	1 point
CREDIT 5.1	Regional Materials*	1 point
CREDIT 7	Certified Wood (MUST BE REQUESTED)	1 point(s)

*This credit is only applicable if in total 20% of the combined value of the procurement of construction materials and in the furniture are manufactured within a radius of 500 miles. This credit will apply if the installation of the finished product occurs within 500 miles of Kitchener, Ontario.

level® CERTIFICATION, AIR EMISSIONS AND FSC® CERTIFICATION



level® CERTIFICATION

BIFMA's e3 Furniture Sustainability Standard is a voluntary, multi-attribute standard that measures the degree of sustainability of furniture. This standard evaluates product and company environmental attributes and compliance systems in a wide range of elements which include Materials, Energy & Atmosphere, Human & Ecosystem Health and Social Responsibility. Tate products have earned level®, BIFMA's sustainability certification program for furniture, certification through third-party verification against the e3 standard.

AIR-EMISSIONS

All Tate products are supplied with air-emissions certified. Contact customer service for information.



FSC®

In 2005, Krug received Forest Stewardship Council® (FSC®) Chain-of-Custody certification for our manufacturing facilities. The FSC® Chain-of-Custody tracks certified wood from seedling to final sale. It verifies that the material for our FSC® certified products only come from well-managed, FSC®-certified forests and other controlled sources. FSC® is dedicated to the promotion of responsible forest management worldwide helping to take care of forests for future generations. Tate and other Krug products can be specified with FSC® Certification. Contact customer service for further information, pricing and lead times.



Architects, designers, and building professionals can specify FSC®-certified products in order to achieve a point from the U.S. Green Building Council's Leadership in Energy and Environmental Design (LEED) Rating System.

TATE BENCHES | FEATURES & OPTIONS

STYLE

Tate Bench features three design styles; Fully Upholstered, Gable End and Table End.



Fully Upholstered

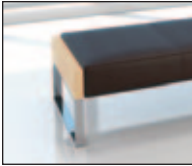

Gable End

Tate Bench gable ends are 2" wide x 20" deep x 6" high on standard depth units and 2" wide x 25" deep x 6" high on deep seat units

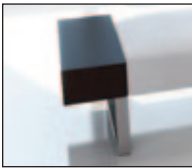

Table End

Tate Bench table ends are 10" wide x 20" deep x 6" high on standard depth units and 10" wide x 25" deep x 6" high on deep seat units.



LEGS

Tate Bench legs feature polished chrome structural steel legs with non-marring glides.

REPLACEABLE COMPONENTS

Tate Benches are uniquely designed to allow major components to be field replaced, providing a very cost effective means to significantly extend the life of the product. Gable ends, table ends and legs are field replaceable.

WEIGHT CAPACITIES

Tate Bench have the following maximum weight ratings:

2 seater - 975 lbs

3 seater - 1,200 lbs

OPTIONS

REMOVABLE COVERS

Optional Removeable covers can be quickly installed on Tate Bench products that were originally ordered with the Removable cover option. Replacement covers can also be installed on Tate Bench products that were not originally ordered with the Removable cover option, with some simple staple removal.

CAL 133 & MOISTURE BARRIER

California Technical Bulletin 133 is a flammability test for seating. Krug offers a compliance method which, in combination with non-flammable upholstery covers, may enable the products to meet certification requirements for this test. This process at the same time also provides the products with a Moisture Barrier - a treatment that helps to prevent the passage of liquids and moisture to inside of upholstered components - thereby conferring sanitary and anti-infection benefits. So when CAL 133 is specified, the product also automatically has a Moisture Barrier, and when a Moisture Barrier is specified, the product also features the compliance method and low flammability features of CAL 133. CAL 133 and Moisture Barrier are available for an upcharge of **\$64 list** per yard.

The application of this upcharge and the compliance method does not mean that the specific configuration of product and upholstery cover are tested and officially certified as being CAL 133 compliant. If official certification is required, Krug will provide this (through an independent certified testing laboratory) at a charge of \$917 per item, plus the cost of the product to be tested. Lead time for certification testing is typically 4-8 weeks. Krug assumes no responsibility for the testing of our products in combination with upholstery covers, or for the results of any testing conducted. Some specific configurations of product and upholstery have already been tested. Please contact Customer Service for additional information.

DIMENSIONS & COM REQUIREMENTS

	Overall Length	Overall Depth	Overall Height	Seat Length	Shipping Weight	Cube	COM Yardage
TAT5-2210	43	21	17	43	48	10.7	1.4
TAT5-2260	43	26	17	43	57	13.2	1.6
TAT5-3210	65	21	17	65	62	15.7	2.0
TAT5-3260	65	26	17	65	74	19.4	2.3
TAT5-2211	47	21	17	43	56	10.7	1.4
TAT5-2261	47	26	17	43	65	13.2	1.6
TAT5-3211	69	21	17	65	70	15.7	2.0
TAT5-3261	69	26	17	65	82	19.4	2.3
TAT5-2212	63	21	17	43	70	14.3	1.4
TAT5-2262	63	26	17	43	83	17.7	1.6
TAT5-3212	84.5	21	17	65	84	19.2	2.0
TAT5-3262	84.5	26	17	65	100	23.8	2.3

DIMENSIONS:

All dimensions are in inches and approximate and are subject to change without notice. Contact Customer Service if dimensions are critical.

TATE BENCHES | VENEERS & FINISHES

WOOD FINISHES

Standard wood finishes are:

SPECIES	FINISH
OAK	Light Oak SilverGrey on Oak Espresso Oak
MAPLE	Clear Maple Wheat Maple
WALNUT	Natural Walnut SilverGrey on Walnut Regular Walnut Dark Walnut

PALETTE FINISHES

Black
White
Sand
Soft Green
Steel Blue
Slate

VENEERS

Tate Benches veneers are quarter cut, except for White Oak, which is rift cut - both quarter cut and rift cut veneers provide a straight grain appearance. The grain direction of the veneers on vertical faces is horizontal.

NON-STANDARD VENEER SPECIES

In addition to range of standard wood species, Tate can be made with virtually any commercially available veneers. Please contact customer service for information and pricing on wood species not included in Tate's standard offering.

NATURAL CHARACTERISTICS OF WOOD

Wood is a natural product with inherent color variations that will never be fully mitigated by the finishing process. Please anticipate variation in colors within a single unit, from piece to piece, and from Krug wood finish samples. If a very close match is required, a sample must be provided with the order and an upcharge will apply. Exact color matches are not possible.

CUSTOM WOOD FINISHES







Add 10% list to your order for special finishes, minimum upcharge is \$500 list per finish per order. (For example, on all orders up to \$5000 list, an upcharge of \$500 will apply, on orders \$5000 and up add 10% list to your order.)

For orders with special finishes, a sample that is a minimum 3" by 3" must be received with the order. Special finishes may add additional lead time to production schedules. Since wood is a natural product, some variations in grain, color and stain acceptance will occur. In our finishing processes, we try to minimize variations, but some variation between samples and finished goods should be anticipated.

ENDURAGUARD FINISH

Tate Benches features the Krug Enduraguard finish, a proprietary catalyzed varnish formulation, that has repeatedly shown through independent laboratory testing to be the industry leader in durability and abrasion resistance. The Krug finish looks better longer than competitors and is uniquely suited to the demands of high traffic environments.

TATE BENCHES | FULLY UPHOLSTERED & GABLE END

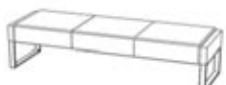
DESCRIPTION/MODEL	SPECIES	COM		COL	FABRIC GRADES			LEATHER		
		1	2	3	4	5	6	7	8	9
 Two-seat, 21", fully upholstered TAT5-2210		992	1042	1088	1152	1228	1294	1370	1463	1558
 Two-seat, 26", fully upholstered TAT5-2260		1107	1166	1227	1311	1409	1493	1589	1709	1832
 Three-seat, 21", fully upholstered TAT5-3210		1193	1258	1327	1420	1527	1620	1728	1861	1995
 Three-seat, 26", fully upholstered TAT5-3260		1315	1395	1478	1589	1717	1832	1959	2119	2281
 Two-seat, 21", gable end TAT5-2211	Maple, Oak, Laminate	1495	1538	1585	1645	1717	1780	1854	1941	2030
	Walnut, Palette	1572	1620	1667	1734	1809	1875	1951	2043	2136
 Two-seat, 26", gable end TAT5-2261	Maple, Oak, Laminate	1622	1678	1736	1817	1908	1989	2080	2195	2310
	Walnut, Palette	1708	1769	1828	1913	2010	2092	2191	2312	2432
 Three-seat, 21", gable end TAT5-3211	Maple, Oak, Laminate	1680	1746	1809	1898	1999	2089	2192	2319	2447
	Walnut, Palette	1771	1837	1905	1998	2106	2198	2307	2441	2576

Tate Bench Option Upcharges



	\$ List
CAL 133 & Moisture Barrier (per yard)	64
Two-seat, 21" - Removable Seat Covers	77
Two-seat, 26" - Removeable Seat Covers	80

	\$ List
Three-seat, 21" - Removable Seat Covers	97
Three-seat, 26" - Removable Seat Covers	101

PRODUCT CODE KEY

Line	Series	Seat Count	Seat Depth	Arm Style
TAT Tate	5 Bench	2 Two-Seat	21 21"	0 Fully Upholstered
		3 Three-Seat	26 26"	1 Gable End
				2 Table End

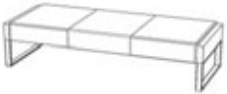
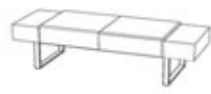
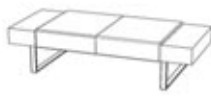
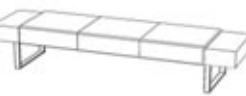
TATE BENCHES | GABLE END & TABLE END

DESCRIPTION/MODEL	SPECIES	COM		COL			FABRIC GRADES			LEATHER	
		1	2	3	4	5	6	7	8	9	
 Three-seat, 26", gable end TAT5-3261	Maple, Oak, Laminate	1832	1907	1984	2090	2212	2319	2443	2594	2746	
	Walnut, Palette	1926	2007	2087	2198	2327	2441	2569	2734	2892	
 Two-seat, 21", table end TAT5-2212	Maple, Oak, Laminate	2023	2066	2110	2173	2247	2308	2382	2470	2559	
	Walnut, Palette	2131	2174	2221	2287	2364	2431	2505	2597	2692	
 Two-seat, 26", table end TAT5-2262	Maple, Oak, Laminate	2196	2254	2312	2390	2486	2564	2657	2770	2884	
	Walnut, Palette	2313	2374	2433	2518	2614	2699	2795	2917	3037	
 Three-seat, 21", table end TAT5-3212	Maple, Oak, Laminate	2210	2274	2337	2427	2529	2618	2718	2848	2972	
	Walnut, Palette	2324	2391	2460	2554	2660	2756	2861	2996	3132	
 Three-seat, 26", table end TAT5-3262	Maple, Oak, Laminate	2407	2481	2560	2665	2789	2894	3016	3167	3322	
	Walnut, Palette	2532	2612	2694	2805	2934	3047	3175	3339	3497	







Tate Bench Option Upcharges

	\$ List		\$ List
CAL 133 & Moisture Barrier (per yard)	64	Three-seat, 21" - Removable Seat Covers	97
Two-seat, 21" - Removable Seat Covers	77	Three-seat, 26" - Removable Seat Covers	101
Two-seat, 26" - Removeable Seat Covers	80		

PRODUCT CODE KEY

Line	Series	Seat Count	Seat Style	Arm Style
TAT	5	2	21	0
Tate	Bench	Two-Seat	21"	Fully Upholstered
		3	26	1
		Three-Seat	26"	Gable End
				2
				Table End

TATE BENCHES | REPLACEMENT COMPONENTS

DESCRIPTION/MODEL	COM		COL	FABRIC GRADES			LEATHER			WEIGHT	CUBE		
	1	2	3	4	5	6	7	8	9				
	Two-seat, 21" Replacement Seat TAT5-RS221		766	812	861	928	1002	1065	1141	1237	1331	34	4.5
	Two-seat, 26" Replacement Seat TAT5-RS226		832	883	937	1014	1096	1172	1260	1367	1477	43	5.5
	Three-seat, 21" Replacement Seat TAT5-RS321		961	1031	1096	1193	1298	1393	1440	1634	1769	52	6
	Three-seat, 26" Replacement Seat TAT5-RS326		1045	1121	1201	1307	1431	1538	1663	1817	1970	74	7.3
	Two-seat, 21" Replacement Seat Cover TAT5-RSC221		302	350	397	460	537	602	678	771	868	5	1.0
	Two-seat, 26" Replacement Seat Cover TAT5-RSC226		328	382	434	511	596	670	757	866	973	6	1.2
	Three-seat, 21" Replacement Seat Cover TAT5-RSC321		391	458	527	620	729	821	929	1063	1198	7	1.5
	Three-seat, 26" Replacement Seat Cover TAT5-RSC326		424	501	580	687	809	916	1042	1197	1349	8	1.7
	Replacement Gable End 21" TAT5-RGE21		Maple, Oak, Laminate		365						4		.30
			Walnut, Palette		437								
	Replacement Gable End 26" TAT5-RGE26		Maple, Oak, Laminate		409						5		.50
			Walnut, Palette		515								
	Replacement Table End 21" TAT5-RTE21		Maple, Oak, Laminate		615						11		1.1
			Walnut, Palette		752								
	Replacement Table End 26" TAT5-RTE26		Maple, Oak, Laminate		672						13		1.3
			Walnut, Palette		815								
	21" Replacement Legs TAT5-RL21				183						7		1.1
	26" Replacement Legs TAT5-RL26				199						9		1.5

ZOLA BENCH | ENVIRONMENTAL SUMMARY

LEED CI CREDITS



MATERIAL CONTENT:

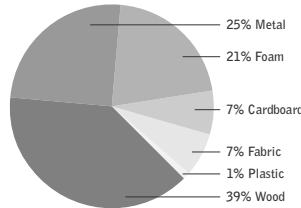

PRE-CONSUMER
RECYCLED CONTENT = 6.43%

POST-CONSUMER
RECYCLED CONTENT = 16.25%

Up to 38.93% of this Zola product is recyclable at the end of its useful life.

CONTRIBUTES TO

CREDIT 2.1 - 2.2	Construction Waste Management	1-2 point(s)
CREDIT 3.3	Resource Reuse	1 point
CREDIT 4.1	Recycled Content	1 point
CREDIT 4.5	Low Emitting Materials, Systems & Seating	1 point
CREDIT 5.1	Regional Materials*	1 point
CREDIT 7	Certified Wood (MUST BE REQUESTED)	1 point(s)

*This credit is only applicable if in total 20% of the combined value of the procurement of construction materials and in the furniture are manufactured within a radius of 500 miles. This credit will apply if the installation of the finished product occurs within 500 miles of Kitchener, Ontario.

level® CERTIFICATION, AIR EMISSIONS AND FSC® CERTIFICATION



level® CERTIFICATION

BIFMA's e3 Furniture Sustainability Standard is a voluntary, multi-attribute standard that measures the degree of sustainability of furniture. This standard evaluates product and company environmental attributes and compliance systems in a wide range of elements which include Materials, Energy & Atmosphere, Human & Ecosystem Health and Social Responsibility. Zola products have earned level®, BIFMA's sustainability certification program for furniture, certification through third-party verification against the e3 standard.

AIR-EMISSIONS

All Zola products are supplied with air-emissions certified. Contact customer service for information.



FSC®

In 2005, Krug received Forest Stewardship Council® (FSC®) Chain-of-Custody certification for our manufacturing facilities. The FSC® Chain-of-Custody tracks certified wood from seedling to final sale. It verifies that the material for our FSC® certified products only come from well-managed, FSC®-certified forests and other controlled sources. FSC® is dedicated to the promotion of responsible forest management worldwide helping to take care of forests for future generations. Zola and other Krug products can be specified with FSC® Certification. Contact customer service for further information, pricing and lead times.



Architects, designers, and building professionals can specify FSC®-certified products in order to achieve a point from the U.S. Green Building Council's Leadership in Energy and Environmental Design (LEED) Rating System.

ZOLA | MODULAR & MODULAR PLUS BENCH STANDARD DEPTH

DIMENSIONS

	Overall Width	Overall Depth	Overall (Seat) Height	Shipping Weight	Cubes
One-Seat	23	22.25	18.5	28	5.2
Two-seat	46	22.25	18.5	48	9.4
Three-seat	69	22.25	18.5	64	14
One-Seat (Plus)	30	22.25	18.5	31	6.1
Two-seat (Plus)	46	22.25	18.5	48	9.4
Three-seat (Plus)	69	22.25	18.5	64	14

COM YARDAGES

	COM Yardage Bench	COM Yardage 2 Benches	COM Yardage 3 Benches	COM Yardage 4 Benches
One-Seat	1.25	2	2.75	4
Two-seat	1.70	3.5	4.91	6.6
Three-seat	2.5	4.5	7	8.9
One-Seat (Plus)	1.25	2.6	3.98	5.3

To calculate the COM Yardage for more than 4 units, take the largest multiple (4 units) and add the closest remainder. See below for example calculations.

5 Units = Take the yardage for 4 units and add the yardage for 1 unit

7 Units = Take the yardage for 4 units and add the yardage for 3 units

8 Units = Take the yardage for 4 units and multiple by 2

9 Units = Take the yardage for 4 units, multiply by 2, add yardage for 1 unit

10 Units = Take the yardage for 4 units, multiply by 2, add yardage for 2 units

20 Units = Take the yardage for 4 units, multiply by 5

ZOLA | MODULAR & MODULAR PLUS BENCH FULL DEPTH

DIMENSIONS

	Overall Width	Overall Depth	Seat Height	Shipping Weight	Cubes
One-Seat	23	26	18.5	33	11.5
Two-seat	46	26	18.5	55	21
Three-seat	69	26	18.5	72	32
One-Seat (Plus)	30	26	18.5	45	16
Two-seat (Plus)	46	26	18.5	57	21
Three-seat (Plus)	69	26	18.5	75	32

COM YARDAGES

	COM Yardage Bench	COM Yardage 2 Benches	COM Yardage 3 Benches	COM Yardage 4 Benches
One-Seat	1.4	2.2	3.6	4.4
Two-seat	1.85	3.7	5.6	7.4
Three-seat	2.8	5.6	8.4	11.2
One-Seat (Plus)	1.85	3.7	5.6	7.4
Two-seat (Plus)	1.85	3.7	5.6	7.4
Three-seat (Plus)	2.8	5.6	8.4	11.2

To calculate the COM Yardage for more than 4 units, take the largest multiple (4 units) and add the closest remainder. See below for example calculations.

5 Units = Take the yardage for 4 units and add the yardage for 1 unit

7 Units = Take the yardage for 4 units and add the yardage for 3 units

8 Units = Take the yardage for 4 units and multiple by 2

9 Units = Take the yardage for 4 units, multiply by 2, add yardage for 1 unit







10 Units = Take the yardage for 4 units, multiply by 2, add yardage for 2 units

20 Units = Take the yardage for 4 units, multiply by 5

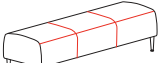

Upcharge for Removable Upholstery Covers:

Option	\$ List	Option	\$ List
Arms (Right or Left)	77	One-Seat standard depth seat	47
Interim Arm	61	Two-seat standard depth seat	68
One-Seat back	68	Three-seat standard depth seat	85
Two-seat back	97	One-Seat plus standard depth seat	61
Three-seat back	121	One-Seat full depth seat	52
One-Seat plus back	78	Two-seat full depth seat	74
		Three-seat full depth seat	85
		One-Seat plus full depth seat	67

ZOLA | MODULAR & MODULAR PLUS BENCH STANDARD DEPTH

DESCRIPTION/MODEL	COM		COL	FABRIC GRADES			LEATHER			
	1	2	3	4	5	6	7	8	9	
 One-Seat ZOL3 MS1S1	871	916	963	1053	1139	1227	1314	1398	1535	
 One-Seat Plus ZOL3 MSB1S1	1098	1146	1195	1289	1384	1480	1572	1668	1810	
ORDERING NOTES: One-Seat Plus Bench is 30" wide.										
 Two-Seat ZOL3 MS2S1	1218	1272	1330	1447	1566	1685	1803	1922	2118	
 Two-Seat Plus ZOL3 MSB2S1	1297	1359	1422	1540	1662	1778	1897	2017	2214	
ORDERING NOTES: The Two-Seat Plus comes standard with a fifth leg for extra support.										
 Three-Seat ZOL3 MS3S1	1558	1638	1715	1883	2048	2214	2381	2548	2748	
 Three-Seat Plus ZOL3 MSB3S1	1852	1928	2010	2148	2294	2434	2579	2718	2946	
ORDERING NOTES: The Three-Seat Plus comes standard with a fifth leg for extra support.										

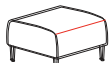
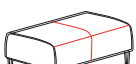
ZOLA | MODULAR & MODULAR PLUS BENCH FULL DEPTH

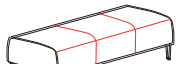
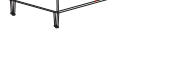
DESCRIPTION/MODEL	COM		COL	FABRIC GRADES			LEATHER			
	1	2	3	4	5	6	7	8	9	
 One-Seat ZOL3 MS1F1	961	1011	1058	1121	1198	1263	1336	1431	1555	
 One-Seat Plus ZOL3 MSB1F1	1158	1222	1284	1371	1467	1557	1657	1778	1905	
ORDERING NOTES: One-Seat Plus Bench is 30" wide.										
 Two-Seat ZOL3 MS2F1	1420	1482	1545	1632	1730	1817	1918	2040	2166	
 Two-Seat Plus ZOL3 MSB2F1	1474	1536	1597	1685	1781	1870	1968	2238	2218	
ORDERING NOTES: The Two-Seat Plus comes standard with a fifth leg for extra support.										
 Three-Seat ZOL3 MS3F1	1921	2016	2108	2236	2388	2522	2671	2859	3047	
 Three-Seat Plus ZOL3 MSB3F1	1988	2085	2176	2310	2460	2591	2742	2928	3117	
ORDERING NOTES: The Three-Seat Plus comes standard with a fifth leg for extra support.										

ORDERING NOTES: Zola Bench Seating is available with 4 casters, for an upcharge of **\$107 list** per chair. Please add a '2' at the end of the model number for casters ie; ZOL31112. Zola Bench Seating is available with 2 legs and 2 casters version, for an upcharge of **\$77 list** per chair. Please add a '3' at the end of the model number for leg/caster version ie; ZOL3F1113. Please note, plus versions are not available with caster options.

PRODUCT CODE KEY

Line	Series	Chair Type	Seat Count	Seat Depth	Leg Type
ZOL Zola	3 Soft Seating	MS Modular	1 One Seat	S Standard Depth	1 Standard Leg & Glide
		MSB Modular Plus	2 Two Seat	F Full Depth	2 Casters
			3 Three Seat		3 2 Legs & 2 Casters

ZOLA | MODULAR CURVE BENCH

DIMENSIONS INSIDE CURVE

	Overall Width	Overall Depth	Seat Height	Seat Depth	Shipping Weight	Cubes
Single seat						
30°	36	28.5	18.5	22.5	50	18
45°	42	29	18.5	22.5	54	19
60°	48	29	18.5	22.5	57	22
90°	59	31	18.5	22.5	69	26
Double seat						
30°	58	30	18.5	22.5	90	32
45°	64	31	18.5	22.5	97.2	33
60°	70	33	18.5	22.5	102.6	39
90°	81	36	18.5	22.5	124.2	46

COM Yardages

	COM Yardage Entire Unit	COM Yardage 2 Entire Units	COM Yardage 3 Entire Units	COM Yardage 4 Entire Units
Single seat				
30°	3.70	7.4	11.1	14.8
45°	4.40	8.8	13.2	17.6
60°	4.40	8.8	13.2	17.6
90°	4.61	9.2	13.83	18.44
Double seat				
30°	6.3	12.6	18.9	25.2
45°	6.4	12.8	19.2	25.6
60°	8.2	16.4	24.6	32.8
90°	8.2	16.4	24.6	32.8

COM Yardages - Individual Components

	COM Yardage Per Seat	COM Yardage Per 2 Seats	COM Yardage Per 3 Seats	COM Yardage Per 4 Seats
Single seat				
30°	1.8	3.6	5.4	7.2
45°	1.8	3.6	5.4	7.2
60°	1.8	3.6	5.4	7.2
90°	1.8	3.6	5.4	7.2
Double seat				
30°	3.4	6.8	10.2	13.6
45°	3.4	6.8	10.2	13.6
60°	3.4	6.8	10.2	13.6
90°	3.4	6.8	10.2	13.6

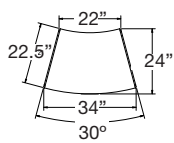

One-Seat, Uph 30° Inside Curve

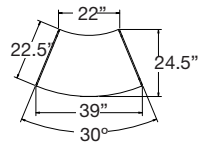

One-Seat, Uph 45° Inside Curve

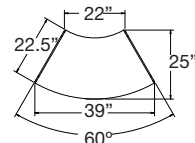

One-Seat, Uph 60° Inside Curve

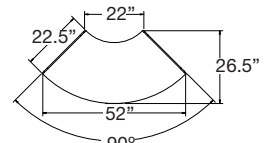

One-Seat, Uph 90° Inside Curve

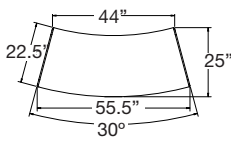

Two-Seat, Uph 30° Inside Curve

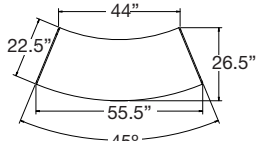

Two-Seat, Uph 45° Inside Curve

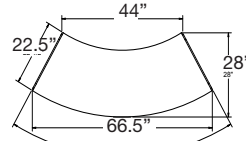

Two-Seat, Uph 60° Inside Curve

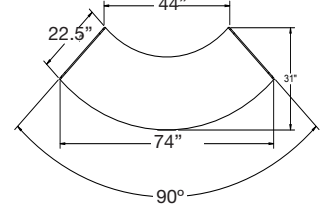

Two-Seat, Uph 90° Inside Curve

Upcharge for Removable Upholstery Covers:

Option	\$ List	Option	\$ List
Single-seat curve 30° seat	61	Double-seat curve 30° seat	93
Single-seat curve 45° seat	64	Double-seat curve 45° seat	101
Single-seat curve 60° seat	86	Double-seat curve 60° seat	123
Single-seat curve 90° seat	113	Double-seat curve 90° seat	126

ZOLA | MODULAR CURVE BENCH

DIMENSIONS OUTSIDE CURVE

	Overall Width	Overall Depth	Seat Height	Seat Depth	Shipping Weight	Cubes
Single seat						
30°	33.75	28.25	18.5	22.5	48	23
45°	38.75	28.75	18.5	22.5	49	24
60°	43.5	29.25	18.5	22.5	50	29
90°	52	29.75	18.5	22.5	51	34
Double seat						
30°	55.75	29.75	18.5	22.5	83	36
45°	60.75	31	18.5	22.5	84	40
60°	65.75	32.25	18.5	22.5	86	45
90°	74	34.5	18.5	22.5	96	56

COM Yardages

	COM Yardage Entire Unit	COM Yardage 2 Entire Units	COM Yardage 3 Entire Units	COM Yardage 4 Entire Units
Single seat				
30°	3.32	6.14	9.46	12.28
45°	3.32	6.14	9.46	12.28
60°	3.32	6.14	9.46	12.28
90°	3.32	6.14	9.46	12.28
Double seat				
30°	6.50	13.0	19.5	26.0
45°	6.50	13.0	19.5	26.0
60°	6.50	13.0	19.5	26.0
90°	6.50	13.0	19.5	26.0

COM Yardages - Individual Components

	COM Yardage Per Back	COM Yardage Per 2 Backs	COM Yardage Per 3 Backs	COM Yardage Per 4 Backs	COM Yardage Per Seat	COM Yardage Per 2 Seats	COM Yardage Per 3 Seats	COM Yardage Per 4 Seats
Single seat								
30°	1.7	2.95	4.65	5.9	1.8	3.6	5.4	7.2
45°	1.7	2.95	4.65	5.9	1.8	3.6	5.4	7.2
60°	1.7	2.95	4.65	5.9	1.8	3.6	5.4	7.2
90°	1.7	2.95	4.65	5.9	1.8	3.6	5.4	7.2
Double seat								
30°	3.1	6.2	9.3	12.4	3.4	6.8	10.2	13.6
45°	3.1	6.2	9.3	12.4	3.4	6.8	10.2	13.6
60°	3.1	6.2	9.3	12.4	3.4	6.8	10.2	13.6
90°	3.1	6.2	9.3	12.4	3.4	6.8	10.2	13.6

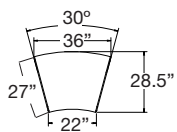

One-Seat, Uph 30° Curve

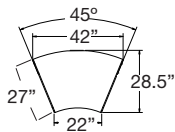

One-Seat, Uph 45° Curve

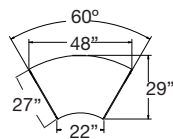

One-Seat, Uph 60° Curve

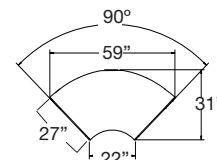

One-Seat, Uph 90° Curve

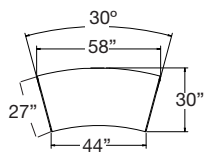

Two-Seat, Uph 30° Curve

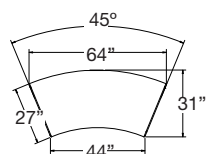

Two-Seat, Uph 45° Curve

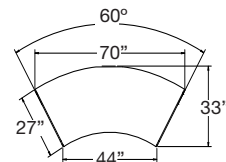

Two-Seat, Uph 60° Curve

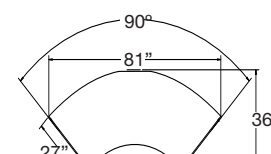









Two-Seat, Uph 90° Curve

Upcharge for Removable Upholstery Covers:

Option	\$ List	Option	\$ List
Single-seat curve 30° seat	61	Double-seat curve 30° seat	93
Single-seat curve 45° seat	64	Double-seat curve 45° seat	101
Single-seat curve 60° seat	86	Double-seat curve 60° seat	123
Single-seat curve 90° seat	113	Double-seat curve 90° seat	126

ZOLA | MODULAR CURVE BENCH



DESCRIPTION/MODEL	COM		COL			FABRIC GRADES			LEATHER	
	1	2	3	4	5	6	7	8	9	
 Single-Seat, 30° Curve, Standard Depth ZOL3 MCS30DS1	1251	1361	1478	1634	1813	1970	2149	2378	2602	
 Single-Seat, 45° Curve, Standard Depth ZOL3 MCS45DS1	1361	1528	1691	1922	2186	2415	2678	3008	3336	
 Single-Seat, 60° Curve, Standard Depth ZOL3 MCS60DS1	1539	1705	1869	2100	2360	2591	2854	3184	3513	
 Single-Seat, 90° Curve, Standard Depth ZOL3 MCS90DS1	1776	1956	2136	2390	2681	2934	3222	3587	3949	
 Single-Seat, 30° Curve, Full Depth ZOL3 MCS30DF1	1376	1499	1623	1797	1995	2168	2368	2613	2861	
 Single-Seat, 45° Curve, Full Depth ZOL3 MCS45DF1	1501	1680	1861	2113	2405	2657	2946	3307	3669	
 Single-Seat, 60° Curve, Full Depth ZOL3 MCS60DF1	1693	1875	2056	2308	2596	2851	3138	3501	3864	
 Single-Seat, 90° Curve, Full Depth ZOL3 MCS90DF1	1954	2149	2352	2631	2948	3229	3545	3946	4343	

ORDERING NOTES: Please note when Zola Modular Benches are ordered, each bench is automatically supplied with two seat to seat brackets (ZOL3 RLKB2). All Modular Units, and tables will be shipped KD (knocked down). Modular Curved Benches are offered in two depths. For a flush edge when joining a Modular Curved Bench to Modular seat with back choose the Full Depth.

PRODUCT CODE KEY

Line	Series	Chair Type	Seat Count	Seat Degree	Seat Depth	Leg Type
ZOL Zola	3 Soft Seating	MC Modular	S Single	30D 30 Degree	S Standard	1 Standard Leg + Glide
		MCB Modular Plus	D Double	45D 45 Degree	F Full	
				60D 60 Degree		
				90D 90 Degree		

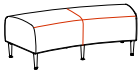
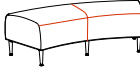
ZOLA | MODULAR CURVE BENCH

DESCRIPTION/MODEL	COM		COL			FABRIC GRADES			LEATHER	
	1	2	3	4	5	6	7	8	9	
 Double-Seat, 30° Curve, Standard Depth ZOL3 MCD30DS1	2190	2385	2584	2858	3173	3452	3766	4160	4555	
 Double-Seat, 45° Curve, Standard Depth ZOL3 MCD45DS1	2385	2672	2959	3363	3820	4223	4684	5259	5834	
 Double-Seat, 60° Curve, Standard Depth ZOL3 MCD60DS1	2694	2983	3269	3671	4131	4533	4994	5569	6142	
 Double-Seat, 90° Curve, Standard Depth ZOL3 MCD90DS1	3105	3424	3740	4184	4691	5135	5640	6273	6909	

Upcharge for Removable Upholstery Covers:

Option	\$ List
Double-seat curve 30° seat	93
Double-seat curve 45° seat	101
Double-seat curve 60° seat	123
Double-seat curve 90° seat	127

ORDERING NOTES: Please note when Zola Modular Benches are ordered, each bench is automatically supplied with two seat to seat brackets (ZOL3 RLKB2). All Modular Units, and tables will be shipped KD (knocked down). Modular Curved Benches are offered in two depths. For a flush edge when joining a Modular Curved Bench to Modular seat with back choose the Full Depth.

PRODUCT CODE KEY

Line	Series	Chair Type	Seat Count	Seat Degree	Seat Depth	Leg Type
ZOL Zola	3 Soft Seating	MC Modular	S Single	30D 30 Degree	S Standard	1 Standard Leg + Glide
		MCB Modular Plus	D Double	45D 45 Degree	F Full	
				60D 60 Degree		
				90D 90 Degree		

ZOLA | MODULAR CURVE BENCH

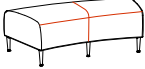
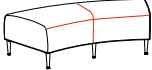
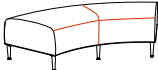
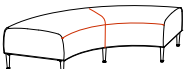
DESCRIPTION/MODEL	COM		COL	FABRIC GRADES			LEATHER		
	1	2	3	4	5	6	7	8	9
 Double-Seat, 30° Curve, Full Depth ZOL3 MCD30DF1	2516	2742	2969	3287	3648	3966	4331	4784	5236
 Double-Seat, 45° Curve, Full Depth ZOL3 MCD45DF1	2742	3073	3403	3866	4395	4859	5388	6048	6709
 Double-Seat, 60° Curve, Full Depth ZOL3 MCD60DF1	3099	3429	3760	4221	4752	5214	5742	6405	7066
 Double-Seat, 90° Curve, Full Depth ZOL3 MCD90DF1	3573	3935	4297	4812	5393	5904	6486	7215	7945

Upcharge for Removable Upholstery Covers:









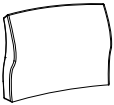

Option	\$ List
Double-seat curve 30° seat	93
Double-seat curve 45° seat	101
Double-seat curve 60° seat	123
Double-seat curve 90° seat	127

ORDERING NOTES: Please note when Zola Modular Benches are ordered, each bench is automatically supplied with two seat to seat brackets (ZOL3 RLKB2). All Modular Units, and tables will be shipped KD (knocked down). Modular Curved Benches are offered in two depths. For a flush edge when joining a Modular Curved Bench to Modular seat with back choose the Full Depth.



PRODUCT CODE KEY

Line	Series	Chair Type	Seat Count	Seat Degree	Seat Depth	Leg Type
ZOL Zola	3 Soft Seating	MC Modular	S Single	30D 30 Degree	S Standard	1 Standard Leg + Glide
		MCB Modular Plus	D Double	45D 45 Degree	F Full	
				60D 60 Degree		
				90D 90 Degree		

ZOLA | MODULAR CURVE BENCH - REPLACEMENT COMPONENTS

DESCRIPTION	MODEL	COM		COL			FABRIC GRADES			LEATHER			COM	YARDAGE	WEIGHT	CUBE
		1	2	3	4	5	6	7	8	9						
	Replacement Back Single-seat Inside Curve															
	ZOL3 RMCBIS30D	1168	1247	1330	1443	1569	1686	1815	1977	2136	1.9	20	8			
	ZOL3 RMCBIS45D	1355	1443	1533	1659	1801	1924	2066	2244	2423	2.6	22	8			
	ZOL3 RMCBIS60D	1647	1772	1893	2064	2257	2431	2628	2870	3113	2.6	23	10			
	ZOL3 RMCBIS90D	1841	1967	2094	2272	2476	2652	2854	3109	3363	2.8	28	11			
	Replacement Back Double-seat Inside Curve															
	ZOL3 RMCBID30D	2042	2185	2324	2524	2747	2947	3172	3456	3739	2.8	38	13			
	ZOL3 RMCBID45D	2369	2524	2681	2898	3147	3367	3617	3929	4239	3	42	13.5			
	ZOL3 RMCBID60D	2884	3099	3313	3610	3954	4252	4595	5022	5448	4.8	43	16			
	ZOL3 RMCBID90D	3220	3444	3665	3975	4331	4641	4995	5440	5884	4.8	52.5	18			
	Replacement Back Single-seat Outside Curve															
	ZOL3 RMCBOS30D	1053	1122	1197	1298	1415	1515	1633	1778	1923	1.7	15	5.0			
	ZOL3 RMCBOS45D	1218	1298	1380	1492	1620	1732	1861	2020	2182	1.7	17	7.0			
	ZOL3 RMCBOS60D	1458	1593	1704	1858	2033	2190	2361	2584	2803	1.7	20	9.0			
	ZOL3 RMCBOS90D	1659	1772	1885	2045	2228	2386	2569	2798	3028	1.7	25	9.0			
	Replacement Back Double-seat Outside Curve															
	ZOL3 RMCBOD30D	1839	1965	2092	2271	2473	2652	2857	3111	3366	3.1	30	9.0			
	ZOL3 RMCBOD45D	2133	2272	2412	2610	2833	3030	3252	3535	3816	3.1	34	11.0			
	ZOL3 RMCBOD60D	2596	2789	2983	3249	3559	3827	4133	4520	4903	3.1	35	14.0			
	ZOL3 RMCBOD90D	2898	3099	3299	3578	3896	4177	4498	4897	5295	3.1	40	14.0			
	Replacement Seat Single-seat Standard Depth Curve															
	ZOL3 RMCSS30DS	1143	1258	1372	1529	1708	1866	2046	2272	2496	1.8	30	11			
	ZOL3 RMCSS45DS	1258	1421	1443	1816	2080	2312	2570	2902	3231	1.8	32	12			
	ZOL3 RMCSS60DS	1437	1598	1765	1993	2255	2487	2747	3077	3408	1.8	34	13			
	ZOL3 RMCSS90DS	1636	1816	1998	2252	2539	2794	3082	3446	3809	1.8	41	16			
	Replacement Seat Double-seat Standard Depth Curve															
	ZOL3 RMCSD30DS	2084	2280	2478	2751	3069	3344	3662	4057	4449	3.4	52.2	19.5			
	ZOL3 RMCSD45DS	2280	2567	2854	3257	3714	4118	4579	5605	5727	3.4	56	21			
	ZOL3 RMCSD60DS	2589	2878	3163	3565	4027	4427	4888	5464	6039	3.4	60	23			
	ZOL3 RMCSD90DS	2966	3283	3602	4042	4551	4994	5502	6136	6767	3.4	72	28			
	Replacement Seat Single-seat Full Depth Curve															
	ZOL3 RMCSS30DF	1270	1393	1518	1691	1890	2063	2263	2507	2757	1.94	36	13.5			
	ZOL3 RMCSS45DF	1394	1573	1755	2010	2298	2552	2839	3202	3563	1.94	39	14.5			
	ZOL3 RMCSS60DF	1589	1771	1951	2202	2492	2744	3035	3397	3759	1.94	41	15.5			
	ZOL3 RMCSS90DF	1813	2012	2211	2491	2807	3090	3405	3804	4205	1.94	49	19			
	Replacement Seat Double-seat Full Depth Curve															
	ZOL3 RMCSD30DF	2410	2637	2863	3182	3543	3862	4223	4678	5131	3.7	63	24			
	ZOL3 RMCSD45DF	2637	2968	3297	3761	4289	4754	5281	5941	6603	3.7	69	25.5			
	ZOL3 RMCSD60DF	2992	3322	3654	4116	4645	5109	5636	6297	6960	3.7	72	27			
	ZOL3 RMCSD90DF	3431	3795	4160	4669	5256	5764	6347	7074	7806	3.7	86	33.5			
	Replacement Seat Cover Single-seat Standard Depth Curve															
	ZOL3 RMCBSCS30DS	223	279	337	416	510	590	680	796	912	1.8	2.5	1			
	ZOL3 RMCBSCS45DS	229	286	344	424	516	597	689	805	917	1.8	3.1	1			
	ZOL3 RMCBSCS60DS	265	321	380	458	552	632	725	840	955	1.8	3.7	1.5			
	ZOL3 RMCBSCS90DS	287	345	404	483	573	655	746	864	978	1.8	4.3	1.5			
	Replacement Seat Cover Double-seat Standard Depth Curve															
	ZOL3 RMCBSCD30DS	388	494	603	757	930	1083	1257	1474	1691	3.4	4.8	1.5			
	ZOL3 RMCBSCD45DS	394	507	614	765	939	1090	1265	1482	1698	3.4	5.9	1.5			
	ZOL3 RMCBSCD60DS	446	556	664	815	988	1140	1314	1533	1748	3.4	7.0	2.5			
	ZOL3 RMCBSCD90DS	464	571	679	833	1008	1161	1333	1551	1768	3.4	8.2	2.5			

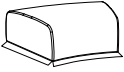
ZOLA | MODULAR CURVE - REPLACEMENT COMPONENTS

DESCRIPTION	MODEL	COM		COL	FABRIC GRADES				LEATHER			COM		
		1	2		3	4	5	6	7	8	9	YARDAGE	WEIGHT	CUBE
	Replacement Seat Cover Single-seat Full Depth Curve													
	ZOL3 RMCBSCS30DF	246	312	380	470	571	665	768	898	1030	1.94	2.9	1	
	ZOL3 RMCBSCS45DF	256	320	386	478	582	672	778	906	1036	1.94	3.6	1	
	ZOL3 RMCBSCS60DF	295	359	424	515	620	710	812	943	1073	1.94	4.3	1.5	
	ZOL3 RMCBSCS90DF	313	380	444	536	640	730	835	962	1094	1.94	4.9	1.5	
	Replacement Seat Cover Double-seat Full Depth Curve													
	ZOL3 RMCBSCD30DF	433	557	680	853	1054	1228	1423	1672	1922	3.7	5.5	1.5	
	ZOL3 RMCBSCD45DF	441	565	689	865	1062	1236	1434	1683	1929	3.7	6.8	1.5	
	ZOL3 RMCBSCD60DF	493	619	743	915	1116	1289	1487	1735	1984	3.7	8.1	2.5	
	ZOL3 RMCBSCD90DF	530	654	778	952	1147	1320	1522	1771	2017	3.7	9.4	2.5	

JORDAN | ENVIRONMENTAL SUMMARY

LEED CI CREDITS

MATERIAL CONTENT:



PRE-CONSUMER
RECYCLED CONTENT = 8.08%

POST-CONSUMER
RECYCLED CONTENT = 18.15%

Up to 40% of this Jordan product is recyclable at the end of its useful life.

CONTRIBUTES TO

CREDIT	CONTRIBUTES TO	POINTS
CREDIT 2.1 - 2.2	Construction Waste Management	1-2 point(s)
CREDIT 3.3	Resource Reuse	1 point
CREDIT 4.1	Recycled Content	1 point
CREDIT 4.2	Recycled Content	1 point
CREDIT 4.5	Low Emitting Materials, Systems & Seating	1 point
CREDIT 5.1	Regional Materials*	1 point
CREDIT 7	Certified Wood (MUST BE REQUESTED)	1 point(s)

*This credit is only applicable if in total 20% of the combined value of the procurement of construction materials and in the furniture are manufactured within a radius of 500 miles. This credit will apply if the installation of the finished product occurs within 500 miles of Kitchener, Ontario.

level® CERTIFICATION, AIR EMISSIONS AND FSC® CERTIFICATION



level® CERTIFICATION

BIFMA's e3 Furniture Sustainability Standard is a voluntary, multi-attribute standard that measures the degree of sustainability of furniture. This standard evaluates product and company environmental attributes and compliance systems in a wide range of elements which include Materials, Energy & Atmosphere, Human & Ecosystem Health and Social Responsibility. Jordan products have earned level®, BIFMA's sustainability certification program for furniture, certification through third-party verification against the e3 standard.

AIR-EMISSIONS

All Jordan products are supplied with air-emissions certified. Contact customer service for information.



FSC®

In 2005, Krug received Forest Stewardship Council® (FSC®) Chain-of-Custody certification for our manufacturing facilities. The FSC® Chain-of-Custody tracks certified wood from seedling to final sale. It verifies that the material for our FSC® certified products only come from well-managed, FSC®-certified forests and other controlled sources. FSC® is dedicated to the promotion of responsible forest management worldwide helping to take care of forests for future generations. Jordan and other Krug products can be specified with FSC® Certification. Contact customer service for further information, pricing and lead times.



Architects, designers, and building professionals can specify FSC®-certified products in order to achieve a point from the U.S. Green Building Council's Leadership in Energy and Environmental Design (LEED) Rating System.

JORDAN | BENCHES - DIMENSIONS & COM REQUIREMENTS

DIMENSIONS

	Overall Width	Overall Depth	Overall Height	Seat Height	Height of Arms from Floor	Width Between Arms	Seat Depth	Shipping Weight	Cubes
21" One-Seater	25	24	22	19	22	20.5	24	35	10
24" One-Seater	28	24	22	19	22	23.5	24	37	11
30" One-Seater Plus	34	24	22	19	22	29.5	24	42	13
48" Two-seater	52.5	24	22	19	22	48	24	65	19.5
72" Three-seater	77	24	22	19	22	72.75	24	91	28

COM YARDAGES

	COM Yardage Complete Unit	Yardage Per Bench - Per Complete Unit	COM Yardage Closed Arm Panel Only	Yardage Per Bench - Closed Arm Panel Only
21" One-Seater	1.1	1.1	0.5	0.5
21" One-Seater (2 units)	1.8	1.1	1	0.5
21" One-Seater (3 units)	2.1	1.1	1.5	0.5
21" One-Seater (4 units)	3.4	1.1	2	0.5
24" One-Seater	1.1	1.1	0.5	0.5
24" One-Seater (2 units)	1.8	1.1	1	0.5
24" One-Seater (3 units)	2.1	1.1	1.5	0.5
24" One-Seater (4 units)	3.4	1.1	2	0.5
30" One-Seater Plus	1.8	1.8	0.5	0.5
30" One-Seater Plus (2 units)	3.6	1.8	1	0.5
30" One-Seater Plus (3 units)	5.4	1.8	1.5	0.5
30" One-Seater Plus (4 units)	7.2	1.8	2	0.5
48" Two-seater	1.8	1.8	0.5	0.5
48" Two-seater (2 units)	3.6	1.8	1	0.5
48" Two-seater (3 units)	5.4	1.8	1.5	0.5
48" Two-seater (4 units)	7.2	1.8	2	0.5
72" Three-seater	2.1	2.1	0.5	0.5
72" Three-seater (2 units)	3.9	2.1	1	0.5
72" Three-seater (3 units)	5.4	2.1	1.5	0.5
72" Three-seater (4 units)	7.8	2.1	2	0.5

WEIGHT CAPACITIES

Jordan weight capacities are as follows:

21" & 24" Bench - 350 lbs

30" Bench - 750 lbs

48" Bench - 525 lbs per unit

72" Bench - 750 lbs per unit

Jordan Bench Option Upcharges

\$ List

CAL 133 & Moisture Barrier (per yard)	64
Removable Seat Cover (per seat) - 21"	103
Removable Seat Cover (per seat) - 24"	115
Removable Seat Cover (per seat) - 30"	143
Removable Seat Cover (per seat) - 48"	156
Removable Seat Cover (per seat) - 72"	268
Non-Marring Glide	37

Replacement seat covers can be quickly installed on Jordan products that were originally ordered with the Replaceable cover option. Replacement seat covers can also be installed on Jordan products that were not originally ordered with the Replaceable cover option, with some simple staple removal on the original seat.

JORDAN | BENCHES

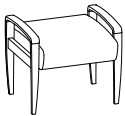
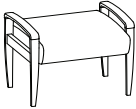
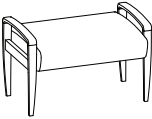
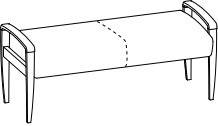
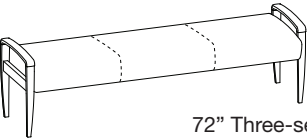
DESCRIPTION/MODEL	Species	COM		COL		FABRIC GRADES					LEATHER	
		1	2	3	4	5	6	7	8	9		
	21" Open Arm											
	JOR5-B21OPS	Beech	1139	1187	1232	1330	1422	1518	1613	1708	1852	
	JOR5-B21OPS	Maple	1232	1282	1330	1422	1518	1613	1708	1803	1945	
	21" Closed Arm											
	JOR5-B21CLS	Beech	1439	1503	1565	1692	1818	1945	2070	2196	2356	
	JOR5-B21CLS	Maple	1534	1597	1662	1788	1913	2039	2166	2294	2483	
	24" Open Arm											
	JOR5-B24OPS	Beech	1202	1249	1297	1391	1485	1583	1676	1772	1913	
	JOR5-B24OPS	Maple	1297	1345	1391	1485	1583	1676	1772	1866	2039	
	24" Closed Arm											
	JOR5-B24CLS	Beech	1503	1565	1631	1755	1882	2007	2134	2263	2434	
	JOR5-B24CLS	Maple	1597	1662	1724	1852	1977	2104	2230	2356	2530	
	30" Plus Open Arm											
	JOR5-B30OPS	Beech	1384	1463	1540	1685	1825	1968	2110	2253	2489	
	JOR5-B30OPS	Maple	1485	1565	1644	1788	1928	2070	2214	2356	2609	
	30" Plus Closed Arm											
	JOR5-B30CLS	Beech	1685	1778	1872	2032	2191	2347	2505	2664	2910	
	JOR5-B30CLS	Maple	1788	1882	1977	2134	2294	2451	2609	2767	3021	
	48" Two-seater Open Arm											
	JOR5-B48OPS	Beech	1613	1692	1772	1913	2056	2196	2341	2483	2718	
	JOR5-B48OPS	Maple	1715	1795	1872	2017	2160	2301	2443	2586	2822	
	48" Two-seater Closed Arm											
	JOR5-B48CLS	Beech	1913	2007	2104	2263	2419	2577	2736	2893	3145	
	JOR5-B48CLS	Maple	2017	2110	2206	2362	2522	2681	2838	2995	3248	
	72" Three-seater Open Arm											
	JOR5-B72OPS	Beech	1945	2039	2134	2324	2515	2703	2893	3082	3398	
	JOR5-B72OPS	Maple	2039	2134	2230	2419	2609	2798	2988	3179	3494	
	72" Three-seater Closed Arm											
	JOR5-B72CLS	Beech	2244	2373	2497	2748	3004	3257	3510	3762	4111	
	JOR5-B72CLS	Maple	2341	2465	2593	2847	3099	3352	3605	3856	4206	

PRODUCT CODE KEY

Line	Series	Chair Type	Size	Arm Type
JOR	5	B	21	OPS
Jordan		Bench	24	Open Arm
			30	CLS
			48	Closed Arm
			72	

CARLYLE BENCH | ENVIRONMENTAL SUMMARY

LEED CI CREDITS



MATERIAL CONTENT:

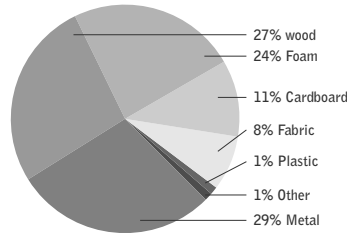

PRE-CONSUMER
RECYCLED CONTENT = 15%

POST-CONSUMER
RECYCLED CONTENT = 17.97%

Up to 49.33% of this Carlyle product is recyclable at the end of its useful life.

CONTRIBUTES TO

CREDIT 2.1 - 2.2	Construction Waste Management	1-2 point(s)
CREDIT 3.3	Resource Reuse	1 point
CREDIT 4.1	Recycled Content	1 point
CREDIT 4.2	Recycled Content	1 point
CREDIT 4.5	Low Emitting Materials, Systems & Seating	1 point
CREDIT 5.1	Regional Materials*	1 point
CREDIT 7	Certified Wood (MUST BE REQUESTED)	1 point(s)

*This credit is only applicable if in total 20% of the combined value of the procurement of construction materials and in the furniture are manufactured within a radius of 500 miles. This credit will apply if the installation of the finished product occurs within 500 miles of Kitchener, Ontario.

level® CERTIFICATION, AIR EMISSIONS AND FSC® CERTIFICATION



level® CERTIFICATION

BIFMA's e3 Furniture Sustainability Standard is a voluntary, multi-attribute standard that measures the degree of sustainability of furniture. This standard evaluates product and company environmental attributes and compliance systems in a wide range of elements which include Materials, Energy & Atmosphere, Human & Ecosystem Health and Social Responsibility. Carlyle products have earned level®, BIFMA's sustainability certification program for furniture, certification through third-party verification against the e3 standard.

AIR-EMISSIONS

All Carlyle products are supplied with air-emissions certified. Contact customer service for information.



FSC®

In 2005, Krug received Forest Stewardship Council® (FSC®) Chain-of-Custody certification for our manufacturing facilities. The FSC® Chain-of-Custody tracks certified wood from seedling to final sale. It verifies that the material for our FSC® certified products only come from well-managed, FSC®-certified forests and other controlled sources. FSC® is dedicated to the promotion of responsible forest management worldwide helping to take care of forests for future generations. Carlyle and other Krug products can be specified with FSC® Certification. Contact customer service for further information, pricing and lead times.



Architects, designers, and building professionals can specify FSC®-certified products in order to achieve a point from the U.S. Green Building Council's Leadership in Energy and Environmental Design (LEED) Rating System.

CARLYLE BENCH

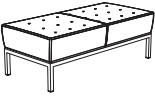
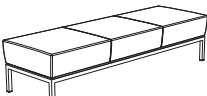
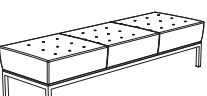
DESCRIPTION/MODEL	COM		COL	FABRIC GRADES			LEATHER		
	1	2	3	4	5	6	7	8	9
 TWO-SEAT CAR5-2-0	1713	1798	1884	1971	2063	2157	2249	2369	2541
 TWO-SEAT - BUTTON DETAILING CAR5-2-1	2209	2294	2381	2465	2559	2649	2743	2861	3037
 THREE-SEAT CAR5-3-0	2253	2377	2493	2612	2734	2852	2972	3117	3503
 THREE-SEAT - BUTTON DETAILING CAR5-3-1	3017	3140	3257	3378	3497	3614	3738	3881	4267

DIMENSIONS & COM REQUIREMENTS

	Overall Width	Overall Depth	Overall Height	Seat Height	Height of Arms from Floor	Width between Arms	Seat Depth	Shipping Weight	Cube	COM Yardage
CAR5-2-0	54	26.5	17.5	-	-	-	-	75	16	2.4
CAR5-2-1	54	26.5	17.5	-	-	-	-	75	16	2.4
CAR5-3-0	81	26.5	17.5	-	-	-	-	110	25	3.6
CAR5-3-1	81	26.5	17.5	-	-	-	-	110	25	3.6

PRODUCT CODE KEY

Line	Series	Seat Count	Upholstery Style
CAR	5	2	0
Carlyle	Bench	Two-Seat	Upholstery Standard
		3	1
		Three-Seat	Top Stitching and Buttons

CARLYLE

Base is available in Silver Metallic only.

MOISTURE BARRIER & CAL 133

Moisture Barrier & CAL 133 is available for an upcharge of **\$64 list** per yard.

RECLINERS

- 345 Ascend
- 353 Jordan Active Patient Recliner
- 359 Jordan 3 Position Recliner
- 368 Jordan Recliner Plus
- 373 Jordan Sleep Recliner

ASCEND EXAM RECLINER | ENVIRONMENTAL SUMMARY

LEED CI CREDITS



MATERIAL CONTENT:

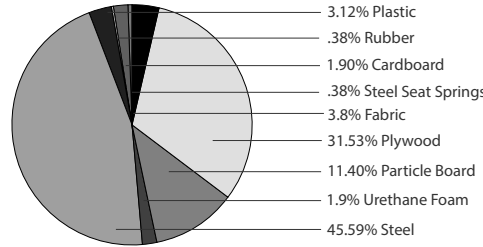

PRE-CONSUMER RECYCLED CONTENT = 22.89%

POST-CONSUMER RECYCLED CONTENT = 11.25%

Up to 47.49% of this Ascend Exam Recliner product is recyclable at the end of its useful life.

CONTRIBUTES TO

CREDIT 2.1 - 2.2	Construction Waste Management	1-2 point(s)
CREDIT 3.3	Resource Reuse	1 point
CREDIT 4.1	Recycled Content	1 point
CREDIT 4.2	Recycled Content	1 point
CREDIT 4.5	Low Emitting Materials, Systems & Seating	1 point
CREDIT 5.1	Regional Materials*	1 point
CREDIT 7	Certified Wood (MUST BE REQUESTED)	1 point(s)

*This credit is only applicable if in total 20% of the combined value of the procurement of construction materials and in the furniture are manufactured within a radius of 500 miles. This credit will apply if the installation of the finished product occurs within 500 miles of Kitchener, Ontario.

level® CERTIFICATION, AIR EMISSIONS AND FSC® CERTIFICATION



level® CERTIFICATION

BIFMA's e3 Furniture Sustainability Standard is a voluntary, multi-attribute standard that measures the degree of sustainability of furniture. This standard evaluates product and company environmental attributes and compliance systems in a wide range of elements which include Materials, Energy & Atmosphere, Human & Ecosystem Health and Social Responsibility. Ascend products have earned level®, BIFMA's sustainability certification program for furniture, certification through third-party verification against the e3 standard.

AIR-EMISSIONS

All Ascend products are supplied with air-emissions certified. Contact customer service for information.



FSC®

In 2005, Krug received Forest Stewardship Council® (FSC®) Chain-of-Custody certification for our manufacturing facilities. The FSC® Chain-of-Custody tracks certified wood from seedling to final sale. It verifies that the material for our FSC® certified products only come from well-managed, FSC®-certified forests and other controlled sources. FSC® is dedicated to the promotion of responsible forest management worldwide helping to take care of forests for future generations. Ascend and other Krug products can be specified with FSC® Certification. Contact customer service for further information, pricing and lead times.



Architects, designers, and building professionals can specify FSC®-certified products in order to achieve a point from the U.S. Green Building Council's Leadership in Energy and Environmental Design (LEED) Rating System.

ASCEND EXAM RECLINER | FEATURES & OPTIONS

FEATURES



UPHOLSTERED ARM & ARM CAPS

Ascend Upholstered Arms are available fully upholstered with the option of being trimmed with flat Polymer Arm Caps, Urethane Arm Caps or Solid Surface Arm Caps.



LIFT CONTROLS

Lift Control button provides height adjustment with a range of a 19" seat height up to a 32" exam height. Buttons are located in a fixed location at the back left of the side arm (facing). Exception: when the Swing Away Tablet option is specified the Lift Control buttons will be located on back right of the side arm (facing).



RECLINE CONTROL

The corded Recline Control can operate the back recline and footrest independently or simultaneously. The Control is housed in a holder at the back left of the side arm (facing) and can be accessed by the patient for position adjustment.



PUSH BAR

This is a standard feature on the Ascend Exam Recliner. Ergonomically designed to assist care-giving staff in the movement and operation of the recliner, as well as promote reduced back strain on the care-giver.



HIGH DURABILITY MECHANISM

Ascend mechanisms are designed for high-traffic, intensive use in caregiving environments. They are built with high-strength steel and the electronics are IEC 60601-1 compliant.



REMOVEABLE COVER

Ascend Back covers can be field removed for replacement. The continuous seat/footrest pad can be removed for replacement or detached from the seat assembly for ease of cleaning.



CASTERS

4" twin wheel locking swivel casters provide quiet and smooth motion when moving Ascend. The lock feature locks both the wheel and swivel.



SPRING SEAT CONSTRUCTION

Spring seat construction combined with dual density foam offers exceptional comfort, durability and increased longevity.

OPTIONS



ARM CAPS

Arm Caps provide enhanced durability and protection and are field replaceable if damaged or degraded. Polymer & Urethane Arm Caps are Grey. Solid Surface is available in 8 finishes. Please see page 631 for color selections.



PROFILE ARM

Profile Arm features a recess under the armrest and inset profile to aid in ingress/egress and serve as a grab rail to assist the patient during transfer. The Profile Arm provides enhanced durability and protection and is field replaceable if damaged or degraded. Polymer Profile Arm are Grey. Solid Surface is available in 8 finishes. Please see page 631 for color selections.



PATIENT TRANSFER ARM

Patient Transfer Arms are designed to fold down where the arm is level with the chair seat. This design allows the caregiver to move the patient from the recliner to a bed, or other transport.



CENTRAL CASTER LOCKING SYSTEM

Allows for single action locking of all four casters at one time. Casters are locked both directionally and rotationally, keeping the recliner in place when locked. The color-coded external foot pedal indicates Red for the locked position (when lowered) and Green for the unlocked position (when unlowered). The standard position for the foot pedal is located at the rear outside of the left (facing) arm panel. It can optionally be located at the front outside of the arm panel (either side) or at rear of right (facing) arm panel. Casters are 4" diameter with soft wheel treads. Purchase orders must indicate Central Caster Locking System option, note the requested position, and include the upcharge



SWING AWAY TABLET

The tablet has the ability to slide up and fold over and rotate 180°. The break-away design allows for the tablet to be pushed away from the patient quickly in case of an emergency. Tablets cannot mount to Patient Transfer Arms.



FLIP UP TABLET

The tablet is 18" x 14" x 3/4", and it can be located on either side of the recliner. Please clearly specify whether a right-handed or left-handed position (facing) is needed when ordering. It is available Laminate with a Polymer edge. It folds flat (protruding 3" from the side of the recliner when flat). Tablets cannot mount to Patient Transfer Arms.



POWER DOC

The pop-up Power doc offers convenient power and USB charging access on demand. Flush with the arm when closed and pop open with a simple touch to the cover. Located at the rear of the arm, opposite side of recliner controls. Include a hospital grade electrical outlet rated 15A/125VAC and a two USB port (A+C) for USB powered device

ASCEND EXAM RECLINER | OPTIONS CONTINUED, DIMENSIONS & C.O.M.



IV POLE & HOLDER

The Ascend IV pole is height adjustable and can be added in the field. It can be located on either the left or right side (facing) at the back of the recliner. The location must be specified at time of order.



COMBINATION UPHOLSTERY OPTION

When combination upholstery is specified with fabric of the same grade or COM, an upcharge for dual fabrics is **\$33 list** per unit and **\$64 list** per unit for three fabrics will be applied. When graded in combination upholstery is selected, use the highest grade upholstery selected or to obtain a quote for blended grading contact Customer Service (please provide the fabrics specified and location of where each fabric is to be applied on the product).



FOLEY HOOK

This recessed, retractable hook system provides a mounting system for catheter bags. It is spring-loaded to automatically retract when not in use, to eliminate any hazard. It can be located on either the left or right side (facing) at the front of the recliner. Opposite to Flip up Tablet or Patient Transfer Arm.



TRENDELENBURG OPTION

The Ascend Trendelenburg option offers full recline with footrest fully extended. While in Trendelenburg mode the seat-back angle remains at 180 degrees but the back goes from 0 degrees to -10 from vertical - resulting in the feet being above the head. It is activated by a foot-release lever that is accessible from either side of the chair.



STIRRUPS

Stirrups attach to extending rails accessible when the seat is in the exam position and can be positioned at different settings according to leg length.



STIRRUP STORAGE

When not in use, the stirrups are conveniently stored on the back of the recliner arm.



PAPER ROLL HOLDER

The Paper Roll is located on the back side of the recliner and will accept 18" standard width rolls.

MOISTURE BARRIER & CAL 133 OPTION

California Technical Bulletin 133 is a flammability test for seating. Krug offers a compliance method, in combination with non-flammable upholstery covers, may enable products to meet certification requirements for this test. This process at the same time also provides the products with a Moisture Barrier - a treatment that helps to prevent the passage of liquids and moisture to inside of the upholstered components - thereby conferring sanitary and anti-infection benefits. So when CAL 133 is specified, the product also automatically has a Moisture Barrier, and when a Moisture Barrier is specified, the product also features the compliance method and low flammability features of CAL 133. The application of this up-charge and the compliance method does not mean that the specific configuration of product and upholstery cover are tested and officially certified as being CAL133 compliant. If the official certification is required, Krug will provide this (through an independent certified testing laboratory) at a charge of \$917 per item, plus the cost of the product to be tested. Lead time for certification testing is typically 4-8 weeks.

DIMENSIONS

	Overall Width	Overall Depth	Overall Depth Reclined	Overall Seated Height (Min Lift)	Overall Seated Height (Max Lift)	Overall Height Exam (Max Lift)	Seat Height (Min Lift)	Seat Height (Max Lift)	Seat Width	Seat Depth	Arm Height	Shipping Weight	Shipping Cubes
Recliner	33	39.7	71.7	49	62.7	32	19.3	32	24	20	27.8	281	38

COM YARDAGES

	COM Yardage for Complete Unit	COM Yardage Seat & Footrest Only	COM Yardage Back Only	COM Yardage Standard Arm Only	Transfer Arm Only
Recliner without transfer arms	6.3	1.4	2.4	2.8	-
Recliner with one transfer arm	6.9	1.4	2.4	2.8	3.75
Recliner with dual transfer arms	7.5	1.4	2.4	-	3.75

WEIGHT CAPACITIES

Ascend Exam Recliner is load rated to 400 lbs

ASCEND EXAM RECLINER | INSTRUCTION



RECLINE CONTROLS

Located on the side of the arm, the Ascend hand wand is used to control both the back recline and the footrest. The top two buttons control the back, the middle two buttons control the ottoman and the lower two buttons control the back and ottoman simultaneously.



LIFT CONTROLS

Located on the side of the arm, the Ascend lift control is used to move the unit up and down. Simply press on the up or down button until you reach your desired height. Do not operate the lift while the unit is in Trendelenburg mode. If applicable stow the swing tablet before use.



POWERDOC (Optional)

Press down on the inner front edge to pop the unit out. Once you are done using it press back down until an audible click is heard.

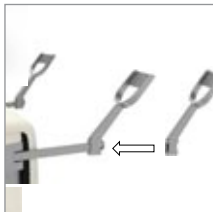

STIRRUPS (Optional Feature)

The stirrup bars are located just below the seat. Using one finger, pull them out to the desired length. Remove the stirrups from the holder on the side of the arm and slide the stirrup onto the stirrup bar.



SWING AWAY TABLET (Optional Feature)

To use, rotate the tablet up to a minimum of 90° from its resting position and lower it in front of the patient so it is sitting parallel to the floor. To stow the tablet flip it up so the tablet surface is parallel to the side of the arm and rotate it back to its resting position. Care should be taken when stowing the tablet. Do not allow it to fall freely as this may cause damage to both the unit and the tablet.



FLIP TABLET (Optional Feature)

To raise the tablet, pull up on it until it is horizontal and “clicks” into place. To lower, depress both safety latches located on the tablet bracket and slowly lower the tablet into its resting position.



TRENDELENBURG LEVER (Optional Feature)

Ensure the unit is in its lowest position before operating the Trendelenburg feature. To convert the unit into Trendelenburg mode press down on the red foot activated pedal below the arms. Once the pedal is pressed gently push down on the back. Releasing the foot pedal will engage the lock and ensure that the chair stays in place. To get the chair back into the standard position press down on the foot pedal again and gently press down on the seat until it is horizontal.



PAPER ROLL HOLDER (Optional Feature)

This feature accepts an 18” wide roll of exam paper. To load/unload rolls untighten the black knobs found on either end of the bar. Remove the bar, and slide it thru the roll of paper. Re install the bar ensuring that the thumbscrews are tight.



PATIENT TRANSFER ARM (Optional Feature)

To activate this feature pull down on the lever located at the front of the arm. This will unlock the arm and allow you to swing the upper portion of the arm down and out of the way. Once you are done using it lift the arm back into the upright position and pull up on the locking lever. When the arm has been re locked gently wiggle it back and forth to ensure it is secure. If the transfer arm is excessively loose or is very hard to lock adjust the built in adjustment screw located inside the upper portion of the arm. Loosening the screw will make the arm easier to open while tightening it will make it lock more firmly. Please specify right or left handed (facing) on the purchase order.



[View Ascend Video](#)

ASCEND EXAM RECLINER

DESCRIPTION/MODEL	COM		COL	FABRIC GRADES			LEATHER		
	1	2	3	4	5	6	7	8	9

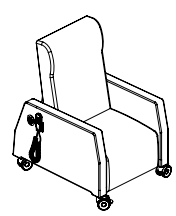

Standard Arm with Upholstered Arm and Standard Seat ASC8RVLSAUPH11	9278	9459	9639	9891	10179	10431	10719	11079	11438
---	------	------	------	------	-------	-------	-------	-------	-------

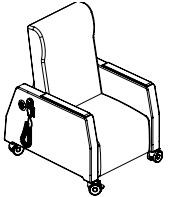

Standard Arm with Polymer Arm Cap and Standard Seat ASC8RVLSAPAC11	9410	9589	9770	10022	10309	10563	10850	11210	11569
---	------	------	------	-------	-------	-------	-------	-------	-------

Standard Arm with Urethane Arm Cap and Standard Seat ASC8RVLSAUAC11	9410	9589	9770	10022	10309	10563	10850	11210	11569
--	------	------	------	-------	-------	-------	-------	-------	-------

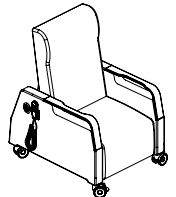

Standard Arm with Polymer Profile Arm and Standard Seat ASC8RVLSAPPA11	9649	9830	10010	10262	10549	10802	11091	11450	11810
---	------	------	-------	-------	-------	-------	-------	-------	-------

Ascend Exam Recliner Option Upcharges



	Grades					\$ List
	A - White	A - Color	B	C		
Solid Surface Arm Cap (pair)	218	227	243	254	Moisture Barrier & CAL 133 (per yard)	64
Solid Surface Profile Arm (pair)	599	635	740	753	Combination Upholstery - Dual	33
					Combination Upholstery - Triple	64
					Patient Transfer Arm - Left (facing unit)	928
					Patient Transfer Arm - Right (facing unit)	928
					Patient Transfer Arm - Dual (both)	1855
Stirrups (2)			1839		IV Pole and Holder	364
Paper Roll Holder			212		Swing Away Tablet	436
-1 Receptacle, 1 USB (Hospital Grade)			617		Flip Up Tablet	396
					Foley Catheter Hook	204
					Central Caster Locking System (CCLS)	1565

ORDERING NOTES: To specify Patient Transfer Arm(s) add upcharge above and change "SA" in the model number to the required Arm Type selection in the Product Code Key below. Example for Patient Transfer Arm Left - ASC8RVLPLSSP11.
To specify Stirrup Seat Style change the 1 to a 2 and add upcharge above.

PRODUCT CODE KEY

Line	Series	Chair Type	Arm Type	Arm Style	Base	Seat Style
ASC	8	RVL	SA	UPH	1	1
Ascend	Motion	Recliner w/Vertical Lift	Standard Arm	Upholstered Arm	Casters	Standard
		RVLT	PL	PAC	3	2
		Recliner w/Vertical Lift & Trendelenburg	Patient Transfer Arm - Left	Polymer Arm Cap	CCLS	Stirrup
			PR	UAC		
			Patient Transfer Arm - Right	Urethane Arm Cap		
			PD	SSC		
			Patient Transfer Arm - Dual	Solid Surface Arm Cap		
				PPA		
				Polymer Profile Arm		
				SSP		
				Solid Surface Profile Arm		

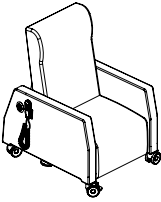
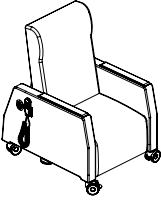
ASCEND EXAM RECLINER | WITH TRENDELENBURG

DESCRIPTION/MODEL	COM		COL		FABRIC GRADES			LEATHER		
	1	2	3	4	5	6	7	8	9	
 Standard Arm with Upholstered Arm, Standard Seat and Trendelenburg ASC8RVLTAUPH11	9840	10020	10199	10453	10740	10992	11281	11640	12000	
 Standard Arm with Polymer Arm Cap, Standard Seat and Trendelenburg ASC8RVLTSAPAC11	9971	10151	10332	10585	10871	11123	11411	11770	12132	
 Standard Arm with Urethane Arm Cap, Standard Seat and Trendelenburg ASC8RVLTAUAC11	9971	10151	10332	10585	10871	11123	11411	11770	12132	
 Standard Arm with Polymer Profile Arm, Standard Seat and Trendelenburg ASC8RVLTSAPPA11	10212	10391	10571	10823	11111	11364	11650	12012	12372	

Ascend Exam Recliner Option Upcharges

	Grades					\$ List
	A - White	A - Color	B	C		
Solid Surface Arm Cap (pair)	218	227	243	254	Moisture Barrier & CAL 133 (per yard)	64
Solid Surface Profile Arm (pair)	599	635	740	753	Combination Upholstery - Dual	33
					Combination Upholstery - Triple	64
					Patient Transfer Arm - Left (facing unit)	928
					Patient Transfer Arm - Right (facing unit)	928
Stirrups (2)			1839		Patient Transfer Arm - Dual (both)	1855
Paper Roll Holder			212		IV Pole and Holder	364
-1 Receptacle, 1 USB (Hospital Grade)			617		Swing Away Tablet	436
					Flip Up Tablet	396
					Foley Catheter Hook	204
					Central Caster Locking System (CCLS)	1565

ORDERING NOTES: To specify Patient Transfer Arm(s) add upcharge above and change "SA" in the model number to the required Arm Type selection in the Product Code Key below. Example for Patient Transfer Arm Left - ASC8RVLPLSSP11.
To specify Stirrup Seat Style change the 1 to a 2 and add upcharge above.

PRODUCT CODE KEY

Line	Series	Chair Type	Arm Type	Arm Style	Base	Seat Style
ASC Ascend	8 Motion	RVL Recliner w/Vertical Lift	SA Standard Arm	UPH Upholstered Arm	1 Casters	1 Standard
		RVLT Recliner w/Vertical Lift & Trendelenburg	PL Patient Transfer Arm - Left	PAC Polymer Arm Cap	3 CCLS	2 Stirrup
			PR Patient Transfer Arm - Right	UAC Urethane Arm Cap		
			PD Patient Transfer Arm - Dual	SSC Solid Surface Arm Cap		
				PPA Polymer Profile Arm		
				SSP Solid Surface Profile Arm		

ASCEND EXAM RECLINER | REPLACEMENT COMPONENTS

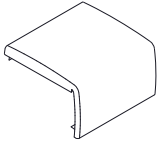
DESCRIPTION/MODEL	COM		COL	FABRIC GRADES			LEATHER			Weight	Cubes
	1	2	3	4	5	6	7	8	9		
 Seat with Continuous Footrest Cover ASC8-RVLRFS	421	449	478	517	564	604	648	707	764	8	1.6

 Back Cover ASC8-RVLRBC	588	657	725	821	931	1027	1137	1272	1411	3	0.8
--	-----	-----	-----	-----	-----	------	------	------	------	---	-----

DESCRIPTION/MODEL	Polymer	Urethane	Solid Surface				Weight	Cubes
			Gr A- White	Gr A- Color	Gr B- Color	Gr C- Color		
 Profile Arm ASC8-RVLRCP	195	n/a	343	362	412	421	8	1

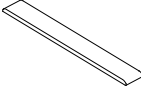
 Arm Cap ASC8-RVLRFC	110	110	154	157	165	170	3	0.5
--	-----	-----	-----	-----	-----	-----	---	-----

DESCRIPTION/MODEL	Price	Weight	Cubes
 Recline Control ASC8-RVLRRC	108	1	0.3



 Paper Roll Holder ASC8-RVLRPH	256	4	0.5
---	-----	---	-----

 Stirrup ASC8-RVLRSS	280	5	0.5
---	-----	---	-----

 Caster ASC8-RVLRCCR	212	2	0.3
---	-----	---	-----

 Push Bar ASC8-RVLRPB	195	2	0.3
--	-----	---	-----

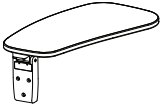
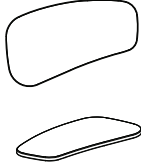
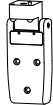
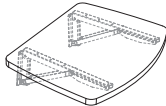
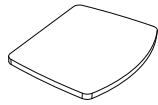
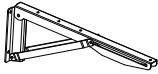
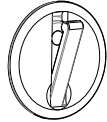
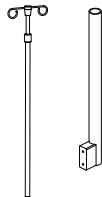
ASCEND EXAM RECLINER | REPLACEMENT COMPONENTS

DESCRIPTION/MODEL	Price	Weight	Cubes
 Swing Away Tablet & Mechanism ASC8-RVLRSC	436	20	1
 Swing Away Tablet only ASC8-RVLRSO 24"w x 14.75"d x .75"h	226	7	0.8
 Swing Away Tablet Mechanism only ASC8-RVLRSM	286	13	0.3
 Flip-up Tablet & Bracket ASC8-RVLRFC	396	6.6	1.6
 Flip-up Tablet ASC8-RVLRFO 18"w x 14"d x .75"h	318	5.8	1.4
 Flip-up Tablet Bracket ASC8-RVLRFB	113	0.8	0.3
 Foley Hook ASC8-RVLRFH	204	1	0.8
 IV Pole ASC8-RVLRIP	278	3.8	1.4
 IV Pole Holder ASC8-RVLRIPH	85	2	0.3

JORDAN | ENVIRONMENTAL SUMMARY

LEED CI CREDITS



MATERIAL CONTENT:

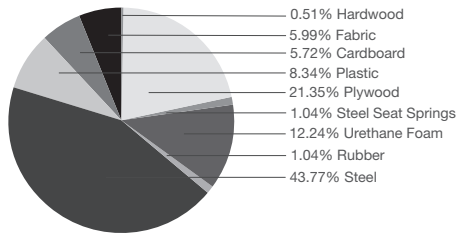

PRE-CONSUMER
RECYCLED CONTENT = 11.21%

POST-CONSUMER
RECYCLED CONTENT = 15.06%

Up to 49.5% of this Jordan product is recyclable at the end of its useful life.

CONTRIBUTES TO

CREDIT 2.1 - 2.2	Construction Waste Management	1-2 point(s)
CREDIT 3.3	Resource Reuse	1 point
CREDIT 4.1	Recycled Content	1 point
CREDIT 4.2	Recycled Content	1 point
CREDIT 4.5	Low Emitting Materials, Systems & Seating	1 point
CREDIT 5.1	Regional Materials*	1 point
CREDIT 7	Certified Wood (MUST BE REQUESTED)	1 point(s)

*This credit is only applicable if in total 20% of the combined value of the procurement of construction materials and in the furniture are manufactured within a radius of 500 miles. This credit will apply if the installation of the finished product occurs within 500 miles of Kitchener, Ontario.

level® CERTIFICATION, AIR EMISSIONS AND FSC® CERTIFICATION



level® CERTIFICATION

BIFMA's e3 Furniture Sustainability Standard is a voluntary, multi-attribute standard that measures the degree of sustainability of furniture. This standard evaluates product and company environmental attributes and compliance systems in a wide range of elements which include Materials, Energy & Atmosphere, Human & Ecosystem Health and Social Responsibility. Jordan products have earned level®, BIFMA's sustainability certification program for furniture, certification through third-party verification against the e3 standard.

AIR-EMISSIONS

All Jordan products are supplied with air-emissions certified. Contact customer service for information.



FSC®

In 2005, Krug received Forest Stewardship Council® (FSC®) Chain-of-Custody certification for our manufacturing facilities. The FSC® Chain-of-Custody tracks certified wood from seedling to final sale. It verifies that the material for our FSC® certified products only come from well-managed, FSC®-certified forests and other controlled sources. FSC® is dedicated to the promotion of responsible forest management worldwide helping to take care of forests for future generations. Jordan and other Krug products can be specified with FSC® Certification. Contact customer service for further information, pricing and lead times.



Architects, designers, and building professionals can specify FSC®-certified products in order to achieve a point from the U.S. Green Building Council's Leadership in Energy and Environmental Design (LEED) Rating System.

JORDAN | ACTIVE PATIENT RECLINER - DIMENSIONS & COM REQUIREMENTS

DIMENSIONS

	Overall Width (incl. handle)	Overall Width (incl. handle) w/ Accessories	Overall Depth (upright)	Overall Depth when Reclined	Overall Height	Seat Height	Height of Arms from Floor	Width Between Arms	Seat Depth	Shipping Weight	Cube
21"	30.5	34.5	27	57	43.5	18.5	26	20.5	19	92	19
24"	33.5	37.5	27	57	43.5	18.5	26	23.5	19	99	24

COM REQUIREMENTS

	COM Yardage Complete Unit	COM Yardage Seat Only	COM Yardage Back Only	COM Yardage Seat & Back	COM Yardage Arm Panel Only	COM Yardage Ottoman
21"						
One Chair	4.88	0.9	1.3	2	2.7	0.5
Two Chair	9.8	1.3	2	3.2	4.3	0.5
Three Chair	14.7	2.1	3	5.2	5.9	0.9
Four Chair	19.6	2.5	5.1	6.9	8	0.9
24"						
One Chair	5.14	0.9	2	2	2.7	0.7
Two Chair	4.9	1.3	3.1	3.9	4.3	0.9
Three Chair	14.7	2.1	4.2	6	5.9	1.4
Four Chair	19.6	2.5	5.3	7.5	8	1.8

ORDERING NOTES: Combination upholstery (more than one upholstery cover within the same unit) is an option on all Jordan upholstered products. When combination upholstery is with upholstery of the same grade or COM, an upcharge for dual fabrics is **\$33 list** per unit and **\$64 list** per unit for three fabrics. When graded in combination upholstery is selected, use the highest grade upholstery selected or contact Customer Service for a quote - please provide the fabrics specified and a description of where each fabric is to be applied on the product in order to obtain a quote.

Active Patient Recliner Option Upcharges

	\$ List	\$ List
Moisture Barrier & CAL 133 (per yard)	64	Solid Surface Arm Cap (per pair) - Gr A White
Ottoman Poly Cover	77	Solid Surface Arm Cap (per pair) - Gr A Color
Push Bar	207	Solid Surface Arm Cap (per pair) - Gr B
Removable Seat Cover (per seat)	121	Solid Surface Arm Cap (per pair) - Gr C
Removable Back Cover	137	Patient Transfer Arm
IV Pole and Holder	380	Thermal Comfort
Flip Up Tablet	416	Combination Upholstery - dual fabrics
Swing Away Tablet	458	Combination Upholstery -Three fabrics

JORDAN | ACTIVE PATIENT RECLINER - FEATURES



INDEPENDENT BACK & OTTOMAN MECHANISMS

Two independent mechanisms provide a greater range of function and positions for the Active Patient Recliner: the back can be upright or reclined, independent of the ottoman which can be closed or extended separately from the back.



OTTOMAN ACTIVATION

The adjustment lever is situated to allow both the user and the caregiver to safely operate the ottoman function of the mechanism. The ottoman is generously padded for comfort, and can be given added protection with the optional Ottoman Protective Cover.



BACK ACTIVATION LEVER

The Active Patient Recliner comes with the back adjustment lever which creates an infinite number of back adjustments within the chair. The back adjustment lever comes in a black plastic finish, and is located on the left hand side (when facing the chair) and on the caregiver side of the arm.

ARM OPTIONS

Arms have urethane arm caps. The textured urethane provides enhanced durability and protection for the arms and is available in three color options; Black, Grey and Taupe. Please specify color when ordering. The urethane arm cap is field replaceable if damaged or degraded.

LATEX FREE

Krug products are made with latex-free materials to prevent the allergic reaction that latex causes in some people.

WEIGHT RATINGS

The Active Patient Recliner has a maximum weight rating of 350 lbs, under normal use (i.e. no excessive force in the use of the product). The ottoman mechanism itself will accept weight to a maximum of 60 lbs (above which it will drop down). The ottoman is designed as a leg rest only, and not designed to accept sitting or standing.

JORDAN | ACTIVE PATIENT RECLINER - OPTIONS



PUSH BAR

The optional push bar is ergonomically designed to assist care-giving staff in the movement and operation of the recliner, and reduce back strain on the caregiver.



IV POLE & HOLDER

The IV Pole is height adjustable (in a range of 27"), and can be added in the field. It can be located in three locations (left front only or right front or back as facing) - if ordered with the recliner, the location must be specified at time of order.



SWING AWAY TABLET

The Swing Away Tablet (24" x 14 3/4" x 3/4") is designed to be easily operated by the caregiver or user. The break away design allows for the tablet to be easily pushed away from the user in an emergency to gain quick access to the patient. The tablet has the ability to swing up and fold over and rotates 180 degrees. The kidney-shaped design is ideal for use as an eating, writing or work surface. The Swing Away Tablet is specified right handed based on a position facing the unit.



FLIP UP TABLET

The Flip Up Tablet's size is 18" x 14" x 3/4", and it is located on the right side based on a position facing the unit. It is available in Beech and Maple Veneer, as well as Plastic Laminate with a Polymer edge. It folds flat (protruding 3" from the side of the recliner when flat).



THERMAL COMFORT

Providing warmth to patients undergoing chemotherapy and other treatments can be vitally important. Thermal Comfort is operated with a hand-held controller located on the inside of the arm (please specify right hand side or left hand side -facing). It provides two heat zones: one in the seat and one in the back. Back and seat zones can be controlled independently, at a high or low heat setting. Thermal Comfort features a safety time-out that automatically shuts off heat after 30 minutes of use. Access to a 110/120 volt, 15 amp(min) electrical outlet is required.



CASTERS

Four heavy-duty 3" diameter soft wheel casters are standard on the recliner. The front casters are inline and locking; the rear casters are swivel and not visible. This combination provides a noticeable and user-friendly ease of steering when the recliner is being moved. Casters are field-replaceable if damaged.



OTTOMAN PROTECTIVE COVER

This optional clear protective cover is sewn into (and over top of) the lower portion of the upholstered ottoman, providing a layer of protection from marring and damage caused by footwear, cleaning and medical equipment, etc. It has an anti-fog additive to maintain clarity, and is resistant to cleaning solutions.



PATIENT TRANSFER ARM

The Patient Transfer Arm is designed to fold down where the arm is level with the chair seat. This design allows the caregiver to easily transport patients from the chair to bed or wheelchair. The arm is folded down by accessing the adjustment lever at the side of the chair. The Patient Transfer Arm can only be specified in a right handed position based on facing the unit.



SOLID SURFACE ARM CAP

The optional Solid Surface Arm Cap provides enhanced durability, protection and cleanability for the arms. This is field replaceable if this becomes damaged or degraded and is available in 8 standard colors. Please see page 631 for color selections.



COMBINATION UPHOLSTERY OPTIONS

When combination upholstery is specified with fabric of the same grade or COM, an upcharge for dual fabrics is **\$33 list** per unit and **\$64 list** per unit for three fabrics will be applied. When graded in combination upholstery is selected, use the highest grade upholstery selected or to obtain a quote for blended grading contact Customer Service (please provide the fabrics specified and location of where each fabric is to be applied on the product).



REMOVABLE COVERS

Removable seat and back covers can be quickly installed on products that were originally ordered with the Removable Cover Option. Removable seat and back covers can also be installed on products that were not originally ordered with the Removable Cover Option, with some simple staple removal on the original seats and backs.

MOISTURE BARRIER & CAL 133

California Technical Bulletin 133 is a flammability test for seating. Krug offers a compliance method, in combination with non-flammable upholstery covers, may enable products to meet certification requirements for this test. This process at the same time also provides the products with a Moisture Barrier - a treatment that helps to prevent the passage of liquids and moisture to inside of the upholstered components - thereby conferring sanitary and anti-infection benefits. So when CAL 133 is specified, the product also automatically has a Moisture Barrier, and when a Moisture Barrier is specified, the product also features the compliance method and low flammability features of CAL 133. The application of this up-charge and the compliance method does not mean that the specific configuration of product and upholstery cover are tested and officially certified as being CAL133 compliant. If the official certification is required, Krug will provide this (through an independent certified testing laboratory) at a charge of \$917 per item, plus the cost of the product to be tested. Lead time for certification testing is typically 4-8 weeks.

JORDAN | ACTIVE PATIENT RECLINER

DESCRIPTION	MODEL	COM		COL		FABRIC GRADES		LEATHER	
		1	2	3	4	5	6	7	8

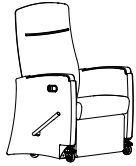

Active Patient Recliner, 21", no options
 JOR6APR210000 2982 3142 3308 3536 3797 4028 4289 4616 4944



Active Patient Recliner, 21", with Ottoman Poly Cover
 JOR6APR210010 3055 3219 3383 3610 3874 4103 4365 4692 5021

ORDERING NOTE: Options can be selected and added to the pre-configured models, using the pricing below



Active Patient Recliner, 21", with Push bar
 JOR6APR210001 3186 3349 3515 3742 4005 4235 4496 4822 5150

ORDERING NOTE: Options can be selected and added to the pre-configured models, using the pricing below

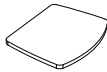

Active Patient Recliner, 21", with Flip up Tablet
 JOR6APR212000 3396 3560 3723 3953 4214 4443 4707 5033 5361

ORDERING NOTE: Options can be selected and added to the pre-configured models, using the pricing below

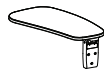
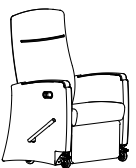

Active Patient Recliner, 21", with Swing Away Tablet
 JOR6APR211000 3439 3604 3767 3996 4258 4486 4749 5078 5403

ORDERING NOTE: Options can be selected and added to the pre-configured models, using the pricing below



Active Patient Recliner, 21", with Thermal Comfort
 JOR6APR210100 3846 4008 4173 4401 4665 4893 5154 5482 5810

ORDERING NOTE: Options can be selected and added to the pre-configured models, using the pricing below

Active Patient Recliner Option Upcharges	\$ List	\$ List
Moisture Barrier & CAL 133 (per yard)	64	Solid Surface Arm Cap (per pair) - Gr A White
Ottoman Poly Cover	77	Solid Surface Arm Cap (per pair) - Gr A Color
Push Bar	207	Solid Surface Arm Cap (per pair) - Gr B
Removable Seat Cover	121	Solid Surface Arm Cap (per pair) - Gr C
Removable Back Cover	137	Note: To change Urethane arm cap to Solid Surface option
IV Pole and Holder	380	add an "S" to the model number and the upcharge above.
Flip Up Tablet	416	Patient Transfer Arm
Swing Away Tablet	458	Thermal Comfort
		889
		927

PRODUCT CODE KEY

Line	Series	Chair Type	Size	Tablets	Thermal Comfort	Ottoman	Push bar
JOR	6	APR	21	0	0	0	0
Jordan	Motion	Recliner		None	None	No Cover	None
			24	1	1	1	1
				Swing	Thermal Comfort	Poly Cover	Push bar Included
				2			
				Flip up Tablet			

JORDAN | ACTIVE PATIENT RECLINER

DESCRIPTION	MODEL	COM		COL		FABRIC GRADES			LEATHER	
		1	2	3	4	5	6	7	8	9



Active Patient Recliner, 24", no options JOR6APR240000	3030	3203	3374	3617	3892	4132	4407	4755	5098
---	------	------	------	------	------	------	------	------	------



Active Patient Recliner, 24", with Ottoman Poly Cover JOR6APR240010	3104	3278	3452	3691	3966	4208	4485	4830	5174
--	------	------	------	------	------	------	------	------	------

ORDERING NOTE: Options can be selected and added to the pre-configured models, using the pricing below



Active Patient Recliner, 24", with Push bar JOR6APR240001	3236	3409	3580	3822	4098	4339	4615	4961	5305
--	------	------	------	------	------	------	------	------	------

ORDERING NOTE: Options can be selected and added to the pre-configured models, using the pricing below

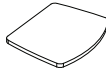

Active Patient Recliner, 24", with Flip up Tablet JOR6APR242000	3445	3618	3789	4033	4309	4547	4823	5170	5513
--	------	------	------	------	------	------	------	------	------

ORDERING NOTE: Options can be selected and added to the pre-configured models, using the pricing below



Active Patient Recliner, 24", with Swing Away Tablet JOR6APR241000	3489	3663	3831	4074	4352	4592	4868	5214	5559
---	------	------	------	------	------	------	------	------	------

ORDERING NOTE: Options can be selected and added to the pre-configured models, using the pricing below



Active Patient Recliner, 24", with Thermal Comfort JOR6APR240100	3894	4067	4239	4483	4757	4998	5275	5619	5965
---	------	------	------	------	------	------	------	------	------





ORDERING NOTE: Options can be selected and added to the pre-configured models, using the pricing below

Active Patient Recliner Option Upcharges		\$ List	\$ List	
Moisture Barrier & CAL 133 (per yard)		64	Solid Surface Arm Cap (per pair) - Gr A White	452
Ottoman Poly Cover		77	Solid Surface Arm Cap (per pair) - Gr A Color	458
Push Bar		207	Solid Surface Arm Cap (per pair) - Gr B	481
Removable Seat Cover (per seat)		121	Solid Surface Arm Cap (per pair) - Gr C	507
Removable Back Cover		137	Note: To change Urethane arm cap to Solid Surface option	
IV Pole and Holder		380	add an "S" to the model number and the upcharge above.	
Flip Up Tablet		416	Patient Transfer Arm	889
Swing Away Tablet		458	Thermal Comfort	927

PRODUCT CODE KEY

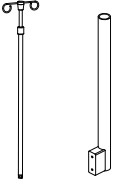
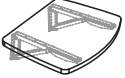
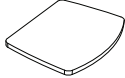
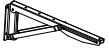
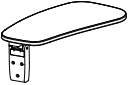
Line	Series	Chair Type	Size	Tablets	Thermal Comfort	Ottoman	Push bar
JOR	6	APR	21	0	0	0	0
Jordan	Motion	Recliner		None	None	No Cover	None
			24	1	1	1	1
				Swing	Thermal Comfort	Poly Cover	Push bar Included
				2			
				Flip up Tablet			

JORDAN | ACTIVE PATIENT RECLINER ACCESSORIES & REPLACEMENT COMPONENTS

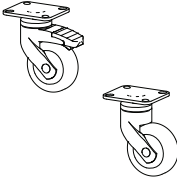
DESCRIPTION	MODEL	PRICE	WEIGHT	CUBES	
	IV Pole JOR8-RCRIP	292	3.8	1.4	
	IV Pole Holder JOR8-RCRIPB	91	2	0.2	
	Flip Up Tablet with brackets JOR8-RCRTK (wood or laminate)	416	6.6	1.6	
	Flip Up Tablet JOR8-RCRT (wood or laminate)	334	18"w x 14"d x .75"h	5.8	1.4
	Flip Up Tablet Bracket JOR8-RCRTH	119	0.8	0.2	
	Swing Away Tablet with Mechanism JOR8-SRST (wood or laminate)	458	24"w x 14.75"d x .75"h	20	1.2
	Swing Away Tablet Only JOR8-SRRT (wood or laminate)	238	7	0.8	
	Swing Away Tablet Mechanism Only JOR8-SRRTH	301	13	1	
	Push Bar JOR8-SRRPB	205	2	0.3	
	In-line Front caster – Locking JOR6-APRRCASFL	47	2	0.2	
	Swivel Rear caster – Locking JOR6-APRRCASRL	100	2	0.2	
	Swivel Rear caster – Non-locking JOR6-APRRCASRN	95	2	0.2	

JORDAN | ENVIRONMENTAL SUMMARY

LEED CI CREDITS



MATERIAL CONTENT:

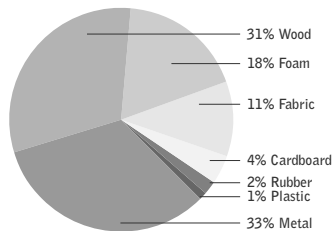

PRE-CONSUMER
RECYCLED CONTENT = 6.5%

POST-CONSUMER
RECYCLED CONTENT = 13%

Up to 35.4% of this Jordan product is recyclable at the end of its useful life.

CONTRIBUTES TO

CREDIT 2.1 - 2.2	Construction Waste Management	1-2 point(s)
CREDIT 3.3	Resource Reuse	1 point
CREDIT 4.1	Recycled Content	1 point
CREDIT 4.5	Low Emitting Materials, Systems & Seating	1 point
CREDIT 5.1	Regional Materials*	1 point
CREDIT 7	Certified Wood (MUST BE REQUESTED)	1 point(s)

*This credit is only applicable if in total 20% of the combined value of the procurement of construction materials and in the furniture are manufactured within a radius of 500 miles. This credit will apply if the installation of the finished product occurs within 500 miles of Kitchener, Ontario.

level® CERTIFICATION, AIR EMISSIONS AND FSC® CERTIFICATION



level® CERTIFICATION

BIFMA's e3 Furniture Sustainability Standard is a voluntary, multi-attribute standard that measures the degree of sustainability of furniture. This standard evaluates product and company environmental attributes and compliance systems in a wide range of elements which include Materials, Energy & Atmosphere, Human & Ecosystem Health and Social Responsibility. Jordan products have earned level®, BIFMA's sustainability certification program for furniture, certification through third-party verification against the e3 standard.

AIR-EMISSIONS

All Jordan products are supplied with air-emissions certified. Contact customer service for information.



FSC®

In 2005, Krug received Forest Stewardship Council® (FSC®) Chain-of-Custody certification for our manufacturing facilities. The FSC® Chain-of-Custody tracks certified wood from seedling to final sale. It verifies that the material for our FSC® certified products only come from well-managed, FSC®-certified forests and other controlled sources. FSC® is dedicated to the promotion of responsible forest management worldwide helping to take care of forests for future generations. Jordan and other Krug products can be specified with FSC® Certification. Contact customer service for further information, pricing and lead times.



Architects, designers, and building professionals can specify FSC®-certified products in order to achieve a point from the U.S. Green Building Council's Leadership in Energy and Environmental Design (LEED) Rating System.

JORDAN | 3-POSITION RECLINER - DIMENSIONS & COM REQUIREMENTS

DIMENSIONS

	Overall Width with 3-Position Mechanism	Overall Width with 3-Position Mechanism with Trendelenburg	Overall Width with Cushioned Armrest	Overall Width with Accessories	Overall Depth	Overall Depth when Reclined	Overall Height	Seat Height	Height of Arms from Floor	Width Between Arms	Seat Depth	Shipping Weight	Cube
3-Position Recliner	29.5	31.5	32	34.5	35	64	45.5	19.5	28.25	23	20	175	27

COM REQUIREMENTS

		COM Yardage Complete Unit	COM Yardage Seat Only	COM Yardage Back Only	COM Yardage Arm Panel Only	COM Yardage Footrest Upholstered Pad Only	Cushioned Armrest Only
Recliner	One Chair	6	1.0	2.5	2.8	0.6	.75
	Two Chairs	12	2.0	5	5.6	1.2	1.5
	Three Chairs	18	3.0	7.5	8.4	1.8	2.25
	Four Chairs	24	4.0	10	11.2	2.4	3

WEIGHT CAPACITIES: Jordan 3-Position Recliner has a maximum weight rating of 350 lbs under normal use (i.e. no excessive force in the use of the product).

JORDAN | 3-POSITION RECLINER - FEATURES & OPTIONS



HIGH DURABILITY MECHANISM

Jordan 3-Position Recliner mechanisms are designed for high-traffic, intensive use in care-giving environments. They are built with high-strength steel, and include Delrin™ wear pads between moving components for added smoothness and longevity.



ENHANCED CUSHIONING

The Jordan Recliners have been upgraded with a softer seat, a more pronounced headrest, and contoured back shaping for improved support. These enhancements, along with the addition of dual-density foam, make these recliners the leader in patient comfort.



RECLINER - 3-POSITION MECHANISM

This mechanism provides 3 distinct user positions:

Position A - Seated with feet on the floor, footrest in down (closed) position. Seat-back angle is 104 degrees, and the back is reclined 20 degrees from vertical.

Position B - Footrest is fully extended, back is in mid-position. Seat-back angle remains at 104 degrees, and the back is 25 degrees from vertical.

Position C - Full recline with footrest fully extended. Seat-back angle is opened to 125 degrees, and the back is 45 degrees from vertical.

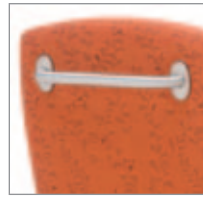

PUSH BAR

This is a standard feature on the Jordan 3-Position Recliner when ordered with casters. Ergonomically designed to assist care-giving staff in the movement and operation of the recliner, and reduce back strain on the caregiver.



MECHANISM WITH TRENDELEBURG

This mechanism provides the same positions described above, as well as the additional Trendelenburg position: full recline with footrest fully extended, seat-back angle remains at 125 degrees, but the back is now 65 degrees from vertical - resulting in the feet being above the head. It is activated by a foot-release lever that is accessible from either side of the recliner. Not available on Jordan Recliner Plus.



ARM OPTIONS

Jordan features 8 arm style options; fully upholstered, fully upholstered with urethane or solid surface arm cap, wood, wood with urethane or solid surface arm cap, full urethane and cushioned arm rest. The arm cap option provides enhanced durability and protection for the arms. The arm cap is field replaceable if damaged or degraded. Please see page 631 for color selections.



LEGS

Jordan Recliners are available with wood legs - in either Beech or Maple. Two options exist for glides on the Jordan Recliners. The white nylon glides are ideal for use on flooring that is easily marked. The stainless steel glides should be utilized for all other types floor surfaces. The stainless steel glide is provided when ordering the Jordan Recliners unless the white nylon glide is specified. The white nylon glide is available at the same price as the stainless steel option.

CLEANING & INFECTION CONTROL

Specifically designed to ease the cleaning and disinfection of the recliner and the floor underneath. Upholstery covers can be made removable, and individual components are automatically removable, to enable thorough cleaning and disinfection.

JORDAN | 3-POSITION RECLINER - OPTIONS



FOLEY HOOK

This recessed, retractable hook system provides a mounting system for catheter bags. It is spring-loaded to automatically retract when not in use, to eliminate any hazard.



IV POLE & HOLDER

The Jordan IV Pole is height adjustable (in a range of 27"), and can be added in the field. It can be located in any of four locations (left or right, front or back) -if ordered with the recliner, the location must be specified at time of order.



CUSHIONED ARMREST

The Cushioned Armrest was designed to maximize patient comfort during infusion treatments. The extra padded and wider arms provide comfort and support over long periods of time. Arms can be ordered in Krug standard healthcare rated grey vinyl or in coordinating textiles.



FLIP UP TABLET

The tablet's size is 18" x 14" x 3/4", and it can be located on either side of the recliner (must be specified if being ordered with the recliner). It is available in Beech and Maple Veneer, as well as Plastic Laminate with a Polymer edge. It folds flat (protruding 3" from the side of the recliner when flat). Please specify whether a right-handed or left-handed position is needed when ordering. Tablet must be mounted on the opposite side when a Patient Transfer Arm is ordered.



SWING AWAY TABLET

The Swing Away Tablet (24" x 14 3/4" x 3/4") is designed to be easily operated by the caregiver or user. The Break Away design allows for the tablet to be easily pushed away from the user in an emergency to gain quick access to the patient. The tablet has the ability to slide up and fold over and rotates 180 degrees. The kidney-shaped design is ideal for use as an eating, writing or work surface. The Footrest activation lever is specified either left or right handed based on a position facing the unit and opposite to where the tablet appears.

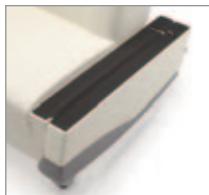

PATIENT TRANSFER ARM

The Patient Transfer Arm is designed to fold down where the arm is level with the chair seat. This design allows the caregiver to easily transport patients from the chair to bed. The arm is folded down by accessing the adjustment lever at the side of the chair. The Patient Transfer Arm is specified in a right or left handed position based on facing the unit. The Patient Transfer Arm cannot be located on the same side as footrest lever or accessories. Dual patient transfer arms cannot be specified with CCLS or accessories.



FOOT TRAY

This option provides a concealed, pull-out tray to assist patients with ingress and egress. It features a non-slip tread and dedicated casters that prevent tipping when standing on the tray.



THERMAL COMFORT

Providing warmth to patients undergoing chemotherapy and other treatments can be vitally important. Thermal Comfort is an option available on all Jordan Recliners, and features a hand-held controller located on the inside arm of the recliner (please specify right hand side or left hand side -facing). It provides two heat zones: one in the seat and one in the back. Back and seat zones can be controlled independently, to one of two heat settings. Controls are conveniently placed for the user to access and include a safety time-out feature after 30 minutes. Access to a 110/120 volt, 15 amp(min) electrical outlet is required.



POWER CONTROL

Optional motorized recline is available on Jordan 3-Position Recliner. The Recliner features a single function control which operates the back and ottoman simultaneously. The control location is standard on the inside left (facing) of the arm, alternately can be specified on the right if required, must be clearly noted on the Purchase Order. Power can also be specified with a lithium battery pack able to run 200 cycles on a full charge.



CASTERS

The standard castor is 4" in diameter, soft-wheel, full swivel, with a lock that in a single action locks both the swivel and rotation of the castor. The Central Locking castor has the same features, with a hooded design.



CENTRAL CASTER LOCKING SYSTEM

Allows for single action locking of all four casters at one time. Casters are locked both directionally and rotationally, keeping the recliner in place when locked. The color-coded external foot pedal indicates Red for the locked position (when lowered) and Green for the unlocked position (when unlowered). The standard position for the foot pedal is located at the rear outside of the left (facing) arm panel. It can optionally be located at the front outside of the arm panel (either side) or at rear of right (facing) arm panel. Central locking casters are 4" diameter with soft wheel treads. Purchase orders must indicate Central Caster Locking System option, note the requested position, and include the upcharge - see pricing pages for upcharge info.





REPLACEMENT & REMOVABLE COVERS

Jordan 3-Position Recliner chairs are available with removable seat and back covers for an upcharge. Removable seat and back covers can be quickly installed on Jordan products that were originally ordered with the removable cover option. Removable seat and back covers can also be installed on Jordan products that were not originally ordered with the Removable cover option, with some simple staple removal on the original seats and backs..

COMBINATION UPHOLSTERY OPTIONS

When combination upholstery is specified with fabric of the same grade or COM, an upcharge for dual fabrics is **\$33 list** per unit and **\$64 list** per unit for three fabrics will be applied. When graded in combination upholstery is selected, use the highest grade upholstery selected or to obtain a quote for blended grading contact Customer Service (please provide the fabrics specified and location of where each fabric is to be applied on the product).

JORDAN | 3-POSITION RECLINER

DESCRIPTION/MODEL	Species	COM		COL			FABRIC GRADES			LEATHER	
		1	2	3	4	5	6	7	8	9	
	Upholstered Arm, 3-Position Mechanism, with legs										
	JOR8-RCUPH12	Beech	3490	3683	3873	4142	4447	4718	5023	5407	5789
	(no push bar)	Maple	3513	3707	3895	4167	4470	4740	5045	5429	5812
	Upholstered Arm, 3-Position Mechanism with Trendelenburg, with legs										
	JOR8-RCUPH22	Beech	3583	3776	3966	4237	4542	4813	5116	5502	5885
	(no push bar)	Maple	3607	3799	3991	4260	4565	4835	5140	5525	5906
	Upholstered Arm, 3-Position Mechanism, with casters										
	JOR8-RCUPH11	n/a	3568	3762	3954	4222	4529	4796	5105	5488	5869
	Upholstered Arm, 3-Position Mechanism with Trendelenburg, with casters										
	JOR8-RCUPH21	n/a	3665	3856	4047	4317	4622	4891	5196	5582	5965

ORDERING NOTES:

All Jordan Recliners components are specified either left or right handed based on a position facing the unit. Jordan Recliners ship with the back apart from the chair folded down inside the packaging.





Jordan Recliner Option Upcharges	\$ List	List
Moisture Barrier (per yard)	64	Power Mechanism - Corded 958
Removable Seat Cover (per seat)	118	Power Mechanism - Battery 1290
Removeable Back Cover	129	Power Trendelenburg Mechanism - Corded 1061
Patient Transfer Arm	932	Power Trendelenburg Mechanism - Battery 1405
Foley Catheter Hook	215	Replacement Battery 620
IV Pole & Holder	380	Solid Surface Arm Cap (per pair) - Gr A White 517
Flip Up Tablet	416	Solid Surface Arm Cap (per pair) - Gr A Color 527
Swing Away Tablet	458	Solid Surface Arm Cap (per pair) - Gr B 548
Central Caster Locking System	1074	Solid Surface Arm Cap (per pair) - Gr C 577
Thermal Comfort	927	
Combination Upholstery Option - 2 fabrics	33	
Combination Upholstery Option - 3 fabrics	64	

Note: For Solid Surface option replace arm type with "USS" in the model number and add the upcharge above.

PRODUCT CODE KEY

Line	Series	Chair Type	Arm Type	Mechanism	Style
JOR	8	RC	UPH	1	1
Jordan	Motion	Recliner	Upholstered Arm	3-Position Mechanism	Casters
		PRC	USS	2	2
		Power Recliner	Upholstered Arm with Solid Surface Cap	3-Position with Trendelenburg Mechanism	Wood Legs
			TUP		3
			Transfer - Upholstered Arm		Central Locking Casters
			TUS		
			Transfer - Upholstered Arm with Solid Surface Cap		

JORDAN | 3-POSITION RECLINER

DESCRIPTION/MODEL	Species	COM		COL			FABRIC GRADES			LEATHER	
		1	2	3	4	5	6	7	8	9	
	Upholstered Arm with Urethane Cap, 3-Position Mechanism, with legs										
	JOR8-RCUUR12	Beech	3587	3781	3972	4240	4546	4816	5121	5505	5888
	(no push bar)	Maple	3610	3805	3994	4265	4569	4838	5143	5527	5911
	Upholstered Arm with Urethane Cap, 3-Position Mechanism with Trendelenberg, with legs										
	JOR8-RCUUR22	Beech	3682	3874	4065	4335	4639	4910	5214	5600	5983
	(no push bar)	Maple	3706	3897	4088	4358	4663	4932	5238	5623	6004
	Upholstered Arm with Urethane Cap, 3-Position Mechanism, with casters										
	JOR8-RCUUR11	n/a	3667	3860	4051	4319	4627	4895	5203	5587	5967
	Upholstered Arm with Urethane Cap, 3-Position Mechanism with Trendelenberg, with casters										
	JOR8-RCUUR21	n/a	3763	3955	4146	4416	4720	4990	5295	5680	6063

ORDERING NOTES:





All Jordan Recliners components are specified either left or right handed based on a position facing the unit. Jordan Recliners ship with the back apart from the chair folded down inside the packaging.

Jordan Recliner Option Upcharges	\$ List	\$ List
Moisture Barrier (per yard)	64	
Removable Seat Cover (per seat)	118	Power Mechanism - Corded
Removeable Back Cover	129	Power Mechanism - Battery
Patient Transfer Arm	932	Power Trendelenburg Mechanism - Corded
Foley Catheter Hook	215	Power Trendelenburg Mechanism - Battery
IV Pole & Holder	380	Replacement Battery
Flip Up Tablet	416	
Swing Away Tablet	458	
Central Caster Locking System	1074	
Thermal Comfort	927	
Combination Upholstery Option - 2 fabrics	33	
Combination Upholstery Option - 3 fabrics	64	

PRODUCT CODE KEY

Line	Series	Chair Type	Arm Type	Mechanism	Style
JOR	8	RC	UUR	1	1
Jordan	Motion	Recliner	Upholstered Arm with Urethane Cap	3-Position Mechanism	Casters
		PRC		2	2
		Power Recliner	Transfer - Upholstered Arm with Urethane Cap	3-Position with Trendelenberg Mechanism	Wood Legs
					3
					Central Locking Casters

JORDAN | 3-POSITION RECLINER

DESCRIPTION/MODEL	Species	COM		COL			FABRIC GRADES			LEATHER	
		1	2	3	4	5	6	7	8	9	
	Full Urethane Arm, 3-Position Mechanism, with legs										
	JOR8-RCFUR12	Beech	3609	3803	3994	4263	4568	4838	5143	5527	5910
	(no push bar)	Maple	3633	3827	4016	4287	4591	4860	5166	5549	5933
	Full Urethane Arm, 3-Position Mechanism with Trendelenburg, with legs										
	JOR8-RCFUR22	Beech	3704	3896	4087	4357	4662	4932	5236	5622	6006
	(no push bar)	Maple	3728	3919	4110	4380	4685	4954	5260	5645	6027
	Full Urethane Arm, 3-Position Mechanism, with casters										
	JOR8-RCFUR11	n/a	3689	3882	4074	4341	4649	4917	5225	5609	5989
	Full Urethane Arm, 3-Position Mechanism with Trendelenburg, with casters										
	JOR8-RCFUR21	n/a	3785	3977	4168	4438	4742	5012	5317	5702	6085

ORDERING NOTES:





All Jordan Recliners components are specified either left or right handed based on a position facing the unit. Jordan Recliners ship with the back apart from the chair folded down inside the packaging.

Jordan Recliner Option Upcharges	\$ List	\$ List
Moisture Barrier (per yard)	64	Power Mechanism - Corded
Removable Seat Cover (per seat)	118	Power Mechanism - Battery
Removeable Back Cover	129	Power Trendelenburg Mechanism - Corded
Patient Transfer Arm	932	Power Trendelenburg Mechanism - Battery
Foley Catheter Hook	215	Replacement Battery
IV Pole & Holder	380	
Flip Up Tablet	416	
Swing Away Tablet	458	
Central Caster Locking System	1074	
Thermal Comfort	927	
Combination Upholstery Option - 2 fabrics	33	
Combination Upholstery Option - 3 fabrics	64	

PRODUCT CODE KEY

Line	Series	Chair Type	Arm Type	Mechanism	Style
JOR	8	RC	FUR	1	1
Jordan	Motion	Recliner	Full Urethane	3-Position Mechanism	Casters
		PRC	TFU	2	2
		Power Recliner	Transfer - Full Urethane	3-Position with Trendelenburg Mechanism	Wood Legs
					3
					Central Locking Casters

JORDAN | 3-POSITION RECLINER

DESCRIPTION/MODEL	Species	COM		COL			FABRIC GRADES			LEATHER	
		1	2	3	4	5	6	7	8	9	
 Wood Arm, 3-Position Mechanism with legs (no push bar) JOR8-RCWOD12	Beech	3714	3908	4098	4368	4672	4943	5248	5632	6014	
	Maple	3798	3992	4182	4450	4756	5027	5331	5716	6098	
 Wood Arm, 3-Position Mechanism with Trendelenburg with legs (no push bar) JOR8-RCWOD22	Beech	3808	4001	4192	4462	4767	5037	5341	5726	6111	
	Maple	3892	4085	4275	4546	4851	5121	5425	5810	6193	
 Wood Arm, 3-Position Mechanism with Casters JOR8-RCWOD11	Beech	3794	3986	4179	4446	4754	5021	5329	5714	6094	
	Maple	3818	4011	4203	4470	4778	5045	5353	5738	6118	
 Wood Arm, 3-Position Mechanism with Trendelenburg with Casters JOR8-RCWOD21	Beech	3890	4082	4272	4543	4846	5117	5421	5807	6189	
	Maple	3914	4106	4296	4567	4870	5141	5446	5831	6213	

ORDERING NOTES:

All Jordan Recliners components are specified either left or right handed based on a position facing the unit. Jordan Recliners ship with the back apart from the chair folded down inside the packaging.





Jordan Recliner Option Upcharges	\$ List	\$ List
Moisture Barrier (per yard)	64	Power Mechanism - Corded
Removable Seat Cover (per seat)	118	Power Mechanism - Battery
Removeable Back Cover	129	Power Trendelenburg Mechanism - Corded
Patient Transfer Arm	932	Power Trendelenburg Mechanism - Battery
Foley Catheter Hook	215	Replacement Battery
IV Pole & Holder	380	Solid Surface Arm Cap (per pair) - Gr A White
Flip Up Tablet	416	Solid Surface Arm Cap (per pair) - Gr A Color
Swing Away Tablet	458	Solid Surface Arm Cap (per pair) - Gr B
Central Caster Locking System	1074	Solid Surface Arm Cap (per pair) - Gr C
Thermal Comfort	927	
Combination Upholstery Option - 2 fabrics	33	
Combination Upholstery Option - 3 fabrics	64	

Note: For Solid Surface option replace arm type with "SSC" in the model number and add the upcharge above.

PRODUCT CODE KEY

Line	Series	Chair Type	Arm Type	Mechanism	Style
JOR	8	RC	WOD	1	1
Jordan	Motion	Recliner	Wood Arm	3-Position Mechanism	Casters
		PRC	SSC	2	2
		Power Recliner	Wood Arm with Solid Surface Cap	3-Position with Trendelenburg Mechanism	Wood Legs
			TWD		3
			Transfer - Wood Arm		Central Locking Casters
			TSS		
			Transfer - Wood Arm with Solid Surface Cap		

JORDAN | 3-POSITION RECLINER

DESCRIPTION/MODEL	Species	COM		COL			FABRIC GRADES			LEATHER	
		1	2	3	4	5	6	7	8	9	
 Wood Arm with Urethane Cap, 3-Position Mechanism with legs JOR8-RCURE12	Beech	3844	4037	4227	4496	4801	5072	5377	5761	6143	
	(no push bar) Maple	3928	4120	4311	4580	4885	5155	5461	5845	6227	
 Wood Arm with Urethane Cap, 3-Position Mechanism with Trendelenburg with legs JOR8-RCURE22	Beech	3937	4130	4321	4591	4896	5167	5470	5855	6240	
	(no push bar) Maple	4021	4214	4404	4675	4979	5251	5553	5939	6323	
 Wood Arm with Urethane Cap, 3-Position Mechanism with casters JOR8-RCURE11	Beech	3922	4116	4308	4575	4883	5150	5458	5843	6223	
	Maple	3948	4140	4332	4600	4907	5174	5483	5867	6247	
 Wood Arm with Urethane Cap, 3-Position Mechanism with Trendelenburg with casters JOR8-RCURE21	Beech	4019	4211	4401	4671	4975	5245	5550	5936	6318	
	Maple	4043	4235	4425	4696	5000	5271	5574	5960	6343	

ORDERING NOTES:





All Jordan Recliners components are specified either left or right handed based on a position facing the unit. Jordan Recliners ship with the back apart from the chair folded down inside the packaging.

Jordan Recliner Option Upcharges	\$ List	\$ List
Moisture Barrier (per yard)	64	
Removable Seat Cover (per seat)	118	Power Mechanism - Corded
Removeable Back Cover	129	Power Mechanism - Battery
Patient Transfer Arm	932	Power Trendelenburg Mechanism - Corded
Foley Catheter Hook	215	Power Trendelenburg Mechanism - Battery
IV Pole & Holder	380	Replacement Battery
Flip Up Tablet	416	
Swing Away Tablet	458	
Central Caster Locking System	1074	
Thermal Comfort	927	
Combination Upholstery Option - 2 fabrics	33	
Combination Upholstery Option - 3 fabrics	64	

PRODUCT CODE KEY

Line	Series	Chair Type	Arm Type	Mechanism	Style
JOR	8	RC	URE	1	1
Jordan	Motion	Recliner	Wood Arm with Urethane Cap	3-Position Mechanism	Casters
		PRC	TUR	2	2
		Power Recliner	Transfer - Wood Arm with Urethane Cap	3-Position with Trendelenburg Mechanism	Wood Legs
					3
					Central Locking Casters

JORDAN | 3-POSITION RECLINER

DESCRIPTION/MODEL	Species	COM		COL			FABRIC GRADES			LEATHER		
		1	2	3	4	5	6	7	8	9		
	Cushioned Armrest, 3-Position Mechanism with legs (no push bar)											
	JOR8-RCINF12	Beech	3843	4036	4226	4495	4800	5071	5376	5760	6142	
		Maple	3866	4060	4248	4520	4823	5093	5398	5782	6165	
	Cushioned Armrest, 3-Position Mechanism with Trendelenburg with legs (no push bar)											
	JOR8-RCINF22	Beech	3936	4129	4319	4590	4895	5166	5469	5854	6238	
		Maple	3960	4152	4343	4613	4918	5188	5493	5877	6259	
	Cushioned Armrest, 3-Position Mechanism with casters											
	JOR8-RCINF11	n/a	3921	4114	4307	4574	4882	5149	5457	5841	6222	
	Cushioned Armrest, 3-Position Mechanism with Trendelenburg with casters											
	JOR8-RCINF21	n/a	4018	4209	4400	4670	4974	5244	5549	5935	6317	

ORDERING NOTES:

All Jordan Recliners components are specified either left or right handed based on a position facing the unit. Jordan Recliners ship with the back apart from the chair folded down inside the packaging.

Jordan Recliner Option Upcharges	\$ List	\$ List
Moisture Barrier (per yard)	64	
Removable Seat Cover (per seat)	118	Power Mechanism - Corded
Removeable Back Cover	129	Power Mechanism - Battery
Patient Transfer Arm	932	Power Trendelenburg Mechanism - Corded
Foley Catheter Hook	215	Power Trendelenburg Mechanism - Battery
IV Pole & Holder	380	Replacement Battery
Flip Up Tablet	416	
Swing Away Tablet	458	
Central Caster Locking System	1074	
Thermal Comfort	927	
Combination Upholstery Option - 2 fabrics	33	
Combination Upholstery Option - 3 fabrics	64	

COORDINATING CUSHIONED ARM OPTION - please add the following up charges for Cushioned Arm in coordinating fabric.

Fabric Grades	1	2	3	4	5	6	7	8	9
2 ARMS	22	47	70	121	171	220	269	319	418

PRODUCT CODE KEY

Line	Series	Chair Type	Arm Type	Mechanism	Style
JOR	8	RC	INF	1	1
Jordan	Motion	Recliner	Cushioned Armrest	3-Position Mechanism	Casters
		PRC		2	2
		Power Recliner		3-Position with Trendelenburg Mechanism	Wood Legs
			TIN		3
			Transfer - Cushioned Armrest		Central Locking Casters

DIMENSIONS

	Overall Width with 3-Position Mechanism	Overall Width with Cushioned Armrest	Overall Width with Accessories	Overall Depth	Overall Depth when Reclined	Overall Height	Seat Height	Height of Arms from Floor	Width Between Arms	Seat Depth	Shipping Weight	Cube	
Recliner Plus	39	-	41.5	44	35	72	45.5	19.5	28.25	28.75	20	202	36

COM REQUIREMENTS

	COM Yardage Complete Unit	COM Yardage Seat Only	COM Yardage Back Only	COM Yardage Arm Panel Only	COM Yardage Footrest Upholstered Pad Only	Cushioned Armrest Only
Recliner Plus	One Chair	7.7	1.31	3.10	2.8	.75
	Two Chairs	15.4	2.62	5.6	5.6	1.5
	Three Chairs	23.1	3.93	8.4	8.4	2.25
	Four Chairs	30.8	4.12	11.2	11.2	3

WEIGHT CAPACITIES :

Jordan Recliner Plus has a maximum weight rating of 500 lbs under normal use (i.e. no excessive force in the use of the product).

JORDAN | RECLINER PLUS FEATURES & OPTIONS



HIGH DURABILITY MECHANISM

Jordan Recliner Plus mechanisms are designed for high-traffic, intensive use in care-giving environments. They are built with high-strength steel, and include Delrin™ wear pads between moving components for added smoothness and longevity.

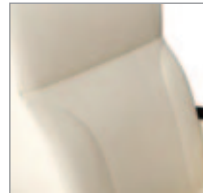

ENHANCED CUSHIONING

The Jordan Recliners have been upgraded with a softer seat, a more pronounced headrest, and contoured back shaping for improved support. These enhancements, along with the addition of dual-density foam, make these recliners the leader in patient comfort.



JORDAN RECLINER PLUS MECHANISM

This mechanism provides Infinitely Adjustable positions: Position A - Seated with feet on the floor, footrest in down (closed) position. Seat-back angle is 102 degrees. Position B - Footrest is fully extended, without compromising the upright position of the back. The seat-back angle remains at 102 degrees. Position C - is the range of infinite adjustability from the seated position of 102 degrees back angle to the fully reclined position at 133 degrees. The Infinitely Adjustable Back angle can be locked in any position with the back adjustment lever that goes to a maximum of 133 degrees when fully extended.



PUSH BAR

This is a standard feature on the Jordan recliner when ordered with casters. Ergonomically designed to assist care-giving staff in the movement and operation of the recliner, and reduce back strain on the caregiver.



LEGS

Jordan Recliners are available with wood legs - in either Beech or Maple. Two options exist for glides on the Jordan Recliners. The white nylon glides are ideal for use on flooring that is easily marked. The stainless steel glides should be utilized for all other types floor surfaces. The stainless steel glide is provided when ordering the Jordan Recliners unless the white nylon glide is specified. The white nylon glide is available at the same price as the stainless steel option.



BACK ADJUSTMENT LEVER

The Jordan Recliner Plus comes with the back adjustment lever which creates an infinite number of back adjustments within the chair. The back adjustment lever comes in a black plastic finish on the caregiver side. The standard position when ordering is left hand based on a position facing, the unit, unless specified otherwise.



FOOTREST LEVER

Jordan Recliner Plus comes with the footrest lever, which extends and closes the built-in footrest. The footrest lever comes in a powder-coated finish to match the casters. The standard position when ordering is a left hand position based on facing the unit, unless specified otherwise.

CLEANING & INFECTION CONTROL

Specifically designed to ease the cleaning and disinfection of the recliner and the floor underneath. Upholstery covers can be made removable, and individual components are automatically removable, to enable thorough cleaning and disinfection.



ARM OPTIONS

Jordan features 8 arm style options; fully upholstered, fully upholstered with urethane or solid surface arm cap, wood, wood with urethane or solid surface arm cap, full urethane and cushioned arm rest. The arm cap option provides enhanced durability and protection for the arms. The arm cap is field replaceable if damaged or degraded. Please see page 631 for color selections.

JORDAN | RECLINER PLUS FEATURES & OPTIONS



FOLEY HOOK

This recessed, retractable hook system provides a mounting system for catheter bags. It is spring-loaded to automatically retract when not in use, to eliminate any hazard.



IV POLE & HOLDER

The Jordan IV Pole is height adjustable (in a range of 27"), and can be added in the field. It can be located in any of four locations (left or right, front or back) -if ordered with the recliner, the location must be specified at time of order.



CUSHIONED ARMREST

The Cushioned Armrest was designed to maximize patient comfort during infusion treatments. The extra padded and wider arms provide comfort and support over long periods of time. Arms can be ordered in Krug standard healthcare rated grey vinyl or in coordinating textiles.



FLIP UP TABLET

The tablet's size is 18" x 14" x 3/4", and it can be located on either side of the recliner (must be specified if being ordered with the recliner). It is available in Beech and Maple Veneer, as well as Plastic Laminate with a Polymer edge. It folds flat (protruding 3" from the side of the recliner when flat). Please specify whether a right-handed or left-handed position is needed when ordering. Tablet must be mounted on the opposite side when a Patient Transfer Arm is ordered.



SWING AWAY TABLET

The Swing Away Tablet (24" x 14 3/4" x 3/4") is designed to be easily operated by the caregiver or user. The Break Away design allows for the tablet to be easily pushed away from the user in an emergency to gain quick access to the patient. The tablet has the ability to slide up and fold over and rotates 180 degrees. The kidney-shaped design is ideal for use as an eating, writing or work surface. The Footrest activation lever is specified either left or right handed based on a position facing the unit and opposite to where the tablet appears.



FOOT TRAY

This option provides a concealed, pull-out tray to assist patients with ingress and egress. It features a non-slip tread and dedicated casters that prevent tipping when standing on the tray.



THERMAL COMFORT

Providing warmth to patients undergoing chemotherapy and other treatments can be vitally important. Thermal Comfort is an option available on all Jordan Recliners, and features a hand-held controller located on the inside arm of the recliner (please specify right hand side or left hand side -facing). It provides two heat zones: one in the seat and one in the back. Back and seat zones can be controlled independently, to one of two heat settings. Controls are conveniently placed for the user to access and include a safety time-out feature after 30 minutes. Access to a 110/120 volt, 15 amp(min) electrical outlet is required.

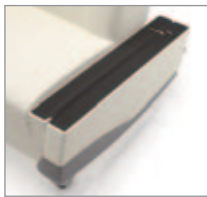

PATIENT TRANSFER ARM

The Patient Transfer Arm is designed to fold down where the arm is level with the chair seat. This design allows the caregiver to easily transport patients from the chair to bed. The arm is folded down by accessing the adjustment lever at the side of the chair. The Patient Transfer Arm is specified in a right or left handed position based on facing the unit. Please note, the Patient Transfer Arm cannot be located on the same side as IV Poles or the footrest lever or tablets.



CASTERS

The standard caster is 4" in diameter, soft-wheel, full swivel, with a lock that in a single action locks both the swivel and rotation of the caster. The Central Locking caster has the same features, with a hooded design.







CENTRAL CASTER LOCKING SYSTEM

Allows for single action locking of all four casters at one time. Casters are locked both directionally and rotationally, keeping the recliner in place when locked. The color-coded external foot pedal indicates Red for the locked position (when lowered) and Green for the unlocked position (when unlowered). The standard position for the foot pedal is located at the rear outside of the left (facing) arm panel. It can optionally be located at the front outside of the arm panel (either side) or at rear of right (facing) arm panel. Central locking casters are 4" diameter with soft wheel treads. Purchase orders must indicate Central Caster Locking System option, note the requested position, and include the upcharge - see pricing pages for upcharge info.

REMOVABLE COVERS AND REPLACEMENT COMPONENTS

Jordan Recliner Plus chairs are available with removable seat and back covers. Removable seat and back covers can be quickly installed on Jordan products that were originally ordered with the Removable cover option. Removable seat and back covers can also be installed on Jordan products that were not originally ordered with the Removable cover option, with some simple staple removal on the original seats and backs..

JORDAN | RECLINER PLUS

DESCRIPTION/MODEL	Species	COM		COL			FABRIC GRADES			LEATHER	
		1	2	3	4	5	6	7	8	9	
 Upholstered Arm, with legs JOR8-BSRUPH2 (no push bar)	Beech	5143	5391	5636	5979	6374	6717	7110	7605	8096	
	Maple	5168	5414	5659	6003	6397	6742	7134	7627	8119	
 Upholstered Arm, with casters JOR8-BSRUPH1	n/a	5343	5588	5834	6180	6573	6915	7310	7802	8293	
 Upholstered Arm with Urethane Cap, with legs JOR8-BSRUUR2 (no push bar)	Beech	5241	5490	5735	6077	6472	6816	7208	7703	8194	
	Maple	5265	5513	5758	6101	6495	6840	7233	7725	8217	
 Upholstered Arm with Urethane Cap, with casters JOR8-BSRUUR1	n/a	5441	5685	5933	6277	6670	7014	7408	7901	8391	

ORDERING NOTES:

All Jordan Recliners components are specified either left or right handed based on a position facing the unit. Jordan Sleep Recliners ship with the back apart from the chair folded down inside the packaging.





Jordan Recliner Plus Option Upcharges	\$ List	\$ List
Moisture Barrier (per yard)	64	Central Caster Locking System
Removable Plus Seat Cover	137	Combination Upholstery Option - 2 fabrics
Removeable Plus Back Cover	180	Combination Upholstery Option - 3 fabrics
Swing Away Tablet	458	Solid Surface Arm Cap (per pair) - Gr A White
IV Pole & Holder	380	Solid Surface Arm Cap (per pair) - Gr A Color
Flip Up Tablet	416	Solid Surface Arm Cap (per pair) - Gr B
Foley Catheter Hook	215	Solid Surface Arm Cap (per pair) - Gr C
Thermal Comfort	927	
Patient Transfer Arm	932	

Note: For Solid Surface option replace UPH arm type with "USS" in the model number and add the upcharge above.

PRODUCT CODE KEY

Line	Series	Chair Type	Arm Type	Style
JOR	8	BSR	UPH	1
Jordan	Motion	Recliner Plus	Upholstered Arm	Casters
			UUR	2
			Upholstered Arm with Urethane Cap	Legs
			USS	3
			Upholstered Arm with Solid Surface Cap	Central Locking Casters

JORDAN | RECLINER PLUS

DESCRIPTION/MODEL	Species	COM		COL			FABRIC GRADES			LEATHER	
		1	2	3	4	5	6	7	8	9	
 Full Urethane Arm, with legs JOR8-BSRFUR2 (no push bar)	Beech	5263	5512	5757	6099	6494	6838	7230	7725	8216	
	Maple	5287	5535	5780	6123	6517	6862	7255	7747	8239	
 Full Urethane Arm, with casters JOR8-BSRFUR1	n/a	5463	5707	5955	6300	6692	7036	7430	7923	8413	
 Wood Arm, with legs JOR8-BSRWOD2 (no push bar)	Beech	5368	5616	5861	6204	6599	6942	7335	7830	8321	
	Maple	5452	5700	5945	6288	6683	7026	7419	7913	8405	
 Wood Arm, with casters JOR8-BSRWOD1	Beech	5568	5812	6059	6405	6797	7140	7534	8028	8518	
	Maple	5592	5836	6083	6429	6821	7164	7558	8052	8542	

ORDERING NOTES:

All Jordan Recliners components are specified either left or right handed based on a position facing the unit. Jordan Sleep Recliners ship with the back apart from the chair folded down inside the packaging.





Jordan Recliner Plus Option Upcharges	\$ List	\$ List
Moisture Barrier (per yard)	64	Central Caster Locking System
Removable Plus Seat Cover	137	Combination Upholstery Option - 2 fabrics
Removeable Plus Back Cover	180	Combination Upholstery Option - 3 fabrics
Swing Away Tablet	458	Solid Surface Arm Cap (per pair) - Gr A White
IV Pole & Holder	380	Solid Surface Arm Cap (per pair) - Gr A Color
Flip Up Tablet	416	Solid Surface Arm Cap (per pair) - Gr B
Foley Catheter Hook	215	Solid Surface Arm Cap (per pair) - Gr C
Thermal Comfort	927	
Patient Transfer Arm	932	

Note: For Solid Surface option replace WOD arm type with "SSC" in the model number and add the upcharge above.

PRODUCT CODE KEY

Line	Series	Chair Type	Arm Type	Style
JOR	8	BSR	FUR	1
Jordan	Motion	Recliner Plus	Full Urethane	Casters
			WOD	2
			Wood Arm	Legs
			SSC	3
			Wood Arm with Solid Surface Cap	Central Locking Casters

JORDAN | RECLINER PLUS

DESCRIPTION/MODEL	Species	COM		COL			FABRIC GRADES			LEATHER	
		1	2	3	4	5	6	7	8	9	
 Wood Arm with Urethane Cap, with legs JOR8-BSRURE2 (no push bar)	Beech	5497	5745	5990	6333	6728	7071	7464	7960	8450	
	Maple	5581	5829	6074	6417	6811	7155	7548	8043	8534	
 Wood Arm with Urethane Cap, with casters JOR8-BSRURE1	Beech	5697	5941	6188	6534	6926	7269	7663	8156	8647	
	Maple	5721	5966	6212	6558	6951	7293	7688	8181	8671	
 Cushioned Armrest, with legs JOR8-BSRINF2 (no push bar)	Beech	5496	5744	5989	6332	6727	7070	7463	7957	8449	
	Maple	5520	5767	6012	6356	6750	7094	7487	7980	8472	
 Cushioned Armrest, with casters JOR8-BSRINF1		5696	5940	6187	6533	6925	7268	7662	8155	8646	

ORDERING NOTES:

All Jordan Recliners components are specified either left or right handed based on a position facing the unit. Jordan Sleep Recliners ship with the back apart from the chair folded down inside the packaging.

Jordan Recliner Plus Option Upcharges	\$ List	\$ List
Moisture Barrier (per yard)	64	Central Caster Locking System
Removable Plus Seat Cover	137	Combination Upholstery Option - 2 fabrics
Removeable Plus Back Cover	180	Combination Upholstery Option - 3 fabrics
Swing Away Tablet	458	
IV Pole & Holder	380	
Flip Up Tablet	416	
Foley Catheter Hook	215	
Thermal Comfort	927	
Patient Transfer Arm	932	

COORDINATING CUSHIONED ARM OPTION - please add the following up charges for Cushioned Arm in coordinating fabric.

Fabric Grades	1	2	3	4	5	6	7	8	9
2 ARMS	22	47	70	121	171	220	269	319	418

PRODUCT CODE KEY

Line	Series	Chair Type	Arm Type	Style
JOR	8	BSR	URE	1
Jordan	Motion	Recliner Plus	Wood Arm with Urethane Cap	Casters
			INF	2
			Cushioned Armrest	Legs
				3
				Central Locking Casters

JORDAN | SLEEP RECLINER

DIMENSIONS

	Overall Width w/ 4 Position Mechanism	Overall Width with Cushioned Armrest	Overall Width w/ Accessories both sides	Overall Depth	Overall Depth w/ Footrest Reclined	Overall Depth w/ Sleep Recline	Overall Height	Seat Height	Height of Arms from Floor	Width Between Arms	Seat Depth	Shipping Weight	Cubes
Sleep Recliner	32.25	34.5	38.25	37	54	72.5	45.5	19.5	28.25	23	20	175	27

WEIGHT CAPACITY: Jordan Sleep Recliner has a maximum weight rating of 350 lbs under normal use (i.e. no excessive force in the use of the product).

COM REQUIREMENTS

	COM Yardage for Complete Unit	COM Yardage Seat Only	COM Yardage Back Only	COM Yardage Arm Panel Only	COM Yardage Footrest Upholstered Pad Only	Cushioned Armrest Only
One Chair	5.8	1.0	2.5	2.8	0.4	.75
Two Chairs	11.6	2.0	5	5.6	0.8	1.5
Three Chairs	17.4	3.0	7.5	8.4	1.2	2.25
Four Chairs	23.2	4.0	10	11.2	1.6	3

JORDAN | SLEEP RECLINER FEATURES & OPTIONS



HIGH DURABILITY MECHANISM

Jordan Sleep Recliner mechanisms are designed for high-traffic, intensive use in care-giving environments. They are built with high-strength steel, and include Delrin™ wear pads between moving components for added smoothness and longevity.

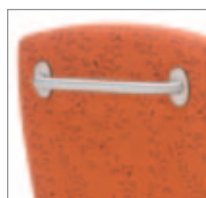

PUSH BAR

This is a standard feature on the Jordan recliner when ordered with casters. Ergonomically designed to assist care-giving staff in the movement and operation of the recliner, and reduce back strain on the caregiver.



JORDAN SLEEP RECLINERS MECHANISM

This mechanism provides Infinitely Adjustable positions: Position A - Seated with feet on the floor, footrest in down (closed) position. Seat-back angle is 102 degrees. Position B - Footrest is fully extended, without compromising the upright position of the back. The seat-back angle remains at 102 degrees. Position C - is the range of infinite adjustability from the seated position of 102 degrees back angle to the fully reclined position at 133 degrees. The Infinitely Adjustable Back angle can be locked in any position with the back adjustment lever that goes to a maximum of 175 degrees when fully extended.



BACK ADJUSTMENT LEVER

The Jordan Sleep Recliner comes with the back adjustment lever which creates an infinite number of back adjustments within the chair. The back adjustment lever comes in a black plastic finish on the caregiver side. The standard position when ordering is left hand based on a position facing, the unit, unless specified otherwise.



MECHANISM WITH TRENDELENBURG

This mechanism provides the same positions described above, as well as the additional Trendelenburg position: full recline with footrest fully extended, seat-back angle remains at 125 degrees, but the back is now 65 degrees from vertical - resulting in the feet being above the head. It is activated by a foot-release lever that is accessible from either side of the recliner. Not available on Recliner Plus.



FOOTREST LEVER

Jordan Sleep Recliner comes with the footrest lever, which extends and closes the built-in footrest. The footrest lever comes in a powder-coated finish to match the casters. The standard position when ordering is a left hand position based on facing the unit, unless specified otherwise.



ENHANCED CUSHIONING

The Jordan Recliners have been upgraded with a softer seat, a more pronounced headrest, and contoured back shaping for improved support. These enhancements, along with the addition of dual-density foam, make these recliners the leader in patient comfort.



ARM OPTIONS

Jordan features 8 arm style options; fully upholstered, fully upholstered with urethane or solid surface arm cap, wood, wood with urethane or solid surface arm cap, full urethane and cushioned arm rest. The arm cap option provides enhanced durability and protection for the arms. The arm cap is field replaceable if damaged or degraded. Please see page 631 for color selections.



CLEANING & INFECTION CONTROL

Specifically designed to ease the cleaning and disinfection of the recliner and the floor underneath. Upholstery covers can be made removable, and individual components are automatically removable, to enable thorough cleaning and disinfection.



LEGS

Jordan Sleep Recliners are available with wood legs - in either Beech or Maple. Two options exist for glides on the Jordan Sleep Recliners. The white nylon glides are ideal for use on flooring that is easily marked. The stainless steel glides should be utilized for all other types floor surfaces. The stainless steel glide is provided when ordering the Jordan Recliners unless the white nylon glide is specified. The white nylon glide is available at the same price as the stainless steel option.

JORDAN | SLEEP RECLINER FEATURES & OPTIONS



FOLEY HOOK

This recessed, retractable hook system provides a mounting system for catheter bags. It is spring-loaded to automatically retract when not in use, to eliminate any hazard.



IV POLE & HOLDER

The Jordan IV Pole is height adjustable (in a range of 27"), and can be added in the field. It can be located in any of four locations (left or right, front or back) -if ordered with the recliner, the location must be specified at time of order.



CUSHIONED ARMREST

The Cushioned Armrest was designed to maximize patient comfort during infusion treatments. The extra padded and wider arms provide comfort and support over long periods of time. Arms can be ordered in Krug standard healthcare rated grey vinyl or in coordinating textiles.



FLIP UP TABLET

The tablet's size is 18" x 14" x 3/4", and it can be located on either side of the recliner (must be specified if being ordered with the recliner). It is available in Beech and Maple Veneer, as well as Plastic Laminate with a Polymer edge. It folds flat (protruding 3" from the side of the recliner when flat). Please specify whether a right-handed or left-handed position is needed when ordering. Tablet must be mounted on the opposite side when a Patient Transfer Arm is ordered.



SWING AWAY TABLET

The Swing Away Tablet (24" x 14 3/4" x 3/4") is designed to be easily operated by the caregiver or user. The Break Away design allows for the tablet to be easily pushed away from the user in an emergency to gain quick access to the patient. The tablet has the ability to slide up and fold over and rotates 180 degrees. The kidney-shaped design is ideal for use as an eating, writing or work surface. The Footrest activation lever is specified either left or right handed based on a position facing the unit and opposite to where the tablet appears.

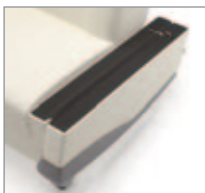

PATIENT TRANSFER ARM

The Patient Transfer Arm is designed to fold down where the arm is level with the chair seat. This design allows the caregiver to easily transport patients from the chair to bed. The arm is folded down by accessing the adjustment lever at the side of the chair. The Patient Transfer Arm is specified in a right or left handed position based on facing the unit. Please note, the Patient Transfer Arm cannot be located on the same side as IV Poles or the footrest lever or tablets.

COMBINATION UPHOLSTERY OPTIONS

When combination upholstery is specified with fabric of the same grade or COM, an upcharge for dual fabrics is **\$33 list** per unit and **\$64 list** per unit for three fabrics will be applied. When graded in combination upholstery is selected, use the highest grade upholstery selected or to obtain a quote for blended grading contact Customer Service (please provide the fabrics specified and location of where each fabric is to be applied on the product).



THERMAL COMFORT

Providing warmth to patients undergoing chemotherapy and other treatments can be vitally important. Thermal Comfort is an option available on all Jordan Recliners, and features a hand-held controller located on the inside arm of the recliner (please specify right hand side or left hand side -facing). It provides two heat zones: one in the seat and one in the back. Back and seat zones can be controlled independently, to one of two heat settings. Controls are conveniently placed for the user to access and include a safety time-out feature after 30 minutes. Access to a 110/120 volt, 15 amp(min) electrical outlet is required.



POWER CONTROL

Optional motorized recline is available on Jordan 3-Position Recliner. The Recliner features a single function control which operates the back and ottoman simultaneously. The control location is standard on the inside left (facing) of the arm, alternately can be specified on the right if required, must be clearly noted on the Purchase Order. Power can also be specified with a lithium battery pack able to run 200 cycles on a full charge.



CASTERS

The standard caster is 4" in diameter, soft-wheel, full swivel, with a lock that in a single action locks both the swivel and rotation of the caster. The Central Locking caster has the same features, with a hooded design.



CENTRAL CASTER LOCKING SYSTEM

Allows for single action locking of all four casters at one time. Casters are locked both directionally and rotationally, keeping the recliner in place when locked. The color-coded external foot pedal indicates Red for the locked position (when lowered) and Green for the unlocked position (when unlowered). The standard position for the foot pedal is located at the rear outside of the left (facing) arm panel. It can optionally be located at the front outside of the arm panel (either side) or at rear of right (facing) arm panel. Central locking casters are 4" diameter with soft wheel treads. Purchase orders must indicate Central Caster Locking System option, note the requested position, and include the upcharge - see pricing pages for upcharge info.







FOOT TRAY

This option provides a concealed, pull-out tray to assist patients with ingress and egress. It features a non-slip tread and dedicated casters that prevent tipping when standing on the tray.

REPLACEMENT & REMOVABLE COVERS

Jordan Sleep Recliners chairs are available with Removable Seat and Back Covers for an upcharge. Removable seat and back covers can be quickly installed on Jordan products that were originally ordered with the Removable cover option. Removable seat and back covers can also be installed on Jordan products that were not originally ordered with the Removable cover option, with some simple staple removal on the original seats and backs.

JORDAN | SLEEP RECLINER

DESCRIPTION/MODEL	Species	COM		COL				FABRIC GRADES			LEATHER	
		1	2	3	4	5	6	7	8	9		
	Upholstered Arm, with legs											
	JOR8-SRUPH24	Beech	4227	4414	4596	4857	5153	5412	5710	6079	6449	
	(no push bar)	Maple	4251	4436	4620	4882	5178	5437	5734	6104	6474	
	Upholstered Arm, with casters											
	JOR8-SRUPH14	n/a	4313	4499	4683	4943	5240	5498	5794	6164	6537	
	(no push bar)											
JOR8-SRUPH13	n/a	4339	4525	4709	4968	5263	5525	5822	6190	6563		
	Upholstered Arm with Urethane Cap, and legs											
	JOR8-SRUUR24	Beech	4326	4511	4694	4954	5252	5510	5808	6178	6546	
	(no push bar)	Maple	4350	4533	4718	4980	5277	5536	5831	6203	6573	
	Upholstered Arm with Urethane Cap, and casters											
	JOR8-SRUUR14	n/a	4412	4596	4780	5041	5339	5596	5893	6263	6634	
	(no push bar)											
JOR8-SRUUR13	n/a	4438	4623	4807	5066	5362	5623	5919	6289	6662		





ORDERING NOTES: All Jordan Recliners components are specified either left or right handed based on a position facing the unit. Jordan Sleep Recliners ship with the back apart from the chair folded down inside the packaging.

Jordan Sleep Recliner Option Upcharges	\$ List	\$ List
Moisture Barrier (per yard)	64	Central Caster Locking System
Removable Plus Seat Cover	118	Combination Upholstery Option - 2 fabrics
Removeable Plus Back Cover	129	Combination Upholstery Option - 3 fabrics
Swing Away Tablet	458	Solid Surface Arm Cap (per pair) - Gr A White
IV Pole & Holder	380	Solid Surface Arm Cap (per pair) - Gr A Color
Flip Up Tablet	416	Solid Surface Arm Cap (per pair) - Gr B
Foley Catheter Hook	215	Solid Surface Arm Cap (per pair) - Gr C
Trendelenburg Option	869	
Thermal Comfort	927	
Power Mechanism - Corded	958	Note: For Solid Surface option replace UPH arm type with "USS" in the model number and add the upcharge above.
Power Mechanism -Battery	1276	
Power Trendelenburg Mechanism - Corded	1386	
Power Trendelenburg Mechanism -Battery	1715	
Replacement Battery	620	
Patient Transfer Arm	932	

PRODUCT CODE KEY

Line	Series	Chair Type	Arm Type	Style
JOR	8	SR	UPH	1
Jordan	Motion	Sleep Recliner	Upholstered Arm	Casters
		PSR	UUR	2
		Power Sleep Recliner	Upholstered Arm with Urethane Cap	Legs
		SRT	USS	3
		Sleep Recliner with Trendelenburg	Upholstered Arm Solid Surface Cap	Central Locking Casters
		PSRT		
		Power Sleep Recliner with Trendelenburg		

JORDAN | SLEEP RECLINER

DESCRIPTION/MODEL	Species	COM		COL		FABRIC GRADES			LEATHER		
		1	2	3	4	5	6	7	8	9	
	Full Urethane Arm, with legs										
	JOR8-SRFUR24	Beech	4348	4533	4716	4977	5274	5532	5830	6200	6563
	(no push bar)	Maple	4372	4555	4740	5002	5299	5558	5853	6225	6595
	Full Urethane Arm, with casters										
	JOR8-SRFUR14	n/a	4434	4618	4802	5063	5361	5618	5915	6285	6657
	(no push bar)										
JOR8-SRFUR13	n/a	4460	4645	4830	5088	5384	5645	5941	6311	6684	
	Wood Arm, with legs										
	JOR8-SRWOD24	Beech	4452	4638	4821	5082	5378	5637	5935	6304	6673
	(no push bar)	Maple	4536	4722	4905	5166	5462	5721	6019	6388	6757
	Wood Arm, with casters										
	JOR8-SRWOD14	Beech	4538	4723	4907	5168	5465	5723	6020	6389	6762
	(no push bar)	Maple	4562	4748	4931	5192	5490	5747	6044	6413	6786
JOR8-SRWOD13	Beech	4565	4750	4933	5193	5488	5749	6046	6416	6788	
	Maple	4589	4774	4958	5217	5513	5773	6071	6440	6813	





ORDERING NOTES: All Jordan Recliners components are specified either left or right handed based on a position facing the unit. Jordan Sleep Recliners ship with the back apart from the chair folded down inside the packaging.

Jordan Sleep Recliner Option Upcharges	\$ List	\$ List
Moisture Barrier (per yard)	64	Central Caster Locking System
Removable Plus Seat Cover	118	Combination Upholstery Option - 2 fabrics
Removeable Plus Back Cover	129	Combination Upholstery Option - 3 fabrics
Swing Away Tablet	458	Solid Surface Arm Cap (per pair) - Gr A White
IV Pole & Holder	380	Solid Surface Arm Cap (per pair) - Gr A Color
Flip Up Tablet	416	Solid Surface Arm Cap (per pair) - Gr B
Foley Catheter Hook	215	Solid Surface Arm Cap (per pair) - Gr C
Trendelenburg Option	869	
Thermal Comfort	927	Note: For Solid Surface option replace WOD arm type with "SSC" in the model number and add the upcharge above.
Power Mechanism - Corded	958	
Power Mechanism -Battery	1276	
Power Trendelenburg Mechanism - Corded	1386	
Power Trendelenburg Mechanism -Battery	1715	
Replacement Battery	620	
Patient Transfer Arm	932	

PRODUCT CODE KEY

Line	Series	Chair Type	Arm Type	Style
JOR	8	SR	FUR	1
Jordan	Motion	Sleep Recliner	Full Urethane	Casters
		PSR	WOD	2
		Power Sleep Recliner	Wood Arm	Legs
		SRT	SSC	3
		Sleep Recliner with Trendelenburg	Wood Arm with Solid Surface Cap	Central Locking Casters
		PSRT		
		Power Sleep Recliner with Trendelenburg		

JORDAN | SLEEP RECLINER

DESCRIPTION/MODEL	Species	COM		COL		FABRIC GRADES			LEATHER		
		1	2	3	4	5	6	7	8	9	
	Wood Arm with Urethane Cap, with legs										
	JOR8-SRURE24	Beech	4581	4768	4950	5211	5507	5766	6064	6433	6802
	(no push bar)	Maple	4665	4852	5034	5295	5591	5850	6147	6517	6886
	Wood Arm with Urethane Cap, with casters										
	JOR8-SRURE14	Beech	4693	4879	5063	5322	5617	5878	6176	6544	6917
	(no push bar)	Maple	4718	4903	5087	5346	5641	5903	6200	6568	6941
	JOR8-SRURE13	Beech	4710	4897	5079	5340	5636	5895	6192	6562	6932
		Maple	4794	4980	5163	5424	5720	5979	6276	6646	7016
	Cushioned Armrest, with legs										
	JOR8-SRINF24	Beech	4580	4767	4949	5210	5506	5765	6063	6432	6801
	(no push bar)	Maple	4604	4789	4972	5235	5531	5790	6086	6457	6827
	Cushioned Armrest, with casters										
	JOR8-SRINF14		4666	4852	5035	5296	5593	5851	6147	6517	6890
	(no push bar)										
	JOR8-SRINF13		4692	4878	5062	5321	5616	5877	6175	6543	6916

ORDERING NOTES: All Jordan Recliners components are specified either left or right handed based on a position facing the unit. Jordan Sleep Recliners ship with the back apart from the chair folded down inside the packaging.

Jordan Sleep Recliner Option Upcharges	\$ List	\$ List	
Moisture Barrier (per yard)	64	Central Caster Locking System	1074
Removable Plus Seat Cover	118	Combination Upholstery Option - 2 fabrics	33
Removeable Plus Back Cover	129	Combination Upholstery Option - 3 fabrics	64
Swing Away Tablet	458	Power Mechanism - Corded	958
IV Pole & Holder	380	Power Mechanism -Battery	1276
Flip Up Tablet	416	Power Trendelenburg Mechanism - Corded	1386
Foley Catheter Hook	215	Power Trendelenburg Mechanism -Battery	1715
Thermal Comfort	927	Replacement Battery	620
Trendelenburg Option	869		







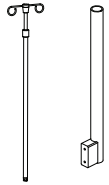

COORDINATING CUSHIONED ARM OPTION - please add the following up charges for Cushioned Arm in coordinating fabric.

Fabric Grades	1	2	3	4	5	6	7	8	9
2 ARMS	22	47	70	121	171	220	269	319	418

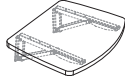
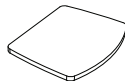
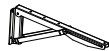
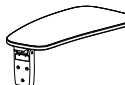
PRODUCT CODE KEY

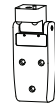
Line	Series	Chair Type	Arm Type	Style
JOR	8	SR	URE	1
Jordan	Motion	Sleep Recliner	Wood Arm with Urethane Cap	Casters
		PSR		2
		Power Sleep Recliner		Legs
		SRT	INF	3
		Sleep Recliner with Trendelenburg	Cushioned Armrest	Central Locking Casters
		PSRT		
		Power Sleep Recliner with Trendelenburg		

JORDAN | RECLINER ACCESSORIES & REPLACEMENT COMPONENTS

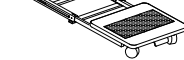
DESCRIPTION/MODEL	Price	Shipping Weight	Cubes
 IV Pole JOR8-RCRIP	291	3.8	1.4
 IV Pole Holder JOR8-RCRIPB	88	2	0.2
 Flip Up Tablet with brackets JOR8-RCRTK (wood or laminate)	416	6.6	1.6
 Flip Up Tablet 18"w x 14"d x .75"h JOR8-RCRT (wood or laminate)	334	5.8	1.4
 Flip Up Tablet Bracket JOR8-RCRTH	119	0.8	0.2
 Swing Away Tablet with Mechanism 24"w x 14.75"d x .75"h JOR8-SRST (wood or laminate)	458	20	1.2
 Swing Away Tablet Only JOR8-SRRT (wood or laminate)	238	7	0.8
 Swing Away Tablet Mechanism Only JOR8-SRRTH	301	13	1
 Push Bar JOR8-SRRPB	205	2	0.3
 Replacement Foley Catheter Hook JOR8-RHK	215	1	0.2
 Locking Rubber Wheel Caster JOR8-RCRCASRL -Back Left	95	2	0.2
JOR8-RCRCASRR -Back Right	47	2	0.2
JOR8-RCRCASFL -Front			
JOR8-RCRCASFR -Front			
 Recliner Foot Tray JOR8-RRFT	452	2.8	15
 Sleep Recliner Foot Tray JOR8-SRRFT	558	2.8	15

GLIDERS

380 Jordan Glider

JORDAN GLIDER | ENVIRONMENTAL SUMMARY

LEED CI CREDITS

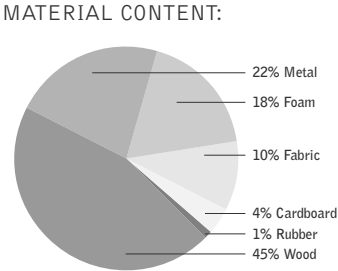

PRE-CONSUMER
RECYCLED CONTENT = 9.0%

POST-CONSUMER
RECYCLED CONTENT = 10.5%

CONTRIBUTES TO

CREDIT 2.1 - 2.2	Construction Waste Management	1-2 point(s)
CREDIT 3.3	Resource Reuse	1 point
CREDIT 4.1	Recycled Content	1 point
CREDIT 4.5	Low Emitting Materials, Systems & Seating	1 point
CREDIT 5.1	Regional Materials*	1 point
CREDIT 7	Certified Wood (MUST BE REQUESTED)	1 point(s)

*This credit is only applicable if in total 20% of the combined value of the procurement of construction materials and in the furniture are manufactured within a radius of 500 miles. This credit will apply if the installation of the finished product occurs within 500 miles of Kitchener, Ontario.

level® CERTIFICATION, AIR EMISSIONS AND FSC® CERTIFICATION



level® CERTIFICATION

BIFMA's e3 Furniture Sustainability Standard is a voluntary, multi-attribute standard that measures the degree of sustainability of furniture. This standard evaluates product and company environmental attributes and compliance systems in a wide range of elements which include Materials, Energy & Atmosphere, Human & Ecosystem Health and Social Responsibility. Jordan products have earned level®, BIFMA's sustainability certification program for furniture, certification through third-party verification against the e3 standard.

AIR-EMISSIONS

All Jordan products are supplied with air-emissions certified. Contact customer service for information.



FSC®

In 2005, Krug received Forest Stewardship Council® (FSC®) Chain-of-Custody certification for our manufacturing facilities. The FSC® Chain-of-Custody tracks certified wood from seedling to final sale. It verifies that the material for our FSC® certified products only come from well-managed, FSC®-certified forests and other controlled sources. FSC® is dedicated to the promotion of responsible forest management worldwide helping to take care of forests for future generations. Jordan and other Krug products can be specified with FSC® Certification. Contact customer service for further information, pricing and lead times.



Architects, designers, and building professionals can specify FSC®-certified products in order to achieve a point from the U.S. Green Building Council's Leadership in Energy and Environmental Design (LEED) Rating System.

JORDAN | GLIDER - DIMENSIONS & COM REQUIREMENTS

DIMENSIONS

	Overall Width	Overall Depth	Overall Height	Seat Height	Height of Arms from Floor	Width Between Arms	Seat Depth	Shipping Weight	Cube	COM Yardage Seat
21" Seat	25	28	43.5	18.5	26	20.5	20	126	17	0.9
24" Seat	28	28	43.5	18.5	26	23.5	20	131	22	0.9

COM REQUIREMENTS

	COM Yardage Complete Unit	Yardage Per Chair - Complete Unit	COM Yardage Back Only	Yardage Per Chair - Back Only	COM Yardage Seat Only	Yardage Per Chair - Seat Only	COM Yardage Inner Arm Panels (Pair)	Yardage Per Chair Inner Arm Panels (Pair)
One Chair	4.6	4.6	1.97	1.97	0.9	0.9	0.5	0.5
Two Chairs	9.2	4.6	3	1.5	1.3	0.63	1	0.5
Three Chairs	13.8	4.6	4	1.33	2.37	0.79	1.5	0.5
Four Chairs	18.4	4.6	6	1.5	2.6	0.65	2	0.5

COM REQUIREMENTS (Continued)

	COM Yardage Outer Arm Panels (Pair)	Yardage Per Chair Outer Arm Panels (Pair)	COM Yardage Front Recessed Kickplate Only	Yardage Per Chair - Front Recessed Kickplate Only	COM Yardage Back Kickplate Only	Yardage Per Chair Back Kickplate Only
One Chair	1.7	1.7	0.5	0.5	0.3	0.3
Two Chairs	3.4	1.7	1	0.5	0.6	0.3
Three Chairs	5.1	1.7	1.5	0.5	0.9	0.3
Four Chairs	6.8	1.7	2	0.5	1.2	0.3

Note: Some vinyls, leathers & upholsteries are not suitable for application on Jordan seating.

The approval process is as follows:

1. A sample of the COM must be provided to Krug Customer Service prior to or at the time of order.

For Maharam or Momentum, Krug will obtain the upholstery cover sample.

2. The sample will be reviewed and the customer advised if the upholstery cover is unsuitable.

3. The COM upholstery cover or leather will be inspected when received at the factory, to identify any further concerns with its suitability.

CONTRASTING BACKS, SEATS, ARM PANELS, RECESSED FRONT PANEL & BACK PANEL

Combination upholstery (more than one upholstery cover within the same unit) is an option on all Jordan upholstered products. When combination upholstery is with upholstery of the same grade or COM, an upcharge for dual fabrics is **\$33 list per unit and \$64 list** per unit for three fabrics. When graded in combination upholstery is selected, use the highest grade upholstery selected or contact Customer Service for a quote -please provide the fabrics specified and a description of where each fabric is to be applied on the product in order to obtain a quote.

GLIDER	SEAT	BACK	INNER ARM PANEL	OUTER ARM PANEL	RECESSED FRONT PANEL	BACK KICKPLATE
21" & 24"	0.9	1.9	0.5	1.7	0.5	0.3

WEIGHT CAPACITIES

Jordan weight capacities are as follows:

Jordan Glider - 350 lbs

JORDAN | GLIDER - FEATURES & OPTIONS



CLEAN OUT

Jordan Glider seating models have a built-in clean out feature: a space at the back of the seat that allows dirt, debris and liquid to fall to the floor for easy clean up and maintenance - designed so that it does not detract from the comfort or appearance of the product.



STEEL SEAT FRAME

The structural seat frame is made from welded steel with a powder-coated finish that allows Jordan Glider to well exceed ANSI/BIFMA standards.



HORIZONTAL MOTION

The Jordan glider is designed to move the patient in a smooth, flat arc that is gentle, soothing and safe. The position of the feet is maintained on the floor throughout the glider motion, rather than being raised up down in a rocking motion.



WALL SAVER DESIGN

The angle of the back and the rear legs are designed to keep the back away from the wall, in a locked position, to prevent wear and damage to both the chairs and to the walls of the facility.



ARM CAPS

The optional arm cap provides enhanced durability and protection for the arms. Available in Urethane or Solid Surface, either is field removable if it becomes damaged or degraded.



HEADREST

The headrest has a dual density foam for both comfort and support, and can be upholstered in matching or contrasting material. It is removable to allow for cleaning and replacement.



RECESSED FRONT PANEL

The Glider's front panel has an attractive arc that serves an important function: to provide safer ingress and egress by allowing the patient to get their feet underneath their weight. This is augmented by arms that have been designed as softly rounded hand-holds, to safely and comfortably support the weight of the patient while entering and exiting the chair.

TWO WIDTHS

21" and 24" widths are offered, allowing flexibility in accommodating patients of different sizes, and providing for the comfortable use of bolsters, pillows and other means of support for the patient.

MECHANISM

The mechanism is both replaceable in the field, and features a locking function so the glider can be used as a fixed chair.

REMOVABLE UPHOLSTERY COVERS

The seat and back covers can be specified to be removable, allowing for cleaning and repair, or replacement.

REMOVABLE AND REPLACEABLE COMPONENTS

All of the components - the seat, back, the arms, the arm cap, and the mechanism can be removed for cleaning, and replaced if damaged. Replacement Parts can be viewed on line at www.krug.ca.

COMBINATION UPHOLSTERY OPTIONS



When combination upholstery is specified with fabric of the same grade or COM, an upcharge for dual fabrics is **\$33 list** per unit and **\$64 list** per unit for three fabrics will be applied. When graded in combination upholstery is selected, use the highest grade upholstery selected or to obtain a quote for blended grading contact Customer Service (please provide the fabrics specified and location of where each fabric is to be applied on the product).

MOISTURE BARRIER & CAL 133

California Technical Bulletin 133 is a flammability test for seating. Krug offers a compliance method, in combination with non-flammable upholstery covers, may enable products to meet certification requirements for this test. This process at the same time also provides the products with a Moisture Barrier - a treatment that helps to prevent the passage of liquids and moisture to inside of the upholstered components - thereby conferring sanitary and anti-infection benefits. So when CAL 133 is specified, the product also automatically has a Moisture Barrier, and when a Moisture Barrier is specified, the product also features the compliance method and low flammability features of CAL 133.

The application of this up-charge and the compliance method does not mean that the specific configuration of product and upholstery cover are tested and officially certified as being CAL133 compliant. If the official certification is required, Krug will provide this (through an independent certified testing laboratory) at a charge of \$917 per item, plus the cost of the product to be tested. Lead time for certification testing is typically 4-8 weeks.

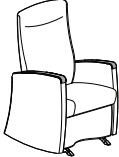
JORDAN | GLIDER

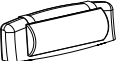
DESCRIPTION/MODEL	COM		COL		FABRIC GRADES			LEATHER		
	1	2	3	4	5	6	7	8	9	
 21" Fully Upholstered Arm JOR6-GL21UPH	2378	2510	2640	2775	2950	3124	3299	3513	3730	
 21" Fully Upholstered Arm with Urethane Cap JOR6-GL21UUR	2564	2696	2826	2961	3136	3310	3484	3698	3915	
 24" Fully Upholstered Arm JOR6-GL24UPH	2492	2627	2759	2890	3067	3241	3412	3629	3846	
 24" Fully Upholstered Arm with Urethane Cap JOR6-GL24UUR	2677	2811	2944	3075	3251	3426	3598	3815	4030	
 21" Adjustable Headrest JOR2-RHR21	327	376	405	433	460	491	517	546	586	
 24" Adjustable Headrest JOR2-RHR24	359	411	444	477	509	540	570	601	644	

Jordan Glider Option Upcharges

	\$ List	\$ List
CAL 133 & Moisture Barrier (per yard)	64	Solid Surface Arm Cap (per pair) - Gr A White 517
Removable Seat Cover	90	Solid Surface Arm Cap (per pair) - Gr A Color 527
Removable Back Cover	103	Solid Surface Arm Cap (per pair) - Gr B 548
Combination Upholstery - dual fabrics	33	Solid Surface Arm Cap (per pair) - Gr C 577
Combination Upholstery -Three fabrics	64	

Note: For Solid Surface option replace UPH arm type with "USS" in the model number and add the upcharge above.

PRODUCT CODE KEY

Line	Series	Chair Type	Size	Arm Type
JOR Jordan	6 Motion	GL Glider	21	UPH Fully Upholstered
			24	UUR Fully Upholstered with Urethane Arm Cap
				USS Fully Upholstered with Solid Surface Arm Cap

SLEEPERS

- 385 Amelio Sofa Sleeper & Modular Sofa
- 400 Amelio Bench Sleeper
- 407 Jordan Lounge Sleeper

AMELIO & AMELIO MODULAR | SLEEP SOFA FEATURES

Amelio Modular is an innovative, patent-pending sleep solution that has been designed to allow hospitals to more cost-effectively address a constant reality: the need for change. Patient rooms are not static spaces, and Amelio Modular enables you to adapt them to changing needs. Each component of Amelio is a module, designed to be added or removed as space needs change: seat, table, storage and footrest modules can be added and removed to reconfigure the sleep sofa - to change overall dimensions, or change the functionality of the sofa - or to replace damaged components. No other sleep solution provides this innovative capability, which can substantially extend the useful life of the product, and allow it to continually evolve as your space is adapted to improve patient care. Use the link [Animation Video](#) to see a video demonstrating Amelio Modular's unique ability to change and evolve with you.



RAISED OFF THE FLOOR

Ample space (5.5", plus up to .5" of glide adjustment) between the bottom of the unit and the floor is designed to enable easier cleaning of the floor underneath.

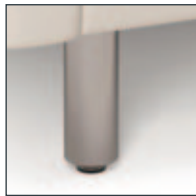

ROUND STEEL LEGS

The 2" diameter steel leg is available in Silver Metallic, Polished Chrome, Matte Black, and White and have an adjustable glide. Amelio units with legs feature 5 legs in total, with the 5th leg located in the rear middle of the unit, providing greater structural strength and durability. Amelio 5.5" high. Amelio Modular 3" high.



REMOVABLE BACK COVER

Amelio backs are standard with a zipper allowing access to the sleep surface cushion straps. These straps are released by simply peeling back the velcro holding them in place.



CLEAN OUT

A 5/8" space between the top of the seat and bottom of the back provide a clean out, for dirt and debris to fall or be swept into, going directly to the floor. The storage compartment also features vented bottoms that perform the same function.

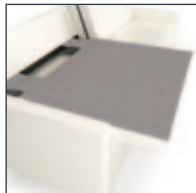

FOLD DOWN SLEEPING SURFACE

The back cushions fold down to instantly transform this sofa into a full-length sleeper - without encroaching on additional floor space. It features comfortable foam with a moisture barrier and an PVC-free surface at a convenient and safe 22" height. Cushions are fastened in place, but can be removed for cleaning or replacement. Minimal seams are designed to support infection control.



HEAVY DUTY HARDWARE & CONNECTIONS

High strength steel mechanisms are joined to other components in Amelio Sofa sleeper product with hardened steel bolts and metal inserts, ensuring exceptional durability, strength and on-site replacement of damaged or degraded components.



REPLACEABLE COMPONENTS

Healthcare furnishings are constantly subjected to intensive use, and even damage. Amelio Sofa sleepers are uniquely designed to allow virtually all major components to be field replaced, providing a very cost effective means to significantly extend the life of the product. Seats and Sleep surface cushions are removable (for repair and cleaning), and replaceable, as are legs, casters, arm panels, arm caps, front panels and storage mechanisms.

SLEEP SURFACE CLEANING

Amelio Sleep Sofas are standard with healthcare-rated PVC-free sleep surface. It is easily cleanable and acts as a moisture barrier on the top of the sleep surface. Sleep surfaces can be cleaned with warm water and mild soap. Water diluted to a maximum of 25% bleach and other intensive cleaning solutions (Virucide, accelerated peroxide) such as PerCept RTU, Zolvex, Clorox Wipes, Alpha HP and Virox can be used without affecting the color or integrity of the fabric. All cleaning products should be applied with a cloth, sponge or soft bristle brush.

CAL 133 & MOISTURE BARRIER

The sleep surface cushions are supplied with a standard moisture barrier applied to the top and sides of the foam cushions. CAL 133 and Moisture Barriers are available on the complete unit, please see upcharges in ordering notes.

California Technical Bulletin 133 is a flammability test for seating. Krug offers a compliance method which, in combination with non-flammable upholstery covers, may enable the products to meet certification requirements for this test. This process at the same time also provides the products with a Moisture Barrier - a treatment that helps to prevent the passage of liquids and moisture to inside of upholstered components - thereby conferring sanitary and anti-infection benefits. So when CAL 133 is specified, the product also automatically has a Moisture Barrier, and when a Moisture Barrier is specified, the product also features the compliance method and low flammability features of CAL 133.

The application of this upcharge and the compliance method does not mean that the specific configuration of product and upholstery cover are tested and officially certified as being CAL 133 compliant. If official certification is required, Krug will provide this (through an independent certified testing laboratory) at a charge of \$917 per item, plus the cost of the product to be tested. Lead time for certification testing is typically 4-8 weeks. Krug assumes no responsibility for the testing of our products in combination with upholstery covers, or for the results of any testing conducted. Some specific configurations of product and upholstery have already been tested. Please contact Customer Service for additional information.

AMELIO & AMELIO MODULAR | SLEEP SOFA OPTIONS

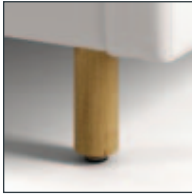

WOOD LEGS

The Amelio Sleep Sofa has the option of 2" round wood legs. All sofa sizes features a center leg for additional support and strength. An adjustable glide is standard on all legs. This helps ensure the furniture is steady and level on uneven floors. Not available on Amelio Modular Sleep Sofa.

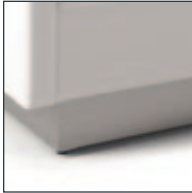

PLINTH

The base is clad in durable grey vinyl to resist damage and is designed to help prevent dirt debris and liquids from accumulating under the sofa sleeper. Amelio Modular is not available with Plinth base.

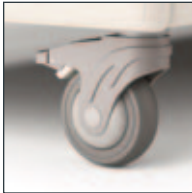

AMELIO CASTERS

4" Casters are available on the Amelio sleep sofa and feature five soft wheels, which lock and include an easy access foot activation and release lever. The casters can be locked both directionally and rotationally, keeping the sofa sleeper securely in place when locked.



AMELIO MODULAR CASTERS

3" dual wheel locking casters are available on Amelio Modular and feature 7 casters in total. The low profile soft wheels offer quiet and smooth performance.



STORAGE COMPARTMENT

An optional under-seat storage compartment features a cleanable interior surface with a vented plastic bottom, with a clean-out for debris and liquids. The venting provides air circulation that assists infection control. The spring-assisted, stainless steel mechanism holds the seat in the upright position to provide safe access.

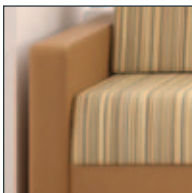

COMBINATION UPHOLSTERY OPTIONS

When combination upholstery is specified with fabric of the same grade or COM, an up-charge for dual fabrics is **\$33 list** per unit and -- per unit for three fabrics will be applied. When graded in combination upholstery is selected, use the highest grade upholstery selected or to obtain a quote for blended grading contact Customer Service (please provide the fabrics specified and location of where each fabric is to be applied on the product).



REMOVABLE SLEEP SURFACE & SEAT COVERS

Removable upholstery cover options on seats and sleep surface cushions, to allow cleaning, repair and replacement. When ordering Removable Seat Cover at time of order, the upcharge is **\$220 list** per seat. Removable Sleep Surface covers are a standard product feature.



POWERDOC

The flush-mounted PowerDoc provides dual power/USB outlets for multiple devices. It can be specified on the front of the Wide Arm, under the Adjustable Table, as well under the Fixed Table (in the valance, Not available with storage).



ARM STYLES

The Amelio Sleep Sofa comes available in either an arm, armless or wide arm version. Arms can be added to armless units in the field. Armed and Wide Armed versions are available as a fully upholstered arm or trimmed with optional arm caps. Footrest option not available with Wide Arms.



URETHANE ARM CAP

The optional Black, Grey or Taupe urethane arm cap provides enhanced durability and protection for the arms. This component is field replaceable if it becomes damaged or degraded. Not available on wide arms.



WOOD ARM CAP

The optional Wood arm cap helps to create a warm and inviting environment. Wood arm caps are field replaceable if they becomes damaged or degraded.



SOLID SURFACE ARM CAP

The optional solid surface arm cap provides enhanced durability and protection for the arms. This component is field replaceable if it becomes damaged or degraded.



THERMOFORMED ARM CAP

The optional thermoformed arm cap features a seamless surface and provides enhanced durability for the arms. The component is field replaceable if it becomes damaged or degraded.



SWING AWAY TABLET

The Swing Away Tablet (24" x 14 3/4" x 3/4") rotates 180 degrees and can fold to the side when not in use. The kidney shaped design is ideal for use as an eating, writing or work-surface. It can be specified left or right as seated on the standard width arm only. Available in Wood, Thermoformed or in 1/2" thick Solid Surface. Meets ANSI/ BIFMA x5.1 2011 (Static Load 150lb). Not available if foot rest option selected for Left / Right module on Amelio Modular.



CUP HOLDER

Wide arms can be optioned with a 3.5" stainless steel cup holder and can be specified on either the left or right arm.

AMELIO SLEEP SOFA | ENVIRONMENTAL SUMMARY

LEED CI CREDITS



MATERIAL CONTENT:

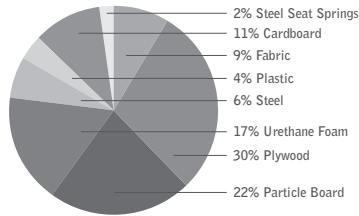

PRE-CONSUMER
RECYCLED CONTENT = 27%

POST-CONSUMER
RECYCLE CONTENT = 12.2%

CONTRIBUTES TO		
CREDIT 2.1 - 2.2	Construction Waste Management	1-2 point(s)
CREDIT 3.3	Resource Reuse	1 point
CREDIT 4.1	Recycled Content	1 point
CREDIT 4.2	Recycled Content	1 point
CREDIT 4.5	Low Emitting Materials, Systems & Seating	1 point
CREDIT 5.1	Regional Materials*	1 point
CREDIT 7	Certified Wood (MUST BE REQUESTED)	1 point(s)

*This credit is only applicable if in total 20% of the combined value of the procurement of construction materials and in the furniture are manufactured within a radius of 500 miles. This credit will apply if the installation of the finished product occurs within 500 miles of Kitchener, Ontario.

level® CERTIFICATION, AIR EMISSIONS AND FSC® CERTIFICATION



level® CERTIFICATION

BIFMA's e3 Furniture Sustainability Standard is a voluntary, multi-attribute standard that measures the degree of sustainability of furniture. This standard evaluates product and company environmental attributes and compliance systems in a wide range of elements which include Materials, Energy & Atmosphere, Human & Ecosystem Health and Social Responsibility. Amelio products have earned level®, BIFMA's sustainability certification program for furniture, certification through third-party verification against the e3 standard.

AIR-EMISSIONS

All Amelio products are supplied with air-emissions certified. Contact customer service for information.



FSC®

In 2005, Krug received Forest Stewardship Council® (FSC®) Chain-of-Custody certification for our manufacturing facilities. The FSC® Chain-of-Custody tracks certified wood from seedling to final sale. It verifies that the material for our FSC® certified products only come from well-managed, FSC®-certified forests and other controlled sources. FSC® is dedicated to the promotion of responsible forest management worldwide helping to take care of forests for future generations. Amelio and other Krug products can be specified with FSC® Certification. Contact customer service for further information, pricing and lead times.



Architects, designers, and building professionals can specify FSC®-certified products in order to achieve a point from the U.S. Green Building Council's Leadership in Energy and Environmental Design (LEED) Rating System.

CUSTOM SIZING



Amelio Sleep Sofa was designed for use with all floorplans, even the most challenging spaces. The Amelio Sleep Sofa is available in custom sizes in 1" increments between the size range of 68" - 84", please use next size up for pricing when ordering 10 or more units. For non-standard sizes in quantities less than 10 units or for other customization of Amelio, please contact Customer Service to obtain a special quote.

The flip-down sleep surface instantly transforms this sofa into a full-length sleeper, without encroaching at all on the footprint of the room, and without any mechanical operation. Sleep surface cushions are held in place with accessible straps - so that they are removable for cleaning and repair, but the cushions will stay in place when the unit is in use.

The Amelio Sleep Sofa unique construction and design provides comfortable daytime seating elements for guests. The split back design provides versatile sleeping options, one back section can be folded to create a parent supervised sleeping surface for a child or the complete back can be folded to accommodate overnight visitors.

CONVERSION FROM SOFA TO SLEEPER

The Amelio Sleep Sofa creates a sleep surface that does not impede the footprint of the patient room. The sleep surface cushions simply fold down to create a comfortable sleep surface.



COMBINATION UPHOLSTERY OPTIONS

When ordering combination upholstery or using COM fabric, please use the following fabric placement reference guide. Simply make a copy, note the fabrics and send in with the order

Outer Back Upholstery

Amelio outer back is standard with latex-free grey colored vinyl

Inner Back Upholstery

Back Cushions Upholstery

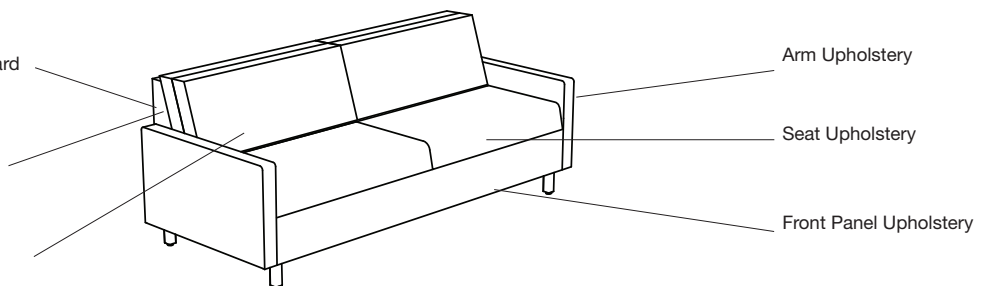

The standard Outer Back upholstery supplied is a latex-free grey colored vinyl, a high-durability polyester fabric with a vinyl backer, designed to withstand impact and helps prevent the passage of moisture. The Sleep Surface is a hospital grade pvc free fabric.

AMELIO | SLEEP SOFA

SLEEP SOFA DIMENSIONS

	Overall Width	Overall Depth	Overall Height	Seat Height	Seat Depth	Sleep Width	Sleep Depth	Arm Height	Shipping Weight	Cubes
ARMLESS										
70"	70	34.5	34.5	19	20	68	28.75	-	220	65
74"	74	34.5	34.5	19	20	72	28.75	-	230	69
78"	78	34.5	34.5	19	20	76	28.75	-	240	72
82"	82	34.5	34.5	19	20	80	28.75	-	250	76
WITH ARMS										
74"	74	34.5	34.5	19	20	68	28.75	23.5	239	69
78"	78	34.5	34.5	19	20	72	28.75	23.5	249	72
82"	82	34.5	34.5	19	20	76	28.75	23.5	259	76
86"	86	34.5	34.5	19	20	80	28.75	23.5	269	79
WITH WIDE ARMS										
82"	82	34.5	34.5	19	20	68	28.75	23.5	255	75
86"	86	34.5	34.5	19	20	72	28.75	23.5	265	78
90"	90	34.5	34.5	19	20	76	28.75	23.5	275	84
94"	94	34.5	34.5	19	20	80	28.75	23.5	285	90

STORAGE COMPARTMENT DIMENSIONS

	SOFA SIZE	WIDTH/SEAT	DEPTH	HEIGHT
ARMLESS				
	70	32	18.5	8
	74	34	18.5	8
	78	36	18.5	8
	82	38	18.5	8
WITH ARMS				
	74	32	18.5	8
	78	34	18.5	8
	82	36	18.5	8
	86	38	18.5	8
WITH WIDE ARMS				
	82	32	18.5	8
	86	34	18.5	8
	90	36	18.5	8
	94	38	18.5	8

COM REQUIREMENTS

	COM Ydg Complete Unit Grey Outer Back (Standard)	COM Ydg Complete Unit with COM on Outer Back	COM Ydg Armless Arm or Wide Arm (Pair)	COM Yardage Seat Cushions (Pair)	COM Yardage Folding Back Cushions (Pair)	COM Yardage Front Panel	COM Yardage Inner Back	COM Yardage Rear Seat
ARMLESS								
70" (overall width)	8.5	10.1	1	2.3	2.8	0.8	1	0.5
74" (overall width)	8.5	10.1	1	2.3	2.8	0.8	1	0.5
78" (overall width)	8.5	10.1	1	2.3	2.8	0.8	1	0.5
82" (overall width)	8.5	10.1	1	2.3	2.8	0.8	1	0.5
WITH ARMS								
74" (overall width)	10	11.6	2.5	2.3	2.8	0.8	1	0.5
78" (overall width)	10	11.6	2.5	2.3	2.8	0.8	1	0.5
82" (overall width)	10	11.6	2.5	2.3	2.8	0.8	1	0.5
86" (overall width)	10	11.6	2.5	2.3	2.8	0.8	1	0.5
WITH WIDE ARMS								
82" (overall width)	10	11.6	2.8	2.3	2.8	0.8	1	0.5
86" (overall width)	10	11.6	2.8	2.3	2.8	0.8	1	0.5
90" (overall width)	10	11.6	2.8	2.3	2.8	0.8	1	0.5
94" (overall width)	10	11.6	2.8	2.3	2.8	0.8	1	0.5

NOTE: Some vinyls, leathers and upholsteries are not suitable for application on Amelio seating.

The COM approval process is as follows:

1. A sample of the COM must be provided to Krug Customer Service prior to or at the time of order.
2. The sample will be reviewed and the customer advised if the upholstery cover is unsuitable.
3. The COM upholstery cover or leather will be inspected when received at the factory, to identify any further concerns with its suitability.

Replacement Removable Seat Cover

Replacement covers are available for Sleep Surface Cushions and for Seat Cushions that were originally ordered with the Removable Cover option.

DESCRIPTION/MODEL	COM Only		COL		FABRIC GRADES				LEATHER	
	1	2	3	4	5	6	7	8	9	
Replacement Removable Seat Cover	479	678	779	877	1082	1275	1474	1672	1871	2271
Replacement Sleep Surface Cushion Cover	731	931	1001	1128	1315	1528	1727	1926	2124	2523

WEIGHT CAPACITY Amelio Sleep Sofa has been load tested to 750 lbs.

AMELIO | SLEEP SOFA

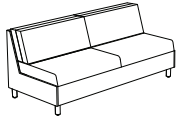
Description/Model/Species	COM			COL			FABRIC GRADES			LEATHER		
	Only	1	2	3	4	5	6	7	8	9		
	Amelio Sleep Sofa without storage, armless with steel legs											
	COM											
	AME6-SL70FALS2 n/a	4158	4758	5013	5274	5786	6300	6817	7330	7843	8871	
	AME6-SL74FALS2	4243	4843	5103	5359	5871	6387	6898	7415	7928	8956	
	AME6-SL78FALS2	4328	4929	5185	5442	5957	6471	6985	7498	8014	9040	
AME6-SL82FALS2	4415	5012	5272	5528	6043	6555	7070	7585	8097	9128		

Steel Legs are also available in Polished Chrome, Matte Black, and White finishes, please note clearly on your order.

	Amelio Sleep Sofa without storage, armless with casters or wood legs.											
	COM											
	AME6-SL70FALS_ Bch/Map	4473	5075	5332	5588	6104	6616	7131	7646	8159	9187	
	AME6-SL74FALS_	4560	5160	5418	5674	6187	6704	7215	7731	8247	9272	
	AME6-SL78FALS_	4644	5244	5502	5758	6271	6788	7300	7816	8330	9357	
AME6-SL82FALS_	4730	5331	5586	5844	6358	6871	7387	7899	8412	9441		

To order Amelio base options, replace the underscore “_” in the model number with the number in product code key below that represents the leg style required.

	Amelio Sleep Sofa with storage, armless with steel legs											
	COM											
	AME6-SL70SALS2 n/a	4862	5464	5719	5977	6492	7005	7520	8033	8545	9574	
	AME6-SL74SALS2	4942	5541	5799	6055	6571	7084	7597	8115	8625	9653	
	AME6-SL78SALS2	5023	5622	5878	6137	6649	7164	7680	8193	8706	9735	
AME6-SL82SALS2	5103	5703	5959	6214	6731	7243	7758	8272	8787	9813		

Steel Legs are also available in Polished Chrome, Matte Black, and White finishes, please note clearly on your order.

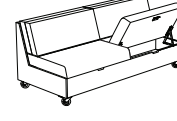
	Amelio Sleep Sofa with storage, armless with casters or wood legs.											
	COM											
	AME6-SL70SALS_ Bch/Map	5179	5781	6034	6292	6806	7322	7836	8346	8864	9889	
	AME6-SL74SALS_	5258	5859	6115	6372	6888	7400	7913	8431	8975	9969	
	AME6-SL78SALS_	5337	5939	6193	6449	6967	7481	7994	8509	9022	10048	
AME6-SL82SALS_	5418	6017	6276	6532	7046	7560	8074	8590	9102	10129		

To order Amelio base options, replace the underscore “_” in the model number with the number in product code key below that represents the leg style required.

Please Note: All length dimensions in model numbers represent the overall, outside length of the unit (including arms, when arms are specified).

Amelio Option Upcharges List

CAL 133 & Moisture Barrier (per yard)	64
Removable Seat Cover	232
Plinth Base - Vinyl Wrapped	483
Combination upholstery - 2 fabrics	33
Combination upholstery - 3 fabrics	64

Amelio Sleep Sofas are standard with a latex-free grey colored back. Upholstered backs are available for the following up-charges:

	Grade 1	Grade 2	Grade 3	Grade 4	Grade 5	Grade 6	Grade 7	Grade 8	Grade 9
\$ List	113	169	227	338	451	561	676	786	1015

PRODUCT CODE KEY

Line	Series	Chair Type	Size	Storage	Arm Type	Base Style
AME	6	SL	70	F	ALS	1
Amelio	Motion	Sofa sleeper	70" Armless	Without Storage	Armless	Casters
			74	S		2
			74" Armless	With Storage		Round Steel Legs
			78			3
			78" Armless			Round Wood Legs
			82			4
			82" Armless			Plinth Base

AMELIO | SLEEP SOFA

Description/Model/Species	COM			COL			FABRIC GRADES			LEATHER		
	only	1	2	3	4	5	6	7	8	9		

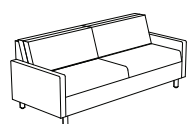

Amelio Sleep Sofa without storage, upholstered arms with steel legs

		COM									
AME6-SL74FUPH2	n/a	4611	5322	5631	5935	6548	7159	7771	8386	8999	10221
AME6-SL78FUPH2		4693	5407	5713	6019	6630	7243	7860	8513	9082	10306
AME6-SL82FUPH2		4780	5492	5796	6104	6716	7329	7942	8555	9165	10424
AME6-SL86FUPH2		4862	5573	5881	6186	6798	7413	8024	8637	9250	10473

Steel Legs are also available in Polished Chrome, Matte Black, and White finishes, please note clearly on your order.

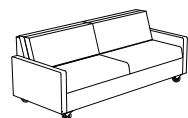

Amelio Sleep Sofa without storage, upholstered arms with casters or wood legs.

		COM									
AME6-SL74FUPH_	Bch/Map	4927	5638	5945	6250	6863	7478	8088	8700	9313	10539
AME6-SL78FUPH_		5010	5721	6030	6335	6945	7560	8174	8786	9397	10621
AME6-SL82FUPH_		5095	5806	6112	6419	7033	7645	8257	8870	9483	10707
AME6-SL86FUPH_		5179	5890	6196	6504	7116	7729	8341	8955	9564	10792

To order Amelio base options, replace the underscore “_” in the model number with the number in product code key below that represents the leg style required.

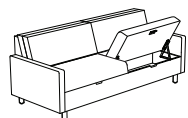

Amelio Sleep Sofa with storage, upholstered arms with steel legs

		COM									
AME6-SL74SUPH2	n/a	5315	6024	6336	6634	7249	7863	8474	9087	9698	10925
AME6-SL78SUPH2		5392	6104	6410	6716	7329	7942	8555	9165	9779	11006
AME6-SL82SUPH2		5472	6184	6491	6795	7408	8019	8634	9247	9860	11084
AME6-SL86SUPH2		5552	6263	6570	6875	7488	8099	8715	9328	9939	11163

Steel Legs are also available in Polished Chrome, Matte Black, and White finishes, please note clearly on your order.

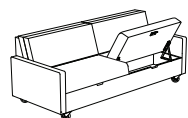

Amelio Sleep Sofa with storage, upholstered arms with casters or wood legs

		COM									
AME6-SL74SUPH_	Bch/Map	5631	6339	6653	6953	7567	8178	8789	9406	10018	11241
AME6-SL78SUPH_		5708	6419	6725	7033	7645	8257	8870	9483	10095	11320
AME6-SL82SUPH_		5787	6498	6805	7110	7725	8339	8948	9562	10175	11401
AME6-SL86SUPH_		5867	6580	6885	7191	7805	8416	9030	9641	10256	11479

To order Amelio base options, replace the underscore “_” in the model number with the number in product code key below that represents the leg style required.

Amelio Option Upcharges	List	Grades				
		A - White	A - Color	B	C	
CAL 133 & Moisture Barrier (per yard)	64	Solid Surface Arm Cap (pair)	233	244	265	280
Removable Seat Cover (per seat)	232					
Black, Grey or Taupe Urethane Arm Cap (pair)	121	Wood Arm Cap (pair)	213	243	Beech	Maple
Thermoformed Arm Cap (pair)	182					
Swing Away Tablet	458					
Plinth Base - Vinyl Wrapped	483					
Combination upholstery - 2 fabrics	33					
Combination upholstery - 3 fabrics	64					

Amelio Sleep Sofas are standard with a latex-free grey colored back. Upholstered backs are available for the following up-charges:

	Grade 1	Grade 2	Grade 3	Grade 4	Grade 5	Grade 6	Grade 7	Grade 8	Grade 9
\$ List	113	169	227	338	451	561	676	786	1015

PRODUCT CODE KEY

Line	Series	Chair Type	Size	Storage	Arm Type	Base Style
AME	6	SL	74	F	UPH	1
Amelio	Motion	Sofa sleeper	74" Armed	Without Storage	Uph. Arm	Casters
			78	S	WOD	2
			78" Armed	With Storage	Uph. Arm with Wood Cap	Steel Legs
			82		URE	3
			82" Armed		Uph. Arm with Urethane Cap	Wood Legs
			86		THC	4
			86" Armed		Uph. Arm with Thermoformed Cap	Plinth Base
					USS	
					Uph. Arm with Solid Surface Cap	

AMELIO MODULAR | ENVIRONMENTAL SUMMARY

LEED CI CREDITS

MATERIAL CONTENT:

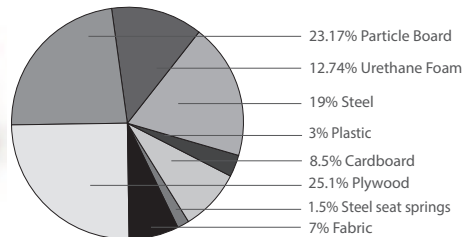

PRE-CONSUMER
RECYCLED CONTENT = 30.41%

POST-CONSUMER
RECYCLED CONTENT = 12.41%

Up to 27.41% of this Amelio tables product is recyclable at the end of its useful life.

CONTRIBUTES TO

CREDIT 2.1 - 2.2	Construction Waste Management	1-2 point(s)
CREDIT 3.3	Resource Reuse	1 point
CREDIT 4.1	Recycled Content	1 point
CREDIT 4.2	Recycled Content	1 point
CREDIT 4.5	Low Emitting Materials, Systems & Seating	1 point
CREDIT 5.1	Regional Materials*	1 point
CREDIT 7	Certified Wood (MUST BE REQUESTED)	1 point(s)

*This credit is only applicable if in total 20% of the combined value of the procurement of construction materials and in the furniture are manufactured within a radius of 500 miles. This credit will apply if the installation of the finished product occurs within 500 miles of Kitchener, Ontario.

level® CERTIFICATION, AIR EMISSIONS AND FSC® CERTIFICATION



level® CERTIFICATION

BIFMA's e3 Furniture Sustainability Standard is a voluntary, multi-attribute standard that measures the degree of sustainability of furniture. This standard evaluates product and company environmental attributes and compliance systems in a wide range of elements which include Materials, Energy & Atmosphere, Human & Ecosystem Health and Social Responsibility. Amelio products have earned level®, BIFMA's sustainability certification program for furniture, certification through third-party verification against the e3 standard.

AIR-EMISSIONS

All Amelio products are supplied with air-emissions certified. Contact customer service for information.



FSC®

In 2005, Krug received Forest Stewardship Council® (FSC®) Chain-of-Custody certification for our manufacturing facilities. The FSC® Chain-of-Custody tracks certified wood from seedling to final sale. It verifies that the material for our FSC® certified products only come from well-managed, FSC®-certified forests and other controlled sources. FSC® is dedicated to the promotion of responsible forest management worldwide helping to take care of forests for future generations. Amelio and other Krug products can be specified with FSC® Certification. Contact customer service for further information, pricing and lead times.



Architects, designers, and building professionals can specify FSC®-certified products in order to achieve a point from the U.S. Green Building Council's Leadership in Energy and Environmental Design (LEED) Rating System.

AMELIO MODULAR | DIMENSIONS

SLEEP SOFA W/ADJ TABLE DIMENSIONS

	Overall Width	Overall Depth	Overall Height	Seat Height	Seat Depth	Sleep Width	Sleep Depth	Arm Height	L/R Seat Width	CTR Table Width	Shipping Weight	Cubes
ARMLESS												
68"	70	35.25	34.5	19	20	68	28.75	-	24.5	19	245	65
72"	74	35.25	34.5	19	20	72	28.75	-	24.5	23	255	69
76"	78	35.25	34.5	19	20	76	28.75	-	24.5	27	265	72
80"	82	35.25	34.5	19	20	80	28.75	-	24.5	31	275	76
WITH ARMS												
68"	74	35.25	34.5	19	20	68	28.75	23.5	24.5	19	264	69
72"	78	35.25	34.5	19	20	72	28.75	23.5	24.5	23	274	72
76"	82	35.25	34.5	19	20	76	28.75	23.5	24.5	27	284	76
80"	86	35.25	34.5	19	20	80	28.75	23.5	24.5	31	294	79
WITH WIDE ARMS												
68"	82	35.25	34.5	19	20	68	28.75	23.5	24.5	19	279	75
72"	86	35.25	34.5	19	20	72	28.75	23.5	24.5	23	289	78
76"	90	35.25	34.5	19	20	76	28.75	23.5	24.5	27	299	84
80"	94	35.25	34.5	19	20	80	28.75	23.5	24.5	31	309	90
	*add 3" per footrest handle											*add 5 cubes for footrest handles

SLEEP SOFA W/FIXED TABLE DIMENSIONS

	Overall Width	Overall Depth	Overall Height	Seat Height	Seat Depth	Sleep Width	Sleep Depth	Arm Height	L/R Seat Width	CTR Table Width	Shipping Weight	Cubes
ARMLESS												
68"	70	35.25	34.5	19	20	68	28.75	-	24.5	19	235	65
72"	74	35.25	34.5	19	20	72	28.75	-	24.5	23	245	69
76"	78	35.25	34.5	19	20	76	28.75	-	24.5	27	255	72
80"	82	35.25	34.5	19	20	80	28.75	-	24.5	31	265	76
WITH ARMS												
68"	74	35.25	34.5	19	20	68	28.75	23.5	24.5	19	254	69
72"	78	35.25	34.5	19	20	72	28.75	23.5	24.5	23	264	72
76"	82	35.25	34.5	19	20	76	28.75	23.5	24.5	27	274	76
80"	86	35.25	34.5	19	20	80	28.75	23.5	24.5	31	284	79
WITH WIDE ARMS												
68"	82	35.25	34.5	19	20	68	28.75	23.5	24.5	19	269	75
72"	86	35.25	34.5	19	20	72	28.75	23.5	24.5	23	279	78
76"	90	35.25	34.5	19	20	76	28.75	23.5	24.5	27	289	84
80"	94	35.25	34.5	19	20	80	28.75	23.5	24.5	31	299	90
	*add 3" per footrest handle											*add 5 cubes for footrest handles

SLEEP SOFA W/CENTER SEAT DIMENSIONS

	Overall Width	Overall Depth	Overall Height	Seat Height	Seat Depth	Sleep Width	Sleep Depth	Arm Height	L/R Seat Width	CTR Table Width	Shipping Weight	Cubes
ARMLESS												
68"	70	34.5	34.5	19	20	68	28.75	-	24.5	19	230	65
72"	74	34.5	34.5	19	20	72	28.75	-	24.5	23	240	69
76"	78	34.5	34.5	19	20	76	28.75	-	24.5	27	250	72
80"	82	34.5	34.5	19	20	80	28.75	-	24.5	31	260	76
WITH ARMS												
68"	74	34.5	34.5	19	20	68	28.75	23.5	24.5	19	249	69
72"	78	34.5	34.5	19	20	72	28.75	23.5	24.5	23	259	72
76"	82	34.5	34.5	19	20	76	28.75	23.5	24.5	27	269	76
80"	86	34.5	34.5	19	20	80	28.75	23.5	24.5	31	279	79
WITH WIDE ARMS												
68"	82	34.5	34.5	19	20	68	28.75	23.5	24.5	19	264	75
72"	86	34.5	34.5	19	20	72	28.75	23.5	24.5	23	274	78
76"	90	34.5	34.5	19	20	76	28.75	23.5	24.5	27	284	84
80"	94	34.5	34.5	19	20	80	28.75	23.5	24.5	31	294	90
	*add 3" per footrest handle											*add 5 cubes for footrest handles

STORAGE COMPARTMENT DIMENSIONS

	SIZE	WIDTH/SEAT	DEPTH	HEIGHT
ARMLESS	ALL	22.5	17.5	10.5
WITH ARMS	ALL	22.5	17.5	10.5
WITH WIDE ARMS	ALL	22.5	17.5	10.5

AMELIO MODULAR | COM REQUIREMENTS

SOFA SLEEPER W/ADJ TABLE COM REQUIREMENTS

	COM Ydg Complete Unit Grey Outer Back (Standard)	COM Ydg Complete Unit with COM on Outer Back	COM Ydg Armless, Arm or Wide Arm (Pair)	COM Yardage L/R Seat Cushion (per sofa)	COM Ydg Folding Back Cushion	COM Yardage Front Panels (per sofa)	COM Yardage Outer Back	COM Yardage Inner Back	COM Yardage Rear Seat
ARMLESS									
68"	8.5	10.1	1	2.3	2.7	1.5	1.1	1	0.5
72"	8.5	10.1	1	2.3	2.7	1.5	1.1	1	0.5
76"	8.5	10.1	1	2.3	2.7	1.5	1.1	1	0.5
80"	8.5	10.1	1	2.3	2.7	1.5	1.1	1	0.5
WITH ARMS									
68"	10	11.8	2.5	2.3	2.7	1.5	1.1	1	0.5
72"	10	11.8	2.5	2.3	2.7	1.5	1.1	1	0.5
76"	10	11.8	2.5	2.3	2.7	1.5	1.1	1	0.5
80"	10	11.8	2.5	2.3	2.7	1.5	1.1	1	0.5
WITH WIDE ARMS									
68"	10	11.8	2.8	2.3	2.7	1.5	1.1	1	0.5
72"	10	11.8	2.8	2.3	2.7	1.5	1.1	1	0.5
76"	10	11.8	2.8	2.3	2.7	1.5	1.1	1	0.5
80"	10	11.8	2.8	2.3	2.7	1.5	1.1	1	0.5

SOFA SLEEPER W/FIXED TABLE COM REQUIREMENTS

	COM Ydg Complete Unit Grey Outer Back (Standard)	COM Ydg Complete Unit with COM on Outer Back	COM Ydg Armless, Arm or Wide Arm (Pair)	COM Yardage L/R Seat Cushion (per sofa)	COM Ydg Folding Back Cushion	COM Yardage Front Panels (per sofa)	COM Yardage Outer Back	COM Yardage Inner Back	COM Yardage Rear Seat
ARMLESS									
68"	7.5	9.5	1	2.3	2.7	0.8	1.1	1	0.5
72"	7.5	9.5	1	2.3	2.7	0.8	1.1	1	0.5
76"	7.5	9.5	1	2.3	2.7	0.8	1.1	1	0.5
80"	7.5	9.5	1	2.3	2.7	0.8	1.1	1	0.5
WITH ARMS									
68"	9.3	11.3	2.5	2.3	2.7	0.8	1.1	1	0.5
72"	9.3	11.3	2.5	2.3	2.7	0.8	1.1	1	0.5
76"	9.3	11.3	2.5	2.3	2.7	0.8	1.1	1	0.5
80"	9.3	11.3	2.5	2.3	2.7	0.8	1.1	1	0.5
WITH WIDE ARMS									
68"	9.3	11.3	2.8	2.3	2.7	0.8	1.1	1	0.5
72"	9.3	11.3	2.8	2.3	2.7	0.8	1.1	1	0.5
76"	9.3	11.3	2.8	2.3	2.7	0.8	1.1	1	0.5
80"	9.3	11.3	2.8	2.3	2.7	0.8	1.1	1	0.5

SOFA SLEEPER W/CENTER SEAT COM REQUIREMENTS

	COM Ydg Complete Unit Grey Outer Back (Standard)	COM Ydg Complete Unit with COM on Outer Back	COM Ydg Armless, Arm or Wide Arm (Pair)	COM Yardage L/R Seat Cushion (per sofa)	COM Ydg Folding Back Cushion	COM Yardage Front Panels (per sofa)	COM Yardage Outer Back	COM Yardage Inner Back	COM Yardage Rear Seat
ARMLESS									
68"	8.5	10.5	1	2.3	2.7	0.8	1.1	1	0.5
72"	8.5	10.5	1	2.3	2.7	0.8	1.1	1	0.5
76"	8.5	10.5	1	2.3	2.7	0.8	1.1	1	0.5
80"	8.5	10.5	1	2.3	2.7	0.8	1.1	1	0.5
WITH ARMS									
68"	10.3	12.3	2.5	2.3	2.7	0.8	1.1	1	0.5
72"	10.3	12.3	2.5	2.3	2.7	0.8	1.1	1	0.5
76"	10.3	12.3	2.5	2.3	2.7	0.8	1.1	1	0.5
80"	10.3	12.3	2.5	2.3	2.7	0.8	1.1	1	0.5
WITH WIDE ARMS									
68"	10.3	12.3	2.8	2.3	2.7	0.8	1.1	1	0.5
72"	10.3	12.3	2.8	2.3	2.7	0.8	1.1	1	0.5
76"	10.3	12.3	2.8	2.3	2.7	0.8	1.1	1	0.5
80"	10.3	12.3	2.8	2.3	2.7	0.8	1.1	1	0.5

NOTE: Some vinyls, leathers and upholsteries are not suitable for application on Amelio seating. The COM approval process is as follows:

1. A sample of the COM must be provided to Krug Customer Service prior to or at the time of order.
2. The sample will be reviewed and the customer advised if the upholstery cover is unsuitable.
3. The COM upholstery cover or leather will be inspected when received at the factory, to identify any further concerns with its suitability.

WEIGHT CAPACITY Amelio Sleep Sofa has been load tested to 750 lbs.

AMELIO MODULAR | MODULE FEATURES



FOOTREST

The Footrest is available on left, right or both seats. The Footrest handle adds 3" per side to the overall width. The Footrest has a weight capacity of 75 lbs, and has a breakaway feature to avoid damage to the mechanism under excessive loading. Footrest option not available with Wide Arms.



POWERDOC

A PowerDoc can be added below Adjustable Height Tables, below Fixed Tables (Not available with storage) and in the front of Wide Arms.



ADJUSTABLE CENTER TABLE

Tables are available in either Thermoformed Vinyl or in Solid Surface. Table has gas-assisted mechanism and has a range of 10.5". Table capacity is 300lbs in the Sit/Sleep position and 150lbs in the raised positions.



FIXED CENTER TABLE

Tables are available in either Thermoformed Vinyl or in Solid Surface.



FIXED CENTER TABLE WITH STORAGE

Tables are available in either Thermoformed Vinyl or in Solid Surface.



SEAT MODULE WITH STORAGE

Available in left, center and right seat positions. Storage features a cleanable interior surface with a vented plastic bottom with a clean-out for debris and liquids. The spring-assisted, stainless steel mechanism holds the seat in the upright position to provide safe access.

AMELIO MODULAR | SLEEP SOFA W/ADJUSTABLE TABLE

Description/Model	COM	COL			FABRIC GRADES			LEATHER		
		1	2	3	4	5	6	7	8	9

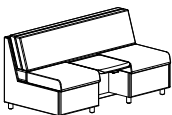

Amelio Sleep Sofa with adjustable center table, no arms and steel legs

	COM	1	2	3	4	5	6	7	8	9
AME6A68ALSNCFATF2	7856	8370	8627	8886	9397	9913	10425	10939	11454	12481
AME6A72ALSNCFATF2	8098	8628	8893	9160	9690	10218	10747	11278	11807	12866
AME6A76ALSNCFATF2	8278	8789	9046	9305	9817	10332	10844	11358	11872	12899
AME6A80ALSNCFATF2	8533	9062	9328	9591	10122	10651	11181	11709	12239	13299

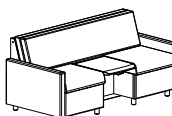

Amelio Sleep Sofa with adjustable center table, upholstered arms and steel legs

	COM	1	2	3	4	5	6	7	8	9
AME6A68UPHNCFATF2	8309	8936	9244	9544	10158	10770	11380	11996	12610	13831
AME6A72UPHNCFATF2	8559	9204	9520	9832	10466	11095	11723	12358	12991	14248
AME6A76UPHNCFATF2	8729	9355	9662	9964	10578	11189	11798	12415	13029	14249
AME6A80UPHNCFATF2	8993	9637	9952	10264	10899	11529	12155	12791	13422	14682

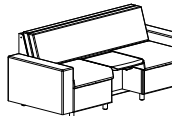

Amelio Sleep Sofa with adjustable center table, upholstered wide arms and steel legs

	COM	1	2	3	4	5	6	7	8	9
AME6A68UPWNCFATF2	8485	9110	9421	9734	10358	10981	11604	12228	12850	14098
AME6A72UPWNCFATF2	8746	9391	9712	10034	10678	11320	11962	12607	13248	14536
AME6A76UPWNCFATF2	8905	9529	9840	10153	10776	11400	12023	12646	13270	14518
AME6A80UPWNCFATF2	9180	9824	10145	10466	11110	11753	12396	13038	13683	14966

ORDERING NOTE: Steel Legs are also available in Polished Chrome, Matte Black, and White finishes, please note clearly on your order.

AMELIO OPTIONS SELECTION:

Amelio Modular can be specified with the options below, choose your configuration facing the unit. To order, use the optional suffixes in the Product Code Key and add the upcharge from the chart below. **Note: No Cap (NC) is an automatic selection for Armless (ALS) units.**

Left Module	List	Center Module	List	Right Module	List	Base Style	List
Left Storage Seat(s)	448	Adj. Solid Surface Table	below	Right Storage Seat	448	Caster	229
Left Seat with Footrest	699			Right Seat with Footrest	699		

Amelio Option Upcharges	List	Grades				
		A - White	A - Color	B	C	
CAL 133 & Moisture Barrier (per yard)	64	Solid Surface Arm Cap (pair)	233	244	265	280
Removable Seat Covers (per seat)	232	Solid Surface Wide Arm Cap (pair)	396	424	479	515
Thermoformed Arm Cap (pair)	182	Solid Surface Table	517	584	711	798
Thermoformed Wide Arm Cap (pair)	331					
Black, Grey or Taupe Urethane Arm Caps (n/a on wide arm)	121					
PowerDoc- Wide Arm	641	Wood Arm Cap (pair)		213	243	
PowerDoc - Table	641	Wood Wide Arm Cap (pair)		299	344	
Swing Away Tablet	458					
Cup Holder for Wide Arm (per cup/arm)	201					

Amelio Sleep Sofas are standard with a latex-free grey colored back. Upholstered backs are available for the following up-charges:

	Grade 1	Grade 2	Grade 3	Grade 4	Grade 5	Grade 6	Grade 7	Grade 8	Grade 9
\$ List	113	169	227	338	451	561	676	786	1015

PRODUCT CODE KEY

Line	Series	Chair Type	Size	Arm Type	Arm Cap Type	Left Module	Center Module	Right Module	Base Style
AME	6	A	68	ALS	NC	F	AT	F	1
Amelio	Motion	Sofa Sleeper w/Adj. Table	68" Sleep Width	Armless	No Cap	Left Fixed Seat	Adj. Thermoformed Table	Right Fixed Seat	Caster
			72	UPH	URE	S	AS	S	2
			72" Sleep Width	Upholstered Arms	Urethane (n/a on wide arm)	Left Storage Seat	Adj. Solid Surface Table	Right Storage Seat	Steel Legs
			76	UPW	WOD	0		O	
			76" Sleep Width	Upholstered Wide Arms	Wood Cap	Left Seat with Footrest		Right Seat with Footrest	
			80		THC				
			80" Sleep Width		Thermoformed Cap	(Standard Uph arms only)		(Standard Uph arms only)	
					SSC				
					Solid Surface Cap				

AMELIO MODULAR | SLEEP SOFA W/FIXED TABLE

Description/Model	COM	COL			FABRIC GRADES			LEATHER		
		1	2	3	4	5	6	7	8	9

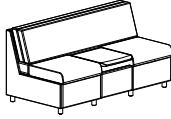

Amelio Sleep Sofa with fixed center table, no arms and steel legs

	COM	1	2	3	4	5	6	7	8	9
AME6F68ALSNCFTXF2	6757	7248	7492	7740	8232	8723	9214	9707	10197	11181
AME6F72ALSNCFTXF2	6964	7472	7725	7978	8486	8993	9498	10006	10513	11527
AME6F76ALSNCFTXF2	7264	7757	8002	8248	8739	9231	9721	10215	10706	11689
AME6F80ALSNCFTXF2	7489	7996	8250	8502	9010	9517	10022	10530	11037	12049

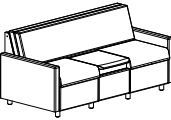

Amelio Sleep Sofa with fixed center table, upholstered arms and steel legs

	COM	1	2	3	4	5	6	7	8	9
AME6F68UPHNCFTXF2	7208	7814	8108	8398	8993	9581	10169	10762	11356	12532
AME6F72UPHNCFTXF2	7423	8045	8352	8653	9263	9868	10473	11088	11698	12909
AME6F76UPHNCFTXF2	7717	8320	8617	8909	9500	10090	10678	11270	11863	13039
AME6F80UPHNCFTXF2	7949	8570	8875	9175	9786	10392	10998	11611	12222	13434

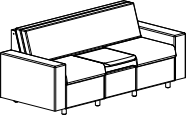

Amelio Sleep Sofa with fixed center table, upholstered wide arms and steel legs

	COM	1	2	3	4	5	6	7	8	9
AME6F68UPWNCFTXF2	7383	7987	8286	8589	9190	9791	10392	10993	11596	12800
AME6F72UPWNCFTXF2	7612	8234	8543	8855	9473	10094	10716	11335	11956	13195
AME6F76UPWNCFTXF2	7893	8495	8797	9096	9697	10300	10903	11504	12107	13308
AME6F80UPWNCFTXF2	8137	8758	9067	9379	9997	10618	11239	11858	12480	13719

ORDERING NOTE: Steel Legs are also available in Polished Chrome, Matte Black, and White finishes, please note clearly on your order.

AMELIO OPTIONS SELECTION:

Amelio Modular can be specified with the options below, choose your configuration facing the unit. To order, use the optional suffixes in the Product Code Key and add the upcharge from the chart below. **Note: No Cap (NC) is an automatic selection for Armless (ALS) units.**

Left Module	List	Center Module	List	Right Module	List	Base Style	List
Left Storage Seat(s)	448	Fixed Thermoformed Table -w/storage	437	Right Storage Seat	448	Caster	229
Left Seat with Footrest	699	Fixed Solid Surface Table	below	Right Seat with Footrest	699		
		Fixed Solid Surface Table-w/storage	below				

Amelio Option Upcharges	List	Grades				
		A - White	A - Color	B	C	
CAL 133 & Moisture Barrier (per yard)	64	Solid Surface Arm Cap (pair)	233	244	265	280
Removable Seat Covers (per seat)	232	Solid Surface Wide Arm Cap (pair)	396	424	479	515
Thermoformed Arm Cap (pair)	182	Solid Surface Table	517	584	711	798
Thermoformed Wide Arm Cap (pair)	331	Solid Surface Table w/Storage	946	1001	1106	1179
Black, Grey or Taupe Urethane Arm Caps (n/a on wide arm)	121					
PowerDoc- Wide Arm	641					
PowerDoc - Table	641	Wood Arm Cap (pair)		213	243	
Swing Away Tablet	458	Wood Wide Arm Cap (pair)		299	344	
Cup Holder for Wide Arm (per cup/arm)	201					

Amelio Sleep Sofas are standard with a latex-free grey colored back. Upholstered backs are available for the following up-charges:

	Grade 1	Grade 2	Grade 3	Grade 4	Grade 5	Grade 6	Grade 7	Grade 8	Grade 9
\$ List	113	169	227	338	451	561	676	786	1015

PRODUCT CODE KEY

Line	Series	Chair Type	Size	Arm Type	Arm Cap Type	Left Module	Center Module	Right Module	Base Style
AME	6	F	68	ALS	NC	F	TX	F	1
Amelio	Motion	Sofa Sleeper w/Fixed Table	68" Sleep Width	Armless	No Cap	Left Fixed Seat	Fixed Thermoformed Table	Right Fixed Seat	Caster
			72	UPH	URE	S	TS	S	2
			72" Sleep Width	Upholstered Arms	Urethane (n/a on wide arm)	Left Storage Seat	Fixed Thermoformed Table w/storage	Right Storage Seat	Steel Legs
			76	UPW	WOD	0	SX	O	
			76" Sleep Width	Upholstered Wide Arms	Wood Cap	Left Seat with Footrest (Standard Uph arms only)	Fixed Solid Surface Table	Right Seat with Footrest (Standard Uph arms only)	
			80		THC		SS		
			80" Sleep Width		Thermoformed Cap		Fixed Solid Surface Table w/Storage		
					SSC				
					Solid Surface Cap				

AMELIO MODULAR | SLEEP SOFA W/CENTER SEAT

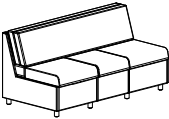
Description/Model	COM	COL			FABRIC GRADES			LEATHER			
		1	2	3	4	5	6	7	8	9	
 Amelio Sleep Sofa with center seat, no arms and steel legs COM	AME6C68ALSNCFCXF2	6269	6787	7044	7302	7817	8334	8847	9363	9879	10909
	AME6C72ALSNCFCXF2	6464	6996	7262	7528	8058	8591	9120	9653	10183	11246
	AME6C76ALSNCFCXF2	6708	7254	7524	7796	8343	8889	9435	9979	10524	11615
	AME6C80ALSNCFCXF2	6914	7478	7758	8039	8600	9164	9725	10287	10850	11975

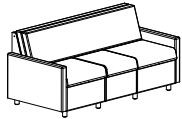
 Amelio Sleep Sofa with center seat, upholstered arms and steel legs COM	AME6C68UPHNCFCXF2	6722	7350	7658	7963	8579	9191	9802	10419	11036	12259
	AME6C72UPHNCFCXF2	6924	7570	7888	8200	8835	9467	10096	10733	11367	12630
	AME6C76UPHNCFCXF2	7159	7817	8141	8458	9104	9747	10388	11035	11681	12966
	AME6C80UPHNCFCXF2	7374	8053	8385	8711	9380	10041	10701	11367	12034	13357

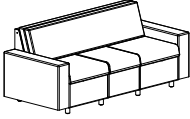
 Amelio Sleep Sofa with center seat, upholstered wide arms and steel legs COM	AME6C68UPWNCFCXF2	6897	7524	7838	8150	8778	9400	10025	10653	11278	12529
	AME6C72UPWNCFCXF2	7110	7758	8081	8404	9046	9692	10336	10984	11625	12915
	AME6C76UPWNCFCXF2	7335	7990	8318	8647	9303	9959	10613	11268	11923	13236
	AME6C80UPWNCFCXF2	7564	8238	8578	8915	9589	10264	10941	11616	12291	13642

ORDERING NOTE:

Steel Legs are also available in Polished Chrome, Matte Black, and White finishes, please note clearly on your order.

AMELIO OPTIONS SELECTION:

Amelio Modular can be specified with the options below, choose your configuration facing the unit. To order, use the optional suffixes in the Product Code Key and add the upcharge from the chart below. **Note: No Cap (NC) is an automatic selection for Armless (ALS) units.**

Left Module	List	Center Module	List	Right Module	List	Base Style	List
Left Storage Seat(s)	448	Center Seat -w/storage	437	Right Storage Seat	448	Caster	229
Left Seat with Footrest	699			Right Seat with Footrest	699		

Amelio Option Upcharges	List	Grades				
		A - White	A - Color	B	C	
CAL 133 & Moisture Barrier (per yard)	64	Solid Surface Arm Cap (pair)	233	244	265	280
Removable Seat Covers (per seat)	232	Solid Surface Wide Arm Cap (pair)	396	424	479	515
Thermoformed Arm Cap (pair)	182					
Thermoformed Wide Arm Cap (pair)	331					
Black, Grey or Taupe Urethane Arm Caps (n/a on wide arm)	121					
PowerDoc- Wide Arm	641					
PowerDoc - Table	641	Wood Arm Cap (pair)		213	243	
Swing Away Tablet	458	Wood Wide Arm Cap (pair)		299	344	
Cup Holder for Wide Arm (per cup/arm)	201					

Amelio Sleep Sofas are standard with a latex-free grey colored back. Upholstered backs are available for the following up-charges:

	Grade 1	Grade 2	Grade 3	Grade 4	Grade 5	Grade 6	Grade 7	Grade 8	Grade 9
\$ List	113	169	227	338	451	561	676	786	1015

PRODUCT CODE KEY

Line	Series	Chair Type	Size	Arm Type	Arm Cap Type	Left Module	Center Module	Right Module	Base Style
AME	6	C	68	ALS	NC	F	CX	F	1
Amelio	Motion	Sofa Sleeper w/Center Seat	68" Sleep Width	Armless	No Cap	Left Fixed Seat	Center Seat	Right Fixed Seat	Caster
			72	UPH	URE	S	CS	S	2
			72" Sleep Width	Upholstered Arms	Urethane (n/a on wide arm)	Left Storage Seat	Center Seat w/Storage	Right Storage Seat	Steel Legs
			76	UPW	WOD	0		O	
			76" Sleep Width	Upholstered Wide Arms	Wood Cap	Left Seat with Footrest		Right Seat with Footrest	
			80		THC				
			80" Sleep Width		Thermoformed Cap				
					SSC				
					Solid Surface Cap				

AMELIO BENCH SLEEPER | ENVIRONMENTAL SUMMARY

LEED CI CREDITS



MATERIAL CONTENT:

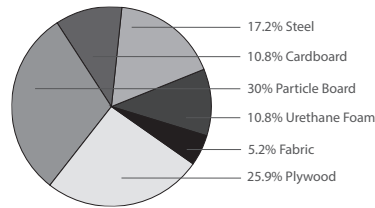

PRE-CONSUMER
RECYCLED CONTENT =37.18%

POST-CONSUMER
RECYCLED CONTENT =13.69%

Up to 28.02% of this Bench Sleeper product is recyclable at the end of its useful life.

CONTRIBUTES TO

CREDIT 2.1 - 2.2	Construction Waste Management	1-2 point(s)
CREDIT 3.3	Resource Reuse	1 point
CREDIT 4.1	Recycled Content	1 point
CREDIT 4.2	Recycled Content	1 point
CREDIT 4.5	Low Emitting Materials, Systems & Seating	1 point
CREDIT 5.1	Regional Materials*	1 point
CREDIT 7	Certified Wood (MUST BE REQUESTED)	1 point(s)

*This credit is only applicable if in total 20% of the combined value of the procurement of construction materials and in the furniture are manufactured within a radius of 500 miles. This credit will apply if the installation of the finished product occurs within 500 miles of Kitchener, Ontario.

level® CERTIFICATION, AIR EMISSIONS AND FSC® CERTIFICATION



level® CERTIFICATION

BIFMA's e3 Furniture Sustainability Standard is a voluntary, multi-attribute standard that measures the degree of sustainability of furniture. This standard evaluates product and company environmental attributes and compliance systems in a wide range of elements which include Materials, Energy & Atmosphere, Human & Ecosystem Health and Social Responsibility. Amelio products have earned level®, BIFMA's sustainability certification program for furniture, certification through third-party verification against the e3 standard.

AIR-EMISSIONS

All Amelio products are supplied with air-emissions certified. Contact customer service for information.



FSC®

In 2005, Krug received Forest Stewardship Council® (FSC®) Chain-of-Custody certification for our manufacturing facilities. The FSC® Chain-of-Custody tracks certified wood from seedling to final sale. It verifies that the material for our FSC® certified products only come from well-managed, FSC®-certified forests and other controlled sources. FSC® is dedicated to the promotion of responsible forest management worldwide helping to take care of forests for future generations. Amelio and other Krug products can be specified with FSC® Certification. Contact customer service for further information, pricing and lead times.



Architects, designers, and building professionals can specify FSC®-certified products in order to achieve a point from the U.S. Green Building Council's Leadership in Energy and Environmental Design (LEED) Rating System.

AMELIO BENCH SLEEPER | FEATURES & OPTIONS

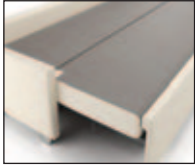

FOLD DOWN SLEEP SURFACE

The seat cushion folds out onto a forward extending platform to transform the bench into a full-length sleeper. It features comfortable foam with a vinyl surface. Cushions can be removed for cleaning or replacement.



STEEL CONSTRUCTION

A welded steel interior framework provides exceptional strength and durability for extended product life and problem-free usage. The platform over the framework is covered in an attractive, durable upholstered cover to support infection control and ease of cleaning.



STEEL LEGS

The standard base is a 3" tall round steel leg in Silver Metallic with polymer glides. Rear glides are adjustable.



LATEX FREE

Krug products are made with latex-free materials to prevent the allergic reaction that latex causes in some people



REPLACEABLE COMPONENTS

Amelio Bench Sleepers is uniquely designed to allow major components to be field replaced, providing a very cost effective means to significantly extend the life of the product.



REMOVABLE COVERS

Removable seat and mattress covers are standard for easy cleaning or replacement.



LOCKING CASTERS

3" dual-wheel locking caster models are available.

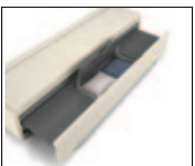

STORAGE COMPARTMENT

Optional under-seat storage compartment features a cleanable interior surface with a vented bottom, and a clean-out for debris and liquids. The spring-assisted hinges hold the storage lid in the upright position to provide safe access.



ARM

Upholstered side arms can be trimmed with optional Grey & Black Urethane or Solid Surface Arm Caps to enhance the durability of the arms and provide a cleanable surface.



LAMINATE FRONT PANEL

Laminate can be specified for the front panel in Krug's in-stock laminates with matching 3mm edging. See page 631 for laminate selection.

WEIGHT CAPACITIES

Amelio Bench Sleepers has been tested and complies with ANSI/BIFMA x5.4-2012 standards.

Amelio Bench Sleepers has a load weight rating of 525lbs

CUSTOM SIZING

Custom sizes are available and can be quoted, with a minimum order quantity of 10 units per size. Custom depth dimensions may require a higher minimum order quantity. Please contact Customer Service for a special quote.

COMBINATION UPHOLSTERY OPTIONS

When combination upholstery is specified with fabric of the same grade or COM, an upcharge for dual fabrics is **\$33 list** per unit and **\$64 list** per unit for three fabrics will be applied. When graded in combination upholstery is selected, use the highest grade upholstery selected or to obtain a quote for blended grading contact Customer Service (please provide the fabrics specified and location of where each fabric is to be applied on the product).

CAL 133 & MOISTURE BARRIER

California Technical Bulletin 133 is a flammability test for seating. Krug offers a compliance method which, in combination with non-flammable upholstery covers, may enable the products to meet certification requirements for this test. This process at the same time also provides the products with a Moisture Barrier - a treatment that helps to prevent the passage of liquids and moisture to inside of upholstered components - thereby conferring sanitary and anti-infection benefits. So when CAL 133 is specified, the product also automatically has a Moisture Barrier, and when a Moisture Barrier is specified, the product also features the compliance method and low flammability features of CAL 133. CAL 133 and Moisture Barrier are available for an upcharge of **\$64 list** per yard.

The application of this upcharge and the compliance method does not mean that the specific configuration of product and upholstery cover are tested and officially certified as being CAL 133 compliant. If official certification is required, Krug will provide this (through an independent testing laboratory) at a charge of \$917 per item, plus the cost of the product to be tested. Lead time for certification testing is typically 4-8 weeks. Krug assumes no responsibility for the testing of our products in combination with upholstery covers, or for the results of any testing conducted. Some specific configurations of product and upholstery have already been tested. Please contact Customer Service for additional information.

DIMENSIONS

	Overall Width	Overall Depth (extended)	Overall Height	Sleep Surface Length	Seat Height (Sleep)	Width Between Arms	Arm Height	Seat Depth (Sleep)	Weight	Cubes
Armless										
68	70	21.5 (38)	19.5	68	19.5 (12")	n/a	n/a	21.5" (34)	158	21
72	74	21.5 (38)	19.5	72	19.5 (12")	n/a	n/a	21.5" (34)	166	22
76	78	21.5 (38)	19.5	76	19.5 (12")	n/a	n/a	21.5" (34)	174	24
80	82	21.5 (38)	19.5	80	19.5 (12")	n/a	n/a	21.5" (34)	182	25
With Arms										
68	74	21.5 (38)	27.5	68	19.5 (12")	68	27.5	21.5" (34)	198	33
72	78	21.5 (38)	27.5	72	19.5 (12")	72	27.5	21.5" (34)	206	34
76	82	21.5 (38)	27.5	76	19.5 (12")	76	27.5	21.5" (34)	214	36
80	86	21.5 (38)	27.5	80	19.5 (12")	80	27.5	21.5" (34)	222	37
Armless with Back										
68	70	21.5 (38)	35	68	19.5 (12")	n/a	n/a	17.5" (34)	168	37
72	74	21.5 (38)	35	72	19.5 (12")	n/a	n/a	17.5" (34)	177	39
76	78	21.5 (38)	35	76	19.5 (12")	n/a	n/a	17.5" (34)	186	41
80	82	21.5 (38)	35	80	19.5 (12")	n/a	n/a	17.5" (34)	195	43
With Arms and Back										
68	74	21.5 (38)	35	68	19.5 (12")	68	27.5	17.5" (34)	208	41
72	78	21.5 (38)	35	72	19.5 (12")	72	27.5	17.5" (34)	217	43
76	82	21.5 (38)	35	76	19.5 (12")	76	27.5	17.5" (34)	226	45
80	86	21.5 (38)	35	80	19.5 (12")	80	27.5	17.5" (34)	235	47
Storage Compartment										
68	28.75	11	6							
72	28.75	11	6							
76	28.75	11	6							
80	28.75	11	6							

COM REQUIREMENTS

	COM Yardage Complete Unit Standard Grey Outer Back	COM Yardage Complete Unit Coordinating Back	COM Yardage Seat Cushion	COM Yardage Full Height Back (w/Grey Outer Back)	COM Yardage Rear Panel Without Back	COM Yardage Front Kick Panel	COM Yardage Side Arms (set of 2)	COM Yardage Armless Side Panels (set of 2)
Armless								
68								
72	n/a	5.08	1.4	n/a	1.7	1.08	n/a	0.9
76								
80	n/a	5.08	1.4	n/a	1.7	1.08	n/a	0.9
With Arms								
68								
72	n/a	5.88	1.4	n/a	1.7	1.08	1.7	n/a
76								
80	n/a	5.88	1.4	n/a	1.7	1.08	1.7	n/a
Armless with Back								
68								
72	4.68	6.48	1.4	3.1 (1.3)	n/a	1.08	n/a	0.9
76								
80	4.68	6.48	1.4	3.1 (1.3)	n/a	1.08	n/a	0.9
With Arms and Back								
68								
72	5.48	7.28	1.4	3.1 (1.3)	n/a	1.08	1.7	n/a
76								
80	5.48	7.28	1.4	3.1 (1.3)	n/a	1.08	1.7	n/a

NOTE: Some vinyls, leathers and upholsteries are not suitable for application on Amelio seating.

The approval process is as follows:

1. A sample of the COM must be provided to Krug Customer Service prior to or at the time of order.
2. The sample will be reviewed and the customer advised if the upholstery cover is unsuitable.
3. The COM upholstery cover or leather will be inspected when received at the factory, to identify any further concerns with its suitability.

AMELIO | BENCH SLEEPERS

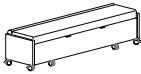
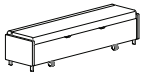
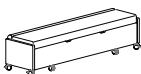
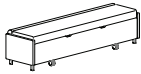
Description	Model	COM		COL		FABRIC GRADES		LEATHER		
		1	2	3	4	5	6	7	8	9
	68" Sleep surface, without back, upholstered front, without storage, armless with casters AME6BS68XUFALSNC1	4446	4587	4728	5006	5284	5562	5841	6120	6679
	72" Sleep surface, without back, upholstered front, without storage, armless with casters AME6BS72XUFALSNC1	4504	4645	4786	5068	5351	5634	5916	6199	6764
	76" Sleep surface, without back, upholstered front, without storage, armless with casters AME6BS76XUFALSNC1	4560	4705	4845	5132	5419	5704	5991	6276	6849
	80" Sleep surface, without back, upholstered front, without storage, armless with casters AME6BS80XUFALSNC1	4616	4762	4905	5195	5484	5775	6064	6356	6936
	68" Sleep surface, without back, upholstered front, without storage, armless with legs AME6BS68XUFALSNC2	4339	4480	4618	4898	5176	5455	5735	6014	6571
	72" Sleep surface, without back, upholstered front, without storage, armless with legs AME6BS72XUFALSNC2	4396	4537	4679	4961	5243	5527	5809	6091	6657
	76" Sleep surface, without back, upholstered front, without storage, armless with legs AME6BS76XUFALSNC2	4454	4595	4738	5024	5310	5596	5884	6167	6742
	80" Sleep surface, without back, upholstered front, without storage, armless with legs AME6BS80XUFALSNC2	4509	4654	4798	5087	5378	5667	5958	6246	6828
	68" Sleep surface, without back, upholstered front, with storage, armless with casters AME6BS68XUSALSNC1	4785	4923	5063	5341	5620	5898	6180	6458	7016
	72" Sleep surface, without back, upholstered front, with storage, armless with casters AME6BS72XUSALSNC1	4844	4986	5128	5411	5693	5975	6256	6540	7105
	76" Sleep surface, without back, upholstered front, with storage, armless with casters AME6BS76XUSALSNC1	4905	5050	5191	5478	5765	6050	6336	6623	7193
	80" Sleep surface, without back, upholstered front, with storage, armless with casters AME6BS80XUSALSNC1	4967	5111	5257	5546	5835	6126	6416	6706	7284
	68" Sleep surface, without back, upholstered front, with storage, armless with legs AME6BS68XUSALSNC2	4678	4816	4956	5234	5513	5792	6072	6350	6909
	72" Sleep surface, without back, upholstered front, with storage, armless with legs AME6BS72XUSALSNC2	4737	4878	5021	5303	5586	5868	6149	6432	6997
	76" Sleep surface, without back, upholstered front, with storage, armless with legs AME6BS76XUSALSNC2	4798	4943	5084	5369	5658	5943	6229	6515	7087
	80" Sleep surface, without back, upholstered front, with storage, armless with legs AME6BS80XUSALSNC2	4860	5005	5149	5439	5727	6019	6308	6598	7177

ORDERING NOTES: Bench sleepers can be specified with Urethane (URE) or Solid Surface (SSC) arm caps, replace "NC" in the model number with the **Arm Cap Type** selection below and add the upcharge.

Amelio Bench Sleeper Option Upcharges	\$ List
CAL133 & Moisture Barrier (per yard)	64
Laminate Front Panel	308
Urethane Arm Caps (per pair)	138
Combination Upholstery - dual fabrics	33

Amelio Bench Sleepers are standard with a latex-free grey colored back. Coordinating upholstered backs are available for the following up-charges:

	Grade 1	Grade 2	Grade 3	Grade 4	Grade 5	Grade 6	Grade 7	Grade 8	Grade 9
\$ List	113	169	227	338	451	561	676	786	1015

PRODUCT CODE KEY

Line	Series	Chair Type	Size	Back Type	Front Type	Storage	Arm Type	Arm Cap Type	Base Style
AME	6	BS	68	X	U	F	ALS	NC	1
Amelio	Motion	Bench Sleepers	68" Sleep Surface	without back	Upholstered	w/o Storage	Armless	No Cap	Casters
			72	B	L	S	UPH	URE	2
			72" Sleep Surface	with back	Laminate	Storage	Upholstered Arm	Urethane	Legs
			76					SSC	
			76" Sleep Surface					Solid Surface	
			80						
			80" Sleep Surface						

AMELIO | BENCH SLEEPERS

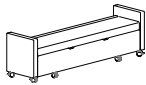
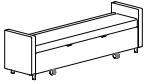
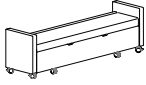
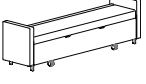
Description	Model	COM		COL		FABRIC GRADES			LEATHER	
		1	2	3	4	5	6	7	8	9
	68" Sleep surface, without back, upholstered front, without storage, upholstered arm with casters AME6BS68XUFUPHNC1	4809	4967	5125	5444	5764	6081	6402	6718	7357
	72" Sleep surface, without back, upholstered front, without storage, upholstered arm with casters AME6BS72XUFUPHNC1	4863	5024	5187	5508	5831	6155	6475	6796	7442
	76" Sleep surface, without back, upholstered front, without storage, upholstered arm with casters AME6BS76XUFUPHNC1	4920	5083	5244	5572	5896	6224	6550	6875	7528
	80" Sleep surface, without back, upholstered front, without storage, upholstered arm with casters AME6BS80XUFUPHNC1	4977	5140	5306	5635	5965	6293	6625	6955	7613
	68" Sleep surface, without back, upholstered front, without storage, upholstered arm with legs AME6BS68XUFUPHNC2	4698	4860	5017	5338	5657	5973	6293	6611	7249
	72" Sleep surface, without back, upholstered front, without storage, upholstered arm with legs AME6BS72XUFUPHNC2	4756	4918	5079	5399	5722	6046	6367	6689	7335
	76" Sleep surface, without back, upholstered front, without storage, upholstered arm with legs AME6BS76XUFUPHNC2	4813	4974	5138	5465	5789	6115	6442	6767	7420
	80" Sleep surface, without back, upholstered front, without storage, upholstered arm with legs AME6BS80XUFUPHNC2	4868	5033	5197	5528	5857	6186	6518	6847	7506
	68" Sleep surface, without back, upholstered front, with storage, upholstered arm with casters AME6BS68XUSUPHNC1	5143	5303	5464	5782	6099	6419	6737	7057	7696
	72" Sleep surface, without back, upholstered front, with storage, upholstered arm with casters AME6BS72XUSUPHNC1	5205	5366	5527	5849	6170	6494	6817	7137	7785
	76" Sleep surface, without back, upholstered front, with storage, upholstered arm with casters AME6BS76XUSUPHNC1	5264	5428	5590	5917	6243	6570	6895	7221	7873
	80" Sleep surface, without back, upholstered front, with storage, upholstered arm with casters AME6BS80XUSUPHNC1	5327	5492	5657	5986	6315	6644	6974	7304	7964
	68" Sleep surface, without back, upholstered front, with storage, upholstered arm with legs AME6BS68XUSUPHNC2	5036	5195	5355	5674	5992	6312	6630	6948	7587
	72" Sleep surface, without back, upholstered front, with storage, upholstered arm with legs AME6BS72XUSUPHNC2	5097	5259	5419	5741	6063	6387	6709	7031	7677
	76" Sleep surface, without back, upholstered front, with storage, upholstered arm with legs AME6BS76XUSUPHNC2	5159	5320	5483	5810	6136	6463	6788	7114	7765
	80" Sleep surface, without back, upholstered front, with storage, upholstered arm with legs AME6BS80XUSUPHNC2	5218	5384	5548	5878	6208	6537	6868	7197	7856

ORDERING NOTES: Bench sleepers can be specified with Urethane (URE) or Solid Surface (SSC) arm caps, replace "NC" in the model number with the **Arm Cap Type** selection below and add the upcharge.

Amelio Bench Sleeper Option Upcharges	\$ List		\$ List
CAL133 & Moisture Barrier (per yard)	64	Solid Surface Arm Cap (per pair) - Gr A White	231
Laminate Front Panel	308	Solid Surface Arm Cap (per pair) - Gr A Color	240
Urethane Arm Caps (per pair)	138	Solid Surface Arm Cap (per pair) - Gr B	256
Combination Upholstery - dual fabrics	33	Solid Surface Arm Cap (per pair) - Gr C	267





Amelio Bench Sleepers are standard with a latex-free grey colored back. Coordinating upholstered backs are available for the following up-charges:

	Grade 1	Grade 2	Grade 3	Grade 4	Grade 5	Grade 6	Grade 7	Grade 8	Grade 9
\$ List	113	169	227	338	451	561	676	786	1015

PRODUCT CODE KEY

Line	Series	Chair Type	Size	Back Type	Front Type	Storage	Arm Type	Arm Cap Type	Base Style
AME	6	BS	68	X	U	F	ALS	NC	1
Amelio	Motion	Bench Sleepers	68" Sleep Surface	without back	Upholstered	w/o Storage	Armless	No Cap	Casters
			72	B	L	S	UPH	URE	2
			72" Sleep Surface	with back	Laminate	Storage	Upholstered Arm	Urethane	Legs
			76					SSC	
			76" Sleep Surface					Solid Surface	
			80						
			80" Sleep Surface						

AMELIO | BENCH SLEEPERS

Description	Model	COM		COL		FABRIC GRADES			LEATHER	
		1	2	3	4	5	6	7	8	9
	68" Sleep surface, with back, upholstered front, without storage, armless with casters AME6BS68BUFALSNC1	4670	4799	4928	5185	5442	5698	5955	6212	6728
	72" Sleep surface, with back, upholstered front, without storage, armless with casters AME6BS72BUFALSNC1	4730	4861	4990	5250	5510	5770	6032	6291	6813
	76" Sleep surface, with back, upholstered front, without storage, armless with casters AME6BS76BUFALSNC1	4789	4921	5054	5317	5581	5843	6108	6372	6897
	80" Sleep surface, with back, upholstered front, without storage, armless with casters AME6BS80BUFALSNC1	4846	4981	5115	5384	5649	5916	6184	6449	6985
	68" Sleep surface, with back, upholstered front, without storage, armless with legs AME6BS68BUFALSNC2	4564	4692	4819	5078	5336	5590	5847	6105	6620
	72" Sleep surface, with back, upholstered front, without storage, armless with legs AME6BS72BUFALSNC2	4622	4754	4883	5142	5404	5663	5924	6184	6706
	76" Sleep surface, with back, upholstered front, without storage, armless with legs AME6BS76BUFALSNC2	4681	4814	4946	5210	5472	5737	6000	6264	6791
	80" Sleep surface, with back, upholstered front, without storage, armless with legs AME6BS80BUFALSNC2	4740	4874	5008	5275	5541	5809	6077	6343	6877
	68" Sleep surface, with back, upholstered front, with storage, armless with casters AME6BS68BUSALSNC1	4988	5117	5245	5503	5761	6017	6272	6531	7045
	72" Sleep surface, with back, upholstered front, with storage, armless with casters AME6BS72BUSALSNC1	5053	5183	5314	5573	5834	6095	6353	6612	7134
	76" Sleep surface, with back, upholstered front, with storage, armless with casters AME6BS76BUSALSNC1	5115	5247	5381	5642	5906	6168	6435	6697	7225
	80" Sleep surface, with back, upholstered front, with storage, armless with casters AME6BS80BUSALSNC1	5179	5314	5447	5715	5979	6246	6515	6780	7315
	68" Sleep surface, with back, upholstered front, with storage, armless with legs AME6BS68BUSALSNC2	4882	5010	5139	5394	5655	5911	6165	6422	6938
	72" Sleep surface, with back, upholstered front, with storage, armless with legs AME6BS72BUSALSNC2	4945	5077	5205	5466	5726	5988	6245	6506	7027
	76" Sleep surface, with back, upholstered front, with storage, armless with legs AME6BS76BUSALSNC2	5008	5140	5273	5536	5799	6061	6328	6590	7117
	80" Sleep surface, with back, upholstered front, with storage, armless with legs AME6BS80BUSALSNC2	5071	5205	5339	5607	5871	6139	6408	6673	7208

ORDERING NOTES: Bench sleepers can be specified with Urethane (URE) or Solid Surface (SSC) arm caps, replace "NC" in the model number with the **Arm Cap Type** selection below and add the upcharge.

Amelio Bench Sleeper Option Upcharges	\$ List		\$ List
CAL133 & Moisture Barrier (per yard)	64	Combination Upholstery - dual fabrics	33
Laminate Front Panel	308	Combination Upholstery -Three fabrics	64
Urethane Arm Caps (per pair)	138		





Amelio Bench Sleepers are standard with a latex-free grey colored back. Coordinating upholstered backs are available for the following up-charges:

	Grade 1	Grade 2	Grade 3	Grade 4	Grade 5	Grade 6	Grade 7	Grade 8	Grade 9
\$ List	113	169	227	338	451	561	676	786	1015

PRODUCT CODE KEY

Line	Series	Chair Type	Size	Back Type	Front Type	Storage	Arm Type	Arm Cap Type	Base Style
AME	6	BS	68	X	U	F	ALS	NC	1
Amelio	Motion	Bench Sleepers	68" Sleep Surface	without back	Upholstered	w/o Storage	Armless	No Cap	Casters
			72	B	L	S	UPH	URE	2
			72" Sleep Surface	with back	Laminate	Storage	Upholstered Arm	Urethane	Legs
			76					SSC	
			76" Sleep Surface					Solid Surface	
			80						
			80" Sleep Surface						

AMELIO | BENCH SLEEPERS

Description	Model	COM		COL		FABRIC GRADES			LEATHER	
		1	2	3	4	5	6	7	8	9
	68" Sleep surface, with back, upholstered front, without storage, upholstered arm with casters AME6BS68BUFUPHNC1	5031	5179	5328	5623	5919	6218	6515	6813	7405
	72" Sleep surface, with back, upholstered front, without storage, upholstered arm with casters AME6BS72BUFUPHNC1	5089	5240	5390	5691	5991	6290	6590	6891	7491
	76" Sleep surface, with back, upholstered front, without storage, upholstered arm with casters AME6BS76BUFUPHNC1	5149	5300	5453	5757	6059	6363	6665	6970	7577
	80" Sleep surface, with back, upholstered front, without storage, upholstered arm with casters AME6BS80BUFUPHNC1	5209	5363	5516	5823	6129	6436	6742	7048	7661
	68" Sleep surface, with back, upholstered front, without storage, upholstered arm with legs AME6BS68BUFUPHNC2	4922	5071	5219	5517	5812	6111	6408	6706	7296
	72" Sleep surface, with back, upholstered front, without storage, upholstered arm with legs AME6BS72BUFUPHNC2	4981	5132	5283	5583	5884	6183	6483	6784	7384
	76" Sleep surface, with back, upholstered front, without storage, upholstered arm with legs AME6BS76BUFUPHNC2	5040	5192	5345	5649	5953	6255	6558	6863	7468
	80" Sleep surface, with back, upholstered front, without storage, upholstered arm with legs AME6BS80BUFUPHNC2	5099	5256	5408	5716	6021	6330	6633	6941	7555
	68" Sleep surface, with back, upholstered front, with storage, upholstered arm with casters AME6BS68BUSUPHNC1	5347	5497	5646	5943	6240	6537	6833	7130	7724
	72" Sleep surface, with back, upholstered front, with storage, upholstered arm with casters AME6BS72BUSUPHNC1	5412	5561	5713	6014	6313	6611	6913	7213	7814
	76" Sleep surface, with back, upholstered front, with storage, upholstered arm with casters AME6BS76BUSUPHNC1	5474	5629	5780	6082	6387	6689	6993	7295	7905
	80" Sleep surface, with back, upholstered front, with storage, upholstered arm with casters AME6BS80BUSUPHNC1	5538	5693	5846	6154	6461	6766	7072	7381	7993
	68" Sleep surface, with back, upholstered front, with storage, upholstered arm with legs AME6BS68BUSUPHNC2	5241	5390	5538	5835	6133	6430	6725	7021	7616
	72" Sleep surface, with back, upholstered front, with storage, upholstered arm with legs AME6BS72BUSUPHNC2	5305	5454	5605	5905	6207	6505	6806	7106	7705
	76" Sleep surface, with back, upholstered front, with storage, upholstered arm with legs AME6BS76BUSUPHNC2	5367	5519	5671	5975	6280	6582	6885	7189	7795
	80" Sleep surface, with back, upholstered front, with storage, upholstered arm with legs AME6BS80BUSUPHNC2	5430	5586	5739	6045	6352	6660	6965	7271	7887

ORDERING NOTES: Bench sleepers can be specified with Urethane (URE) or Solid Surface (SSC) arm caps, replace "NC" in the model number with the **Arm Cap Type** selection below and add the upcharge.

Amelio Bench Sleeper Option Upcharges	\$ List		\$ List
CAL133 & Moisture Barrier (per yard)	64	Solid Surface Arm Cap (per pair) - Gr A White	231
Laminate Front Panel	308	Solid Surface Arm Cap (per pair) - Gr A Color	240
Urethane Arm Caps (per pair)	138	Solid Surface Arm Cap (per pair) - Gr B	256
Combination Upholstery - dual fabrics	33	Solid Surface Arm Cap (per pair) - Gr C	267

Amelio Bench Sleepers are standard with a latex-free grey colored back. Coordinating upholstered backs are available for the following up-charges:

	Grade 1	Grade 2	Grade 3	Grade 4	Grade 5	Grade 6	Grade 7	Grade 8	Grade 9
\$ List	113	169	227	338	451	561	676	786	1015

PRODUCT CODE KEY

Line	Series	Chair Type	Size	Back Type	Front Type	Storage	Arm Type	Arm Cap Type	Base Style
AME	6	BS	68	X	U	F	ALS	NC	1
Amelio	Motion	Bench Sleepers	68" Sleep Surface	without back	Upholstered	w/o Storage	Armless	No Cap	Casters
			72	B	L	S	UPH	URE	2
			72" Sleep Surface	with back	Laminate	Storage	Upholstered Arm	Urethane	Legs
			76					SSC	
			76" Sleep Surface					Solid Surface	
			80						
			80" Sleep Surface						

JORDAN LOUNGE SLEEPERS | LEED CI CREDIT SUMMARY

Jordan Lounge Sleepers



MATERIAL CONTENT:

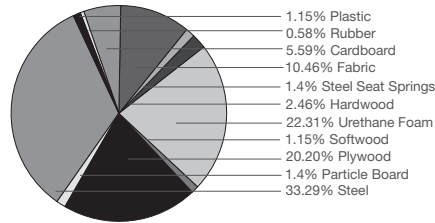

PRE-CONSUMER
RECYCLED CONTENT = 5.49%

POST-CONSUMER
RECYCLED CONTENT = 40.69%

Up to 42.44% of this Jordan Lounge Sleepers product is recyclable at the end of its useful life.

CONTRIBUTES TO

CREDIT 2.1 - 2.2	Construction Waste Management	1-2 point(s)
CREDIT 3.3	Resource Reuse	1 point
CREDIT 4.1	Recycled Content	1 point
CREDIT 4.2	Recycled Content	1 point
CREDIT 4.5	Low Emitting Materials, Systems & Seating	1 point
CREDIT 5.1	Regional Materials*	1 point
CREDIT 7	Certified Wood (MUST BE REQUESTED)	1 point(s)

*This credit is only applicable if in total 20% of the combined value of the procurement of construction materials and in the furniture are manufactured within a radius of 500 miles. This credit will apply if the installation of the finished product occurs within 500 miles of Kitchener, Ontario.

level® CERTIFICATION, AIR EMISSIONS AND FSC® CERTIFICATION



level® CERTIFICATION

BIFMA's e3 Furniture Sustainability Standard is a voluntary, multi-attribute standard that measures the degree of sustainability of furniture. This standard evaluates product and company environmental attributes and compliance systems in a wide range of elements which include Materials, Energy & Atmosphere, Human & Ecosystem Health and Social Responsibility. Jordan products have earned level®, BIFMA's sustainability certification program for furniture, certification through third-party verification against the e3 standard.

AIR-EMISSIONS

All Jordan products are supplied with air-emissions certified. Contact customer service for information.



FSC®

In 2005, Krug received Forest Stewardship Council® (FSC®) Chain-of-Custody certification for our manufacturing facilities. The FSC® Chain-of-Custody tracks certified wood from seedling to final sale. It verifies that the material for our FSC® certified products only come from well-managed, FSC®-certified forests and other controlled sources. FSC® is dedicated to the promotion of responsible forest management worldwide helping to take care of forests for future generations. Jordan and other Krug products can be specified with FSC® Certification. Contact customer service for further information, pricing and lead times.



Architects, designers, and building professionals can specify FSC®-certified products in order to achieve a point from the U.S. Green Building Council's Leadership in Energy and Environmental Design (LEED) Rating System.

DIMENSIONS

	Overall Width	Overall Depth Chair	Overall Depth Chaise	Overall Depth Bed	Overall Height	Seat Height	Width Between Arms	Seat Depth	Shipping Weight	Cubes
One-Seat	35	38	65	87	39	19	28.5	19.5	150	41
Two-Seat	54	38	65	87	39	19	48	19.5	205	63

COM REQUIREMENTS

	COM Yardage Complete Unit	COM Yardage Seat Only	COM Yardage Back Only	COM Yardage Low Outer Back (Panel) Only	COM Yardage Arm Panel Only	COM Yardage Kickplate Upholstery Only	COM Yardage Ottoman Upholstery Only
One-Seat - One Chair	7.3	1.4	1.6	.8	2.9	.4	1
One-Seat - Two Chairs	14.6	2.8	3.2	1.6	5.8	.8	2
One-Seat - Three Chairs	22	4.3	4.8	2.4	8.7	1.2	3
One-Seat - Four Chairs	29.3	5.7	6.4	3.2	11.6	1.6	4
Two-Seat - One Chair	9.0	1.8	2.2	.8	2.9	.4	1.7
Two-Seat - Two Chairs	17.4	3.6	3.8	1.6	5.8	.8	3.4
Two-Seat - Three Chairs	26.4	5.4	6	2.4	8.7	1.2	5.1
Two-Seat - Four Chairs	34.8	7.2	7.6	3.2	11.6	1.6	6.8

NOTE: Some vinyls, leathers and upholsteries are not suitable for application on Jordan seating.

The approval process is as follows:

1. A sample of the COM must be provided to Krug Customer Service prior to or at the time of order.
2. The sample will be reviewed and the customer advised if the upholstery cover is unsuitable.
3. The COM upholstery cover or leather will be inspected when received at the factory, to identify any further concerns with its suitability.



One-Seat Lounge Sleepers



Two-Seat Lounge Sleepers

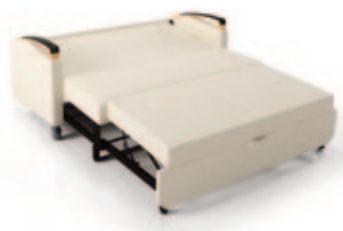

WEIGHT CAPACITIES

Jordan weight capacities are as follows:

Jordan One-Seat Lounge Sleepers is load rated to 350 lbs.

Jordan Two-Seat Lounge Sleepers is load rated to 525 lbs.

Jordan Lounge Sleepers Option Upcharges

	\$ List		\$ List
Moisture Barrier (per yard)	64	Two-Seat Lounge Sleepers - Removable Seat Cover	318
One-Seat Lounge Sleepers - Removable Seat Cover	205	Two-Seat Lounge Sleepers - Removable Back Cover	287
One-Seat Lounge Sleepers - Removeable Back Covers	198	Two-Seat Lounge Sleepers - Removable Ottoman Covers	295
One-Seat Lounge Sleepers - Removable Ottoman Covers	190	Solid Surface Arm Cap (per pair) - Gr A White	517
Combination Upholstery - dual fabrics	33	Solid Surface Arm Cap (per pair) - Gr A Color	527
Combination Upholstery -Three fabrics	64	Solid Surface Arm Cap (per pair) - Gr B	548
		Solid Surface Arm Cap (per pair) - Gr C	577

JORDAN | LOUNGE SLEEPERS FEATURES & OPTIONS



HIGH DURABILITY MECHANISM

This product features a heavy-duty mechanism, made with heavy gauge steel and minimal moving parts - its designed to last, and is backed by a 5-year warranty on the mechanism itself, in addition to the lifetime warranty on the rest of the product. If it does become damaged or degraded, the mechanism can be field-replaced.



COMFORTABLE SLEEP SURFACE

A new, enhanced sleep surface is 87" in length, providing exceptional range to stretch out in comfort, with supportive cushioning that is specifically designed for sleeping.



CHAISE/OTTOMAN POSITION

In addition to the sitting and sleep positions, this position allows the user to sit (or even sleep) in comfort with legs elevated and supported.



EASY OPEN AND CLOSE

The sleeper is extended easily to either position, using a pull handle that is neatly tucked away when not in use. The sleeper can be quickly closed by raising the back, and then lowering the ottoman cushion into the storage position. Instructions for operating the sleeper are located on the front of the ottoman cushion.



WALL SAVER DESIGN

The shape of the arm is designed to keep the back away from the wall (in a locked position), to prevent wear and damage to both the chairs and to the walls of the facility.



CASTERS

Enhanced accessibility of the casters allows the caregiver or visitor to easily lock and unlock them. The 3" casters are soft, with a premium lock function, which locks both the wheel rotation and the swivel rotation to rigidly hold the unit in position.



LEGS

Jordan Lounge Sleepers legs are available in Beech and Maple wood as well as Grey Urethane.



ARM STYLES

Jordan Lounge Sleepers feature 7 arm styles Upholstered Arm, Wood Arm, Full Urethane Arm, Wood Arm with Urethane Cap & Wood Arm with Solid Surface Cap, Upholstered Arm with Urethane Cap & Upholstered Arm with Solid Surface Cap. The optional arm caps and full urethane arm provide enhanced durability and protection for the arms. Urethane arm and arm cap are available in Black, Grey and Taupe colors. Solid Surface Arm caps are available in 8 colors shown on page 631. The arm cap is field replaceable if it becomes damaged or degraded.



UPHOLSTERED ARM with URETHANE ARM CAP



UPHOLSTERED ARM with SOLID SURFACE ARM CAP



WOOD ARM



FULL URETHANE ARM



URETHANE ARM CAP



WOOD ARM with SOLID SURFACE ARM CAP



CLEANING AND INFECTION CONTROL

Specifically designed to ease the cleaning and disinfection of the sleeper and the floor underneath them - in the first opening stage, open access is provided to the floor underneath so it can be cleaned without having to move the sleeper. Upholstery covers can be made removable, and individual components are automatically removable, to enable thorough cleaning and disinfection.

JORDAN | LOUNGE SLEEPERS OPTIONS & INSTRUCTIONS



REMOVABLE & REPLACEABLE UPHOLSTERY & COMPONENTS

Seat, back and ottoman upholstery covers can be specified as removable, so they can be removed for cleaning, or replacement. The mechanism, casters, front kickplate, arm panels and caps - as well as seat, back and ottoman cushions - are field-replaceable if damaged or degraded - so the life of this product can be extended indefinitely, and made to look good as new.

COMBINATION UPHOLSTERY OPTIONS

When combination upholstery is specified with fabric of the same grade or COM, an upcharge for dual fabrics is **\$33 list** per unit and **\$64 list** per unit for three fabrics will be applied. When graded in combination upholstery is selected, use the highest grade upholstery selected or to obtain a quote for blended grading contact Customer Service (please provide the fabrics specified and location of where each fabric is to be applied on the product).

MOISTURE BARRIER & CAL 133

California Technical Bulletin 133 is a flammability test for seating. Krug offers a compliance method, in combination with non-flammable upholstery covers, may enable products to meet certification requirements for this test. This process at the same time also provides the products with a Moisture Barrier - a treatment that helps to prevent the passage of liquids and moisture to inside of the upholstered components - thereby conferring sanitary and anti-infection benefits. So when CAL 133 is specified, the product also automatically has a Moisture Barrier, and when a Moisture Barrier is specified, the product also features the compliance method and low flammability features of CAL 133. The application of this up-charge and the compliance method does not mean that the specific configuration of product and upholstery cover are tested and officially certified as being CAL133 compliant. If the official certification is required, Krug will provide this (through an independent certified testing laboratory) at a charge of \$917 per item, plus the cost of the product to be tested. Lead time for certification testing is typically 4-8 weeks.

CONVERSION FROM CHAIR TO CHAISE TO SLEEPER (TO OPEN SLEEPER)

1. Chaise position - lock the casters and using the hand pull, pull the ottoman out. Lift pull handle up and out to fully extend the ottoman.
2. Sleep position - from chaise position, pull ottoman handle again away from chair to full extension. Lower the back manually forward into position.



CONVERSION FROM SLEEPER TO CHAISE TO CHAIR (TO CLOSE SLEEPER)

1. Chaise position - Lift the Sleeper back into it's upright position and push (using the ottoman kick plate) inward.
2. Chair position - Lower the ottoman into the tuck away position and continue to push the ottoman inward

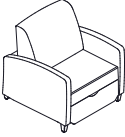

JORDAN | LOUNGE SLEEPERS

Description	Model	Species	COM		COL			FABRIC GRADES			LEATHER	
			1	2	3	4	5	6	7	8	9	
	One-Seat, upholstered arms and wood legs											
	JOR7-SL1UPH2	Beech	4480	4723	4970	5314	5706	6049	6441	6933	7424	
		Maple	4503	4748	4993	5336	5727	6074	6466	6957	7446	

ORDERING NOTE: Jordan Lounge Sleepers are available with Grey Urethane Legs, to order change the “2” to a “3”.

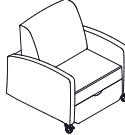
	One-Seat, upholstered arms and casters										
	JOR7-SL1UPH1	n/a	4545	4790	5036	5382	5773	6115	6510	7000	7490

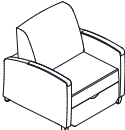
	One-Seat, upholstered arms with urethane cap and wood legs										
	JOR7-SL1UUR2	Beech	4578	4821	5068	5411	5805	6146	6539	7030	7523
		Maple	4601	4845	5092	5433	5826	6171	6564	7056	7545

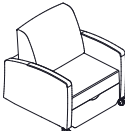
	One-Seat, upholstered arms with urethane cap and casters										
	JOR7-SL1UUR1	n/a	4643	4887	5134	5479	5872	6212	6607	7098	7589

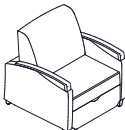
	One-Seat, Full Urethane Arm, and wood legs										
	JOR7-SL1FUR2	Beech	4628	4870	5116	5460	5853	6196	6587	7080	7572
		Maple	4658	4903	5149	5493	5885	6229	6623	7111	7605

ORDERING NOTE: Jordan Lounge Sleepers are available with Grey Urethane Legs, to order change the “2” to a “3”.

	One-Seat, Full Urethane Arm, with casters										
	JOR7-SL1FUR1	n/a	4692	4939	5185	5529	5920	6264	6657	7148	7639

Jordan Lounge Sleepers Option Upcharges	\$ List	\$ List
Moisture Barrier (per yard)	64	
One-Seat Lounge Sleepers - Removable Seat Cover	205	Solid Surface Arm Cap (per pair) - Gr A White
One-Seat Lounge Sleepers - Removeable Back Cover	198	Solid Surface Arm Cap (per pair) - Gr A Color
One-Seat Lounge Sleepers - Removable Ottoman Cover	190	Solid Surface Arm Cap (per pair) - Gr B
Combination Upholstery - dual fabrics	33	Solid Surface Arm Cap (per pair) - Gr C
Combination Upholstery -Three fabrics	64	

Note: For Solid Surface option replace UPH arm type with “USS” in the model number and add the upcharge above.

PRODUCT CODE KEY

Line	Series	Chair Type	Size	Arm Type	Base Type
JOR	7	SL	1	UPH	1
Jordan	Motion	Sleeper	One-Seat	Upholstered Arm	Casters
				UUR	2
				Upholstered Arm with Urethane Arm Cap	Wood Legs
				FUR	3
				Full Urethane Arm	Grey Urethane Legs
				USS	
				Upholstered Arm with Solid Surface Arm Cap	

JORDAN | LOUNGE SLEEPERS

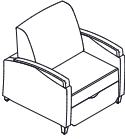
Description	Model	Species	COM		COL			FABRIC GRADES			LEATHER	
			1	2	3	4	5	6	7	8	9	
	One-Seat, wood arms and wood legs											
	JOR7-SL1WOD2	Beech	4732	4977	5220	5566	5959	6300	6692	7185	7679	
		Maple	4763	5008	5256	5598	5991	6334	6728	7218	7710	

ORDERING NOTE: Jordan Lounge Sleepers are available with Grey Urethane Legs, to order change the “2” to a “3”.

	One-Seat, wood arms and casters										
	JOR7-SL1WOD1	Beech	4796	5043	5289	5634	6028	6370	6763	7255	7743
		Maple	4817	5063	5308	5655	6046	6389	6781	7271	7763

	One-Seat, wood arms with urethane cap and wood legs										
	JOR7-SL1URE2	Beech	4921	5168	5412	5756	6147	6493	6885	7374	7867
		Maple	4959	5205	5450	5792	6185	6531	6924	7414	7906

ORDERING NOTE: Jordan Lounge Sleepers are available with Grey Urethane Legs, to order change the “2” to a “3”.

	One-Seat, wood arms with urethane cap and casters										
	JOR7-SL1URE1	Beech	4988	5233	5479	5823	6214	6558	6953	7442	7934
		Maple	5010	5258	5503	5847	6241	6583	6977	7466	7956

Jordan Lounge Sleepers Option Upcharges		\$ List	\$ List
Moisture Barrier (per yard)		64	
One-Seat Lounge Sleepers - Removable Seat Cover		205	Solid Surface Arm Cap (per pair) - Gr A White 517
One-Seat Lounge Sleepers - Removeable Back Cover		198	Solid Surface Arm Cap (per pair) - Gr A Color 527
One-Seat Lounge Sleepers - Removable Ottoman Cover		190	Solid Surface Arm Cap (per pair) - Gr B 548
Combination Upholstery - dual fabrics		33	Solid Surface Arm Cap (per pair) - Gr C 577
Combination Upholstery -Three fabrics		64	

Note: For Solid Surface option replace UPH arm type with “USS” in the model number and add the upcharge above.

PRODUCT CODE KEY

Line	Series	Chair Type	Size	Arm Type	Base Type
JOR	7	SL	1	WOD	1
Jordan	Motion	Sleeper	One-Seat	Wood Arm	Casters
				URE	2
				Wood Arm with Urethane Arm Cap	Wood Legs
				SSC	3
				Wood Arm with Solid Surface Arm Cap	Grey Urethane Legs

JORDAN | LOUNGE SLEEPERS

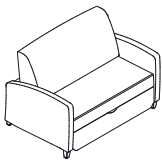
Description	Model	Species	COM		COL		FABRIC GRADES			LEATHER	
			1	2	3	4	5	6	7	8	9
	Two-Seat, upholstered arms and wood legs										
	JOR7-SL2UPH2	Beech	5612	5914	6214	6640	7124	7547	8031	8634	9238
		Maple	5637	5940	6243	6664	7149	7572	8056	8661	9265

ORDERING NOTE: Jordan Lounge Sleepers are available with Grey Urethane Legs, to order change the “2” to a “3”.

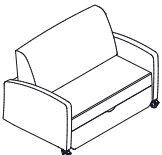
	Two-Seat, upholstered arms and casters										
	JOR7-SL2UPH1	n/a	5681	5980	6285	6708	7190	7613	8097	8700	9307

	Two-Seat, upholstered arms urethane cap and wood legs										
	JOR7-SL2UUR2	Beech	5710	6012	6313	6737	7221	7645	8129	8732	9336
		Maple	5736	6038	6340	6762	7247	7670	8154	8760	9362

ORDERING NOTE: Jordan Lounge Sleepers are available with Grey Urethane Legs, to order change the “2” to a “3”.

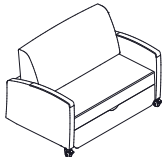
	Two-Seat, upholstered arms with urethane cap and casters										
	JOR7-SL2UUR1	n/a	5780	6078	6382	6806	7288	7711	8195	8799	9404

	Two-Seat, Full Urethane Arm, and wood legs										
	JOR7-SL2FUR2	Beech	5760	6061	6363	6787	7270	7696	8178	8782	9385
		Maple	5791	6093	6395	6820	7303	7728	8209	8813	9417

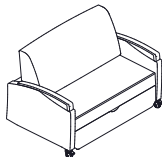
	Two-Seat, Full Urethane Arm, and casters										
	JOR7-SL2FUR1	n/a	5828	6129	6432	6855	7338	7761	8247	8847	9454

Jordan Lounge Sleepers Option Upcharges	\$ List		\$ List
Moisture Barrier (per yard)	64	Solid Surface Arm Cap (per pair) - Gr A White	517
Two-Seat Lounge Sleepers - Removable Seat Covers	318	Solid Surface Arm Cap (per pair) - Gr A Color	527
Two-Seat Lounge Sleepers - Removeable Back Covers	287	Solid Surface Arm Cap (per pair) - Gr B	548
Two-Seat Lounge Sleepers - Removable Ottoman Covers	295	Solid Surface Arm Cap (per pair) - Gr C	577
Combination Upholstery - dual fabrics	33		
Combination Upholstery -Three fabrics	64		

Note: For Solid Surface option replace UPH arm type with “USS” in the model number and add the upcharge above.

PRODUCT CODE KEY

Line	Series	Chair Type	Size	Arm Type	Base Type
JOR	7	SL	2	UPH	1
Jordan	Motion	Sleeper	Two-Seat	Upholstered Arm	Casters
				UUR	2
				Upholstered Arm with Urethane Arm Cap	Wood Legs
				FUR	3
				Full Urethane Arm	Grey Urethane Legs
				USS	
				Upholstered Arm with Solid Surface Arm Cap	

JORDAN | LOUNGE SLEEPERS

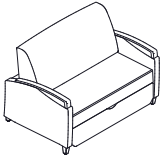
Description	Model	Species	COM		COL		FABRIC GRADES			LEATHER	
			1	2	3	4	5	6	7	8	9
	Two-Seat, wood arms and wood legs										
	JOR7-SL2WOD2	Beech	5866	6167	6469	6892	7375	7799	8283	8887	9490
		Maple	5896	6199	6501	6925	7408	7833	8313	8918	9521

ORDERING NOTE: Jordan Lounge Sleepers are available with Grey Urethane Legs, to order change the “2” to a “3”.

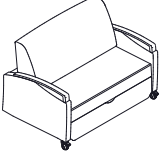
	Two-Seat, wood arms and casters										
	JOR7-SL2WOD1	Beech	5933	6233	6537	6960	7442	7865	8347	8953	9560
		Maple	5954	6254	6556	6980	7463	7884	8368	8972	9578

	Two-Seat, wood arms with urethane cap and wood legs										
	JOR7-SL2URE2	Beech	6054	6358	6659	7081	7567	7988	8472	9075	9683
		Maple	6091	6394	6696	7122	7605	8028	8511	9116	9719

ORDERING NOTE: Jordan Lounge Sleepers are available with Grey Urethane Legs, to order change the “2” to a “3”.

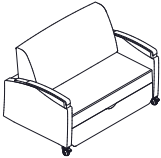
	Two-Seat, wood arms with urethane cap and casters										
	JOR7-SL2URE1	Beech	6122	6422	6725	7149	7632	8056	8540	9144	9749
		Maple	6144	6445	6749	7173	7655	8077	8561	9165	9771

Jordan Lounge Sleepers Option Upcharges	\$ List	\$ List
Moisture Barrier (per yard)	64	Solid Surface Arm Cap (per pair) - Gr A White
Two-Seat Lounge Sleepers - Removable Seat Covers	318	Solid Surface Arm Cap (per pair) - Gr A Color
Two-Seat Lounge Sleepers - Removeable Back Covers	287	Solid Surface Arm Cap (per pair) - Gr B
Two-Seat Lounge Sleepers - Removable Ottoman Covers	295	Solid Surface Arm Cap (per pair) - Gr C
Combination Upholstery - dual fabrics	33	
Combination Upholstery -Three fabrics	64	

Note: For Solid Surface option replace UPH arm type with “USS” in the model number and add the upcharge above.



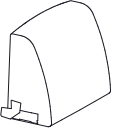
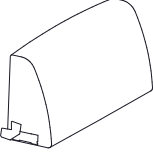
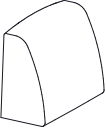
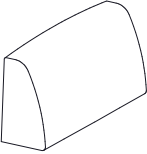
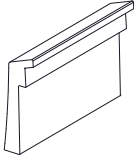
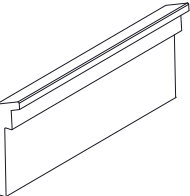

PRODUCT CODE KEY

Line	Series	Chair Type	Size	Arm Type	Base Type
JOR	7	SL	2	WOD	1
Jordan	Motion	Sleeper	Two-Seat	Wood Arm	Casters
				URE	2
				Wood Arm with Urethane Arm Cap	Wood Legs
				SSC	3
				Wood Arm with Solid Surface Arm Cap	Grey Urethane Legs

JORDAN | LOUNGE SLEEPERS REPLACEMENT COMPONENTS

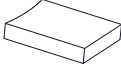
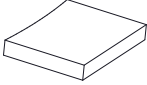
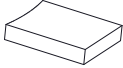
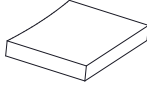
Description	Model	COM		COL			FABRIC GRADES			LEATHER			Yardage	Weight	Cubes
		1	2	3	4	5	6	7	8	9					
	One-Seat Back JOR7-SL1RB	710	763	816	892	978	1054	1139	1245	1355	1.6	18	5.6		
	Two-Seat Back JOR7-SL2RB	960	1034	1109	1212	1331	1434	1554	1698	1845	2.2	30.1	9.3		
	One-Seat Back Cover JOR7-SL1RBC	244	299	352	427	513	589	673	781	889	1.6	2.6	1		
	Two-Seat Back Cover JOR7-SL2RBC	427	497	573	676	795	822	1017	1165	1312	2.2	3.5	1		
	One-Seat Outback JOR7-SL1R0B	344	366	390	424	460	493	532	580	626	.7	8	2.5		
	Two-Seat Outback JOR7-SL2R0B	453	477	500	533	569	602	640	688	733	.7	14	4		

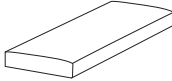
JORDAN | LOUNGE SLEEPERS REPLACEMENT PARTS

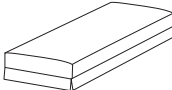
Description	Model	COM		COL			FABRIC GRADES			LEATHER			Yardage	Weight	Cubes
		1	2	3	4	5	6	7	8	9					
	One-Seat Seat JOR7-SL1RS	622	672	721	786	868	934	1014	1109	1206	1.4	18.5	4.1		
	Two-Seat Seat JOR7-SL2RS	960	1034	1109	1212	1331	1434	1554	1698	1845	1.8	31.4	6.8		
	One-Seat Seat Cover JOR7-SL1RSC	233	280	331	399	477	543	621	720	816	1.4	2.7	1		
	Two-Seat Seat Cover JOR7-SL2RSC	303	366	428	514	614	701	803	924	1048	1.8	3.6	1		
	One-Seat Ottoman JOR7-SL1RO	369	404	435	485	531	584	637	705	771	1	9.6	3		
	Two-Seat Ottoman JOR7-SL2RO	562	620	676	757	848	929	1018	1135	1246	1.7	17	5.3		
	One-Seat Ottoman Cover JOR7-SL1ROC	191	226	259	305	359	406	458	527	595	1	2.4	1		
	Two-Seat Ottoman Cover JOR7-SL2ROC	283	340	399	479	568	648	740	853	967	1.7	3.4	1		

JORDAN | LOUNGE SLEEPERS REPLACEMENT COMPONENTS

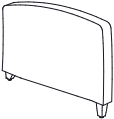
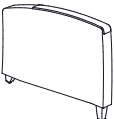
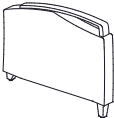
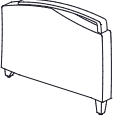
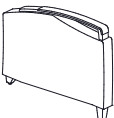
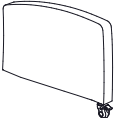
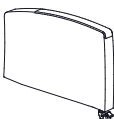
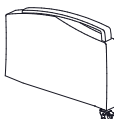
Description	Model	Species	COM		COL	FABRIC GRADES			LEATHER			Yardage	Weight	Cubes
			1	2	3	4	5	6	7	8	9			
	Upholstered Arm with legs													
	JOR7-SLRUPH2	Beech	706	805	901	1036	1193	1330	1483	1677	1872	2.9	32.8	4.9
		Maple	711	808	906	1042	1197	1333	1487	1683	1879			
	Upholstered Arm with Urethane Cap with legs													
	JOR7-SLRUUR2	Beech	804	904	1000	1134	1291	1428	1581	1775	1970	2.9	32.8	4.9
		Maple	809	907	1003	1140	1294	1431	1585	1780	1977			
	Full Urethane Arm, with legs													
	JOR7-SLRFUR2	Beech	866	961	1061	1197	1351	1487	1643	1837	2033	2.9	32.8	4.9
		Maple	870	967	1064	1201	1356	1493	1646	1841	2037			
	Wood Arm with legs													
	JOR7-SLRWOD2	Beech	890	988	1087	1223	1377	1513	1668	1862	2059	2.9	32.8	4.9
		Maple	905	1002	1098	1236	1390	1528	1683	1878	2072			
	Wood Arm with Urethane Cap with legs													
	JOR7-SLRFUR2	Beech	990	1088	1185	1319	1478	1613	1769	1962	2160	2.9	32.8	4.9
		Maple	1003	1098	1198	1333	1487	1624	1779	1976	2169			
ORDERING NOTE: Jordan Lounge Sleepers are available with Grey Urethane Legs, to order change the “2” to a “3”.														
	Upholstered Arm with casters													
	JOR7-SLRUPH1		720	816	914	1052	1205	1342	1497	1691	1886	2.9	33.4	4.9
	Upholstered Arm with Urethane Cap with casters													
	JOR7-SLRUUR1		819	914	1012	1150	1304	1441	1596	1790	1985	2.9	33.4	4.9
	Full Urethane Arm, with casters													
	JOR7-SLRFUR1		886	984	1083	1216	1373	1509	1664	1858	2055	2.9	33.4	4.9

ORDERING NOTES:

Please note when ordering Jordan Sleeper replacement arms, you must specify either a right or left arm.

JORDAN | LOUNGE SLEEPERS REPLACEMENT PARTS

Description	Model	Species	COM		COL				FABRIC GRADES			LEATHER			Yardage	Weight	Cubes
			1	2	3	4	5	6	7	8	9						

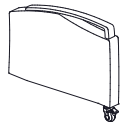

Wood Arm with casters																
JOR7-SLRWOD1	Beech	901	999	1095	1231	1387	1526	1678	1872	2069				2.9	33.4	4.9
	Maple	909	1006	1106	1240	1394	1533	1688	1881	2077						



Wood Arm with Urethane Cap with casters																
JOR7-SLRURE1	Beech	1012		1109	1206	1342	1497	1634	1789	1984				21772.9	33.4	4.9
	Maple	10181117	1213	1349	1505	1642	1797	1990	2188							

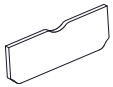

One-Seat Kickplate																
JOR7-SL1RUP		212	226	239	258	278	298	319	345	372				.4	4.1	0.6

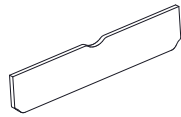

Two-Seat Kickplate																
JOR7-SL2RUP		271	284	299	318	338	358	380	406	433				.4	7.7	1.1

Description	Model	Price												Weight	Cubes
-------------	-------	-------	--	--	--	--	--	--	--	--	--	--	--	--------	-------

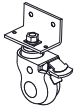

Locking Rubber Wheel Caster																
JOR7-SLRCAS		70												3.4	0.2	



Urethane Arm Cap																
JOR7-SLRURE		120												3.7	0.3	



Full Urethane Arm																
JOR7-SRRFUR		182												12	1	

BEHAVIORAL HEALTH

420 Solis
436 Faeron
472 Zola
479 Leyton
489 Tate
493 Karma
497 Chit Chat
504 Juno

SOLIS BEHAVIORAL HEALTH | ENVIRONMENTAL SUMMARY

LEED CI CREDITS



MATERIAL CONTENT:

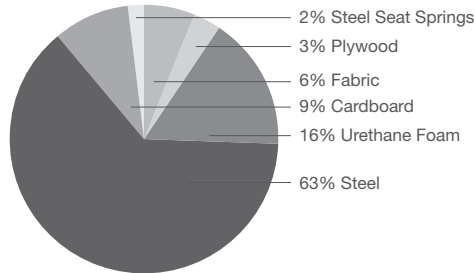

PRE-CONSUMER
RECYCLED CONTENT = 16%

POST-CONSUMER
RECYCLED CONTENT = 22%

CONTRIBUTES TO

CREDIT	CONTRIBUTES TO	POINTS
CREDIT 2.1 - 2.2	Construction Waste Management	1-2 point(s)
CREDIT 3.3	Resource Reuse	1 point
CREDIT 4.1	Recycled Content	1 point
CREDIT 4.2	Recycled Content	1 point
CREDIT 4.5	Low Emitting Materials, (PLEASE ENQUIRE) Composite Wood & Laminate Adhesives	1 point
CREDIT 5.1	Regional Materials*	1 point
CREDIT 7	Certified Wood (PLEASE ENQUIRE)	1 point

* This credit is only applicable if in total 20% of the combined value of the procurement of construction materials and in the furniture are manufactured within a radius of 500 miles. This credit will apply if the installation of the finished product occurs within 500 miles of Toronto, Ontario.

level® CERTIFICATION, AIR EMISSIONS AND FSC® CERTIFICATION



level® CERTIFICATION

BIFMA's e3 Furniture Sustainability Standard is a voluntary, multi-attribute standard that measures the degree of sustainability of furniture. This standard evaluates product and company environmental attributes and compliance systems in a wide range of elements which include Materials, Energy & Atmosphere, Human & Ecosystem Health and Social Responsibility. Solis products have earned level®, BIFMA's sustainability certification program for furniture, certification through third-party verification against the e3 standard.

AIR-EMISSIONS

All Solis products are supplied with air-emissions certified. Contact customer service for information.



FSC®

In 2005, Krug received Forest Stewardship Council® (FSC®) Chain-of-Custody certification for our manufacturing facilities. The FSC® Chain-of-Custody tracks certified wood from seedling to final sale. It verifies that the material for our FSC® certified products only come from well-managed, FSC®-certified forests and other controlled sources. FSC® is dedicated to the promotion of responsible forest management worldwide helping to take care of forests for future generations. Solis and other Krug products can be specified with FSC® Certification. Contact customer service for further information, pricing and lead times.



Architects, designers, and building professionals can specify FSC®-certified products in order to achieve a point from the U.S. Green Building Council's Leadership in Energy and Environmental Design (LEED) Rating System.

SOLIS BEHAVIORAL HEALTH | FEATURES



CLEAN OUT

All Solis seating models have a built-in clean out feature: a space at the back of the seat that allows dirt, debris and liquids to fall to the floor for easy clean up and maintenance - designed so that it does not detract from the comfort or appearance of the product.



STEEL SEAT FRAME

The structural seat frame is made from welded steel with a powder-coated finish that allows Solis to well exceed ANSI/BIFMA standards.



FLEX BACK

The ergonomically-designed back has a slight flexing action, which significantly enhances comfort.



WALL SAVER

The angle of the back and the rear legs are designed to keep the back away from the wall, to prevent wear and damage to both the chairs and to the walls of the facility. Patient and Guest chairs with mesh backs are excluded as they do not have the wall saver feature.

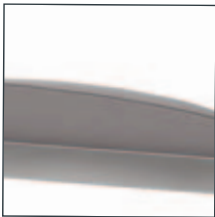

HIGH DENSITY FOAM

Solis features dual density foam that is soft on the outside for comfort, dense on the inside for high durability. The seat and back foam features a compound curvature that supports healthy sitting postures, while also designed to ease ingress and egress.



SECURED WOODEN ARM

Solis Wood Arm caps are fastened to the side frames with tamper resistant security screws. Wood arms are available in either beech or maple hardwood and in 22 Krug standard finishes. Maple arm caps are available for an up-charge of **\$77 list** per arm using beech pricing.



URETHANE ARM

Solis secured urethane arms are durable, comfortable, and long lasting. Urethane arms are available in three colors options; Black, Grey and Taupe.

TAMPER RESISTANT HARDWARE

All screws used on the Solis Behavioral Health units have been replaced with tamper resistant security screws.

GANGING

All Solis Freestanding chairs can be ganged using a ganging bracket. The powder-coated metal plate is fastened to the underside of the steel side rails using the pre-existing holes in the frame.

SECURED GLIDES

Solis Behavioral Health chairs have their glides secured in place to prevent their removal and damage.

BOTTOM STAPLE COVER/SHIELD

Solis Behavioral Health chairs come standard with a black painted plywood cover underneath the seat. This cover is designed to prevent access to the upholstery staples of the seat and to prevent the hiding of objects underneath the seat. The cover is also designed to allow for regular ganging hardware and proper seat ventilation. The cover is secured to the unit with tamper resistant security screws.

BACK STAPLE COVER STRIP

The Solis Behavioral Health back upholstery has been altered to allow a staple cover strip to be attached; this will prevent access to the upholstery staples. The cover strip is nylon coated galvanized steel with vinyl coated ends to prevent any sharp edges. The back cover strip is fastened to the unit with tamper resistant security screws.

TUBULAR STEEL CHAIR FRAME

The overall aesthetic frame of the chair is built from structural steel tubing, both elliptical and rectangular for exceptional strength and appealing design. The frame is electro welded and polished joints for ease of cleaning and a one piece look. Available in eight powder-coated finishes. Silver Metallic is offered as Krug's standard finish. For all metal finishes other than Silver Metallic, there is a minimum quantity of 30 units per color and are available for an upcharge of **\$64 list** per seat/table. Microban anti-microbial finish is standard, with no upcharge, when frame finishes other than Silver Metallic is ordered. Solis Silver Metallic frames are available with an anti-microbial finish for an upcharge of **\$64 list** per chair or table. Upcharges for quantities less than 30 units per color, per order can be obtained through Customer Service.

FINISH DURABILITY

The Krug Enduraguard finish, a proprietary catalyzed varnish formulation, has been repeatedly shown, through independent laboratory testing, to be the industry leader in durability and abrasion resistance. The Krug finish looks better longer than competitors, and is uniquely suited to the demands of healthcare environments.

LATEX-FREE

Krug products are made with latex-free materials, to prevent the allergic reaction that latex causes in some people.

WEIGHT CAPACITIES

Weight capacities are as follows:
Guest & Patient Chairs (21" & 24") - **500 lbs**
Plus Chairs (30" & 44") - **750 lbs**



SLED BASE

The Solis side frames legs have the option to be tied front to back with a steel rail, this will strengthen the frames and eliminate the option of having legs.



KINETIC BACK OPTION

This optional feature provides the chair back with a very pleasant and comfortable rocking motion, which can significantly enhance long-term sitting for patients and guests alike. The durable spring-loaded mechanism provides a range of motion of 20 degrees, and can be field-installed or replaced. It's available on any Solis chair back - Guest, Patient and Multiple Seating - with the exception of the 30" and 44" sizes.



CLOSED ARM

Solis closed arm has an upholstered arm panel built into the side frame. It is between the middle rail on the side frame and the top of the arm.



FULLY CLOSED ARM (SLEIGH BASE ONLY)

The fully closed arm includes the regular closed arm, but also adds a second upholstered arm panel between the middle rail on the side frame and the sleigh base bottom. This feature is only available when the sleigh base option is selected.

FLOOR ANCHOR BRACKETS (SLEIGH BASE ONLY)

Floor mounting brackets are supplied to be secured to the bottom of the Solis sleigh base with tamper resistant security screws. The hardware to attach the brackets to the floor is not provided by Krug.

WEIGHTED SHIELD

In place of the Bottom Staple Cover, a weighted black coated steel version is also available. This steel shield is designed to add enough weight for the product to be a minimum of 80 lbs. The shield is also designed to allow standard ganging hardware as well as proper seat ventilation. This is all achieved while also covering/preventing all access to the upholstery staples under the seat. The Weighted Shield is fastened with tamper-resistant security screws.

COMBINATION UPHOLSTERY OPTIONS

When combination upholstery is specified with fabric of the same grade or COM, an upcharge for dual fabrics is **\$33 list** per unit and **\$64 list** per unit for three fabrics will be applied. When graded in combination upholstery is selected, use the highest grade upholstery selected or to obtain a quote for blended grading contact Customer Service (please provide the fabrics specified and location of where each fabric is to be applied on the product).

ANTI-MICROBIAL FINISH

Solis Silver Metallic frames are available with an anti-microbial finish for an upcharge of **\$64 list** per chair or table.

CAL133 & MOISTURE BARRIER

California Technical Bulletin 133 is a flammability test for seating. Krug offers a compliance method, in combination with non-flammable upholstery covers, may enable products to meet certification requirements for this test. This process at the same time also provides the products with a Moisture Barrier - a treatment that helps to prevent the passage of liquids and moisture to inside of the upholstered components - thereby conferring sanitary and anti-infection benefits. So when CAL 133 is specified, the product also automatically has a Moisture Barrier, and when a Moisture Barrier is specified, the product also features the compliance method and low flammability features of CAL 133.

The application of this up-charge and the compliance method does not mean that the specific configuration of product and upholstery cover are tested and officially certified as being CAL133 compliant. If the official certification is required, Krug will provide this (through an independent certified testing laboratory) at a charge of \$917 per item, plus the cost of the product to be tested. Lead time for certification testing is typically 4-8 weeks. Krug assumes no responsibility for the testing of our products in combination with upholstery covers, or for the results of any testing conducted. Some specific configurations of products and upholstery have already been tested. Please contact Customer Service for additional information. CAL 133 and Moisture Barrier is available for **\$64 list** per yard.

REMOVABLE COVERS & REPLACEMENT COMPONENTS

Optional Removeable seat and back covers can be quickly installed on Solis products that were originally ordered with the Removeable cover option. Replacement seat and back covers can also be installed on Solis products that were not originally ordered with the Removeable cover option, with some simple staple removal on the original seats and backs. Complete Mesh backs can be ordered and field replaced.

NO SPRING SEATS

The springs in the seat have been removed and replaced with a solid plywood seat pan, Additional foam has also been added in place of the springs for comfort.

TAMPER-RESISTANT SPLASHGUARD

All Solis seating models are available with a coated steel moisture barrier that covers and enclosed the underside of the seat (while still allowing air transfer and ventilation in and out of the seat cushion). The Splashguard replaces the Bottom Staple Cover on the underside of the seat. It is designed to still allowing ganging and has folded metal edges to prevent any sharp edges. The splashguard is fastened with tamper resistant security screws.

SOLIS BEHAVIORAL HEALTH | GUEST -DIMENSIONS & COM REQUIREMENTS

DIMENSIONS

	Overall Width	Overall Depth	Overall Height	Seat Height	Height of Arms from Floor	Width Between Arms	Seat Depth	Base Shipping Weight	Cubes
21" Seat	25	28	34.5	18.5	26	20	20	51	16
24" Seat	28	28	34.5	18.5	26	23	20	55	18
30" Seat	34	28	34.5	18.5	26	29	20	60	22
44" Seat	48	28	34.5	18.5	26	43	20	74	31

COM - YARDAGE REQUIREMENTS





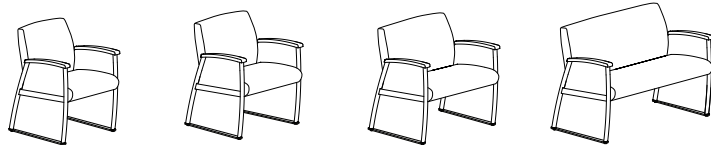
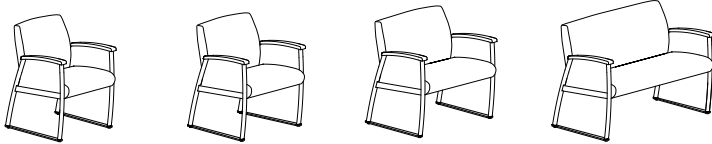

	Yardage Seat & Back	Yardage Seat	Yardage Back	Yardage Closed Upper Arm Panel	Yardage Fully Closed Arm Panel (Upper & Lower)
21" & 24" - One Chair	1.6	0.9	1.6	0.8	1.6
21" & 24" - Two Chairs	3.1	1.3	1.6	1.2	2.4
21" & 24" - Three Chairs	4.7	2.1	3.7	1.6	3.2
30" Plus - One Chair	2.5	0.9	1.6	1.6	3.2
30" Plus - Two Chairs	5	1.8	3.2	1.2	2.4
30" Plus - Three Chairs	7.5	2.7	4.8	1.6	3.2
44" Plus - One Chair	2.5	0.9	2.3	0.8	1.6
44" Plus - Two Chairs	5	1.8	3.9	1.2	2.4
44" Plus - Three Chairs	7.5	2.7	5.5	1.6	3.2

Closed Arm Panels (per chair) - please add the following up charges for closed arm panels.

Fabric Grades	(COM)		(COL)				Leather			COM
	1	2	3	4	5	6	7	8	9	
Closed Arm Panel (1 arm)	208	224	238	267	294	321	350	379	435	0.4
Closed Arm Panels (2 arms)	418	448	477	531	588	643	699	757	869	0.8
Fully Closed Arm (1 arm)	339	365	391	436	483	529	576	627	707	1.5
Fully Closed Arm (2 arms)	677	730	782	872	967	1054	1151	1253	1412	3



SOLIS BEHAVIORAL HEALTH | GUEST

DESCRIPTION/MODEL	COM		COL	FABRIC GRADES			LEATHER				
	1	2	3	4	5	6	7	8	9		
	21" Open Arm, Mesh Back										
	SOL2-GBHM21OPU	Urethane	1119	1151	1181	1245	1309	1372	1434	1499	1596
	SOL2-GBHM21OPW	Beech	1240	1271	1304	1367	1429	1492	1556	1619	1716
	21" Open Arm, Upholstered Back										
	SOL2-GBHU21OPU	Urethane	1169	1220	1271	1373	1477	1578	1678	1779	1985
	SOL2-GBHU21OPW	Beech	1289	1340	1391	1493	1594	1697	1801	1899	2106
	24" Open Arm, Mesh Back										
	SOL2-GBHM24OPU	Urethane	1161	1192	1223	1285	1349	1414	1478	1538	1638
	SOL2-GBHM24OPW	Beech	1281	1311	1342	1405	1468	1534	1596	1661	1756
	24" Open Arm, Upholstered Back										
	SOL2-GBHU24OPU	Urethane	1209	1262	1312	1415	1515	1619	1719	1821	2028
	SOL2-GBHU24OPW	Beech	1331	1381	1433	1535	1638	1818	1840	1942	2146
	30" Open Arm, Upholstered Back										
	SOL2-GBHU30OPU	Urethane	1443	1522	1604	1761	1922	2083	2239	2401	2718
	SOL2-GBHU30OPW	Beech	1563	1642	1724	1882	2042	2201	2359	2522	2839
	44" Open Arm, Upholstered Back										
	SOL2-GBHUH44OPU	Urethane	1606	1686	1765	1923	2085	2241	2405	2562	2880
	SOL2-GBHUH44OPW	Beech	1727	1806	1884	2043	2205	2361	2524	2682	2999

ORDERING NOTES: Solis Behavioral Health guest chairs are standard with; secured glides, secured Arms, Bottom Staple shield/Cover, Non-Accessible Staples (Bottom of back) and Tamper- Resistant Hardware.

Solis Guest Option Upcharges	\$ List	\$ List
CAL 133 & Moisture Barrier (per yard)	64	30" & 44" - Removable Back Cover (per back)
Guest chair - Removable Seat Cover	80	Kinetic Back option
21" & 24" - Removeable Back Cover	58	Maple Arm upgrade per arm (add to beech price)
Combination Upholstery - dual fabrics	33	Non-Marring Glide
Combination Upholstery -Three fabrics	64	

Solis Behavioral Health Option Upcharges	\$ List	\$ List
Plywood Seat / No Springs	121	Weight Shield (to min 80lbs) - 21" Uph.
Sled Base	265	Weight Shield (to min 80lbs) - 21" Mesh
Anchor to Floor (Sleigh base only)	359	Weight Shield (to min 80lbs) - 24" Uph.
21" Tamper- Resistant Splashguard	157	Weight Shield (to min 80lbs) - 24" Mesh
24" Tamper- Resistant Splashguard	165	Weight Shield (to min 80lbs) - 30" Uph.
30" Tamper- Resistant Splashguard	340	Weight Shield (to min 80lbs) - 44" Uph.
44" Tamper- Resistant Splashguard	363	

Solis Behavioral Health guest chairs have the option of Closed or Fully Closed arms, change the last 3 letters of the model number to the required arm type from the Product Code Key below and add the upcharge on page 423.

PRODUCT CODE KEY

Line	Series	Chair Type	Back Type	Size	Arm Type
SOL	2	GBH	U	21	OPU
Solis	Chair	Guest Seating	Upholstered Back		Open Arm - Urethane
		PBH	M	24	OPW
		Patient Seating	Mesh Back 21" & 24" Only		Open Arm - Wood
				30	CLW
					Closed Arm - Wood
				44	CLU
					Closed Arm - Urethane
					FCW
					Fully Closed Arm - Wood
					FCU
					Fully Closed Arm - Urethane

SOLIS BEHAVIORAL HEALTH | PATIENT -DIMENSIONS & COM REQUIREMENTS

DIMENSIONS

	Overall Width	Overall Depth	Overall Height	Seat Height	Height of Arms from Floor	Width Between Arms	Seat Depth	Base Shipping Weight	Cubes
UPHOLSTERED BACK									
21" Seat	25	28	43.75	18.5	26	20	20	54	21
24" Seat	28	28	43.75	18.5	26	23	20	58	23
30" Seat	34	28	43.75	18.5	26	29	20	64	28

COM - YARDAGE REQUIREMENTS

	Yardage Seat & Back	Yardage Seat	Yardage Back	Yardage-Closed Upper Arm Panel	Yardage-Fully Closed Arm Panel (Upper & Lower)
21" & 24" - One Chair	2.1	0.9	2	0.8	1.6
21" & 24" - Two Chairs	4	1.3	3.4	1.2	2.4
21" & 24" - Three Chairs	6.1	2.1	5.4	1.6	3.2
30" Plus - One Chair	3.1	0.9	2.2	0.8	1.6
30" Plus - Two Chairs	6.2	1.8	4.4	1.2	2.4
30" Plus - Three Chairs	9.3	2.7	6.6	1.6	3.2

ORDERING NOTES:

Complete Mesh backs (21" & 24") can be ordered and field replaced.

The standard **Solis Frame Color** is Silver Metallic. Additional frame colors are available for an upcharge of **\$64 list** per arm frame pair, please see page 24 for color selection and required ordering quantities. Silver metallic frames are available with an anti-microbial finish for an upcharge of **\$64 list** per arm frame pair or table.

Closed Arm Panels (per chair) - please add the following up charges for closed arm panels.



Fabric Grades	(COM)		(COL)					Leather		COM
	1	2	3	4	5	6	7	8	9	
Closed Arm Panel (1 arm)	208	224	238	267	294	321	350	379	435	0.4
Closed Arm Panels (2 arms)	418	448	477	531	588	643	699	757	869	0.8

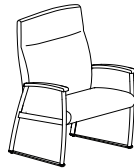

Fully Closed Arm (1 arm)	339	365	391	436	483	529	576	627	707	1.5
Fully Closed Arm (2 arms)	677	730	782	872	967	1054	1151	1253	1412	3



SOLIS BEHAVIORAL HEALTH | PATIENT

DESCRIPTION/MODEL	COM		COL		FABRIC GRADES			LEATHER			
	1	2	3	4	5	6	7	8	9		
	21" Open Arm, Mesh Back										
	SOL2-PBHM21OPU	Urethane	1164	1241	1272	1335	1398	1461	1526	1589	1688
	SOL2-PBHM21OPW	Beech	1331	1360	1393	1456	1519	1583	1644	1709	1808
	21" Open Arm, Upholstered Back										
	24" Open Arm, Mesh Back										
	SOL2-PBHM24OPU	Urethane	1247	1281	1311	1374	1439	1503	1565	1629	1727
	SOL2-PBHM24OPW	Beech	1370	1401	1431	1494	1559	1622	1686	1748	1845
	24" Open Arm, Upholstered Back										
	30" Open Arm, Upholstered Back										
	SOL2-PBHU30OPU	Urethane	1640	1741	1837	2033	2234	2431	2629	2824	3220
	SOL2-PBHU30OPW	Beech	1760	1860	1957	2155	2354	2552	2746	2946	3342

Solis Guest Option Upcharges	\$ List	\$ List	
CAL 133 & Moisture Barrier (per yard)	64	30" - Removable Back Cover (per back)	80
Guest chair - Removable Seat Cover	80	Kinetic Back option	120
21" & 24" - Removeable Back Cover	58	Maple Arm upgrade per arm (add to beech price)	80
Combination Upholstery - dual fabrics	33	Non-Marring Glide	37
Combination Upholstery -Three fabrics	64		

Solis Behavioral Health Option Upcharges	\$ List	\$ List	
Plywood Seat / No Springs	121	Weight Shield (to min 80lbs) - 21" Uph.	408
Sled Base	265	Weight Shield (to min 80lbs) - 21" Mesh	486
Anchor to Floor (Sleigh base only)	359	Weight Shield (to min 80lbs) - 24" Uph.	337
21" Tamper- Resistant Splashguard	157	Weight Shield (to min 80lbs) - 24" Mesh	412
24" Tamper- Resistant Splashguard	165	Weight Shield (to min 80lbs) - 30" Uph.	180
30" Tamper- Resistant Splashguard	340		

Solis Behavioral Health guest chairs have the option of Closed or Fully Closed arms, change the last 3 letters of the model number to the required arm type from the Product Code Key below and add the upcharge on page 425.

PRODUCT CODE KEY

Line	Series	Chair Type	Back Type	Size	Arm Type
SOL	2	GBH	U	21	OPU
Solis	Chair	Guest Seating	Upholstered Back		Open Arm - Urethane
		PBH	M	24	OPW
		Patient Seating	Mesh Back 21" & 24" Only		Open Arm - Wood
				30	CLW
					Closed Arm - Wood
				44	CLU
					Closed Arm - Urethane
					FCW
					Fully Closed Arm - Wood
					FCU
					Fully Closed Arm - Urethane

SOLIS BEHAVIORAL HEALTH | MULTIPLE SEATING - GUEST

DIMENSIONS & COM. REQUIREMENTS - START UNITS

	Overall Width	Overall Depth	Overall Height	Seat Height	Height of Arms from Floor	Width Between Arms	Seat Depth	Shipping Weight	Cube	COM. Seat & Back Yardage	COM. Fabric Seat Yardage	COM. Fabric Back Yardage	COM. Fabric Closed Arm Panel (1 Arm) Yardage	COM. Fabric Closed Arm Panel (2 Arms) Yardage
MESH BACK														
SGM21	25	28	34.5	18.5	26	20	20	41	16	-	0.9	-	0.4	0.8
SGM24	28	28	34.5	18.5	26	23	20	44	18	-	0.9	-	0.4	0.8
UPHOLSTERED BACK														
SGU21	25	28	34.5	18.5	26	20	20	43	16	1.6	0.9	1.6	0.4	0.8
SGU24	28	28	34.5	18.5	26	23	20	47	18	1.6	0.9	1.6	0.4	0.8
SGU30	34	28	34.5	18.5	26	29	20	52	22	2.5	0.9	2.5	0.4	0.8
SGU44	48	28	34.5	18.5	26	43	20	66	31	2.5	0.9	2.5	0.4	0.8

DIMENSIONS & COM. REQUIREMENTS - CENTER UNITS

	Overall Width	Overall Depth	Overall Height	Seat Height	Height of Arms from Floor	Width Between Arms	Seat Depth	Shipping Weight	Cube	COM. Seat & Back Yardage	COM. Fabric Seat Yardage	COM. Fabric Back Yardage	COM. Fabric Closed Arm Panel Yardage
MESH BACK													
CGM21	23	28	34.5	18.5	26	20	20	35	16	-	0.9	-	0.4
CGM24	26	28	34.5	18.5	26	23	20	38	18	-	0.9	-	0.4
UPHOLSTERED BACK													
CGU21	23	28	34.5	18.5	26	20	20	37	16	1.6	0.9	1.6	0.4
CGU24	26	28	34.5	18.5	26	23	20	41	19	1.6	0.9	1.6	0.4
CGU30	32	28	34.5	18.5	26	29	20	46	22	2.5	0.9	2.5	0.4
CGU44	46	28	34.5	18.5	26	43	20	60	31	2.5	0.9	2.5	0.4

DIMENSIONS & COM. REQUIREMENTS - END UNITS

	Overall Width	Overall Depth	Overall Height	Seat Height	Height of Arms from Floor	Width Between Arms	Seat Depth	Shipping Weight	Cube	COM. Seat & Back Yardage	COM. Fabric Seat Yardage	COM. Fabric Back Yardage	COM. Fabric Closed Arm Panel Yardage
MESH BACK													
EGM21	23	28	34.5	18.5	26	20	20	35	16	-	0.9	-	0.4
EGM24	26	28	34.5	18.5	26	23	20	38	18	-	0.9	-	0.4
UPHOLSTERED BACK													
EGU21	23	28	34.5	18.5	26	20	20	37	16	1.6	0.9	1.6	0.4
EGU24	26	28	34.5	18.5	26	23	20	41	18	1.6	0.9	1.6	0.4
EGU30	32	28	34.5	18.5	26	29	20	46	22	2.5	0.9	2.5	0.4
EGU44	46	28	34.5	18.5	26	43	20	60	31	2.5	0.9	2.5	0.4

Closed Arm Panels (per chair) - please add the following up charges for closed arm panels.

Fabric Grades	(COM) 1	(COL) 2	(COL) 3	4	5	6	7	Leather 8	9	COM
Closed Arm Panel (1 arm)	208	224	238	267	294	321	350	379	435	0.4
Closed Arm Panels (2 arms)	418	448	477	531	588	643	699	757	869	0.8
Fully Closed Arm (1 arm)	339	365	391	436	483	529	576	627	707	1.5
Fully Closed Arm (2 arms)	677	730	782	872	967	1054	1151	1253	1412	3

SOLIS BEHAVIORAL HEALTH | START, CENTER & END GUEST UNITS

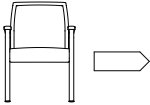
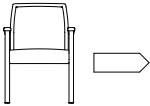
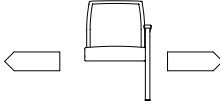
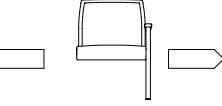
DESCRIPTION/MODEL			COM		COL	FABRIC GRADES			LEATHER				
			1	2	3	4	5	6	7	8	9		
	21" Open Arm Start Guest Unit, Mesh Back		SOL2-SGBHM21OPU	Urethane	1119	1151	1181	1245	1309	1372	1434	1499	1596
			SOL2-SGBHM21OPW	Beech	1240	1271	1304	1367	1429	1492	1556	1619	1716
	21" Open Arm Start Guest Unit, Upholstered Back		SOL2-SGBHU21OPU	Urethane	1169	1220	1271	1373	1477	1578	1678	1779	1985
			SOL2-SGBHU21OPW	Beech	1289	1340	1391	1493	1594	1697	1801	1899	2106
	24" Open Arm Start Guest Unit, Mesh Back		SOL2-SGBHM24OPU	Urethane	1161	1192	1223	1285	1349	1414	1478	1538	1638
			SOL2-SGBHM24OPW	Beech	1281	1311	1342	1405	1468	1534	1596	1661	1756
	24" Open Arm Start Guest Unit, Upholstered Back		SOL2-SGBHU24OPU	Urethane	1209	1262	1312	1415	1515	1619	1685	1821	2028
			SOL2-SGBHU24OPW	Beech	1331	1381	1433	1535	1638	1818	1840	1942	2146
	30" Open Arm Start Guest Unit, Upholstered Back		SOL2-SGBHU30OPU	Urethane	1443	1522	1604	1761	1922	2083	2239	2401	2718
			SOL2-SGBHU30OPW	Beech	1563	1642	1724	1882	2042	2201	2359	2522	2839
	44" Open Arm Start Guest Unit, Upholstered Back		SOL2-SGBHU44OPU	Urethane	1606	1686	1765	1923	2085	2241	2405	2562	2880
			SOL2-SGBHU44OPW	Beech	1727	1806	1884	2043	2205	2361	2524	2682	2999
	21" Open Arm Center Guest Unit, Mesh Back		SOL2-CGBHM21OPU	Urethane	1021	1054	1086	1147	1210	1273	1336	1401	1499
			SOL2-CGBHM21OPW	Beech	1083	1114	1143	1207	1271	1334	1396	1460	1559
	21" Open Arm Center Guest Unit, Upholstered Back		SOL2-CGBHU21OPU	Urethane	1064	1117	1168	1270	1372	1474	1572	1677	1881
			SOL2-CGBHU21OPW	Beech	1124	1177	1228	1331	1431	1534	1634	1738	1941
	24" Open Arm Center Guest Unit, Mesh Back		SOL2-CGBHM24OPU	Urethane	1046	1081	1110	1172	1237	1302	1361	1425	1524
			SOL2-CGBHM24OPW	Beech	1108	1139	1170	1232	1297	1359	1422	1485	1584
	24" Open Arm Center Guest Unit, Upholstered Back		SOL2-CGBHU24OPU	Urethane	1093	1143	1195	1297	1398	1503	1604	1704	1909
			SOL2-CGBHU24OPW	Beech	1153	1205	1254	1357	1459	1562	1664	1765	1968

Solis Behavioral Health guest chairs have the option of Closed or Fully Closed arms, change the last 3 letters of the model number to the required arm type from the Product Code Key below and add the upcharge on page 427.

PRODUCT CODE KEY

Line	Series	Chair Type	Back Type	Size	Arm Type
SOL	2	SG	U	21	OPW
Solis	Chair	Start Unit Guest Multiple Seating	Upholstered Back		Open Arm - Wood Arm
		CG	M	24	OPU
		Center Unit Guest Multiple Seating	Mesh Back 21" & 24" Only		Open Arm Urethane Arm
		EG		30	CLW
		End Unit Guest Multiple Seating			Closed Arm - Wood
				44	CLU
					Closed Arm - Urethane
					FCW
					Fully Closed Arm - Wood
					FCU
					Fully Closed Arm - Urethane

SOLIS BEHAVIORAL HEALTH | CENTER & END GUEST UNITS

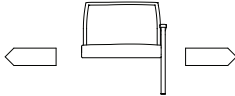
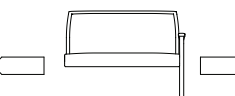
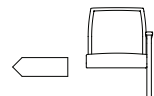
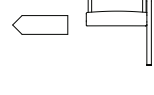
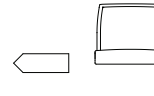
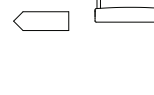
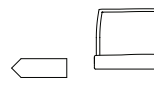
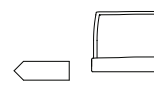
DESCRIPTION/MODEL		COM		COL	FABRIC GRADES			LEATHER		
		1	2	3	4	5	6	7	8	9
	30" Open Arm Center Guest Unit, Upholstered Back									
	SOL2-CGBHU30OPU Urethane	1310	1389	1467	1631	1788	1946	2107	2265	2585
	SOL2-CGBHU30OPW Beech	1371	1449	1529	1690	1846	2006	2167	2324	2642
	44" Open Arm Center Guest Unit, Upholstered Back									
	SOL2-CGBHU44OPU Urethane	1463	1545	1617	1781	1942	2103	2263	2419	2740
	SOL2-CGBHU44OPW Beech	1524	1606	1685	1842	2002	2163	2322	2480	2800
	21" Open Arm End Guest Unit, Mesh Back									
	SOL2-EGBHM21OPU Urethane	1021	1054	1086	1147	1210	1273	1336	1401	1499
	SOL2-EGBHM21OPW Beech	1083	1114	1143	1207	1271	1334	1396	1460	1559
	21" Open Arm End Guest Unit, Upholstered Back									
	SOL2-EGBHU21OPU Urethane	1064	1117	1168	1270	1372	1474	1572	1677	1881
	SOL2-EGBHU21OPW Beech	1124	1177	1228	1331	1431	1534	1634	1738	1941
	24" Open Arm End Guest Unit, Mesh Back									
	SOL2-EGBHM24OPU Urethane	1046	1081	1110	1172	1237	1302	1361	1425	1524
	SOL2-EGBHM24OPW Beech	1108	1139	1170	1232	1297	1359	1422	1485	1584
	24" Open Arm End Guest Unit, Upholstered Back									
	SOL2-EGBHU24OPU Urethane	1093	1143	1195	1297	1398	1503	1604	1704	1909
	SOL2-EGBHU24OPW Beech	1153	1205	1254	1357	1459	1562	1664	1765	1968
	30" Open Arm End Guest Unit, Upholstered Back									
	SOL2-EGBHU30OPU Urethane	1310	1389	1467	1631	1788	1946	2107	2265	2585
	SOL2-EGBHU30OPW Beech	1371	1449	1529	1690	1846	2006	2167	2324	2642
	44" Open Arm End Guest Unit, Upholstered Back									
	SOL2-EGBHU44OPU Urethane	1463	1545	1617	1781	1942	2103	2263	2419	2740
	SOL2-EGBHU44OPW Beech	1524	1606	1685	1842	2002	2163	2322	2480	2800

ORDERING NOTES:

The standard **Solis Frame Color** is Silver Metallic. Additional frame colors are available for an upcharge of **\$64 list** per arm frame pair, please see page 24 for color selection and required ordering quantities. Silver metallic frames are available with an anti-microbial finish for an upcharge of **\$64 list** per arm frame pair or table.

Solis Behavioral Health guest chairs have the option of Closed or Fully Closed arms, change the last 3 letters of the model number to the required arm type from the Product Code Key below and add the upcharge on page 427.

PRODUCT CODE KEY

Line	Series	Chair Type	Back Type	Size	Arm Type
SOL	2	SG	U	21	OPW
Solis	Chair	Start Unit Guest Multiple Seating	Upholstered Back		Open Arm - Wood Arm
		CG	M	24	OPU
		Center Unit Guest Multiple Seating	Mesh Back 21" & 24" Only		Open Arm Urethane Arm
		EG		30	CLW
		End Unit Guest Multiple Seating			Closed Arm - Wood
				44	CLU
					Closed Arm - Urethane
					FCW
					Fully Closed Arm - Wood
					FCU
					Fully Closed Arm - Urethane

SOLIS BEHAVIORAL HEALTH | MULTIPLE SEATING - PATIENT BACKS

DIMENSIONS & COM. REQUIREMENTS - START UNITS

	Overall Width	Overall Depth	Overall Height	Seat Height	Height of Arms from Floor	Width Between Arms	Seat Depth	Shipping Weight	Cube	COM. Seat & Back Yardage	COM. Fabric Seat Yardage	COM. Fabric Back Yardage	COM. Fabric Closed Arm Panel (1 Arm) Yardage	COM. Fabric Closed Arm Panel (2 Arms) Yardage
MESH BACK														
SPM21	25	28	43.75	18.5	26	20	20	42	21	-	0.9	-	0.4	0.8
SPM24	28	28	43.75	18.5	26	23	20	45	23	-	0.9	-	0.4	0.8
UPHOLSTERED BACK														
SPU21	25	28	43.75	18.5	26	20	20	46	21	2.1	0.9	2.0	0.4	0.8
SPU24	28	28	43.75	18.5	26	23	20	50	23	2.1	0.9	2.0	0.4	0.8
SPU30	34	28	43.75	18.5	26	29	20	56	28	3.1	0.9	2.2	0.4	0.8

DIMENSIONS & COM. REQUIREMENTS - CENTER UNITS

	Overall Width	Overall Depth	Overall Height	Seat Height	Height of Arms from Floor	Width Between Arms	Seat Depth	Shipping Weight	Cube	COM. Seat & Back Yardage	COM. Fabric Seat Yardage	COM. Fabric Back Yardage	COM. Fabric Closed Arm Panel Yardage	
MESH BACK														
CPM21	23	28	43.75	18.5	26	20	20	36	21	-	0.9	-	0.4	
CPM24	26	28	43.75	18.5	26	23	20	39	23	-	0.9	-	0.4	
UPHOLSTERED BACK														
CPU21	23	28	43.75	18.5	26	20	20	40	21	2.1	0.9	2.0	0.4	
CPU24	26	28	43.75	18.5	26	23	20	44	23	2.1	0.9	2.0	0.4	
CPU30	32	28	43.75	18.5	26	29	20	50	28	3.1	0.9	2.2	0.4	

DIMENSIONS & COM. REQUIREMENTS - END UNITS

	Overall Width	Overall Depth	Overall Height	Seat Height	Height of Arms from Floor	Width Between Arms	Seat Depth	Shipping Weight	Cube	COM. Seat & Back Yardage	COM. Fabric Seat Yardage	COM. Fabric Back Yardage	COM. Fabric Closed Arm Panel Yardage	
MESH BACK														
EPM21	23	28	43.75	18.5	26	20	20	36	21	-	0.9	-	0.4	
EPM24	26	28	43.75	18.5	26	23	20	38	23	-	0.9	-	0.4	
UPHOLSTERED BACK														
EPU21	23	28	43.75	18.5	26	20	20	40	21	2.1	0.9	2.0	0.4	
EPU24	26	28	43.75	18.5	26	23	20	44	23	2.1	0.9	2.0	0.4	
EPU30	32	28	43.75	18.5	26	29	20	50	28	3.1	0.9	2.2	0.4	

ORDERING NOTES:

Multiple yardage requirements for Patient back Start, Center and End units, please refer to page 25.

Closed Arm Panels (per chair) - please add the following up charges for closed arm panels.

Fabric Grades	(COM) 1	2	(COL) 3	4	5	6	7	Leather 8	9	COM
Closed Arm Panel (1 arm)	208	224	238	267	294	321	350	379	435	0.4
Closed Arm Panels (2 arms)	418	448	477	531	588	643	699	757	869	0.8
Fully Closed Arm (1 arm)	627	669	710	796	879	963	1048	1135	1304	1.5
Fully Closed Arm (2 arms)	835	890	948	1061	1172	1285	1335	1510	1736	3

SOLIS BEHAVIORAL HEALTH | START & CENTER PATIENT UNITS

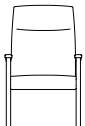
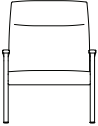
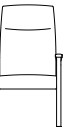
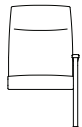
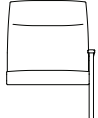
DESCRIPTION/MODEL	COM		COL		FABRIC GRADES			LEATHER			
	1	2	3	4	5	6	7	8	9		
START 	21" Open Arm Start Patient Unit, Mesh Back										
	SOL2-SPBHM21OPU	Urethane	1164	1241	1272	1335	1398	1461	1526	1589	1688
	SOL2-SPBHM21OPW	Beech	1331	1360	1393	1456	1519	1583	1644	1709	1808
	21" Open Arm Start Patient Unit, Upholstered Back										
	SOL2-SPBHU21OPU	Urethane	1265	1331	1396	1533	1664	1801	1932	2064	2333
	SOL2-SPBHU21OPW	Beech	1384	1451	1518	1653	1782	1921	2054	2186	2453
	24" Open Arm Start Patient Unit, Mesh Back										
	SOL2-SPBHM24OPU	Urethane	1247	1281	1311	1374	1439	1503	1565	1629	1727
	SOL2-SPBHM24OPW	Beech	1370	1401	1431	1494	1559	1622	1686	1748	1845
	24" Open Arm Start Patient Unit, Upholstered Back										
	SOL2-SPBHU24OPU	Urethane	1305	1372	1439	1570	1705	1839	1974	2108	2377
	SOL2-SPBHU24OPW	Beech	1423	1492	1559	1692	1825	1959	2092	2229	2496
	30" Open Arm Start Patient Unit, Upholstered Back										
	SOL2-SPBHU30OPU	Urethane	1640	1741	1837	2033	2234	2431	2629	2824	3220
	SOL2-SPBHU30OPW	Beech	1760	1860	1957	2155	2354	2552	2746	2946	3342
CENTER 	21" Open Arm Center Patient Unit, Mesh Back										
	SOL2-CPBHM21OPU	Urethane	1111	1142	1173	1239	1303	1363	1428	1491	1589
	SOL2-CPBHM21OPW	Beech	1171	1203	1236	1298	1360	1423	1487	1552	1647
	21" Open Arm Center Patient Unit, Upholstered Back										
	SOL2-CPBHU21OPU	Urethane	1161	1228	1294	1428	1562	1693	1832	1964	2232
	SOL2-CPBHU21OPW	Beech	1220	1288	1355	1487	1622	1753	1890	2024	2293
	24" Open Arm Urethane Cap Center Patient Unit, Mesh Back										
	SOL2-CPBHM24OPU	Urethane	1138	1169	1201	1265	1328	1390	1453	1515	1613
	SOL2-CPBHM24OPW	Beech	1198	1229	1262	1323	1387	1451	1513	1578	1672
	24" Open Arm Center Patient Unit, Upholstered Back										
	SOL2-CPBHU24OPU	Urethane	1187	1253	1319	1456	1589	1723	1856	1990	2257
	SOL2-CPBHU24OPW	Beech	1246	1314	1381	1515	1647	1781	1915	2053	2319
	30" Open Arm Center Patient Unit, Upholstered Back										
	SOL2-CPBHU30OPU	Urethane	1506	1606	1703	1899	2096	2295	2493	2692	3087
	SOL2-CPBHU30OPW	Beech	1566	1666	1764	1960	2158	2355	2554	2751	3145

Solis Behavioral Health guest chairs have the option of Closed or Fully Closed arms, change the last 3 letters of the model number to the required arm type from the Product Code Key below and add the upcharge on page 426.

PRODUCT CODE KEY

Line	Series	Chair Type	Back Type	Size	Arm Type
SOL	2	SG	U	21	OPW
Solis	Chair	Start Unit Guest Multiple Seating	Upholstered Back		Open Arm - Wood Arm
		CG	M	24	OPU
		Center Unit Guest Multiple Seating	Mesh Back 21" & 24" Only		Open Arm Urethane Arm
		EG		30	CLW
		End Unit Guest Multiple Seating			Closed Arm - Wood
				44	CLU
					Closed Arm - Urethane
					FCW
					Fully Closed Arm - Wood
					FCU
					Fully Closed Arm - Urethane

SOLIS BEHAVIORAL HEALTH | END PATIENT UNITS

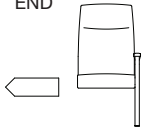
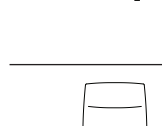
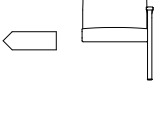
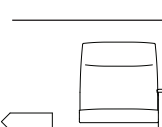
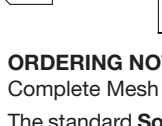
DESCRIPTION/MODEL	COM		COL		FABRIC GRADES			LEATHER		
	1	2	3	4	5	6	7	8	9	
 21" Open Arm End Unit, Mesh Back SOL2-EPBHM21OPU Urethane SOL2-EPBHM21OPW Beech	1111	1142	1173	1239	1303	1363	1428	1491	1589	
	1171	1203	1236	1298	1360	1423	1487	1552	1647	
 21" Open Arm End Unit, Upholstered Back SOL2-EPBHU21OPU Urethane SOL2-EPBHU21OPW Beech	1161	1228	1294	1428	1562	1693	1832	1964	2232	
	1220	1288	1355	1487	1622	1753	1890	2024	2293	
 24" Open Arm Urethane Cap End Unit, Mesh Back SOL2-EPBHM24OPU Urethane SOL2-EPBHM24OPW Beech	1138	1169	1201	1265	1328	1390	1453	1515	1613	
	1198	1229	1262	1323	1387	1451	1513	1578	1672	
 24" Open Arm End Unit, Upholstered Back SOL2-EPBHU24OPU Urethane SOL2-EPBHU24OPW Beech	1187	1253	1319	1456	1589	1723	1856	1990	2257	
	1246	1314	1381	1515	1647	1781	1915	2053	2319	
 30" Open Arm End Unit, Upholstered Back SOL2-EPBHU30OPU Urethane SOL2-EPBHU30OPW Beech	1506	1606	1703	1899	2096	2295	2493	2692	3087	
	1566	1666	1764	1960	2158	2355	2554	2751	3145	

ORDERING NOTES:

Complete Mesh backs (21" & 24") can be ordered and field replaced.

The standard **Solis Frame Color** is Silver Metallic. Additional frame colors are available for an upcharge of **\$64 list** per arm frame pair, please see **page 24** for color selection and required ordering quantities. Silver metallic frames are available with an anti-microbial finish for an upcharge of **\$64 list** per arm frame pair or table.

Solis Option Upcharges	\$ List		\$ List
CAL 133 & Moisture Barrier (per yard)	64	Non-Marring Glide	37
Removable Seat Cover (per seat)	80	Kinetic Back option	120
21" & 24" - Removeable Back Covers (per back)	58	Maple Arm upgrade per arm (add to beech price)	80
30" - Removable Back Cover (per back)	80		
Combination Upholstery - dual fabrics	33		
Combination Upholstery -Three fabrics	64		

Solis Behavioral Health Option Upcharges \$ List





Plywood Seat / No Springs	121	Weight Shield (to min 80lbs) - 21" Uph.	408
Sled Base	265	Weight Shield (to min 80lbs) - 21" Mesh	486
Anchor to Floor (Sleigh base only)	359	Weight Shield (to min 80lbs) - 24" Uph.	337
21" Tamper- Resistant Splashguard	157	Weight Shield (to min 80lbs) - 24" Mesh	412
24" Tamper- Resistant Splashguard	165	Weight Shield (to min 80lbs) - 30" Uph.	180
30" Tamper- Resistant Splashguard	340		

Solis Behavioral Health guest chairs have the option of Closed or Fully Closed arms, change the last 3 letters of the model number to the required arm type from the Product Code Key below and add the upcharge on page 430.

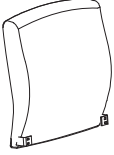

PRODUCT CODE KEY

Line	Series	Chair Type	Back Type	Size	Arm Type
SOL	2	SG	U	21	OPW
Solis	Chair	Start Unit Guest Multiple Seating	Upholstered Back		Open Arm -Wood Arm
		CG	M	24	OPU
		Center Unit Guest Multiple Seating	Mesh Back 21" & 24" Only		Open Arm Urethane Arm
		EG		30	CLW
		End Unit Guest Multiple Seating			Closed Arm - Wood
				44	CLU
					Closed Arm - Urethane
					FCW
					Fully Closed Arm - Wood
					FCU
					Fully Closed Arm - Urethane

SOLIS BEHAVIORAL HEALTH | REPLACEMENT COMPONENTS

Description	Model	COM		COL			FABRIC GRADES			LEATHER			Yardage	Weight	Cube
		1	2	3	4	5	6	7	8	9					
	21" Replacement Behavioral Health Guest Upholstered Backs	SOL2-RBBHGU21	508	555	598	665	740	807	883	977	1067	1.5	14	2.7	
	21" Replacement Behavioral Health Guest Mesh Backs	SOL2-RBBHGM21	441										10	2.7	
	24" Replacement Behavioral Health Guest Upholstered Backs	SOL2-RBBHGU24	529	571	620	687	763	829	904	995	1089	1.5	15	2.8	
	24" Replacement Behavioral Health Guest Mesh Backs	SOL2-RBBHGM24	468										11	2.8	
	30" Replacement Behavioral Health Guest Upholstered Backs	SOL2-RBBHGU30	597	652	705	780	905	940	1027	1135	1241	1.6	19	3.4	
	44" Replacement Behavioral Health Guest Upholstered Backs	SOL2-RBBHGU44	774	824	879	956	1039	1117	1202	1309	1416	2.25	28	4.8	
		21" Replacement Behavioral Health Patient Upholstered Backs	SOL2-RBBHPU21	628	695	764	856	961	1059	1165	1298	1433	2.0	21	3.8
		21" Replacement Behavioral Health Mesh Backs	SOL2-RBBHPM21	478										15	3.8
		24" Replacement Behavioral Health Patient Upholstered Backs	SOL2-RBBHPU24	662	729	796	889	997	1090	1198	1334	1466	2.0	21	3.8
		24" Replacement Behavioral Health Patient Mesh Backs	SOL2-RBBHPM24	508										17	3.8
		30" Replacement Behavioral Health Patient Upholstered Backs	SOL2-RBBHPU30	834	921	1009	1131	1270	1391	1533	1706	1881	2.2	24	4.8
			21" Replacement Behavioral Health Guest Upholstered Back Cover	SOL2-RBCBHGU21	155	202	246	313	389	455	531	624	717	1.5	2
21" Replacement Behavioral Health Guest Mesh Back Cover			SOL2-RBCBHGM21	191										2	.8
24" Replacement Behavioral Health Guest Upholstered Back Cover			SOL2-RBCBHGU24	155	202	247	313	389	455	532	624	720	1.5	2.3	.8
24" Replacement Behavioral Health Mesh Back Cover			SOL2-RBCBHGM24	232										2.3	.8
30" Replacement Behavioral Health Guest Upholstered Back Cover			SOL2-RBCBHGU30	169	224	274	350	435	512	597	717	811	1.6	2.6	.8
44" Replacement Behavioral Health Guest Upholstered Back Cover			SOL2-RBCBHGU44	178	232	284	362	448	518	606	715	821	2.25	3.5	.8
			21" Replacement Behavioral Health Patient Upholstered Back Cover	SOL2-RBCBHPU21	199	267	334	427	535	628	735	870	1003	2.0	2.5
	21" Replacement Behavioral Health Mesh Back Cover		SOL2-RBCBHPM21	212										2.5	.8
	24" Replacement Behavioral Health Patient Upholstered Back Cover		SOL2-RBCBHPU24	201	267	334	427	536	628	735	870	1003	2.0	2.7	.8
	24" Replacement Behavioral Health Patient Mesh Back Cover		SOL2-RBCBHPM24	250										2.7	.8
	30" Replacement Behavioral Health Patient Upholstered Back Cover		SOL2-RBCBHPU30	244	333	420	541	679	804	941	1117	1290	2.2	3	.8

SOLIS BEHAVIORAL HEALTH | REPLACEMENT COMPONENTS

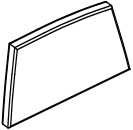
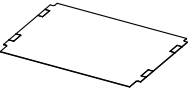
Description	Model	COM		COL	FABRIC GRADES			LEATHER			Yardage	Weight	Cube
		1	2	3	4	5	6	7	8	9			
	21" Replacement Behavioral Health Seat												
	SOL2-RSBH21	321	352	382	424	473	514	562	624	686	.9	9	2.7
	24" Replacement Behavioral Health Seat												
	SOL2-RSBH24	358	388	418	458	510	548	598	659	720	.9	10	2.7
	30" Replacement Behavioral Health Seat												
SOL2-RSBH30	405	434	464	509	546	597	644	705	765	.9	12	3.4	
	44" Replacement Behavioral Health Seat												
SOL2-RSBH44	538	576	613	665	723	777	834	909	983	.9	14	4.8	
	21" Replacement Behavioral Health No Spring Seat												
	SOL2-RSBH21NS	443	473	502	543	592	634	685	744	806	.9	9	2.7
	24" Replacement Behavioral Health No Spring Seat												
	SOL2-RSBH24NS	479	510	538	582	628	670	720	780	840	.9	10	2.7
	30" Replacement Behavioral Health No Spring Seat												
SOL2-RSBH30NS	522	556	585	627	667	717	765	824	886	.9	12	3.4	
	44" Replacement Behavioral Health No Spring Seat												
SOL2-RSBH44NS	659	696	732	784	844	895	955	1030	1103	.9	12	3.4	
	21" Replacement Behavioral Health Seat Cover												
	SOL2-RSBHC21	108	138	169	210	259	301	348	409	470	1.0	1.6	.8
	24" Replacement Behavioral Health Seat Cover												
	SOL2-RSBHC24	111	140	170	212	260	302	350	410	471	1.0	1.7	.8
	30" Replacement Guest, Patient & Easy Access Seat Cover												
SOL2-RSBHC30	119	141	179	223	270	312	362	422	481	1.0	2	.8	
	44" Replacement Behavioral Health Seat Cover												
SOL2-RSBHC44	140	178	213	267	326	376	434	510	583	1.0	2.5	.8	
	Replacement Closed Arm												
	SOL2-RCA	195	207	220	238	259	276	297	321	345	.8	6	.9
	Replacement Lower Closed Arm Panel												
SOL2-RCAB	137	151	163	182	202	218	240	265	291	.8	6	.9	
	Bottom Staple Cover/Shield												
	SOL2-RBC21	82										2	0.8
	SOL2-RBC24	85										2.3	0.8
	SOL2-RBC30	95										2.6	0.8
	SOL2-RBC44	105										3.5	0.8
	Weighted Shield												
	SOL2-RWSU21	408										25	1
	SOL2-RWSM21	486										25	1
	SOL2-RWSU24	337										25	1
	SOL2-RWSM24	412										25	1
	SOL2-RWSU30	180										31	1
	SOL2-RWSU44	171										44	1
	Tamper- Resistant Splashguard												
	SOL2-RSGBH21	259										1	.3
	SOL2-RSGBH24	269										2	.4
SOL2-RSGBH30	464										3	.5	
SOL2-RSGBH44	502										4	.6	

SOLIS BEHAVIORAL HEALTH | REPLACEMENT FRAMES

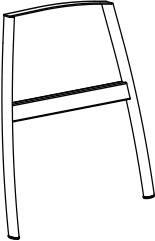
Description	Model	Price	Weight	Cubes
	Tamper- Resistant Side Frame Assembly - Start		9	1.5
	SOL2-RSFABHS - Urethane	178		
	- Beech	357		
	Tamper- Resistant Side Frame Assembly - Center		9	1.5
	SOL2-RSFABHC - Urethane	178		
	- Beech	357		
	Tamper- Resistant Side Frame Assembly - End		9	1.5
	SOL2-RSFABHE - Urethane	178		
	- Beech	357		
	Sleigh Base Side Frame Assembly - Start		9	1.5
SOL2-RSFABHSSB - Urethane	585			
- Beech	764			
Sleigh Base Side Frame Assembly - Center		9	1.5	
SOL2-RSFABHCSB - Urethane	585			
- Beech	764			
Sleigh Base Side Frame Assembly - End		9	1.5	
SOL2-RSFABHESB - Urethane	585			
- Beech	764			
Sleigh Base Fully Closed Side Frame - Start		9	1.5	
SOL2-RSFABHSFC - Urethane	585			
- Beech	764			
Sleigh Base Fully Closed Side Frame - Center		9	1.5	
SOL2-RSFABHCFC - Urethane	585			
- Beech	764			
Sleigh Base Fully Closed Side Frame - End		9	1.5	
SOL2-RSFABHEFC - Urethane	585			
- Beech	764			

Maple arm side frames are available for an upcharge of \$74 list per arm, please see page 630 for finish selection.

Tamper- Resist Tool Kit				
SOL2-BHTK		143		

FAERON BEHAVIORAL HEALTH | ENVIRONMENTAL SUMMARY

LEED CI CREDITS

Guest Seating



Material Content:

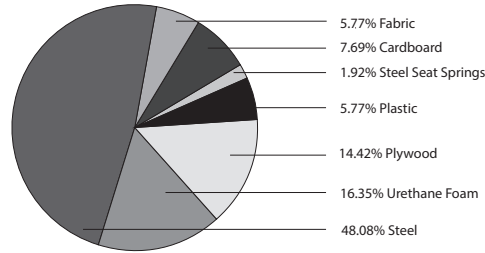

Pre-Consumer
Recycled Content = 6.25%

Post-Consumer
Recycled Content = 17.77%

Up to 55.77% of this Faeron Metal product is recyclable at the end of its useful life.

CONTRIBUTES TO

CREDIT	CONTRIBUTES TO	POINTS
CREDIT 2.1 - 2.2	Construction Waste Management	1-2 point(s)
CREDIT 3.3	Resource Reuse	1 point
CREDIT 4.1	Recycled Content	1 point
CREDIT 4.2	Recycled Content	1 point
CREDIT 4.5	Low Emitting Materials, Systems & Seating	1 point
CREDIT 5.1	Regional Materials*	1 point
CREDIT 7	Certified Wood (MUST BE REQUESTED)	1 point(s)

*This credit is only applicable if in total 20% of the combined value of the procurement of construction materials and in the furniture are manufactured within a radius of 500 miles. This credit will apply if the installation of the finished product occurs within 500 miles of Kitchener, Ontario.

level® CERTIFICATION, AIR EMISSIONS AND FSC® CERTIFICATION



level® CERTIFICATION

BIFMA's e3 Furniture Sustainability Standard is a voluntary, multi-attribute standard that measures the degree of sustainability of furniture. This standard evaluates product and company environmental attributes and compliance systems in a wide range of elements which include Materials, Energy & Atmosphere, Human & Ecosystem Health and Social Responsibility. Faeron products have earned level®, BIFMA's sustainability certification program for furniture, certification through third-party verification against the e3 standard.

AIR-EMISSIONS

All Faeron products are supplied with air-emissions certified. Contact customer service for information.



FSC®

In 2005, Krug received Forest Stewardship Council® (FSC®) Chain-of-Custody certification for our manufacturing facilities. The FSC® Chain-of-Custody tracks certified wood from seedling to final sale. It verifies that the material for our FSC certified products only come from well-managed, FSC®-certified forests and other controlled sources. FSC® is dedicated to the promotion of responsible forest management worldwide helping to take care of forests for future generations. Faeron and other Krug products can be specified with FSC® Certification. Contact customer service for further information, pricing and lead times.



Architects, designers, and building professionals can specify FSC®-certified products in order to achieve a point from the U.S. Green Building Council's Leadership in Energy and Environmental Design (LEED) Rating System.

FAERON BEHAVIORAL HEALTH | GUEST & PATIENT SEATING | FEATURES



FLEX BACK

The ergonomically designed back has been designed with a slight flexing action for enhanced comfort and ease of ingress and egress.



WALL SAVER

The angle of the back and the rear legs are designed to keep the back away from the wall, to prevent wear and damage to both the chairs and the walls of the facility.

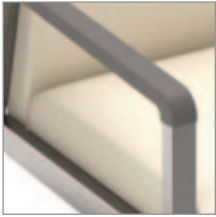

POLYMER ARM

Faeron Metal Behavioral Health guest and patient chairs are standard with tamper-resistant polymer arms that are durable, comfortable, and long lasting. Available in black, grey and taupe.



SPRING SEAT CONSTRUCTION

Faeron Metal Behavioral Health guest and patient chairs are designed with spring seat construction and dual density foam for superior longevity, comfort and performance.



STEEL SEAT FRAME

Side frames, backs and seats are attached to a heavy-duty steel frame with tamper-resistant hardware. These components are removable and field replaceable.



CLEAN OUT

Faeron Metal Behavioral Health guest and patient chairs feature a clean out space that supports infection control by enabling debris and fluid to fall to the floor for easy cleaning.

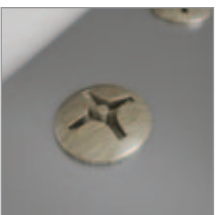

TAMPER-RESISTANT HARDWARE

Tamper-resistant hardware is utilized in the construction of all Faeron Metal Behavioral Health seating. The specific tools needed to remove components for maintenance or replacement are available for purchase from Krug.



INACCESSIBLE STAPLES

An inaccessible galvanized steel band with vinyl edges covers the staples on the back upholstery cover. It is installed with tamper-resistant hardware.

SECURED GLIDES

Faeron Metal Behavioral Health seating features tamper-resistant glides to minimize risk of removal and weaponization.

UNDERSEAT SHIELD

Faeron Metal Behavioral Health guest and patient chairs feature a metal under seat shield that minimizes the risk of access to the upholstery staples. It also minimizes the ability to hide contraband under the seat. The vented shield is compatible with ganging brackets and is installed with tamper-resistant hardware.

LATEX-FREE

Krug products are made with latex-free materials, to help prevent allergic reaction.

WEIGHT CAPACITIES

Tested to meet or exceed the BIFMA X5.4 Standard Guest & Patient Chairs (21" & 24") - 500 lbs
Plus Chairs (30" & 44") - 750 lbs



KINETIC BACK

The optional Kinetic Back provides the chair back with a very pleasant and comfortable rocking motion, which can significantly enhance long-term sitting. The durable spring-loaded mechanism provides a range of motion of 20 degrees, and can be field-installed or replaced. It is available on any Faeron Guest chair back with the exception of the Plus sizes (30" and 44").



SOLID SURFACE ARM

The optional Solid Surface Arm provides a fully seamless armrest for enhanced durability, protection and cleanability. It is available in 8 standard Corian colors, and custom colors (at an upcharge). Arms are replaceable as a full side frame if they become damaged or degraded. Solid Surface not recommended for lower acuity environments.



WOOD ARM

Faeron Wood Arm caps are fastened to the side frames. Wood arms are solid Beech and available in standard and custom finishes. Arms can be replaced if they do become damaged or degraded.



CLOSED ARM PANEL

The side frames on Faeron Metal Behavioral Health guest and patient chairs can be enclosed to the center rail.

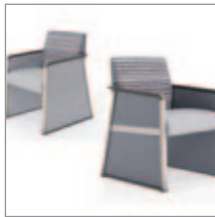

FULLY CLOSED ARM (SLEIGH BASE ONLY)

The side frames on Faeron Metal Behavioral Health guest and patient chairs can be fully enclosed to the base rail. This can be achieved with 2 panels showing the center rail or a single panel enclosing the center rail. This option is only available with the sled base.



FLOOR ANCHOR BRACKETS

For additional security, tamper-resistant anchor brackets are available to bolt the sled base to the floor. The hardware to attach the brackets to the floor is not included. This option is only available with the sled base.



SPRINGLESS SEATS

The springs in the seats can be replaced with an optional plywood seat pan and dual density foam.



SLED BASE

The sled base ties the front and back legs together with a steel rail. This option minimizes the risk of the chair being weaponized. Optional anchor brackets are available to bolt the base to the floor for additional security.

SUPPLEMENTAL WEIGHT

In place of the standard Underseat shield, an optional weighted black coated steel shield is available. The steel shield is designed to add enough weight for the product to be a minimum of 80 lbs. The shield is also designed to allow standard ganging hardware, seat ventilation and covers all access to the upholstery staples under the seat. The weighted shield is fastened with tamper-resistant hardware.

TAMPER-RESISTANT GANGING BRACKET

Faeron Metal Behavioral Health guest and patient chairs can be ganged together with a tamper-resistant powder coated metal bracket.

COMBINATION UPHOLSTERY

When combination upholstery is specified with fabric of the same grade or COM, an upcharge for dual fabrics is **\$32 list** per unit and **\$61 list** per unit for three fabrics will be applied. When graded in combination upholstery is selected, use the highest grade upholstery selected or to obtain a quote for blended grading contact Customer Service (please provide the fabrics specified and location of where each fabric is to be applied on the product).

REMOVABLE COVERS

Faeron Metal chairs are available with removeable seat and back covers. Replacement covers can be quickly field installed on Faeron products that were originally ordered with the removeable cover option. Replacement seat and back covers can also be installed on Faeron products that were not originally ordered with the removeable cover option, with some simple staple removal on the original seats and backs.

CAL133 & MOISTURE BARRIER

California Technical Bulletin 133 is a flammability test for seating. Krug offers a compliance method, in combination with non-flammable upholstery covers, may enable products to meet certification requirements for this test. This process at the same time also provides the products with a Moisture Barrier - a treatment that helps to prevent the passage of liquids and moisture to inside of the upholstered components - thereby conferring sanitary and anti-infection benefits. So when CAL 133 is specified, the product also automatically has a Moisture Barrier, and when a Moisture Barrier is specified, the product also features the compliance method and low flammability features of CAL 133.

The application of this up-charge and the compliance method does not mean that the specific configuration of product and upholstery cover are tested and officially certified as being CAL133 compliant. If the official certification is required, Krug will provide this (through an independent certified testing laboratory) at a charge of \$917 per item, plus the cost of the product to be tested. Lead time for certification testing is typically 4-8 weeks. Krug assumes no responsibility for the testing of our products in combination with upholstery covers, or for the results of any testing conducted. Some specific configurations of products and upholstery have already been tested. Please contact Customer Service for additional information.

FAERON BEHAVIORAL HEALTH | GUEST

DIMENSIONS

	Overall Width	Overall Depth	Overall Height	Seat Height	Height of Arms from Floor	Width Between Arms	Seat Depth	Shipping Weight	Cube
21" Seat	25.0	26.3	34.5	19.0	25.0	21	19.5	62	14
24" Seat	28.0	26.3	34.5	19.0	25.0	24	19.5	67	19
30" Seat	34.0	26.3	34.5	19.0	25.0	30	19.5	75	20
44" Seat	48.0	26.3	34.5	19.0	25.0	44	19.5	96	28

COM- YARDAGE REQUIREMENTS

	COM Yardage Seat & Back	COM Yardage Seats Only	COM Yardage Back Only	COM Yardage Closed Arm Panel	COM Yardage Fully Closed Arm
21" & 24" - One Chair	1.6	0.9	1.4	0.96	3.20
30" - One Chair	2.3	0.9	1.4	0.96	3.20
44" - One Chair	2.9	1.5	1.6	0.96	3.20

ORDERING NOTES:

The approval process is as follows:





1. A sample of the COM must be provided to Krug Customer Service prior to or at the time of order.
2. The sample will be reviewed and the customer advised if the fabric is unsuitable.
3. The COM fabric or leather will be inspected when received at the factory, to identify any further concerns with its suitability.

Note: Some vinyls, leathers & upholsteries are not suitable for application on Faeron Metal seating.

COMBINATION UPHOLSTERY OPTION

When combination upholstery is specified with fabric of the same grade or COM, an upcharge for dual fabrics is **\$33 list** per unit and **\$64 list** per unit for three fabrics will be applied. When graded in combination upholstery is selected, use the highest grade upholstery selected or to obtain a quote for blended grading contact Customer Service (please provide the fabrics specified and location of where each fabric is to be applied on the product).

FAERON BEHAVIORAL HEALTH | GUEST

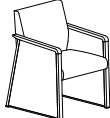
DESCRIPTION/MODEL	COM		COL		FABRIC GRADES			LEATHER		
	1	2	3	4	5	6	7	8	9	
	21" Open Polymer Arm, Silver Metallic Leg Base FAE2M-GBH21OPAS1	1436	1482	1528	1620	1712	1804	1897	1988	2171
	21" Open Polymer Arm, Brushed Nickel Leg Base FAE2M-GBH21OPAN1	1642	1687	1734	1826	1917	2010	2103	2194	2377
	21" Closed Polymer Arm, Silver Metallic Leg Base FAE2M-GBH21CPAS1	1880	1949	2018	2157	2295	2431	2571	2708	2984
	21" Closed Polymer Arm, Brushed Nickel Leg Base FAE2M-GBH21CPAN1	2086	2155	2224	2363	2500	2637	2777	2914	3190
	21" Open Polymer Arm, Silver Metallic Sled Base FAE2M-GBH21OPAS2	1571	1616	1662	1755	1846	1938	2032	2122	2306
	21" Open Polymer Arm, Brushed Nickel Sled Base FAE2M-GBH21OPAN2	1777	1822	1868	1960	2052	2144	2238	2328	2512
	21" Closed Polymer Arm, Silver Metallic Sled Base FAE2M-GBH21CPAS2	2014	2084	2153	2291	2429	2565	2705	2843	3119
	21" Closed Polymer Arm, Brushed Nickel Sled Base FAE2M-GBH21CPAN2	2220	2289	2359	2497	2635	2771	2911	3048	3325
	21" Two Panel Fully Closed Polymer Arm, Silver Metallic Sled Base FAE2M-GBH212PPFAS2	2120	2229	2339	2496	2667	2839	3029	3215	3519
	21" Two Panel Fully Closed Polymer Arm, Brushed Nickel Sled Base FAE2M-GBH212PPAN2	2326	2435	2545	2701	2873	3045	3235	3421	3725
	21" Single Panel Fully Closed Polymer Arm, Silver Metallic Sled Base FAE2M-GBH211PPFAS2	2482	2644	2807	3017	3254	3492	3762	4027	4431
	21" Single Panel Fully Closed Polymer Arm, Brushed Nickel Sled Base FAE2M-GBH211PPAN2	2688	2850	3013	3222	3460	3698	3968	4233	4637





ORDERING NOTES: Faeron Metal chairs can be specified with a Wood Arm (WA) or a Solid Surface Arm (SA), replace "PA" in the model number with the **Arm Style** selection below and add the upcharge listed.

Faeron Behavioral Health Option Upcharges	\$ List	\$ List
Kinetic Back	120	Supplemental Weight - 21"
Solid Surface Arm (per pair) - Gr A White	573	Supplemental Weight - 24"
Solid Surface Arm (per pair) - Gr A Color	598	Ganging Bracket
Solid Surface Arm (per pair) - Gr B	645	Combination Upholstery - Dual
Solid Surface Arm (per pair) - Gr C	678	Combination Upholstery - Three
Wood Arm (WA) - (per pair)	215	Removeable Seat Cover
Floor Anchor Brackets (Sleigh base only)	153	Removable Back Cover
Springless Seat	117	CAL 133 & Moisture Barrier (per yard)

PRODUCT CODE KEY

Line	Series	Chair Type	Size	Arm Type	Arm Style	Metal Finish	Base Type
FAE	2M	GBH	21	O	PA	S	1
Faeron	Chair	Guest Seating		Open Arm	Polymer Arm	Silver Metallic	Leg Base
			24	C	WA	N	2
				Closed Arm	Wood Arm	Brushed Nickel	Sled Base
			30	2PF	SA		
				Two Panel Fully Closed Arm	Solid Surface Arm		
			44	1PF			
				Single Panel Fully Closed Arm			

FAERON BEHAVIORAL HEALTH | GUEST

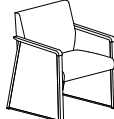
DESCRIPTION/MODEL	COM		COL	FABRIC GRADES			LEATHER					
	1	2	3	4	5	6	7	8	9			
	24" Open Polymer Arm, Silver Metallic Leg Base FAE2M-GBH24OPAS1			1540	1587	1633	1724	1818	1907	2000	2092	2275
	24" Open Polymer Arm, Brushed Nickel Leg Base FAE2M-GBH24OPAN1			1746	1792	1839	1930	2023	2113	2206	2298	2481
	24" Closed Polymer Arm, Silver Metallic Leg Base FAE2M-GBH24CPAS1			1985	2053	2122	2260	2398	2536	2675	2812	3088
	24" Closed Polymer Arm, Brushed Nickel Leg Base FAE2M-GBH24CPAN1			2191	2259	2328	2466	2603	2742	2881	3018	3294
	24" Open Polymer Arm, Silver Metallic Sled Base FAE2M-GBH24OPAS2			1675	1721	1767	1859	1952	2041	2135	2226	2410
	24" Open Polymer Arm, Brushed Nickel Sled Base FAE2M-GBH24OPAN2			1881	1927	1973	2064	2158	2247	2341	2432	2616
	24" Closed Polymer Arm, Silver Metallic Sled Base FAE2M-GBH24CPAS2			2119	2187	2257	2394	2532	2670	2809	2947	3223
	24" Closed Polymer Arm, Brushed Nickel Sled Base FAE2M-GBH24CPAN2			2325	2393	2463	2600	2738	2876	3015	3152	3429
	24" Two Panel Fully Closed Polymer Arm, Silver Metallic Sled Base FAE2M-GBH242PFPAS2			2224	2334	2444	2600	2773	2942	3132	3319	3623
	24" Two Panel Fully Closed Polymer Arm, Brushed Nickel Sled Base FAE2M-GBH242PFPAN2			2430	2540	2650	2805	2979	3148	3338	3525	3829
	24" Single Panel Fully Closed Polymer Arm, Silver Metallic Sled Base FAE2M-GBH241PFPAS2			2586	2749	2912	3121	3360	3595	3865	4131	4535
	24" Single Panel Fully Closed Polymer Arm, Brushed Nickel Sled Base FAE2M-GBH241PFPAN2			2792	2955	3118	3326	3566	3801	4071	4337	4741













ORDERING NOTES: Faeron Metal chairs can be specified with a Wood Arm (WA) or a Solid Surface Arm (SA), replace "PA" in the model number with the **Arm Style** selection below and add the upcharge listed.

Faeron Behavioral Health Option Upcharges	\$ List	\$ List
Kinetic Back	120	Supplemental Weight - 21"
Solid Surface Arm (per pair) - Gr A White	573	Supplemental Weight - 24"
Solid Surface Arm (per pair) - Gr A Color	598	Ganging Bracket
Solid Surface Arm (per pair) - Gr B	645	Combination Upholstery - Dual
Solid Surface Arm (per pair) - Gr C	678	Combination Upholstery - Three
Wood Arm (WA) - (per pair)	215	Removable Seat Cover
Floor Anchor Brackets (Sleigh base only)	153	Removable Back Cover
Springless Seat	117	CAL 133 & Moisture Barrier (per yard)

PRODUCT CODE KEY

Line	Series	Chair Type	Size	Arm Type	Arm Style	Metal Finish	Base Type
FAE	2M	GBH	21	O	PA	S	1
Faeron	Chair	Guest Seating		Open Arm	Polymer Arm	Silver Metallic	Leg Base
			24	C	WA	N	2
				Closed Arm	Wood Arm	Brushed Nickel	Sled Base
			30	2PF	SA		
				Two Panel Fully Closed Arm	Solid Surface Arm		
			44	1PF			
				Single Panel Fully Closed Arm			

FAERON BEHAVIORAL HEALTH | GUEST

DESCRIPTION/MODEL	COM		COL	FABRIC GRADES			LEATHER		
	1	2	3	4	5	6	7	8	9
	30" Open Polymer Arm, Silver Metallic Leg Base								
	FAE2M-GBH30OPAS1	1780	1845	1913	2044	2176	2310	2441	2573
	30" Open Polymer Arm, Brushed Nickel Leg Base								
	FAE2M-GBH30OPAN1	1986	2051	2118	2250	2382	2515	2647	2779
	30" Closed Polymer Arm, Silver Metallic Leg Base								
	FAE2M-GBH30CPAS1	2225	2313	2403	2581	2758	2937	3114	3294
	30" Closed Polymer Arm, Brushed Nickel Leg Base								
	FAE2M-GBH30CPAN1	2431	2519	2609	2787	2964	3142	3320	3499
	30" Open Polymer Arm, Silver Metallic Sled Base								
	FAE2M-GBH30OPAS2	1915	1980	2047	2178	2311	2444	2575	2708
	30" Open Polymer Arm, Brushed Nickel Sled Base								
	FAE2M-GBH30OPAN2	2121	2186	2253	2384	2516	2650	2781	2913
	30" Closed Polymer Arm, Silver Metallic Sled Base								
	FAE2M-GBH30CPAS2	2359	2447	2538	2715	2893	3071	3248	3428
	30" Closed Polymer Arm, Brushed Nickel Sled Base								
	FAE2M-GBH30CPAN2	2565	2653	2743	2921	3098	3277	3454	3634
	30" Two Panel Fully Closed Polymer Arm, Silver Metallic Sled Base								
	FAE2M-GBH302PPFAS2	2464	2593	2724	2919	3132	3345	3572	3801
	30" Two Panel Fully Closed Polymer Arm, Brushed Nickel Sled Base								
	FAE2M-GBH302PPFAN2	2669	2799	2930	3125	3337	3551	3778	4006
	30" Single Panel Fully Closed Polymer Arm, Silver Metallic Sled Base								
	FAE2M-GBH301PPFAS2	2826	3008	3192	3440	3719	3998	4305	4613
	30" Single Panel Fully Closed Polymer Arm, Brushed Nickel Sled Base								
	FAE2M-GBH301PPFAN2	3031	3214	3398	3646	3924	4204	4511	4818

ORDERING NOTES: Faeron Metal chairs can be specified with a Wood Arm (WA) or a Solid Surface Arm (SA), replace "PA" in the model number with the **Arm Style** selection below and add the upcharge listed.

Faeron Behavioral Health Option Upcharges	\$ List	\$ List
Solid Surface Arm (per pair) - Gr A White	573	Supplemental Weight - 30"
Solid Surface Arm (per pair) - Gr A Color	598	Ganging Bracket
Solid Surface Arm (per pair) - Gr B	645	Combination Upholstery - Dual
Solid Surface Arm (per pair) - Gr C	678	Combination Upholstery - Three
Wood Arm (WA) - (per pair)	215	Removeable Seat Cover
Floor Anchor Brackets (Sleigh base only)	153	Removable Back Cover
Springless Seat	117	CAL 133 & Moisture Barrier (per yard)

PRODUCT CODE KEY

Line	Series	Chair Type	Size	Arm Type	Arm Style	Metal Finish	Base Type
FAE	2M	GBH	21	O	PA	S	1
Faeron	Chair	Guest Seating		Open Arm	Polymer Arm	Silver Metallic	Leg Base
			24	C	WA	N	2
				Closed Arm	Wood Arm	Brushed Nickel	Sled Base
			30	2PF	SA		
				Two Panel Fully Closed Arm	Solid Surface Arm		
			44	1PF			
				Single Panel Fully Closed Arm			

FAERON BEHAVIORAL HEALTH | GUEST

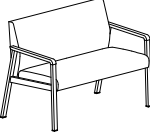
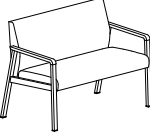
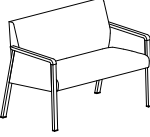
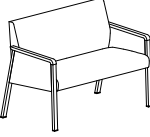
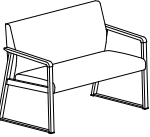
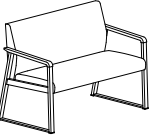
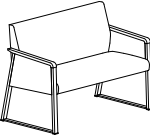
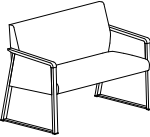
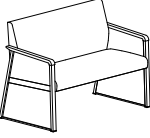
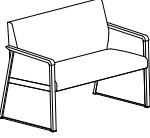
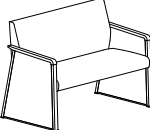
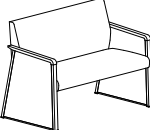
DESCRIPTION/MODEL	COM		COL	FABRIC GRADES			LEATHER		
	1	2	3	4	5	6	7	8	9
	44" Open Polymer Arm, Silver Metallic Leg Base								
	FAE2M-GBH44OPAS1	2203	2286	2370	2536	2703	2869	3036	3202
	44" Open Polymer Arm, Brushed Nickel Leg Base								
	FAE2M-GBH44OPAN1	2409	2491	2575	2741	2908	3075	3242	3408
	44" Closed Polymer Arm, Silver Metallic Leg Base								
	FAE2M-GBH44CPAS1	2646	2753	2859	3071	3284	3497	3710	3922
	44" Closed Polymer Arm, Brushed Nickel Leg Base								
	FAE2M-GBH44CPAN1	2852	2959	3065	3277	3490	3702	3915	4128
	44" Open Polymer Arm, Silver Metallic Sled Base								
	FAE2M-GBH44OPAS2	2337	2420	2504	2670	2837	3004	3171	3337
	44" Open Polymer Arm, Brushed Nickel Sled Base								
	FAE2M-GBH44OPAN2	2543	2626	2710	2876	3043	3210	3377	3542
	44" Closed Polymer Arm, Silver Metallic Sled Base								
	FAE2M-GBH44CPAS2	2780	2888	2994	3206	3419	3631	3844	4056
	44" Closed Polymer Arm, Brushed Nickel Sled Base								
	FAE2M-GBH44CPAN2	2986	3093	3199	3411	3625	3837	4050	4262
	44" Two Panel Fully Closed Polymer Arm, Silver Metallic Sled Base								
	FAE2M-GBH442PPFAS2	2886	3033	3181	3411	3658	3905	4168	4430
	44" Two Panel Fully Closed Polymer Arm, Brushed Nickel Sled Base								
	FAE2M-GBH442PPAN2	3092	3239	3387	3617	3864	4111	4374	4635
	44" Single Panel Fully Closed Polymer Arm, Silver Metallic Sled Base								
	FAE2M-GBH441PPFAS2	3248	3448	3649	3932	4245	4558	4901	5242
	44" Single Panel Fully Closed Polymer Arm, Brushed Nickel Sled Base								
	FAE2M-GBH441PPAN2	3454	3654	3855	4138	4451	4764	5107	5447

ORDERING NOTES: Faeron Metal chairs can be specified with a Wood Arm (WA) or a Solid Surface Arm (SA), replace "PA" in the model number with the **Arm Style** selection below and add the upcharge listed.

Faeron Behavioral Health Option Upcharges	\$ List	\$ List
Solid Surface Arm (per pair) - Gr A White	573	Ganging Bracket
Solid Surface Arm (per pair) - Gr A Color	598	Combination Upholstery - Dual
Solid Surface Arm (per pair) - Gr B	645	Combination Upholstery - Three
Solid Surface Arm (per pair) - Gr C	678	Removeable Seat Cover
Wood Arm (WA) - (per pair)	215	Removable Back Cover
Floor Anchor Brackets (Sleigh base only)	153	CAL 133 & Moisture Barrier (per yard)
Springless Seat	117	

PRODUCT CODE KEY

Line	Series	Chair Type	Size	Arm Type	Arm Style	Metal Finish	Base Type
FAE	2M	GBH	21	O	PA	S	1
Faeron	Chair	Guest Seating		Open Arm	Polymer Arm	Silver Metallic	Leg Base
			24	C	WA	N	2
				Closed Arm	Wood Arm	Brushed Nickel	Sled Base
			30	2PF	SA		
				Two Panel Fully Closed Arm	Solid Surface Arm		
			44	1PF			
				Single Panel Fully Closed Arm			

FAERON BEHAVIORAL HEALTH | ENVIRONMENTAL SUMMARY

LEED CI CREDITS

Patient Seating



Material Content:

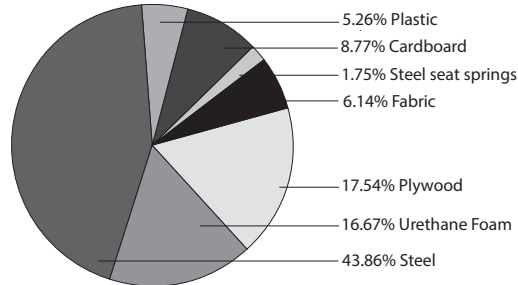

Pre-Consumer Recycled Content = 9.80%

Post-Consumer Recycled Content = 17.63%

Up to 47.06% of this Faeron Metal product is recyclable at the end of its useful life.

CONTRIBUTES TO

CREDIT 2.1 - 2.2	Construction Waste Management	1-2 point(s)
CREDIT 3.3	Resource Reuse	1 point
CREDIT 4.1	Recycled Content	1 point
CREDIT 4.2	Recycled Content	1 point
CREDIT 4.5	Low Emitting Materials, Systems & Seating	1 point
CREDIT 5.1	Regional Materials*	1 point
CREDIT 7	Certified Wood (MUST BE REQUESTED)	1 point(s)

*This credit is only applicable if in total 20% of the combined value of the procurement of construction materials and in the furniture are manufactured within a radius of 500 miles. This credit will apply if the installation of the finished product occurs within 500 miles of Kitchener, Ontario.

level® CERTIFICATION, AIR EMISSIONS AND FSC® CERTIFICATION



level® CERTIFICATION

BIFMA's e3 Furniture Sustainability Standard is a voluntary, multi-attribute standard that measures the degree of sustainability of furniture. This standard evaluates product and company environmental attributes and compliance systems in a wide range of elements which include Materials, Energy & Atmosphere, Human & Ecosystem Health and Social Responsibility. Faeron products have earned level®, BIFMA's sustainability certification program for furniture, certification through third-party verification against the e3 standard.

AIR-EMISSIONS

All Faeron products are supplied with air-emissions certified. Contact customer service for information.



FSC®

In 2005, Krug received Forest Stewardship Council® (FSC®) Chain-of-Custody certification for our manufacturing facilities. The FSC® Chain-of-Custody tracks certified wood from seedling to final sale. It verifies that the material for our FSC certified products only come from well-managed, FSC®-certified forests and other controlled sources. FSC® is dedicated to the promotion of responsible forest management worldwide helping to take care of forests for future generations. Faeron and other Krug products can be specified with FSC® Certification. Contact customer service for further information, pricing and lead times.



Architects, designers, and building professionals can specify FSC®-certified products in order to achieve a point from the US Green Building Council's Leadership in Energy and Environmental Design (LEED) Rating System.

FAERON METAL BEHAVIORAL HEALTH | PATIENT

DIMENSIONS & COM REQUIREMENTS

	Overall Width	Overall Depth	Overall Height	Seat Height	Height of Arms from Floor	Width Between Arms	Seat Depth	Shipping Weight	Cubes
21" Seat	25.0	26.3	45.0	19.0	25	21	19.5	67	17
24" Seat	28.0	26.3	45.0	19.0	25	24	19.5	72	22
30" Seat	34.0	26.3	45.0	19.0	25	30	19.5	85	28

COM - YARDAGE REQUIREMENTS

	COM Yardage Seats & Backs Only	COM Yardage Seat Only	COM Yardage Back Only	COM Yardage Closed Arm Panel	COM Yardage Fully Closed Arm Panel
21" & 24" - One Chair	2.0	0.9	2.0	0.96	3.20
30" Plus - One Chair	3.0	0.9	2.0	0.96	3.20

ORDERING NOTES:

The approval process is as follows:





1. A sample of the COM must be provided to Krug Customer Service prior to or at the time of order.
2. The sample will be reviewed and the customer advised if the fabric is unsuitable.
3. The COM fabric or leather will be inspected when received at the factory, to identify any further concerns with its suitability.

Note: Some vinyls, leathers & upholsteries are not suitable for application on Faeron Metal seating.

COMBINATION UPHOLSTERY OPTION

When combination upholstery is specified with fabric of the same grade or COM, an upcharge for dual fabrics is **\$33 list** per unit and **\$64 list** per unit for three fabrics will be applied. When graded in combination upholstery is selected, use the highest grade upholstery selected or to obtain a quote for blended grading contact Customer Service (please provide the fabrics specified and location of where each fabric is to be applied on the product).

FAERON METAL BEHAVIORAL HEALTH | PATIENT

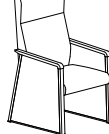
DESCRIPTION/MODEL	COM		COL	FABRIC GRADES			LEATHER				
	1	2	3	4	5	6	7	8	9		
	21" Open Polymer Arm, Silver Metallic Leg Base FAE2M-PBH21OPAS1		1493	1550	1608	1724	1838	1953	2069	2183	2413
	21" Open Polymer Arm, Brushed Nickel Leg Base FAE2M-PBH21OPAN1		1699	1756	1813	1930	2043	2159	2274	2389	2619
	21" Closed Polymer Arm, Silver Metallic Leg Base FAE2M-PBH21CPAS1		1938	2017	2097	2259	2420	2581	2743	2901	3225
	21" Closed Polymer Arm, Brushed Nickel Leg Base FAE2M-PBH21CPAN1		2143	2223	2303	2465	2625	2787	2949	3107	3431
	21" Open Polymer Arm, Silver Metallic Sled Base FAE2M-PBH21OPAS2		1628	1684	1742	1859	1972	2087	2203	2317	2547
	21" Open Polymer Arm, Brushed Nickel Sled Base FAE2M-PBH21OPAN2		1833	1890	1948	2064	2178	2293	2409	2523	2753
	21" Closed Polymer Arm, Silver Metallic Sled Base FAE2M-PBH21CPAS2		2072	2152	2232	2393	2554	2716	2877	3036	3359
	21" Closed Polymer Arm, Brushed Nickel Sled Base FAE2M-PBH21CPAN2		2278	2358	2437	2599	2760	2921	3083	3242	3565
	21" Two Panel Fully Closed Polymer Arm, Silver Metallic Sled Base FAE2M-PBH212PPFAS2		2176	2297	2419	2600	2793	2988	3200	3410	3760
	21" Two Panel Fully Closed Polymer Arm, Brushed Nickel Sled Base FAE2M-PBH212PPFAN2		2382	2503	2625	2805	2999	3194	3406	3616	3966
	21" Single Panel Fully Closed Polymer Arm, Silver Metallic Sled Base FAE2M-PBH211PPFAS2		2538	2712	2887	3121	3380	3641	3933	4222	4672
	21" Single Panel Fully Closed Polymer Arm, Brushed Nickel Sled Base FAE2M-PBH211PPFAN2		2744	2918	3093	3326	3586	3847	4139	4428	4878







ORDERING NOTES: Faeron Metal chairs can be specified with a Wood Arm (WA) or a Solid Surface Arm (SA), replace "PA" in the model number with the **Arm Style** selection below and add the upcharge listed.

Faeron Behavioral Health Option Upcharges	\$ List	\$ List
Kinetic Back	120	Supplemental Weight - 21"
Solid Surface Arm (per pair) - Gr A White	573	Supplemental Weight - 24"
Solid Surface Arm (per pair) - Gr A Color	598	Ganging Bracket
Solid Surface Arm (per pair) - Gr B	645	Combination Upholstery - Dual
Solid Surface Arm (per pair) - Gr C	678	Combination Upholstery - Three
Wood Arm (WA) - (per pair)	215	Removeable Seat Cover
Floor Anchor Brackets (Sleigh base only)	153	Removeable Back Cover
Springless Seat	117	CAL 133 & Moisture Barrier (per yard)

PRODUCT CODE KEY

Line	Series	Chair Type	Size	Arm Type	Arm Style	Metal Finish	Base Type
<input type="text" value="FAE"/>	<input type="text" value="2M"/>	<input type="text" value="PBH"/>	<input type="text" value="21"/>	<input type="text" value="O"/>	<input type="text" value="PA"/>	<input type="text" value="S"/>	<input type="text" value="1"/>
Faeron	Chair	Patient Seating		Open Arm	Polymer Arm	Silver Metallic	Leg Base
			<input type="text" value="24"/>	<input type="text" value="C"/>	<input type="text" value="WA"/>	<input type="text" value="N"/>	<input type="text" value="2"/>
				Closed Arm	Wood Arm	Brushed Nickel	Sled Base
			<input type="text" value="30"/>	<input type="text" value="2PF"/>	<input type="text" value="SA"/>		
				Two Panel Fully Closed Arm	Solid Surface Arm		
				<input type="text" value="1PF"/>			
				Single Panel Fully Closed Arm			

FAERON METAL BEHAVIORAL HEALTH | PATIENT

DESCRIPTION/MODEL	COM		COL	FABRIC GRADES			LEATHER				
	1	2	3	4	5	6	7	8	9		
	24" Open Polymer Arm, Silver Metallic Leg Base FAE2M-PBH24OPAS1		1582	1640	1698	1812	1927	2043	2158	2273	2502
	24" Open Polymer Arm, Brushed Nickel Leg Base FAE2M-PBH24OPAN1		1788	1846	1904	2018	2133	2249	2364	2479	2708
	24" Closed Polymer Arm, Silver Metallic Leg Base FAE2M-PBH24CPAS1		2027	2109	2188	2349	2511	2671	2832	2993	3315
	24" Closed Polymer Arm, Brushed Nickel Leg Base FAE2M-PBH24CPAN1		2233	2315	2393	2555	2717	2876	3038	3199	3521
	24" Open Polymer Arm, Silver Metallic Sled Base FAE2M-PBH24OPAS2		1717	1775	1832	1947	2061	2178	2292	2408	2637
	24" Open Polymer Arm, Brushed Nickel Sled Base FAE2M-PBH24OPAN2		1923	1980	2038	2153	2267	2384	2498	2614	2842
	24" Closed Polymer Arm, Silver Metallic Sled Base FAE2M-PBH24CPAS2		2161	2243	2322	2484	2645	2805	2967	3127	3450
	24" Closed Polymer Arm, Brushed Nickel Sled Base FAE2M-PBH24CPAN2		2367	2449	2528	2689	2851	3011	3172	3333	3655
	24" Two Panel Fully Closed Polymer Arm, Silver Metallic Sled Base FAE2M-PBH242PPFAS2		2266	2388	2509	2688	2882	3079	3289	3501	3850
	24" Two Panel Fully Closed Polymer Arm, Brushed Nickel Sled Base FAE2M-PBH242PPAN2		2472	2593	2715	2894	3088	3285	3495	3707	4055
	24" Single Panel Fully Closed Polymer Arm, Silver Metallic Sled Base FAE2M-PBH241PPFAS2		2628	2803	2977	3209	3469	3732	4022	4313	4762
	24" Single Panel Fully Closed Polymer Arm, Brushed Nickel Sled Base FAE2M-PBH241PPFAN2		2834	3008	3183	3415	3675	3938	4228	4519	4967







ORDERING NOTES: Faeron Metal chairs can be specified with a Wood Arm (WA) or a Solid Surface Arm (SA), replace "PA" in the model number with the **Arm Style** selection below and add the upcharge listed.

Faeron Behavioral Health Option Upcharges	\$ List	\$ List
Kinetic Back	120	Supplemental Weight - 21"
Solid Surface Arm (per pair) - Gr A White	573	Supplemental Weight - 24"
Solid Surface Arm (per pair) - Gr A Color	598	Ganging Bracket
Solid Surface Arm (per pair) - Gr B	645	Combination Upholstery - Dual
Solid Surface Arm (per pair) - Gr C	678	Combination Upholstery - Three
Wood Arm (WA) - (per pair)	215	Removeable Seat Cover
Floor Anchor Brackets (Sleigh base only)	153	Removable Back Cover
Springless Seat	117	CAL 133 & Moisture Barrier (per yard)

PRODUCT CODE KEY

Line	Series	Chair Type	Size	Arm Type	Arm Style	Metal Finish	Base Type
FAE	2M	PBH	21	O	PA	S	1
Faeron	Chair	Patient Seating		Open Arm	Polymer Arm	Silver Metallic	Leg Base
			24	C	WA	N	2
				Closed Arm	Wood Arm	Brushed Nickel	Sled Base
			30	2PF	SA		
				Two Panel Fully Closed Arm	Solid Surface Arm		
				1PF			
				Single Panel Fully Closed Arm			

FAERON METAL BEHAVIORAL HEALTH | PATIENT

DESCRIPTION/MODEL	COM		COL	FABRIC GRADES			LEATHER				
	1	2	3	4	5	6	7	8	9		
	30" Open Polymer Arm, Silver Metallic Leg Base FAE2M-PBH30OPAS1		1848	1935	2020	2193	2366	2538	2711	2884	3227
	30" Open Polymer Arm, Brushed Nickel Leg Base FAE2M-PBH30OPAN1		2053	2141	2226	2399	2572	2744	2916	3090	3433
	30" Closed Polymer Arm, Silver Metallic Leg Base FAE2M-PBH30CPAS1		2292	2403	2510	2730	2946	3167	3385	3603	4039
	30" Closed Polymer Arm, Brushed Nickel Leg Base FAE2M-PBH30CPAN1		2498	2609	2716	2936	3152	3372	3591	3809	4245
	30" Open Polymer Arm, Silver Metallic Sled Base FAE2M-PBH30OPAS2		1982	2069	2154	2327	2501	2673	2845	3018	3362
	30" Open Polymer Arm, Brushed Nickel Sled Base FAE2M-PBH30OPAN2		2188	2275	2360	2533	2706	2879	3051	3224	3567
	30" Closed Polymer Arm, Silver Metallic Sled Base FAE2M-PBH30CPAS2		2426	2538	2645	2864	3080	3301	3519	3738	4174
	30" Closed Polymer Arm, Brushed Nickel Sled Base FAE2M-PBH30CPAN2		2632	2743	2851	3070	3286	3507	3725	3944	4379
	30" Two Panel Fully Closed Polymer Arm, Silver Metallic Sled Base FAE2M-PBH302PFPAS2		2531	2682	2831	3068	3322	3574	3842	4111	4575
	30" Two Panel Fully Closed Polymer Arm, Brushed Nickel Sled Base FAE2M-PBH302PFPAN2		2737	2888	3037	3274	3527	3780	4048	4317	4780
	30" Single Panel Fully Closed Polymer Arm, Silver Metallic Sled Base FAE2M-PBH301PFPAS2		2893	3097	3299	3589	3909	4227	4575	4923	5487
	30" Single Panel Fully Closed Polymer Arm, Brushed Nickel Sled Base FAE2M-PBH301PFPAN2		3099	3303	3505	3795	4114	4433	4781	5129	5692

ORDERING NOTES: Faeron Metal chairs can be specified with a Wood Arm (WA) or a Solid Surface Arm (SA), replace "PA" in the model number with the **Arm Style** selection below and add the upcharge listed.

Faeron Behavioral Health Option Upcharges	\$ List	\$ List
Solid Surface Arm (per pair) - Gr A White	573	Supplemental Weight - 30"
Solid Surface Arm (per pair) - Gr A Color	598	Ganging Bracket
Solid Surface Arm (per pair) - Gr B	645	Combination Upholstery - Dual
Solid Surface Arm (per pair) - Gr C	678	Combination Upholstery - Three
Wood Arm (WA) - (per pair)	215	Removeable Seat Cover
Floor Anchor Brackets (Sleigh base only)	153	Removeable Back Cover
Springless Seat	117	CAL 133 & Moisture Barrier (per yard)

PRODUCT CODE KEY

Line	Series	Chair Type	Size	Arm Type	Arm Style	Metal Finish	Base Type
FAE	2M	PBH	21	O	PA	S	1
Faeron	Chair	Patient Seating		Open Arm	Polymer Arm	Silver Metallic	Leg Base
			24	C	WA	N	2
				Closed Arm	Wood Arm	Brushed Nickel	Sled Base
			30	2PF	SA		
				Two Panel Fully Closed Arm	Solid Surface Arm		
				1PF			
				Single Panel Fully Closed Arm			

FAERON METAL BEHAVIORAL HEALTH | MULTIPLE SEATING - START, CENTER & END UNITS

DIMENSIONS & COM REQUIREMENTS

FAERON METAL MULTIPLE START UNITS

	Overall Width	Overall Depth	Overall Height	Seat Height	Height of Arms from Floor	Width Between Arms	Seat Depth	Shipping Weight	Cube	COM Seat & Back Yardage	COM Fabric Seat Yardage	COM Fabric Back Yardage	COM Fabric Closed Arm Panel (Pair) Yardage	COM Fabric Fully Closed Arm Panel Yardage
SG21	25	26.3	34.5	19	25	21	19.5	62	14	1.6	0.9	1.4	0.96	3.20
SP21	25	26.3	45	19	25	21	19.5	67	17	2.0	0.9	2.0	0.96	3.20
SG24	28	26.3	34.5	19	25	24	19.5	67	19	1.6	0.9	1.4	0.96	3.20
SP24	28	26.3	45	19	25	24	19.5	72	22	2.0	0.9	2.0	0.96	3.20
SG30	34	26.3	34.5	19	25	30	19.5	75	20	2.3	0.9	1.4	0.96	3.20
SP30	34	26.3	45	19	25	30	19.5	85	28	3.0	0.9	2.0	0.96	3.20
SG44	48	26.3	34.5	19	25	44	19.5	96	28	2.9	0.9	1.6	0.96	3.20

FAERON METAL MULTIPLE CENTER UNITS

	Overall Width	Overall Depth	Overall Height	Seat Height	Height of Arms from Floor	Width Between Arms	Seat Depth	Shipping Weight	Cube	COM Seat & Back Yardage	COM Fabric Seat Yardage	COM Fabric Back Yardage	COM Fabric Closed Arm Panel Yardage	COM Fabric Fully Closed Arm Panel YDG
CG21	23	26.3	34.5	19	25	21	19.5	52	14	1.6	0.9	1.4	0.48	1.6
CP21	23	26.3	45	19	25	21	19.5	57	17	2.0	0.9	2.0	0.48	1.6
CG24	26	26.3	34.5	19	25	24	19.5	57	19	1.6	0.9	1.4	0.48	1.6
CP24	26	26.3	45	19	25	24	19.5	62	22	2.0	0.9	2.0	0.48	1.6
CG30	32	26.3	34.5	19	25	30	19.5	65	20	2.3	0.9	1.4	0.48	1.6
CP30	32	26.3	45	19	25	30	19.5	75	28	3.0	0.9	2.0	0.48	1.6
CG44	46	26.3	34.5	19	25	44	19.5	86	28	2.9	0.9	1.6	0.48	1.6

FAERON METAL MULTIPLE END UNITS

	Overall Width	Overall Depth	Overall Height	Seat Height	Height of Arms from Floor	Width Between Arms	Seat Depth	Shipping Weight	Cube	COM Seat & Back Yardage	COM Fabric Seat Yardage	COM Fabric Back Yardage	COM Fabric Closed Arm Panel Ydg	COM Fabric Fully Closed Arm Panel YDG
EG21	23	26.3	34.5	19	25	21	19.5	52	14	1.6	0.9	1.4	0.48	1.6
EP21	23	26.3	45	19	25	21	19.5	57	17	2.0	0.9	2.0	0.48	1.6
EG24	26	26.3	34.5	19	25	24	19.5	57	19	1.6	0.9	1.4	0.48	1.6
EP24	26	26.3	45	19	25	24	19.5	62	22	2.0	0.9	2.0	0.48	1.6
EG30	32	26.3	34.5	19	25	30	19.5	65	20	2.3	0.9	1.4	0.48	1.6
EP30	32	26.3	45	19	25	30	19.5	75	28	3.0	0.9	2.0	0.48	1.6
EG44	46	26.3	34.5	19	25	44	19.5	86	28	2.9	0.9	1.6	0.48	1.6

ORDERING NOTES:

A drawing showing the configuration of the multiple seating and tables is required with each purchase order.

Combination Upholstery Option

When combination upholstery is specified with fabric of the same grade or COM, an upcharge for dual fabrics is \$32 list per unit and \$61 list per unit for three fabrics will be applied. When graded in combination upholstery is selected, use the highest grade upholstery selected or to obtain a quote for blended grading contact Customer Service (please provide the fabrics specified and location of where each fabric is to be applied on the product).

Faeron Behavioral Health Option Upcharges	\$ List	\$ List	
Kinetic Back	120	Floor Anchor Brackets (Sleigh base only)	153
Solid Surface Arm (each) - Gr A White	287	Springless Seat	117
Solid Surface Arm (each) - Gr A Color	299	Supplemental Weight - 21"	390
Solid Surface Arm (each) - Gr B	321	Supplemental Weight - 24"	321
Solid Surface Arm (each) - Gr C	339	Ganging Bracket	56
Wood Arm (WA) (each)	108	Combination Upholstery - Dual	32
Solid Surface Arm (per pair) - Gr A White	573	Combination Upholstery - Three	61
Solid Surface Arm (per pair) - Gr A Color	598	Removeable Seat Cover (per seat)	86
Solid Surface Arm (per pair) - Gr B	645	Removable Back Cover (per back)	56
Solid Surface Arm (per pair) - Gr C	678	CAL 133 & Moisture Barrier (per yard)	61
Wood Arm (WA) - (per pair)	215		

Patient backs are available on multiple units, please change the model number FAE2M-SGBH to FAE2M-SPBH, and add the following upcharges per back:

Grade 1	Grade 2	Grade 3	Grade 4	Grade 5	Grade 6	Grade 7	Grade 8	Grade 9
---------	---------	---------	---------	---------	---------	---------	---------	---------

WEIGHT CAPACITIES

Faeron weight capacities are as follows:
Guest & Patient Chairs (21" & 24") - 500 lbs

FAERON METAL BEHAVIORAL HEALTH | MULTIPLE SEATING - START, CENTER & END UNITS

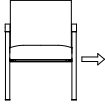
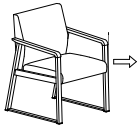
DESCRIPTION/MODEL	COM		COL		FABRIC GRADES			LEATHER										
	1	2	3	4	5	6	7	8	9									
Start - Leg Base 	21" Open Polymer Arm Start Unit, Guest Back, Silver Metallic Leg Base FAE2M-SGBH21OPAS1									1436	1482	1528	1620	1712	1804	1897	1988	2171
	21" Open Polymer Arm Start Unit, Guest Back, Brushed Nickel Leg Base FAE2M-SGBH21OPAN1									1642	1687	1734	1826	1917	2010	2103	2194	2377
	21" Closed Polymer Arm Start Unit, Guest Back, Silver Metallic Leg Base FAE2M-SGBH21CPAS1									1880	1949	2018	2157	2295	2431	2571	2708	2984
	21" Closed Polymer Arm Start Unit, Guest Back, Brushed Nickel Leg Base FAE2M-SGBH21CPAN1									2086	2155	2224	2363	2500	2637	2777	2914	3190
Start - Sled Base 	21" Open Polymer Arm Start Unit, Guest Back, Silver Metallic Sled Base FAE2M-SGBH21OPAS2									1571	1616	1662	1755	1846	1938	2032	2122	2306
	21" Open Polymer Arm Start Unit, Guest Back, Brushed Nickel Sled Base FAE2M-SGBH21OPAN2									1777	1822	1868	1960	2052	2144	2238	2328	2512
	21" Closed Polymer Arm Start Unit, Guest Back, Silver Metallic Sled Base FAE2M-SGBH21CPAS2									2014	2084	2153	2291	2429	2565	2705	2843	3119
	21" Closed Polymer Arm Start Unit, Guest Back, Brushed Nickel Sled Base FAE2M-SGBH21CPAN2									2220	2289	2359	2497	2635	2771	2911	3048	3325
	21" Two Panel Fully Closed Polymer Arm Start Unit, Guest Back, Silver Metallic Sled Base FAE2M-SGBH212PPFAS2									2120	2229	2339	2496	2667	2839	3029	3215	3519
	21" Two Panel Fully Closed Polymer Arm Start Unit, Guest Back, Brushed Nickel Sled Base FAE2M-SGBH212PPAN2									2326	2435	2545	2701	2873	3045	3235	3421	3725
	21" Single Panel Fully Closed Polymer Arm Start Unit, Guest Back, Silver Metallic Sled Base FAE2M-SGBH211PPFAS2									2482	2644	2807	3017	3254	3492	3762	4027	4431
	21" Single Panel Fully Closed Polymer Arm Start Unit, Guest Back, Brushed Nickel Sled Base FAE2M-SGBH211PPAN2									2688	2850	3013	3222	3460	3698	3968	4233	4637

ORDERING NOTES: Faeron Metal chairs can be specified with a Wood Arm (WA) or a Solid Surface Arm (SA), replace "PA" in the model number with the **Arm Style** selection below and add the upcharge listed. **Patient backs** are available on multiple units, please change the model number FAE2M-SGBH to FAE2M-SPBH, and add the upcharges on page 449 per back.

Faeron Behavioral Health Option Upcharges	\$ List	\$ List
Kinetic Back	115	Supplemental Weight - 21"
Solid Surface Arm (per pair) - Gr A White	546	Supplemental Weight - 24"
Solid Surface Arm (per pair) - Gr A Color	570	Ganging Bracket
Solid Surface Arm (per pair) - Gr B	615	Combination Upholstery - Dual
Solid Surface Arm (per pair) - Gr C	646	Combination Upholstery - Three
Wood Arm (WA) - (per pair)	205	Removeable Seat Cover (per seat)
Floor Anchor Brackets (Sleigh base only)	153	Removable Back Cover (per back)
Springless Seat	117	CAL 133 & Moisture Barrier (per yard)

PRODUCT CODE KEY

Line	Series	Chair Type	Size	Arm Type	Arm Style	Metal Finish	Base Type
FAE	2M	SGBH	21	O	PA	S	1
Faeron	Chair	Start-Guest Seating		Open Arm	Polymer Arm	Silver Metallic	Leg Base
		CGBH	24	C	WA	N	2
		Center-Guest Seating		Closed Arm	Wood Arm	Brushed Nickel	Sled Base
		EGBH	30	2PF	SA		
		End-Guest Seating		Two Panel Fully Closed Arm	Solid Surface Arm		
			44	1PF			
				Single Panel Fully Closed Arm			

FAERON METAL BEHAVIORAL HEALTH | MULTIPLE SEATING - START, CENTER & END UNITS

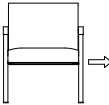
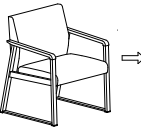
DESCRIPTION/MODEL	COM		COL	FABRIC GRADES			LEATHER											
	1	2	3	4	5	6	7	8	9									
Start - Leg Base 	24" Open Polymer Arm Start Unit, Guest Back, Silver Metallic Leg Base FAE2M-SGBH24OPAS1									1540	1587	1633	1724	1818	1907	2000	2092	2275
	24" Open Polymer Arm Start Unit, Guest Back, Brushed Nickel Leg Base FAE2M-SGBH24OPAN1									1746	1792	1839	1930	2023	2113	2206	2298	2481
	24" Closed Polymer Arm Start Unit, Guest Back, Silver Metallic Leg Base FAE2M-SGBH24CPAS1									1985	2053	2122	2260	2398	2536	2675	2812	3088
	24" Closed Polymer Arm Start Unit, Guest Back, Brushed Nickel Leg Base FAE2M-SGBH24CPAN1									2191	2259	2328	2466	2603	2742	2881	3018	3294
Start - Sled Base 	24" Open Polymer Arm Start Unit, Guest Back, Silver Metallic Sled Base FAE2M-SGBH24OPAS2									1675	1721	1767	1859	1952	2041	2135	2226	2410
	24" Open Polymer Arm Start Unit, Guest Back, Brushed Nickel Sled Base FAE2M-SGBH24OPAN2									1881	1927	1973	2064	2158	2247	2341	2432	2616
	24" Closed Polymer Arm Start Unit, Guest Back, Silver Metallic Sled Base FAE2M-SGBH24CPAS2									2119	2187	2257	2394	2532	2670	2809	2947	3223
	24" Closed Polymer Arm Start Unit, Guest Back, Brushed Nickel Sled Base FAE2M-SGBH24CPAN2									2325	2393	2463	2600	2738	2876	3015	3152	3429
	24" Two Panel Fully Closed Polymer Arm Start Unit, Guest Back, Silver Metallic Sled Base FAE2M-SGBH242PPFAS2									2224	2334	2444	2600	2773	2942	3132	3319	3623
	24" Two Panel Fully Closed Polymer Arm Start Unit, Guest Back, Brushed Nickel Sled Base FAE2M-SGBH242PPAN2									2430	2540	2650	2805	2979	3148	3338	3525	3829
	24" Single Panel Fully Closed Polymer Arm Start Unit, Guest Back, Silver Metallic Sled Base FAE2M-SGBH241PPFAS2									2586	2749	2912	3121	3360	3595	3865	4131	4535
	24" Single Panel Fully Closed Polymer Arm Start Unit, Guest Back, Brushed Nickel Sled Base FAE2M-SGBH241PPAN2									2792	2955	3118	3326	3566	3801	4071	4337	4741

ORDERING NOTES: Faeron Metal chairs can be specified with a Wood Arm (WA) or a Solid Surface Arm (SA), replace "PA" in the model number with the **Arm Style** selection below and add the upcharge listed. **Patient backs** are available on multiple units, please change the model number FAE2M-SGBH to FAE2M-SPBH, and add the upcharges on page 449 per back.

Faeron Behavioral Health Option Upcharges	\$ List	\$ List
Kinetic Back	115	Supplemental Weight - 21" 390
Solid Surface Arm (per pair) - Gr A White	546	Supplemental Weight - 24" 321
Solid Surface Arm (per pair) - Gr A Color	570	Ganging Bracket 56
Solid Surface Arm (per pair) - Gr B	615	Combination Upholstery - Dual 32
Solid Surface Arm (per pair) - Gr C	646	Combination Upholstery - Three 61
Wood Arm (WA) - (per pair)	205	Removeable Seat Cover (per seat) 86
Floor Anchor Brackets (Sleigh base only)	153	Removable Back Cover (per back) 56
Springless Seat	117	CAL 133 & Moisture Barrier (per yard) 61

PRODUCT CODE KEY

Line	Series	Chair Type	Size	Arm Type	Arm Style	Metal Finish	Base Type
FAE	2M	SGBH	21	O	PA	S	1
Faeron	Chair	Start-Guest Seating		Open Arm	Polymer Arm	Silver Metallic	Leg Base
		CGBH	24	C	WA	N	2
		Center-Guest Seating		Closed Arm	Wood Arm	Brushed Nickel	Sled Base
		EGBH	30	2PF	SA		
		End-Guest Seating		Two Panel Fully Closed Arm	Solid Surface Arm		
			44	1PF			
				Single Panel Fully Closed Arm			

FAERON METAL BEHAVIORAL HEALTH | MULTIPLE SEATING - START, CENTER & END UNITS

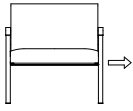
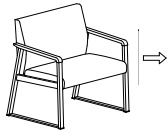
DESCRIPTION/MODEL	COM		COL	FABRIC GRADES			LEATHER											
	1	2	3	4	5	6	7	8	9									
Start - Leg Base 	30" Open Polymer Arm Start Unit, Guest Back, Silver Metallic Leg Base FAE2M-SGBH30OPAS1									1780	1845	1913	2044	2176	2310	2441	2573	2839
	30" Open Polymer Arm Start Unit, Guest Back, Brushed Nickel Leg Base FAE2M-SGBH30OPAN1									1986	2051	2118	2250	2382	2515	2647	2779	3045
	30" Closed Polymer Arm Start Unit, Guest Back, Silver Metallic Leg Base FAE2M-SGBH30CPAS1									2225	2313	2403	2581	2758	2937	3114	3294	3651
	30" Closed Polymer Arm Start Unit, Guest Back, Brushed Nickel Leg Base FAE2M-SGBH30CPAN1									2431	2519	2609	2787	2964	3142	3320	3499	3856
Start - Sled Base 	30" Open Polymer Arm Start Unit, Guest Back, Silver Metallic Sled Base FAE2M-SGBH30OPAS2									1915	1980	2047	2178	2311	2444	2575	2708	2973
	30" Open Polymer Arm Start Unit, Guest Back, Brushed Nickel Sled Base FAE2M-SGBH30OPAN2									2121	2186	2253	2384	2516	2650	2781	2913	3179
	30" Closed Polymer Arm Start Unit, Guest Back, Silver Metallic Sled Base FAE2M-SGBH30CPAS2									2359	2447	2538	2715	2893	3071	3248	3428	3785
	30" Closed Polymer Arm Start Unit, Guest Back, Brushed Nickel Sled Base FAE2M-SGBH30CPAN2									2565	2653	2743	2921	3098	3277	3454	3634	3991
	30" Two Panel Fully Closed Polymer Arm Start Unit, Guest Back, Silver Metallic Sled Base FAE2M-SGBH302PPFAS2									2464	2593	2724	2919	3132	3345	3572	3801	4186
	30" Two Panel Fully Closed Polymer Arm Start Unit, Guest Back, Brushed Nickel Sled Base FAE2M-SGBH302PPAN2									2669	2799	2930	3125	3337	3551	3778	4006	4392
	30" Single Panel Fully Closed Polymer Arm Start Unit, Guest Back, Silver Metallic Sled Base FAE2M-SGBH301PPFAS2									2826	3008	3192	3440	3719	3998	4305	4613	5098
30" Single Panel Fully Closed Polymer Arm Start Unit, Guest Back, Brushed Nickel Sled Base FAE2M-SGBH301PPAN2									3031	3214	3398	3646	3924	4204	4511	4818	5304	

ORDERING NOTES: Faeron Metal chairs can be specified with a Wood Arm (WA) or a Solid Surface Arm (SA), replace "PA" in the model number with the **Arm Style** selection below and add the upcharge listed. **Patient backs** are available on multiple units, please change the model number FAE2M-SGBH to FAE2M-SPBH, and add the upcharges on page 449 per back.

Faeron Behavioral Health Option Upcharges	\$ List	\$ List
Solid Surface Arm (per pair) - Gr A White	546	Supplemental Weight - 30"
Solid Surface Arm (per pair) - Gr A Color	570	Ganging Bracket
Solid Surface Arm (per pair) - Gr B	615	Combination Upholstery - Dual
Solid Surface Arm (per pair) - Gr C	646	Combination Upholstery - Three
Wood Arm (WA) - (per pair)	205	Removeable Seat Cover (per seat)
Floor Anchor Brackets (Sleigh base only)	153	Removeable Back Cover (per back)
Springless Seat	117	CAL 133 & Moisture Barrier (per yard)

PRODUCT CODE KEY

Line	Series	Chair Type	Size	Arm Type	Arm Style	Metal Finish	Base Type
FAE	2M	SGBH	21	O	PA	S	1
Faeron	Chair	Start-Guest Seating		Open Arm	Polymer Arm	Silver Metallic	Leg Base
		CGBH	24	C	WA	N	2
		Center-Guest Seating		Closed Arm	Wood Arm	Brushed Nickel	Sled Base
		EGBH	30	2PF	SA		
		End-Guest Seating		Two Panel Fully Closed Arm	Solid Surface Arm		
			44	1PF			
				Single Panel Fully Closed Arm			

FAERON METAL BEHAVIORAL HEALTH | MULTIPLE SEATING - START, CENTER & END UNITS

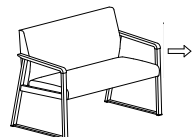
DESCRIPTION/MODEL	COM		COL	FABRIC GRADES			LEATHER			
	1	2	3	4	5	6	7	8	9	
 Start	44" Open Polymer Arm Start Unit, Guest Back, Silver Metallic Leg Base									
	FAE2M-SGBH44OPAS1	2203	2286	2370	2536	2703	2869	3036	3202	3536
	44" Open Polymer Arm Start Unit, Guest Back, Brushed Nickel Leg Base									
	FAE2M-SGBH44OPAN1	2409	2491	2575	2741	2908	3075	3242	3408	3742
44" Closed Polymer Arm Start Unit, Guest Back, Silver Metallic Leg Base										
FAE2M-SGBH44CPAS1	2646	2753	2859	3071	3284	3497	3710	3922	4348	
44" Closed Polymer Arm Start Unit, Guest Back, Brushed Nickel Leg Base										
FAE2M-SGBH44CPAN1	2852	2959	3065	3277	3490	3702	3915	4128	4554	
 Start - Sled Base	44" Open Polymer Arm Start Unit, Guest Back, Silver Metallic Sled Base									
	FAE2M-SGBH44OPAS2	2337	2420	2504	2670	2837	3004	3171	3337	3671
	44" Open Polymer Arm Start Unit, Guest Back, Brushed Nickel Sled Base									
	FAE2M-SGBH44OPAN2	2543	2626	2710	2876	3043	3210	3377	3542	3876
	44" Closed Polymer Arm Start Unit, Guest Back, Silver Metallic Sled Base									
	FAE2M-SGBH44CPAS2	2780	2888	2994	3206	3419	3631	3844	4056	4482
	44" Closed Polymer Arm Start Unit, Guest Back, Brushed Nickel Sled Base									
	FAE2M-SGBH44CPAN2	2986	3093	3199	3411	3625	3837	4050	4262	4688
44" Two Panel Fully Closed Polymer Arm Start Unit, Guest Back, Silver Metallic Sled Base										
FAE2M-SGBH442PPFAS2	2886	3033	3181	3411	3658	3905	4168	4430	4884	
44" Two Panel Fully Closed Polymer Arm Start Unit, Guest Back, Brushed Nickel Sled Base										
FAE2M-SGBH442PPAN2	3092	3239	3387	3617	3864	4111	4374	4635	5089	
44" Single Panel Fully Closed Polymer Arm Start Unit, Guest Back, Silver Metallic Sled Base										
FAE2M-SGBH441PPFAS2	3248	3448	3649	3932	4245	4558	4901	5242	5796	
44" Single Panel Fully Closed Polymer Arm Start Unit, Guest Back, Brushed Nickel Sled Base										
FAE2M-SGBH441PPAN2	3454	3654	3855	4138	4451	4764	5107	5447	6001	

ORDERING NOTES: Faeron Metal chairs can be specified with a Wood Arm (WA) or a Solid Surface Arm (SA), replace "PA" in the model number with the **Arm Style** selection below and add the upcharge listed. **Patient backs** are available on multiple units, please change the model number FAE2M-SGBH to FAE2M-SPBH, and add the upcharges on page 449 per back.

Faeron Behavioral Health Option Upcharges	\$ List	\$ List
Solid Surface Arm (per pair) - Gr A White	546	Ganging Bracket
Solid Surface Arm (per pair) - Gr A Color	570	Combination Upholstery - Dual
Solid Surface Arm (per pair) - Gr B	615	Combination Upholstery - Three
Solid Surface Arm (per pair) - Gr C	646	Removeable Seat Cover (per seat)
Wood Arm (WA) - (per pair)	205	Removeable Back Cover (per back)
Floor Anchor Brackets (Sleigh base only)	153	CAL 133 & Moisture Barrier (per yard)
Springless Seat	117	

PRODUCT CODE KEY

Line	Series	Chair Type	Size	Arm Type	Arm Style	Metal Finish	Base Type
FAE	2M	SGBH	21	O	PA	S	1
Faeron	Chair	Start-Guest Seating		Open Arm	Polymer Arm	Silver Metallic	Leg Base
		CGBH	24	C	WA	N	2
		Center-Guest Seating		Closed Arm	Wood Arm	Brushed Nickel	Sled Base
		EGBH	30	2PF	SA		
		End-Guest Seating		Two Panel Fully Closed Arm	Solid Surface Arm		
			44	1PF			
				Single Panel Fully Closed Arm			

FAERON METAL BEHAVIORAL HEALTH | MULTIPLE SEATING - START, CENTER & END UNITS

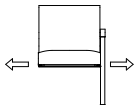
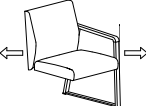
DESCRIPTION/MODEL	COM		COL	FABRIC GRADES			LEATHER											
	1	2	3	4	5	6	7	8	9									
 Center - Leg Base	21" Open Polymer Arm Center Unit, Guest Back, Silver Metallic Leg Base FAE2M-CGBH21OPAS1									1363	1409	1457	1548	1640	1733	1823	1916	2099
	21" Open Polymer Arm Center Unit, Guest Back, Brushed Nickel Leg Base FAE2M-CGBH21OPAN1									1569	1615	1663	1754	1846	1939	2029	2121	2305
	21" Closed Polymer Arm Center Unit, Guest Back, Silver Metallic Leg Base FAE2M-CGBH21CPAS1									1624	1683	1739	1855	1970	2084	2199	2313	2544
	21" Closed Polymer Arm Center Unit, Guest Back, Brushed Nickel Leg Base FAE2M-CGBH21CPAN1									1830	1888	1945	2061	2176	2290	2405	2518	2749
 Center - Sled Base	21" Open Polymer Arm Center Unit, Guest Back, Silver Metallic Sled Base FAE2M-CGBH21OPAS2									1435	1481	1529	1620	1712	1805	1895	1988	2171
	21" Open Polymer Arm Center Unit, Guest Back, Brushed Nickel Sled Base FAE2M-CGBH21OPAN2									1641	1687	1735	1826	1918	2011	2101	2193	2377
	21" Closed Polymer Arm Center Unit, Guest Back, Silver Metallic Sled Base FAE2M-CGBH21CPAS2									1696	1755	1811	1927	2042	2156	2271	2385	2616
	21" Closed Polymer Arm Center Unit, Guest Back, Brushed Nickel Sled Base FAE2M-CGBH21CPAN2									1902	1960	2017	2133	2248	2362	2477	2590	2821
	21" Two Panel Fully Closed Polymer Arm Center Unit, Guest Back, Silver Metallic Sled Base FAE2M-CGBH212PPFAS2									1710	1788	1867	1991	2123	2255	2394	2534	2778
	21" Two Panel Fully Closed Polymer Arm Center Unit, Guest Back, Brushed Nickel Sled Base FAE2M-CGBH212PPFAN2									1916	1994	2073	2196	2329	2461	2599	2740	2984
	21" Single Panel Fully Closed Polymer Arm Center Unit, Guest Back, Silver Metallic Sled Base FAE2M-CGBH211PPFAS2									1891	1995	2101	2251	2416	2582	2760	2940	3234
	21" Single Panel Fully Closed Polymer Arm Center Unit, Guest Back, Brushed Nickel Sled Base FAE2M-CGBH211PPFAN2									2097	2201	2307	2456	2622	2788	2965	3146	3440



ORDERING NOTES: Faeron Metal chairs can be specified with a Wood Arm (WA) or a Solid Surface Arm (SA), replace "PA" in the model number with the **Arm Style** selection below and add the upcharge listed. **Patient backs** are available on multiple units, please change the model number FAE2M-SGBH to FAE2M-SPBH, and add the upcharges on page 449 per back.

Faeron Behavioral Health Option Upcharges	\$ List	\$ List
Kinetic Back	115	Supplemental Weight - 21"
Solid Surface Arm (each) - Gr A White	274	Supplemental Weight - 24"
Solid Surface Arm (each) - Gr A Color	285	Ganging Bracket
Solid Surface Arm (each) - Gr B	306	Combination Upholstery - Dual
Solid Surface Arm (each) - Gr C	323	Combination Upholstery - Three
Wood Arm (WA) - (per pair)	205	Removeable Seat Cover (per seat)
Floor Anchor Brackets (Sleigh base only)	153	Removeable Back Cover (per back)
Springless Seat	117	CAL 133 & Moisture Barrier (per yard)

PRODUCT CODE KEY

Line	Series	Chair Type	Size	Arm Type	Arm Style	Metal Finish	Base Type
FAE	2M	SGBH	21	O	PA	S	1
Faeron	Chair	Start-Guest Seating		Open Arm	Polymer Arm	Silver Metallic	Leg Base
		CGBH	24	C	WA	N	2
		Center-Guest Seating		Closed Arm	Wood Arm	Brushed Nickel	Sled Base
		EGBH	30	2PF	SA		
		End-Guest Seating		Two Panel Fully Closed Arm	Solid Surface Arm		
			44	1PF			
				Single Panel Fully Closed Arm			

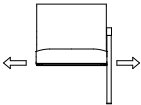
FAERON METAL BEHAVIORAL HEALTH | MULTIPLE SEATING - START, CENTER & END UNITS

DESCRIPTION/MODEL	COM		COL		FABRIC GRADES			LEATHER		
	1	2	3	4	5	6	7	8	9	
 <p>Center - Leg Base</p>	24" Open Polymer Arm Center Unit, Guest Back, Silver Metallic Leg Base									
	FAE2M-CGBH24OPAS1	1468	1512	1559	1652	1742	1836	1927	2020	2203
	24" Open Polymer Arm Center Unit, Guest Back, Brushed Nickel Leg Base									
	FAE2M-CGBH24OPAN1	1674	1718	1764	1858	1948	2042	2133	2225	2409
24" Closed Polymer Arm Center Unit, Guest Back, Silver Metallic Leg Base										
FAE2M-CGBH24CPAS1	1728	1785	1843	1959	2073	2189	2303	2419	2647	
24" Closed Polymer Arm Center Unit, Guest Back, Brushed Nickel Leg Base										
FAE2M-CGBH24CPAN1	1934	1990	2049	2165	2279	2395	2509	2625	2852	
 <p>Center - Sled Base</p>	24" Open Polymer Arm Center Unit, Guest Back, Silver Metallic Sled Base									
	FAE2M-CGBH24OPAS2	1540	1584	1631	1724	1814	1908	1999	2092	2275
	24" Open Polymer Arm Center Unit, Guest Back, Brushed Nickel Sled Base									
	FAE2M-CGBH24OPAN2	1746	1790	1836	1930	2020	2114	2205	2297	2481
	24" Closed Polymer Arm Center Unit, Guest Back, Silver Metallic Sled Base									
	FAE2M-CGBH24CPAS2	1800	1857	1915	2031	2145	2261	2375	2491	2719
	24" Closed Polymer Arm Center Unit, Guest Back, Brushed Nickel Sled Base									
	FAE2M-CGBH24CPAN2	2006	2062	2121	2237	2351	2467	2581	2697	2924
24" Two Panel Fully Closed Polymer Arm Center Unit, Guest Back, Silver Metallic Sled Base										
FAE2M-CGBH242PPFAS2	1815	1891	1969	2095	2225	2358	2498	2638	2882	
24" Two Panel Fully Closed Polymer Arm Center Unit, Guest Back, Brushed Nickel Sled Base										
FAE2M-CGBH242PPFAN2	2021	2097	2175	2300	2431	2564	2703	2844	3088	
24" Single Panel Fully Closed Polymer Arm Center Unit, Guest Back, Silver Metallic Sled Base										
FAE2M-CGBH241PPFAS2	1996	2098	2203	2355	2518	2685	2864	3044	3338	
24" Single Panel Fully Closed Polymer Arm Center Unit, Guest Back, Brushed Nickel Sled Base										
FAE2M-CGBH241PPFAN2	2202	2304	2409	2560	2724	2891	3069	3250	3544	

ORDERING NOTES: Faeron Metal chairs can be specified with a Wood Arm (WA) or a Solid Surface Arm (SA), replace "PA" in the model number with the **Arm Style** selection below and add the upcharge listed. **Patient backs** are available on multiple units, please change the model number FAE2M-CGBH to FAE2M-CPBH, and add the upcharges on page 449 per back.

Faeron Behavioral Health Option Upcharges	\$ List	\$ List
Kinetic Back	115	Supplemental Weight - 21"
Solid Surface Arm (each) - Gr A White	274	Supplemental Weight - 24"
Solid Surface Arm (each) - Gr A Color	285	Ganging Bracket
Solid Surface Arm (each) - Gr B	306	Combination Upholstery - Dual
Solid Surface Arm (each) - Gr C	323	Combination Upholstery - Three
Wood Arm (WA) - (per pair)	205	Removeable Seat Cover (per seat)
Floor Anchor Brackets (Sleigh base only)	153	Removeable Back Cover (per back)
Springless Seat	117	CAL 133 & Moisture Barrier (per yard)

PRODUCT CODE KEY

Line	Series	Chair Type	Size	Arm Type	Arm Style	Metal Finish	Base Type
FAE	2M	SGBH	21	O	PA	S	1
Faeron	Chair	Start-Guest Seating		Open Arm	Polymer Arm	Silver Metallic	Leg Base
		CGBH	24	C	WA	N	2
		Center-Guest Seating		Closed Arm	Wood Arm	Brushed Nickel	Sled Base
		EGBH	30	2PF	SA		
		End-Guest Seating		Two Panel Fully Closed Arm	Solid Surface Arm		
			44	1PF			
				Single Panel Fully Closed Arm			

FAERON METAL BEHAVIORAL HEALTH | MULTIPLE SEATING - START, CENTER & END UNITS

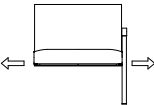
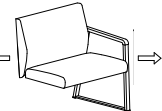
DESCRIPTION/MODEL	COM		COL		FABRIC GRADES			LEATHER	
	1	2	3	4	5	6	7	8	9
Center - Leg Base	30" Open Polymer Arm Center Unit, Guest Back, Silver Metallic Leg Base								
 FAE2M-CGBH30OPAS1	1707	1774	1839	1973	2103	2235	2370	2501	2766
	30" Open Polymer Arm Center Unit, Guest Back, Brushed Nickel Leg Base								
FAE2M-CGBH30OPAN1	1913	1980	2045	2179	2309	2441	2576	2707	2971
	30" Closed Polymer Arm Center Unit, Guest Back, Silver Metallic Leg Base								
FAE2M-CGBH30CPAS1	1967	2045	2123	2277	2434	2588	2744	2898	3210
	30" Closed Polymer Arm Center Unit, Guest Back, Brushed Nickel Leg Base								
FAE2M-CGBH30CPAN1	2172	2251	2329	2483	2640	2794	2949	3104	3416
Center - Sled Base	30" Open Polymer Arm Center Unit, Guest Back, Silver Metallic Sled Base								
 FAE2M-CGBH30OPAS2	1779	1846	1911	2045	2175	2307	2442	2573	2838
	30" Open Polymer Arm Center Unit, Guest Back, Brushed Nickel Sled Base								
FAE2M-CGBH30OPAN2	1851	1918	1983	2117	2247	2379	2514	2645	2910
	30" Closed Polymer Arm Center Unit, Guest Back, Silver Metallic Sled Base								
FAE2M-CGBH30CPAS2	2039	2117	2195	2349	2506	2660	2816	2970	3282
	30" Closed Polymer Arm Center Unit, Guest Back, Brushed Nickel Sled Base								
FAE2M-CGBH30CPAN2	2244	2323	2401	2555	2712	2866	3021	3176	3488
	30" Two Panel Fully Closed Polymer Arm Center Unit, Guest Back, Silver Metallic Sled Base								
FAE2M-CGBH302PPFAS2	2054	2153	2250	2415	2586	2758	2940	3120	3444
	30" Two Panel Fully Closed Polymer Arm Center Unit, Guest Back, Brushed Nickel Sled Base								
FAE2M-CGBH302PPAN2	2126	2225	2322	2487	2658	2830	3012	3192	3516
	30" Single Panel Fully Closed Polymer Arm Center Unit, Guest Back, Silver Metallic Sled Base								
FAE2M-CGBH301PPFAS2	2235	2360	2484	2675	2879	3085	3306	3526	3900
	30" Single Panel Fully Closed Polymer Arm Center Unit, Guest Back, Brushed Nickel Sled Base								
FAE2M-CGBH301PPFAN2	2307	2432	2556	2747	2951	3157	3378	3598	3972

ORDERING NOTES: Faeron Metal chairs can be specified with a Wood Arm (WA) or a Solid Surface Arm (SA), replace "PA" in the model number with the **Arm Style** selection below and add the upcharge listed. **Patient backs** are available on multiple units, please change the model number FAE2M-CGBH to FAE2M-CPBH, and add the upcharges on page 449 per back.

Faeron Behavioral Health Option Upcharges	\$ List	\$ List
Solid Surface Arm (each) - Gr A White	274	Supplemental Weight - 30"
Solid Surface Arm (each) - Gr A Color	285	Ganging Bracket
Solid Surface Arm (each) - Gr B	306	Combination Upholstery - Dual
Solid Surface Arm (each) - Gr C	323	Combination Upholstery - Three
Wood Arm (WA) - (per pair)	205	Removeable Seat Cover (per seat)
Floor Anchor Brackets (Sleigh base only)	153	Removeable Back Cover (per back)
Springless Seat	117	CAL 133 & Moisture Barrier (per yard)

PRODUCT CODE KEY

Line	Series	Chair Type	Size	Arm Type	Arm Style	Metal Finish	Base Type
FAE	2M	SGBH	21	O	PA	S	1
Faeron	Chair	Start-Guest Seating		Open Arm	Polymer Arm	Silver Metallic	Leg Base
		CGBH	24	C	WA	N	2
		Center-Guest Seating		Closed Arm	Wood Arm	Brushed Nickel	Sled Base
		EGBH	30	2PF	SA		
		End-Guest Seating		Two Panel Fully Closed Arm	Solid Surface Arm		
			44	1PF			
				Single Panel Fully Closed Arm			

FAERON METAL BEHAVIORAL HEALTH | MULTIPLE SEATING - START, CENTER & END UNITS

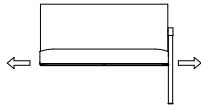
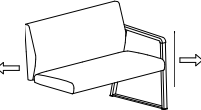
DESCRIPTION/MODEL	COM		COL		FABRIC GRADES			LEATHER	
	1	2	3	4	5	6	7	8	9
Center - Leg Base 	44" Open Polymer Arm Center Unit, Guest Back, Silver Metallic Leg Base FAE2M-CGBH44OPAS1 2129 2213 2296 2462 2629 2797 2962 3129 3463								
	44" Open Polymer Arm Center Unit, Guest Back, Brushed Nickel Leg Base FAE2M-CGBH44OPAN1 2335 2419 2502 2668 2835 3003 3168 3335 3669								
	44" Closed Polymer Arm Center Unit, Guest Back, Silver Metallic Leg Base FAE2M-CGBH44CPAS1 2391 2485 2578 2769 2959 3147 3338 3527 3906								
	44" Closed Polymer Arm Center Unit, Guest Back, Brushed Nickel Leg Base FAE2M-CGBH44CPAN1 2597 2690 2784 2975 3165 3353 3544 3733 4112								
Center - Sled Base 	44" Open Polymer Arm Center Unit, Guest Back, Silver Metallic Sled Base FAE2M-CGBH44OPAS2 2337 2420 2504 2670 2837 3004 3171 3337 3671								
	44" Open Polymer Arm Center Unit, Guest Back, Brushed Nickel Sled Base FAE2M-CGBH44OPAN2 2543 2626 2710 2876 3043 3210 3377 3542 3876								
	44" Closed Polymer Arm Center Unit, Guest Back, Silver Metallic Sled Base FAE2M-CGBH44CPAS2 2780 2888 2994 3206 3419 3631 3844 4056 4482								
	44" Closed Polymer Arm Center Unit, Guest Back, Brushed Nickel Sled Base FAE2M-CGBH44CPAN2 2986 3093 3199 3411 3625 3837 4050 4262 4688								
	44" Two Panel Fully Closed Polymer Arm Center Unit, Guest Back, Silver Metallic Sled Base FAE2M-CGBH442PPFAS2 2476 2592 2707 2905 3112 3320 3533 3748 4142								
	44" Two Panel Fully Closed Polymer Arm Center Unit, Guest Back, Brushed Nickel Sled Base FAE2M-CGBH442PPFAN2 2682 2798 2913 3111 3318 3526 3738 3953 4347								
	44" Single Panel Fully Closed Polymer Arm Center Unit, Guest Back, Silver Metallic Sled Base FAE2M-CGBH441PPFAS2 2657 2799 2941 3165 3405 3647 3899 4154 4598								
	44" Single Panel Fully Closed Polymer Arm Center Unit, Guest Back, Brushed Nickel Sled Base FAE2M-CGBH441PPFAN2 2863 3005 3147 3371 3611 3853 4104 4359 4803								

ORDERING NOTES: Faeron Metal chairs can be specified with a Wood Arm (WA) or a Solid Surface Arm (SA), replace "PA" in the model number with the **Arm Style** selection below and add the upcharge listed. **Patient backs** are available on multiple units, please change the model number FAE2M-CGBH to FAE2M-CPBH, and add the upcharges on page 449 per back.

Faeron Behavioral Health Option Upcharges	\$ List	\$ List
Solid Surface Arm (each) - Gr A White	274	Ganging Bracket
Solid Surface Arm (each) - Gr A Color	285	Combination Upholstery - Dual
Solid Surface Arm (each) - Gr B	306	Combination Upholstery - Three
Solid Surface Arm (each) - Gr C	323	Removeable Seat Cover (per seat)
Wood Arm (WA) - (per pair)	205	Removeable Back Cover (per back)
Floor Anchor Brackets (Sleigh base only)	153	CAL 133 & Moisture Barrier (per yard)
Springless Seat	117	

PRODUCT CODE KEY

Line	Series	Chair Type	Size	Arm Type	Arm Style	Metal Finish	Base Type
FAE	2M	SGBH	21	O	PA	S	1
Faeron	Chair	Start-Guest Seating		Open Arm	Polymer Arm	Silver Metallic	Leg Base
		CGBH	24	C	WA	N	2
		Center-Guest Seating		Closed Arm	Wood Arm	Brushed Nickel	Sled Base
		EGBH	30	2PF	SA		
		End-Guest Seating		Two Panel Fully Closed Arm	Solid Surface Arm		
			44	1PF			
				Single Panel Fully Closed Arm			

FAERON METAL BEHAVIORAL HEALTH | MULTIPLE SEATING - START, CENTER & END UNITS

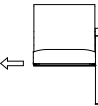
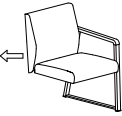
DESCRIPTION/MODEL	COM		COL		FABRIC GRADES			LEATHER		
	1	2	3	4	5	6	7	8	9	
End - Leg Base 	21" Open Polymer Arm End Unit, Guest Back, Silver Metallic Leg Base									
	FAE2M-EGBH21OPAS1	1363	1409	1457	1548	1640	1733	1823	1916	2099
	21" Open Polymer Arm End Unit, Guest Back, Brushed Nickel Leg Base									
	FAE2M-EGBH21OPAN1	1569	1615	1663	1754	1846	1939	2029	2121	2305
21" Closed Polymer Arm End Unit, Guest Back, Silver Metallic Leg Base										
FAE2M-EGBH21CPAS1	1624	1683	1739	1855	1970	2084	2199	2313	2544	
21" Closed Polymer Arm End Unit, Guest Back, Brushed Nickel Leg Base										
FAE2M-EGBH21CPAN1	1830	1888	1945	2061	2176	2290	2405	2518	2749	
End - Sled Base 	21" Open Polymer Arm End Unit, Guest Back, Silver Metallic Sled Base									
	FAE2M-EGBH21OPAS2	1435	1481	1529	1620	1712	1805	1895	1988	2171
	21" Open Polymer Arm End Unit, Guest Back, Brushed Nickel Sled Base									
	FAE2M-EGBH21OPAN2	1641	1687	1735	1826	1918	2011	2101	2193	2377
	21" Closed Polymer Arm End Unit, Guest Back, Silver Metallic Sled Base									
	FAE2M-EGBH21CPAS2	1696	1755	1811	1927	2042	2156	2271	2385	2616
	21" Closed Polymer Arm End Unit, Guest Back, Brushed Nickel Sled Base									
	FAE2M-EGBH21CPAN2	1902	1960	2017	2133	2248	2362	2477	2590	2821
	21" Two Panel Fully Closed Polymer Arm End Unit, Guest Back, Silver Metallic Sled Base									
FAE2M-EGBH212PPFAS2	1710	1788	1867	1991	2123	2255	2394	2534	2778	
21" Two Panel Fully Closed Polymer Arm End Unit, Guest Back, Brushed Nickel Sled Base										
FAE2M-EGBH212PPFAN2	1916	1994	2073	2196	2329	2461	2599	2740	2984	
21" Single Panel Fully Closed Polymer Arm End Unit, Guest Back, Silver Metallic Sled Base										
FAE2M-EGBH211PPFAS2	1891	1995	2101	2251	2416	2582	2760	2940	3234	
21" Single Panel Fully Closed Polymer Arm End Unit, Guest Back, Brushed Nickel Sled Base										
FAE2M-EGBH211PPFAN2	2097	2201	2307	2456	2622	2788	2965	3146	3440	

ORDERING NOTES: Faeron Metal chairs can be specified with a Wood Arm (WA) or a Solid Surface Arm (SA), replace "PA" in the model number with the **Arm Style** selection below and add the upcharge listed. **Patient backs** are available on multiple units, please change the model number FAE2M-EGBH to FAE2M-EPBH, and add the upcharges on page 449 per back.

Faeron Behavioral Health Option Upcharges	\$ List	\$ List
Kinetic Back	115	Supplemental Weight - 21"
Solid Surface Arm (each) - Gr A White	274	Supplemental Weight - 24"
Solid Surface Arm (each) - Gr A Color	285	Ganging Bracket
Solid Surface Arm (each) - Gr B	306	Combination Upholstery - Dual
Solid Surface Arm (each) - Gr C	323	Combination Upholstery - Three
Wood Arm (WA) - (per pair)	205	Removeable Seat Cover (per seat)
Floor Anchor Brackets (Sleigh base only)	153	Removeable Back Cover (per back)
Springless Seat	117	CAL 133 & Moisture Barrier (per yard)

PRODUCT CODE KEY

Line	Series	Chair Type	Size	Arm Type	Arm Style	Metal Finish	Base Type
FAE	2M	SGBH	21	O	PA	S	1
Faeron	Chair	Start-Guest Seating		Open Arm	Polymer Arm	Silver Metallic	Leg Base
		CGBH	24	C	WA	N	2
		Center-Guest Seating		Closed Arm	Wood Arm	Brushed Nickel	Sled Base
		EGBH	30	2PF	SA		
		End-Guest Seating		Two Panel Fully Closed Arm	Solid Surface Arm		
			44	1PF			
				Single Panel Fully Closed Arm			

FAERON METAL BEHAVIORAL HEALTH | MULTIPLE SEATING - START, CENTER & END UNITS

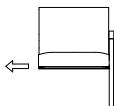
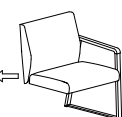
DESCRIPTION/MODEL	COM		COL		FABRIC GRADES			LEATHER		
	1	2	3	4	5	6	7	8	9	
End - Leg Base 	24" Open Polymer Arm End Unit, Guest Back, Silver Metallic Leg Base									
	FAE2M-EGBH24OPAS1	1468	1512	1559	1652	1742	1836	1927	2020	2203
	24" Open Polymer Arm End Unit, Guest Back, Brushed Nickel Leg Base									
	FAE2M-EGBH24OPAN1	1674	1718	1764	1858	1948	2042	2133	2225	2409
24" Closed Polymer Arm End Unit, Guest Back, Silver Metallic Leg Base										
FAE2M-EGBH24CPAS1	1728	1785	1843	1959	2073	2189	2303	2419	2647	
24" Closed Polymer Arm End Unit, Guest Back, Brushed Nickel Leg Base										
FAE2M-EGBH24CPAN1	1934	1990	2049	2165	2279	2395	2509	2625	2852	
End - Sled Base 	24" Open Polymer Arm End Unit, Guest Back, Silver Metallic Sled Base									
	FAE2M-EGBH24OPAS2	1540	1584	1631	1724	1814	1908	1999	2092	2275
	24" Open Polymer Arm End Unit, Guest Back, Brushed Nickel Sled Base									
	FAE2M-EGBH24OPAN2	1746	1790	1836	1930	2020	2114	2205	2297	2481
	24" Closed Polymer Arm End Unit, Guest Back, Silver Metallic Sled Base									
	FAE2M-EGBH24CPAS2	1800	1857	1915	2031	2145	2261	2375	2491	2719
	24" Closed Polymer Arm End Unit, Guest Back, Brushed Nickel Sled Base									
	FAE2M-EGBH24CPAN2	2006	2062	2121	2237	2351	2467	2581	2697	2924
24" Two Panel Fully Closed Polymer Arm End Unit, Guest Back, Silver Metallic Sled Base										
FAE2M-EGBH242PPFAS2	1815	1891	1969	2095	2225	2358	2498	2638	2882	
24" Two Panel Fully Closed Polymer Arm End Unit, Guest Back, Brushed Nickel Sled Base										
FAE2M-EGBH242PPFAN2	2021	2097	2175	2300	2431	2564	2703	2844	3088	
24" Single Panel Fully Closed Polymer Arm End Unit, Guest Back, Silver Metallic Sled Base										
FAE2M-EGBH241PPFAS2	1996	2098	2203	2355	2518	2685	2864	3044	3338	
24" Single Panel Fully Closed Polymer Arm End Unit, Guest Back, Brushed Nickel Sled Base										
FAE2M-EGBH241PPFAN2	2202	2304	2409	2560	2724	2891	3069	3250	3544	

ORDERING NOTES: Faeron Metal chairs can be specified with a Wood Arm (WA) or a Solid Surface Arm (SA), replace "PA" in the model number with the **Arm Style** selection below and add the upcharge listed. **Patient backs** are available on multiple units, please change the model number FAE2M-EGBH to FAE2M-EPBH, and add the upcharges on page 449 per back.

Faeron Behavioral Health Option Upcharges	\$ List	\$ List
Kinetic Back	115	Supplemental Weight - 21" 390
Solid Surface Arm (each) - Gr A White	274	Supplemental Weight - 24" 321
Solid Surface Arm (each) - Gr A Color	285	Ganging Bracket 56
Solid Surface Arm (each) - Gr B	306	Combination Upholstery - Dual 32
Solid Surface Arm (each) - Gr C	323	Combination Upholstery - Three 61
Wood Arm (WA) - (per pair)	205	Removeable Seat Cover (per seat) 86
Floor Anchor Brackets (Sleigh base only)	153	Removable Back Cover (per back) 56
Springless Seat	117	CAL 133 & Moisture Barrier (per yard) 61

PRODUCT CODE KEY

Line	Series	Chair Type	Size	Arm Type	Arm Style	Metal Finish	Base Type
FAE	2M	SGBH	21	O	PA	S	1
Faeron	Chair	Start-Guest Seating		Open Arm	Polymer Arm	Silver Metallic	Leg Base
		CGBH	24	C	WA	N	2
		Center-Guest Seating		Closed Arm	Wood Arm	Brushed Nickel	Sled Base
		EGBH	30	2PF	SA		
		End-Guest Seating		Two Panel Fully Closed Arm	Solid Surface Arm		
			44	1PF			
				Single Panel Fully Closed Arm			

FAERON METAL BEHAVIORAL HEALTH | MULTIPLE SEATING - START, CENTER & END UNITS

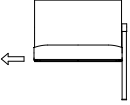
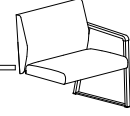
DESCRIPTION/MODEL	COM		COL		FABRIC GRADES			LEATHER	
	1	2	3	4	5	6	7	8	9
End - Leg Base	30" Open Polymer Arm End Unit, Guest Back, Silver Metallic Leg Base								
 FAE2M-EGBH30OPAS1	1707	1774	1839	1973	2103	2235	2370	2501	2766
30" Open Polymer Arm End Unit, Guest Back, Brushed Nickel Leg Base									
FAE2M-EGBH30OPAN1	1913	1980	2045	2179	2309	2441	2576	2707	2971
30" Closed Polymer Arm End Unit, Guest Back, Silver Metallic Leg Base									
FAE2M-EGBH30CPAS1	1967	2045	2123	2277	2434	2588	2744	2898	3210
30" Closed Polymer Arm End Unit, Guest Back, Brushed Nickel Leg Base									
FAE2M-EGBH30CPAN1	2172	2251	2329	2483	2640	2794	2949	3104	3416
End - Sled Base	30" Open Polymer Arm End Unit, Guest Back, Silver Metallic Sled Base								
 FAE2M-EGBH30OPAS2	1779	1846	1911	2045	2175	2307	2442	2573	2838
30" Open Polymer Arm End Unit, Guest Back, Brushed Nickel Sled Base									
FAE2M-EGBH30OPAN2	1851	1918	1983	2117	2247	2379	2514	2645	2910
30" Closed Polymer Arm End Unit, Guest Back, Silver Metallic Sled Base									
FAE2M-EGBH30CPAS2	2039	2117	2195	2349	2506	2660	2816	2970	3282
30" Closed Polymer Arm End Unit, Guest Back, Brushed Nickel Sled Base									
FAE2M-EGBH30CPAN2	2244	2323	2401	2555	2712	2866	3021	3176	3488
30" Two Panel Fully Closed Polymer Arm End Unit, Guest Back, Silver Metallic Sled Base									
FAE2M-EGBH302PPFAS2	2054	2153	2250	2415	2586	2758	2940	3120	3444
30" Two Panel Fully Closed Polymer Arm End Unit, Guest Back, Brushed Nickel Sled Base									
FAE2M-EGBH302PPAN2	2126	2225	2322	2487	2658	2830	3012	3192	3516
30" Single Panel Fully Closed Polymer Arm End Unit, Guest Back, Silver Metallic Sled Base									
FAE2M-EGBH301PPFAS2	2235	2360	2484	2675	2879	3085	3306	3526	3900
30" Single Panel Fully Closed Polymer Arm End Unit, Guest Back, Brushed Nickel Sled Base									
FAE2M-EGBH301PPAN2	2307	2432	2556	2747	2951	3157	3378	3598	3972

ORDERING NOTES: Faeron Metal chairs can be specified with a Wood Arm (WA) or a Solid Surface Arm (SA), replace "PA" in the model number with the **Arm Style** selection below and add the upcharge listed. **Patient backs** are available on multiple units, please change the model number FAE2M-EGBH to FAE2M-EPBH, and add the upcharges on page 449 per back.

Faeron Behavioral Health Option Upcharges	\$ List	\$ List
Solid Surface Arm (each) - Gr A White	274	Supplemental Weight - 30"
Solid Surface Arm (each) - Gr A Color	285	Ganging Bracket
Solid Surface Arm (each) - Gr B	306	Combination Upholstery - Dual
Solid Surface Arm (each) - Gr C	323	Combination Upholstery - Three
Wood Arm (WA) - (per pair)	205	Removeable Seat Cover (per seat)
Floor Anchor Brackets (Sleigh base only)	153	Removeable Back Cover (per back)
Springless Seat	117	CAL 133 & Moisture Barrier (per yard)

PRODUCT CODE KEY

Line	Series	Chair Type	Size	Arm Type	Arm Style	Metal Finish	Base Type
FAE	2M	SGBH	21	O	PA	S	1
Faeron	Chair	Start-Guest Seating		Open Arm	Polymer Arm	Silver Metallic	Leg Base
		CGBH	24	C	WA	N	2
		Center-Guest Seating		Closed Arm	Wood Arm	Brushed Nickel	Sled Base
		EGBH	30	2PF	SA		
		End-Guest Seating		Two Panel Fully Closed Arm	Solid Surface Arm		
			44	1PF			
				Single Panel Fully Closed Arm			

FAERON METAL BEHAVIORAL HEALTH | MULTIPLE SEATING - START, CENTER & END UNITS

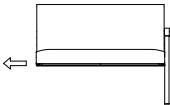
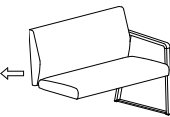
DESCRIPTION/MODEL	COM		COL	FABRIC GRADES			LEATHER		
	1	2	3	4	5	6	7	8	9
End - Leg Base	44" Open Polymer Arm End Unit, Guest Back, Silver Metallic Leg Base								
 FAE2M-EGBH44OPAS1	2129	2213	2296	2462	2629	2797	2962	3129	3463
44" Open Polymer Arm End Unit, Guest Back, Brushed Nickel Leg Base									
FAE2M-EGBH44OPAN1	2335	2419	2502	2668	2835	3003	3168	3335	3669
44" Closed Polymer Arm End Unit, Guest Back, Silver Metallic Leg Base									
FAE2M-EGBH44CPAS1	2391	2485	2578	2769	2959	3147	3338	3527	3906
44" Closed Polymer Arm End Unit, Guest Back, Brushed Nickel Leg Base									
FAE2M-EGBH44CPAN1	2597	2690	2784	2975	3165	3353	3544	3733	4112
End - Sled Base	44" Open Polymer Arm End Unit, Guest Back, Silver Metallic Sled Base								
 FAE2M-EGBH44OPAS2	2337	2420	2504	2670	2837	3004	3171	3337	3671
44" Open Polymer Arm End Unit, Guest Back, Brushed Nickel Sled Base									
FAE2M-EGBH44OPAN2	2543	2626	2710	2876	3043	3210	3377	3542	3876
44" Closed Polymer Arm End Unit, Guest Back, Silver Metallic Sled Base									
FAE2M-EGBH44CPAS2	2780	2888	2994	3206	3419	3631	3844	4056	4482
44" Closed Polymer Arm End Unit, Guest Back, Brushed Nickel Sled Base									
FAE2M-EGBH44CPAN2	2986	3093	3199	3411	3625	3837	4050	4262	4688
44" Two Panel Fully Closed Polymer Arm End Unit, Guest Back, Silver Metallic Sled Base									
FAE2M-EGBH442PPFAS2	2476	2592	2707	2905	3112	3320	3533	3748	4142
44" Two Panel Fully Closed Polymer Arm End Unit, Guest Back, Brushed Nickel Sled Base									
FAE2M-EGBH442PPFAN2	2682	2798	2913	3111	3318	3526	3738	3953	4347
44" Single Panel Fully Closed Polymer Arm End Unit, Guest Back, Silver Metallic Sled Base									
FAE2M-EGBH441PPFAS2	2657	2799	2941	3165	3405	3647	3899	4154	4598
44" Single Panel Fully Closed Polymer Arm End Unit, Guest Back, Brushed Nickel Sled Base									
FAE2M-EGBH441PPFAN2	2863	3005	3147	3371	3611	3853	4104	4359	4803

ORDERING NOTES: Faeron Metal chairs can be specified with a Wood Arm (WA) or a Solid Surface Arm (SA), replace "PA" in the model number with the **Arm Style** selection below and add the upcharge listed. **Patient backs** are available on multiple units, please change the model number FAE2M-EGBH to FAE2M-EPBH, and add the upcharges on page 449 per back.

Faeron Behavioral Health Option Upcharges	\$ List	\$ List
Solid Surface Arm (each) - Gr A White	274	Ganging Bracket
Solid Surface Arm (each) - Gr A Color	285	Combination Upholstery - Dual
Solid Surface Arm (each) - Gr B	306	Combination Upholstery - Three
Solid Surface Arm (each) - Gr C	323	Removeable Seat Cover (per seat)
Wood Arm (WA) - (per pair)	205	Removeable Back Cover (per back)
Floor Anchor Brackets (Sleigh base only)	153	CAL 133 & Moisture Barrier (per yard)
Springless Seat	117	

PRODUCT CODE KEY

Line	Series	Chair Type	Size	Arm Type	Arm Style	Metal Finish	Base Type
FAE	2M	SGBH	21	O	PA	S	1
Faeron	Chair	Start-Guest Seating		Open Arm	Polymer Arm	Silver Metallic	Leg Base
		CGBH	24	C	WA	N	2
		Center-Guest Seating		Closed Arm	Wood Arm	Brushed Nickel	Sled Base
		EGBH	30	2PF	SA		
		End-Guest Seating		Two Panel Fully Closed Arm	Solid Surface Arm		
			44	1PF			
				Single Panel Fully Closed Arm			

FAERON LOUNGE BEHAVIORAL HEALTH | ENVIRONMENTAL SUMMARY

LEED CI CREDITS

Lounge Seating



Material Content:

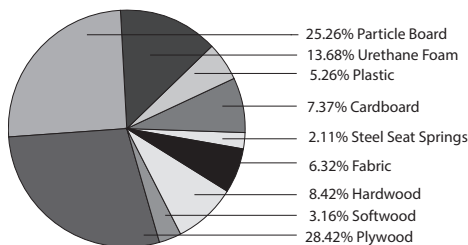

PRE-CONSUMER
RECYCLED CONTENT = 12.89%

POST-CONSUMER
RECYCLED CONTENT = 7.84%

Up to 14.95% of this Faeron Metal product is recyclable at the end of its useful life.

CONTRIBUTES TO

CREDIT	CONTRIBUTES TO	POINTS
CREDIT 2.1 - 2.2	Construction Waste Management	1-2 point(s)
CREDIT 3.3	Resource Reuse	1 point
CREDIT 4.1	Recycled Content	1 point
CREDIT 4.5	Low Emitting Materials, Systems & Seating	1 point
CREDIT 5.1	Regional Materials*	1 point
CREDIT 7	Certified Wood (MUST BE REQUESTED)	1 point(s)

*This credit is only applicable if in total 20% of the combined value of the procurement of construction materials and in the furniture are manufactured within a radius of 500 miles. This credit will apply if the installation of the finished product occurs within 500 miles of Kitchener, Ontario.

level® CERTIFICATION, AIR EMISSIONS AND FSC® CERTIFICATION



level® CERTIFICATION

BIFMA's e3 Furniture Sustainability Standard is a voluntary, multi-attribute standard that measures the degree of sustainability of furniture. This standard evaluates product and company environmental attributes and compliance systems in a wide range of elements which include Materials, Energy & Atmosphere, Human & Ecosystem Health and Social Responsibility. Faeron products have earned level®, BIFMA's sustainability certification program for furniture, certification through third-party verification against the e3 standard.

AIR-EMISSIONS

All Faeron products are supplied with air-emissions certified. Contact customer service for information.



FSC®

In 2005, Krug received Forest Stewardship Council® (FSC®) Chain-of-Custody certification for our manufacturing facilities. The FSC® Chain-of-Custody tracks certified wood from seedling to final sale. It verifies that the material for our FSC certified products only come from well-managed, FSC®-certified forests and other controlled sources. FSC® is dedicated to the promotion of responsible forest management worldwide helping to take care of forests for future generations. Faeron and other Krug products can be specified with FSC® Certification. Contact customer service for further information, pricing and lead times.



Architects, designers, and building professionals can specify FSC®-certified products in order to achieve a point from the U.S. Green Building Council's Leadership in Energy and Environmental Design (LEED) Rating System.

FAERON LOUNGE BEHAVIORAL HEALTH | FEATURES



ARM PANEL POLYMER BASE

Faeron Metal Behavioral Health lounge seating is available with a ligature-resistant, cleanable, Grey polymer base securely fastened to the arm panel.



PLINTH BASE

Faeron Metal Behavioral Health lounge seating is also available with an Grey polymer plinth base that restricts access to the interior of the chair and dirt and debris from accumulating under the chair.



WALL SAVER

Faeron Lounge models feature a wall saver feature. The angle of the back is designed to keep the back away from the wall, to prevent wear and damage to both the chairs and to the walls of the facility.



LIGATURE RISK REDUCTION

Faeron Metal Behavioral Health lounge seating has been designed with ligature-resistant features such as closed arm panels and legless base options to significantly reduce anchor points.



RESTRICTED ACCESS UPHOLSTERY

This feature provides complete closure and elimination of the standard clean out space between seat, back and arm panels in the - hindering the use of these areas for hiding contraband. This feature reduces the ability to utilize the product for ligature.



TAMPER-RESISTANT HARDWARE

Tamper-resistant hardware is utilized in the construction of all Faeron Metal Behavioral Health seating. The specific tools needed to remove components for maintenance and replacement can be purchased from Krug..



INACCESSIBLE STAPLES

All staples on this product are covered and made inaccessible with a use of polymer underseat shield, fastened with tamper-resistant hardware.



UNDERSEAT SHIELD

The polymer shield is attached with tamper-resistant hardware. It is designed to restrict access to the interior of the chair.

SECURED GLIDES

The glides are screwed in place using temper resistant screws to hinder their removal. They can be field-replaced with the use of tools.

LATEX FREE

Krug products are made with latex-free materials to prevent the allergic reaction that latex causes in some people.

FINISH DURABILITY

The Krug finish, a proprietary catalyzed varnish formulation, has been repeatedly shown, through independent laboratory testing, to be the industry leader in durability and abrasion resistance. The Krug finish looks better longer than competitors, and is uniquely suited to the demands of healthcare environments.

WEIGHT CAPACITIES

Tested to meet or exceed the BIFMA X5.4 Lounge Standard

- One-Seat - 500 lbs
- One-Seat - Plus - 750 lbs
- One-seat Wide - 500 lbs
- One-seat Wide Plus - 750 lbs
- Two-Seat - 625 lbs
- Two-Seat Plus- 975 lbs
- Three - Seat - 850 lbs
- Three - Seat Plus- 1200 lbs

FAERON LOUNGE BEHAVIORAL HEALTH | OPTIONS



POLYMER ARM CAP

The optional Polymer Arm cap provides a fully seamless armrest for enhanced durability, protection and cleanability. It is available in Black, Grey and Taupe, and is replaceable if it become damaged or degraded.



WOOD ARM CAP

The optional Wood Arm cap provides a fully seamless armrest for enhanced durability, protection and cleanability. It is available in all standard wood finishes, and are replaceable if they become damaged or degraded.



SOLID SURFACE ARM CAP

The optional Solid Surface Arm cap provides a fully seamless armrest for enhanced durability, protection and cleanability. It is available in 8 standard Corian colors, and custom colors (at an upcharge). Arms are replaceable if they become damaged or degraded. Solid Surface not recommended for lower acuity environments.



PANEL ARM METAL BASE

An optional powder coated steel panel base is available on Faeron Metal Behavioral Health lounge seating. The base is ligature resistant and installed with tamper-resistant hardware.

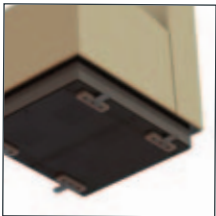

ANCHOR BRACKETS

Heavy duty tamper-resistant anchor brackets are available to secure the chair to the floor.



COMBINATION UPHOLSTERY OPTIONS

When combination upholstery is specified with fabric of the same grade or COM, an upcharge for dual fabrics is \$32 list per unit and \$61 list per unit for three fabrics will be applied. When graded in combination upholstery is selected, use the highest grade upholstery selected or to obtain a quote for blended grading contact Customer Service (please provide the fabrics specified and location of where each fabric is to be applied on the product).

SUPPLEMENTAL WEIGHT

Optional supplemental weight can be specified for additional safety and to minimize risk of weaponization. The standard polymer shield is replaced with a heavy gauge steel shield that increase the overall weight to at least 80 lbs.

REMOVABLE/REPLACEABLE UPHOLSTERY

Removable upholstery covers can be specified on this product, to facilitate cleaning and assist with infection control. They utilize tamper-resistant hardware, and inaccessible staples. Replacement upholstery covers have the same features, and can be field installed with tamper-resistant fastener tools.

CAL133 & MOISTURE BARRIER

California Technical Bulletin 133 is a flammability test for seating. Krug offers a compliance method, in combination with non-flammable upholstery covers, may enable products to meet certification requirements for this test. This process at the same time also provides the products with a Moisture Barrier - a treatment that helps to prevent the passage of liquids and moisture to inside of the upholstered components - thereby conferring sanitary and anti-infection benefits. So when CAL 133 is specified, the product also automatically has a Moisture Barrier, and when a Moisture Barrier is specified, the product also features the compliance method and low flammability features of CAL 133.





The application of this up-charge and the compliance method does not mean that the specific configuration of product and upholstery cover are tested and officially certified as being CAL133 compliant. If the official certification is required, Krug will provide this (through an independent certified testing laboratory) at a charge of \$874 per item, plus the cost of the product to be tested. Lead time for certification testing is typically 4-8 weeks. Krug assumes no responsibility for the testing of our products in combination with upholstery covers, or for the results of any testing conducted. Some specific configurations of products and upholstery have already been tested. Please contact Customer Service for additional information.

FAERON LOUNGE BEHAVIORAL HEALTH | DIMENSIONS & COM

DIMENSIONS & COM REQUIREMENTS

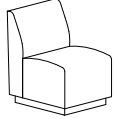
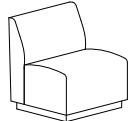
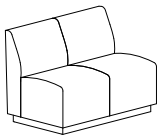
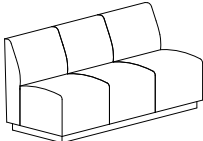
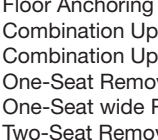
	Overall Width	Overall Depth	Overall Height	Seat Height	Height of Arms from Floor	Width between Arms	Seat Depth	Shipping Weight	Cube	COM YDG Entire	COM YDG Seat Only	COM YDG Back Only	COM YDG Arm Only (pair)
One Seat - Armless, Plinth Base													
Lounge	23	28.5	31.5	17.8	-	-	21	74	20	3.2	1.4	1.8	-
High Back	23	28.5	41.5	17.8	-	-	21	80	24	3.8	1.4	2.4	-
One Seat - Upholstered Arm, Plinth Base													
Lounge	28	30	31.5	17.8	24	23	21	114	20	6.3	1.4	1.8	3.1
High Back	28	30	41.5	17.8	24	23	21	120	24	6.9	1.4	2.4	3.1
One Seat - Upholstered Arm Panel w/ Polymer Base													
Lounge	28	31	31.5	17.8	24	23	21	95	20	6.2	1.3	1.7	3.2
High Back	28	31	41.5	17.8	24	23	21	100	24	6.8	1.3	2.3	3.2
One Seat - Upholstered Arm Panel w/ Metal Base													
Lounge	28	30	31.5	17.8	24	23	21	97	20	6.2	1.3	1.7	3.2
High Back	28	30	41.5	17.8	24	23	21	102	24	6.8	1.3	2.3	3.2
One Seat Wide - Armless, Plinth Base													
Lounge	30	28.5	31.5	17.8	-	-	21	88	23	3.4	1.6	1.8	-
High Back	30	28.5	41.5	17.8	-	-	21	94	27	4	1.6	2.4	-
One Seat Wide - Upholstered Arm, Plinth Base													
Lounge	35	30	31.5	17.8	24	23	21	128	23	6.5	1.6	1.8	3.1
High Back	35	30	41.5	17.8	24	23	21	134	27	7.1	1.6	2.4	3.1
One Seat Wide - Upholstered Arm Panel w/ Polymer Base													
Lounge	35	31	31.5	17.8	24	23	21	107	23	6.4	1.5	1.7	3.2
High Back	35	31	41.5	17.8	24	23	21	113	27	7	1.5	2.3	3.2
One Seat Wide - Upholstered Arm Panel w/ Metal Base													
Lounge	35	30	31.5	17.8	24	23	21	109	23	6.4	1.5	1.7	3.2
High Back	35	30	41.5	17.8	24	23	21	114	27	7	1.5	2.3	3.2
Two Seat - Armless, Plinth Base													
Lounge	46	28.5	31.5	17.8	-	-	21	124	36	4.5	1.8	2.7	-
High Back	46	28.5	41.5	17.8	-	-	21	135	43	5.4	1.8	3.6	-
Two Seat - Upholstered Arm, Plinth Base													
Lounge	51	30	31.5	17.8	24	23	21	164	36	7.6	1.8	2.7	3.1
High Back	51	30	41.5	17.8	24	23	21	175	43	8.5	1.8	3.6	3.1
Two Seat - Upholstered Arm Panel w/ Polymer Base													
Lounge	51	31	31.5	17.8	24	23	21	140	36	7.50	1.7	2.6	3.2
High Back	51	31	41.5	17.8	24	23	21	149	43	8.40	1.7	3.5	3.2
Two Seat - Upholstered Arm Panel w/ Metal Base													
Lounge	51	30	31.5	17.8	24	23	21	141	36	7.50	1.7	2.6	3.2
High Back	51	30	41.5	17.8	24	23	21	150	43	8.40	1.7	3.5	3.2
Three Seat - Armless, Plinth Base													
Lounge	69	28.5	31.5	17.8	-	-	21	172	52	6.1	2.6	3.5	-
High Back	69	28.5	41.5	17.8	-	-	21	187	61	7.4	2.6	4.8	-
Three Seat - Upholstered Arm, Plinth Base													
Lounge	74	30	31.5	17.8	24	23	21	213	52	9.2	2.6	3.5	3.1
High Back	74	30	41.5	17.8	24	23	21	228	61	10.5	2.6	4.8	3.1
Three Seat - Upholstered Arm Panel w/ Polymer Base													
Lounge	74	31	31.5	17.8	24	23	21	183	52	9.1	2.5	3.4	3.2
High Back	74	31	41.5	17.8	24	23	21	196	61	10.4	2.5	4.7	3.2
Three Seat - Upholstered Arm Panel w/ Metal Base													
Lounge	74	30	31.5	17.8	24	23	21	185	52	9.1	2.5	3.4	3.2
High Back	74	30	41.5	17.8	24	23	21	198	61	10.4	2.5	4.7	3.2

FAERON BEHAVIORAL HEALTH | ARMLESS LOUNGE

DESCRIPTION/MODEL	COM		COL	FABRIC GRADES			LEATHER		
	1	2	3	4	5	6	7	8	9
	One-Seat, Armless, Plinth Base								
	FAE3-APBHL1H	2040	2163	2286	2409	2562	2716	2900	3085
	One-Seat Plus, Armless, Plinth Base								
	FAE3-APBHLB1H	2105	2228	2351	2474	2627	2781	2965	3150
	One-Seat Wide, Armless, Plinth Base								
	FAE3-APBHL1+H	2243	2374	2504	2635	2798	2961	3157	3353
	One-Seat Wide Plus, Armless, Plinth Base								
	FAE3-APBHLB1+H	2313	2444	2574	2705	2868	3031	3227	3423
	Two-Seat, Armless, Plinth Base								
	FAE3-APBHL2H	3238	3411	3584	3756	3972	4188	4448	4707
	Two-Seat Plus, Armless, Plinth Base								
	FAE3-APBHLB2H	3316	3488	3661	3834	4050	4266	4525	4785
	Three-Seat, Armless, Plinth Base								
	FAE3-APBHL3H	4224	4458	4693	4927	5220	5513	5864	6215
	Three-Seat Plus, Armless, Plinth Base								
	FAE3-APBHLB3H	4357	4592	4826	5060	5353	5646	5997	6349

Option Upcharges

	\$ List		\$ List
Floor Anchoring Hardware	90	One-Seat Removable Seat Cover	145
Combination Upholstery - Dual fabrics	32	One-Seat wide Removable Seat Cover	218
Combination Upholstery - Three fabrics	61	Two-Seat Removable Seat Cover	288
One-Seat Removable Back Cover	145	Three-Seat Removable Seat Cover	432
One-Seat wide Removable Back Cover	218	Supplemental Weight One-Seat	110
Two-Seat Removable Back Cover	288	Supplemental Weight One-Seat Plus	128
Three-Seat Removable Back Cover	432	Supplemental Weight Two-seat	162
		Supplemental Weight Three-seat	231
		CAL 133 & Moisture Barrier (per yard)	61

PRODUCT CODE KEY

Line	Series	Chair Type	Size		Base
FAE	3-APBH	L	1	B1	H
Faeron	Behavioral Health Lounge Seating Armless	Lounge	One-Seat	One-Seat Plus	Plinth Base
		H	1+	B1+	
		High Back Lounge	One-Seat Wide	One-Seat Wide Plus	
			2	B2	
			Two-Seat	Two-Seat Plus	
			3	B3	
			Three-Seat	Three-Seat Plus	

FAERON BEHAVIORAL HEALTH | ARMLESS HIGH BACK LOUNGE

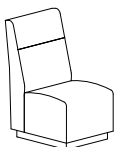
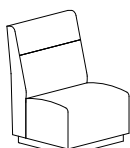
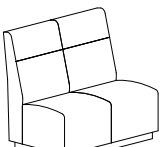
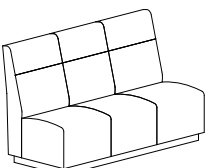

DESCRIPTION/MODEL	COM		COL	FABRIC GRADES			LEATHER				
	1	2	3	4	5	6	7	8	9		
	One-Seat, Armless, Plinth Base FAE3-APBHH1H		2245	2391	2536	2682	2865	3047	3266	3485	3759
	One-Seat Plus, Armless, Plinth Base FAE3-APBHHB1H		2310	2456	2602	2748	2930	3112	3331	3550	3824
	One-Seat Wide, Armless, Plinth Base FAE3-APBHH1+H		2383	2537	2690	2844	3036	3228	3458	3689	3977
	One-Seat Wide Plus, Armless, Plinth Base FAE3-APBHHB1+H		2453	2607	2760	2914	3106	3298	3529	3759	4047
	Two-Seat, Armless, Plinth Base FAE3-APBHH2H		3529	3737	3944	4152	4411	4670	4981	5292	5681
	Two-Seat Plus, Armless, Plinth Base FAE3-APBHHB2H		3607	3815	4022	4229	4489	4748	5059	5370	5759
	Three-Seat, Armless, Plinth Base FAE3-APBHH3H		4641	4926	5210	5494	5849	6205	6631	7057	7590
	Three-Seat Plus, Armless, Plinth Base FAE3-APBHHB3H		4775	5059	5343	5627	5983	6338	6764	7191	7723

Option Upcharges	\$ List	\$ List	
Floor Anchoring Hardware	90	One-Seat Removable Seat Cover	145
Combination Upholstery - Dual fabrics	32	One-Seat wide Removable Seat Cover	218
Combination Upholstery - Three fabrics	61	Two-Seat Removable Seat Cover	288
One-Seat Removable Back Cover	145	Three-Seat Removable Seat Cover	432
One-Seat wide Removable Back Cover	218	Supplemental Weight One-Seat	110
Two-Seat Removable Back Cover	288	Supplemental Weight One-Seat Plus	128
Three-Seat Removable Back Cover	432	Supplemental Weight Two-seat	162
		Supplemental Weight Three-seat	231
		CAL 133 & Moisture Barrier (per yard)	61

PRODUCT CODE KEY

Line	Series	Chair Type	Size		Base
FAE Faeron	3-APBH Behavioral Health Lounge Seating Armless	L Lounge	1 One-Seat	B1 One-Seat Plus	H Plinth Base
		H High Back Lounge	1+ One-Seat Wide	B1+ One-Seat Wide Plus	
			2 Two-Seat	B2 Two-Seat Plus	
			3 Three-Seat	B3 Three-Seat Plus	

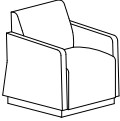
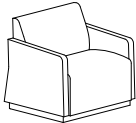
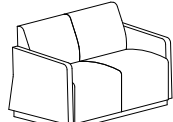
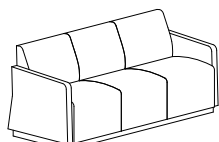
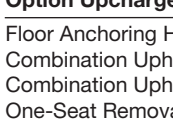
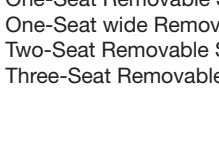
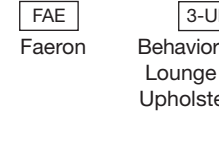
FAERON BEHAVIORAL HEALTH | LOUNGE

DESCRIPTION/MODEL	COM		COL		FABRIC GRADES			LEATHER	
	1	2	3	4	5	6	7	8	9
	One-Seat, Upholstered Arm, No Arm Cap, Plinth Base								
	FAE3-UPBHL1NCH	2865	3112	3360	3607	3916	4225	4596	4967
	One-Seat Plus, Upholstered Arm, No Arm Cap, Plinth Base								
	FAE3-UPBHLB1NCH	2930	3178	3425	3672	3981	4291	4662	5033
	One-Seat Wide, Upholstered Arm, No Arm Cap, Plinth Base								
	FAE3-UPBHL1+NCH	3128	3383	3638	3893	4212	4531	4913	5296
	One-Seat Wide Plus, Upholstered Arm, No Arm Cap, Plinth Base								
	FAE3-UPBHLB1+NCH	3198	3453	3709	3964	4282	4601	4984	5366
	Two-Seat, Upholstered Arm, No Arm Cap, Plinth Base								
	FAE3-UPBHL2NCH	4080	4378	4675	4972	5344	5715	6161	6607
	Two-Seat Plus, Upholstered Arm, No Arm Cap, Plinth Base								
	FAE3-UPBHLB2NCH	4158	4455	4753	5050	5421	5793	6239	6685
	Three-Seat, Upholstered Arm, No Arm Cap, Plinth Base								
	FAE3-UPBHL3NCH	5084	5443	5801	6160	6608	7057	7595	8133
	Three-Seat Plus, Upholstered Arm, No Arm Cap, Plinth Base								
	FAE3-UPBHLB3NCH	5217	5576	5935	6293	6742	7190	7728	8266

ORDERING NOTES: Faeron Lounge chairs can also be specified with a Polymer Arm Cap (PC), Wood Arm Cap (WC) or a Solid Surface Arm Cap (SC), replace "NC" in the model number with the **Arm Style** selection below and add the upcharge listed.

Option Upcharges	\$ List	\$ List
Floor Anchoring Hardware	90	Supplemental Weight One-Seat
Combination Upholstery - Dual fabrics	32	Supplemental Weight One-Seat Plus
Combination Upholstery - Three fabrics	61	Supplemental Weight Two-seat
One-Seat Removable Back Cover	145	Supplemental Weight Three-seat
One-Seat wide Removable Back Cover	218	CAL 133 & Moisture Barrier (per yard)
Two-Seat Removable Back Cover	288	Urethane Arm Cap
Three-Seat Removable Back Cover	432	Wood Arm Cap
One-Seat Removable Seat Cover	145	Solid Surface Arm Cap - Gr A White
One-Seat wide Removable Seat Cover	218	Solid Surface Arm Cap - Gr A Color
Two-Seat Removable Seat Cover	288	Solid Surface Arm Cap - Gr B
Three-Seat Removable Seat Cover	432	Solid Surface Arm Cap - Gr C
		See page 631 for color selection.

PRODUCT CODE KEY

Line	Series	Chair Type	Size		Arm Cap	Base
<input type="text" value="FAE"/>	<input type="text" value="3-UPBH"/>	<input type="text" value="L"/>	<input type="text" value="1"/>	<input type="text" value="B1"/>	<input type="text" value="NC"/>	<input type="text" value="H"/>
Faeron	Behavioral Health Lounge Seating Upholstered Arm	Lounge	One-Seat	One-Seat Plus	No Cap	Plinth Base
		<input type="text" value="H"/>	<input type="text" value="1+"/>	<input type="text" value="B1+"/>	<input type="text" value="PC"/>	
		High Back Lounge	One-Seat Wide	One-Seat Wide Plus	Polymer Cap	
			<input type="text" value="2"/>	<input type="text" value="B2"/>	<input type="text" value="SC"/>	
			Two-Seat	Two-Seat Plus	Solid Surface Cap	
			<input type="text" value="3"/>	<input type="text" value="B3"/>	<input type="text" value="WC"/>	
			Three-Seat	Three-Seat Plus	Wood Cap	

FAERON BEHAVIORAL HEALTH | HIGH BACK LOUNGE

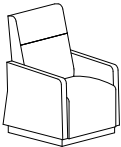
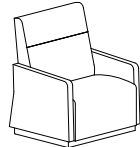
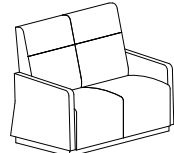
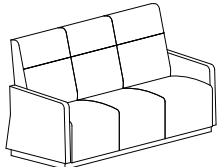
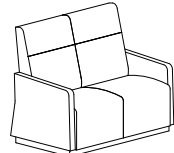
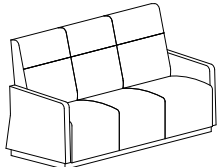
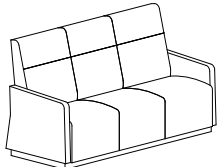
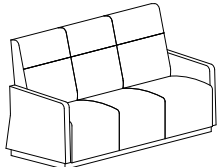
DESCRIPTION/MODEL	COM		COL		FABRIC GRADES			LEATHER		
	1	2	3	4	5	6	7	8	9	
	One-Seat, Upholstered Arm, No Arm Cap, Plinth Base									
	FAE3-UPBHH1NCH	3070	3340	3611	3881	4219	4557	4962	5368	5875
	One-Seat Plus, Upholstered Arm, No Arm Cap, Plinth Base									
	FAE3-UPBHHB1NCH	3135	3405	3676	3946	4284	4622	5027	5433	5940
	One-Seat Wide, Upholstered Arm, No Arm Cap, Plinth Base									
	FAE3-UPBHH1+NCH	3268	3546	3824	4102	4450	4797	5214	5632	6153
	One-Seat Wide Plus, Upholstered Arm, No Arm Cap, Plinth Base									
	FAE3-UPBHHB1+NCH	3338	3616	3895	4173	4520	4868	5285	5702	6223
	Two-Seat, Upholstered Arm, No Arm Cap, Plinth Base									
	FAE3-UPBHH2NCH	4372	4704	5036	5367	5782	6197	6695	7192	7815
	Two-Seat Plus, Upholstered Arm, No Arm Cap, Plinth Base									
	FAE3-UPBHHB2NCH	4450	4781	5113	5445	5860	6275	6772	7270	7892
	Three-Seat, Upholstered Arm, No Arm Cap, Plinth Base									
	FAE3-UPBHH3NCH	5500	5909	6318	6726	7237	7748	8361	8974	9740
	Three-Seat Plus, Upholstered Arm, No Arm Cap, Plinth Base									
	FAE3-UPBHHB3NCH	5634	6042	6451	6860	7370	7881	8494	9107	9873

ORDERING NOTES: Faeron Lounge chairs can also be specified with a Polymer Arm Cap (PC), Wood Arm Cap (WC) or a Solid Surface Arm Cap (SC), replace "NC" in the model number with the **Arm Style** selection below and add the upcharge listed.

Option Upcharges	\$ List	\$ List
Floor Anchoring Hardware	90	Supplemental Weight One-Seat
Combination Upholstery - Dual fabrics	32	Supplemental Weight One-Seat Plus
Combination Upholstery - Three fabrics	61	Supplemental Weight Two-seat
One-Seat Removable Back Cover	145	Supplemental Weight Three-seat
One-Seat wide Removable Back Cover	218	CAL 133 & Moisture Barrier (per yard)
Two-Seat Removable Back Cover	288	Urethane Arm Cap
Three-Seat Removable Back Cover	432	Wood Arm Cap
One-Seat Removable Seat Cover	145	Solid Surface Arm Cap - Gr A White
One-Seat wide Removable Seat Cover	218	Solid Surface Arm Cap - Gr A Color
Two-Seat Removable Seat Cover	288	Solid Surface Arm Cap - Gr B
Three-Seat Removable Seat Cover	432	Solid Surface Arm Cap - Gr C
		See page 631 for color selection.

PRODUCT CODE KEY

Line	Series	Chair Type	Size		Arm Cap	Base
<input type="text" value="FAE"/>	<input type="text" value="3-UPBH"/>	<input type="text" value="L"/>	<input type="text" value="1"/>	<input type="text" value="B1"/>	<input type="text" value="NC"/>	<input type="text" value="H"/>
Faeron	Behavioral Health Lounge Seating Upholstered Arm	Lounge	One-Seat	One-Seat Plus	No Cap	Plinth Base
		<input type="text" value="H"/>	<input type="text" value="1+"/>	<input type="text" value="B1+"/>	<input type="text" value="PC"/>	
		High Back Lounge	One-Seat Wide	One-Seat Wide Plus	Polymer Cap	
			<input type="text" value="2"/>	<input type="text" value="B2"/>	<input type="text" value="SC"/>	
			Two-Seat	Two-Seat Plus	Solid Surface Cap	
			<input type="text" value="3"/>	<input type="text" value="B3"/>	<input type="text" value="WC"/>	
			Three-Seat	Three-Seat Plus	Wood Cap	

FAERON LOUNGE BEHAVIORAL HEALTH | LOUNGE

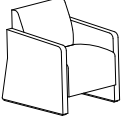
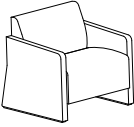
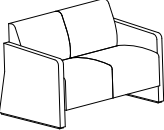
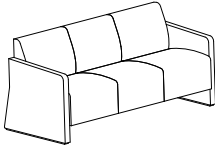
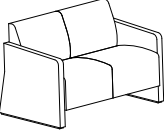
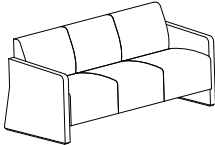
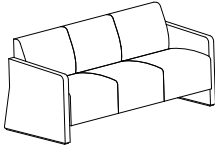
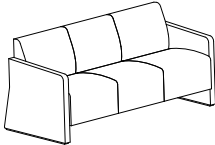
DESCRIPTION/MODEL	COM		COL		FABRIC GRADES			LEATHER	
	1	2	3	4	5	6	7	8	9
	One-Seat Upholstered Arm Panel with Polymer Base, No Arm Cap								
	FAE3-UBHL1NCG	2790	2946	3101	3256	3450	3644	3876	4109
	One-Seat Plus Upholstered Arm Panel with Polymer Base, No Arm Cap								
	FAE3-UBHLB1NCG	2855	3011	3166	3321	3515	3709	3942	4174
	One-Seat Wide Upholstered Arm Panel with Polymer Base, No Arm Cap								
	FAE3-UBHL1+NCG	3071	3261	3450	3640	3877	4114	4399	4684
	One-Seat Wide Plus Upholstered Arm Panel with Polymer Base, No Arm Cap								
	FAE3-UBHLB1+NCG	3141	3331	3521	3710	3948	4185	4469	4754
	Two-seat Upholstered Arm Panel with Polymer Base, No Arm Cap								
	FAE3-UBHL2NCG	3837	4061	4286	4510	4790	5071	5407	5743
	Two-seat Plus Upholstered Arm Panel with Polymer Base, No Arm Cap								
	FAE3-UBHLB2NCG	3915	4139	4363	4588	4868	5148	5485	5821
	Three-seat Upholstered Arm Panel with Polymer Base, No Arm Cap								
	FAE3-UBHL3NCG	4861	5150	5440	5730	6091	6453	6888	7322
	Three-seat Plus Upholstered Arm Panel with Polymer Base, No Arm Cap								
	FAE3-UBHLB3NCG	4994	5284	5573	5863	6225	6587	7021	7456

ORDERING NOTES: Faeron Lounge chairs can also be specified with a Polymer Arm Cap (PC), Wood Arm Cap (WC) or a Solid Surface Arm Cap (SC), replace "NC" in the model number with the **Arm Style** selection below and add the upcharge listed. To specify the arm panel with metal base change the "G" to and "M" and upcharge below.

Option Upcharges	\$ List	\$ List
Floor Anchoring Hardware	90	Supplemental Weight One-Seat
Combination Upholstery - Dual fabrics	32	Supplemental Weight One-Seat Plus
Combination Upholstery - Three fabrics	61	Supplemental Weight Two-seat
One-Seat Removable Back Cover	145	Supplemental Weight Three-seat
One-Seat wide Removable Back Cover	218	CAL 133 & Moisture Barrier (per yard)
Two-Seat Removable Back Cover	288	Arm Panel Metal Base
Three-Seat Removable Back Cover	432	Urethane Arm Cap
One-Seat Removable Seat Cover	145	Wood Arm Cap
One-Seat wide Removable Seat Cover	218	Solid Surface Arm Cap - Gr A White
Two-Seat Removable Seat Cover	288	Solid Surface Arm Cap - Gr A Color
Three-Seat Removable Seat Cover	432	Solid Surface Arm Cap - Gr B
		Solid Surface Arm Cap - Gr C
		See page 631 for color selection.

PRODUCT CODE KEY

Line	Series	Chair Type	Size	Arm Cap	Base
FAE	3-UBH	L	1	NC	G
Faeron	Behavioral Health Lounge Seating	Lounge	One-Seat	No Cap	Arm Panel Polymer Base
	Upholstered Arm	H	1+	PC	M
		High Back Lounge	One-Seat Wide	Polymer Cap	Arm Panel Metal Base
			2	WC	
			Two-Seat	Wood Cap	
			3	SC	
			Three-Seat	Solid Surface Cap	

FAERON LOUNGE BEHAVIORAL HEALTH | HIGH BACK LOUNGE

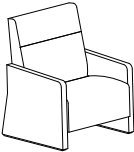
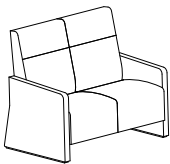
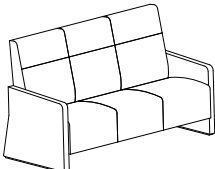
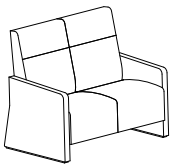
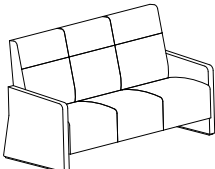
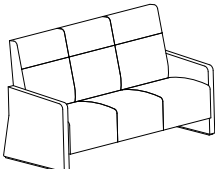
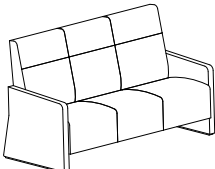
DESCRIPTION/MODEL	COM		COL		FABRIC GRADES			LEATHER	
	1	2	3	4	5	6	7	8	9
	One-Seat Upholstered Arm Panel with Polymer Base, No Arm Cap								
	FAE3-UBHH1NCG	2940	3103	3266	3429	3632	3836	4080	4325
	One-Seat Plus Upholstered Arm Panel with Polymer Base, No Arm Cap								
	FAE3-UBHHB1NCG	3005	3168	3331	3494	3698	3901	4145	4390
	One-Seat Wide Upholstered Arm Panel with Polymer Base, No Arm Cap								
	FAE3-UBHH1+NCG	3197	3410	3623	3836	4101	4367	4687	5006
	One-Seat Wide Plus Upholstered Arm Panel with Polymer Base, No Arm Cap								
	FAE3-UBHHB1+NCG	3268	3480	3693	3906	4172	4438	4757	5076
	Two-seat Upholstered Arm Panel with Polymer Base, No Arm Cap								
	FAE3-UBHH2NCG	4107	4370	4633	4895	5224	5552	5946	6340
	Two-seat Plus Upholstered Arm Panel with Polymer Base, No Arm Cap								
	FAE3-UBHHB2NCG	4185	4448	4710	4973	5301	5630	6024	6418
	Three-seat Upholstered Arm Panel with Polymer Base, No Arm Cap								
	FAE3-UBHH3NCG	5241	5577	5912	6248	6668	7087	7591	8094
	Three-seat Plus Upholstered Arm Panel with Polymer Base, No Arm Cap								
	FAE3-UBHHB3NCG	5374	5710	6046	6381	6801	7221	7724	8228

ORDERING NOTES: Faeron Lounge chairs can also be specified with a Polymer Arm Cap (PC), Wood Arm Cap (WC) or a Solid Surface Arm Cap (SC), replace "NC" in the model number with the **Arm Style** selection below and add the upcharge listed. To specify the arm panel with metal base change the "G" to an "M" and upcharge below.

Option Upcharges	\$ List	\$ List
Floor Anchoring Hardware	90	Supplemental Weight One-Seat
Combination Upholstery - Dual fabrics	32	Supplemental Weight One-Seat Plus
Combination Upholstery - Three fabrics	61	Supplemental Weight Two-seat
One-Seat Removable Back Cover	145	Supplemental Weight Three-seat
One-Seat wide Removable Back Cover	218	CAL 133 & Moisture Barrier (per yard)
Two-Seat Removable Back Cover	288	Arm Panel Metal Base
Three-Seat Removable Back Cover	432	Urethane Arm Cap
One-Seat Removable Seat Cover	145	Wood Arm Cap
One-Seat wide Removable Seat Cover	218	Solid Surface Arm Cap - Gr A White
Two-Seat Removable Seat Cover	288	Solid Surface Arm Cap - Gr A Color
Three-Seat Removable Seat Cover	432	Solid Surface Arm Cap - Gr B
		Solid Surface Arm Cap - Gr C
		See page 631 for color selection.

PRODUCT CODE KEY

Line	Series	Chair Type	Size		Arm Cap	Base
FAE	3-UBH	L	1	B1	NC	G
Faeron	Behavioral Health Lounge Seating Upholstered Arm	Lounge	One-Seat	One-Seat Plus	No Cap	Arm Panel Polymer Base
		H	1+	B1+	PC	M
		High Back Lounge	One-Seat Wide	One-Seat Wide Plus	Polymer Cap	Arm Panel Metal Base
			2	B2	WC	
			Two-Seat	Two-Seat Plus	Wood Cap	
			3	B3	SC	
			Three-Seat	Three-Seat Plus	Solid Surface Cap	

ZOLA BEHAVIORAL HEALTH | ENVIRONMENTAL SUMMARY

LEED CI CREDITS



MATERIAL CONTENT:

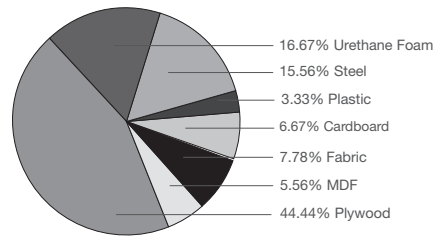

PRE-CONSUMER RECYCLED CONTENT = 2.78%

POST-CONSUMER RECYCLED CONTENT = 9.71%

Up to 22.22% of this Zola Behavioral Health product is recyclable at the end of its useful life.

CONTRIBUTES TO

CREDIT 2.1 - 2.2	Construction Waste Management	1-2 point(s)
CREDIT 3.3	Resource Reuse	1 point
CREDIT 4.1	Recycled Content	1 point
CREDIT 4.5	Low Emitting Materials, Systems & Seating	1 point
CREDIT 5.1	Regional Materials*	1 point
CREDIT 7	Certified Wood (MUST BE REQUESTED)	1 point(s)

*This credit is only applicable if in total 20% of the combined value of the procurement of construction materials and in the furniture are manufactured within a radius of 500 miles. This credit will apply if the installation of the finished product occurs within 500 miles of Kitchener, Ontario.

level® CERTIFICATION, AIR EMISSIONS AND FSC® CERTIFICATION



level® CERTIFICATION

BIFMA's e3 Furniture Sustainability Standard is a voluntary, multi-attribute standard that measures the degree of sustainability of furniture. This standard evaluates product and company environmental attributes and compliance systems in a wide range of elements which include Materials, Energy & Atmosphere, Human & Ecosystem Health and Social Responsibility. Zola products have earned level®, BIFMA's sustainability certification program for furniture, certification through third-party verification against the e3 standard.

AIR-EMISSIONS

All Zola products are supplied with air-emissions certified. Contact customer service for information.



FSC®

In 2005, Krug received Forest Stewardship Council® (FSC®) Chain-of-Custody certification for our manufacturing facilities. The FSC® Chain-of-Custody tracks certified wood from seedling to final sale. It verifies that the material for our FSC® certified products only come from well-managed, FSC®-certified forests and other controlled sources. FSC® is dedicated to the promotion of responsible forest management worldwide helping to take care of forests for future generations. Zola and other Krug products can be specified with FSC® Certification. Contact customer service for further information, pricing and lead times.



Architects, designers, and building professionals can specify FSC®-certified products in order to achieve a point from the U.S. Green Building Council's Leadership in Energy and Environmental Design (LEED) Rating System.

ZOLA BEHAVIORAL HEALTH | FEATURES



TAMPER-RESISTANT HARDWARE

This is utilized on all connection points of the product that are (or potentially) accessible, hindering components from being removed or the product being dis-assembled. The unique tools for these fasteners are available from Krug for any maintenance and component replacement.



INACCESSIBLE STAPLES

All staples on this product are covered and made inaccessible with a secondary barrier, which is fastened with tamper-resistant hardware.



LIGATURE RISK REDUCTION

This product has been designed to minimize the ability to use it for ligature - the closed arm panels, the elimination of legs, and the option of Restricted Access Upholstery significantly reduce the points on the product that could be used for ligature.



SPRINGLESS SEAT CONSTRUCTION

A very comfortable and durable sit is achieved without internal metal components such as springs - the high resiliency foam and heavy-duty suspension sheet webbing are materials used to deter harm or damage.

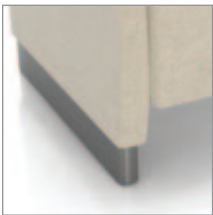

ARM PANEL BASE

This product has no legs (which could be used to cause harm or damage, or for ligature); instead the bottom portion of each arm panel is a 3" vinyl-clad runner. The durable covering is tightly secured, easy to clean, and will resist damage caused by cleaning equipment, etc.



SECURED GLIDES

The glides are epoxied and nailed in place to hinder their removal. They can be field-replaced with the use of tools.



WALL SAVER

The position of the back in relation to the base of this product is designed so the back won't impact when the chairs are pushed against the wall - avoiding potential damage to both the chairs and walls.



RESTRICTED ACCESS UPHOLSTERY

This feature provides complete closure and elimination of the normal gap between upholstered seat, back and arm panels in the seat area of the product - hindering the use of these areas for hiding weapons and contraband. This option further reduces the ability to utilize the product for ligature.

FINISH DURABILITY

The Krug 's proprietary catalyzed varnish formulation, has been repeatedly shown, through independent laboratory testing, to be the industry leader in durability and abrasion resistance. The Krug finish looks better longer than competitors, and is uniquely suited to the demands of healthcare environments.

LATEX FREE

Krug products are made with latex-free materials to prevent the allergic reaction that latex causes in some people.

WEIGHT CAPACITIES

Zola Behavioral Health weight capacities are as follows:

One Seat - 300lbs

Two Seat - 525

Three Seat - 750

One Seat Plus - 750

Two Seat Plus - 975

Three Seat Plus - 1150

ADDITIONAL FEATURES

- Lifetime warranty
- Certified to meet CAL 117 with most fabrics

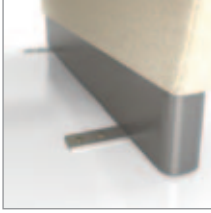

FLOOR ANCHORING

This can be provided when the product is ordered, or can be added in the field. In both cases, the fastening hardware attaching the steel floor anchoring brackets to the product is tamper-resistant.

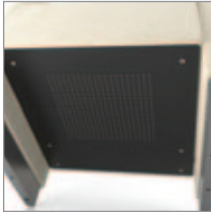

STEEL BOTTOM SHIELD

This hinders access to the interior frame and components. The powdercoated heavy-gauge steel has venting to allow circulation (venting holes are small enough to hinder use for concealment or ligature), and is fastened with tamper-resistant hardware. The Bottom Shield also adds weight to the product.

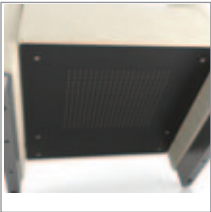

WEIGHTING

The option of additional weighting can be specified, to specific weight requirements. Additional weighting is achieved through steel plating that is fastened to the interior side of the Steel Bottom Shield, making it secure and inaccessible. This option increases total shipping weight to 87lbs.



PLUS UPGRADE

The offering includes a standard plus-size 1-seater model, as well as the option to specify plus weight rating for all other models in the offering - this provides a weight rating that exceeds 750 lbs, and includes additional seat support and an additional back leg on the 2- and 3-seat models only.



REMOVABLE/REPLACEABLE UPHOLSTERY

Removable upholstery covers can be specified on this product, to facilitate cleaning and assist with infection control. They utilize tamper-resistant hardware, and inaccessible staples. Replacement upholstery covers have the same features, and can be field installed with tamper-resistant fastener tools.



TABLES

A range of occasional tables designed specifically for behavioral health environments is included in this product offering, with a similar range of features and options to provide safety and security to patients and care-givers.

CAL133 & MOISTURE BARRIER

California Technical Bulletin 133 is a flammability test for seating. Krug offers a compliance method, in combination with non-flammable upholstery covers, may enable products to meet certification requirements for this test. This process at the same time also provides the products with a Moisture Barrier - a treatment that helps to prevent the passage of liquids and moisture to inside of the upholstered components - thereby conferring sanitary and anti-infection benefits. So when CAL 133 is specified, the product also automatically has a Moisture Barrier, and when a Moisture Barrier is specified, the product also features the compliance method and low flammability features of CAL 133.

The application of this up-charge and the compliance method does not mean that the specific configuration of product and upholstery cover are tested and officially certified as being CAL133 compliant. If the official certification is required, Krug will provide this (through an independent certified testing laboratory) at a charge of \$917 per item, plus the cost of the product to be tested. Lead time for certification testing is typically 4-8 weeks. Krug assumes no responsibility for the testing of our products in combination with upholstery covers, or for the results of any testing conducted. Some specific configurations of products and upholstery have already been tested. Please contact Customer Service for additional information.

ZOLA BEHAVIORAL HEALTH | LOUNGE

DIMENSIONS

	Overall Width	Overall Depth	Overall Height	Seat Height	Height of Arms From Floor	Width Between Arms	Seat Depth	Shipping Weight	Cubes
One-Seat	29.25	27	34	18.5	26.75	23	19.25	67	21.5
Two-seat	52.25	27	34	18.5	26.75	46	19.25	90	38
Three-seat	75.25	27	34	18.5	26.75	69	19.25	116	54.5
One-Seat (Plus)	36.25	27	34	18.5	26.75	30	19.25	72	22.6

COM YARDAGES (Lounge Product Only Available with Arms)

	COM Entire Unit	COM 2 Entire Units	COM 3 Entire Units	COM 4 Entire Units
One-Seat	4.5	8.25	13	16.5
Two-seat	6	12	17.5	23.7
Three-seat	7.6	14.25	20.5	30
One-Seat (Plus)	5	10	15	20

COM YARDAGES (Individual Components)

	COM Yardage Per Seat	COM Yardage Per 2 Seats	COM Yardage Per 3 Seats	COM Yardage Per 4 Seats	COM Yardage Per Back	COM Yardage Per 2 Backs	COM Yardage Per 3 Backs
One-Seat	1.25	2.1	3.35	4.2	1.75	2.75	3.5
Two-seat	1.75	3.4	5.1	6.5	2.5	4.54	6.08
Three-seat	2.5	4.6	7	9	3.5	6.25	9
One-Seat (Plus)	1.25	2.5	3.75	5	1.75	3.5	5.25

COM YARDAGES (Individual Components cont'd)

	COM Yardage Per 4 Backs	COM Yardage Per Arm	COM Yardage Per 2 Arms	COM Yardage Per 3 Arms	COM Yardage Per 4 Arms
One-Seat	5.25	1.75	2.4	3.3	4.2
Two-seat	8.5	1.75	2.4	3.3	4.2
Three-seat	12.5	1.75	2.4	3.3	4.2
One-Seat (Plus)	7	1.75	2.4	3.3	4.2

Upcharge for Removable Upholstery Covers:

Option Upcharge	\$ List	Option Upcharge	\$ List
Arms (Right or Left)	77	One-Seat seat	47
One-Seat back	68	Two-seat seat	68
Two-seat back	97	Three-seat seat	85
Three-seat back	121	One-Seat plus seat	61
One-Seat plus back	77		

Zola Behavioral Health Option Upcharges

\$ List

CAL 133 & Moisture Barrier (per yard)	64
Floor Anchoring Hardware	94
One-Seat Metal Bottom Shield (to min 80lbs)	115
One-Seat Plus Metal Bottom Shield (to min 80lbs)	134
Two-seat Metal Bottom Shield (to min 80lbs)	170
Three-seat Metal Bottom Shield (to min 80lbs)	242
Urethane Arm Caps (pair)	242
Combination Upholstery - dual fabrics	33
Combination Upholstery -Three fabrics	64

ZOLA BEHAVIORAL HEALTH | LOUNGE

DESCRIPTION	MODEL	COM		COL			FABRIC GRADES			LEATHER	
		1	2	3	4	5	6	7	8	9	

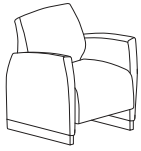

One-Seat ZOL3 BHF1221	2535	2680	2826	3066	3313	3553	3801	3903	4410
--------------------------	------	------	------	------	------	------	------	------	------

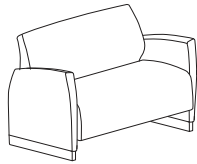

Two-Seat ZOL3 BHF2221	3621	3795	3962	4215	4479	4734	4997	5269	5667
--------------------------	------	------	------	------	------	------	------	------	------

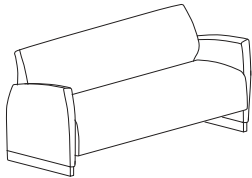

Three-Seat ZOL3 BHF3221	4809	5050	5292	5760	6230	6698	7169	7654	8441
----------------------------	------	------	------	------	------	------	------	------	------

Upcharge for Removable Upholstery Covers:

Option Upcharge	\$ List	Option Upcharge	\$ List
Arms (Right or Left)	77	One-Seat seat	47
One-Seat back	68	Two-seat seat	68
Two-seat back	97	Three-seat seat	85
Three-seat back	121	One-Seat plus seat	61
One-Seat plus back	77		

Zola Behavioral Health Option Upcharges \$ List

CAL 133 & Moisture Barrier (per yard)	64
Floor Anchoring Hardware	94
One-Seat Metal Bottom Shield (to min 80lbs)	115
One-Seat Plus Metal Bottom Shield (to min 80lbs)	134
Two-seat Metal Bottom Shield (to min 80lbs)	170
Three-seat Metal Bottom Shield (to min 80lbs)	242
Urethane Arm Caps (pair)	242
Combination Upholstery - dual fabrics	33
Combination Upholstery -Three fabrics	64

PRODUCT CODE KEY

Line	Series	Chair Type	Seat Count	Back Type	Arm Type	Leg Type
ZOL Zola	3-BH Soft Seating	F Freestanding	1 One Seat	2 Upholstered Back - no gap	2 Upholstered Arms - no gap	1 3" Runner
		FB Freestanding Plus	2 Two Seat			
			3 Three Seat			

ZOLA BEHAVIORAL HEALTH | PLUS LOUNGE

DESCRIPTION	MODEL	COM		COL			FABRIC GRADES		LEATHER	
		1	2	3	4	5	6	7	8	9

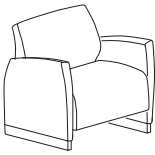

One-Seat Plus ZOL3 BHFB1221	2951	3100	3255	3508	3764	4020	4277	4551	4917
--------------------------------	------	------	------	------	------	------	------	------	------

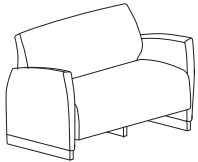

Two-Seat Plus ZOL3 BHFB2221	3886	4074	4246	4515	4790	5056	5332	5622	6036
--------------------------------	------	------	------	------	------	------	------	------	------

ORDERING NOTE: The Two-Seat Plus comes standard with center support.

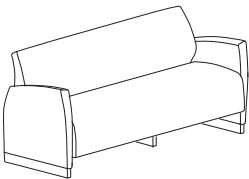

Three-Seat Plus ZOL3 BHFB3221	5150	5406	5657	6151	6644	7133	7631	8140	8964
----------------------------------	------	------	------	------	------	------	------	------	------

Zola Behavioral Health Option Upcharges \$ List

CAL 133 & Moisture Barrier (per yard)	64
Floor Anchoring Hardware	94
One-Seat Metal Bottom Shield (to min 80lbs)	115
One-Seat Plus Metal Bottom Shield (to min 80lbs)	134
Two-seat Metal Bottom Shield (to min 80lbs)	170
Three-seat Metal Bottom Shield (to min 80lbs)	242
Urethane Arm Caps (pair)	242
Combination Upholstery - dual fabrics	33
Combination Upholstery -Three fabrics	64

ZOLA BEHAVIORAL HEALTH | REPLACEMENT COMPONENTS

Description	Model	Price	Weight	Cube
-------------	-------	-------	--------	------

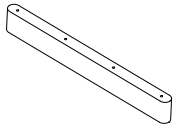

Replacement Arm Panel Base ZOL3RBCS	169	6	.5
--	-----	---	----

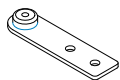



Replacement Floor Mounting Bracket (set of 4) ZOL3RFMB	113	2	.5
---	-----	---	----

PRODUCT CODE KEY

Line	Series	Chair Type	Seat Count	Back Type	Arm Type	Leg Type
ZOL Zola	3-BH Soft Seating	F Freestanding	1 One Seat	2 Upholstered Back - no gap	2 Upholstered Arms - no gap	1 3" Runner
		FB Freestanding Plus	2 Two Seat			
			3 Three Seat			

ZOLA BEHAVIORAL HEALTH | FREESTANDING TABLES

Description	Model	Maple Palette	Beech	Laminate side Laminate top PVC edge	Wood side Laminate top w/ PVC edge Maple	Wood side Laminate top w/ PVC edge Beech	Wood side Laminate top w/ Wood edge Maple	Wood side Laminate top w/ Wood edge Beech	
	Square Tables								
	ZOL4-BH181818	1390	1351	1109	1318	1356	1374	1411	
	ZOL4-BH242418	1779	1756	1403	1673	1728	1743	1795	

	Rectangular Tables								
	ZOL4-BH241818	1604	1573	1254	1512	1558	1569	1618	
	ZOL4-BH482418	2696	2642	2155	2515	2593	2611	2692	

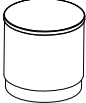
	Round Tables								
	ZOL4-BH18D18	1199	1245	1276	1109	1228	1237	1355	
	ZOL4-BH24D18	1465	1522	1612	1377	1506	1458	1588	
	ZOL4-BH30D18	2838	2719	2996	2745	2705	2851	2808	

Zola Behavioral Health Option Upcharges \$ List

Floor Anchoring Hardware	91
ZOL4-BH181818 - Weighting to min 80lbs	348
ZOL4-BH242418 - Weighting to min 80lbs	239
ZOL4-BH241818 - Weighting to min 80lbs	129
ZOL4-BH482418 - standard exceeds 80lbs	n/a
ZOL4-BH18D18 - Weighting to min 80lbs	388
ZOL4-BH24D18 - Weighting to min 80lbs	239
ZOL4-BH30D18 - standard exceeds 80lbs	n/a

ORDERING NOTE: Additional weight levels are available, contact customer service for quotes.

TABLE DIMENSIONS

Model	W	D	H	Weight	Weight with Solid Surface top	Cube	
Square Tables	ZOL4-BH181818	18	18	18	39	48	4.0
	ZOL4-BH242418	24	18	18	64	80	5.2
Rectangular Tables	ZOL4-BH241818	24	24	18	51	63	6.9
	ZOL4-BH482418	48	24	18	123	156	13.5
Round Tables	ZOL4-BH18D18	18	-	18	30	38	4.0
	ZOL4-BH24D18	24	-	18	49	62	6.9
	ZOL4-BH30D18	30	-	18	77	98	10.6

LEYTON BEHAVIORAL HEALTH | ENVIRONMENTAL SUMMARY

LEED CI CREDITS

Lounge Seating



MATERIAL CONTENT:

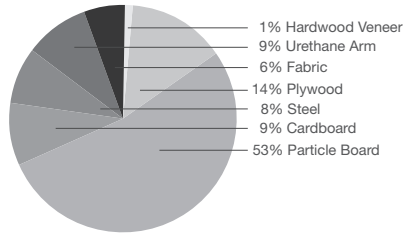

Pre-Consumer
Recycled Content = 28.61%

Post-Consumer
Recycled Content = 9.91%

Up to 8.81% of this Leyton product is recyclable at the end of its useful life.

CONTRIBUTES TO

CREDIT 2.1 - 2.2	Construction Waste Management	1-2 point(s)
CREDIT 3.3	Resource Reuse	1 point
CREDIT 4.1	Recycled Content	1 point
CREDIT 4.2	Recycled Content	1 point
CREDIT 4.5	Low Emitting Materials, Systems & Seating	1 point
CREDIT 5.1	Regional Materials*	1 point
CREDIT 7	Certified Wood (MUST BE REQUESTED)	1 point(s)

*This credit is only applicable if in total 20% of the combined value of the procurement of construction materials and in the furniture are manufactured within a radius of 500 miles. This credit will apply if the installation of the finished product occurs within 500 miles of Kitchener, Ontario.

level® CERTIFICATION, AIR EMISSIONS AND FSC® CERTIFICATION



level® CERTIFICATION

BIFMA's e3 Furniture Sustainability Standard is a voluntary, multi-attribute standard that measures the degree of sustainability of furniture. This standard evaluates product and company environmental attributes and compliance systems in a wide range of elements which include Materials, Energy & Atmosphere, Human & Ecosystem Health and Social Responsibility. Leyton products have earned level®, BIFMA's sustainability certification program for furniture, certification through third-party verification against the e3 standard.

AIR EMISSIONS

All Leyton products are supplied air-emissions certified. Contact customer service for information and upcharges.

FSC®

In 2005, Krug received Forest Stewardship Council® (FSC®) Chain-of-Custody certification for our manufacturing facilities. The FSC® Chain-of-Custody tracks certified wood from seedling to final sale. It verifies that the material for our FSC certified products only come from well-managed, FSC®-certified forests and other controlled sources. FSC® is dedicated to the promotion of responsible forest management worldwide helping to take care of forests for future generations. Leyton and other Krug products can be specified with FSC® Certification. Contact customer service for further information, pricing and lead times.

In addition, architects, designers, and building professionals can specify FSC®-certified products in order to achieve a point from the U.S. Green Building Council's Leadership in Energy and Environmental Design (LEED) Rating System.



LEYTON BEHAVIORAL HEALTH | FEATURES & OPTIONS

ARM STYLE

Leyton Behavioral Health features two design styles Upholstered Armless, Upholstered Full Arm.

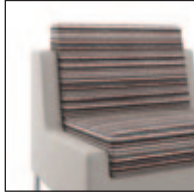

Upholstered Armless



Upholstered Full Arm



RESTRICTED ACCESS UPHOLSTERY

This product has been designed to minimize the ability to use it for ligature - the closed arm panels, the elimination of legs, and the option of Restricted Access Upholstery significantly reduce the points on the product that could be used for ligature.



TAMPER-RESISTANT HARDWARE

This is utilized on all connection points of the product that are (or potentially) accessible, hindering components from being removed or the product being dis-assembled. The unique tools for these fasteners are available from Krug for any maintenance and component replacement.



UNDERSEAT SHIELD

The polymer shield is attached with tamper-resistant hardware. It is designed to restrict access to the interior of the chair.

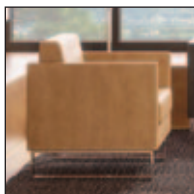

REPLACEABLE COMPONENTS

Leyton chairs are uniquely designed to allow major components to be field replaced, providing a very cost effective means to significantly extend the life of the product. Seats, backs, arms and frames are field replaceable, with the only exceptions being the Upholstered Armless, Upholstered Full Arm and Upholstered Front Panel as it is one piece.

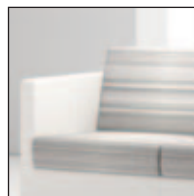

COMBINATION UPHOLSTERY

When combination upholstery is specified with fabric of the same grade or COM, an upcharge for dual fabrics is **\$33 list** per unit and **\$64 list** per unit for three fabrics will be applied. When graded in combination upholstery is selected, use the highest grade upholstery selected or to obtain a quote for blended grading contact Customer Service (please provide the fabrics specified and location of where each fabric is to be applied on the product).



SLED BASE

The sled base also features Polished Chrome structural steel with Black glides. Non-marring glides are available upon request.



POLYMER PLINTH BASE

Leyton Behavioral Health lounge seating is also available with an Grey polymer plinth base that restricts access to the interior of the chair and dirt and debris from accumulating under the chair.



FLOOR ANCHORING

This can be provided when the product is ordered, or can be added in the field. In both cases, the fastening hardware attaching the steel floor anchoring brackets to the product is tamper-resistant.

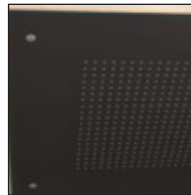

SUPPLEMENTAL WEIGHT

The option of additional weighting can be specified, to specific weight requirements. Additional weighting is achieved through steel plating that is fastened to the interior side of the Steel Bottom Shield, making it secure and inaccessible. This option increases total shipping weight to 87lbs.

SECURED GLIDES

The glides are screwed in place using temper resistant screws to hinder their removal. They can be field-replaced with the use of tools.

CAL 133 & MOISTURE BARRIER

California Technical Bulletin 133 is a flammability test for seating. Krug offers a compliance method which, in combination with non-flammable upholstery covers, may enable the products to meet certification requirements for this test. This process at the same time also provides the products with a Moisture Barrier - a treatment that helps to prevent the passage of liquids and moisture to inside of upholstered components - thereby conferring sanitary and anti-infection benefits. So when CAL 133 is specified, the product also automatically has a Moisture Barrier, and when a Moisture Barrier is specified, the product also features the compliance method and low flammability features of CAL 133. CAL 133 and Moisture Barrier are available for an upcharge. See page 628 for more information.

LEYTON | FINISHES & LAMINATES

WOOD FINISHES

Standard wood finishes are:

SPECIES	FINISH
OAK	Light Oak SilverGrey on Oak Espresso Oak Harvest Oak Mahogany Mellow oak
MAPLE	Clear Maple Honey Maple Wheat Maple
WALNUT	Natural Walnut SilverGrey on Walnut Regular Walnut Dark Walnut Cordovan Walnut
CHERRY	Appalachian Cherry American Cherry Imperial Cherry Sable Cherry Light Cherry Medium Cherry Natural Cherry Standard Cherry
ANIGRE	Clear Anigre Medium Anigre
SYCAMORE	Clear Sycamore

Please note Cherry, Anigre and Sycamore species require a minimum quantity order, of 5 units for seating and 5 units for tables, per species.

PALETTE	Black White Sand Soft Green Steel Blue Slate
----------------	---

IN-STOCK LAMINATE

Krug's in-stock laminates are available on Leyton Table surfaces in 4 solid laminate selections. Laminate surfaces are self-edged.

SOLID LAMINATES

Designer White - Platinum - Earth - Charcoal

VENEERS

Leyton veneers are quarter cut, except for White Oak, which is rift cut - both quarter cut and rift cut veneers provide a straight grain appearance. The grain direction of the veneers on vertical faces is horizontal.

NON-STANDARD VENEER SPECIES

In addition to range of standard wood species, Leyton can be made with virtually any commercially available veneers. Please contact customer service for information and pricing on wood species not included in Leyton's standard offering.

NATURAL CHARACTERISTICS OF WOOD

Wood is a natural product with inherent color variations that will never be fully mitigated by the finishing process. Please anticipate variation in colors within a single unit, from piece to piece, and from Krug wood finish samples. If a very close match is required, a sample must be provided with the order and an upcharge will apply. Exact color matches are not possible.

CUSTOM WOOD FINISHES

Add 10% list to your order for special finishes, minimum upcharge is \$525 list per finish per order. (For example, on all orders up to \$5250 list, an upcharge of \$525 will apply, on orders \$5000 and up add 10% list to your order.)

For orders with special finishes, a sample that is a minimum 3" by 3" must be received with the order. Special finishes may add additional lead time to production schedules.

Special finish upcharges on seating products are calculated on a grade 1 value. For orders with special finishes, a sample that is a minimum 3" by 3" must be received with the order. Special finishes may add additional lead time to production schedules. Since wood is a natural product, some variations in grain, color and stain acceptance will occur. In our finishing processes, we try to minimize variations, but some variation between samples and finished goods should be anticipated.

KRUG FINISH

Leyton features the Krug's proprietary catalyzed varnish formulation, that has repeatedly shown through independent laboratory testing to be the industry leader in durability and abrasion resistance. The Krug finish looks better longer than competitors and is uniquely suited to the demands of high traffic environments.

LEYTON | DIMENSIONS, COM REQUIREMENTS & MOISTURE BARRIER

DIMENSIONS

	Overall Width	Overall Depth	Overall Height	Seat Height min/max	Height of Arms from Floor	Width between Arms	Seat Depth	Shipping Weight Leg Base	Shipping Weight Sled Base	Shipping Weight Plinth Base	Cube
LEY31UF	28.5	29.25	31	17.75	26.25	23.25	19.25	89	92	100	18.5
LEY31.5UF	35.5	29.25	31	17.75	26.25	30.25	19.25	114	118	132.5	25.2
LEY32UF	52	29.25	31	17.75	26.25	47	19.25	138	140	167	32.5
LEY33UF	75.75	29.25	31	17.75	26.25	70.5	19.25	186	198	233	46.5
LEY31UN	28.5	29.25	31	17.75	n/a	23.25	19.25	85	88	96	18.5
LEY31.5UN	35.5	29.25	31	17.75	n/a	30.25	19.25	110	114	128.5	25.2
LEY32UN	52	29.25	31	17.75	n/a	47	19.25	134	146	163	32.5
LEY33UN	75.75	29.25	31	17.75	n/a	70.5	19.25	182	194	229	46.5

All dimensions are in inches and approximate and are subject to change without notice. Contact Customer Service if dimensions are critical.

COM YARDAGE REQUIREMENTS

	Fully Upholstered (Complete Unit)	Wood Surround (Seat and Back only)	Seat Cushion only (Wood or Full Uph)	Back Cushion only (Wood or Full Uph)	Full Arm & front panel (Pair)	Armless panel & front panel (pair)	Back Panel only	Full body with arm, Front panel & Back panel
One-Seat - One Chair								
Armless	3.75	1.6	0.9	0.8		1.75	.75	2.5
Full Arm	4.6	1.6	0.9	0.8	2.6		.75	3.35
One & Half-Seat - One Chair								
Armless	5.2	2.3	1.3	1		2.1	.75	2.85
Full Arm	5.7	2.3	1.3	1	2.6		.75	3.35
Two-Seat - One Chair								
Armless	5.7	3	1.5	1.5		2	.75	2.75
Full Arm	6.3	3	1.5	1.5	2.6		.75	3.35
Three-Seat - One Chair								
Armless	8	4.6	2.4	2.2		2.3	1.5	3.8
Full Arm	8.7	4.6	2.4	2.2	3		1.5	4.5

COM APPROVAL PROCESS:

The approval process is as follows:

1. A sample of the COM fabric must be provided to Krug Customer Service prior to or at time of order.
2. The sample will be reviewed and the customer advised if the fabric is unsuitable.
3. The COM fabric will be inspected when received at the factory to identify any further concerns with its suitability.

CAL 133 MOISTURE BARRIER

Model	Upcharge	Model	Upcharge	Model	Upcharge	Model	Upcharge
LEY31UN	297	LEY32UN	436	LEY31.5UN	384	LEY33UN	740
LEY31UF	368	LEY32UF	512	LEY31.5UF	478	LEY33UF	810

WEIGHT CAPACITIES

All Leyton seating feature Plus Weight capacities.

- One-Seat - 750lbs
- One-seat Wide - 750lbs
- Two-Seat - 975lbs
- Three-Seat - 1200lbs

Leyton has been tested to ANSI / BIFMA.

LEYTON BEHAVIORAL HEALTH

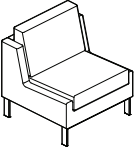
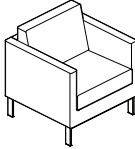
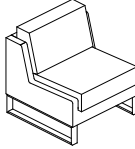
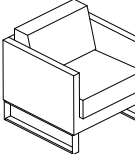
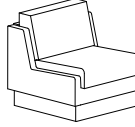
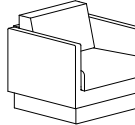
DESCRIPTION/MODEL	COM		COL	FABRIC GRADES			LEATHER		
	1	2	3	4	5	6	7	8	9
 One-seat, Upholstered, Armless with Legs LEY3-BH1UN0	2585	2900	3050	3200	3387	3574	3799	4024	4306
 One-seat, Upholstered, Full Arm with Legs LEY3-BH1UF0	2646	2979	3147	3315	3525	3736	3988	4240	4556
 One-seat, Upholstered, Armless with Sled Base LEY3-BH1UN1	2732	3047	3197	3347	3534	3721	3946	4171	4453
 One-seat, Upholstered, Full Arm with Sled Base LEY3-BH1UF1	2793	3126	3294	3462	3672	3883	4135	4387	4703
 One-seat, Upholstered, Armless with Polymer Plinth Base LEY3-BH1UN2	2957	3272	3422	3572	3759	3946	4171	4396	4678
 One-seat, Upholstered, Full Arm with Polymer Plinth Base LEY3-BH1UF2	3018	3351	3519	3687	3897	4108	4360	4612	4928

Leyton Lounge Behavioral Health Option Upcharges

	\$ List		\$ List
Floor Anchoring Hardware	270	Supplemental Weight Three-seat	231
Supplemental Weight One-Seat	110	CAL 133 & Moisture Barrier (per yard)	see page 482
Supplemental Weight One-Seat Plus	128		
Supplemental Weight Two-seat	162		

LEYTON LOUNGE PRODUCT CODE KEY

Line	Series	Seat Count	Arm Style	Base Type
LEY Leyton	3-BH Soft Seating	1 One Seat	UF Upholstered Full Arm	0 Leg Base
		1.5 One & Half Seat	UN Upholstered Armless	1 Sled Base
		2 Two Seat		2 Polymer Plinth Base
		3 Three Seat		

LEYTON BEHAVIORAL HEALTH

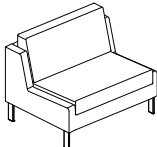
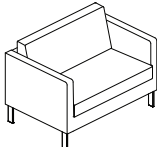
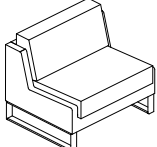
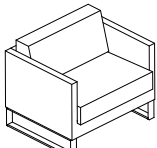
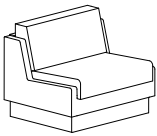
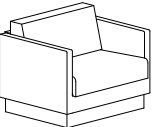
DESCRIPTION/MODEL	COM		COL	FABRIC GRADES			LEATHER		
	1	2	3	4	5	6	7	8	9
 One & Half Seat, Upholstered, Armless with Legs LEY3-BH1.5UN0	3070	3261	3451	3641	3879	4117	4402	4687	5044
 One & Half Seat, Upholstered, Full Arm with Legs LEY3-BH1.5UF0	3131	3340	3548	3757	4017	4278	4591	4903	5294
 One & Half Seat, Upholstered, Armless with Sled Base LEY3-BH1.5UN1	3217	3408	3598	3788	4026	4264	4549	4834	5191
 One & Half Seat, Upholstered, Full Arm with Sled Base LEY3-BH1.5UF1	3278	3487	3695	3904	4164	4425	4738	5050	5441
 One & Half Seat, Upholstered, Armless with Polymer Plinth Base LEY3-BH1.5UN2	3510	3701	3891	4081	4319	4557	4842	5127	5484
 One & Half Seat, Upholstered, Full Arm with Polymer Plinth Base LEY3-BH1.5UF2	3571	3780	3988	4197	4457	4718	5031	5343	5734

LEYTON LOUNGE Behavioral Health Option Upcharges	\$ List	\$ List
Floor Anchoring Hardware	270	231
Supplemental Weight One-Seat	110	see page 482
Supplemental Weight One-Seat Plus	128	
Supplemental Weight Two-seat	162	

LEYTON LOUNGE PRODUCT CODE KEY

Line	Series	Seat Count	Arm Style	Base Type
LEY Leyton	3-BH Soft Seating	1 One Seat	UF Upholstered Full Arm	0 Leg Base
		1.5 One & Half Seat	UN Upholstered Armless	1 Sled Base
		2 Two Seat		2 Polymer Plinth Base
		3 Three Seat		

LEYTON BEHAVIORAL HEALTH

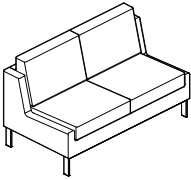
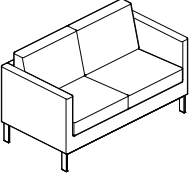
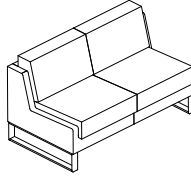
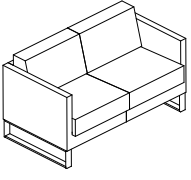
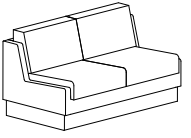
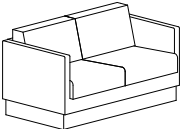
DESCRIPTION/MODEL	COM		COL	FABRIC GRADES			LEATHER		
	1	2	3	4	5	6	7	8	9
 Two-seat, Upholstered, Armless with Legs LEY3-BH2UN0	3602	3814	4026	4238	4504	4769	5087	5405	5803
 Two-seat, Upholstered, Full Arm with Legs LEY3-BH2UF0	3663	3893	4123	4354	4642	4930	5276	5621	6053
 Two-seat, Upholstered, Armless with Sled Base LEY3-BH2UN1	3749	3961	4173	4385	4651	4916	5234	5552	5950
 Two-seat, Upholstered, Full Arm with Sled Base LEY3-BH2UF1	3810	4040	4270	4501	4789	5077	5423	5768	6200
 Two-seat, Upholstered, Armless with Polymer Plinth Base LEY3-BH2UN2	4484	4696	4908	5120	5386	5651	5969	6287	6685
 Two-seat, Upholstered, Full Arm with Polymer Plinth Base LEY3-BH2UF2	4545	4775	5005	5236	5524	5812	6158	6503	6935

Leyton Lounge Behavioral Health Option Upcharges

	\$ List		\$ List
Floor Anchoring Hardware	270	Supplemental Weight Three-seat	231
Supplemental Weight One-Seat	110	CAL 133 & Moisture Barrier (per yard)	see page 482
Supplemental Weight One-Seat Plus	128		
Supplemental Weight Two-seat	162		

LEYTON LOUNGE PRODUCT CODE KEY

Line	Series	Seat Count	Arm Style	Base Type
LEY Leyton	3-BH Soft Seating	1 One Seat	UF Upholstered Full Arm	0 Leg Base
		1.5 One & Half Seat	UN Upholstered Armless	1 Sled Base
		2 Two Seat		2 Polymer Plinth Base
		3 Three Seat		

LEYTON BEHAVIORAL HEALTH

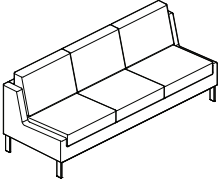
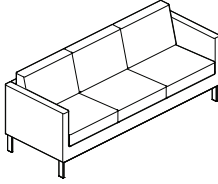
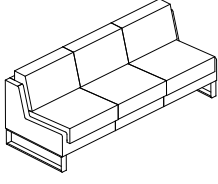
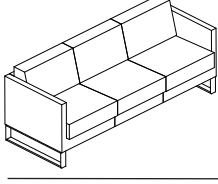
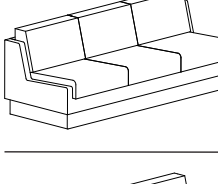
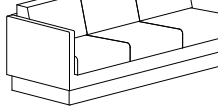
DESCRIPTION/MODEL	COM		COL	FABRIC GRADES			LEATHER		
	1	2	3	4	5	6	7	8	9
 Three-Seat, Upholstered, Armless with Legs LEY3-BH3UN0	4815	5111	5408	5704	6074	6445	6889	7333	7889
 Three-Seat, Upholstered, Full Arm with Legs LEY3-BH3UF0	4876	5190	5505	5819	6213	6606	7078	7550	8139
 Three-Seat, Upholstered, Armless with Sled Base LEY3-BH3UN1	4962	5258	5555	5851	6221	6592	7036	7480	8036
 Three-Seat, Upholstered, Full Arm with Sled Base LEY3-BH3UF1	5023	5337	5652	5966	6360	6753	7225	7697	8286
 Three-Seat, Upholstered, Armless with Polymer Plinth Base LEY3-BH3UN2	5796	6092	6389	6685	7055	7426	7870	8314	8870
 Three-Seat, Upholstered, Full Arm with Polymer Plinth Base LEY3-BH3UF2	5857	6171	6486	6800	7194	7587	8059	8531	9120

LEYTON LOUNGE Behavioral Health Option Upcharges	\$ List		\$ List
Floor Anchoring Hardware	270	Supplemental Weight Three-seat	231
Supplemental Weight One-Seat	110	CAL 133 & Moisture Barrier (per yard)	see page 482
Supplemental Weight One-Seat Plus	128		
Supplemental Weight Two-seat	162		

LEYTON LOUNGE PRODUCT CODE KEY

Line	Series	Seat Count	Arm Style	Base Type
LEY Leyton	3-BH Soft Seating	1 One Seat	UF Upholstered Full Arm	0 Leg Base
		1.5 One & Half Seat	UN Upholstered Armless	1 Sled Base
		2 Two Seat		2 Polymer Plinth Base
		3 Three Seat		

LEYTON BEHAVIORAL HEALTH | ENVIRONMENTAL SUMMARY

LEED CI CREDITS



MATERIAL CONTENT:

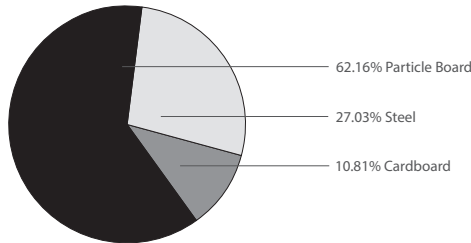

PRE-CONSUMER RECYCLED CONTENT = 34.73%

POST-CONSUMER RECYCLED CONTENT = 15.68%

Up to 62.16% of this Leyton product is recyclable at the end of its useful life.

CONTRIBUTES TO

CREDIT 2.1 - 2.2	Construction Waste Management	1-2 point(s)
CREDIT 3.3	Resource Reuse	1 point
CREDIT 4.1	Recycled Content	1 point
CREDIT 4.2	Recycled Content	1 point
CREDIT 4.5	Low Emitting Materials, Systems & Seating	1 point
CREDIT 5.1	Regional Materials*	1 point
CREDIT 7	Certified Wood (MUST BE REQUESTED)	1 point(s)

*This credit is only applicable if in total 20% of the combined value of the procurement of construction materials and in the furniture are manufactured within a radius of 500 miles. This credit will apply if the installation of the finished product occurs within 500 miles of Kitchener, Ontario.

level® CERTIFICATION, AIR EMISSIONS AND FSC® CERTIFICATION



level® CERTIFICATION

BIFMA's e3 Furniture Sustainability Standard is a voluntary, multi-attribute standard that measures the degree of sustainability of furniture. This standard evaluates product and company environmental attributes and compliance systems in a wide range of elements which include Materials, Energy & Atmosphere, Human & Ecosystem Health and Social Responsibility. Leyton products have earned level®, BIFMA's sustainability certification program for furniture, certification through third-party verification against the e3 standard.



the mark of responsible forest

AIR EMISSIONS

All Leyton products are supplied air-emissions certified. Contact customer service for information.

FSC®

In 2005, Krug received Forest Stewardship Council® (FSC®) Chain-of-Custody certification for our manufacturing facilities. The FSC® Chain-of-Custody tracks certified wood from seedling to final sale. It verifies that the material for our FSC certified products only come from well-managed, FSC®-certified forests and other controlled sources. FSC® is dedicated to the promotion of responsible forest management worldwide helping to take care of forests for future generations. Jordan and other Krug products can be specified with FSC® Certification. Contact customer service for further information, pricing and lead times.



In addition, architects, designers, and building professionals can specify FSC®-certified products in order to achieve a point from the U.S. Green Building Council's Leadership in Energy and Environmental Design (LEED) Rating System.

LEYTON BEHAVIORAL HEALTH | TABLES

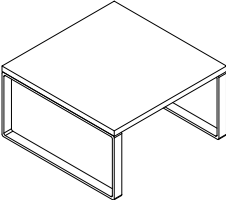
DESCRIPTION/MODEL	Maple, Oak Walnut Palette Laminate	Cherry Anigre Sycamore (5 UNIT MIN.)	Solid Surface top Grade A - White	Solid Surface top Grade A - Color	Solid Surface top Grade B	Solid Surface top Grade C	
	LEY4BH182416	793	873	1097	1154	1267	1346
	LEY4BH242416	821	920	1211	1283	1426	1525
	LEY4BH302416	851	967	1319	1404	1574	1690
	LEY4BH362416	877	1010	1454	1556	1757	1893
	LEY4BH422416	1023	1177	1571	1687	1915	2073
	LEY4BH183016	851	947	1233	1300	1433	1527
	LEY4BH243016	885	1008	1355	1439	1611	1725
	LEY4BH303016	926	1066	1474	1575	1776	1914
	LEY4BH363016	961	1121	1621	1740	1978	2141
	LEY4BH423016	1096	1283	1766	1900	2173	2360

Note: Leyton veneers are quarter cut, except for White Oak, which is rift cut - both quarter cut and rift cut veneers provide a straight grain appearance. Please note Cherry, Anigre and Sycamore species require a minimum quantity order of 5 tables (any combination of sizes) per species. Leyton Lounge and Tables feature Polished Chrome structural steel legs with glides.

Leyton Lounge Behavioral Health Option Upcharges \$ List

Floor Anchoring Hardware	270
--------------------------	-----

DIMENSIONS

Model	Width	Depth	Height	Shipping Weight	Cubes
LEY4BH182416	18	24	16	27	1.4
LEY4BH242416	24	24	16	33	1.8
LEY4BH302416	30	24	16	39	2.2
LEY4BH362416	36	24	16	45	2.7
LEY4BH422416	42	24	16	51	3.1
LEY4BH183016	18	30	16	28	1.4
LEY4BH243016	24	30	16	34	1.8
LEY4BH303016	30	30	16	40	2.2
LEY4BH363016	36	30	16	46	2.7
LEY4BH423016	42	30	16	52	3.1

TATE BENCH BEHAVIORAL HEALTH | ENVIRONMENTAL SUMMARY

LEED CI CREDITS

Bench Seating



Material Content:

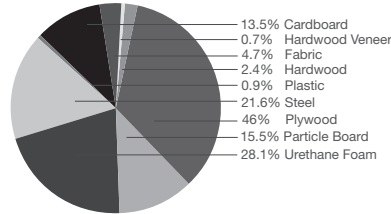

Pre-Consumer
Recycled Content = 9.09%

Post-Consumer
Recycled Content = 24.26%

Up to 26.97% of this Tate product is recyclable at the end of its useful life.

CONTRIBUTES TO

CREDIT 2.1 - 2.2	Construction Waste Management	1-2 point(s)
CREDIT 3.3	Resource Reuse	1 point
CREDIT 4.1	Recycled Content	1 point
CREDIT 4.2	Recycled Content	1 point
CREDIT 4.5	Low Emitting Materials, Systems & Seating	1 point
CREDIT 5.1	Regional Materials*	1 point
CREDIT 7	Certified Wood (MUST BE REQUESTED)	1 point(s)

*This credit is only applicable if in total 20% of the combined value of the procurement of construction materials and in the furniture are manufactured within a radius of 500 miles. This credit will apply if the installation of the finished product occurs within 500 miles of Kitchener, Ontario.

level® CERTIFICATION, AIR EMISSIONS AND FSC® CERTIFICATION



level® CERTIFICATION

BIFMA's e3 Furniture Sustainability Standard is a voluntary, multi-attribute standard that measures the degree of sustainability of furniture. This standard evaluates product and company environmental attributes and compliance systems in a wide range of elements which include Materials, Energy & Atmosphere, Human & Ecosystem Health and Social Responsibility. Tate products have earned level®, BIFMA's sustainability certification program for furniture, certification through third-party verification against the e3 standard.

AIR-EMISSIONS

All Tate products are supplied with air-emissions certified. Contact customer service for information.



FSC®

In 2005, Krug received Forest Stewardship Council® (FSC®) Chain-of-Custody certification for our manufacturing facilities. The FSC® Chain-of-Custody tracks certified wood from seedling to final sale. It verifies that the material for our FSC certified products only come from well-managed, FSC®-certified forests and other controlled sources. FSC® is dedicated to the promotion of responsible forest management worldwide helping to take care of forests for future generations. Tate and other Krug products can be specified with FSC® Certification. Contact customer service for further information, pricing and lead times.



Architects, designers, and building professionals can specify FSC®-certified products in order to achieve a point from the U.S. Green Building Council's Leadership in Energy and Environmental Design (LEED) Rating System.

TATE BENCH BEHAVIORAL HEALTH | FEATURES & OPTIONS



STYLE

Tate Bench features two design styles; Fully Upholstered & Full Gable End.



LEGS

Tate Bench legs feature polished chrome structural steel legs with non-marring glides. Legs are field replaceable.



LIGATURE RISK REDUCTION, FULL GABLE END

This option has been designed to minimize the ability to use it for ligature - the elimination of legs with the closed end, significantly reduce the points on the product that could be used for ligature.



TAMPER-RESISTANT HARDWARE

This is utilized on all connection points of the product that are (or potentially) accessible, hindering components from being removed or the product being dis-assembled. The unique tools for these fasteners are available from Krug for any maintenance and component replacement.



INACCESSIBLE STAPLES

All staples on this product are covered and made inaccessible with a secondary barrier, which is fastened with tamper-resistant hardware.



BOTTOM SHIELD

This hinders access to the interior frame and components. The bottom shield has venting to allow circulation (venting holes are small enough to hinder use for concealment or ligature), and is fastened with tamper-resistant hardware.

FLOOR ANCHORING

This can be provided when the product is ordered, or can be added in the field. In both cases, the fastening hardware attaching the steel floor anchoring brackets to the product is tamper-resistant.

SUPPLEMENTAL WEIGHT

The option of additional weighting can be specified, to specific weight requirements. Additional weighting is achieved through steel plating that is fastened to the interior side of the Steel Bottom Shield, making it secure and inaccessible. This option increases total shipping weight to 87lbs.

CAL 133 & MOISTURE BARRIER

California Technical Bulletin 133 is a flammability test for seating. Krug offers a compliance method which, in combination with non-flammable upholstery covers, may enable the products to meet certification requirements for this test. This process at the same time also provides the products with a Moisture Barrier - a treatment that helps to prevent the passage of liquids and moisture to inside of upholstered components - thereby conferring sanitary and anti-infection benefits. So when CAL 133 is specified, the product also automatically has a Moisture Barrier, and when a Moisture Barrier is specified, the product also features the compliance method and low flammability features of CAL 133.

WEIGHT CAPACITIES

Tate Bench have the following maximum weight ratings:
2 seater - 975 lbs
3 seater - 1,200 lbs

DIMENSIONS & COM REQUIREMENTS

	Overall Length	Overall Depth	Overall Height	Seat Length	Shipping Weight	Cube	COM Yardage
TAT5-BH2210	43	21	17	43	54	10.7	1.4
TAT5-BH2260	43	26	17	43	63	13.2	1.6
TAT5-BH3210	65	21	17	65	71	15.7	2.0
TAT5-BH3260	65	26	17	65	83	19.4	2.3
TAT5-BH2212	63	21	17	43	96	14.3	1.4
TAT5-BH2262	63	26	17	43	109	17.7	1.6
TAT5-BH3212	84.5	21	17	65	113	19.2	2.0
TAT5-BH3262	84.5	26	17	65	129	23.8	2.3

DIMENSIONS:

All dimensions are in inches and approximate and are subject to change without notice. Contact Customer Service if dimensions are critical.

TATE BENCH | FINISHES & LAMINATES

WOOD FINISHES

Standard wood finishes are:

SPECIES	FINISH
OAK	Light Oak SilverGrey on Oak Espresso Oak
MAPLE	Clear Maple Wheat Maple
WALNUT	Natural Walnut SilverGrey on Walnut Regular Walnut Dark Walnut

PALETTE FINISHES

Black
White
Sand
Soft Green
Steel Blue
Slate

WOOD FINISHES TO MATCH STANDARD LAMINATES

Willow on Rift Oak
Portobello on Rift Oak
Ash on Rift Oak
Park Avenue Walnut
Chocolate on Walnut
Nutmeg on Walnut
Dark Walnut
Dune Maple

LAMINATES

Krug's in-stock Laminates are available in 17 different laminate selections. Please note that 4 of the colors (Gingerbread, Portobello, Ash and Willow) have textured finishes and may not be appropriate for use in patient areas due to infection control concerns. Minimum order quantities and extended lead times may apply for exotic laminate colors, please check with customer service. Polymer Edge will be selected to match the worksurface. Krug's previous laminate in-stock program will be phased out as in-stock supply depletes. Please contact customer service for availability.

IN-STOCK LAMINATES

Wood Grain Laminates	High Pressure Laminate Supplier	Textured Wood Grain Laminates	High Pressure Laminate Supplier
Champagne	Tafisa T492CR	Gingerbread	Tafisa T556UR
Hardrock Maple	Formica 86992-58	Portobello	Tafisa T557UR
Dune	Tafisa T491CR	Ash	Tafisa T535AT
Copper	Tafisa T521CR	Willow	Tafisa T543AT
Shiraz Cherry	Tafisa T472CR	Solid Laminates	
Park Avenue Walnut	Wilsonart 7984-38	Designer White	Wilsonart D354-60
Chocolate	Tafisa T498CR	Platinum	Tafisa T202CR
Nutmeg	Tafisa T477CR	Earth	Tafisa T767CR
Dark Walnut	Tafisa T469CR	Charcoal	Tafisa T228CR

PHASE OUT LAMINATES

Almond - Black- Shadows - Edgewood Sycamore - Gunstock Walnut

Non-Stocked Laminates

For specific lead time and application questions, please contact Krug Customer Service for your requirement. Upcharges will be applicable for non-stocked laminates, depending on their cost. Non-stock laminates may require a minimum order quantity, please contact customer service. Stocked polymer edges only can be specified for use with non-stocked laminates or tops will be self-edged.

veneers

Tate Bench veneers are quarter cut, except for White Oak, which is rift cut - both quarter cut and rift cut veneers provide a straight grain appearance. The grain direction of the veneers on vertical faces is horizontal.

NON-STANDARD VENEER SPECIES

In addition to range of standard wood species, Tate can be made with virtually any commercially available veneers. Please contact customer service for information and pricing on wood species not included in Tate's standard offering.

NATURAL CHARACTERISTICS OF WOOD





Wood is a natural product with inherent color variations that will never be fully mitigated by the finishing process. Please anticipate variation in colors within a single unit, from piece to piece, and from Krug wood finish samples. If a very close match is required, a sample must be provided with the order and an upcharge will apply. Exact color matches are not possible.

CUSTOM WOOD FINISHES

Add 10% list to your order for special finishes, minimum upcharge is \$525 list per finish per order. (For example, on all orders up to \$5250 list, an upcharge of \$525 will apply, on orders \$5000 and up add 10% list to your order.)

For orders with special finishes, a sample that is a minimum 3" by 3" must be received with the order. Special finishes may add additional lead time to production schedules. Since wood is a natural product, some variations in grain, color and stain acceptance will occur. In our finishing processes, we try to minimize variations, but some variation between samples and finished goods should be anticipated.

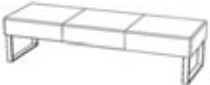
TATE BENCH BEHAVIORAL HEALTH

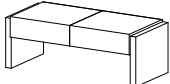
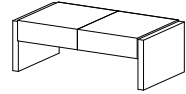
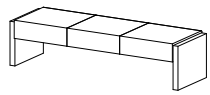
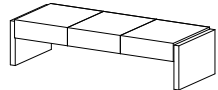
DESCRIPTION/MODEL	SPECIES	COM		COL	FABRIC GRADES			LEATHER		
		1	2	3	4	5	6	7	8	9
 Two-seat, 21", fully upholstered TAT5-BH2210		1377	1423	1465	1523	1592	1652	1720	1805	1891
 Two-seat, 26", fully upholstered TAT5-BH2260		1482	1536	1591	1667	1756	1832	1919	2028	2139
 Three-seat, 21", fully upholstered TAT5-BH3210		1758	1817	1879	1964	2061	2145	2243	2364	2485
 Three-seat, 26", fully upholstered TAT5-BH3260		1869	1941	2016	2117	2234	2337	2453	2598	2745
 Two-seat, 21", full gable end TAT5-BH2212	Maple, Oak, Laminate	1998	2037	2080	2134	2200	2257	2323	2402	2483
	Walnut, Palette	2359	2402	2445	2506	2573	2633	2703	2786	2871
 Two-seat, 26", full gable end TAT5-BH2262	Maple, Oak, Laminate	2143	2194	2247	2320	2403	2476	2558	2663	2764
	Walnut, Palette	2554	2609	2663	2740	2828	2903	2992	3102	3211
 Three-seat, 21", full gable end TAT5-BH3212	Maple, Oak, Laminate	2363	2423	2480	2561	2653	2735	2828	2943	3059
	Walnut, Palette	2737	2797	2859	2943	3041	3125	3224	3345	3468
 Three-seat, 26", full gable end TAT5-BH3262	Maple, Oak, Laminate	2531	2600	2669	2766	2876	2973	3086	3223	3361
	Walnut, Palette	2950	3023	3096	3197	3314	3417	3533	3682	3826

ORDERING NOTES: Tate Behavioral Health models TAT5-3262 are not available with the supplemental weight option.

Tate Bench Option Upcharges	\$ List	Supplemental Weight	\$ List
CAL 133 & Moisture Barrier (per yard)	64	TAT5-2210	399
Floor Anchoring Hardware	86	TAT5-2260	287
		TAT5-3210	208
		TAT5-3260	75
		TAT5-2212	299
		TAT5-2262	187
		TAT5-3212	125

PRODUCT CODE KEY

Line	Series	Seat Count	Seat Depth	Style
TAT	5-BH	2	21	0
Tate	Bench Behavioral Health	Two-Seat	21"	Fully Upholstered
		3	26	2
		Three-Seat	26"	Full Gable End

KARMA | BEHAVIORAL HEALTH FEATURES & OPTIONS

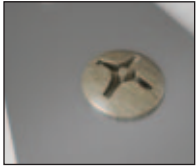

TAMPER RESISTANT HARDWARE

All screws used on the Karma Behavioral Health units have been replaced with tamper resistant security screws.



ADDED WEIGHT OPTION

Karma can be supplied with supplemental weight on the bottom of the seat adding 23lbs to each chair. When chairs are weighted they cannot be ganged.

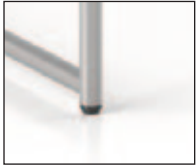

TAMPER-RESISTANT GLIDES

Karma chairs have their glides secured in place to prevent their removal and damage.

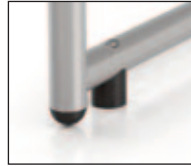

FLOOR ANCHORING OPTION

Sled base can be supplied with additional holes and bushings to allow for fastening to the floor.



NON-ACCESSIBLE STAPLES

The Karma back upholstery has been altered to allow a nylon staple cover strip to be attached; this will prevent access to the upholstery staples. The back cover strip is fastened to the unit with tamper-resistant security screws.



SLED BASE





Sled base is an integrated rail spanning the front to back leg. Karma chairs with the Sled Base option do not stack.

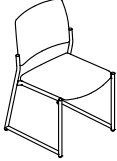

TAMPER RESISTANT ARMS

Polymer arms are equipped with added hardware, internal to the tube frame making them tamper resistant to removal from the tube. Available in four colors (Black, Grey, Light Grey & Taupe)

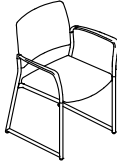
KARMA | BEHAVIORAL HEALTH

DESCRIPTION/MODEL	COM		COL		FABRIC GRADES			LEATHER		
	1	2	3	4	5	6	7	8	9	
 18.5" Sled Base, Matte Black or Silver Metallic - Fully Upholstered, No Arm with Polymer Shroud KAR2BH-18.5S_UNAS	934	967	999	1062	1124	1190	1252	1315	1441	
 18.5" Sled Base, Matte Black or Silver Metallic - Upholstered Seat & Wood Back, No Arm with Polymer Shroud KAR2BH-18.5S_WNAS	866	890	914	960	1009	1058	1106	1151	1246	
 18.5" Sled Base, Matte Black or Silver Metallic - Fully Upholstered, with Arm and Polymer Shroud KAR2BH-18.5S_U_S	982	1014	1044	1109	1171	1236	1298	1361	1488	
 18.5" Sled Base, Matte Black or Silver Metallic - Upholstered Seat & Wood Back, with Arm and Polymer Shroud KAR2BH-18.5S_W_S	914	939	961	1009	1059	1106	1152	1199	1294	



ORDERING NOTES: When selecting Frame Color and Arm Style please see Product Code Key below.

Karma Option Upcharges	\$ List
CAL 133 & Moisture Barrier (per yard)	64
Added weight (23 lbs per chair)	483
Floor anchoring	82

PRODUCT CODE KEY

Line	Series	Frame Size	Frame Color	Style	Arm Style	Underseat Shroud
KAR Karma	2BH Behavioral Health Chair	18.5S 18.5" Sled Base	B Matte Black S Silver Metallic	U Fully Upholstered W Beech Wood Back	NA No Arm AB Black AG Grey AT Taupe	S Polymer Shroud

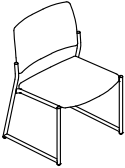
KARMA | BEHAVIORAL HEALTH

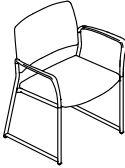
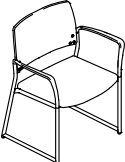
DESCRIPTION/MODEL	COM		COL			FABRIC GRADES			LEATHER	
	1	2	3	4	5	6	7	8	9	
 22" Sled Base, Matte Black or Silver Metallic - Fully Upholstered, No Arm with Polymer Shroud KAR2BH-22S_UNAS	1004	1036	1066	1131	1194	1257	1319	1384	1510	
 22" Sled Base, Matte Black or Silver Metallic - Upholstered Seat & Wood Back, No Arm with Polymer Shroud KAR2BH-22S_WNAS	932	957	981	1029	1074	1121	1170	1218	1312	
 22" Sled Base, Matte Black or Silver Metallic - Fully Upholstered, with Arm and Polymer Shroud KAR2BH-22S_U_S	1053	1084	1116	1179	1243	1306	1370	1433	1559	
 22" Sled Base, Matte Black or Silver Metallic- Upholstered Seat & Wood Back, with Arm and Polymer Shroud KAR2BH-22S_W_S	981	1004	1030	1074	1122	1170	1220	1266	1360	

ORDERING NOTES: When selecting Frame Color and Arm Style please see Product Code Key below.

Karma Option Upcharges

\$ List

CAL 133 & Moisture Barrier (per yard)	64
Added weight (23 lbs per chair)	483
Floor anchoring	82

PRODUCT CODE KEY

Line	Series	Frame Size	Frame Color	Style	Arm Style	Underseat Shroud
KAR Karma	2BH Behavioral Health Chair	22S 22" Sled Base	B Matte Black S Silver Metallic	U Fully Upholstered W Beech Wood Back	NA No Arm AB Black AG Grey AT Taupe	S Polymer Shroud

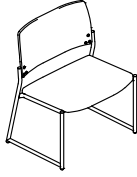
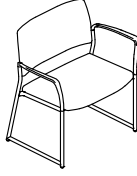
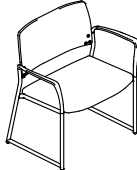
DESCRIPTION/MODEL	COM		COL	FABRIC GRADES			LEATHER		
	1	2	3	4	5	6	7	8	9
 26" Sled Base, Matte Black or Silver Metallic - Fully Upholstered, Armless with Polymer Shroud KAR2BH-26S_UNAS	1148	1202	1256	1362	1471	1581	1688	1795	2010
 26" Sled Base, Matte Black or Silver Metallic - Upholstered Seat & Wood Back, Armless, with Polymer Shroud KAR2BH-26S_WNAS	1032	1058	1081	1126	1173	1222	1270	1316	1412
 26" Sled Base, Matte Black or Silver Metallic - Fully Upholstered, with Arm and Polymer Shroud KAR2BH-26S_U_S	1195	1249	1304	1411	1518	1624	1734	1841	2058
 26" Sled Base, Matte Black or Silver Metallic- Upholstered Seat & Wood Back, with Arm and Polymer Shroud KAR2BH-26S_W_S	1081	1103	1127	1173	1223	1270	1317	1363	1460

ORDERING NOTES: When selecting Frame Color and Arm Style please see Product Code Key below.

Karma Option Upcharges	\$ List
CAL 133 & Moisture Barrier (per yard)	64
Added weight (23 lbs per chair)	483
Floor anchoring	82

PRODUCT CODE KEY

Line	Series	Frame Size	Frame Color	Style	Arm Style	Underseat Shroud
KAR	2BH	26S	B	U	NA	S
Karma	Behavioral Health Chair	26" Sled Base	Matte Black	Fully Upholstered	No Arm	Polymer Shroud
			S	W	AB	
			Silver Metallic	Beech Wood Back	Black	
					AG	
					Grey	
					AT	
					Taupe	

CHIT CHAT | ENVIRONMENTAL SUMMARY

LEED CI CREDITS



MATERIAL CONTENT:

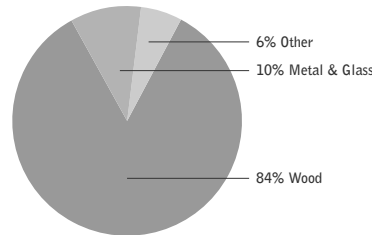

PRE-CONSUMER
RECYCLED CONTENT = 81%

POST-CONSUMER
RECYCLED CONTENT = 3%

		CONTRIBUTES TO
CREDIT 2.1 - 2.2	Construction Waste Management	1-2 point(s)
CREDIT 3.3	Resource Reuse	1 point
CREDIT 4.1	Recycled Content	1 point
CREDIT 4.2	Recycled Content	1 point
CREDIT 4.5	Low Emitting Materials, Systems & Seating	1 point
CREDIT 5.1	Regional Materials*	1 point
CREDIT 7	Certified Wood (MUST BE REQUESTED)	1 point(s)

*This credit is only applicable if in total 20% of the combined value of the procurement of construction materials and in the furniture are manufactured within a radius of 500 miles. This credit will apply if the installation of the finished product occurs within 500 miles of Kitchener, Ontario.

level® CERTIFICATION, AIR EMISSIONS AND FSC® CERTIFICATION



level® CERTIFICATION

BIFMA's e3 Furniture Sustainability Standard is a voluntary, multi-attribute standard that measures the degree of sustainability of furniture. This standard evaluates product and company environmental attributes and compliance systems in a wide range of elements which include Materials, Energy & Atmosphere, Human & Ecosystem Health and Social Responsibility. Chit Chat products have earned level®, BIFMA's sustainability certification program for furniture, certification through third-party verification against the e3 standard.

AIR-EMISSIONS

All Chit Chat products are supplied with air-emissions certified. Contact customer service for information.



FSC®

In 2005, Krug received Forest Stewardship Council® (FSC®) Chain-of-Custody certification for our manufacturing facilities. The FSC® Chain-of-Custody tracks certified wood from seedling to final sale. It verifies that the material for our FSC® certified products only come from well-managed, FSC®-certified forests and other controlled sources. FSC® is dedicated to the promotion of responsible forest management worldwide helping to take care of forests for future generations. Chit Chat and other Krug products can be specified with FSC® Certification. Contact customer service for further information, pricing and lead times.



Architects, designers, and building professionals can specify FSC®-certified products in order to achieve a point from the U.S. Green Building Council's Leadership in Energy and Environmental Design (LEED) Rating System.

CHIT CHAT | PRODUCT FEATURES & OPTIONS

TOP SHAPE & GRAIN DIRECTION

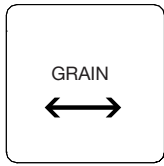

Square

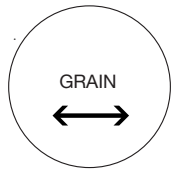

Round

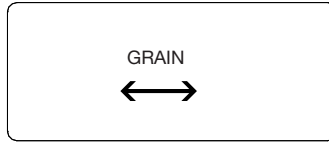

Rectangle

EDGE PROFILES



Flat Edge - T



Radius Edge - D

Chit Chat Table tops are 1-1/4" thick and available in two edge profiles. **Note:** Solid Surface is only available in the D Radius edge profile. See page 631 for color options.

BASES

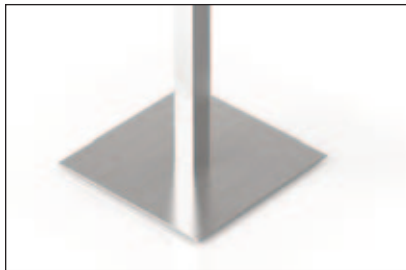

Chit Chat Table bases are available in Brushed Stainless Steel, Matte Black or White finishes with tamper resistant non-marring glides.

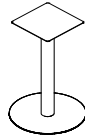

Cylindrical column with disc base

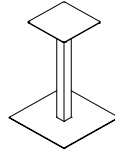

Square column with square base



Brushed Stainless Steel (-13)



Matte Black (-14)

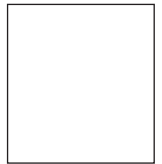

White (-44)

ANCHOR BRACKETS

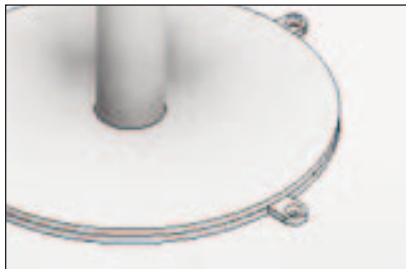

Heavy duty tamper-resistant anchor brackets are available to secure the chair to the floor.

SUPPLEMENTAL WEIGHT

Additional weighting is achieved through steel plating that is fastened to the under side of the base, making it secure and inaccessible. This option increases total shipping weight to 87lbs.

CHIT CHAT | DIMENSIONS

Model	Width	Depth	Height	Shipping Weight	Cubes
Table					
Square Table -Rounded Corners					
7261242429	24	24	29.5	40	22.25
7261303029	30	30	29.5	45	30.5
7261363629	36	36	29.5	52	40.25
Rectangular Table -Rounded Corners					
7261233029	23	30	29.5	42	18.5
7261243029	24	30	29.5	42	18.5
7261463029	45.75	30	29.5	59	32.75
7261483029	48	30	29.5	85	33.25
7261693029	68.75	30	29.5	96	47.25
7261723029	72	30	29.5	117	49
Round Table					
72052429	24D		29.5	40	15
72053029	30D		29.5	45	22
72053629	36D		29.5	62	30.25
Bar					
Square Table -Rounded Corners					
7261242442	24	24	41.75	45	21.25
7261303042*	30	30	41.75	50	31
7261363642	36	36	41.75	67	42.75
Rectangular Table -Rounded Corners					
7261233042	23	30	41.75	47	25.75
7261243042	24	30	41.75	47	25.75
7261463042	45.75	30	41.75	65	45.25
7261483042	48	30	41.75	95	47
7261693042	68.75	30	41.75	101	65.75
7261723042	72	30	41.75	127	68.5
Round Table					
72052442	25D		41.75	45	21.25
72053042	30D		41.75	50	31
72053642	36D		41.75	67	42.75
Counter					
Square Table -Rounded Corners					
7261242436	24	24	36	45	21.25
7261303036*	30	30	36	50	31
7261363636	36	36	36	67	42.75
Rectangular Table -Rounded Corners					
7261233036	23	30	36	47	25.75
7261243036	24	30	36	47	25.75
7261463036	45.75	30	36	65	45.25
7261483036	48	30	36	95	47
7261693036	68.75	30	36	101	65.75
7261723036	72	30	36	127	68.5
Round Table					
72052436	25D		36	45	21.25
72053036	30D		36	50	31
72053636	36D		36	67	42.75
Occasional					
Square Table -Rounded Corners					
7261242416	24	24	16	35	10.25
7261303016	30	30	16	40	15
7261363616	36	36	16	47	20.5
Rectangular Table -Rounded Corners					
7261233016	23	30	16	37	12.5
7261243016	24	30	16	37	12.5
7261463016	45.75	30	16	54	21.75
7261483016	48	30	16	75	22.75
7261693016	68.75	30	16	91	31.5
7261723016	72	30	16	107	32.75
Round Table					
72052416	24D		16	35	10.25
72053016	30D		16	40	15
72053616	36D		16	57	20.5

CHIT CHAT | TABLE

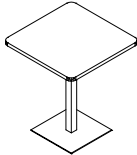
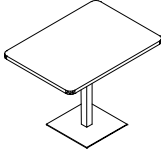
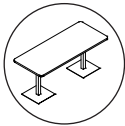
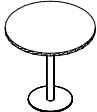
DESCRIPTION/MODEL		Laminate PVC Edge	HPL PVC Edge	Solid Surface top Grade A - White	Solid Surface top Grade A - Color	Solid Surface top Grade B	Solid Surface top Grade C
Square Table, -Rounded Corners 	Square Plate Base						
	7261242429SQ	1476	1641	1964	2045	2145	2298
	7261303029SQ	1542	1720	2144	2241	2397	2609
	7261363629SQ	1764	1969	2708	2843	3079	3392
Rectangular Table, -Rounded Corners  	Square Plate Base						
	7261233029SQ	1492	1661	2038	2127	2242	2417
	7261243029SQ	1492	1661	2038	2127	2242	2417
	7261463029SQ	2567	2831	3511	3649	3893	4213
	7261483029SQ	2596	2866	3588	3732	3988	4325
	7261693029SQ	2709	3001	4254	4457	4810	5277
	7261723029SQ	2743	3042	4366	4582	4952	5442
	Round Disc Base						
	7261233029DB	1381	1542	1925	2013	2132	2305
	7261243029DB	1381	1542	1925	2013	2132	2305
	7261463029DB	2345	2597	3290	3429	3673	3992
	7261483029DB	2377	2633	3367	3510	3767	4103
	7261693029DB	2486	2765	4032	4237	4588	5055
	7261723029DB	2524	2809	4146	4360	4730	5211
Round Table 	Round Disc Base						
	72052429DB	1365	1525	1828	1909	2028	2194
	72053029DB	1428	1600	2006	2103	2287	2507
	72053629DB	1633	1832	2544	2675	2842	2959

ORDERING NOTES:

Rectangular Chit Chat Tables 46" (45.75) and longer include two bases. Please note table sizes 23", 46" & 69" (68.75) coordinate with all Zola one, two and three-seat Benches.

Chit Chat Behavioral Health Option Upcharges

Floor Anchoring Hardware
Supplemental Weight

Please contact engquotes@krug.ca

ORDERING PROCEDURE

To order please specify the following:

1. Select model number
2. Select top material
3. Select a color for top
4. Select base finish
5. Select edge profile

BASE FINISH

Round Disc Base, Brushed Stainless- DB-13
 Square Plate Base, Brushed Stainless- SQ-13
 Round Disc Base, White- DB-44
 Square Plate Base, White- SQ-44
 Round Disc Base, Matte Black- DB-14
 Square Plate Base, Matte Black- SQ-14

MATERIALS

For a complete list of Solid Surface colors please see page 631. Solid Surface is only available in the D Radius edge profile.

For a complete list of Laminate colors please see page 631.

CHIT CHAT | BAR

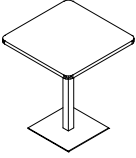
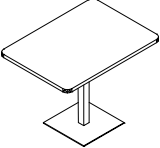
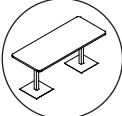
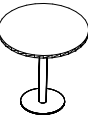
DESCRIPTION/MODEL		Laminate PVC Edge	HPL PVC Edge	Solid Surface top Grade A - White	Solid Surface top Grade A - Color	Solid Surface top Grade B	Solid Surface top Grade C
Square Table, -Rounded Corners 	Square Plate Base						
	7261242442SQ	1601	1774	2090	2170	2270	2423
	7261303042SQ*	1668	1855	2269	2366	2522	2734
	7261363642SQ	1891	2104	2834	2969	3205	3517
Rectangular Table, -Rounded Corners  	Square Plate Base						
	7261233042SQ	1617	1794	2163	2250	2368	2542
	7261243042SQ	1617	1794	2163	2250	2368	2542
	7261463042SQ	2819	3099	3763	3899	4143	4464
	7261483042SQ	2847	3134	3839	3982	4238	4574
	7261693042SQ	2959	3270	4503	4708	5061	5527
	7261723042SQ	2994	3312	4617	4832	5202	5693
	Round Disc Base						
	7261233042DB	1468	1633	2012	2100	2218	2392
	7261243042DB	1468	1633	2012	2100	2218	2392
	7261463042DB	2527	2787	3465	3603	3847	4166
	7261483042DB	2550	2816	3540	3685	3941	4277
	7261693042DB	2660	2950	4206	4412	4763	5231
	7261723042DB	2697	2991	4320	4536	4905	5395
ORDERING NOTES:							
Rectangular Chit Chat Tables 46" (45.75) and longer include two bases.							
Please note table sizes 23", 46" & 69" (68.75) coordinate with all Zola one, two and three-seat Benches.							
Round Table 	Round Disc Base						
	72052442DB	1451	1616	1916	1996	2115	2281
	72053042DB	1514	1691	2092	2190	2373	2594
	72053642DB*	1719	1923	2636	2766	2933	3049

Chit Chat Behavioral Health Option Upcharges

Floor Anchoring Hardware

Supplemental Weight

Please contact engquotes@krug.ca

ORDERING PROCEDURE

To order please specify the following:

1. Select model number
2. Select top material
3. Select a color for top
4. Select base finish
5. Select edge profile

BASE FINISH

Round Disc Base, Brushed Stainless- DB-13
 Square Plate Base, Brushed Stainless- SQ-13
 Round Disc Base, White- DB-44
 Square Plate Base, White- SQ-44
 Round Disc Base, Matte Black- DB-14
 Square Plate Base, Matte Black- SQ-14

MATERIALS

For a complete list of Solid Surface colors please see page 631. Solid Surface is only available in the D Radius edge profile.

For a complete list of Laminate colors please see page 631.

CHIT CHAT | COUNTER

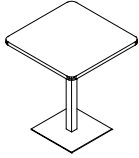
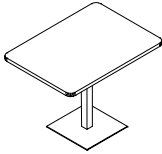
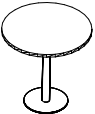
DESCRIPTION/MODEL		Laminate PVC Edge	HPL PVC Edge	Solid Surface top Grade A - White	Solid Surface top Grade A - Color	Solid Surface top Grade B	Solid Surface top Grade C
Square Table, -Rounded Corners 	Square Plate Base						
	7261242436SQ	1562	1735	2051	2131	2231	2384
	7261303036SQ*	1629	1816	2230	2327	2483	2695
	7261363636SQ	1852	2065	2795	2930	3166	3478
Rectangular Table, -Rounded Corners 	Square Plate Base						
	7261233036SQ	1578	1755	2124	2211	2329	2503
	7261243036SQ	1578	1755	2124	2211	2329	2503
	7261463036SQ	2742	3022	3686	3822	4066	4387
	7261483036SQ	2770	3057	3762	3905	4161	4497
	7261693036SQ	2882	3193	4426	4631	4984	5450
	7261723036SQ	2917	3235	4540	4755	5125	5616
	Round Disc Base						
	7261233036DB	1438	1603	1982	2070	2188	2362
	7261243036DB	1438	1603	1982	2070	2188	2362
	7261463036DB	2467	2727	3405	3543	3787	4106
	7261483036DB	2490	2756	3480	3625	3881	4217
	7261693036DB	2600	2890	4146	4352	4703	5171
	7261723036DB	2637	2931	4260	4476	4845	5335
Round Table 	Round Disc Base						
	72052436DB	1421	1586	1886	1966	2085	2251
	72053036DB	1484	1661	2062	2159	2343	2564
	72053636DB*	1689	1893	2606	2736	2903	3019

ORDERING NOTES:

Rectangular Chit Chat Tables 46" (45.75) and longer include two bases.
Please note table sizes 23", 46" & 69" (68.75) coordinate with all Zola one, two and three-seat Benches.

Chit Chat Behavioral Health Option Upcharges

Floor Anchoring Hardware
Supplemental Weight

Please contact engquotes@krug.ca

ORDERING PROCEDURE

To order please specify the following:

1. Select model number
2. Select top material
3. Select a color for top
4. Select base finish
5. Select edge profile

BASE FINISH

Round Disc Base, Brushed Stainless- DB-13
Square Plate Base, Brushed Stainless- SQ-13
Round Disc Base, White- DB-44
Square Plate Base, White- SQ-44
Round Disc Base, Matte Black- DB-14
Square Plate Base, Matte Black- SQ-14

MATERIALS & FINISHES

For a complete list of Solid Surface colors please see page 631. Solid Surface is only available in the D Radius edge profile.

For a complete list of Laminate colors please see page 631.

CHIT CHAT | OCCASIONAL

DESCRIPTION/MODEL	Laminate PVC Edge	HPL PVC Edge	Solid Surface top Grade A - White	Solid Surface top Grade A - Color	Solid Surface top Grade B	Solid Surface top Grade C
-------------------	-------------------------	--------------------	---	---	---------------------------------	---------------------------------

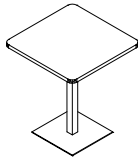
Square Table, -Rounded Corners 	Square Plate Base					
	7261242416SQ	1382	1457	1870	1951	2051
	7261303016SQ	1448	1626	2050	2147	2303
	7261363616SQ	1670	1875	2614	2749	2985

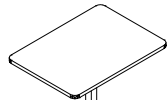
Rectangular Table, -Rounded Corners 	Square Plate Base					
	7261233016SQ	1398	1567	1944	2033	2148
	7261243016SQ	1398	1567	1944	2033	2148
	7261463016SQ	2379	2643	3323	3461	3705
	7261483016SQ	2408	2678	3400	3544	3800
	7261693016SQ	2521	2793	4066	4269	4622
	7261723016SQ	2555	2854	4178	4394	4764

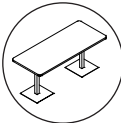
	Round Disc Base					
	7261233016DB	1317	1478	1861	1949	2068
	7261243016DB	1317	1478	1861	1949	2068
	7261463016DB	2217	2469	3162	3301	3545
	7261483016DB	2249	2505	3239	3382	3639
	7261693016DB	2358	2637	3904	4109	4460
	7261723016DB	2396	2681	4018	4232	4602

ORDERING NOTES:

Rectangular Chit Chat Tables 46" (45.75) and longer include two bases. Please note table sizes 23", 46" & 69" (68.75) coordinate with all Zola one, two and three-seat Benches.

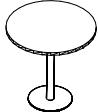
Round Table 	Round Disc Base					
	72052416DB	1301	1462	1764	1845	1964
	72053016DB	1364	1536	1942	2039	2223
	72053616DB	1569	1768	2480	2611	2778

Chit Chat Behavioral Health Option Upcharges

Floor Anchoring Hardware

Supplemental Weight

Please contact engquotes@krug.ca

ORDERING PROCEDURE

To order please specify the following:

1. Select model number
2. Select top material
3. Select a color for top
4. Select base finish
5. Select edge profile

BASE FINISH

Round Disc Base, Brushed Stainless- DB-13
 Square Plate Base, Brushed Stainless- SQ-13
 Round Disc Base, White- DB-44
 Square Plate Base, White- SQ-44
 Round Disc Base, Matte Black- DB-14
 Square Plate Base, Matte Black- SQ-14

MATERIALS & FINISHES

For a complete list of Solid Surface colors please see page 631. Solid Surface is only available in the D Radius edge profile.

For a complete list of Laminate colors please see page 631.

JUNO BEHAVIORAL HEALTH | ENVIRONMENTAL SUMMARY



MATERIAL CONTENT:

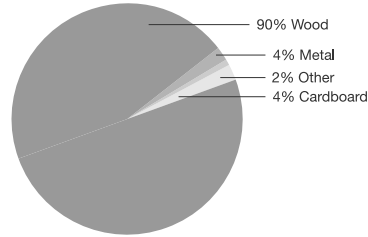

PRE-CONSUMER
RECYCLED CONTENT = 91%

POST-CONSUMER
RECYCLE CONTENT = 5%

		CONTRIBUTES TO
CREDIT 2.1 - 2.2	Construction Waste Management	1-2 point(s)
CREDIT 4.1	Recycled Content	1 point
CREDIT 4.2	Recycled Content	1 point
CREDIT 4.5	Low Emitting Materials, (MUST BE REQUESTED)	1 point
	Composite Wood & Laminate Adhesives	1 point
CREDIT 5.1	Regional Materials*	1 point
CREDIT 7	Certified Wood (PLEASE ENQUIRE)	1 point

* This credit is only applicable if in total 20% of the combined value of the procured construction materials and furniture is manufactured within a radius of 500 miles. This credit will apply if the installation of the finished product occurs within 500 miles of Toronto, Ontario.

level® CERTIFICATION, AIR EMISSIONS AND FSC® CERTIFICATION



level® CERTIFICATION

BIFMA's e3 Furniture Sustainability Standard is a voluntary, multi-attribute standard that measures the degree of sustainability of furniture. This standard evaluates product and company environmental attributes and compliance systems in a wide range of elements which include Materials, Energy & Atmosphere, Human & Ecosystem Health and Social Responsibility. Juno products have earned level®, BIFMA's sustainability certification program for furniture, certification through third-party verification against the e3 standard.

AIR-EMISSIONS

All Juno products are supplied with air-emissions certified. Contact customer service for information.



FSC®

In 2005, Krug received Forest Stewardship Council® (FSC®) Chain-of-Custody certification for our manufacturing facilities. The FSC® Chain-of-Custody tracks certified wood from seedling to final sale. It verifies that the material for our FSC® certified products only come from well-managed, FSC®-certified forests and other controlled sources. FSC® is dedicated to the promotion of responsible forest management worldwide helping to take care of forests for future generations. Juno and other Krug products can be specified with FSC® Certification. Contact customer service for further information, pricing and lead times.



Architects, designers, and building professionals can specify FSC®-certified products in order to achieve a point from the U.S. Green Building Council's Leadership in Energy and Environmental Design (LEED) Rating System.

JUNO BEHAVIORAL HEALTH | STATEMENT OF LINE

STATEMENT OF LINE:

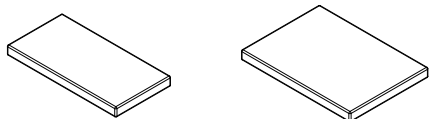
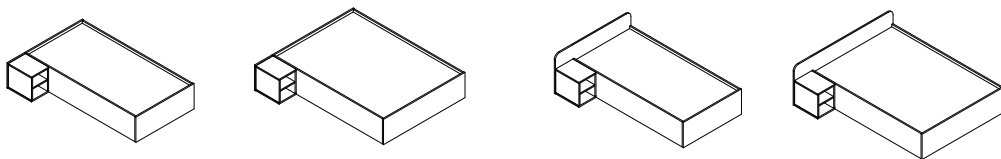
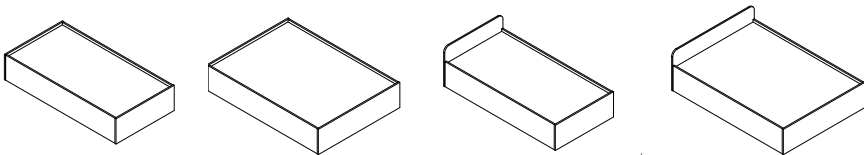
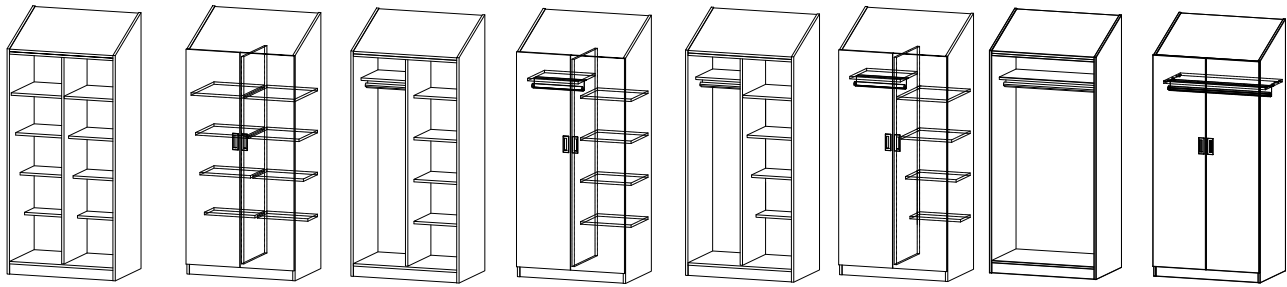
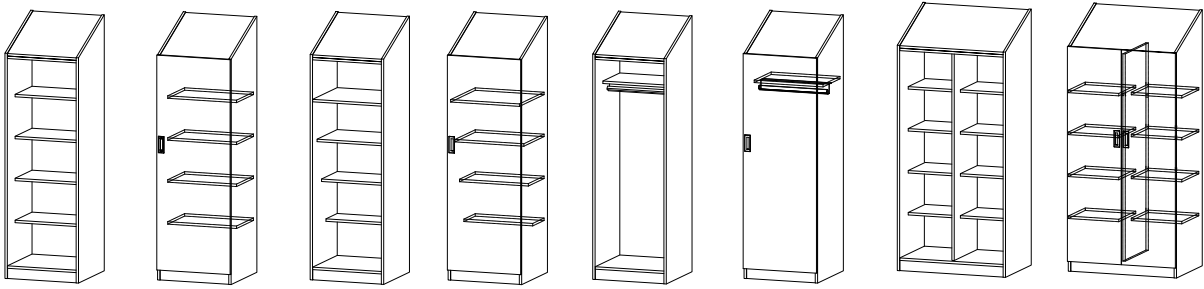
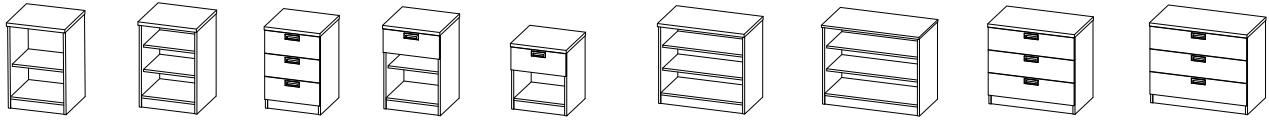

CUSTOM CAPABILITY

Krug offers standard products in custom sizes in addition to completely customized units.

CLEANABILITY

Juno Behavioral Health casegoods manufactured with Krug standard laminates can be cleaned with mild soap and warm water. Do not use steel wool, hot water, or any other abrasive cleaning product. For non-standard laminates, follow the manufacturer's instructions. Solid surface tops can be cleaned with 5% bleach diluted solutions.

<https://krug.ca/wp-content/uploads/2023/11/Cleaning-Guidelines.pdf>

ENVIRONMENTAL FEATURES

Juno Behavioral Health casegoods are manufactured with a significant amount of recycled content that contributes to both LEED credits 4.1 and 4.2. In addition, the freight packaging is recyclable and Greenguard certification is an option.

DURABILITY

Juno Behavioral Health casegoods are manufactured with ¾" low-pressure laminate panels that are glued and dowelled for superior strength, safety and durability. All exposed particle board has 3mm polymer edge-banding to restrict moisture and bacteria from seeping into the core. Tamper-resistant hardware is used to attach doors, drawers, pulls and J-bars..

TOPS

Tops on bedside tables, dressers and desks are 1" thick low-pressure laminate with particle board core and 3mm polymer edge-banding. Tops on wardrobes are ¾" thick low-pressure laminate with 3mm polymer edge-banding and feature a 25-degree slope.

DRAWERS

Drawers feature white metal sides with integrated glides for easy cleaning and disinfection and white low-pressure laminate backs and base panels. All exposed particle board has 3mm polymer edge-banding. Drawers are fixed and non-removable.

DRAWER FRONTS

Drawer fronts are ¾" thick low-pressure laminate with 3mm polymer edge-banding and are installed with tamper-resistant hardware.

DOOR AND DRAWER PULL

Drawer pulls are inset to reduce ligature risk and are installed with tamper-resistant hardware.

DOOR HINGES

Wardrobe doors are attached with a heavy gauge steel piano hinge that is ligature-resistant. The hinge is installed with tamper-resistant hardware.

SHELVES

Shelves on bedside tables, dressers and desks are inset 2", fixed and non-removable. Shelves on wardrobes are inset 7", fixed and non-removable. Reverse stair step shelving is also available on wardrobes.

BASE RAIL

Cabinets feature a ¾" low-pressure laminate base rail that restricts access to the underside of the cabinet.

PLATFORM BEDS

Juno Behavioral Health platform beds feature double wall construction and are completely enclosed. Non-removable, non-pickable caulking is installed around the deck perimeter, minimizing the risk of access to the core and reducing the risk of fluids seeping into the interior.

MATTRESS

The Juno Behavioral Health mattress has a durable tear, puncture and fluid resistant anti-microbial vinyl cover over a polyurethane foam core. Welded seams reduce the risk of bed bugs and the moisture barrier supports infection control..

HARDWARE

All hardware is tamper-resistant.

WARRANTY

Juno Behavioral Health casegoods have a lifetime warranty.

JUNO BEHAVIORAL HEALTH | OPTIONS



Anchor Brackets

Tamper-resistant anchor brackets are available to attach casegoods and beds to wall or floor for additional safety and security. Krug provides the hardware to attach to the wall or floor.



Lower Wardrobe Shelf

Wardrobes with J-Bars are available with an optional lower shelf that is 12" above finished base panel.



Restraint Brackets

Four stainless steel restraint brackets are installed on both sides of the bed



High Pressure Laminate

Casegoods can be specified in high pressure laminate for an upcharge.



JUNO BEHAVIORAL HEALTH | FINISHES

STANDARD LAMINATE PROGRAM

All colors are available in laminate, and high-pressure laminate. Polymer Edge banding matches the laminate selections

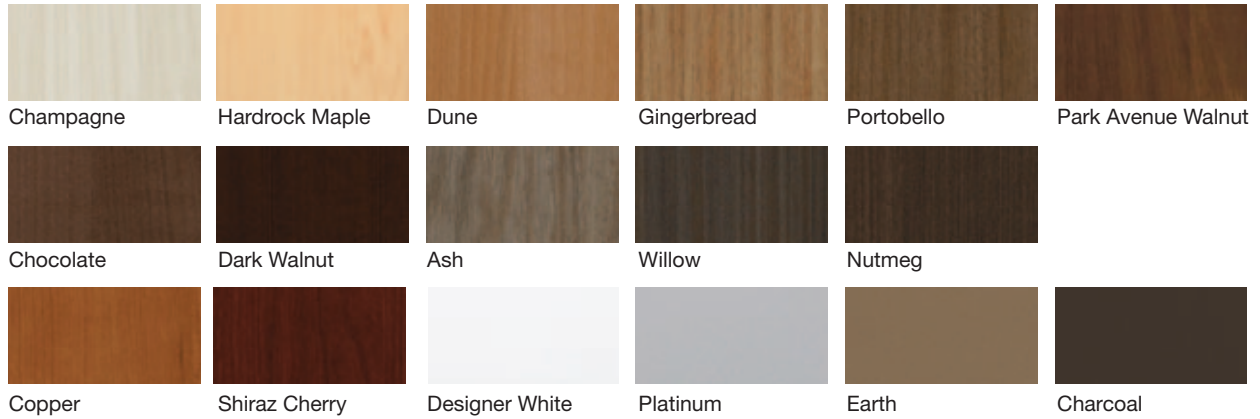

SOLID SURFACE PROGRAM

The Solid Surface option provides an enhanced durability, protection and cleanability. It is available in 8 standard colors and is replaceable if it becomes damaged or degraded. See individual products for list upcharge chart.

GROUP GRADE A - WHITE

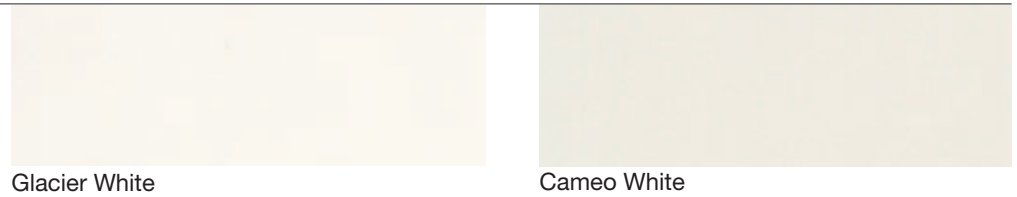

GROUP GRADE A - COLOR

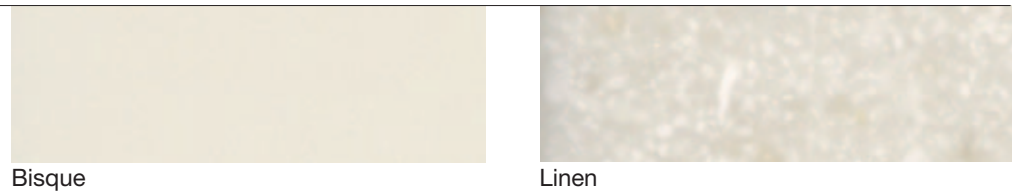

GROUP GRADE B



GROUP GRADE C

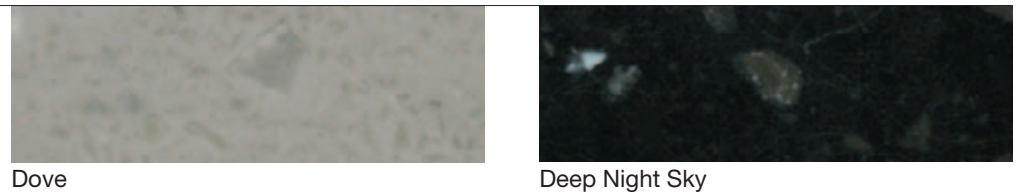

JUNO BEHAVIORAL HEALTH | BEDSIDE TABLES

Description	Model	Laminate	Width	Depth	Shipping Height	Weight	Cube
Open, One Shelf	JBHB7209	1024	20.25	19.25	30	74	8
							
Open, Two Shelves	JBHB8209	1100	20.25	19.25	30	78	8
							
1 Drawer, 1 Fixed Shelf	JBHB2209	1320	20.25	19.25	30	74	8
							
1 Drawer	JBHB3209	1188	20.25	19.25	24	62	8
							
3 Drawer	JBHB4209	1606	20.25	19.25	30	89	8
							

Required to Specify

1. Model number
2. Top Color (Page 508)
3. Body Color (Page 508)
4. Options (right)

Option Upcharges

	\$ List
Solid Surface Top - Gr A White	497
Solid Surface Top - Gr A Color	546
Solid Surface Top - Gr B	615
Solid Surface Top - Gr C	713
Spill Guard	87
Anchor Bracket - (per pair)	76

PRODUCT CODE KEY

Product Line	Description	Style	Width	Base Style	Top Option
JBH	B	2	20	9	SS
Juno Behavioral Health	Bedside Table	1 Drawer, 1 Fixed Shelf	20 inches	Platform	Solid Surface
		3			
		1 Drawer			
		4			
		3 Drawer			
		7			
		Open, 1 Fixed Shelf			
		8			
		Open, 2 Fixed Shelves			

JUNO BEHAVIORAL HEALTH | DRESSERS

Description	Model	Laminate - L	Width	Depth	Height	Shipping Weight	Cube
30" Open Dresser	JBHD7309	1242	30	19.75	30	90	13



36" Open Dresser	JBHD7369	1325	35.75	19.75	30	92	16
------------------	----------	------	-------	-------	----	----	----

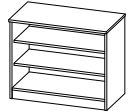

30" 3 Drawer Dresser	JBHD4309	1932	30	19.75	30	112	13
----------------------	----------	------	----	-------	----	-----	----



36" 3 Drawer Dresser	JBHD4369	2034	35.75	19.75	30	125	16
----------------------	----------	------	-------	-------	----	-----	----



Required to Specify

1. Model number
2. Top Color (Page 508)
3. Body Color (Page 508)
4. Options (right)

Option Upcharges

	30" \$ List	36" \$ List
Solid Surface Top - Gr A White	610	661
Solid Surface Top - Gr A Color	679	745
Solid Surface Top - Gr B	780	861
Solid Surface Top - Gr C	899	1002
Anchor Bracket - (per pair)	76	

PRODUCT CODE KEY

Product Line	Description	Style	Width	Base Style	Top Option
JBH	D	4	30	9	SS
Juno Behavioral Health	Dresser	3 Drawer	30 inches	Platform	Solid Surface
		7	36		
		Open	36 inches		

JUNO BEHAVIORAL HEALTH | SINGLE STORAGE

Description	Model	Laminate - L	Width	Depth	Height	Shipping Weight	Cube
Single Storage Open, Inset Shelves	JBHS7249N	1901	23.25	23.75	70/79.75	164	21

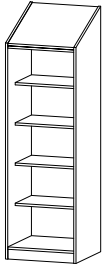

Single Storage Closed, Inset Shelves	JBHS1249L	2404	23.25	23.75	70/79.75	196	32
	JBHS1249R	2404	23.25	23.75	70/79.75	196	32



Required to Specify

1. Model number
2. Body Color (Page 508)
3. Options (below)

Options

Anchor Bracket - (per pair) \$76

PRODUCT CODE KEY

Product Line	Description	Style	Width	Base Style	Orientation (hinge side when facing cabinet)
JBH	S	1	24	9	L
Juno Behavioral Health	Storage	Closed Inset Shelves	24 inches	Platform	Left
		7			R
		Open Inset Shelves			Right
					N
					Not Applicable

JUNO BEHAVIORAL HEALTH | SINGLE STORAGE

Description	Model	Laminate - L	Width	Depth	Height	Shipping Weight	Cube
Single Storage Open Reverse Stair Step Shelves	JBHS8249N	1901	23.25	23.75	70/79.75	160	32

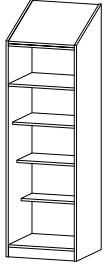

Single Storage Closed, Reverse Stair Step Shelves	JBHS2249L	2404	23.25	23.75	70/79.75	191	32
	JBHS2249R	2404	23.25	23.75	70/79.75	191	32

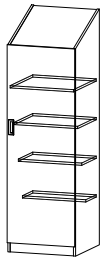

Required to Specify

1. Model number
2. Body Color (Page 508)
3. Options (below)

Options

Anchor Bracket - (per pair) \$76

PRODUCT CODE KEY

Product Line	Description	Style	Width	Base Style	Orientation (hinge side when facing cabinet)
JBH	S	2	24	9	L
Junio Behavioral Health	Storage	Closed Reverse Stair Step Shelves	24 inches	Platform	Left
		8			R
		Open Reverse Stair Step Shelves			Right
					N
					Not Applicable

JUNO BEHAVIORAL HEALTH | SINGLE STORAGE

Description	Model	Laminate	Width	Depth	Height	Shipping Weight	Cube
Single Wardrobe Open, J-Bar and Shelf	JBHW7249N	2149	23.25	23.75	70/79.75	145	32

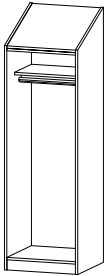

Single Wardrobe Closed, J-Bar and Shelf	JBHW1249L	2666	23.25	23.75	70/79.75	177	32
	JBHW1249R	2666	23.25	23.75	70/79.75	177	32

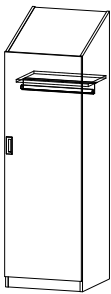

Required to Specify

1. Model number
2. Body Color (Page 508)
3. Options (below)

Options

Anchor Bracket - \$76
 Lower Shelf - \$97

PRODUCT CODE KEY

Product Line	Description	Style	Width	Base Style	Orientation (hinge side when facing cabinet)
JBH	W	1	24	9	L
Juno Behavioral Health	Wardrobe	Closed Inset Shelves	24 inches	Platform	Left
		7			R
		Open Inset Shelves			Right
					N
					Not Applicable

JUNO BEHAVIORAL HEALTH | DOUBLE WARDROBE

Description	Model	Laminate - L	Width	Depth	Height	Shipping Weight	Cube
Double Storage Open, Inset Shelves	JBHS7369N	2613	35.75	23.75	70/79.75	248	47

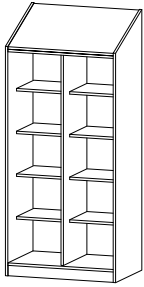

Double Storage Closed, Inset Shelves	JBHS1369N	3495	35.75	23.75	70/79.75	294	47
--------------------------------------	-----------	------	-------	-------	----------	-----	----

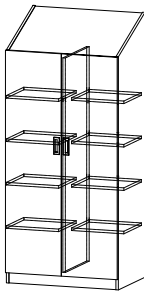

Required to Specify

1. Model number
2. Body Color (Page 508)
3. Options (below)

Options

Anchor Bracket - \$76

PRODUCT CODE KEY

Product Line	Description	Style	Width	Base Style	Orientation (hinge side when facing cabinet)
JBH	S	1	36	9	L
Juno Behavioral Health	Storage	Closed Inset Shelves	36 inches	Platform	Left
		7			R
		Open Inset Shelves			Right
					N
					Not Applicable

JUNO BEHAVIORAL HEALTH | DOUBLE STORAGE

Description	Model	Laminate - L	Width	Depth	Height	Shipping Weight	Cube
Double Storage Open, Reverse Stair Step Shelves	JBHS8369N	2613	35.75	23.75	70/79.75	246	47

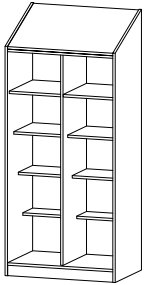

Double Storage Closed, Reverse Stair Step Shelves	JBHS2369N	3495	35.75	23.75	70/79.75	292	47
---	-----------	------	-------	-------	----------	-----	----

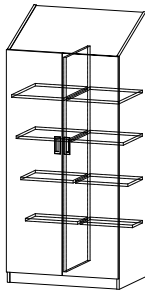

Required to Specify

1. Model number
2. Body Color (Page 508)
3. Options (below)

Options

Anchor Bracket - \$76

PRODUCT CODE KEY

Product Line	Description	Style	Width	Base Style	Orientation (hinge side when facing cabinet)
JBH	S	2	36	9	L
Juno Behavioral Health	Storage	Closed Reverse Stair Step Shelves	36 inches	Platform	Left
		8			R
		Open Reverse Stair Step Shelves			Right
					N
					Not Applicable

JUNO BEHAVIORAL HEALTH | DOUBLE WARDROBE/STORAGE

Description	Model	Laminate - L	Width	Depth	Height	Shipping Weight	Cube
Double Wardrobe/Storage	JBHW7369L	2848	35.75	23.75	70/79.25	234	47
Open, Inset Shelves	JBHW7369R	2848	35.75	23.75	70/79.25		

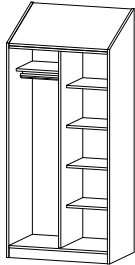

Double Wardrobe/Storage	JBHW1369L	3731	35.75	23.75	70/79.25	280	47
Closed, Inset Shelves	JBHW1369R	3731	35.75	23.75	70/79.25	280	47

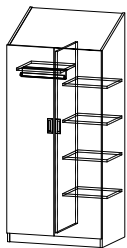

Required to Specify

1. Model number
2. Body Color (Page 508)
3. Options (below)

Options

Anchor Bracket -	\$76
Lower Shelf -	\$97

PRODUCT CODE KEY

Product Line	Description	Style	Width	Base Style	Orientation (hinge side when facing cabinet)
JBH	W	1	36	9	L
Juno Behavioral Health	Wardrobe	Closed Inset Shelves	36 inches	Platform	Left
		7			R
		Open Inset Shelves			Right
					N
					Not Applicable

JUNO BEHAVIORAL HEALTH | DOUBLE WARDROBE/STORAGE

Description	Model	Laminate - L	Width	Depth	Height	Shipping Weight	Cube
Double Storage Open, Reverse Stair Step Shelves	JBHW8369L	2848	35.75	23.75	70/79.75	232	47
	JBHW8369R	2848	35.75	23.75	70/79.75	232	47

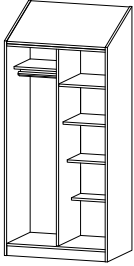

Double Storage Closed, Reverse Stair Step Shelves	JBHW236L	3731	35.75	23.75	70/79.75	278	47
	JBHW236R	3731	35.75	23.75	70/79.75	278	47



Required to Specify

1. Model number (directly preceding - add L or R to designate material)
2. Body Color (Page 508)
3. Options (below)

Options

Anchor Bracket -	\$76
Lower Shelf -	\$97

PRODUCT CODE KEY

Product Line	Description	Style	Width	Base Style	Orientation (hinge side when facing cabinet)
JBH	W	2	36	9	L
Juno Behavioral Health	Wardrobe	Closed Reverse Stair Step Shelves	36 inches	Platform	Left
		8			R
		Open Reverse Stair Step Shelves			Right
					N
					Not Applicable

JUNO BEHAVIORAL HEALTH | SINGLE STORAGE

Description	Model	Laminate	Width	Depth	Height	Shipping Weight	Cube
Double Wardrobe Open, J-Bar and Shelf	JBHW7369N	2784	35.75	23.75	70/79.75	232	47

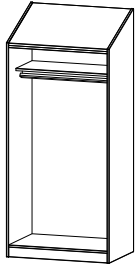

Double Wardrobe Closed, J-Bar and Shelf	JBHW1369L	3667	35.75	23.75	70/79.75	278	47
--	-----------	------	-------	-------	----------	-----	----



Required to Specify

1. Model number
2. Body Color (Page 508)
3. Options (below)

Options

Anchor Bracket - \$76
Lower Shelf - \$115

PRODUCT CODE KEY

Product Line	Description	Style	Width	Base Style	Orientation (hinge side when facing cabinet)
JBH	W	1	36	9	L
Juno Behavioral Health	Wardrobe	Closed Inset Shelves	36 inches	Platform	Left
		7			R
		Open Inset Shelves			Right
					N
					Not Applicable

JUNO BEHAVIORAL HEALTH | DESK

Description	Model	Laminate - L	Width	Depth	Height	Shipping Weight	Cube
Desk Shell	JBHDS1369N	913	35.75	19.25	30	90	16
	JBHDS1489N	1167	47.75	19.25	30	101	21

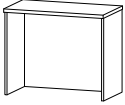

Desk Shell with 3 Shelves	JBHDS3489L	1647	47.75	19.25	30	165	21
	JBHDS3489R	1647	47.75	19.25	30	165	21

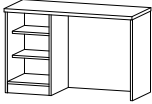

Desk Shell with drawers	JBHDS4489L	2132	47.75	19.25	30	188	21
	JBHDS4489R	2132	47.75	19.25	30	188	21

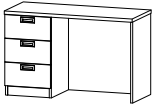

Required to Specify

1. Model number
2. Top Color (Page 508)
3. Body Color (Page 508)
4. Options (right)

Option Upcharges

	36" \$ List	48" \$ List
Solid Surface Top - Gr A White	661	842
Solid Surface Top - Gr A Color	745	952
Solid Surface Top - Gr B	861	1108
Solid Surface Top - Gr C	1002	1295
Anchor Bracket - AB	76	

PRODUCT CODE KEY

Product Line	Description	Style	Width	Base Style	Orientation (when facing cabinet)
JBH	DS	1	36	9	L
Juno Behavioral Health	Desk Shell	Open	36 inches	Platform	Drawers/Shelves Left
		3	48		R
		Shelves	48 inches		Drawers/Shelves Right
		4			N
		Drawers			Not Applicable

JUNO BEHAVIORAL HEALTH | PLATFORM BED

Description	Model	Laminate	Width	Length	Height	Shipping Weight	Cube
Single Platform Bed, without Headboard	JBHP1389 N	2797	40	82	14.75	285	52.5

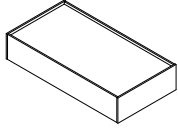

Double Platform Bed, without Headboard	JBHP1549N	3326	55.75	82	14.75	390	71.5
--	-----------	------	-------	----	-------	-----	------

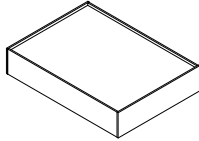

Single Platform Bed, with Headboard	JBHP2389N	2949	40	82	23.25	300	60
-------------------------------------	-----------	------	----	----	-------	-----	----

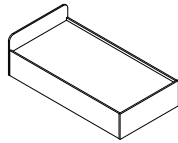

Double Platform Bed with Headboard	JBHP2549N	3458	55.75	82	23.25	405	80
------------------------------------	-----------	------	-------	----	-------	-----	----

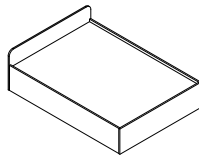

Note: All platform beds have an unfinished plywood frame and do not include a mattress, see page 522 for mattress selection.

Required to Specify

1. Model number
2. Body Color (Page 508)
3. Options (below)

Options

- Anchor Bracket - \$76
- Restraint Brackets (per pair) - \$376

PRODUCT CODE KEY

Product Line	Description	Style	Width	Base Style	Orientation (when facing cabinet)
JBH Juno Behavioral Health	P Platform Bed	1 Bed	38 Single Width	9 Platform	L Bedside Left
		2 Bed with Headboard	54 Double Width		R Bedside Right
		3 Bed with Attached Bedside			N Not Applicable
		4 Bed with Headboard & Attached Bedside			

JUNO BEHAVIORAL HEALTH | PLATFORM BED

Description	Model	Laminate	Width	Length	Height	Shipping Weight	Cube
Single Platform Bed, Attached Bedside without Headboard	JBHP3389L	3821	51.5	82	14.75	315	66.5
	JBHP3389R	3821	51.5	82	14.75	315	66.5

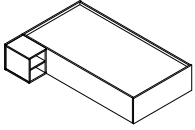

Double Platform Bed Attached Bedside without Headboard	JBHP3549L	4462	55.75	82	14.75	415	86
	JBHP3549R	4462	55.75	82	14.75	415	86

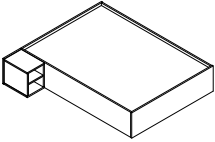

Single Platform Bed Attached Bedside with Headboard	JBHP4549L	3993	51.5	82	23.25	404	78
	JBHP4549R	3993	51.5	82	23.25	404	78

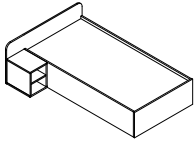

Double Platform Bed Attached Bedside with Headboard	JBHP4549L	4502	67.5	82	23.25	415	88
	JBHP4549R	4502	67.5	82	23.25	415	88

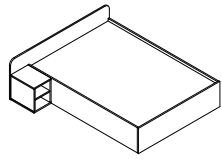

Note: All platform beds have an unfinished plywood frame and do not include a mattress, see page 522 for mattress selection.

Required to Specify

1. Model number
2. Body Color (Page 508)
3. Options (below)

Options

- Anchor Bracket - \$76
- Restraint Brackets (per pair) - \$376

PRODUCT CODE KEY

Product Line	Description	Style	Width	Base Style	Orientation (when facing cabinet)
JBH	P	1	38	9	L
Juno Behavioral Health	Platform Bed	Bed	Single Width	Platform	Bedside Left
		2	54		R
		Bed with Headboard	Double Width		Bedside Right
		3			N
		Bed with Attached Bedside			Not Applicable
		4			
		Bed with Headboard & Attached Bedside			

JUNO BEHAVIORAL HEALTH | PLATFORM BED

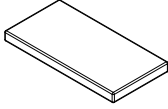
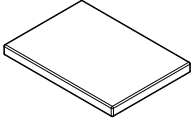
Description	Model	Seamless	Width	Depth	Height	Shipping Weight	Cube
Single Mattress	JBHM538S	1170	38	80	6	18	17
	Integrated Pillow JBHM38SIP	1342					
Double Mattress	JBHM554S	1702	54	80	6	29	25
	Integrated Pillow JBHM38SIP	1938					

PRODUCT CODE KEY

Product Line	Description	Width	Style
JBH Juno Behavioral Health	M Mattress	38 Single Width	S Standard
		54 Double Width	IP Integrated Pillow

OCCASIONAL TABLES

- 524 Karma
- 529 Cressida
- 535 Leyton
- 537 Faeron Wood
- 541 Faeron Metal
- 544 Zola
- 549 Jordan
- 552 Solis

LEED CI CREDITS



MATERIAL CONTENT:

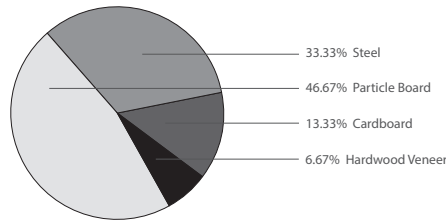

PRE-CONSUMER RECYCLED CONTENT = 29.17%

POST-CONSUMER RECYCLED CONTENT = 42.67%

Up to 46.67% of this Karma product is recyclable at the end of its useful life.

CONTRIBUTES TO

CREDIT 2.1 - 2.2	Construction Waste Management	1-2 point(s)
CREDIT 3.3	Resource Reuse	1 point
CREDIT 4.1	Recycled Content	1 point
CREDIT 4.2	Recycled Content	1 point
CREDIT 4.5	Low Emitting Materials, Systems & Seating	1 point
CREDIT 5.1	Regional Materials*	1 point
CREDIT 7	Certified Wood (MUST BE REQUESTED)	1 point(s)

*This credit is only applicable if in total 20% of the combined value of the procurement of construction materials and in the furniture are manufactured within a radius of 500 miles. This credit will apply if the installation of the finished product occurs within 500 miles of Kitchener, Ontario.

level® CERTIFICATION, AIR EMISSIONS AND FSC® CERTIFICATION



level® CERTIFICATION

BIFMA's e3 Furniture Sustainability Standard is a voluntary, multi-attribute standard that measures the degree of sustainability of furniture. This standard evaluates product and company environmental attributes and compliance systems in a wide range of elements which include Materials, Energy & Atmosphere, Human & Ecosystem Health and Social Responsibility. Karma products have earned level®, BIFMA's sustainability certification program for furniture, certification through third-party verification against the e3 standard.

AIR-EMISSIONS

All Karma products are supplied with air-emissions certified. Contact customer service for information.



FSC®

In 2005, Krug received Forest Stewardship Council® (FSC®) Chain-of-Custody certification for our manufacturing facilities. The FSC® Chain-of-Custody tracks certified wood from seedling to final sale. It verifies that the material for our FSC® certified products only come from well-managed, FSC®-certified forests and other controlled sources. FSC® is dedicated to the promotion of responsible forest management worldwide helping to take care of forests for future generations. Karma and other Krug products can be specified with FSC® Certification. Contact customer service for further information, pricing and lead times.



Architects, designers, and building professionals can specify FSC®-certified products in order to achieve a point from the U.S. Green Building Council's Leadership in Energy and Environmental Design (LEED) Rating System.

KARMA | FREE STANDING TABLES

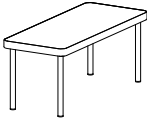
Description	Model	Beech/ Palette	Laminate top w/Wood Edge	Laminate top w/ Polymer Edge	W	D	H	Weight	Cube
	Square & Rectangular Tables, Matte Black or Silver Metallic legs								
	KAR4 18-18-18	706	853	569	17.5	17.5	17.5	15	2.6
	KAR4 22-18-18	741	879	585	22	17.5	17.5	16.5	2.6
	KAR4 42-18-18	1114	1004	985	42	17.5	17.5	24.5	4.6
	KAR4 18-18-21	722	868	585	17.5	17.5	21	17	3
	KAR4 22-18-21	757	892	597	22	17.5	21	18.5	3
	KAR4 42-18-21	1128	1183	999	42	17.5	21	26.5	4.6
	Square & Rectangular Tables, Polished Chrome legs								
	KAR4 18-18-18	834	982	696	17.5	17.5	17.5	15	2.6
	KAR4 22-18-18	870	1006	710	22	17.5	17.5	16.5	2.6
	KAR4 42-18-18	1241	1134	1114	42	17.5	17.5	24.5	4.6
	KAR4 18-18-21	864	1009	725	17.5	17.5	21	17	3
KAR4 22-18-21	898	1034	739	22	17.5	21	16.5	2.6	
KAR4 42-18-21	1270	1327	1139	42	17.5	21	24.5	4.6	
ORDERING NOTE: For leg finish add to the end of the model number; B for Matte Black, S for Silver Metallic and C for Polished Chrome									

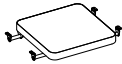
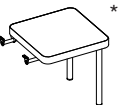

	Round Tables, Matte Black or Silver Metallic legs									
	KAR4 24D-18	877	1197	687	24	-	17.5	19	3.5	
	KAR4 36D-18	1199	1349	753	36	-	17.5	31	7.3	
	KAR4 24D-21	889	1212	701	24	-	21	21	3.5	
	KAR4 36D-21	1213	1363	767	36	-	21	33	7.3	
	Round Tables, Polished Chrome legs									
	KAR4 24D-18	1004	1323	811	24	-	17.5	19	3.5	
	KAR4 36D-18	1361	1513	916	36	-	17.5	31	7.3	
	KAR4 24D-21	1032	1354	843	24	-	21	21	3.5	
	KAR4 36D-21	1391	1540	946	36	-	21	33	7.3	
	ORDERING NOTE: For leg finish add to the end of the model number; B for Matte Black, S for Silver Metallic and C for Polished Chrome									

KARMA | LINKING TABLES

Description	Model	Beech/ Palette	Laminate top w/Wood Edge	Laminate top w/ PVC Edge	W	D	H	Weight	Cube
	Square Straight Linking Table, Matte Black or Silver Metallic, Left or Right handed (Same direction seating)								
	KAR4-LKII-18-18	685	830	543	17.5	17.5	-	15	2.5
	Square Straight Linking Table, Matte Black or Silver Metallic, Left handed as seated (Opposed seating)								
	KAR4-LKIL-18-18	685	830	543	17.5	17.5	-	15	2.5
	Square Straight Linking Table, Matte Black or Silver Metallic, Right handed as seated (Opposed seating)								
	KAR4-LKIR-18-18	685	830	543	17.5	17.5	-	15	2.5
	Square Straight Linking Table, Polished Chrome, Left or Right handed (Same direction seating)								
	KAR4-LKII-18-18	834	982	696	17.5	17.5	-	15	2.5
	Square Straight Linking Table, Polished Chrome, Left handed as seated (Opposed seating)								
KAR4-LKIL-18-18	834	982	696	17.5	17.5	-	15	2.5	
Square Straight Linking Table, Polished Chrome, Right handed as seated (Opposed seating)									
KAR4-LKIR-18-18	834	982	696	17.5	17.5	-	15	2.5	
	Square Straight Linking End Table, Matte Black or Silver Metallic legs, Left handed as seated								
	KAR4-LKEL-18-18*	694	838	556	17.5	17.5	17.5	15	2.5
	Square Straight Linking End Table, Matte Black or Silver Metallic legs, Right handed as seated								
	KAR4-LKER-18-18	694	838	556	17.5	17.5	17.5	15	2.5
	Square Straight Linking End Table, Polished Chrome legs, Left handed as seated								
KAR4-LKEL-18-18*	848	994	710	17.5	17.5	17.5	15	2.5	
Square Straight Linking End Table, Polished Chrome legs, Right handed as seated									
KAR4-LKER-18-18	848	994	710	17.5	17.5	17.5	15	2.5	

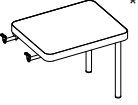

ORDERING NOTES: A drawing showing the configuration of the multiple seating and tables is required with each purchase order. See page 528 for suggested configurations.

KARMA | LINKING TABLES

Description	Model	Beech/ Palette	Laminate top w/Wood Edge	Laminate top w/ PVC Edge	W	D	H	Weight	Cube
	Rectangular Straight Linking Table, Matte Black or Silver Metallic, Left or Right handed (Same direction seating)								
	KAR4-LKII-22-18	721	854	560	22	17.5	-	16.5	2.8
	Rectangular Straight Linking Table, Matte Black or Silver Metallic, Left handed as seated (Opposed seating)								
	KAR4-LKIL-22-18	721	854	560	22	17.5	-	16.5	2.8
	Rectangular Straight Linking Table, Matte Black or Silver Metallic, Right handed as seated (Opposed seating)								
	KAR4-LKIR-22-18	721	854	560	22	17.5	-	16.5	2.8
	Rectangular Straight Linking Table, Polished Chrome, Left or Right handed (Same direction seating)								
KAR4-LKII-22-18	871	1008	710	22	17.5	-	16.5	2.8	
Rectangular Straight Linking Table, Polished Chrome, Left handed as seated (Opposed seating)									
KAR4-LKIL-22-18	871	1008	710	22	17.5	-	16.5	2.8	
Rectangular Straight Linking Table, Polished Chrome, Right handed as seated (Opposed seating)									
KAR4-LKIR-22-18	871	1008	710	22	17.5	-	16.5	2.8	
	Rectangular Straight Linking End Table, Matte Black or Silver Metallic, Left handed as seated (Opposed seating)								
	KAR4-LKEL-22-18*	729	865	569	22	17.5	17.5	16.5	2.8
	Rectangular Straight Linking End Table, Matte Black or Silver Metallic, Right handed as seated (Opposed seating)								
	KAR4-LKER-22-18	729	865	569	22	17.5	17.5	16.5	2.8
	Rectangular Straight Linking End Table, Polished Chrome, Left handed as seated (Opposed seating)								
KAR4-LKEL-22-18*	883	1018	725	22	17.5	17.5	16.5	2.8	
Rectangular Straight Linking End Table, Polished Chrome, Right handed as seated (Opposed seating)									
KAR4-LKER-22-18	883	1018	725	22	17.5	17.5	16.5	2.8	
	Curvilinear Connector Table 45°, Matte Black or Silver Metallic, Left or Right handed (Same direction, inward seating)								
	KAR4-LKCI-RF45	984	1434	781	28	24	-	19	4.2
	Curvilinear Connector Table 45°, Matte Black or Silver Metallic, Left or Right handed (Same direction, outward seating)								
	KAR4-LKCO-RF45	984	1434	781	28	24	-	19	4.2
	Curvilinear Connector Table 45°, Matte Black or Silver Metallic, Left handed as seated (Opposed seating)								
	KAR4-LKCL-RF45	984	1434	781	28	24	-	19	4.2
	Curvilinear Connector Table 45°, Matte Black or Silver Metallic, Right handed as seated (Opposed seating)								
	KAR4-LKCR-RF45	984	1434	781	28	24	-	19	4.2
	Curvilinear Connector Table 45°, Polished Chrome, Left or Right handed (Same direction, inward seating)								
	KAR4-LKCI-RF45	1136	1451	931	28	24	-	19	4.2
	Curvilinear Connector Table 45°, Polished Chrome, Left or Right handed (Same direction, outward seating)								
	KAR4-LKCO-RF45	1136	1451	931	28	24	-	19	4.2
Curvilinear Connector Table 45°, Polished Chrome, Left handed as seated (Opposed seating)									
KAR4-LKCL-RF45	1136	1451	931	28	24	-	19	4.2	
Curvilinear Connector Table 45°, Polished Chrome, Right handed as seated (Opposed seating)									
KAR4-LKCR-RF45	1136	1451	931	28	24	-	19	4.2	
	Curvilinear Connector Table 45° Matte Black or Silver Metallic, with Flat edge, Left or Right handed (Same direction, inward seating)								
	KAR4-LKCI-RR45	1017	1478	819	28	24	-	19	4.2
	Curvilinear Connector Table 45° Matte Black or Silver Metallic, with Flat edge, Left or Right handed (Same direction, outward seating)								
	KAR4-LKCO-RR45	1017	1478	819	28	24	-	19	4.2
	Curvilinear Connector Table 45° Matte Black or Silver Metallic, with Flat edge, Left handed as seated (Opposed seating)								
	KAR4-LKCL-RR45	1017	1478	819	28	24	-	19	4.2
	Curvilinear Connector Table 45° Matte Black or Silver Metallic, with Flat edge, Right handed as seated (Opposed seating)								
	KAR4-LKCR-RR45	1017	1478	819	28	24	-	19	4.2
	Curvilinear Connector Table 45° Polished Chrome, with Flat edge, Left or Right handed (Same direction, inward seating)								
	KAR4-LKCI-RR45	1168	1629	968	28	24	-	19	4.2
	Curvilinear Connector Table 45° Polished Chrome, with Flat edge, Left or Right handed (Same direction, outward seating)								
	KAR4-LKCO-RR45	1168	1629	968	28	24	-	19	4.2
Curvilinear Connector Table 45° Polished Chrome, with Flat edge, Left handed as seated (Opposed seating)									
KAR4-LKCL-RR45	1168	1629	968	28	24	-	19	4.2	
Curvilinear Connector Table 45° Polished Chrome, with Flat edge, Right handed as seated (Opposed seating)									
KAR4-LKCR-RR45	1168	1629	968	28	24	-	19	4.2	

ORDERING NOTES: A drawing showing the configuration of the multiple seating and tables is required with each purchase order. See page 528 for suggested configurations.

KARMA | LINKING TABLES

Description	Model	Beech/ Palette	Laminate top w/Wood Edge	Laminate top w/ PVC Edge	W	D	H	Weight	Cube
	Curvilinear Connector Table 90°, Matte Black or Silver Metallic, Left or Right handed (Same direction, inward seating)								
	KAR4-LKCI-RR90	1281	1856	1027	38	24	-	22	5.5
	Curvilinear Connector Table 90°, Matte Black or Silver Metallic, Left or Right handed (Same direction, outward seating)								
	KAR4-LKCO-RR90	1281	1856	1027	38	24	-	22	5.5
	Curvilinear Connector Table 90°, Matte Black or Silver Metallic, Left handed as seated (Opposed seating)								
	KAR4-LKCL-RR90	1281	1856	1027	38	24	-	22	5.5
	Curvilinear Connector Table 90°, Matte Black or Silver Metallic, Right handed as seated (Opposed seating)								
	KAR4-LKCR-RR90	1281	1856	1027	38	24	-	22	5.5
	Curvilinear Connector Table 90°, Polished Chrome, Left or Right handed (Same direction, inward seating)								
	KAR4-LKCI-RR90	1430	2006	1177	38	24	-	22	5.5
	Curvilinear Connector Table 90°, Polished Chrome, Left or Right handed (Same direction, outward seating)								
	KAR4-LKCO-RR90	1430	2006	1177	38	24	-	22	5.5
Curvilinear Connector Table 90°, Polished Chrome, Left handed as seated (Opposed seating)									
KAR4-LKCL-RR90	1430	2006	1177	38	24	-	22	5.5	
Curvilinear Connector Table 90°, Polished Chrome, Right handed as seated (Opposed seating)									
KAR4-LKCR-RR90	1430	2006	1177	38	24	-	22	5.5	
	Curvilinear Connector Table 90° with Matte Black or Silver Metallic, Flat edge, Left or Right handed (Same direction, inward seating)								
	KAR4-LKCI-RF90	1206	1912	1059	38	24	-	22	5.5
	Curvilinear Connector Table 90°, Matte Black or Silver Metallic, with Flat edge, Left or Right handed (Same direction, outward seating)								
	KAR4-LKCO-RF90	1206	1912	1059	38	24	-	22	5.5
	Curvilinear Connector Table 90°, Matte Black or Silver Metallic, with Flat edge, Left handed as seated (Opposed seating)								
	KAR4-LKCL-RF90	1206	1912	1059	38	24	-	22	5.5
	Curvilinear Connector Table 90°, Matte Black or Silver Metallic, with Flat edge, Right handed as seated (Opposed seating)								
	KAR4-LKCR-RF90	1206	1912	1059	38	24	-	22	5.5
	Curvilinear Connector Table 90° Polished Chrome, with Flat edge, Left or Right handed (Same direction, inward seating)								
	KAR4-LKCI-RF90	1467	2061	1207	38	24	-	22	5.5
	Curvilinear Connector Table 90° Polished Chrome, with Flat edge, Left or Right handed (Same direction, outward seating)								
	KAR4-LKCO-RF90	1467	2061	1207	38	24	-	22	5.5
Curvilinear Connector Table 90° Polished Chrome, with Flat edge, Left handed as seated (Opposed seating)									
KAR4-LKCL-RF90	1467	2061	1207	38	24	-	22	5.5	
Curvilinear Connector Table 90° Polished Chrome, with Flat edge, Right handed as seated (Opposed seating)									
KAR4-LKCR-RF90	1467	2061	1207	38	24	-	22	5.5	
	Rectilinear Corner Connector Table 90° Matte Black or Silver Metallic, with Flat edge, Left or Right handed (Same direction, inward seating)								
	KAR4-LKCI-SF90	1431	2076	1147	30	30	-	26	5.5
	Rectilinear Connector Table 90° Matte Black or Silver Metallic, with Flat edge, Left or Right handed (Same direction, outward seating)								
	KAR4-LKCO-SF90	1431	2076	1147	30	30	-	26	5.5
	Rectilinear Connector Table 90°, Matte Black or Silver Metallic, with Flat edge Left handed as seated (Opposed seating)								
	KAR4-LKCL-SF90	1431	2076	1147	30	30	-	26	5.5
	Rectilinear Connector Table 90° Matte Black or Silver Metallic, with Flat edge, Right handed as seated (Opposed seating)								
	KAR4-LKCR-SF90	1431	2076	1147	30	30	-	26	5.5
	Rectilinear Corner Connector Table 90° Polished Chrome, with Flat edge, Left or Right handed (Same direction, inward seating)								
	KAR4-LKCI-SF90	1643	2286	1359	30	30	-	26	5.5
	Rectilinear Connector Table 90° Polished Chrome, with Flat edge, Left or Right handed (Same direction, outward seating)								
	KAR4-LKCO-SF90	1643	2286	1359	30	30	-	26	5.5
Rectilinear Connector Table 90°, Polished Chrome, with Flat edge Left handed as seated (Opposed seating)									
KAR4-LKCL-SF90	1643	2286	1359	30	30	-	26	5.5	
Rectilinear Connector Table 90° Polished Chrome, with Flat edge, Right handed as seated (Opposed seating)									
KAR4-LKCR-SF90	1643	2286	1359	30	30	-	26	5.5	

ORDERING NOTES: A drawing showing the configuration of the multiple seating and tables is required with each purchase order. See page 528 for suggested configurations.

KARMA | LINKING TABLES CONFIGURATIONS

Straight Linking Square Table	Straight Linking Rectangular Table	Linked Table - Corner/Radius 45	Linked Table - Corner/Flat 45	Linked Table - Corner/Radius 90	Linked Table - Corner/Flat 90
KAR4-LKII-18-18	KAR4-LKII-22-18	KAR4-LKCI-RR45	KAR4-LKCI-RF45	KAR4-LKCI-RR90	KAR4-LKCI-RF90
KAR4-LKIL-18-18	KAR4-LKIL-22-18	KAR4-LKCO-RR45	KAR4-LKCO-RF45	KAR4-LKCO-RR90	KAR4-LKCO-RF90
KAR4-LKIR-18-18	KAR4-LKIR-22-18	KAR4-LKCL-RR45	KAR4-LKCL-RF45	KAR4-LKCL-RR90	KAR4-LKCL-RF90
Linked Table - End Square	Linked Table - End Rectangular				
		KAR4-LKCL-RR45	KAR4-LKCL-RF45	KAR4-LKCL-RR90	KAR4-LKCL-RF90
KAR4-LKEL-18-18	KAR4-LKEL-22-18	KAR4-LKCR-RR45	KAR4-LKCR-RF45	KAR4-LKCR-RR90	KAR4-LKCR-RF90
KAR4-LKER-18-18	KAR4-LKER-22-18				

ORDERING NOTES: A drawing showing the configuration of the multiple seating and tables is required with each purchase order.

CRESSIDA | ENVIRONMENTAL SUMMARY

LEED CI CREDITS



MATERIAL CONTENT:

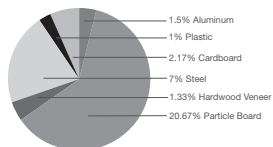

PRE-CONSUMER RECYCLED CONTENT - 36.34%

POST-CONSUMER RECYCLED CONTENT - 26.4%

Up to 31.25% of this Cressida product is recyclable at the end of its useful life.



MATERIAL CONTENT:

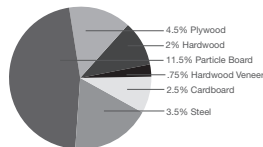

PRE-CONSUMER RECYCLED CONTENT - 30.77%

POST-CONSUMER RECYCLED CONTENT - 25.68%

Up to 27.88% of this Cressida product is recyclable at the end of its useful life.

CONTRIBUTES TO

CREDIT 2.1 - 2.2	Construction Waste Management	1-2 point(s)
CREDIT 3.3	Resource Reuse	1 point
CREDIT 4.1	Recycled Content	1 point
CREDIT 4.2	Recycled Content	1 point
CREDIT 4.5	Low Emitting Materials, Systems & Seating	1 point
CREDIT 5.1	Regional Materials*	1 point
CREDIT 7	Certified Wood (MUST BE REQUESTED)	1 point(s)

*This credit is only applicable if in total 20% of the combined value of the procurement of construction materials and in the furniture are manufactured within a radius of 500 miles. This credit will apply if the installation of the finished product occurs within 500 miles of Kitchener, Ontario.

level® CERTIFICATION, AIR EMISSIONS AND FSC® CERTIFICATION



level® CERTIFICATION

BIFMA's e3 Furniture Sustainability Standard is a voluntary, multi-attribute standard that measures the degree of sustainability of furniture. This standard evaluates product and company environmental attributes and compliance systems in a wide range of elements which include Materials, Energy & Atmosphere, Human & Ecosystem Health and Social Responsibility. Cressida products have earned level®, BIFMA's sustainability certification program for furniture, certification through third-party verification against the e3 standard.

AIR-EMISSIONS

All Cressida products are supplied with air-emissions certified. Contact customer service for information.



FSC®

In 2005, Krug received Forest Stewardship Council® (FSC®) Chain-of-Custody certification for our manufacturing facilities. The FSC® Chain-of-Custody tracks certified wood from seedling to final sale. It verifies that the material for our FSC® certified products only come from well-managed, FSC®-certified forests and other controlled sources. FSC® is dedicated to the promotion of responsible forest management worldwide helping to take care of forests for future generations. Cressida and other Krug products can be specified with FSC® Certification. Contact customer service for further information, pricing and lead times.



Architects, designers, and building professionals can specify FSC®-certified products in order to achieve a point from the U.S. Green Building Council's Leadership in Energy and Environmental Design (LEED) Rating System.

CRESSIDA | TABLE FEATURES

ANTI-MICROBIAL FINISH

Cressida wood surfaces include an anti-microbial finish that inhibits the growth of some molds and mildews. Surfaces coated in this finish support the reduction of fungal growth, and spores from germs, microbes and bacteria

STANDARD FINISHES

For a complete list of standard wood finishes, please see page 630. Cressida tables are available in 22 standard finishes.

LAMINATE

Cressida Box-style tables are available in laminate with wood side or laminate side. See page 631 for laminate information.

SOLID SURFACE

Cressida Box-style & Slab-style tables are available with 1/2" solid surface tops. Cressida Light-style tables are available with full solid surface tops, 1" thick. Please contact customer service for a quote.

CRESSIDA | BOX-STYLE TABLES

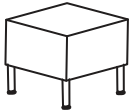
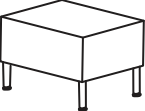
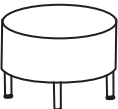
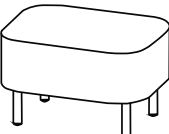
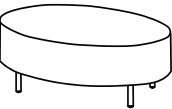
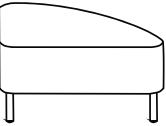
DESCRIPTION	MODEL	BEECH PALETTE LAMINATE	MAPLE	LAMINATE TOP W/BEECH SIDES	LAMINATE TOP W/ MAPLE SIDES	W	D	H	WEIGHT	CUBE
	Square Tables									
	CRE4A 181816	1179	1227	1224	1271	18	18	15.75	24	3
	CRE4A 242416	1458	1515	1508	1567	24	24	15.75	34	5
	Rectangular Tables									
	CRE4A 241816	1295	1347	1338	1393	24	18	15.75	28	4
	CRE4A 482416	2085	2167	2158	2241	48	24	15.75	56	10
	Round Tables									
	CRE4A 18D16	973	1012	1003	1044	18	-	15.75	16	3
	CRE4A 24D16	1187	1236	1338	1393	24	-	15.75	23	5
	CRE4A 30D16	2079	2163	2272	2361	30	-	15.75	34	8
	Rectangular Round Corner									
	CRE4 B181816	1265	1315	1311	1361	18	18	15.75	21	3
	CRE4 B241816	1425	1483	1485	1545	24	18	15.75	25	4
	CRE4 B242416	1583	1644	1686	1752	24	24	15.75	30	5
	CRE4 B482416	2299	2390	2461	2559	48	24	15.75	51	10
	Oval Tables									
	CRE4A E241816	1312	1363	1443	1501	24	18	15.75	23	4
	CRE4A E322416	1620	1686	1753	1825	32	24	15.75	34	7
	CRE4A E482916	2058	2139	2201	2287	48	29	15.75	56	12
	Triangular Round Corner									
	CRE4B T1618-45	1187	1236	1205	1253	16	18	15.75	18	2.5
	CRE4B T2124-45	1359	1415	1411	1465	21	24	15.75	23	4.5
	CRE4B T2529-45	1666	1732	1760	1833	25	29	15.75	28	7
	CRE4B T2818-90	1477	1534	1534	1594	28	18	15.75	24	3
	CRE4B T3624-90	1758	1832	1841	1915	36	24	15.75	30	7.5
	CRE4B T4429-90	2114	2198	2135	2220	44	29	15.75	36	11

TRIANGULAR TABLE DIMENSIONS

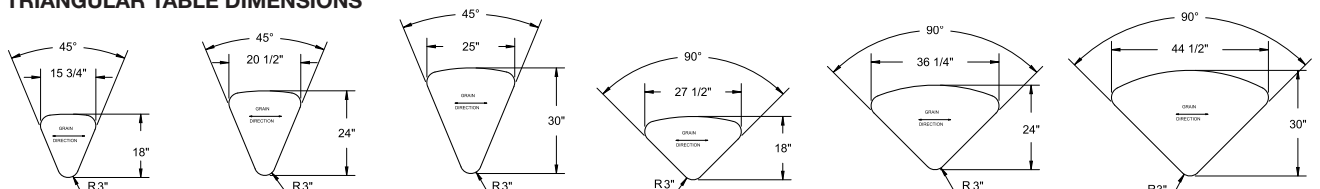

CRESSIDA | BOX-STYLE LINKING TABLES

DESCRIPTION	MODEL	BEECH	MAPLE	LAMINATE TOP	LAMINATE TOP W/	W	D	H	WEIGHT	CUBE
		PALETTE		SIDES	MAPLE					
	Middle Linking Table									
	CRE4 LKI12	939	977	961	1002	12	16	-	22	2.5
	CRE4 LKI18	1065	1109	1116	1162	18	16	-	24	2.9
	CRE4 LKI24	1192	1240	1265	1315	24	16	-	29	3.7

ORDERING NOTE: Middle Linking Modular Table ships with 2 KB1 brackets.

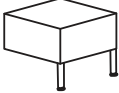
	End Table Square Corners									
	CRE4A LKE12	976	1015	1001	1042	12	16	15.75	19	2.3
	CRE4A LKE18	1103	1146	1153	1201	18	16	15.75	23	2.9
	CRE4A LKE24	1228	1276	1304	1356	24	16	15.75	28	3.7

ORDERING NOTE: End Linking Modular Table ships with 1 KB1 bracket.

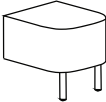
	End Table Rounded Corner									
	CRE4B LKH12	1194	1241	1246	1297	12	16	15.75	19	2.3
	CRE4B LKH18	1298	1349	1356	1411	18	16	15.75	23	2.9

	Curvilinear 30° Table									
	CRE4A LKC30	1102	1143	1177	1224	16	16.5	-	15	2.3

	Curvilinear 45° Table									
	CRE4A LKC45	1279	1331	1358	1414	16	17	-	17	2.9

	Curvilinear 60° Table									
	CRE4A LKC60	1455	1513	1555	1615	16	17.5	-	20	3.7

	Curvilinear 90° Table									
	CRE4A LKC90	1689	1755	1810	1883	16	19	-	24	5.4

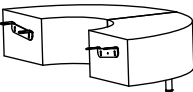
	Curvilinear 90°x2 Table									
	CRE4A LKC90X2	3182	3311	3412	3552	16	19	15.75	55	10

	Curvilinear End Round Table									
	CRE4A LKH12	1212	1262	1265	1315	12	16	15.75	18	2.3
	CRE4A LKH18	1317	1372	1377	1433	18	16	15.75	21	3.6

ORDERING NOTES: When fastening two linking tables together, mounting hardware will be provided when ordered, that will include one leg per table (to a maximum of two legs), which will be mounted on the adjoining seam. Cressida Middle tables have the ability to be easily reconfigured, as they are universal and non-handed. They can be moved to a reverse position in almost any configuration to provide a high level of flexibility when specifying.

CURVILINEAR TABLE DIMENSIONS

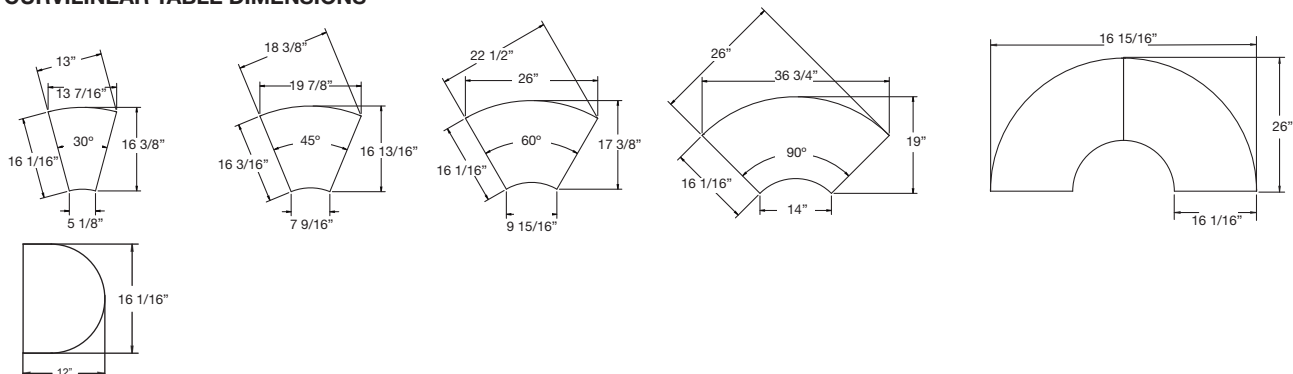

CRESSIDA | SLAB-STYLE LINKING TABLES

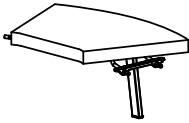
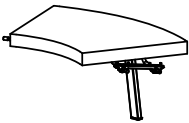
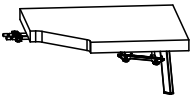
DESCRIPTION	MODEL	BEECH PALETTE LAMINATE	MAPLE	LAMINATE TOP W/BEECH SIDES	LAMINATE TOP W/ MAPLE SIDES	W	D	H	WEIGHT	CUBE	
	Square and Rectangular Slab Table										
	CRE4C LK11818	703	732	679	706	18	18	-	23	1.5	
	CRE4C LK12418	769	803	811	845	24	18	-	26	2.0	
	Curvilinear Slab Table with flat front										
	CRE4C LKCRF45	1029	1066	1045	1088	28	24	16	25	1.8	
	CRE4C LKCRF90	1183	1230	1251	1302	38	24	16	45	3.0	
	Curvilinear Slab Table										
	CRE4C LKCRR45	1029	1066	1045	1088	28	24	16	23	1.8	
	CRE4C LKCRR90	1183	1230	1251	1302	38	24	16	42	3.0	
	Rectilinear Corner table										
CRE4C LKCSF90	1360	1416	1505	1565	30	30	16	52	3.5		

ORDERING NOTES:

Linking tables can be ordered in conjunction with any of the Krug Multiple Seating. Linking tables are connected to the Multiple Seating via Linking brackets. Hardware for tables can be used left or right handed.





The design of the tables for Cressida Multiple Seating allows for any table to be very easily added or moved to a new position within the configuration - or completely replaced - after the product has been first installed. The attachment of the tables is designed so that they can be readily be taken out of the configuration without any defacing of the adjoining seat frames.

Linking Tables also feature a universal, non-handed design:







They can be moved to reverse position in almost any configuration, providing a high level of flexibility for reconfiguring.

A drawing showing the configuration of the multiple seating and tables is required with each purchase order.

CRESSIDA | LIGHT-STYLE TABLES

DESCRIPTION	MODEL	BEECH PALETTE		LAMINATE TOP W/BEECH SIDES	LAMINATE TOP W/ MAPLE SIDES	W	D	H	WEIGHT CUBE		
		LAMINATE	MAPLE								
	Square Tables										
	CRE4D 222216	589	613	672	699	22	22	16	32	5	
	CRE4D 222221	601	626	687	714	22	22	21	34	7	
	CRE4D 422216	832	865	997	1036	42	22	16	55	9	
											
	Soft Square Tables										
	CRE4D 181816S	533	555	596	620	18	18	16	22	3	
	CRE4D 242416S	591	615	688	715	24	24	16	33	5	
	CRE4D 363616S	845	878	1014	1054	36	36	16	65	12	
	CRE4D 181821S	543	565	610	633	18	18	21	25	4	
	CRE4D 242421S	603	628	699	729	24	24	21	35	5	
											

CRESSIDA | LIGHT-STYLE LINKING TABLES

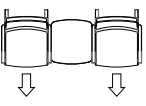
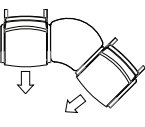
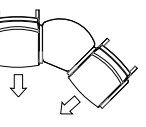
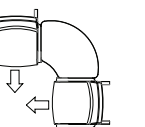
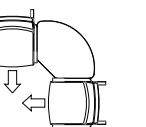
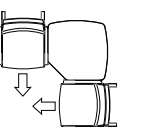
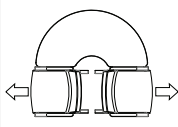
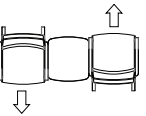
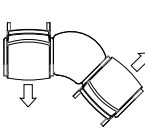
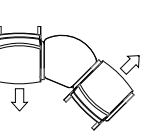
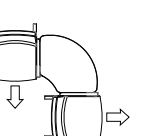
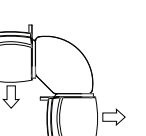
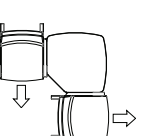
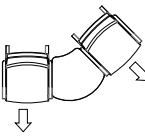
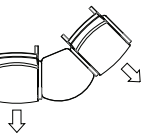
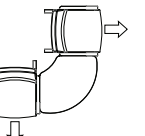
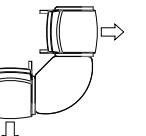
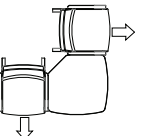
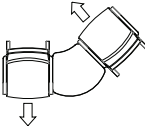
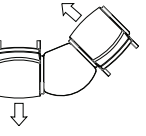
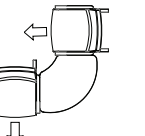
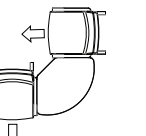
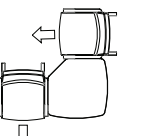
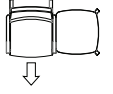
Linked Table -Center	Linked Table - Corner/Radius 45	Linked Table - Corner/Flat 45	Linked Table - Corner/Radius 90	Linked Table - Corner/Flat 90	Linked Table - Corner Rounded Flat	Curvilinear Connector Table 180°
						
CRE4-LKE-22-22	CRE4-LKGR45	CRE4-LCRF45	CRE4-LKCR90	CRE4-LKCRF90	CRE4-LKCSF90	
						
						
Linked Table - End						
CRE4-LKI-22-22						
						

CRESSIDA | LIGHT-STYLE LINKING TABLES

DESCRIPTION	MODEL	BEECH PALETTE LAMINATE	MAPLE	LAMINATE TOP W/BEECH SIDES	LAMINATE TOP W/ MAPLE SIDES	W	D	H	WEIGHT	CUBE
	Center Square Table CRE4D LKI2222	592	617	676	703	22	22	-	23	1.5
	End Square Table CRE4D LKE2222	586	611	670	697	22	22	16	34	1.5
	Curvilinear Connector Table 45° with flat edge CRE4D LKCRF45	703	732	670	697	28	24	16	27	2.2
	Curvilinear Connector Table 45° CRE4D LKCRR45	703	732	670	697	28	24	16	26	2.2
	Curvilinear Connector Table 90° with flat edge CRE4D LKCRF90	765	795	967	1006	38	24	16	32	2.2
	Curvilinear Connector Table 90° CRE4D LKCRR90	765	795	967	1006	38	24	16	32	2.2
	Rectilinear Corner Connector Table 90° CRE4D LKCSF90	811	845	973	1012	30	30	16	42	2.2
	Curvilinear Connector Table 180° CRE4D LKCRR180	1192	1239	1387	1443	55	29	16	60	4.4

ORDERING NOTES:

Linking tables can be ordered in conjunction with any of the Cressida Multiple Seating.

A drawing showing the configuration of the multiple seating and tables is required with each purchase order.

Rectilinear Corner Connector table 90° include a support leg in the outer corner.

All end linking tables include 2 legs. All Curvilinear tables include one supporting center leg.

LEYTON | ENVIRONMENTAL SUMMARY

LEED CI CREDITS

MATERIAL CONTENT:

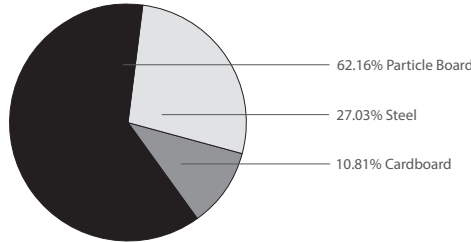

PRE-CONSUMER RECYCLED CONTENT = 34.73%

POST-CONSUMER RECYCLED CONTENT = 15.68%

Up to 62.16% of this Leyton product is recyclable at the end of its useful life.

CONTRIBUTES TO

CREDIT	CONTRIBUTES TO	POINTS
CREDIT 2.1 - 2.2	Construction Waste Management	1-2 point(s)
CREDIT 3.3	Resource Reuse	1 point
CREDIT 4.1	Recycled Content	1 point
CREDIT 4.2	Recycled Content	1 point
CREDIT 4.5	Low Emitting Materials, Systems & Seating	1 point
CREDIT 5.1	Regional Materials*	1 point
CREDIT 7	Certified Wood (MUST BE REQUESTED)	1 point(s)

*This credit is only applicable if in total 20% of the combined value of the procurement of construction materials and in the furniture are manufactured within a radius of 500 miles. This credit will apply if the installation of the finished product occurs within 500 miles of Kitchener, Ontario.

level® CERTIFICATION, AIR EMISSIONS AND FSC® CERTIFICATION



level® CERTIFICATION

BIFMA's e3 Furniture Sustainability Standard is a voluntary, multi-attribute standard that measures the degree of sustainability of furniture. This standard evaluates product and company environmental attributes and compliance systems in a wide range of elements which include Materials, Energy & Atmosphere, Human & Ecosystem Health and Social Responsibility. Leyton products have earned level®, BIFMA's sustainability certification program for furniture, certification through third-party verification against the e3 standard.

AIR-EMISSIONS

All Leyton products are supplied with air-emissions certified. Contact customer service for information.



FSC®

In 2005, Krug received Forest Stewardship Council® (FSC®) Chain-of-Custody certification for our manufacturing facilities. The FSC® Chain-of-Custody tracks certified wood from seedling to final sale. It verifies that the material for our FSC® certified products only come from well-managed, FSC®-certified forests and other controlled sources. FSC® is dedicated to the promotion of responsible forest management worldwide helping to take care of forests for future generations. Leyton and other Krug products can be specified with FSC® Certification. Contact customer service for further information, pricing and lead times.



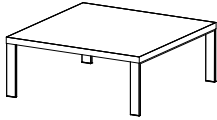
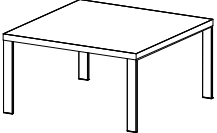
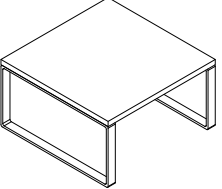

Architects, designers, and building professionals can specify FSC®-certified products in order to achieve a point from the U.S. Green Building Council's Leadership in Energy and Environmental Design (LEED) Rating System.

LEYTON | TABLES

DESCRIPTION/MODEL	Maple, Oak Walnut Palette Laminate	Cherry Anigre Sycamore (5 UNIT MIN.)	Solid Surface top Grade A - White	Solid Surface top Grade A - Color	Solid Surface top Grade B	Solid Surface top Grade C	
	LEY4122412	584	648	824	869	958	1019
	LEY4182412	611	695	940	1002	1120	1202
	LEY4242412	641	744	1062	1137	1288	1390
	LEY4302412	670	794	1173	1265	1440	1563
	LEY4362412	699	842	1317	1422	1633	1778
	LEY4422412	851	1015	1438	1559	1801	1966
	LEY4183012	666	765	1053	1122	1266	1361
	LEY4243012	701	832	1183	1271	1449	1570
	LEY4303012	743	890	1309	1414	1624	1769
	LEY4363012	781	953	1462	1587	1836	2009
LEY4423012	922	1117	1613	1756	2041	2238	
	LEY4182416	626	710	946	1005	1124	1207
	LEY4242416	656	760	1065	1141	1291	1395
	LEY4302416	687	809	1179	1268	1446	1568
	LEY4362416	715	854	1320	1428	1639	1781
	LEY4422416	868	1030	1443	1565	1804	1970
	LEY4183016	680	781	1081	1151	1291	1390
	LEY4243016	716	845	1209	1297	1478	1598
	LEY4303016	759	906	1334	1440	1651	1796
	LEY4363016	795	963	1488	1613	1863	2034
	LEY4423016	937	1134	1641	1781	2068	2264
	LEY4-SB122412	622	683	850	893	978	1036
	LEY4-SB182412	647	727	961	1020	1132	1210
	LEY4-SB242412	676	774	1077	1148	1292	1389
	LEY4-SB302412	704	822	1183	1270	1437	1554
	LEY4-SB362412	731	867	1320	1420	1621	1759
	LEY4-SB422412	876	1032	1435	1550	1781	1938
	LEY4-SB183012	700	794	1068	1134	1271	1362
	LEY4-SB243012	733	858	1192	1276	1445	1561
	LEY4-SB303012	773	913	1312	1412	1612	1750
	LEY4-SB363012	809	973	1458	1577	1814	1979
LEY4-SB423012	944	1129	1602	1738	2009	2197	

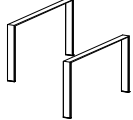
Please note Cherry, Anigre and Sycamore species require a minimum quantity order of 5 tables (any combination of sizes) per species.

DESCRIPTION/MODEL	Price	Weight	Cubes	
	Replacement Table Legs (pair)			
	LEY4R2412	238	8	1
	LEY4R2416	246	10	1.25
	LEY4R3012	276	10	2
	LEY4R3016	305	12	2.25
	Replacement Glides - Lounge & Table (set of four)			
	LEY3RG	18	1	.25
	LEY3-POWERDOC - Undermount	570	3	0.375

DIMENSIONS

Model	W	D	H	Shipping Weight	Cubes	Model	W	D	H	Shipping Weight	Cubes
LEY4122412	12	24	12	17.5	.7	LEY4182416	18	24	16	27	1.4
LEY4182412	18	24	12	22	1.1	LEY4242416	24	24	16	33	1.8
LEY4242412	24	24	12	28	1.4	LEY4302416	30	24	16	39	2.2
LEY4302412	30	24	12	32	1.8	LEY4362416	36	24	16	45	2.7
LEY4362412	36	24	12	37	2.2	LEY4422416	42	24	16	51	3.1
LEY4422412	42	24	12	41.5	2.5	LEY4183016	18	30	16	28	1.4
LEY4183012	18	30	12	23	1.1	LEY4243016	24	30	16	34	1.8
LEY4243012	24	30	12	28	1.4	LEY4303016	30	30	16	40	2.2
LEY4303012	30	30	12	33	1.8	LEY4363016	36	30	16	46	2.7
LEY4363012	36	30	12	37.5	2.2	LEY4423016	42	30	16	52	3.1
LEY4423012	42	30	12	42.5	2.5						

FAERON WOOD | ENVIRONMENTAL SUMMARY

LEED CI CREDITS

MATERIAL CONTENT:

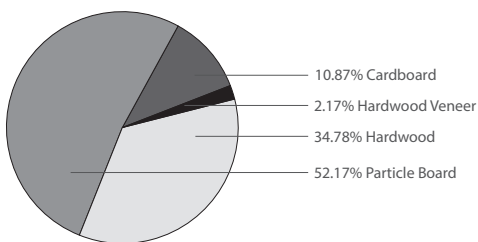

PRE-CONSUMER
RECYCLED CONTENT = 54.89%

POST-CONSUMER
RECYCLED CONTENT = 10.33%

Up to 10.87% of this Faeron product is recyclable at the end of its useful life.

CONTRIBUTES TO

CREDIT 2.1 - 2.2	Construction Waste Management	1-2 point(s)
CREDIT 3.3	Resource Reuse	1 point
CREDIT 4.1	Recycled Content	1 point
CREDIT 4.2	Recycled Content	1 point
CREDIT 4.5	Low Emitting Materials, Systems & Seating	1 point
CREDIT 5.1	Regional Materials*	1 point
CREDIT 7	Certified Wood (MUST BE REQUESTED)	1 point(s)

*This credit is only applicable if in total 20% of the combined value of the procurement of construction materials and in the furniture are manufactured within a radius of 500 miles. This credit will apply if the installation of the finished product occurs within 500 miles of Kitchener, Ontario.

level® CERTIFICATION, AIR EMISSIONS AND FSC® CERTIFICATION



level® CERTIFICATION

BIFMA's e3 Furniture Sustainability Standard is a voluntary, multi-attribute standard that measures the degree of sustainability of furniture. This standard evaluates product and company environmental attributes and compliance systems in a wide range of elements which include Materials, Energy & Atmosphere, Human & Ecosystem Health and Social Responsibility. Faeron products have earned level®, BIFMA's sustainability certification program for furniture, certification through third-party verification against the e3 standard.

AIR-EMISSIONS

All Faeron products are supplied with air-emissions certified. Contact customer service for information.



FSC®

In 2005, Krug received Forest Stewardship Council® (FSC®) Chain-of-Custody certification for our manufacturing facilities. The FSC® Chain-of-Custody tracks certified wood from seedling to final sale. It verifies that the material for our FSC® certified products only come from well-managed, FSC®-certified forests and other controlled sources. FSC® is dedicated to the promotion of responsible forest management worldwide helping to take care of forests for future generations. Faeron and other Krug products can be specified with FSC® Certification. Contact customer service for further information, pricing and lead times.



Architects, designers, and building professionals can specify FSC®-certified products in order to achieve a point from the U.S. Green Building Council's Leadership in Energy and Environmental Design (LEED) Rating System.

FAERON WOOD | LINKING TABLES FEATURES

WOOD SPECIES

Solid Beech frames, and edges.
Veneer tops.

LAMINATE AND POLYMER EDGE

Faeron tables are available in laminates with
with Polymer edge.
See page 631 for laminate information.

STANDARD FINISHES

For a complete list of standard wood finishes,
please see page 550. Faeron tables are avail-
able in 22 standard finishes.

ORDERING NOTES:

Linking tables can be ordered in conjunction with any of the Krug Multiple Seating. Linking tables are connected to the Multiple Seating via U-Shaped brackets.

The design of the tables for Faeron Multiple Seating allows for any table to be very easily added or moved to a new position within the configuration - or completely replaced - after the product has been first installed. The attachment of the tables is designed so that they can be readily be taken out of the configuration without any defacing of the adjoining seat frames.

Linking Tables also feature a universal, non-handed design:

They can be moved to reverse position in almost any configuration, providing a high level of flexibility for reconfiguring.

Please note Faeron Laminate Linking Tables are not available on *KrugExpress*.

Wood Tops with Wood Edges are available on *KrugExpress* but with a minimum order requirement of 5 tables per order.

A drawing showing the configuration of the multiple seating and tables is required with each purchase order.

Linked Table - End

FAE4-LKE-22-22

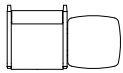

Linked Table -Center

FAE4-LKI-22-22

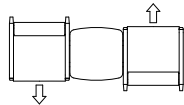
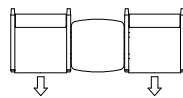

Linked Table -
Corner/Flat 45

FAE4-LCRF45

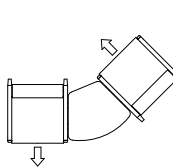
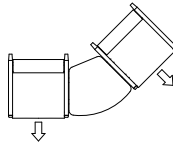
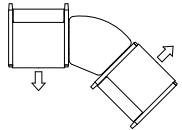
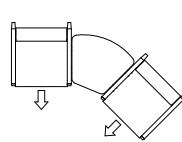

Linked Table -
Corner/Flat 90

FAE4-LKCRF90

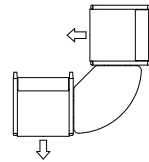
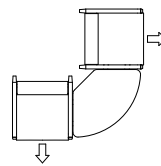
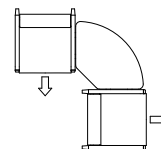
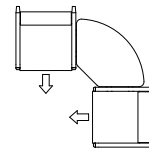

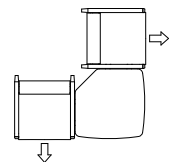
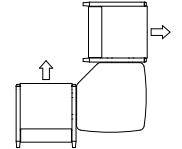
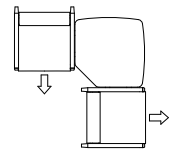
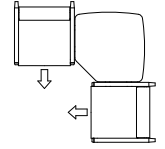

Linked Table -
Corner Square Flat

FAE4-LKCSF90

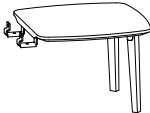

FAERON WOOD | LINKING TABLES

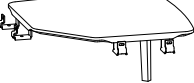
DESCRIPTION/MODEL	Beech	Laminate with Polymer Edge	Solid Surface top Grade A - White	Solid Surface top Grade A - Color	Solid Surface top Grade B	Solid Surface top Grade C
 Center Square Table FAE4-LKI-22-22	752	520	895	943	1042	1110
 End Square Table FAE4-LKE-22-22	959	688	1103	1155	1260	1333
 Linking Curved Corner Table 45° FAE4-LKCRF45	834	547	1102	1158	1271	1349
 Linking Curved Corner Table 90° FAE4-LKCRF90	1036	727	1303	1378	1534	1640
 Linking Square Corner Table 90° FAE4-LKCSF90	1131	789	1434	1512	1669	1777

DIMENSIONS

Model	Width	Depth	Height	Shipping Weight	Cubes
Center Square Table FAE4-LKI-22-22	22	22	-	23	1.5
End Square Table FAE4-LKE-22-22	22	22	16	34	1.5
Linking Curved Corner Table 45° FAE4-LKCRF45	28	24	16	27	2.2
Linking Curved Corner Table 90° FAE4-LKCRF90	38	24	16	32	2.2
Linking Square Corner Table 90° FAE4-LKCSF90	30	30	16	42	2.2

FAERON WOOD | FREE STANDING TABLES

WOOD SPECIES



Solid Beech frames, and edges.
Veneer tops.

LAMINATE AND POLYMER EDGE

Faeron tables are available in laminates with wood or laminates with Polymer edge.
See page 631 for color selection.

STANDARD FINISHES

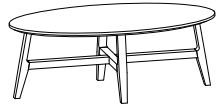
For a complete list of standard wood finishes, please see [page 550](#). Faeron tables are available in 22 standard finishes.

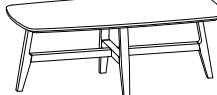
DESCRIPTION/MODEL	Beech	Laminate with Polymer Edge	Solid Surface top Grade A - White	Solid Surface top Grade A - Color	Solid Surface top Grade B	Solid Surface top Grade C
Round Tables						
 FAE4-22D-21	1384	1030	2034	2177	2299	2523
FAE4-30D-16	1558	1153	2367	2532	2753	3078
FAE4-44D-16	2860	2088	4180	4471	4877	5460
Elliptical						
 FAE4-E44-22-16	1780	1298	2619	2804	3055	3419
Square Tables						
 FAE4-22-22-21	1371	1018	1942	2080	2211	2434
FAE4-30-30-16	1587	1177	2386	2553	2820	3186
FAE4-44-44-16	2920	2131	4265	4564	4977	5572
Rectangular Table						
 FAE4-44-22-16	1802	1315	2634	2817	3071	3441

DIMENSIONS

Model	Width	Depth	Height	Shipping Weight	Cubes
Round Tables					
FAE4-22D-21	22" Diameter		21	22	8
FAE4-30D-16	30" Diameter		16	35	11
FAE4-44D-16	40" Diameter		16	45	14
Elliptical					
FAE4-E44-22-16	44	22	16	65	21
Square Tables					
FAE4-22-22-21	22	22	21	34	8
FAE4-30-30-16	30	30	16	42	11
FAE4-44-44-16	44	44	16	47	12
Rectangular Table					
FAE4-44-22-16	44	22	16	55	12

FAERON METAL | ENVIRONMENTAL SUMMARY

LEED CI CREDITS



MATERIAL CONTENT:

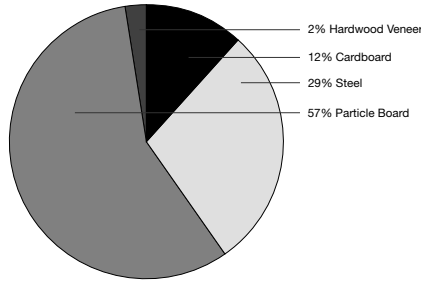

PRE-CONSUMER
RECYCLED CONTENT = 67.26%

POST-CONSUMER
RECYCLED CONTENT = 17.02%

Up to 40.48% of this Faeron Metal product is recyclable at the end of its useful life.

CONTRIBUTES TO

CREDIT 2.1 - 2.2	Construction Waste Management	1-2 point(s)
CREDIT 3.3	Resource Reuse	1 point
CREDIT 4.1	Recycled Content	1 point
CREDIT 4.2	Recycled Content	1 point
CREDIT 4.5	Low Emitting Materials, Systems & Seating	1 point
CREDIT 5.1	Regional Materials*	1 point
CREDIT 7	Certified Wood (MUST BE REQUESTED)	1 point(s)

*This credit is only applicable if in total 20% of the combined value of the procurement of construction materials and in the furniture are manufactured within a radius of 500 miles. This credit will apply if the installation of the finished product occurs within 500 miles of Kitchener, Ontario.

level® CERTIFICATION, AIR EMISSIONS AND FSC® CERTIFICATION



level® CERTIFICATION

BIFMA's e3 Furniture Sustainability Standard is a voluntary, multi-attribute standard that measures the degree of sustainability of furniture. This standard evaluates product and company environmental attributes and compliance systems in a wide range of elements which include Materials, Energy & Atmosphere, Human & Ecosystem Health and Social Responsibility. Faeron products have earned level®, BIFMA's sustainability certification program for furniture, certification through third-party verification against the e3 standard.

AIR-EMISSIONS

All Faeron products are supplied with air-emissions certified. Contact customer service for information.



FSC®

In 2005, Krug received Forest Stewardship Council® (FSC®) Chain-of-Custody certification for our manufacturing facilities. The FSC® Chain-of-Custody tracks certified wood from seedling to final sale. It verifies that the material for our FSC® certified products only come from well-managed, FSC®-certified forests and other controlled sources. FSC® is dedicated to the promotion of responsible forest management worldwide helping to take care of forests for future generations. Faeron and other Krug products can be specified with FSC® Certification. Contact customer service for further information, pricing and lead times.



Architects, designers, and building professionals can specify FSC®-certified products in order to achieve a point from the U.S. Green Building Council's Leadership in Energy and Environmental Design (LEED) Rating System.

FAERON METAL | FREE STANDING TABLES

FRAME FINISH

Faeron Metal table frames are available in Krug Silver Metallic or Brushed Nickel.

METAL FINISH OPTIONS

Silver Metallic frames are available with an anti-microbial finish for an upcharge of **\$64 list** per arm frame pair or table. Additional Frame Finishes, which include anti-microbial finish, are available for an upcharge of **\$64**



list per per arm frame pair or table. Available colors are: White, Parchment, Sand, Taupe, Warm Grey, Cool Grey or Black. For all metal finishes other than Silver Metallic Standard, there is a minimum order quantity of 30 units per color. Upcharges for order quantities less than 30 units per color or custom metal finishes, please contact Customer Service to obtain a quote.

STANDARD FINISHES

For a complete list of standard wood finishes, please see [Page 97](#). Faeron tables are available in 22 standard finishes.

LAMINATE AND POLYMER EDGE

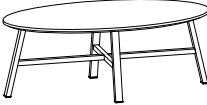

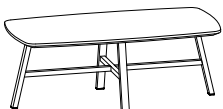
Faeron tables are available in laminates with wood or laminates with Polymer edge. See [Page 97](#) for color selection.

DESCRIPTION/MODEL	Beech	Laminate with Polymer Edge	Solid Surface top Grade A - White	Solid Surface top Grade A - Color	Solid Surface top Grade B	Solid Surface top Grade C	
 <p>Round Tables, Silver Metallic Frame</p>	FAE4-M22D-21S	1257	901	1907	2051	2172	2396
	FAE4-M30D-16S	1359	956	2168	2333	2554	2880
	FAE4-M44D-16S	2559	1788	3877	4170	4574	5159
	Round Tables, Brushed Nickel Frame						
	FAE4-M22D-21N	1437	1082	2087	2230	2353	2576
	FAE4-M30D-16N	1539	1136	2347	2513	2735	3059
FAE4-M44D-16N	2955	2184	4273	4566	4971	5556	
 <p>Elliptical, Silver Metallic Frame</p>	FAE4-ME44-22-16S	1527	1044	2366	2549	2800	3164
	Elliptical, Brushed Nickel Frame						
	FAE4-ME44-22-16N	1885	1404	2724	2908	3160	3523
	Square Tables, Silver Metallic Frame						
	FAE4-M22-22-21S	1243	890	1816	1951	2083	2306
	FAE4-M30-30-16S	1389	978	2188	2355	2620	2986
	FAE4-M44-44-16S	2616	1828	3962	4263	4675	5271
	Square Tables, Brushed Nickel Frame						
	FAE4-M22-22-21N	1422	1071	1995	2131	2262	2486
	FAE4-M30-30-16N	1568	1158	2367	2535	2802	3165
FAE4-M44-44-16N	3013	2223	4360	4659	5071	5666	
 <p>Rectangular Table, Silver Metallic Frame</p>	FAE4-M44-22-16S	1547	1061	2378	2563	2817	3186
	Rectangular Table, Brushed Nickel Frame						
	FAE4-M44-22-16N	1907	1420	2739	2922	3177	3545

DIMENSIONS

Model	Width	Depth	Height	Shipping Weight	Cubes
Round Tables					
FAE4-M22D-21	22" Diameter		21	30	8
FAE4-M30D-16	30" Diameter		16	42	11
FAE4-M44D-16	44" Diameter		16	72	21
Elliptical					
FAE4-ME44-22-16	44	22	16	42	12
Square Tables					
FAE4-M22-22-21	22	22	21	32	8
FAE4-M30-30-16	30	30	16	47	11
FAE4-M44-44-16	44	44	16	83	21
Rectangular Table					
FAE4-M44-22-16	44	22	16	47	12

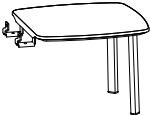
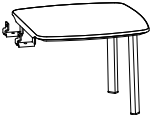
FAERON METAL | LINKING TABLES

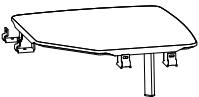
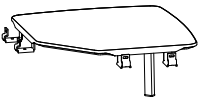
DESCRIPTION/MODEL	Beech	Laminate with Polymer Edge	Solid Surface top Grade A - White	Solid Surface top Grade A - Color	Solid Surface top Grade B	Solid Surface top Grade C
 Center Square Table FAE4-LKI-22-22	752	520	894	942	1042	1109
 End Square Table, Silver Metallic Frame FAE4-MLKE-22-22S	894	622	1038	1090	1195	1268
 End Square Table, Brushed Nickel Frame FAE4-MLKE-22-22N	941	672	1087	1139	1244	1316
 Linking Curved Corner Table 45° FAE4-LKCRF45	833	547	1102	1158	1270	1349
 Linking Curved Corner Table 90° FAE4-LKCRF90	1034	725	1302	1378	1533	1639
 Linking Square Corner Table 90°, Silver Metallic Frame FAE4-MLKCSF90S	1096	756	1399	1479	1636	1744
 Linking Square Corner Table 90°, Brushed Nickel Frame FAE4-MLKCSF90N	1121	781	1423	1504	1661	1768

DIMENSIONS

Model	Width	Depth	Height	Shipping Weight	Cubes
Center Square Table FAE4-LKI-22-22	22	22	-	23	1.5
End Square Table FAE4-MLKE-22-22	22	22	16	39	1.5
Linking Curved Corner Table 45° FAE4-LKCRF45	28	24	16	27	2.2
Linking Curved Corner Table 90° FAE4-LKCRF90	38	24	16	32	2.2
Linking Square Corner Table 90° FAE4-MLKCSF90	30	30	16	45	2.2

LEED CI CREDITS



MATERIAL CONTENT:

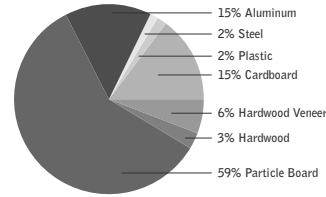

PRE-CONSUMER
RECYCLED CONTENT = 58.82%

POST-CONSUMER
RECYCLED CONTENT = 17.25%

Up to 29.41% of this Zola product is recyclable at the end of its useful life.

CONTRIBUTES TO

CREDIT 2.1 - 2.2	Construction Waste Management	1-2 point(s)
CREDIT 3.3	Resource Reuse	1 point
CREDIT 4.1	Recycled Content	1 point
CREDIT 4.2	Recycled Content	1 point
CREDIT 4.5	Low Emitting Materials, Systems & Seating	1 point
CREDIT 5.1	Regional Materials*	1 point
CREDIT 7	Certified Wood (MUST BE REQUESTED)	1 point(s)

*This credit is only applicable if in total 20% of the combined value of the procurement of construction materials and in the furniture are manufactured within a radius of 500 miles. This credit will apply if the installation of the finished product occurs within 500 miles of Kitchener, Ontario.

level® CERTIFICATION, AIR EMISSIONS AND FSC® CERTIFICATION



level® CERTIFICATION

BIFMA's e3 Furniture Sustainability Standard is a voluntary, multi-attribute standard that measures the degree of sustainability of furniture. This standard evaluates product and company environmental attributes and compliance systems in a wide range of elements which include Materials, Energy & Atmosphere, Human & Ecosystem Health and Social Responsibility. Zola products have earned level®, BIFMA's sustainability certification program for furniture, certification through third-party verification against the e3 standard.

AIR-EMISSIONS

All Zola products are supplied with air-emissions certified. Contact customer service for information.



FSC®

In 2005, Krug received Forest Stewardship Council® (FSC®) Chain-of-Custody certification for our manufacturing facilities. The FSC® Chain-of-Custody tracks certified wood from seedling to final sale. It verifies that the material for our FSC® certified products only come from well-managed, FSC®-certified forests and other controlled sources. FSC® is dedicated to the promotion of responsible forest management worldwide helping to take care of forests for future generations. Zola and other Krug products can be specified with FSC® Certification. Contact customer service for further information, pricing and lead times.



Architects, designers, and building professionals can specify FSC®-certified products in order to achieve a point from the U.S. Green Building Council's Leadership in Energy and Environmental Design (LEED) Rating System.

ZOLA | TABLES FEATURES

TABLES MATERIALS OPTION

Tables are available in veneer, plastic laminate, and Palette finishes - and an optional solid surface top. Tables feature leveling glides on every leg.

SOLID SURFACE TOPS

The Solid Surface Top option features Solid Surface material:

composed of minerals, acrylic resins and colors, it is a non-porous, scratch and dent-resistant material that does not stain, and does not allow microbes and bacteria to penetrate the surface. Color is throughout the material, so surface scratches are not as visible.

POWER OPTION

The flush-mounted Power unit provides dual power/USB outlets for multiple devices. It can be located on the front face of Middle or End Tables (not available on curvilinear models) To specify, clearly mark on the order and add **\$589 list**.

UNDER-MOUNT POWER OPTION

The Under-mount Power unit provides dual power/USB outlets for multiple devices. It can be located below tables.

See [Page 283](#) for pricing.

ZOLA | MODULAR LINKING TABLES

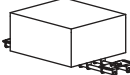
DESCRIPTION	MODEL	BEECH PALETTE LAMINATE	MAPLE CHERRY	LAMINATE TOP W/BEECH SIDES	LAMINATE TOP W/ MAPLE/CHERRY SIDES	W	D	H	WEIGHT	CUBE
	Middle Linking Modular Table									
	ZOL4 LKM12	988	1036	1088	1140	12	16	-	22	2.8
	ZOL4 LKM18	1044	1098	1147	1209	18	16	-	24	4.5
	ZOL4 LKM24	1074	1155	1181	1270	24	16	-	29	5.7

ORDERING NOTE: Middle Linking Modular Table ships with 2 KB1 brackets.

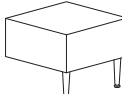
	Rectangular End Table Square Corner									
	ZOL4 LKE12	1053	1108	1158	1218	12	16	14.75	19	2.8
	ZOL4 LKE18	1098	1155	1209	1270	18	16	14.75	23	4.5
	ZOL4 LKE24	1146	1202	1263	1323	24	16	14.75	28	5.7

ORDERING NOTE: End Linking Modular Table ships with 1 KB1 bracket.

	End Table Rounded Corner									
	ZOL4 ECLKH12	1199	1246	1232	1284	12	12	14.75	18	2.5
	ZOL4 ECLKH18	1295	1347	1342	1395	18	12	14.75	24	3

ORDERING NOTE: End Linking Modular Table ships with 1 KB1 bracket.

	Curvilinear 30° Table									
	ZOL4 LKC30	1019	1074	1122	1181	16	16.5	-	15	2.3



	Curvilinear 45° Table									
	ZOL4 LKC45	1098	1155	1209	1270	16	17	-	17	2.9

ORDERING NOTES: Middle Linking Tables are automatically supplied with two ZOL3 RLKB1 (table to seat bracket) brackets for fastening to benches. End tables are automatically supplied with one ZOL3 RLKB1 (table to seat bracket) bracket for fastening to benches. When fastening two linking tables (ZOL4 LKC90X2) together, mounting hardware will be provided when ordered, that will include one leg per table (to a maximum of two legs), which will be mounted on the adjoining seam. Please note in model ZOL4 LKH12, the "12" corresponds to the length of the table.

Zola Solid Surface Upcharges	A-White	Grades A-Color	B	C
ZOL4-LKM12	218	229	260	295
ZOL4-LKM18	269	286	332	383
ZOL4-LKM24	381	406	522	621
ZOL4-LKE12	218	229	260	295
ZOL4-LKE18	269	286	332	383
ZOL4-LKE24	381	406	522	621
ZOL4-ECLKH12	218	229	260	295
ZOL4-ECLKH18	269	286	332	383
ZOL4-LKC30	246	260	299	340
ZOL4-LKC45	308	328	384	446

The Solid Surface top option is priced as an upcharge to existing table price. Please add a "S" to the end of the model number and then add the upcharge listed under Solid Surface ie: ZOL4 18D15S. Zola Solid Surface tables have a 1/2" thickness on top of the existing table, with a 1 mm overhang (soft radius vertical edge).

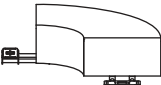
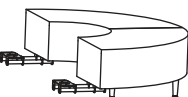
ZOLA | MODULAR LINKING TABLES

DESCRIPTION	MODEL	BEECH PALETTE LAMINATE	MAPLE CHERRY	LAMINATE TOP W/BEECH SIDES	LAMINATE TOP W/ MAPLE/CHERRY SIDES	W	D	H	WEIGHT	CUBE
	Curvilinear 60° Table ZOL4 LKC60	1146	1209	1263	1332	16	17.5	-	20	3.7
	Curvilinear 90° Table ZOL4 LKC90	1283	1354	1411	1487	16	19	-	24	5.4
	Curvilinear 90°x2 Table ZOL4 LKC90X2	2548	2625	2802	2886	16	19	-	55	10
	Curvilinear Table ZOL4 LKH12	1116	1170	1228	1288	16	19	14.75	18	2.3

ORDERING NOTES: Middle Linking Tables are automatically supplied with two ZOL3 RLKB1 (table to seat bracket) brackets for fastening to benches. End tables are automatically supplied with one ZOL3 RLKB1 (table to seat bracket) bracket for fastening to benches. When fastening two linking tables (ZOL4 LKC90X2) together, mounting hardware will be provided when ordered, that will include one leg per table (to a maximum of two legs), which will be mounted on the adjoining seam. Zola Middle tables have the ability to be easily reconfigured, as they are universal and non-handed. They can be moved to a reverse position in almost any configuration to provide a high level of flexibility when specifying.

Zola Solid Surface Upcharges	Grades			
	A-White	A-Color	B	C
ZOL4-LKC60	379	402	473	
ZOL4-LKC90	562	596	719	
ZOL4-LKC90X2	894	933	1141	
ZOL4-LKH12	218	229	260	

The Solid Surface top option is priced as an upcharge to existing table price. Please add a "S" to the end of the model number and then add the upcharge listed under Solid Surface ie: ZOL4 18D15S. Zola Solid Surface tables have a 1/2" thickness on top of the existing table, with a 1 mm overhang (soft radius vertical edge).

CURVILINEAR TABLE DIMENSIONS

ZOL4 LKC30

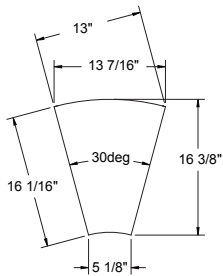

ZOL4 LKC60

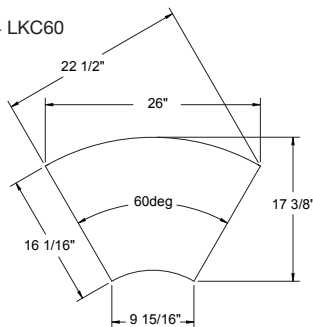

ZOL4 LKC45

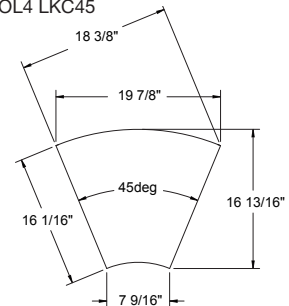

ZOL4 LKC90

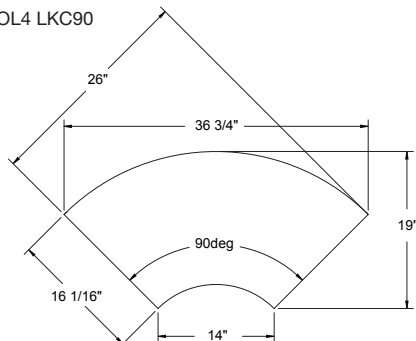

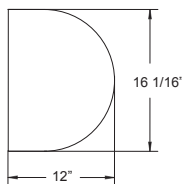

ZOL4 LKH12

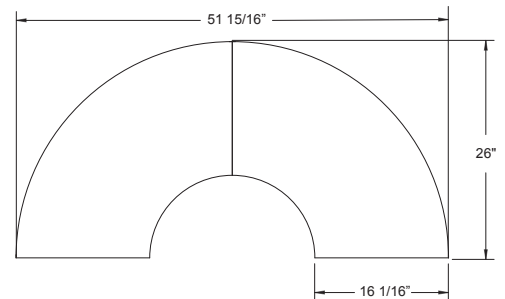

ZOL4 LKC90X2

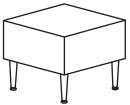
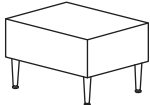
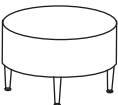

ZOLA | FREESTANDING TABLES

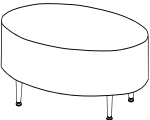
DESCRIPTION	MODEL	BEECH PALETTE LAMINATE	MAPLE CHERRY	LAMINATE TOP W/BEECH SIDES	LAMINATE TOP W/ MAPLE/CHERRY SIDES	W	D	H	WEIGHT	CUBE
	Square Tables									
	ZOL4 181815	1098	1155	1209	1270	18	18	14.75	24	3
	ZOL4 242415	1187	1251	1305	1374	24	24	14.75	34	5
	Rectangular Tables									
	ZOL4 241815	1139	1203	1253	1327	24	18	14.75	28	4
	ZOL4 482415	1359	1443	1495	1587	48	24	14.75	56	10
	Round Tables									
	ZOL4 18D15	1170	1244	1288	1367	18	-	14.75	16	3
	ZOL4 24D15	1251	1318	1374	1452	24	-	14.75	23	5
	ZOL4 30D15	1391	1474	1530	1619	30	-	14.75	34	8
	Square Table - Round Corners									
	ZOL4 EC181815	1275	1328	1320	1376	18	18	14.75	21	3
	ZOL4 EC241815	1434	1492	1493	1555	24	18	14.75	25	4
	ZOL4 EC242415	1578	1639	1686	1752	24	24	14.75	30	5
	ZOL4 EC482415	2264	2354	2408	2504	48	24	14.75	51	10
	Ellipse Table									
	ZOL4 E241815	1327	1378	1499	1559	24	18	14.75	22	4
	ZOL4 E322415	1610	1673	1788	1858	32	24	14.75	32	7
	ZOL4 E482915	2016	2096	2254	2345	48	29	14.75	53	12

Zola Solid Surface Upcharges	Grades			
	A-White	A-Color	B	C
ZOL4 1818	287	301	352	409
ZOL4 2424	460	469	560	662
ZOL4 2418	343	364	433	510
ZOL4 4824	771	791	970	1170
ZOL4 18D	274	290	339	396
ZOL4 24D	410	443	533	633
ZOL4 30D	658	716	942	1136
ZOL4 EC1818	287	301	352	409
ZOL4 EC2418	343	364	433	510
ZOL4 EC2424	460	469	560	662
ZOL4 EC4824	771	791	970	1170
ZOL4 E2418	343	364	433	510
ZOL4 E3224	543	581	699	834
ZOL4 E4829	908	949	1164	1405

The Solid Surface top option is priced as an upcharge to existing table price. Please add a "S" to the end of the model number and then add the upcharge listed under Solid Surface ie: ZOL4 18D15S. Zola Solid Surface tables have a 1/2" thickness on top of the existing table, with a 1 mm overhang (soft radius vertical edge).

ZOLA | FREESTANDING TABLES

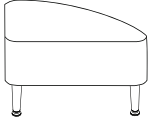
DESCRIPTION	MODEL	BEECH PALETTE LAMINATE	MAPLE CHERRY	LAMINATE TOP W/BEECH SIDES	LAMINATE TOP W/ MAPLE/CHERRY SIDES	W	D	H	WEIGHT	CUBE	
	Triangular Tables - Rounded Corners										
	ZOL4 CR45D1815	1192	1240	1207	1257	15.75	18	14.75	17	2.5	
	ZOL4 CR45D2415	1354	1408	1404	1459	20.5	24	14.75	22	4.5	
	ZOL4 CR45D2915	1639	1705	1734	1803	25	29	14.75	27	7	
	ZOL4 CR90D1815	1465	1526	1529	1585	17.5	18	14.75	23	3	
	ZOL4 CR90D2415	1730	1801	1813	1885	36.25	24	14.75	29	7.5	
	ZOL4 CR90D2915	2066	2148	2109	2194	44.5	29	14.75	35	11	

Zola Solid Surface Upcharges	Grades			
	A-White	A-Color	B	C
ZOL4 CR45D18	270	286	333	386
ZOL4 CR45D24	403	432	512	602
ZOL4 CR45D29	542	573	687	815
ZOL4 CR90D18	339	371	441	518
ZOL4 CR90D24	576	613	740	885
ZOL4 CR90D29	815	846	1033	1242

The Solid Surface top option is priced as an upcharge to existing table price. Please add a "S" to the end of the model number and then add the upcharge listed under Solid Surface ie: ZOL4 18D15S. Zola Solid Surface tables have a 1/2" thickness on top of the existing table, with a 1 mm overhang (soft radius vertical edge).

TRIANGULAR TABLE DIMENSIONS

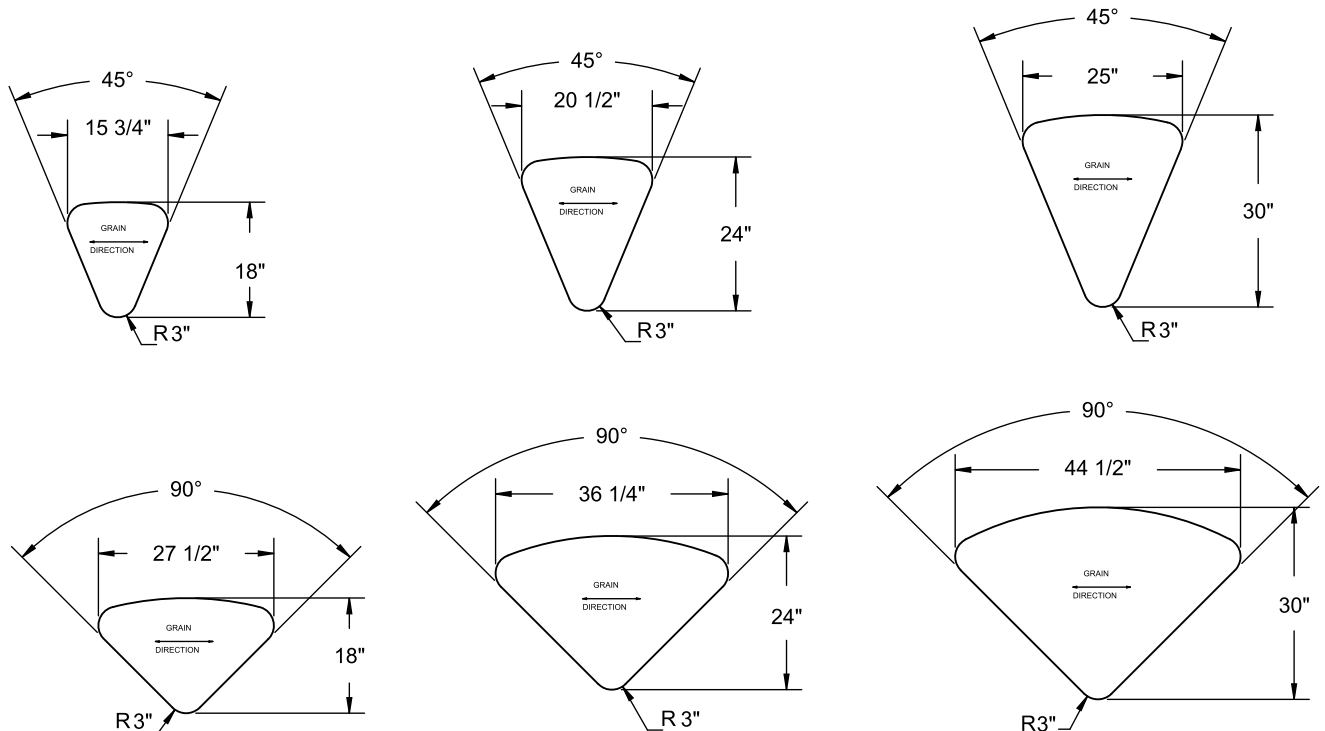

JORDAN | ENVIRONMENTAL SUMMARY

LEED CI CREDITS



MATERIAL CONTENT:

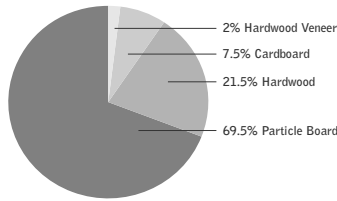

PRE-CONSUMER
RECYCLED CONTENT = 71.25%

POST-CONSUMER
RECYCLED CONTENT = 6.9%

CONTRIBUTES TO

CREDIT 2.1 - 2.2	Construction Waste Management	1-2 point(s)
CREDIT 3.3	Resource Reuse	1 point
CREDIT 4.1	Recycled Content	1 point
CREDIT 4.2	Recycled Content	1 point
CREDIT 4.5	Low Emitting Materials, Systems & Seating	1 point
CREDIT 5.1	Regional Materials*	1 point
CREDIT 7	Certified Wood (MUST BE REQUESTED)	1 point(s)

*This credit is only applicable if in total 20% of the combined value of the procurement of construction materials and in the furniture are manufactured within a radius of 500 miles. This credit will apply if the installation of the finished product occurs within 500 miles of Kitchener, Ontario.

level® CERTIFICATION, AIR EMISSIONS AND FSC® CERTIFICATION



level® CERTIFICATION

BIFMA's e3 Furniture Sustainability Standard is a voluntary, multi-attribute standard that measures the degree of sustainability of furniture. This standard evaluates product and company environmental attributes and compliance systems in a wide range of elements which include Materials, Energy & Atmosphere, Human & Ecosystem Health and Social Responsibility. Jordan products have earned level®, BIFMA's sustainability certification program for furniture, certification through third-party verification against the e3 standard.

AIR-EMISSIONS

All Jordan products are supplied with air-emissions certified. Contact customer service for information.



FSC®

In 2005, Krug received Forest Stewardship Council® (FSC®) Chain-of-Custody certification for our manufacturing facilities. The FSC® Chain-of-Custody tracks certified wood from seedling to final sale. It verifies that the material for our FSC® certified products only come from well-managed, FSC®-certified forests and other controlled sources. FSC® is dedicated to the promotion of responsible forest management worldwide helping to take care of forests for future generations. Jordan and other Krug products can be specified with FSC® Certification. Contact customer service for further information, pricing and lead times.



Architects, designers, and building professionals can specify FSC®-certified products in order to achieve a point from the U.S. Green Building Council's Leadership in Energy and Environmental Design (LEED) Rating System.

WOOD SPECIES

Solid Beech & Maple frames, and edges.
Veneer tops.

STANDARD FINISHES

For a complete list of standard wood finishes, please see [page 550](#). Jordan tables are available in 22 standard finishes.

LAMINATE AND POLYMER EDGE

Jordan tables are available in laminates with wood or laminates with Polymer edge.
See [page 551](#) for laminate information.
Please specify species, Beech or Maple, for the base frame under the laminate top.

ORDERING NOTES:

Linking tables can be ordered in conjunction with any of the Krug Multiple Seating. Linking tables are connected to the Multiple Seating via U-Shaped brackets.

The design of the tables for Jordan Multiple Seating allows for any table to be very easily added or moved to a new position within the configuration - or completely replaced - after the product has been first installed. The attachment of the tables is designed so that they can be readily be taken out of the configuration without any defacing of the adjoining seat frames.

Linking Tables also feature a universal, non-handed design:

They can be moved to reverse position in almost any configuration, providing a high level of flexibility for reconfiguring.

Please note Jordan Plastic Laminate Linking Tables are not available on *KrugExpress*. Please specify species, Beech or Maple, for the base frame under the laminate top.

Wood Tops with Wood Edges are available on *KrugExpress* but with a minimum order requirement of 5 tables per order.

A drawing showing the configuration of the multiple seating and tables is required with each purchase order.

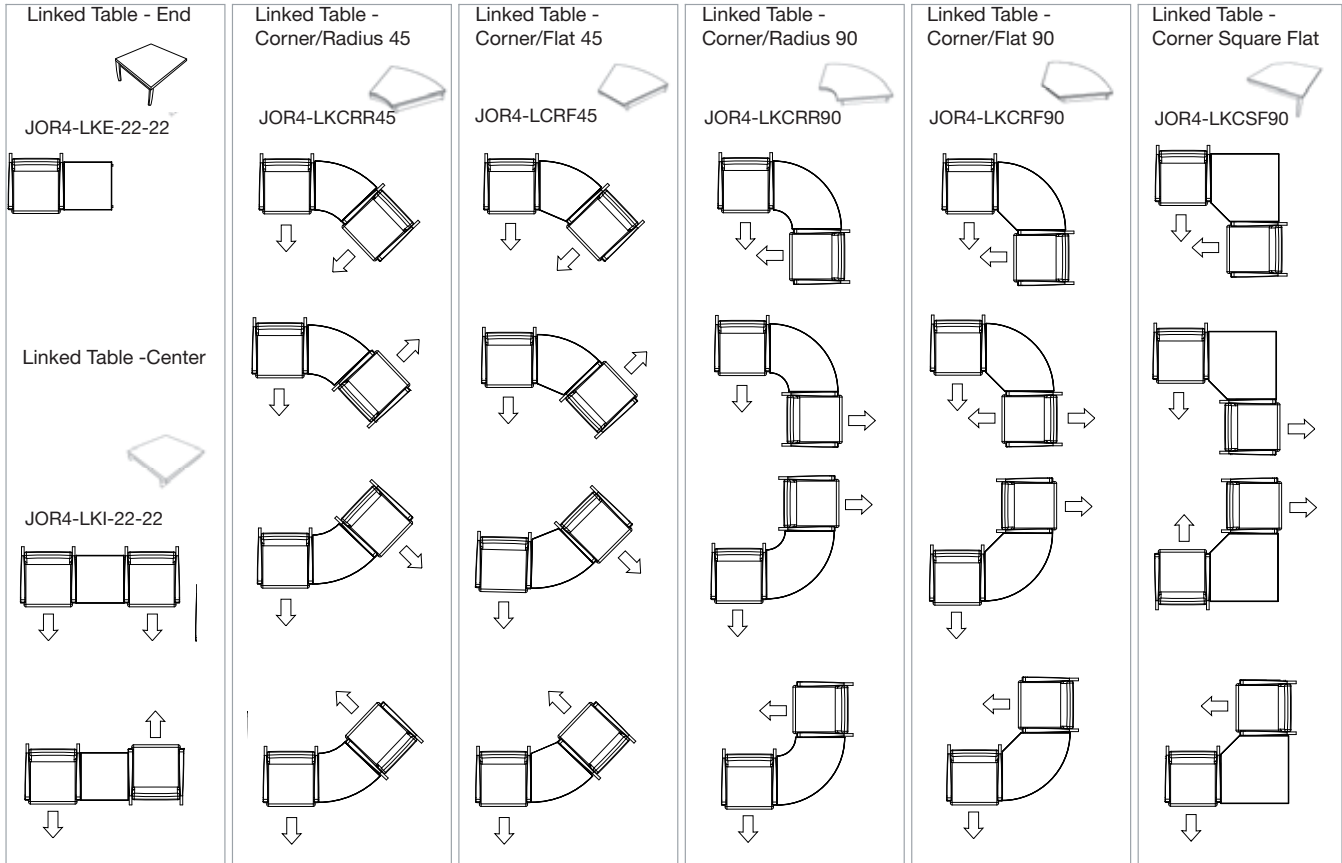

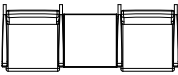
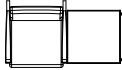
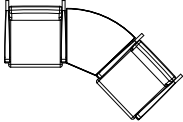
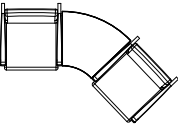
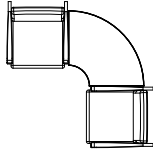
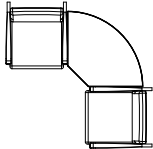
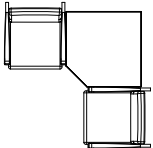

JORDAN | LINKING & FREESTANDING TABLES

DESCRIPTION/MODEL	Beech	Maple	Laminate with Wood Edge	Laminate with Polymer Edge	W	D	Weight	Cubes
 Center Square Table JOR4-LKI-22-22	652	721	739	538	22	22	18	1.5
 End Square Table JOR4-LKE-22-22	865	953	979	747	22	22	20	1.5
 Curvilinear Connector Table 45° with flat edge JOR4-LKCRF45	747	823	865	652	27.5	27.5	21	2.2
 Curvilinear Connector Table 45° JOR4-LKCR45	747	823	865	652	27.5	27.5	21	2.2
 Curvilinear Connector Table 90° JOR4-LKCR90	823	913	940	730	30.5	30.5	27	2.2
 Curvilinear Connector Table 90° with flat edge JOR4-LKCRF90	785	873	901	670	30.5	29	29	2.2
 Rectilinear Corner Connector Table 90° JOR4-LKCSF90	1056	1141	1191	921	30.5	30.5	32	2.2

ORDERING NOTES: Linking tables can be ordered in conjunction with any of the Jordan Multiple Seating. Linking tables are connected to the Multiple Seating via U-Shaped brackets.

A drawing showing the configuration of the multiple seating and tables is required with each purchase order.

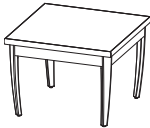
Rectilinear Corner Connector table 90° include a support leg in the outer corner. When specifying Linking Tables please ensure that each unit has legs on either side of the table. Please note Jordan Plastic Laminate Linking Tables are not available on *KrugExpress*. Please specify species, Beech or Maple, for the base frame under the laminate top. Wood Tops with Wood Edges are available on *KrugExpress* but with a minimum order requirement of 5 tables per order.

DESCRIPTION/MODEL	Beech	Maple	Laminate with Wood Edge	Laminate with Polymer Edge	W	D	H	Weight	Cubes	
	Square Tables									
	JOR4-22-22-16	1008	1106	1108	937	22	22	16	26	5
	JOR4-42-22-16	1306	1439	1434	1213	42	22	16	46	9
	JOR4-22-22-21	1036	1134	1139	961	22	22	21	28	7
	Circular Tables									
	JOR4-18D-16	1207	1333	1330	1122	18 Diameter	-	16	20	3
	JOR4-24D-16	1285	1401	1415	1194	24 Diameter	-	16	32	5
	JOR4-36D-16	1706	1880	1879	1587	36 Diameter	-	16	43	12
	JOR4-18D-21	1239	1360	1359	1152	18 Diameter	-	21	22	4
	JOR4-24D-21	1323	1439	1456	1230	24 Diameter	-	21	35	7

LEED CI CREDITS



MATERIAL CONTENT:

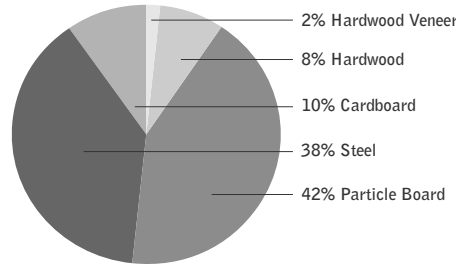

PRE-CONSUMER RECYCLED CONTENT = 54.33%

POST-CONSUMER RECYCLED CONTENT = 16.83%

CONTRIBUTES TO

CREDIT 2.1 - 2.2	Construction Waste Management	1-2 point(s)
CREDIT 3.3	Resource Reuse	1 point
CREDIT 4.1	Recycled Content	1 point
CREDIT 4.2	Recycled Content	1 point
CREDIT 4.5	Low Emitting Materials, Systems & Seating	1 point
CREDIT 5.1	Regional Materials*	1 point
CREDIT 7	Certified Wood (MUST BE REQUESTED)	1 point(s)

*This credit is only applicable if in total 20% of the combined value of the procurement of construction materials and in the furniture are manufactured within a radius of 500 miles. This credit will apply if the installation of the finished product occurs within 500 miles of Kitchener, Ontario.

level® CERTIFICATION, AIR EMISSIONS AND FSC® CERTIFICATION



level® CERTIFICATION

BIFMA's e3 Furniture Sustainability Standard is a voluntary, multi-attribute standard that measures the degree of sustainability of furniture. This standard evaluates product and company environmental attributes and compliance systems in a wide range of elements which include Materials, Energy & Atmosphere, Human & Ecosystem Health and Social Responsibility. Solis products have earned level®, BIFMA's sustainability certification program for furniture, certification through third-party verification against the e3 standard.

AIR-EMISSIONS

All Solis products are supplied with air-emissions certified. Contact customer service for information.



FSC®

In 2005, Krug received Forest Stewardship Council® (FSC®) Chain-of-Custody certification for our manufacturing facilities. The FSC® Chain-of-Custody tracks certified wood from seedling to final sale. It verifies that the material for our FSC® certified products only come from well-managed, FSC®-certified forests and other controlled sources. FSC® is dedicated to the promotion of responsible forest management worldwide helping to take care of forests for future generations. Solis and other Krug products can be specified with FSC® Certification. Contact customer service for further information, pricing and lead times.



Architects, designers, and building professionals can specify FSC®-certified products in order to achieve a point from the U.S. Green Building Council's Leadership in Energy and Environmental Design (LEED) Rating System.

SOLIS | TABLES, FEATURES & OPTIONS

STANDARD FINISHES

Solid Beech & Maple edges with Veneer tops. For a complete list of standard wood finishes, please see [page 550](#). Solis tables are available in 22 standard finishes.

LAMINATE AND POLYMER EDGE

Solis tables are available in laminates with wood or laminates with Polymer edge. See [page 551](#) for laminate information.

METAL FINISHES

Silver Metallic Standard - No Upcharge
 Silver Metallic frames are available with an anti-microbial finish for an upcharge of **\$64 list** per arm frame pair or table. Additional Frame Finishes are available for an upcharge of **\$64 list** per seat/ table.
 Available colors are: • White • Parchment • Sand • Taupe • Warm Grey • Cool Grey • Black

For all metal finishes other than Silver Metallic Standard, there is a minimum order quantity of 30 units per color. The anti-microbial finish is included in the additional finish up-charge. Upcharges for order quantities less than 30 units per color or custom metal finishes, please contact Customer Service to obtain a quote.

[View Solis images | www.krug.ca](http://www.krug.ca)

ORDERING NOTES:

Linking tables can be ordered in conjunction with any of the Krug Solis Multiple Seating. Linking tables are connected to the Multiple Seating via U-Shaped brackets. The design of the tables for Solis Multiple Seating allows for any table to be very easily added or moved to a new position within the configuration - or completely replaced - after the product has been first installed. The attachment of the tables is designed so that they can be readily be taken out of the configuration without any defacing of the adjoining seat frames.

Linking tables also feature a universal, non-handed design:

They can be moved to reverse position in almost every configuration, providing a high level of flexibility for reconfiguring.

Please note Solis Plastic Laminate Linking Tables are not available on *KrugExpress*.

Wood Tops with Wood Edges are available on *KrugExpress* but with a minimum order requirement of 5 tables per order.

A drawing showing the configuration of the multiple seating and tables are required with each purchase order.

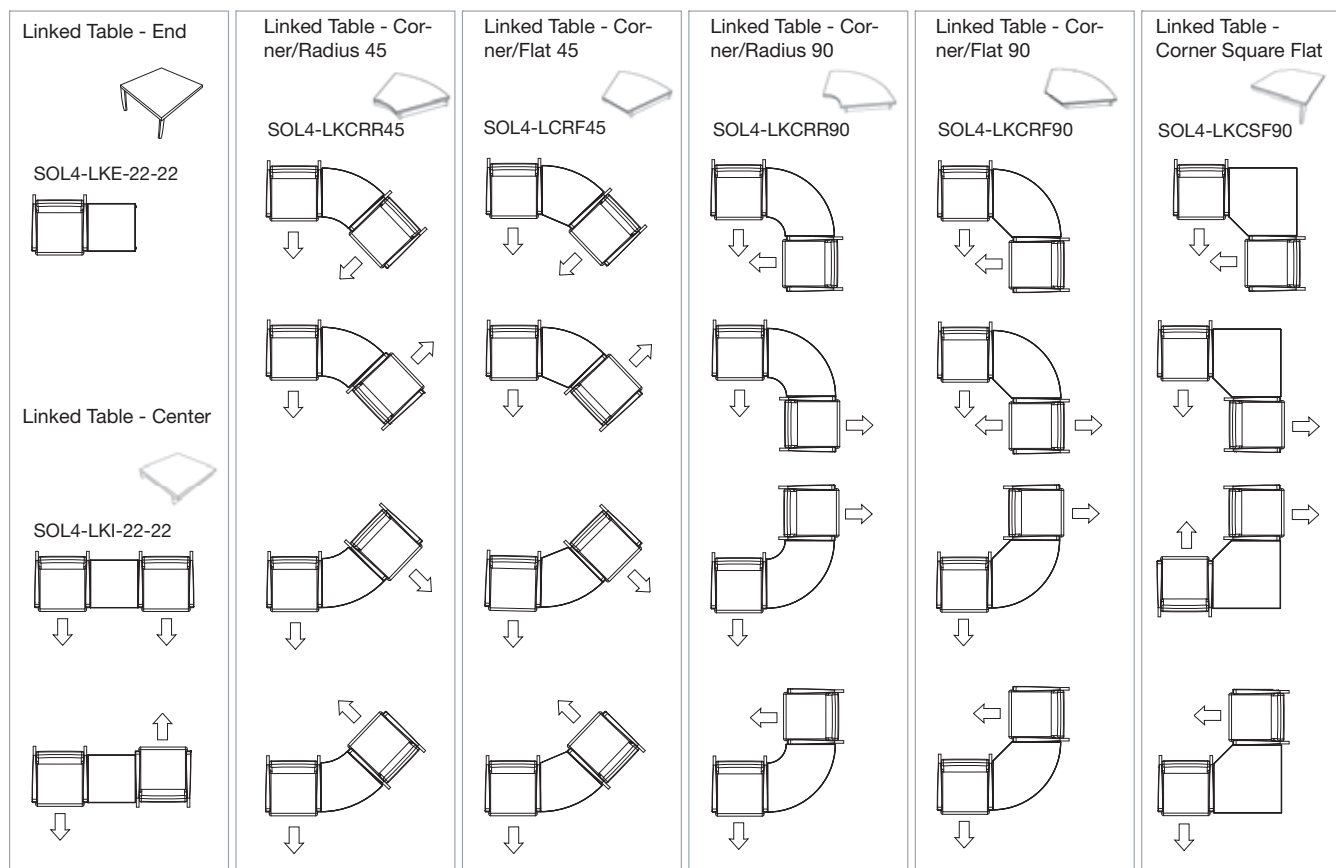

SOLIS | LINKING TABLES

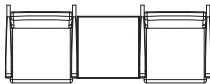
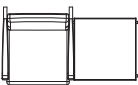
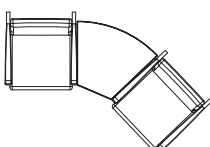
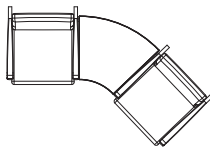
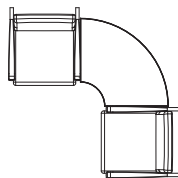
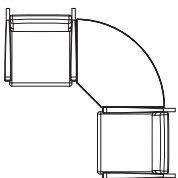
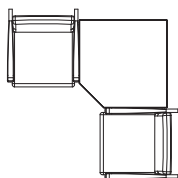
DESCRIPTION/MODEL	Beech	Maple	Laminate with Wood Edge	Laminate with Polymer Edge	W	D	Weight	Cubes
 Center Square Table SOL4-LKI-22-22	617	647	752	591	22	22	18	1.5
 End Square Table SOL4-LKE-22-22	658	693	803	634	22	22	20	1.5
 Curvilinear Connector Table 45° with flat edge SOL4-LKCRF45	598	630	730	591	27.5	27.5	21	2.2
 Curvilinear Connector Table 45° SOL4-LKCRR45	628	662	766	622	27.5	27.5	21	2.2
 Curvilinear Connector Table 90° SOL4-LKCRR90	708	746	866	706	30	30	27	2.2
 Curvilinear Connector Table 90° with flat edge SOL4-LKCRF90	699	738	852	695	30	30	29	2.2
 Rectilinear Corner Connector Table 90° SOL4-LKCSF90	785	829	958	739	30	30	32	2.2

ORDERING NOTES:

Linking tables can be ordered in conjunction with any of the Solis Multiple Seating. Linking tables are connected to the Multiple Seating via U-Shaped brackets.

Rectilinear Corner Connector table 90° include a support leg in the outer corner.









When specifying Linking Tables please ensure that each unit has legs on either side of the table.

Please note Solis Plastic Laminate Linking Tables are not available on *KrugExpress*.

Wood Tops with Wood Edges are available on *KrugExpress* but with a minimum order requirement of 5 tables per order.

A drawing showing the configuration of the multiple seating and tables is required with each purchase order.

SOLIS | FREE STANDING TABLES

DESCRIPTION/MODEL	Beech	Maple	Laminate with Wood Edge	Laminate with Polymer Edge	W	D	H	Weight	Cubes	
 Square Tables SOL4-22-22-16	583	613	708	552	22	22	16	26	5	
 SOL4-42-22-16	809	852	988	759	42	22	16	46	9	
 SOL4-22-22-21	588	618	716	558	22	22	21	28	7	
<hr/>										
 Circular Tables SOL4-18D-16	515	542	630	491	18 Diameter	-	16	20	3	
 SOL4-18D-21	532	560	648	508	18 Diameter	-	21	22	4	
 SOL4-24D-16	544	576	666	530	24 Diameter	-	16	32	5	
 SOL4-24D-21	588	618	716	568	24 Diameter	-	21	35	7	
 SOL4-36D-16	830	873	1011	844	36 Diameter	-	16	43	12	

557 Tranquility

TRANQUILITY | ENVIRONMENTAL SUMMARY

LEED CI CREDITS



MATERIAL CONTENT:

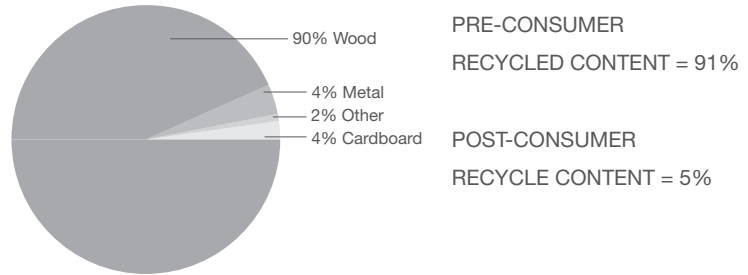

CONTRIBUTES TO

CREDIT 2.1 - 2.2	Construction Waste Management	1-2 point(s)
CREDIT 4.1	Recycled Content	1 point
CREDIT 4.2	Recycled Content	1 point
CREDIT 4.5	Low Emitting Materials	1 point
	Composite Wood & Laminate Adhesives	1 point
CREDIT 5.1	Regional Materials*	1 point
CREDIT 7	Certified Wood (PLEASE ENQUIRE)	1 point

* This credit is only applicable if in total 20% of the combined value of the procured construction materials and furniture is manufactured within a radius of 500 miles. This credit will apply if the installation of the finished product occurs within 500 miles of Kitchener, Ontario.

level® CERTIFICATION, AIR EMISSIONS AND FSC® CERTIFICATION



level® CERTIFICATION

BIFMA's e3 Furniture Sustainability Standard is a voluntary, multi-attribute standard that measures the degree of sustainability of furniture. This standard evaluates product and company environmental attributes and compliance systems in a wide range of elements which include Materials, Energy & Atmosphere, Human & Ecosystem Health and Social Responsibility. Tranquility products have earned level®, BIFMA's sustainability certification program for furniture, certification through third-party verification against the e3 standard.

AIR-EMISSIONS

All Tranquility products are supplied with air-emissions certified. Contact customer service for information.



The mark of responsible forestry

FSC®

In 2005, Krug received Forest Stewardship Council® (FSC®) Chain-of-Custody certification for our manufacturing facilities. The FSC® Chain-of-Custody tracks certified wood from seedling to final sale. It verifies that the material for our FSC® certified products only come from well-managed, FSC®-certified forests and other controlled sources. FSC® is dedicated to the promotion of responsible forest management worldwide helping to take care of forests for future generations. Tranquility and other Krug products can be specified with FSC® Certification. Contact customer service for further information, pricing and lead times.



Architects, designers, and building professionals can specify FSC®-certified products in order to achieve a point from the U.S. Green Building Council's Leadership in Energy and Environmental Design (LEED) Rating System.

THE GENESIS OF TRANQUILITY

Tranquility infusion bay furniture was designed to provide effective solutions for several applications including chemotherapy units within oncology departments, and areas administering renal dialysis.

Before actual product was even contemplated, extensive research was completed to understand the needs of the infusion patient and their supporting caregivers and family or friends.

Foremost among these needs was the requirement to provide the patient with privacy during their treatment sessions or the option to socialize and share experiences with a neighboring patient. And we wanted to put the patient in control of their choices to the largest extent possible. It was clear that the furniture needed to allow the patient to embrace nature where possible and that the product components should reflect natural elements. The furniture needed to contribute to a quiet and soothing environment in which the patient could comfortably relax, rest, work or enjoy a snack. We also learned the physical requirements of each of the patients, caregivers and family and friends. This included the needs for storage of belongings, supplies, and disposal of various types of wastes, as well as the supports for the treatment. Finally, it was clear that the product had to make maximum use of space, as cost-effectively as possible.

Tranquility is a highly-effective response to the needs. The core of the design is the use of sliding resin panels embedded with organic elements to divide patient bays. At the mutual agreement of neighboring patients, the resin panels can be slid open to provide an opportunity to visit and share experiences. The patient is provided with many options - swivel to take in an outside landscape, converse with another patient or a family member, rest in privacy, read, watch a movie, or work on their computer. There is ample storage for personal belongings. A warming blanket can be located in a drawer beside them. There is space for the caregiver to store supplies, dispose of wastes and maintain charts. The unique Combination Patient Entertainment/Nurses' Module provides space for TV and DVD for two patients as well as work space and storage for caregivers, all in one unit at a minimized footprint.

Tranquility – an outstanding solution for cancer care and other treatment applications.

TRANQUILITY | SAMPLE CONFIGURATION

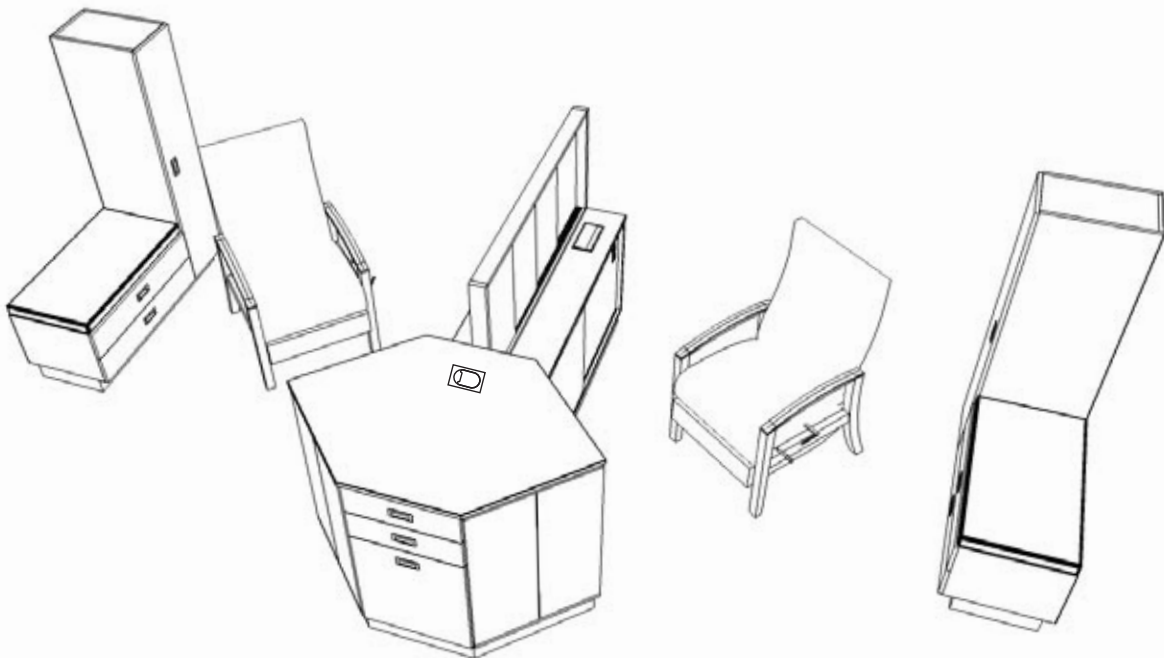

QTY	MODEL	LAMINATE	VENEER
1	IP1649	2970	3471
1	IT1559	2746	3339
1	IR1649N	2505	2505
1	IW2129L	1663	2064
2	IC2369N	1590	1935
		1590	1935
1	IW2129R	1663	2064
1	Grommet	152	152
1	PowerPort1	397	397
		\$15,276	\$17,862

*Resin insert quoted separately

Priced with Delphine front, Indus pulls, Plywood base, Laminate top.

TRANQUILITY | FEATURES & OPTIONS

BREADTH OF LINE:

The Tranquility infusion casegoods offering provides solutions from contemporary to transitional to traditional styling. The line includes wardrobes, benches, patient divider modules, sliding resin partitions, patient entertainment module, nurses' modules and combination patient entertainment / nurses' modules.

CUSTOM CAPABILITY:

Krug can offer both custom sizes of standard product and completely custom units. For more information, please contact Customer Service.

DURABILITY:

Cabinets are constructed of ¾" thick panels including backs. In contrast to cabinets constructed with 1/8" back panels, the Tranquility units are more robust and less susceptible to damage. All exposed laminate edges are covered with 2.5 mm polymer edgebanding in colors matching the laminates. This thicker edgebanding provides an increased level of durability on all edges as well as a 2.5 mm radius on the edge. The softer radius is less likely to bruise or cut the skin of a patient or caregiver.

LAMINATES:

"Laminate" is variously known in the marketplace as Thermofused Melamine, Low-Pressure Laminate or LPL. There are 2 solid color options and 7 wood-grain colors. Colors are available in laminate, high-pressure laminate or thermoformed vinyl. Polymer Edgebanding matches the laminate selection. Wood finishes to match the wood-grain laminates are available for Krug Healthcare Seating.

VENEER:

The Tranquility product is also available in maple veneer. The veneered version is available with the Delphine front.

AIR-EMISSIONS:

All products can be air-emissions certified. Upcharges and extended leadtimes may apply. Please contact customer service for more information.

WARRANTY:

All cabinets carry a limited lifetime warranty.

SUSTAINABILITY

Tranquility cabinets have a very high recycled content and contribute to both LEED credits 4.1 and 4.2. The packaging is recyclable. Non-urea-added core is available as an option and air-emissions certified product is also optionally available. FSC-certified wood may be possible on larger projects.

DRY FIT CONSTRUCTION:

Cabinets, other than the combination patient entertainment/nurses' modules and patient divider modules, are assembled with mechanical cams. This is known as dry fit construction. The result is that any panel can be replaced if damaged, unlike cabinets that are glued together where damage to any surface leads to replacement of the entire unit.

SEALED CORE:

All unseen particle board edges that are not covered by an adjoining panel are edge banded (i.e. no exposed particle board). As with the vent covers noted above, this prevents moisture and bacteria from seeping into the core.

BASES:

Separate plywood 4" bases including leveling glides are supplied for cabinets. Bases are included in the component pricing and do not need to be specified separately. Typically the vinyl base molding used in the room would be applied. HPL cladding can be ordered as an option. HPL is grey unless otherwise requested.

MASTER KEY

Tranquility cabinets have the option to lock with a master key. This must be specified on the order.

HIGH - PRESSURE LAMINATE BASES

Standard Tranquility base is plywood. Optionally, this can be clad in HPL.

CABINET MOUNT MARKERBOARD:

The Markerboards are 24" high by 12" wide (slightly narrower on 12" wide wardrobes). They can be mounted to the inside or outside of the cabinet door.

CABINET MOUNT MIRROR OPTION:

The Mirrors are 24" high by 12" wide and acrylic. They can be mounted to the inside or outside of the cabinet door.

TRANQUILITY | FEATURES & OPTIONS



DOOR AND DRAWER PULL STYLES:

The Indus pull eliminates a protrusion that could bruise a patient or caregiver. The finish is Silver Metallic. Circa offers a very large grip. The pull could be accessed with a closed knuckle. It has a Silver Metallic finish. Ravenna is an attractive transitional pull in satin nickel. Padua is a traditional pull in antique brass.



BENCH:

The cushion for the bench is 3" thick. The plus version of the bench supports 500 pounds



SLIDING RESIN PANELS:

Krug can quote and procure a wide variety of Translucent Resin Panels, many of which are embedded with organic materials.



VENTS:

There is one 1" diameter vent for each drawer and each door set for air circulation on the benches & wardrobes. All vent holes are covered with plastic vents both inside and outside to eliminate exposed particle board, thus preventing moisture and bacteria from entering the core.



DRAWERS:

Drawers have white metal sides with white laminate bottoms and backs, and all exposed particle board edges are edge banded. The unobstructed metal sides facilitate cleaning. Bumpers are installed on all drawers and doors to soften the sound of closing. Large drawers use white Laminate sides and extension slides.

Locking Top Drawer or Door

Tranquility cabinets have the option to lock. They can be randomly keyed for security. The lock option is factory installed and must be specified on the order.



TOPS:

Tops can be laminate with polymer edgebanding, high-pressure laminate with polymer edgebanding or solid surface.

Tops on units over 40" high are laminate only.

Laminate and veneer tops are 3/4" thick. High-pressure laminate and solid surface tops are 1" thick and cabinets with those tops are 1/4" taller.

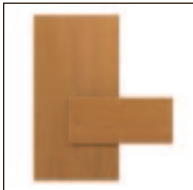

DOOR / DRAWER FRONTS:

Door / drawer fronts are 3/4" thick and 3 styles are available.

- Delphine - Laminate with Polymer Edge or Veneer
- Como - seamless Thermoformed Vinyl with white backs
- Bassano - seamless Thermoformed Vinyl with white backs (Como and Bassano fronts are not available on Patient Divider Modules)
- Veneer - veneer front with 3mm wood edge

TRANQUILITY | SPECIFYING

REQUIRED TO SPECIFY

After each product grouping in the following pages, there is a summary under the title "Required to Specify". The summary lists the elements that need to be specified including Model Number, Base, Pull Style and Color, Body Style and Color,

DOOR AND DRAWER PULL STYLES:

Select one:



Indus - I
Silver Metallic
\$39 each



Circa - C
Silver Metallic
\$6 each



Ravenna - R
Satin Nickel
No Upcharge



Padua - P
English Antique Brass
\$6 each

ORDERING NOTES:

Indus pulls can not be used on Front Style - Como.

LAMINATE COLORS - Select one:



Champagne



Hardrock Maple



Dune



Gingerbread



Portobello

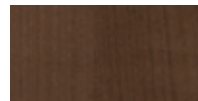

Chocolate



Park Avenue Walnut



Dark Walnut



Ash



Willow



Nutmeg



Copper



Shiraz Cherry

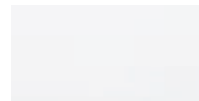

Designer White

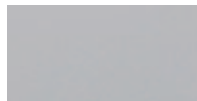

Platinum



Charcoal



Earth

VINYL COLORS:

Select one:



Champagne



Hardrock Maple



Copper



Park Avenue Walnut



Dark Walnut



Nutmeg



Ash

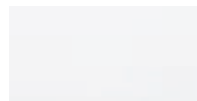

Designer White



Platinum



Earth

VENEER COLORS - Select one:



Clear Maple



Wheat Maple



Honey Maple

SOLID SURFACE: Please contact customer service for a quote. See [page 551](#) for color options.

TRANQUILITY | WARDROBES - SINGLE SIDED

FRONT STYLES

Delphine front is laminate. Como and Bassano are thermoformed vinyl.

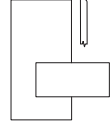
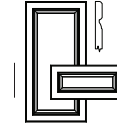
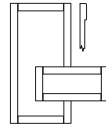
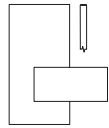

Description	Model	Delphine - D	Como - C	Bassano - B	Veneer - V
Open Wardrobe with Coat Rod	IW1129NP	1374	N/A	N/A	1583

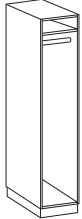

Closed Wardrobe with Coat Rod	IW2129LP* IW2129RP	1663	1852	1852	2064
-------------------------------	-----------------------	------	------	------	------



DIMENSIONS

	Overall Width	Overall Depth	Overall Height	Shipping Weight	Cubes
IW1129	12	19.75	59	77	10
IW2129	12	19.75	59	91	10

REQUIRED TO SPECIFY

1. **Model number** (above)
2. **Front Style** (above)
3. **Pull Style** (page 481)
4. **Case Color** (page 481)
5. **Options** (below)

OPTIONS	List	List
Cabinet Mount Markerboard (inside) - MB	145 (each)	Locking Top Drawer or Door - LK
Cabinet Mount Markerboard (outside) - MB2	145 (each)	Master Key - MK
Cabinet Mount Mirror (inside) - AB	182 (each)	Base Upgrade to HPL - H
Cabinet Mount Mirror (outside) - AB2	182 (each)	NOTE: to order change "P" to "H" and add calculated upcharge

MODEL CODE KEY

Product Line	Description	Style	Width	Base Style	Orientation (hinge side when facing cabinet)	Base Option
I	W	1	12	9	L	P
Infusion	Wardrobe	Open		no legs	Hinged Left	Plywood (n/c)
		2			R	H
		Closed Door			Hinged Right	HPL
					N	
					No Hinge	

TRANQUILITY | WARDROBES - DOUBLE SIDED

FRONT STYLES

Delphine front is laminate. Como and Bassano are thermoformed vinyl.

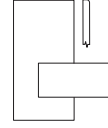
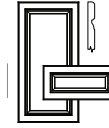
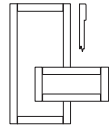
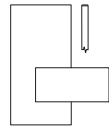

Description	Model	Delphine - D	Como - C	Bassano - B	Veneer - V
Open Wardrobe with Coat Rod - Double Sided	IW3129NP	1562	N/A	N/A	2077

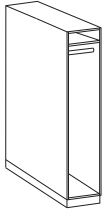

Closed Wardrobe with Coat Rod - Double Sided	IW4129LP* IW4129RP	2129	2566	2566	2736
--	-----------------------	------	------	------	------

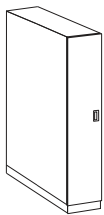

DIMENSIONS

	Overall Width	Overall Depth	Overall Height	Shipping Weight	Cubes
IW3129	12	39.5	59	140	20
IW4129	12	39.5	59	168	20

REQUIRED TO SPECIFY

1. **Model number** (above)
2. **Front Style** (above)
3. **Pull Style** (page 481)
4. **Case Color** (page 481)
5. **Options** (below)

OPTIONS

	List	List
Cabinet Mount Markerboard (inside) - MB	145 (each)	Locking Top Drawer or Door - LK 71 (each)
Cabinet Mount Markerboard (outside) - MB2	145 (each)	Master Key - MK 61
Cabinet Mount Mirror (inside) - AB	182 (each)	Base Upgrade to HPL - H 16 (per lineal foot)
Cabinet Mount Mirror (outside) - AB2	182 (each)	NOTE: to order change "P" to "H" and add calculated upcharge

MODEL CODE KEY

Product Line	Description	Style	Width	Base Style	Orientation (hinge side when facing cabinet)	Base Option
I	W	3	12	9	L	P
Infusion	Wardrobe	Open -Double Sided		no legs	Hinged Left	Plywood (n/c)
		4			R	H
		Closed Door- Double Sided			Hinged Right	HPL
					N	
					No Hinge	

TRANQUILITY | BENCHES - SINGLE SIDED

FRONT STYLES

Delphine front is laminate. Como and Bassano are thermoformed vinyl.

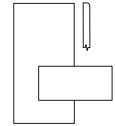
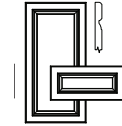
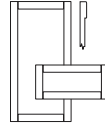
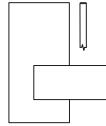

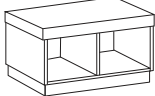
Description	Model	Delphine - D	Como - C	Bassano - B	Veneer - V
Open Bench	IC1309NP	1032	N/A	N/A	1303
	IC1369NP	1143	N/A	N/A	1440
Open Bench Plus	IC4369NP	1207	N/A	N/A	1539
					

DIMENSIONS

	Overall Width	Overall Depth	Overall Height	Shipping Weight	Cubes
IC1309	29.25	19.75	23	60	8
IC1369	35.25	19.75	23	68	9
IC4369	35.25	19.75	23	73	9

REQUIRED TO SPECIFY

1. Model number (above)
2. Front Style (above)
3. Pull Style (page 481)
4. Case Color (page 481)
5. Cushion Upholstery (page 544)
6. Options (below)

OPTIONS

List

List

Moisture Barrier (Single Cushion)	92	Master Key - MK	61
Base Upgrade to HPL - H	16 (per lineal foot)		

NOTE: to order change "P" to "H" and add calculated upcharge

CUSHION UPHOLSTERY UPGRADE

Cushions for Single Bench are priced in COM/Grade 1. For fabric upgrades add upcharge below.

Grade	2	3	4	5	6	7	8	9	COM YDG
	\$32	61	115	173	231	287	343	456	85 (30" & 36")

WEIGHT RATING Tranquility Benches have a load weight rating of 500lbs.

MODEL CODE KEY



Product Line	Description	Style	Width	Base Style	Orientation (hinge side when facing cabinet)	Base Option
<input type="checkbox"/> I	<input type="checkbox"/> C	<input type="checkbox"/> 1	<input type="checkbox"/> 30	<input type="checkbox"/> 9	<input type="checkbox"/> N	<input type="checkbox"/> P
Infusion	Cushioned Bench	Open Bench		no legs	Non Handed	Plywood (n/c)
		<input type="checkbox"/> 4	<input type="checkbox"/> 36			<input type="checkbox"/> H
		Open Bench Plus				HPL

TRANQUILITY | BENCHES - SINGLE SIDED

FRONT STYLES

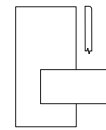
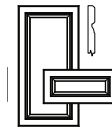
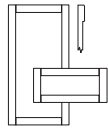
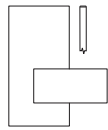
Delphine front is laminate. Como and Bassano are thermoformed vinyl.



Description	Model	Delphine - D	Como - C	Bassano - B	Veneer - V
	IC3309NP	1232	1354	1354	1522
	IC3369NP	1363	1555	1555	1686
	IC2309NP	1434	1555	1555	1747
	IC2369NP	1590	1747	1747	1935

DIMENSIONS

	Overall Width	Overall Depth	Overall Height	Shipping Weight	Cubes
IC2309	29.25	19.75	23	88	8
IC2369	35.25	19.75	23	102	9
IC3309	29.25	19.75	23	78	8
IC3369	35.25	19.75	23	90	9

REQUIRED TO SPECIFY

1. Model number (above)
2. Front Style (above)
3. Pull Style (page 481)
4. Case Color ((page 481)
5. Cushion Upholstery (page 544)
6. Options (below)

OPTIONS	List	List
Moisture Barrier (Single Cushion)	92	Locking Top Drawer or Door - LK
Base Upgrade to HPL - H	16 (per lineal foot)	Master Key - MK
		71 (each)
		61

NOTE: to order change "P" to "H" and add calculated upcharge

CUSHION UPHOLSTERY UPGRADE

Cushions for Single Bench are priced in COM/Grade 1. For fabric upgrades add upcharge below.

Grade	2	3	4	5	6	7	8	9	COM YDG
	\$32	61	115	173	231	287	343	456	85 (30" & 36")

WEIGHT RATING Tranquility Benches have a load weight rating of 500lbs.

MODEL CODE KEY

Product Line	Description	Style	Width	Base Style	Orientation (hinge side when facing cabinet)	Base Option
I	C	3	30	9	N	P
Infusion	Cushioned Bench	1 Drawer		no legs	Non Handed	Plywood (n/c)
		2	36			H
		2 Drawer				HPL

TRANQUILITY | BENCHES - DOUBLE SIDED

FRONT STYLES

Delphine front is laminate. Como and Bassano are thermoformed vinyl.

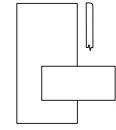
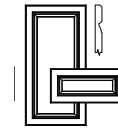
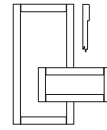
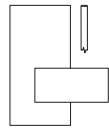

Description	Model	Delphine - D	Como - C	Bassano - B	Veneer - V
Open Bench - Double Sided	IC5309NP	1319	N/A	N/A	1585
	IC5369NP	1438	N/A	N/A	1713
Open Bench Plus - Double Sided	IC8369NP	1501	N/A	N/A	1813

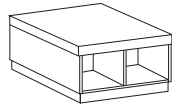
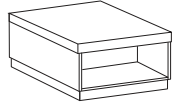

DIMENSIONS

	Overall Width	Overall Depth	Overall Height	Shipping Weight	Cubes
IC5309N	29.25	39.5	23	109	16
IC5369N	35.25	39.5	23	123	18
IC8369N	35.25	39.5	23	133	18

REQUIRED TO SPECIFY

1. Model number (above)
2. Front Style (above)
3. Pull Style (page 481)
4. Case Color (page 481)
5. Cushion Upholstery (page 544)
6. Options (below)

OPTIONS

	List	List
Moisture Barrier (Double Cushion).	137	Master Key - MK
Base Upgrade to HPL - H	16 (per lineal foot)	59

NOTE: to order change "P" to "H" and add calculated upcharge

CUSHION UPHOLSTERY UPGRADE

Cushions for Double Bench are priced in COM/Grade 1. For fabric upgrades add upcharge below.

Grade	2	3	4	5	6	7	8	9	COM YDG
	\$42	89	171	258	340	427	513	686	1.3 (30" & 36")

WEIGHT RATING Tranquility Benches have a load weight rating of 500lbs.

MODEL CODE KEY

Product Line	Description	Style	Width	Base Style	Orientation (hinge side when facing cabinet)	Base Option
I	C	5	30	9	N	P
Infusion	Cushioned Bench	Open Bench - Double Sided		no legs	Non Handed	Plywood (n/c)
		8	36			H
		Open Bench Plus - Double sided				HPL

TRANQUILITY | BENCHES - DOUBLE SIDED

FRONT STYLES

Delphine front is laminate. Como and Bassano are thermoformed vinyl.

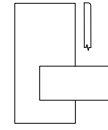
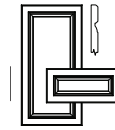
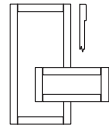
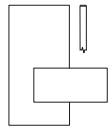

Description	Model	Delphine - D	Como - C	Bassano - B	Veneer - V
1-Drawer Bench -Double Sided	IC7309NP	1911	2163	2163	2255
	IC7369NP	2033	2346	2346	2388



2-Drawer Bench -Double Sided	IC6309NP	2286	2526	2526	2657
	IC6369NP	2410	2712	2712	2791



DIMENSIONS

	Overall Width	Overall Depth	Overall Height	Shipping Weight	Cubes
IC6309N	29.25	39.5	23	165	16
IC6369N	35.25	39.5	23	191	18
IC7309N	29.25	39.5	23	145	16
IC7369N	35.25	39.5	23	167	18

REQUIRED TO SPECIFY

1. Model number (above)
2. Front Style (above)
3. Pull Style (page 481)
4. Case Color ((page 481)
5. Cushion Upholstery (page 544)
6. Options (below)

OPTIONS

List

List

Moisture Barrier (Double Cushion).	143	Master Key - MK	61
Base Upgrade to HPL - H	16 (per lineal foot)		

NOTE: to order change "P" to "H" and add calculated upcharge

CUSHION UPHOLSTERY UPGRADE

Cushions for Double Bench are priced in COM/Grade 1. For fabric upgrades add upcharge below.

Grade	2	3	4	5	6	7	8	9	COM YDG
	\$42	89	171	258	340	427	513	686	1.3 (30" & 36")

WEIGHT RATING Tranquility Benches have a load weight rating of 500lbs.

MODEL CODE KEY

Product Line	Description	Style	Width	Base Style	Orientation (hinge side when facing cabinet)	Base Option
I	C	7	30	9	N	P
Infusion	Cushioned Bench	1 Drawer Bench -Double Sided		no legs	Non Handed	Plywood (n/c)
		6	36			H
		2 Drawer Bench -Double sided				HPL

TRANQUILITY | PATIENT DIVIDER MODULES

FRONT STYLES

Delphine-D front is laminate.

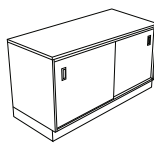

Description	Model	Delphine - D	Veneer - V
 Patient Divider Module 20" Deep & 26" Deep	IP1569NPL	2831	3315
	IP1649NPL	2970	3471
	IP2569NPL	2963	3479
	IP2649NPL	3113	3641
 Patient Divider Module 20" Deep Single Sided	IP3569LPL* RPL	2218	2682
	IP3649LPL RPL	2355	2838

DIMENSIONS

	Overall Length	Overall Depth	Overall Height	Shipping Weight	Cubes
IP1569	56	20	30	200	24
IP1649	64	20	30	230	27
IP2569	56	26	30	225	31
IP2649	64	26	30	255	35
IP3569	56	20	30	162	24
IP3649	64	20	30	185	27

REQUIRED TO SPECIFY

1. Model number (above)
2. Front Style (above)
3. Pull Style (page 481)
4. Top Color (page 481)
5. Case Color (page 481)
6. Options (below)

OPTIONS

	List	List
Base Upgrade to HPL - H	16 (per lineal foot)	Locking Top Drawer or Door - LK Master Key - MK
NOTE: to order change "P" to "H" add calculated upcharge		
Top Upgrade to HPL w/Polymer Edge - P 20"x56"	617	
NOTE: to order change "L" to "P"		
20"x64"	676	
26"x56"	701	
26"x64"	774	

MODEL CODE KEY

Product Line	Description	Style	Length	Base Style	Orientation (when facing cabinet)	Base Option	Top Option
I	P	1	56	9	L	P	L
Infusion	Patient Divider Module	20" Deep		no legs	Left Handed	Plywood (n/c)	Laminate (n/c)
		2	64		R	H	P
		26" Deep			Right Handed	HPL	HPL w/Polymer Edge
		3			N		
		20" Deep -Single Sided			Non Handed		

TRANQUILITY | SLIDING RESIN PARTITIONS

Description	Model	Price	Qty 5-10 Price	Qty 10+ Price
Sliding Resin Partition - Solid Maple Frame	IR1569N	2391	N/A	
	IR1649N	2505		



Sliding Resin Partition - Grade A Glacier White-Solid Surface Frame	IR2569N	3333	2694	2536
	IR2649N	3490	2820	2650

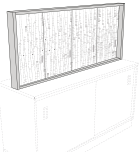

ORDERING NOTES:

Price includes the frame and the machining of the resin panels, but does not include the cost of the resin. Krug can quote and procure a wide variety of Translucent Resin Panels, many of which are embedded with organic materials. Please contact customer service for assistance.

DIMENSIONS

	Overall Length	Overall Depth	Overall Height	Shipping Weight	Cubes
IR1569	56	4	24	45	7.5
IR1649	64	4	24	51	7.5
IR2569	56	4	24	45	7.5
IR2649	64	4	24	51	7.5

REQUIRED TO SPECIFY

1. Model number
2. Maple finish (page 481)
3. Specify Translucent Resin Panels (contact customer service for assistance)

PRODUCT CODE KEY

Product Line	Description	Style	Length	Base Style	Orientation (when facing cabinet)
I	R	1	56	9	N
Infusion	Sliding Resin Partition	Solid Maple Frame		no legs	Non Handed
		2	64		
		Solid Surface Frame			

TRANQUILITY | PATIENT ENTERTAINMENT MODULES

FRONT STYLES

Delphine front is laminate.

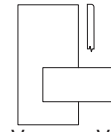
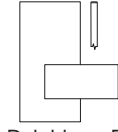

Description	Model	Delphine - D	Veneer - V
Patient Entertainment Module - Single Sided	IE1259NPL	1465	1752

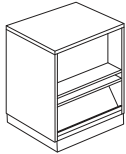

Patient Entertainment Module - Double Sided (20" Deep & 26" Deep)	IE2259NPL	1743	2042
	IE3259NPL	1998	2343

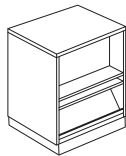

ORDERING NOTES:

Inside space for TV units is approximately 23.25" wide x 17.25" high and the DVD space is 23.25" wide x 2.75" high

DIMENSIONS

	Overall Width	Overall Depth	Overall Height	Shipping Weight	Cubes
IE1259	24.75	20	40.25	102	15
IE2259	24.75	20	40.25	110	15
IE3259	24.75	26	40.25	125	19

REQUIRED TO SPECIFY

1. Model number (above)
2. Front Style (above)
3. Top Color (page 481)
4. Case Color (page 481)
5. Options (below)

OPTIONS

List

Base Upgrade to HPL - H 16 (per lineal foot)

NOTE: to order change "P" to "H" add calculated upcharge

Top Upgrade to HPL w/Polymer Edge - P 24.75"x20" 279

NOTE: to order change "L" to "P" 24.75"x26" 352

MODEL CODE KEY

Product Line	Description	Style	Width	Base Style	Orientation (when facing cabinet)	Base Option	Top Option
I	E	1	25	9	N	P	L
Infusion	Patient Entertainment Module	20" Deep -Single Sided		no legs	Non Handed	Plywood (n/c)	Laminate (n/c)
		2				H	P
		20" Deep				HPL	HPL w/Polymer Edge
		3					
		26" Deep					

TRANQUILITY | NURSES' MODULES

FRONT STYLES

Delphine front is laminate. Como and Bassano are thermoformed vinyl.

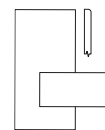
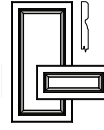
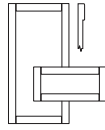
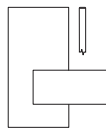

Description	Model	Delphine - D	Como - C	Bassano - B	Veneer - V
Combined Patient Entertainment/ Nurses' Module	IT1559NPL*	2746	2948	2948	3339
	IT1619NPL	2867	3099	3099	3488



Back View

Combined Patient Entertainment/ Nurses' Module - End Unit	IT2389LPL* RPL	2378	2570	2570	2936
---	-------------------	------	------	------	------



	IT2449LPL RPL	2497	2720	2720	3088
--	------------------	------	------	------	------



Back View

ORDERING NOTES:

Inside space for TV units is approximately 23.25" wide x 17.25" high and the DVD space is 23.25" wide x 2.75" high. IT1559, IT2389 have a 20" back and fit to a 20" wide Patient Divider Module. IT1619 and IT2449 have 26" backs.

DIMENSIONS

	Overall Width	Overall Depth	Overall Height	Shipping Weight	Cubes
IT1559	55.5	35.3	40.25	310	65
IT1619	61.5	35.3	40.25	334	72
IT2389	37.75	35.3	40.25	240	48
IT2449	43.75	35.3	40.25	264	55

REQUIRED TO SPECIFY

1. Model number (above)
2. Front Style (above)
3. Pull Style (page 481)
4. Top Color (page 481)
5. Case Color (page 481)
6. Options (below)

OPTIONS

	List		List
Base Upgrade to HPL - H	16 (per lineal foot)	Top Upgrade to HPL w/Polymer Edge - P	55.5"x35.3" 982
NOTE: to order change "P" to "H" add calculated upcharge		NOTE: to order change "L" to "P"	61.5"x35.3" 1107
Locking Top Drawer or Door - LK	71 (each)		37.75"x35.3" 739
Master Key - MK	61		43.75"x35.5" 845

MODEL CODE KEY

Product Line	Description	Style	Width	Base Style	Orientation (when facing cabinet)	Base Option	Top Option
I	T	1	55	9	N	P	L
Infusion	Nurses Module	Full Unit	61	no legs	Non Handed	Plywood (n/c)	Laminate (n/c)
		2	38			H	P
		End Unit	44			HPL	HPL w/Polymer Edge

TRANQUILITY | NURSES' MODULES

FRONT STYLES

Delphine front is laminate. Como and Bassano are thermoformed vinyl.

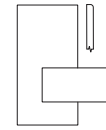
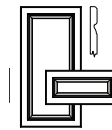
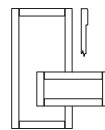
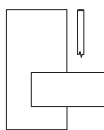

Description	Model	Delphine - D	Como - C	Bassano - B	Veneer - V
Nurses' Module - 3 Drawers (20" & 26"w)	IN1209NPL	1836	2035	2035	2147
	IN1269NPL	1923	2124	2124	2250



Nurses' Module - 5 Small Drawers (20 & 26" w)	IN2209NPL	2061	2193	2193	2412
	IN2269NPL	2147	2280	2280	2513



ORDERING NOTES:

Inside space for TV units is approximately 23.25" wide x 17.25" high and the DVD space is 23.25" wide x 2.75" high. IT1559, IT2389 have a 20" back and fit to a 20" wide Patient Divider Module. IT1619 and IT2449 have 26" backs.

DIMENSIONS

	Overall Width	Overall Depth	Overall Height	Shipping Weight	Cubes
IN1209	20	19.25	40.25	96	13
IN1269	26	19.25	40.25	114	15
IN2209	20	19.25	40.25	110	13
IN2269	26	19.25	40.25	130	15

REQUIRED TO SPECIFY

1. Model number (above)
2. Front Style (above)
3. Pull Style (page 481)
4. Top Color (page 481)
5. Case Color ((page 481)
6. Options (below)



OPTIONS

	List		List
Base Upgrade to HPL - H	16 (per lineal foot)	Top Upgrade to HPL w/Polymer Edge - P	238
NOTE: to order change "P" to "H" add canulated upcharge		NOTE: to order change "L" to "P"	309
Locking Top Drawer or Door - LK	71 (each)		
Master Key - MK	61		

MODEL CODE KEY

Product Line	Description	Style	Width	Base Style	Orientation (when facing cabinet)	Base Option	Top Option
I	N	1	20	9	N	P	L
Infusion	Nurses Module	3 Drawers		no legs	Non Handed	Plywood (n/c)	Laminate (n/c)
		2	26			H	P
		5 Drawers				HPL	HPL w/Polymer Edge

TRANQUILITY | CONNECTIVITY SOLUTIONS

		List Price
CABLING GROMMET	Cabling grommet	152
	<p>A black cabling grommet with an opening in the cover provides a cable passage for cords. The removable cover serves to provide a large cable passage when required.</p> <p>Cabling grommets can be combined with powerbars to provide cable management as well as connections for electrical/voice/data.</p> <p>Black Rectangular grommet 4 1/8" x 2 11/16"</p> <p>Cabling grommets can be located on the top and sides for the Combined Patient Entertainment/ Nurses' Module.</p> <p>For other nurses' modules the location is top center/back.</p>	
POWERBAR	Powerbar (Category 5/6 A)	127
	<p>The powerbar comes standard with 3 receptacles, 2 RJ45 ports and a 10' heavy duty power cord.</p> <p>The powerbar is a UL/CSA - approved power/data powerbar, which includes three 115-volt electrical convenience outlets and two data ports - all easily accessed behind the touch latch door of the cable management cavity in the Combined Patient Entertainment/ Nurses' Module.</p>	
	POWERPORT	
	<p>A PowerPort is a unique worksurface mounted module that can be specified to a location that best serves the user's needs. It includes a UL approved electrical, voice and data power bar, containing two 115 - volt electrical simplex outlets which are accessible from the work surface, plus a utility outlet at the end for daisy chaining purposes. 3 data versions are available.</p>	
Power Port, 2-RJ45's, Category 5/6	88POWERPORT1	397
	Port Includes: 2 simplex, 1 utility, 2 RJ45's, category 5/6, horizontal cable management.	
Power Port , RJ11/RJ45	88POWERPORT3	397
	Port Includes: 2 simplex receptacles, 1 utility outlet, 1 RJ11, 1 RJ45, horizontal cable management.	
PowerPort 4	88POWERPORT4	412
	Port Includes: 2 simplex receptacles, 1 utility outlet, 2 USB charging ports, horizontal cable management.	
Port	PORT	
	<p>A service module having no power bar will serve as a large grommet. A hinged lid easily enables the passage of several cables and devices.</p> <p>88PORT</p>	137

CABLE MANAGEMENT

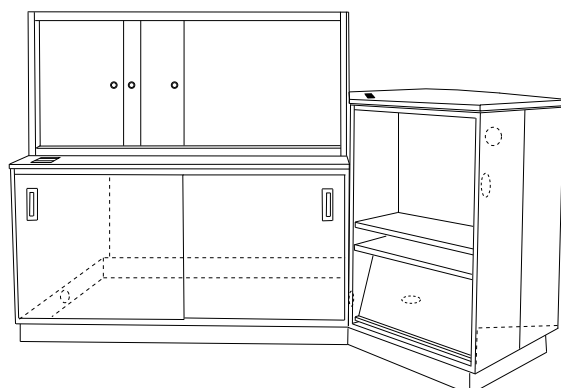

Cables from the top can enter the combined Patient's Entertainment/ Nurse's Module from a grommet located in the top or the side of the unit. The cables run behind the drawers and pass through a cable grommet into the cable management cavity. Electrically and data cables can be plugged in to the powerbar located inside.

Cables from the entertainment portion of this unit also can pass through a cable grommet in the side of the cabinet into the cable management cavity and are connected to the powerbar.

The powerbar cord runs inside of the base to the power source.

The Patient's Entertainment / Nurse's Module has a convenient touch latch door to gain access to the cable management cavity.

The powerbar cord runs inside of the base to the power source.

When using a PowerPort, the cables pass through these same grommets into the divider cabinet. A cable management trough is used to manage cables through the storage unit, with no interference with the items being stored.

575 Juno

599 Trevisa

JUNO & TREVISA | HEADWALLS AND FOOTWALLS

The Juno and Trevisa lines include a custom offering of modular headwalls and footwalls. The offering has been designed around 24", 30" and 36" wide modules that include a back panel, canopy (1 1/2" thick) and cabinets. The overall height is 82". Cabinet height can be 20" (e.g. benches), 30" (e.g. bedsides, dressers and desks) or 36" (e.g. work counters, possibly including a sinks). The cabinets can be taken with slight modification from the Juno and Trevisa offerings of bedside tables, benches, dressers, desks, wardrobes and storage units. As well, other items such as floating shelves can be incorporated. In each case, the cabinet sits on a substantial 4" inset base. Bases are typically in grey laminate. Some combinations of the modules can be freestanding while others need to be fastened to the wall.

Fronts, top profiles and pulls from the Juno and Trevisa line can be incorporated into the headwall or footwall. The tops are only profiled on the front and there is no overhang at the sides. Tops can be laminate, high-pressure laminate, thermoformed vinyl or solid surface.

The modules are designed to accommodate wiring for lighting, TVs and to support other electrical devices such as computers. Similarly, there is space for plumbing.

Advantages of modular footwalls and headwalls may include improved depreciation for tax purposes, the ability to reconfigure at some future point, replaceability of individual components and even individual panels, consistency of design, colors and pulls with freestanding cabinets in the room, and the fact that design and construction meets the same healthcare standards reflected in the balance of the Juno and Trevisa lines. A limited lifetime warranty applies.

Please contact your Krug representative or customer service for a quotation on your specific project. The following are sample project configurations and associated list prices.

Headwalls

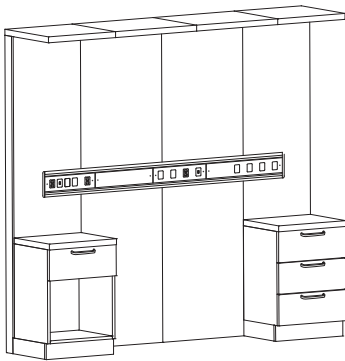

Total List \$8178

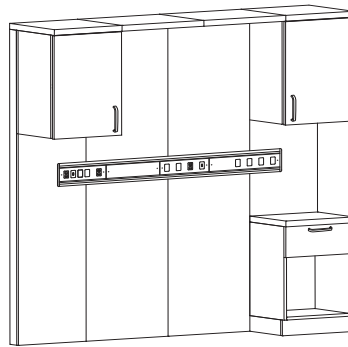

Total List \$8298

Footwalls

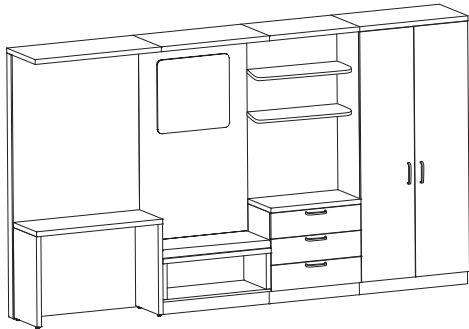

Total List \$11,562

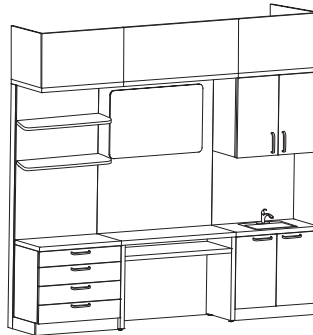

Total List \$10,883

Consultation Station

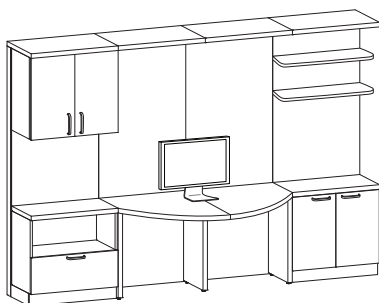

Total List \$11,096

Quiet Area

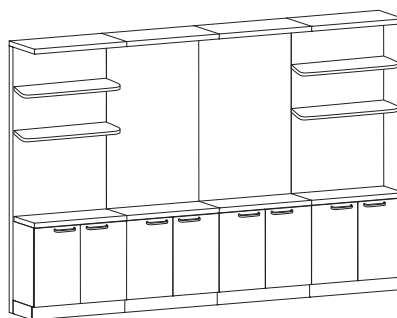

Total List \$11,254



MATERIAL CONTENT:

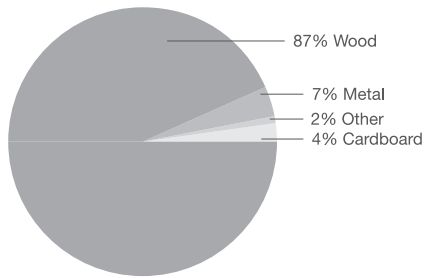

PRE-CONSUMER

RECYCLED CONTENT = 88%

POST-CONSUMER

RECYCLE CONTENT = 5%

CONTRIBUTES TO

CREDIT 2.1 - 2.2	Construction Waste Management	1-2 point(s)
CREDIT 3.3	Resource Reuse	1 point
CREDIT 4.1	Recycled Content	1 point
CREDIT 4.2	Recycled Content	1 point
CREDIT 4.4	Low Emitting Materials	1 point
	Composite Wood & Laminate Adhesives	1 point
CREDIT 5.1	Regional Materials*	1 point
CREDIT 7	Certified Wood (PLEASE ENQUIRE)	1 point

* This credit is only applicable if in total 20% of the combined value of the procured construction materials and furniture is manufactured within a radius of 500 miles. This credit will apply if the installation of the finished product occurs within 500 miles of Toronto, Ontario.

JUNO | FEATURES & OPTIONS

BREADTH OF LINE:

The healthcare casegoods lines offer solutions from contemporary to transitional to traditional styling. Juno is the contemporary version. The lines are extremely wide including 5 bedside table configurations, 3 dressers, 2 benches, 2 combination bench/wardrobes, 8 wardrobe/storage units, 4 TV units, 3 bookcases, 2 desks, a headboard and footboard, a marker board, mirror and corkboard, and 4 overbed tables. In addition custom modular headwalls and footwalls are offered.



CUSTOM CAPABILITY:

Krug can offer both custom sizes of standard product and completely custom units, including modular headwalls and footwalls.

For more information, please contact Customer Service.



DURABILITY:

Cabinets are constructed of 3/4" thick panels including backs. In contrast to cabinets constructed with 1/8" back panels, the Juno units are more robust and less susceptible to damage. All exposed laminate edges are covered with 2.5 mm polymer edge banding in colors matching the laminates. This thicker edge banding provides an increased level of durability on all edges as well as a 2.5 mm radius on the edge. The softer radius is less likely to bruise or cut the skin of a patient or caregiver. Bottom panels extend under the side and back panels of cabinets with legs and on any units with 4 casters in order to maximize the ability of the cabinet to withstand heavy handling.



DRY FIT CONSTRUCTION:

Cabinets are assembled with mechanical cams. This is known as dry fit construction. The result is that any panel can be replaced if damaged, unlike in the case of cabinets that are glued together where damage to any surface leads to replacement of the entire unit.

VENTS:

There is one 1" diameter vent for each drawer and each door set for air circulation. All vent holes are covered with plastic vents both inside and outside to eliminate exposed particle board, thus preventing moisture and bacteria from entering the core.



SEALED CORE

All unseen particle board edges that are not covered by an adjoining panel are edge banded (i.e. no exposed particle board). As with the vent covers noted above, this prevents moisture and bacteria from seeping into the core.

DRAWERS:

Drawers have white metal sides with white laminate bottoms and backs, and all exposed particle board edges are edge banded.

The unobstructed metal sides facilitate cleaning. Bumpers are installed on all drawers and doors to soften the sound of closing.

ENVIRONMENTAL

Juno cabinets have a very high recycled content and contribute to both LEED credits 4.1 and 4.2. The packaging is recyclable. Non-urea-added core is available as an option and Air Emissions certified product is also optionally available. FSC-certified wood may be possible on larger projects



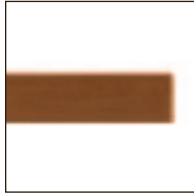

TOPS:

Tops are 3/4" thick and can be laminate with polymer edge banding, high-pressure laminate with polymer edge banding, or seamless thermoformed vinyl.

- Edge A - Laminate with Polymer Edge, or High-Pressure Laminate with Polymer Edge
- Edge B - Thermoformed Vinyl or High-Pressure Laminate with Wood Edge
- Edge C - Thermoformed Vinyl or High-Pressure Laminate with Wood Edge
- Edge S - Laminate with T-Mold bumper or High-Pressure Laminate with T-Mold bumper

With Edge S the Overhang is 1/2" on all sides

Standard Top Overhang is 1/4" on 4 sides

Optional Top Overhang is 1/2" on 4 sides (to assist with movement of the cabinet) on other edges.

Tops on units over 40" high are laminate only

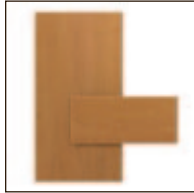

DOOR / DRAWER FRONTS:

Door / drawer fronts are 3/4" thick and 2 styles are available.

- Delphine - Laminate with Polymer Edge
- Lia - Thermoformed Vinyl

Headboards and footboards are high-pressure laminate on 3/4" plywood with polymer edge banding. HPL and plywood are used in this application for added strength.



LEGS & BASE RAIL:

Cabinets are available with 4 1/4" legs (for ease of cleaning), or sides to the floor with a base-plate Style 1 that is either Laminate with Polymer Edge, or Seamless Thermoformed Vinyl, (based on the Door/Drawer front material selected).



DOOR AND DRAWER PULL STYLES:

Flex is an injection-molded plastic pull designed to offer some "give" or flexibility when inadvertently hit by a patient or caregiver. The color is similar to Silver Metallic.

The Circa offers a very large grip. The pull could be accessed with a closed knuckle. It has a Silver Metallic finish.

The Indus pull eliminates a protrusion that could bruise a patient or caregiver. The finish is Silver Metallic.



BENCH

The cushion for the bench is 3" thick.

Juno benches have a load weight rating of 200 lbs.



OVERBED TABLES:

There are 4 overbed table top shapes in either high-pressure laminate or seamless thermoformed vinyl, with 3 edge profiles (2 are spill-guard edges). There is also a version with a second drop-down surface. The overbed table offering includes 2 alternative steel base styles, each available in 5 standard powdercoat finishes. The overall height of the U-base including casters is less than 2" and the H-base is 3.25".

Baskets are a frequently ordered option. They are commonly used to hold urinals to keep them off table surfaces.

LAMINATES:

"Laminate" is variously known in the marketplace as Thermofused Melamine, Low-Pressure Laminate or LPL.

There are 1 solid color options and 5 wood-grain colors. All colors are available in laminate, high-pressure laminate or thermoformed vinyl. Polymer Edge banding matches the laminate selection. Wood finishes to match the wood-grain laminates are available for Krug Healthcare Seating.

VENEER

Many items in the Juno product line are also available in maple veneer and in a combination of veneer exterior surfaces and laminate interior faces. The veneered version is available with the Delphine front and "A" top edge profile. Both high-pressure laminate and thermoformed vinyl tops can be supplied as options with the veneered cabinets. Please contact your Krug representative or customer service for a quotation on veneered product.

WARRANTY

All cabinets carry a limited lifetime warranty. Overbed tables have a 2-year warranty.

JUNO | OPTIONS

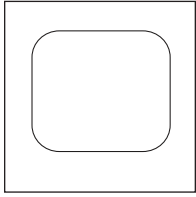

ROUNDED TOPS

A top with rounded corners is available as an option on bedside tables. There is a choice of laminate or high pressure laminate. The edge is polymer to match the laminate color. The overhang is 3/4" on all 4 sides of the top. (Tops specified with T-mold bumper are also rounded at corners. In these cases the overhang is 1/2" on all sides).

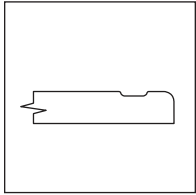

SPILL-GUARD EDGE

Juno bedside tables are available with the spill-guard edge surface on the thermoformed vinyl tops to collect liquids when spills occur.

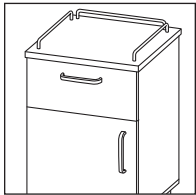

GALLERY RAILS

Optional gallery rails are in satin nickel finish. There is a rail on each side and another across the back.



LOCKING TOP DRAWER OR DOOR

Juno cabinets have the option to lock. They can be randomly keyed for security. The lock option is factory installed and must be specified on the order.

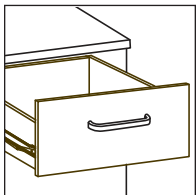

LAMINATE DRAWER

An optional white laminate drawer with a single-action 3/4-extension slide is available at no upcharge. All edges are banded.

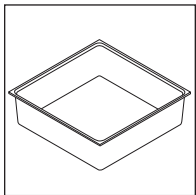

SEAMLESS DRAWER LINER

Juno bedside tables are available with the option of a plastic drawer liner. Ideal for infection control purposes, it can be removed, sterilized or replaced when damaged or degraded.

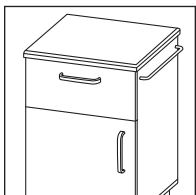

TOWEL BAR

The Towel Bar option fastens to the sides of the bedside tables. It is available in a satin nickel finish. The standard placement is the side opposite the hinge.

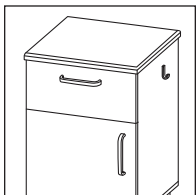

LITTER BAG HOLDER

The Litter Bag Holder option fastens to the sides of the bedside tables. It is available in a satin nickel finish. It holds small paper bags and can be field-installed. The standard placement is the side opposite the hinge.

MASTER KEY

Juno bedside tables have the option to lock with a master key. This must be specified on the order.

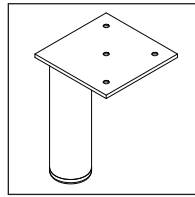

LEG / CASTERS:

Juno Bedside Tables have 5 base options - 4 legs with glides, 2 front legs with glides and 2 back casters, 4 swivel casters (2 locking), no legs and adjustable glides, or no legs and 2 hidden non-swivel casters at the rear of the cabinet.

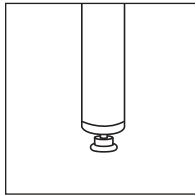
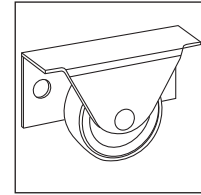
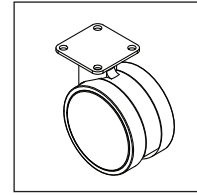
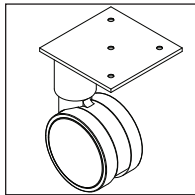

LEG LEVELER

An adjustable glide option is available for legs when there are 4 legs on a cabinet. This is standard on units without legs. This helps ensure the furniture is steady and level on uneven floors.

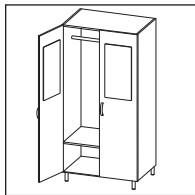

CABINET MOUNT MARKERBOARD

The Markerboards are 24" high by 12" wide. They can be mounted to the inside or outside of the cabinet door (inside is standard).

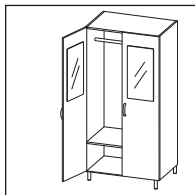

CABINET MOUNT MIRROR OPTION

The Mirrors are 24" high by 12" wide and acrylic. They can be mounted to the inside or outside of the cabinet door (inside is standard).

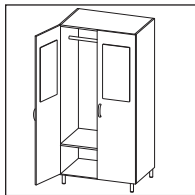

CABINET MOUNT CORKBOARD OPTION

The Corkboards are 24" high by 12" wide. They can be mounted to the inside or outside of the cabinet door (inside is standard).

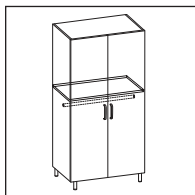

LOWER MOUNTING COAT ROD AND SHELF (ADA)

Juno Wardrobes are available with the lower shelf and coat rod for ADA compliance (shelf is 48" above the floor).

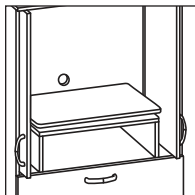

PULL-OUT SWIVEL TV TRAY

Juno TV Units come with the option of a pull-out swivel TV Tray. The swivel tray is factory installed and must be specified at the time of order.

EXTENDED TOP OVERHANG

Rather than the standard 1/4" top overhang on all sides, this can be at 1/2" to facilitate moving of the cabinet for cleaning.

REQUIRED TO SPECIFY

After each product grouping in the following pages, there is a summary under the title “Required to Specify”. The summary lists the elements that need to be specified including Model Number, Top & Edge Profile, Pull Style and Color, Body Style and Color,

TOP EDGE PROFILES:

Select one:



Edge Profile A



Edge Profile B



Edge Profile C



Edge Profile S
(only offered on bedside tables)

ORDERING NOTES:

Edge Profile A is available in Laminate with Polymer Edge, or High-Pressure Laminate with Polymer Edge.

Edge Profiles B & C are available with the Seamless Thermoformed Vinyl.

Spill-Guard Edge can be ordered on Edge Profiles B & C in Seamless Thermoformed Vinyl.

Edge Profile S is available in Laminate with T-Mold bumper or High-Pressure Laminate with T-Mold bumper.

DOOR AND DRAWER PULL STYLES:



Flex - F



Circa - C



Indus - I

Select one:

No upcharge
Color is similar to
Silver Metallic

\$6 each
Silver Metallic

\$11 each
Silver Metallic

ORDERING NOTES: Silver Metallic Finish matches Juno legs and stanchions.

BASE RAIL:

Select one:



Style 1

ORDERING NOTES: Style 1 is the Juno standard in cases where leg option is not chosen, but it must still be selected to ensure clarity.

LAMINATE:

Select one:



Champagne



Hardrock Maple



Dune



Gingerbread



Portobello



Park Avenue Walnut



Chocolate



Dark Walnut



Ash

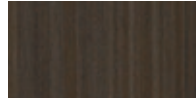

Willow



Nutmeg



Copper



Shiraz Cherry

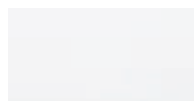

Designer White



Platinum



Earth



Charcoal

JUNO | SPECIFYING

VINYL COLORS: (For Overbed Table vinyl selection see page 517)

Select one:



VENEER COLORS:

Select one:



SOLID SURFACE: Please contact customer service for a quote. See [page 551](#) for color options.

T-MOLD BUMPER COLORS:

Select one: Beige - B Charcoal Grey - C

BASE COLORS FOR OVERBED TABLES:

Select one: S - Silver Metallic G - Graphite B- Black A - Almond N - Nevada

ORDERING NOTES:

A typical selection and the ideal way to enter on your purchase order would be as follows:





REQUIRED TO SPECIFY	SPECIFIED	LIST	
1. Model number (above)	JB1201R	\$974	Bedside Table with 1 drawer/1 door and Lia fronts Right handed
2. Top Material/Top Edge Profile (below)	- B	\$78	Edge Profiles B
3. Front Style (above)	- L	as listed	Seamless Thermoformed Vinyl
4. Pull Style (Page 7)	- F	n/c	Lia
5. Base Rail -TB models note "Style 1"	Top Color (select color)	n/c	Flex
6. Top Color (Page 7 note color selection)	Body Color (select color)	n/c	
7. Case Color (Page 7 note color selection)			
8. T-mold bumper - Edge Profile S note color selection			
9. Options (below)	Options:		
	Locking Top Drawer - LK	\$48	
	Seamless Drawer Liner - SL	\$51	
	Final - JB1201 R B L F LK SL -	\$1151	

JUNO | BEDSIDE TABLES

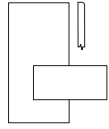
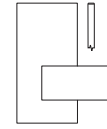
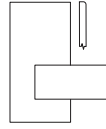
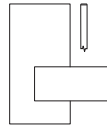
FRONT STYLES

Delphine front is laminate. Lia is thermoformed vinyl.



Description/Model	Delphine - D	Lia - L	Description/Model	Delphine - D	Lia - L		
 1 Drawer, 1 Door	JB1201L* R	846	974	 1 Drawer, 1 Door	TB1209L* R	794	921
	JB1202L R	894	1019		TB1203L R	845	973
 1 Drawer, 1 Fixed Shelf	JB2201N*	740	869	 1 Drawer, 1 Fixed Shelf	TB2209N*	691	816
	JB2202N	786	915		TB2203N	740	868
					TB2204N	777	901

* Indicates model illustrated by line drawing.

DIMENSIONS

	Overall Width	Overall Depth	Overall Height	Shipping Weight	Cubes
1201	19.75	19.75	30	77	8
2201	19.75	19.75	30	74	8

REQUIRED TO SPECIFY

1. Model number (above)
2. Top Material/Top Edge Profile (right)
3. Front Style (above)
4. Pull Style (page 500)
5. Base Rail - TB models note "Style 1"
6. Top Color (page 500 note color selection)
7. Case Color (page 500 note color selection)
8. T-mold bumper - Edge Profile S note color selection
9. Options (below)

TOP MATERIALS: (Page 7)

	LIST
Laminate W/ Polymer Edge - L (with Edge Profile A)	N/C
HP Laminate W/ Polymer Edge - P (with Edge Profile A)	35
Seamless Thermoformed Vinyl - B or C (with Edge Profiles B or C)	78
Laminate Bumper - X (with Edge Profile S)	48
HP Laminate Bumper - Y (with Edge Profile S)	82

JUNO BEDSIDE TABLE OPTIONS

	LIST
Spill Guard Edge - SG	51
NOTE: Available on Seamless Thermoformed Vinyl only.	
Locking Top Drawer or Door - LK	48
Gallery Rails - GR	199
Leg Leveler (per unit, 4 Legs) - LL	14
Litter Bag Holder - BH	14
Seamless Drawer Liner - SL	51

	LIST
Towel Bar - TB	51
Master Key - MK	40
Laminate Drawer - DR	N/C
Rounded Top - RT	N/C
NOTE: Available with Top Materials Laminate or HPL and Top Edge Profile "A".	
Extended Top Overhang - EX	N/C

MODEL CODE KEY





Product Line	Description	Style	Width	Base Style	Orientation (hinge side when facing cabinet)
J	B	1	20	1	L
Units with Legs	Bedside Table	1 Drawer, 1 Door		4 legs	Hinged Left
T		2		2	R
Units without Legs		1 Drawer, 1 Fixed Shelf		2 legs/2 casters	Hinged Right
				3	N
				2 casters	Not Applicable
				4	
				4 casters	
				9	
				no legs or casters	

JUNO | BEDSIDE TABLES

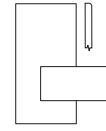
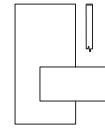
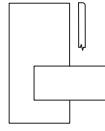
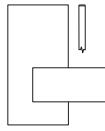
FRONT STYLES

Delphine front is laminate. Lia is thermoformed vinyl.



Description/Model	Delphine - D	Lia - L	Description/Model	Delphine - D	Lia - L
1 Drawer	JB3201N* 716	820	1 Drawer	TB3209N* 665	768
	JB3202N 765	868		TB3203N 715	820
				TB3204N 751	853
3 Drawers	JB4201N* 1120	1246	3 Drawers	TB4209N* 1066	1194
	JB4202N 1168	1294		TB4203N 1118	1245
				TB4204N 1153	1281

* Indicates model illustrated by line drawing.

DIMENSIONS

	Overall Width	Overall Depth	Overall Height	Shipping Weight	Cubes
3201	19.75	19.75	24	62	6
4201	19.75	19.75	30	92	8

REQUIRED TO SPECIFY

1. Model number (above)
2. Top Material/Top Edge Profile (right)
3. Front Style (above)
4. Pull Style (page 500)
5. Base Rail -TB models note "Style 1"
6. Top Color (page 500 note color selection)
7. Case Color (page 500 note color selection)
8. T-mold bumper - Edge Profile S note color selection
9. Options (below)

TOP MATERIALS: (Page 7)

LIST

Laminate W/ Polymer Edge	- L (with Edge Profile A)	N/C
HP Laminate W/ Polymer Edge	- P (with Edge Profile A)	35
Seamless Thermoformed Vinyl	- B or C (with Edge Profiles B or C)	78
Laminate Bumper	- X (with Edge Profile S)	48
HP Laminate Bumper	- Y (with Edge Profile S)	82

JUNO BEDSIDE TABLE OPTIONS

LIST

LIST

Spill Guard Edge - SG	51	Towel Bar - TB	51
NOTE: Available on Seamless Thermoformed Vinyl only.		Master Key - MK	40
Locking Top Drawer or Door - LK	48	Laminate Drawer - DR	N/C
Gallery Rails - GR	199	Rounded Top - RT	N/C
Leg Leveler (per unit, 4 Legs) - LL	14	NOTE: Available with Top Materials Laminate or HPL and Top Edge Profile "A".	
Litter Bag Holder - BH	14	Extended Top Overhang - EX	N/C
Seamless Drawer Liner - SL	51		



MODEL CODE KEY

Product Line	Description	Style	Width	Base Style	Orientation (hinge side when facing cabinet)
J	B	3	20	1	L
Units with Legs	Bedside Table	1 Drawer		4 legs	Hinged Left
T		4		2	R
Units without Legs		3 Drawers		2 legs/2 casters	Hinged Right
				3	N
				2 casters	Not Applicable
				4	
				4 casters	
				9	
				no legs or casters	

FRONT STYLES

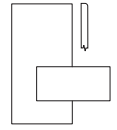
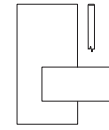
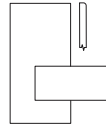
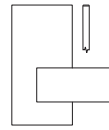
Delphine front is laminate. Lia is thermoformed vinyl.



Description/Model	Delphine - D	Lia - L	Description/Model	Delphine - D	Lia - L	
	1 Drawer, 1 Door JB5201L* R	1131	1282	1 Drawer, 1 Door TB5209L* R	1082	1230
	JB5202L R	1178	1330	TB5203L R	1131	1282
				TB5204L R	1166	1315
	1 Drawer, 1 Door JB6201L* R	1118	1268	1 Drawer, 1 Door TB6209L* R	1066	1218
	JB6202L R	1166	1315	TB6203L R	1118	1268
				TB6204L R	1153	1304

DIMENSIONS

	Overall Width	Overall Depth	Overall Height	Shipping Weight	Cubes
5201	19.75	19.75	35	77	8
6201	19.75	19.75	35	74	8

REQUIRED TO SPECIFY

1. Model number (above)
2. Top Material/Top Edge Profile (right)
3. Front Style (above)
4. Pull Style (page 500)
5. Base Rail -TB models note "Style 1"
6. Top Color (page 500 note color selection)
7. Case Color (page 500 note color selection)
8. T-mold bumper - Edge Profile S note color selection
9. Options (below)

TOP MATERIALS: (Page 7)

	LIST
Laminate W/ Polymer Edge - L (with Edge Profile A)	N/C
HP Laminate W/ Polymer Edge - P (with Edge Profile A)	35
Seamless Thermoformed Vinyl - B or C (with Edge Profiles B or C)	78
Laminate Bumper - X (with Edge Profile S)	48
HP Laminate Bumper - Y (with Edge Profile S)	82

JUNO BEDSIDE TABLE OPTIONS

	LIST		LIST
Spill Guard Edge - SG	51	Towel Bar - TB	51
NOTE: Available on Seamless Thermoformed Vinyl only.		Master Key - MK	40
Locking Top Drawer or Door - LK	48	Laminate Drawer - DR	N/C
Gallery Rails - GR	199	Rounded Top - RT	N/C
Leg Leveler (per unit, 4 Legs) - LL	14	NOTE: Available with Top Materials Laminate or HPL and Top Edge Profile "A".	
Litter Bag Holder - BH	14	Extended Top Overhang - EX	N/C
Seamless Drawer Liner - SL	51		

MODEL CODE KEY





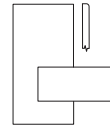
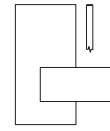
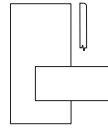
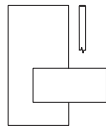

Product Line	Description	Style	Width	Base Style	Orientation (hinge side when facing cabinet)
J	B	5	20	1	L
Units with Legs	Bedside Table	1 Drawer, 1 Door		4 legs	Hinged Left
T		6		2	R
Units without Legs		1 Drawer, 1 Door		2 legs/ 2 casters	Hinged Right
				3	N
				2 casters	Not Applicable
				4	
				4 casters	
				9	
				no legs or casters	

JUNO | DRESSERS

FRONT STYLES

Delphine front is laminate. Lia is thermoformed vinyl.



Description/Model	Delphine - D	Lia - L	Delphine - D	Lia - L
3 Drawer 	JD1321N 1239	1440	3 Drawer TD1329N 	1187 1389
4 Drawer 	JD2321N 1565	1822	4 Drawer TD2329N 	1513 1772
6 Drawer 	JD3606N 2241	2620	6 Drawer TD3609N 	2165 2542

DIMENSIONS

	Overall Width	Overall Depth	Overall Height	Shipping Weight	Cubes
1321N	31.75	19.75	30	130	12
2321N	31.75	19.75	38.6	161	15
3601N	59.75	19.75	30	246	23

REQUIRED TO SPECIFY

1. Model number (above)
2. Top Material/Top Edge Profile (right)
3. Front Style (above)
4. Pull Style (page 500)
5. Base Rail -TB models note "Style 1"
6. Top Color (page 500 note color selection)
7. Case Color (page 500 note color selection)
8. Options (below)

TOP MATERIALS: (Page 7)

	LIST
Laminate W/ Polymer Edge - L (with Edge Profile A)	N/C
3 or 4 drawer	
HP Laminate W/ Polymer Edge - P (with Edge Profile A)	58
Seamless Thermoformed Vinyl - B or C (with Edge Profiles B or C)	123
6 drawer	
HP Laminate W/ Polymer Edge - P (with Edge Profile A)	103
Seamless Thermoformed Vinyl - B or C (with Edge Profiles B or C)	232

JUNO DRESSER OPTIONS

	LIST	LIST
Locking Top Drawer or Door - LK	48	Master Key - MK 40
Leg Leveler (per unit, 4 Legs) - LL	14	Laminate Drawer - DR N/C
Leg Leveler (per unit, 6 Legs) - LL	18	Extended Top Overhang - EX N/C

MODEL CODE KEY

Product Line	Description	Style	Width	Base Style	Orientation (hinge side when facing cabinet)
J	D	1	32	1	N
Units with Legs	Dresser	3 Drawer		4 legs	Not Applicable
T		2	60	6	
Units without Legs		4 Drawers		6 legs	
		3		9	
		6 Drawers		no legs or casters	

FRONT STYLES

Delphine front is laminate. Lia is thermoformed vinyl.



Description/Model		Delphine - D	Lia - L		Delphine - D	Lia - L	
Open Bench	JC1301N	968	N/A	Open Bench	TC1309N	915	N/A
	JC1361N	1142	N/A		TC1369N	1092	N/A
Bench with 2 Drawers	JC2301N	1271	1386	Bench with 2 Drawers	TC2309N	1220	1333
	JC2361N	1429	1565			1376	1513

DIMENSIONS

	Overall Width	Overall Depth	Overall Height	Shipping Weight	Cubes
1301	29.25	19.75	23	60	8
1361	35.25	19.75	23	68	9
2301	29.25	19.75	23	88	8
2361	35.25	19.75	23	102	9

REQUIRED TO SPECIFY

1. Model number (above)
2. Front Style (above)
3. Pull Style (page 500)
4. Base Rail -TB models note "Style 1"
5. Case Color (page 500 note color selection)
6. Fabric Selection
7. Options (below)

JUNO BENCH OPTIONS

LIST

Locking Top Drawer or Door - LK	48
Leg Leveler (per unit, 4 Legs) - LL	14
Master Key - MK	40
Laminate Drawer - DR	N/C
Moisture Barrier	85

Cushions are priced in COM/Grade 1

Fabric Grades upcharge	2	(COL) 3	4	5	6	7	Leather 8	9
	33	64	127	190	255	318	381	477

COM yardage is 1 yard for both 30" and 36" cushions. Juno and Trevisa benches have a load weight rating of 200lbs.

MODEL CODE KEY

Product Line	Description	Style	Width	Base Style	Orientation (hinge side when facing cabinet)
J	C	1	30	1	N
Units with Legs	Cushioned Bench	Open Bench		4 legs	Not Applicable
T		2	36	9	
Units without Legs		Bench with 2 Drawers		no legs or casters	

JUNO | BENCHES & WARDROBE COMBINATION

FRONT STYLES

Delphine front is laminate. Lia is thermoformed vinyl.

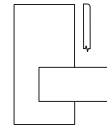
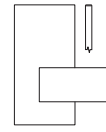
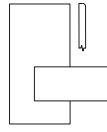
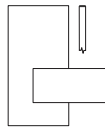

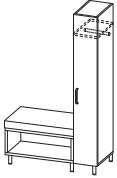
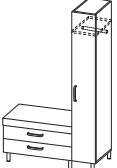
Description/Model	Delphine - D		Lia -L		Delphine - D		Lia - L	
 Open Bench with Half Wardrobe	JC3426L	2471	2639		TC3429L	2369	2535	
	R*				R*			
	JC3486L	2646	2817		TC3489L	2543	2713	
			R				R	
 Bench with 2 Drawers & Half Wardrobe	JC4426L	2774	3057		TC4429L	2671	2954	
	R*				R*			
	JC4486L	2932	3238		TC4489L	2828	3134	
	R				R			

* Indicates model illustrated by line drawing.

DIMENSIONS

	Overall Width	Overall Depth	Overall Height of Bench	Overall Height of Wardrobe	Shipping Weight	Cubes
3426	41.25	19.75	23	70	167	19
3486	47.25	19.75	23	70	175	20
4426	41.25	19.75	23	70	195	19
4486	47.25	19.75	23	70	209	20

ORDERING NOTES These units ship as two separate pieces. Cushions are priced in COM/Grade 1

REQUIRED TO SPECIFY

1. Model number (above)
2. Front Style (above)
3. Pull Style (page 500)
4. Base Rail -TB models note "Style 1"
5. Case Color (page 500 note color selection)
6. Fabric Selection
7. Options (below)

JUNO BENCH/WARDROBE OPTIONS	LIST	LIST
Locking Top Drawer or Door - LK	48	Laminate Drawer - DR
Cabinet Mount Corkboard -TB	245	Lower Mounting Coat Rod and Shelf - AD
Leg Leveler (per unit) - LL	18	Extended Top Overhang - EX
Cabinet Mount Markerboard - MB	155	Master Key - MK
Cabinet Mount Mirror - AM	245	Moisture Barrier

Cushions are priced in COM/Grade 1

Fabric Grades upcharge	(COL)			Leather				
	2	3	4	5	6	7	8	9
	33	64	127	190	255	318	381	477

COM yardage is 1 yard for both 30" and 36" cushions. Juno and Trevisa benches have a load weight rating of 200lbs.

MODEL CODE KEY

Product Line	Description	Style	Width	Base Style	Orientation (hinge side when facing cabinet)
J	C	3	42	6	L
Units with Legs	Cushioned Bench	Open Bench		6 legs	Hinged Left
T		4	48	9	R
Units without Legs		Bench with 2 Drawers		no legs or casters	Hinged Right

FRONT STYLES

Delphine front is laminate. Lia is thermoformed vinyl.

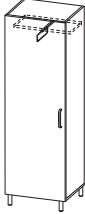

Description/Model	Delphine - D	Lia - L	Delphine - D	Lia - L
Half Wardrobe w/ Coat Rod 	JW1121L R* 1504	1671	Half Wardrobe w/ Coat Rod TW1129L R* 1453	1620
ORDERING NOTE: 1121L/R units must either be fastened to the wall or fastened to another case for support to prevent tipping.		ORDERING NOTE: 1121L/R units must either be fastened to the wall or fastened to another case for support to prevent tipping.		
Single Door Wardrobe w/ Coat Rod 	JW2241L* R 1832	2166	Single Door Wardrobe w/ Coat Rod TW2249L* R 1778	2113
* Indicates model illustrated by line drawing.				

DIMENSIONS

	Overall Width	Overall Depth	Overall Height	Shipping Weight	Cubes
JW1121	12	19.75	70	107	11
JW2241	23.25	19.75	70	164	21

The dimensions above apply to codes starting with "T" as well.

REQUIRED TO SPECIFY

1. **Model number** (above)
2. **Front Style** (above)
3. **Pull Style** (page 500)
4. **Base Rail** -TB models note "Style 1"
5. **Case Color** (page 500 note color selection)
6. **Options** (below)

JUNO WARDROBE OPTIONS

	LIST		LIST
Locking Top Drawer or Door - LK	48	Cabinet Mount Mirror - AM	245
Cabinet Mount Corkboard -TB	245	Laminate Drawer - DR	N/C
Leg Leveler (per unit) - LL	14	Lower Mounting Coat Rod and Shelf - AD	N/C
Cabinet Mount Markerboard - MB	155	Master Key - MK	40

MODEL CODE KEY

Product Line	Description	Style	Width	Base Style	Orientation (hinge side when facing cabinet)
J	W	1	12	1	L
Units with Legs	Wardrobe	Half Wardrobe		4 legs	Hinged Left
T		2	24	9	R
Units without Legs		Single Door Wardrobe		no legs or casters	Hinged Right

JUNO | WARDROBES

FRONT STYLES

Delphine front is laminate. Lia is thermoformed vinyl.

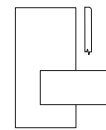
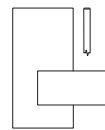
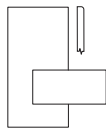
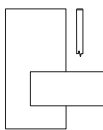

Description/Model	Delphine - D	Lia - L	Delphine - D	Lia - L
Single Door Storage w/ 4 Fixed Shelves JW3241L* R	1801	2134	Single Door Storage w/ 4 Fixed Shelves TW3249L* R	1747 2084
2 Door Wardrobe JW4361N	2174	2680	2 Door Wardrobe TW4369N	2124 2629

* Indicates model illustrated by line drawing.

DIMENSIONS

	Overall Width	Overall Depth	Overall Height	Shipping Weight	Cubes
JW3241	23.25	19.75	70	185	21
JW4361	35.25	23.25	70	243	37

The dimensions above apply to codes starting with "T" as well.

REQUIRED TO SPECIFY

1. **Model number** (above)
2. **Front Style** (above)
3. **Pull Style** (page 500)
4. **Base Rail** -TB models note "Style 1"
5. **Case Color** (page 500 note color selection)
6. **Options** (below)

JUNO WARDROBE OPTIONS

LIST

Locking Top Drawer or Door - LK	48
Cabinet Mount Corkboard -TB	245
Leg Leveler (per unit) - LL	14
Cabinet Mount Markerboard - MB	155

LIST

Cabinet Mount Mirror - AM	245
Laminate Drawer - DR	N/C
Lower Mounting Coat Rod and Shelf - AD	N/C
Master Key - MK	40

MODEL CODE KEY

Product Line	Description	Style	Width	Base Style	Orientation (hinge side when facing cabinet)
J	W	3	32	1	L
Units with Legs	Wardrobe	Single Door		4 legs	Hinged Left
T		4	36	9	R
Units without Legs		2 Door Wardrobe		no legs or casters	Hinged Right

FRONT STYLES

Delphine front is laminate. Lia is thermoformed vinyl.

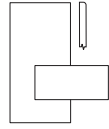
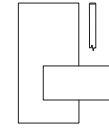
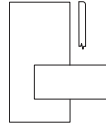
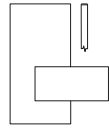

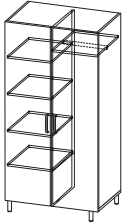
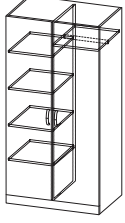
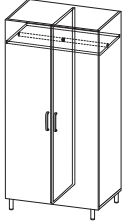
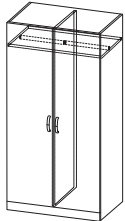
Description/Model		Delphine - D	Lia - L		Delphine - D	Lia - L
2 Door Wardrobe w/ Storage & 4 Fixed Shelves	JW5361L R*	2492	2983	2 Door Wardrobe w/ Storage & 4 Fixed Shelves	TW5369L R*	2427 2932
						
2 Door Wardrobe w/ Partition	JW6361N	2483	2987	2 Door Wardrobe w/ Partition	TW6369N	2431 2934
						

* Indicates model illustrated by line drawing.

DIMENSIONS

	Overall Width	Overall Depth	Overall Height	Shipping Weight	Cubes
JW5361	35.25	23.25	70	292	37
JW6361	35.25	23.25	70	272	37

The dimensions above apply to codes starting with "T" as well.

REQUIRED TO SPECIFY

1. **Model number** (above)
2. **Front Style** (above)
3. **Pull Style** (page 500)
4. **Base Rail** -TB models note "Style 1"
5. **Case Color** (page 500 note color selection)
6. **Options** (below)

JUNO WARDROBE OPTIONS

	LIST		LIST
Locking Top Drawer or Door - LK	48	Cabinet Mount Mirror - AM	245
Cabinet Mount Corkboard -TB	245	Laminate Drawer - DR	N/C
Leg Leveler (per unit) - LL	14	Lower Mounting Coat Rod and Shelf - AD	N/C
Cabinet Mount Markerboard - MB	155	Master Key - MK	40

MODEL CODE KEY



Product Line	Description	Style	Width	Base Style	Orientation (hinge side when facing cabinet)
J	W	5	36	1	L
Units with Legs	Wardrobe	4 Fixed Shelves		4 legs	Hinged Left
T		6		9	R
Units without Legs		Wardrobe w/ Partition		no legs or casters	Hinged Right

JUNO | WARDROBES

FRONT STYLES

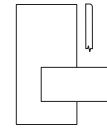
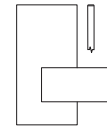
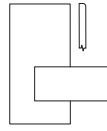
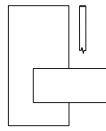
Delphine front is laminate. Lia is thermoformed vinyl.

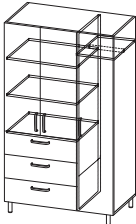
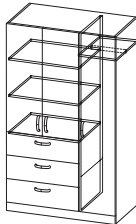

Description/Model	Delphine - D	Lia - L	Delphine - D	Lia - L	
Storage w/ 3 Drawers, & 2 Doors w/ 2 Fixed Shelves 	JW7321N 2312	2815	Storage w/ 3 Drawers, & 2 Doors w/ 2 Fixed Shelves 	TW7329N 2257	2764
Wardrobe w/ Coat Rod & Storage w/ 3 Drawers & 2 Doors w/ 2 Fixed Shelves 	JW8421L R* 3207	3793	Wardrobe w/ Coat Rod & Storage w/ 3 Drawers & 2 Doors w/ 2 Fixed Shelves 	TW8429L R* 3158	3742

* Indicates model illustrated by line drawing.

DIMENSIONS

	Overall Width	Overall Depth	Overall Height	Shipping Weight	Cubes
JW7321	31.25	19.75	70	252	27
JW8421	41.25	23.25	70	358	43

The dimensions above apply to codes starting with "T" as well.

REQUIRED TO SPECIFY

1. Model number (above)
2. Front Style (above)
3. Pull Style (page 500)
4. Base Rail -TB models note "Style 1"
5. Case Color (page 500 note color selection)
6. Options (below)

JUNO WARDROBE OPTIONS

LIST

Locking Top Drawer or Door - LK	48
Cabinet Mount Corkboard -TB	245
Leg Leveler (per unit) - LL	14
Cabinet Mount Markerboard - MB	155

LIST

Cabinet Mount Mirror - AM	245
Laminate Drawer - DR	N/C
Lower Mounting Coat Rod and Shelf - AD	N/C
Master Key - MK	40

MODEL CODE KEY

Product Line	Description	Style	Width	Base Style	Orientation (hinge side when facing cabinet)
J	W	7	32	1	L
Units with Legs	Wardrobe	3 Drawers & 2 Doors		4 legs	Hinged Left
T		8	42	9	R
Units without Legs		Wardrobe & 3 Drawers & 2 Doors		no legs or casters	Hinged Right

FRONT STYLES

Delphine front is laminate. Lia is thermoformed vinyl.

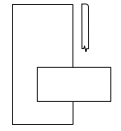
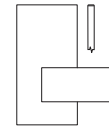
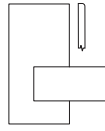
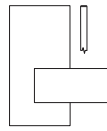

Description/Model	Delphine - D	Lia - L	Delphine - D	Lia - L		
TV Unit w/ 3 Drawers	JE1321N	2632	3078	TE1329N	2580	3028
TV Unit w/ 2 Doors and Shelf	JE2321N	2362	2810	TE2329N	2312	2761

* Indicates model illustrated by line drawing.

DIMENSIONS

	Overall Width	Overall Depth	Overall Height	Shipping Weight	Cubes
JE1321N	31.25	19.75	70	232	28
JE2321N	31.25	19.75	70	209	28

The dimensions above apply to codes starting with "T" as well.

REQUIRED TO SPECIFY

1. **Model number** (above)
2. **Front Style** (above)
3. **Pull Style** (page 500)
4. **Base Rail** -TB models note "Style 1"
5. **Case Color** (page 500 note color selection)
6. **Options** (below)

JUNO TV UNIT OPTIONS

	LIST		LIST
Locking Top Drawer or Door - LK	48	Laminate Drawer - DR	N/C
Leg Leveler (per unit) - LL	14	Master Key - MK	40
Pull-out Swivel TV Tray - SW	309		

MODEL CODE KEY

Product Line	Description	Style	Width	Base Style	Orientation (hinge side when facing cabinet)
J	E	1	32	1	N
Units with Legs	TV Unit	3 Drawers		4 legs	Not Applicable
T		2		9	
Units without Legs		2 Doors & Shelf		no legs or casters	

JUNO | TV UNITS

FRONT STYLES

Delphine front is laminate. Lia is thermoformed vinyl.

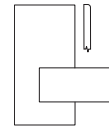
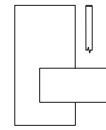
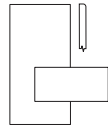
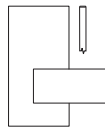

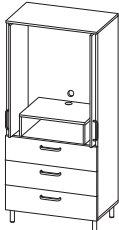
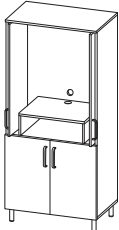
Description/Model	Delphine - D	Lia - L	Delphine - D	Lia - L
TV Unit w/ 3 Drawers and Pocket Doors 	JE3321N 4518	5078	TE3329N 4468	5028
TV Unit w/ 2 Doors, Shelf and Pocket Doors 	JE4321N 4005	4564	TE4329N 3953	4518

* Indicates model illustrated by line drawing.

DIMENSIONS

	Overall Width	Overall Depth	Overall Height	Shipping Weight	Cubes
JE3321N	40	19.75	70	311	35
JE4321N	40	19.75	70	277	35

The dimensions above apply to codes starting with "T" as well.

REQUIRED TO SPECIFY

1. Model number (above)
2. Front Style (above)
3. Pull Style (page 500)
4. Base Rail -TB models note "Style 1"
5. Case Color (page 500 note color selection)
6. Options (below)

JUNO TV UNIT OPTIONS

	LIST	LIST
Locking Top Drawer or Door - LK	48	Laminate Drawer - DR
Leg Leveler (per unit) - LL	14	Master Key - MK
Pull-out Swivel TV Tray - SW	309	N/C
		40

MODEL CODE KEY

Product Line	Description	Style	Width	Base Style	Orientation (hinge side when facing cabinet)
J	E	3	32	1	N
Units with Legs	TV Unit	Pocket Doors & 3 Drawers		4 legs	Not Applicable
T		4		9	
Units without Legs		Pocket Doors & 2 Doors w/ Shelf		no legs or casters	

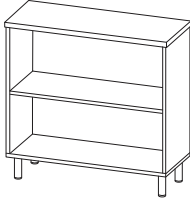
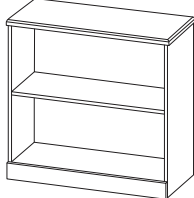
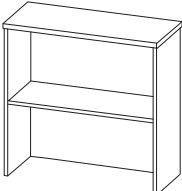
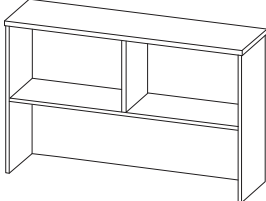
Description/Model	Price		Description/Model	Price
Bookcase w/ 1 Fixed Shelf 	JS1321N 627		Bookcase w/ 1 Fixed Shelf 	TS1329N 576
Bookcase Top for 32" Dresser 	TS2309N 552		Bookcase Top for 48" Desk 	TS3489N 689

DIMENSIONS

	Overall Width	Overall Depth	Overall Height	Shipping Weight	Cubes
JS1321N	31.25	12	30	65	8
TS2309N	29.75	10	31.4	70	6
TS3489N	46	10	31.4	75	9

The dimensions above apply to codes starting with "T" as well.

REQUIRED TO SPECIFY

1. **Model number** (above)
2. **Top Material/Top Edge Profile** -1321N only (right)
4. **Base Rail** -TS model note "Style 1"
5. **Top Color** (page 500 note color selection)
6. **Case Color** (page 500 note color selection)
7. **Options** (below)

TOP MATERIALS: (Page 7)

	LIST
Laminate W/ Polymer Edge - L (with Edge Profile A)	N/C
HP Laminate W/ Polymer Edge - P (with Edge Profile A)	35
Seamless Thermoformed Vinyl - B or C (with Edge Profiles B or C)	78

JUNO TV UNIT OPTIONS

LIST

Leg Leveler (per unit) - LL	14
Extended Top Overhang - EX JS1321N & TS1329N	N/C

MODEL CODE KEY

Product Line	Description	Style	Width	Base Style	Orientation (hinge side when facing cabinet)
J	S	1	32	1	N
Units with Legs	Bookcase			4 legs	Not Applicable
T		2		9	
Units without Legs				no legs or casters	

JUNO | DESKS

FRONT STYLES

Delphine front is laminate. Lia is thermoformed vinyl.

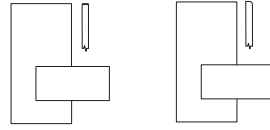

Description/Model	Delphine - D	Lia -L
Desk Shell	TK1489N	669

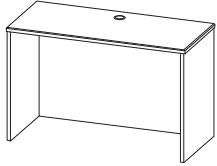

Description/Model	Delphine - D	Lia -L
Desk w/ 1 Drawer	TK2489N	897

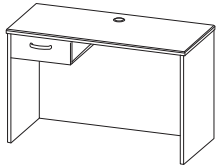

DIMENSIONS

	Overall Width	Overall Depth	Overall Height	Shipping Weight	Cubes
TK1489N	47.25	19.75	30	101	18
TK2489N	47.25	19.75	30	112	18

The dimensions above apply to codes starting with "T" as well.

REQUIRED TO SPECIFY

1. Model number (above)
2. Top Material/Top Edge Profile (below)
3. Front Style (above)
4. Pull Style (page 500)
5. Top Color (page 500 note color selection)
6. Case Color (page 500 note color selection)
7. Options (below)

TOP MATERIALS: (Page 7)

LIST

Laminate W/ Polymer Edge	- L (with Edge Profile A)	N/C
HP Laminate W/ Polymer Edge	- P (with Edge Profile A)	79
Seamless Thermoformed Vinyl	- B or C (with Edge Profiles B or C)	178

JUNO DESK OPTIONS



LIST

Locking Top Drawer or Door - LK	46
Laminate Drawer - DR	N/C
Extended Top Overhang - EX	N/C
Master Key - MK	39

MODEL CODE KEY

Product Line	Description	Style	Width	Base Style	Orientation (hinge side when facing cabinet)
T	K	1	48	9	N
Units without Legs	Desk	Shell		no legs or casters	Not Applicable
		2			
		1 Drawer			

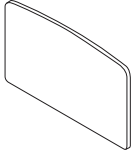
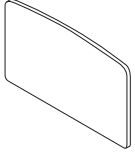
JUNO | HEADBOARD/FOOTBOARD, MARKERBOARD, MIRROR & CORKBOARD

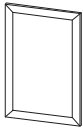
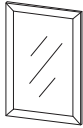
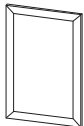
Description/Model	Price	Overall Width	Overall Depth	Overall Height	Shipping Weight	Cubes
Headboard TF1369N	427	36	0.75	22	17	1
						
Footboard TF2369N	334	36	0.75	16	13	0.75
						
Mounting Legs (2) TF3029N	224	2.375	0.75	30	3	0.25
 <p>ORDERING NOTES: Legs are used to attach a headboard to a bed frame. Mounting Legs are solid maple in a clear finish. Hardware is not included.</p>						
Wall Mount Markerboard TMB209N	466	20	0.75	32	11	1.2
						
Wall Mount Mirror - Glass TGM209N	536	20	0.75	32	17	1.2
						
Wall Mount Corkboard TTB209N	466	20	0.75	32	9	1.2
 <p>ORDERING NOTES: Laminate frames are supplied around markerboards, mirrors, and corkboards.</p>						

Required to Specify:

1. Model number
2. Color (page 500)
3. Options (below)

JUNO HEADBOARD/FOOTBOARD OPTIONS \$LIST

Custom Cutout - CC -per headboard or footboard	\$129
---	-------

JUNO | OVERBED TABLES - FEATURES & OPTIONS

Top Shape R is available in High-Pressure Laminate with Polymer Edges. Top Shapes K, C, and P are Seamless Thermoformed Vinyl and include a spill-guard edge as standard.



High-Pressure Laminate Edge



Seamless Thermoformed Vinyl with Spill-guard Edge

VINYL COLORS:



Champagne



Hardrock Maple



Copper



Shiraz Cherry



Gingerbread



Park Avenue Walnut



Chocolate



Nutmeg



Dark Walnut



Ash



Portobello



Willow



Platinum

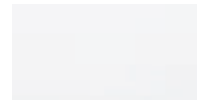

Designer White

BASE COLORS FOR OVERBED TABLES:

Select one:

S - Silver Metallic

G - Graphite

B- Black

A - Almond

N - Nevada

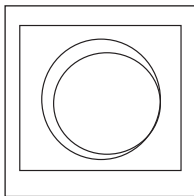

INTEGRATED SEAMLESS CUP HOLDER

The Integrated Seamless Cup Holder is available on the thermoformed vinyl tops. It is 3/8" deep and 2 1/2" in diameter. A drawing must be supplied to show the location. Two cup holders are standard on thermoformed vinyl tops when a dual top model is ordered.

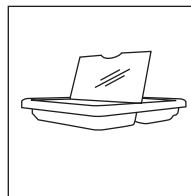

VANITY DRAWER AND MIRROR

Overbed tables have the option of a vanity drawer to store patients personal items. This drawer includes a mirror and is non-locking. Please include on the order.

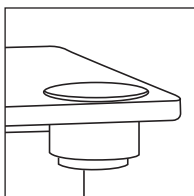

RECESSED CUP HOLDER

The Recessed cup holder is a molded flexible insert with an opening in the bottom. The inner dimensions are 3.5" diameter by 2.6" deep. It fits in a cut-out in the top. The opening is edge banded. A drawing must be supplied to show the required location.

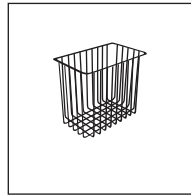

STORAGE BASKETS



Powder-coated wire brackets are available in 3 sizes - 9" x 9" x 10", 10" x 6" x 9" and 5" x 5" x 4".

TOP SHAPES

Rectangular
High-Pressure Laminate
with Polymer edges.

Kidney, Rectangular and Peanut
Seamless Thermoformed Vinyl.

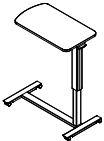
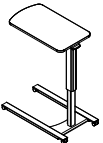

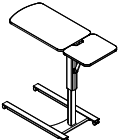
Description/Model		Rectangular - R	Kidney - K (LorR)	Rectangular - C	Peanut - P
Overbed Table w/ H - Base 	TO1304N	1289	1319	1319	1319
Overbed Table w/ U - Base 	TO2304N	1289	1319	1319	1319
Dual Top Overbed Table w/ H - Base 	TO3304N	n/a	n/a	2271	2271
Dual Top Overbed Table w/ U - Base 	TO4304N	n/a	n/a	2271	2271

DIMENSIONS

	Overall Width	Overall Depth	Overall Height Range	Shipping Weight	Cubes
TO1304N	30	16	27/43	50	15
TO2304N	30	16	27/43	50	15
TO3304N	30	16	27/43	54	15
TO4304N	30	16	27/43	54	15

ORDERING NOTES: Cubes shown above are for 2 overbed tables per carton. The overall height of the U-base including casters is less than 2" and the H-base is 3.25"

REQUIRED TO SPECIFY

1. Model number (above)
2. Top Shape/Material (above - Kidney please choose left or Right facing)
5. Top Color (page 500 note color selection)
6. Base Color (page 500 note color selection)
7. Options (below)

JUNO OVERBED TABLE OPTIONS

	\$LIST
Vanity Drawer & Mirror - VM	357
-per headboard or footboard	
Storage Basket	
9" x 9" x 10" - B1	155
10" x 6" x 9" - B2	155
5" x 5" x 4" - B3	155
Integrated Seamless Cup Holder - IC	N/C
Recessed Cup Holder - RC	123

TREVISA | LEED CI CREDIT SUMMARY



MATERIAL CONTENT:

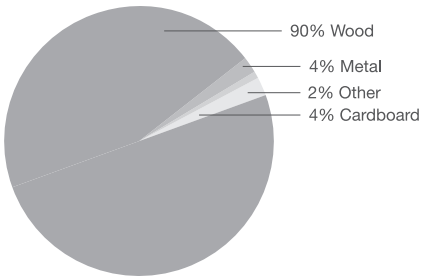

PRE-CONSUMER
RECYCLED CONTENT = 91%

POST-CONSUMER
RECYCLE CONTENT = 4%

CONTRIBUTES TO

CREDIT 2.1 - 2.2	Construction Waste Management	1-2 point(s)
CREDIT 3.3	Resource Reuse	1 point
CREDIT 4.1	Recycled Content	1 point
CREDIT 4.2	Recycled Content	1 point
CREDIT 4.4	Low Emitting Materials	1 point
	Composite Wood & Laminate Adhesives	1 point
CREDIT 5.1	Regional Materials*	1 point
CREDIT 7	Certified Wood (PLEASE ENQUIRE)	1 point

* This credit is only applicable if in total 20% of the combined value of the procured construction materials and furniture is manufactured within a radius of 500 miles. This credit will apply if the installation of the finished product occurs within 500 miles of Toronto, Ontario.

BREADTH OF LINE:

The healthcare casegoods lines offer solutions from contemporary to transitional to traditional styling. Trevisa offers transitional and traditional. The lines are extremely wide including 5 bedside table configurations, 3 dressers, 2 benches, 2 combination bench/wardrobes, 8 wardrobe/storage units, 4 TV units, 3 bookcases, 2 desks, a headboard and footboard, a marker board, mirror and corkboard, and 4 overbed tables. In addition custom modular headwalls and footwalls are offered.



CUSTOM CAPABILITY:

Krug can offer both custom sizes of standard product and completely custom units, including modular headwalls and footwalls. For more information, please contact Customer Service.

DURABILITY:

Cabinets are constructed of 3/4" thick panels including backs. In contrast to cabinets constructed with 1/8" back panels, the Trevisa units are more robust and less susceptible to damage. All exposed laminate edges are covered with 2.5mm polymer edge banding in colors matching the laminates. This thicker edge banding provides an increased level of durability on all edges as well as a 2.5 mm radius on the edge. The softer radius is less likely to bruise or cut the skin of a patient or caregiver. Bottom panels extend under the side and back panels of cabinets with 4 casters in order to maximize the ability of the cabinet to withstand heavy handling.



DRY FIT CONSTRUCTION:

Cabinets are assembled with mechanical cams. This is known as dry fit construction. The result is that any panel can be replaced if damaged, unlike in the case of cabinets that are glued together where damage to any surface leads to replacement of the entire unit.

VENTS:

There is one 1" diameter vent for each drawer and each door set for air circulation. All vent holes are covered with plastic vents both inside and outside to eliminate exposed particle board, thus preventing moisture and bacteria from entering the core.

SEALED CORE:

All unseen particle board edges that are not covered by an adjoining panel are edge banded (i.e. no exposed particle board). As with the vent covers noted above, this prevents moisture and bacteria from seeping into the core.



DRAWERS:

Drawers have white metal sides with white laminate bottoms and backs, and all exposed particle board edges are edge banded.

The unobstructed metal sides facilitate cleaning. Bumpers are installed on all drawers and doors to soften the sound of closing.



DOOR AND DRAWER PULL STYLES:

Flex is an injection-molded plastic pull designed to offer some "give" or flexibility when inadvertently hit by a patient or caregiver. The color is similar to Silver Metallic.

The Indus pull eliminates a protrusion that could bruise a patient or caregiver. The finish is Silver Metallic.

The Ravenna and Murano are attractive transitional pulls in satin nickel.

The Renzo knob pull creates a much different cabinet appearance. The finish is satin nickel.

The Verona and Padua traditional pulls are mounted with rosettes. Finish in antique brass. A complimentary brushed brass knob is used on doors.

TREVISA | FEATURES



TOPS:

Tops are 3/4" thick and can be laminate with polymer edge banding, high-pressure laminate with polymer edge banding, or seamless thermoformed vinyl.

- Edge A - Laminate with Polymer Edge, or High-Pressure Laminate with Polymer Edge
- Edge B - Seamless Thermoformed Vinyl
- Edge C - Seamless Thermoformed Vinyl
- Edge D - Seamless Thermoformed Vinyl
- Edge E - Seamless Thermoformed Vinyl
- Edge F - Seamless Thermoformed Vinyl
- Edge G - High-Pressure Laminate with Wood Edge, or Seamless Thermoformed Vinyl
- Edge S - Laminate with T-Mold bumper or High-Pressure Laminate with T-Mold bumper. With this edge the overhang is 1/2" on all sides.

Standard Top Overhang is 1/4" on 4 sides

Optional Top Overhang is 1/2" on 4 sides (to assist with movement of the cabinet)

Tops on units over 40" high are laminate only



DOOR / DRAWER FRONTS:

Door / Drawer fronts are 3/4" thick and 7 styles are available.

- Delphine - Laminate with Polymer Edge
- Lia - Seamless Thermoformed Vinyl
- Como - Seamless Thermoformed Vinyl
- Assano - Seamless Thermoformed Vinyl
- Bassano - Seamless Thermoformed Vinyl
- Elba - Seamless Thermoformed Vinyl
- Rossano - Seamless Thermoformed Vinyl

Headboards and footboards are high-pressure laminate on 3/4" plywood with polymer edge banding. HPL and plywood are used in this application for added strength.



BASE RAILS (material will be the same as the Door/Drawer Fronts):

Cabinets are available with 4 1/4" legs (for ease of cleaning), or sides to the floor with the following 4 front base-rail options.

- Option 1 - Laminate with Polymer Edge, or Seamless Thermoformed Vinyl
- Option 2 - Laminate with Polymer Edge, or Seamless Thermoformed Vinyl
- Option 3 - Laminate with Polymer Edge, or Seamless Thermoformed Vinyl
- Option 4 - Laminate with Polymer Edge, or Seamless Thermoformed Vinyl



BENCH

The cushion for the bench is 3" thick.

LAMINATE COLORS:

There are 4 solid color options and 13 wood-grain colors. All colors are available in laminate, high-pressure laminate and thermoformed vinyl. Polymer Edge banding matches the laminate selections. Wood finishes to match the wood-grain laminates are available for Krug Healthcare Seating.

VENEER

Many items in the Trevisa product line are also available in maple veneer and in a combination of veneer exterior surfaces and laminate interior faces.

The veneered version is available with the Delphine front and "A" top edge profile. Both high-pressure laminate and thermoformed vinyl tops can be supplied as options with the veneered cabinets. Please contact your Krug representative or customer service for a quotation on veneered product.

ENVIRONMENTAL FEATURES:

Trevisa cabinets have a very high recycled content and contribute to both LEED credits 4.1 and 4.2. The packaging is recyclable. Non-urea-added core is available as an option and air-emissions certified product is also optionally available. FSC wood may be possible on larger projects.

WARRANTY:

All cabinets carry a limited lifetime warranty. Overbed tables have a 2-year warranty.

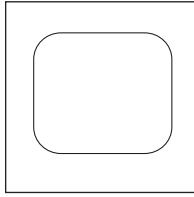

ROUNDED TOPS

A top with rounded corners is available as an option on bedside tables. There is a choice of laminate or high-pressure laminate. The edge is polymer to match the laminate color. The overhang is 3/4" on all 4 sides of the top. (Tops specified with T-mold bumper are also rounded at corners. In these cases the overhang is 1/2" on all sides).

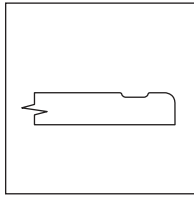

SPILL-GUARD EDGE

Trevisa bedside tables are available with the spill-guard edge surface on the thermoformed vinyl tops to collect liquids when spills occur.

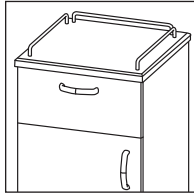

GALLERY RAILS

Optional gallery rails are satin nickel finish. There is a rail on each side and another across the back.

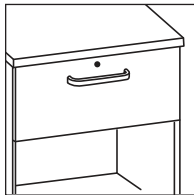

LOCKING TOP DRAWER OR DOOR

Trevisa cabinets have the option to lock. They can be randomly keyed for security. The lock option is factory installed and must be specified on the order.

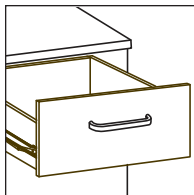

LAMINATE DRAWER

An optional white laminate drawer with a single-action, 3/4-extension slide is available at no upcharge. All edges are banded.

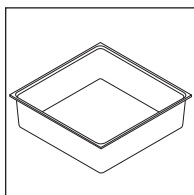

SEAMLESS DRAWER LINER

Trevisa bedside tables are available with the option of a plastic drawer liner. Ideal for infection control purposes, it can be removed, sterilized or replaced when damaged or degraded.

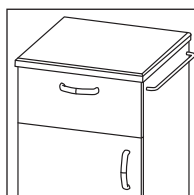

TOWEL BAR

The Towel Bar is an option on Trevisa and fastens to the sides of the bedside tables. It is available in a satin nickel finish. It can be field installed. The standard placement is the side opposite the hinge.

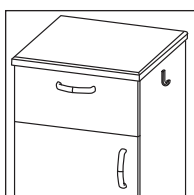

LITTER BAG HOLDER

The Litter Bag Holder option fastens to the sides of the bedside tables. It is available in a satin nickel finish. It holds small paper bags and can be field-installed. The standard placement is the side opposite the hinge.

MASTER KEY

Trevisa bedside tables have the option to lock with a master key. This must be specified on the order.

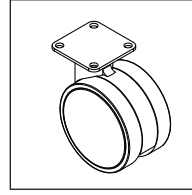

LEG / CASTERS:

Trevisa Bedside Tables have 3 base options - sides to floor and front base rail, 2 non-swivel back casters, or 4 swivel casters 2 of which are locking (there is no base rail in this case).

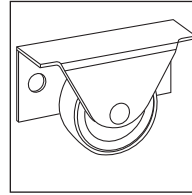

CABINET MOUNT MARKERBOARD

The Markerboards are 24" high by 12" wide. They can be mounted to the inside or outside of the cabinet door (inside is standard).

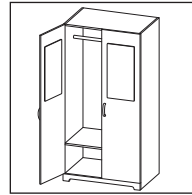

CABINET MOUNT MIRROR OPTION

The Mirrors are 24" high by 12" wide and acrylic. They can be mounted to the inside or outside of the cabinet door (inside is standard).

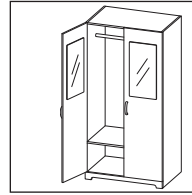

CABINET MOUNT CORKBOARD OPTION

The Mirrors are 24" high by 12" wide and acrylic. They can be mounted to the inside or outside of the cabinet door (inside is standard).

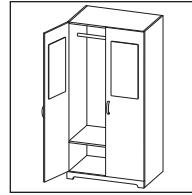

LOWER MOUNTING COAT ROD AND SHELF (ADA)

Trevisa Wardrobes are available with the lower shelf and coat rod for ADA compliance (shelf is 48" above the floor).

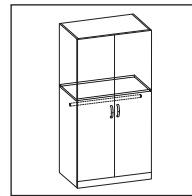

CROWN MOLDING

Crown Molding is available as an option for tall units. It is in thermoformed vinyl to match the cabinet. Crown Molding ships separately and is field installed. It is supplied for the front and two sides with mitered joints.

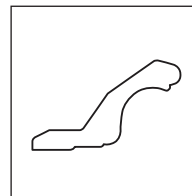

PULL-OUT SWIVEL TV TRAY

Trevisa TV Units come with the option of a pull-out swivel TV Tray. The swivel tray is factory installed and must be specified at the time of order.

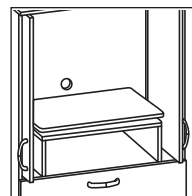

EXTENDED TOP OVERHANG

Rather than the standard 1/4" top overhang on all sides, this can be at 1/2" to facilitate moving of the cabinet for cleaning.

TREVISA | SPECIFYING

REQUIRED TO SPECIFY

After each product grouping in the following pages, there is a summary under the title “Required to Specify”. The summary lists the elements that need to be specified including Model Number, Top & Edge Profile, Pull Style and Color, Body Style and Color,

TOP EDGE PROFILES:

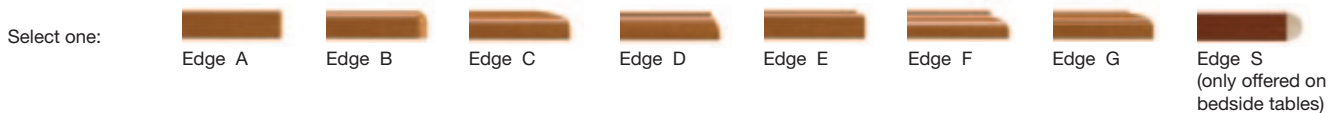

ORDERING NOTES:

Edge A is available in Laminate with Polymer Edge or High-Pressure Laminate with Polymer Edge.
 Edge Profiles B, C, D, E, F & G are available in Seamless Thermoformed Vinyl. Laminate surface is not flush to the wood edge. Spill-guard Edge can be ordered on Edge Profiles B, C, D, E, F & G in Seamless Thermoformed Vinyl.
 Edge S is available in Laminate with T-Mold bumper or High-Pressure Laminate T-Mold bumper.

DOOR AND DRAWER PULL STYLES:

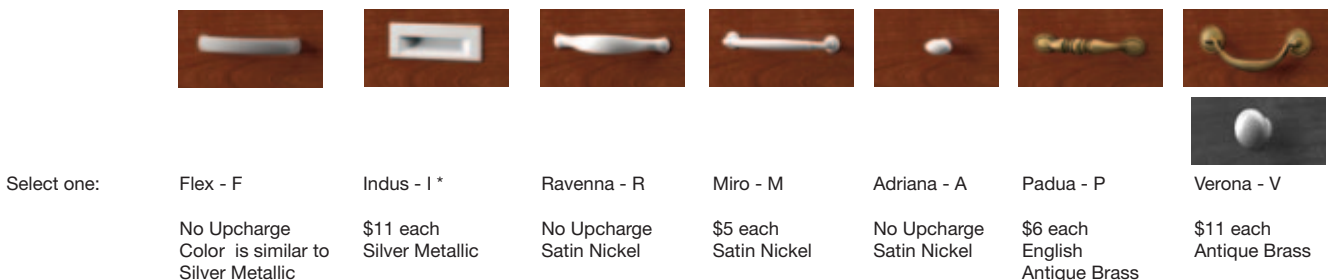

ORDERING NOTES:

* Cannot be used on Front Styles Como or Azzano.

BASE RAILS:



LAMINATE:



VINYL COLORS: (For Overbed Table vinyl selection see page 540)

Select one:



VENEER COLORS:

Select one:



SOLID SURFACE: Please contact customer service for a quote. See page 551 for color options.

T-MOLD BUMPER COLORS:

Select one: Beige - B Charcoal Grey - C

BASE COLORS FOR OVERBED TABLES:

Select one: S - Silver Metallic G - Graphite B- Black A - Almond N - Nevada

ORDERING NOTES:

A typical selection and the ideal way to enter on your purchase order would be as follows:

REQUIRED TO SPECIFY	SPECIFIED	LIST	
1. Model number (above)	TB1201R	\$921	Bedside Table with 1 drawer/1 door and Lia fronts Right handed
2. Top Material/Top Edge Profile (below)	- B	\$78	Edge Profile B Seamless Thermoformed Vinyl
3. Front Style (above)	- L	as listed	Lia
5. Base Rail	-1	N/C	
4. Pull Style (page 523)	- F	Flex	
6. Top Color (page 523 note color selection)	Top Color (select color)	N/C	
7. Case Color (page 523 note color selection)	Body Color (select color)	N/C	
8. T-mold bumper - Edge Profile S note color selection			
9. Options (below)	Options:		
	Locking Top Drawer - LK	\$49	
	Seamless Drawer Liner - SL	\$49	
	Final - TB1201 R B L 1 F LK SL -	\$1097	

TREVISA | BEDSIDE TABLES

FRONT STYLES

Delphine front is laminate. All others are thermoformed vinyl.

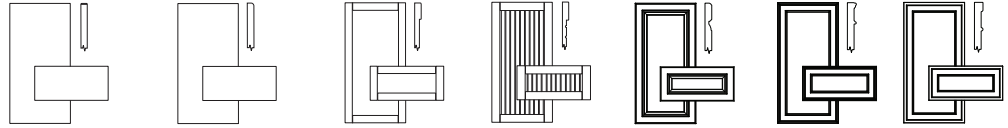

Description/Model	Delphine - D	Lia - L	Como - C	Azzano - A	Bassano - B	Elba - E	Rossano - R
1 Drawer, 1 Door TB1209L* R TB1203L R TB1204L R	794	921	963	982	990	1018	1018
	845	973	1016	1032	1043	1067	1067
	879	1006	1052	1065	1080	1106	1106
1 Drawer, 1 Fixed Shelf TB2209N* TB2203N TB2204N	691	816	861	877	888	914	914
	740	868	912	928	939	963	963
	777	901	946	960	974	1001	1001

DIMENSIONS

	Overall Width	Overall Depth	Overall Height	Shipping Weight	Cubes
TB1209 (TB1203, TB1204)	19.75	19.75	30	77	8
TB2209 (TB2203, TB2204)	19.75	19.75	30	74	8

REQUIRED TO SPECIFY

1. Model number (above)
2. Top Material/Top Edge Profile (right)
3. Front Style (above)
4. Base Rail (page 523)
5. Pull Style (page 523)
6. Top Color (page 523)
7. Body Color (page 523)
8. T-mold bumper color if applicable (page 500)
9. Options (below)

TOP MATERIALS: (page 7)

	LIST
Laminate W/ Polymer Edge - L (with Edge Profile A)	N/C
HP Laminate W/ Polymer Edge - P (with Edge Profile A)	35
Seamless Thermoformed Vinyl - B - G (with Edge Profiles B - C)	78
Laminate Bumper - X (with Edge Profile S)	48
HP Laminate Bumper - Y (with Edge Profile S)	82

TREVISA BEDSIDE TABLE OPTIONS

	LIST		LIST
Spill Guard Edge - SG	51	Towel Bar - TB	51
NOTE: Available on Seamless Thermoformed Vinyl only.		Master Key - MK	40
Locking Top Drawer or Door - LK	48	Laminate Drawer - DR	N/C
Gallery Rails - GR	199	Rounded Top - RT	N/C
Leg Leveler (per unit, 4 Legs) - LL	14	NOTE: Available with Top Materials Laminate or HPL and Top Edge Profile "A".	
Litter Bag Holder - BH	14	Extended Top Overhang - EX	N/C
Seamless Drawer Liner - SL	51		

MODEL CODE KEY



Product Line	Description	Style	Width	Base Style	Orientation (hinge side when facing cabinet)
T	B	1	20	3	L
Units without Legs	Bedside Table	1 Drawer, 1 Door		2 casters	Hinged Left
		2		4	R
		1 Drawer, 1 Fixed Shelf		4 casters	Hinged Right
				9	N
				no legs or casters	Not Applicable

TREVISA | BEDSIDE TABLES

FRONT STYLES

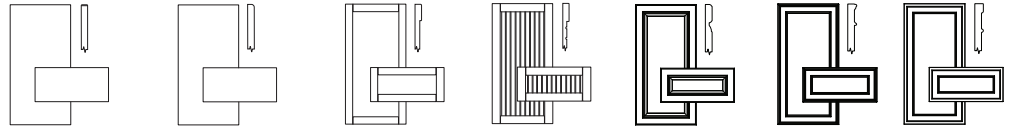
Delphine front is laminate. All others are thermoformed vinyl.



Description/Model	Delphine - D	Lia - L	Como - C	Azzano - A	Bassano - B	Elba - E	Rossano - R
1 Drawer	TB3209N* 665	768	804	815	822	844	844
	TB3203N 715	820	852	866	873	894	894
	TB3204N 751	853	888	900	909	929	929
3 Drawers	TB4209N* 1066	1194	1239	1253	1266	1292	1292
	TB4203N 1118	1245	1289	1306	1315	1342	1342
	TB4204N 1153	1281	1323	1340	1351	1377	1377

DIMENSIONS

	Overall Width	Overall Depth	Overall Height	Shipping Weight	Cubes
TB3209 (TB3203, TB3204)	19.75	19.75	24	62	6
TB4209 (TB4203, TB4204)	19.75	19.75	30	92	8

REQUIRED TO SPECIFY

1. Model number (above)
2. Top Material/Top Edge Profile (right)
3. Front Style (above)
4. Base Rail (page 523)
5. Pull Style (page 523)
6. Top Color (page 523)
7. Body Color (page 523)
8. T-mold bumper color if applicable (page 500)
9. Options (below)

TOP MATERIALS: (page 7)

	LIST
Laminate W/ Polymer Edge - L (with Edge Profile A)	N/C
HP Laminate W/ Polymer Edge - P (with Edge Profile A)	35
Seamless Thermoformed Vinyl - B - G (with Edge Profiles B - C)	78
Laminate Bumper - X (with Edge Profile S)	48
HP Laminate Bumper - Y (with Edge Profile S)	82

TREVISA BEDSIDE TABLE OPTIONS

	LIST		LIST
Spill Guard Edge - SG	51	Towel Bar - TB	51
NOTE: Available on Seamless Thermoformed Vinyl only.		Master Key - MK	40
Locking Top Drawer or Door - LK	48	Laminate Drawer - DR	N/C
Gallery Rails - GR	199	Rounded Top - RT	N/C
Leg Leveler (per unit, 4 Legs) - LL	14	NOTE: Available with Top Materials Laminate or HPL and Top Edge Profile "A".	
Litter Bag Holder - BH	14	Extended Top Overhang - EX	N/C
Seamless Drawer Liner - SL	51		

MODEL CODE KEY

Product Line	Description	Style	Width	Base Style	Orientation (hinge side when facing cabinet)
T	B	3	20	3	L
Units without Legs	Bedside Table	1 Drawer		2 casters	Hinged Left
		4		4	R
		3 Drawers		4 casters	Hinged Right
				9	N
				no legs or casters	Not Applicable

TREVISA | BEDSIDE TABLES

FRONT STYLES

Delphine front is laminate. All others are thermoformed vinyl.

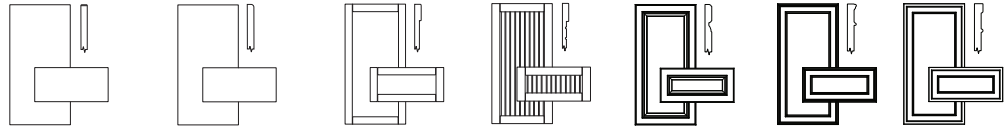

Description/Model	Delphine - D	Lia - L	Como - C	Azzano - A	Bassano - B	Elba - E	Rossano - R
1 Drawer, 1 Door  TB5209L* R	1082	1230	1283	1304	1315	1351	1351
TB5203L R	1131	1282	1333	1355	1369	1402	1402
TB5204L R	1166	1315	1370	1389	1402	1437	1437

* Indicates model illustrated by line drawing.

1 Drawer, 1 Door  TB6209L* R	1066	1218	1270	1290	1304	1338	1338
TB6203L R	1118	1268	1319	1341	1355	1389	1389
TB6204L R	1153	1304	1356	1376	1389	1422	1422

DIMENSIONS

	Overall Width	Overall Depth	Overall Height	Shipping Weight	Cubes
TB5209 (TB5203, TB5204)	20.75	20.75	35.5	89	9
TB6209 (TB6203, TB6204)	20.75	19.75	35.5	88	9

REQUIRED TO SPECIFY

1. Model number (above)
2. Top Material/Top Edge Profile (right)
3. Front Style (above)
4. Base Rail (page 523)
5. Pull Style (page 523)
6. Top Color (page 523)
7. Body Color (page 523)
8. T-mold bumper color if applicable (page 500)
9. Options (below)

TOP MATERIALS: (page 7)

	LIST
Laminate W/ Polymer Edge - L (with Edge Profile A)	N/C
HP Laminate W/ Polymer Edge - P (with Edge Profile A)	35
Seamless Thermoformed Vinyl - B - G (with Edge Profiles B - C)	78
Laminate Bumper - X (with Edge Profile S)	48
HP Laminate Bumper - Y (with Edge Profile S)	82

TREVISA BEDSIDE TABLE OPTIONS

	LIST	LIST
Spill Guard Edge - SG	51	Towel Bar - TB
NOTE: Available on Seamless Thermoformed Vinyl only.		Master Key - MK
Locking Top Drawer or Door - LK	48	Laminate Drawer - DR
Gallery Rails - GR	199	Rounded Top - RT
Leg Leveler (per unit, 4 Legs) - LL	14	NOTE: Available with Top Materials Laminate or HPL and Top Edge Profile "A".
Litter Bag Holder - BH	14	Extended Top Overhang - EX
Seamless Drawer Liner - SL	51	

MODEL CODE KEY

Product Line	Description	Style	Width	Base Style	Orientation (hinge side when facing cabinet)
T	B	5	20	3	L
Units without Legs	Bedside Table	1 Drawer, 1 Door		2 casters	Hinged Left
		6		4	R
		1 Drawer, 1 Door		4 casters	Hinged Right
				9	N
				no legs or casters	Not Applicable

FRONT STYLES

Delphine front is laminate. All others are thermoformed vinyl.

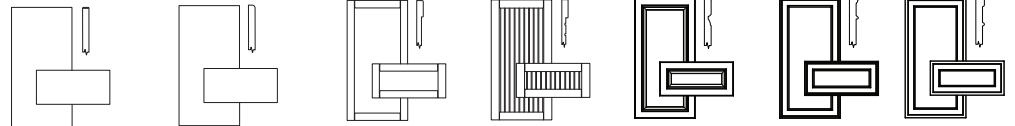

Description/Model	Delphine - D	Lia - L	Como - C	Azzano - A	Bassano - B	Elba - E	Rossano - R
3 Drawer TD1329N	1187	1389	1459	1484	1503	1547	1547



4 Drawer TD2329N	1513	1772	1866	1899	1924	1984	1984
------------------	------	------	------	------	------	------	------



6 Drawer TD3609N	2165	2542	2672	2721	2756	2838	2838
------------------	------	------	------	------	------	------	------



DIMENSIONS

	Overall Width	Overall Depth	Overall Height	Shipping Weight	Cubes
TD1329N	31.75	19.75	30	130	12
TD2329N	31.75	19.75	38.6	161	15
TD3609N	59.75	19.75	30	246	23

REQUIRED TO SPECIFY

1. Model number (above)
2. Top Material/Top Edge Profile (right)
3. Front Style (above)
4. Base Rail (page 523)
5. Pull Style (page 523)
6. Top Color (page 523 note color selection)
7. Case Color (page 523 note color selection)
8. Options (below)

TOP MATERIALS: (page 7)

	LIST
Laminate W/ Polymer Edge - L (with Edge Profile A)	N/C
3 or 4 drawer	
HP Laminate W/ Polymer Edge - P (with Edge Profile A)	58
Seamless Thermoformed Vinyl - B or C (with Edge Profiles B or C)	123
6 drawer	
HP Laminate W/ Polymer Edge - P (with Edge Profile A)	103
Seamless Thermoformed Vinyl - B or C (with Edge Profiles B or C)	232

TREVISA DRESSER OPTIONS

LIST

Locking Top Drawer or Door - LK	48	Laminate Drawer - DR	N/C
Master Key - MK	40	Extended Top Overhang - EX	N/C

MODEL CODE KEY

Product Line	Description	Style	Width	Base Style	Orientation (hinge side when facing cabinet)
T	D	1	32	1	N
Units without Legs	Dresser	3 Drawer		4 legs	Not Applicable
		2	60	6	
		4 Drawers		6 legs	
		3		9	
		6 Drawers		no legs or casters	

TREVISA | BENCHES

FRONT STYLES

Delphine front is laminate. All others are thermoformed vinyl.

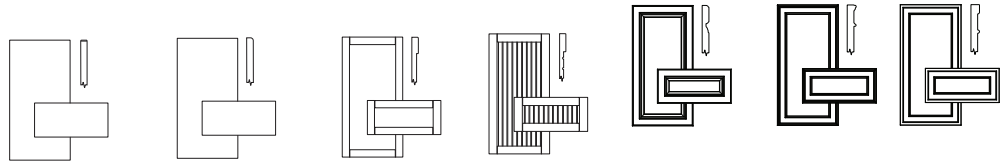

Description/Model	Delphine - D	Lia - L	Como - C	Azzano - A	Bassano - B	Elba - E	Rossano - R
Open Bench	TC1309N TC1369N	915 1092	n/a n/a	n/a n/a	n/a n/a	n/a n/a	n/a n/a

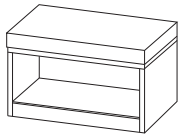

Description/Model	Delphine - D	Lia - L	Como - C	Azzano - A	Bassano - B	Elba - E	Rossano - R
Bench with 2 Drawers	TC2309N TC2369N	1220 1376	1335 1513	1369 1554	1378 1567	1387 1578	1405 1601



DIMENSIONS

	Overall Width	Overall Depth	Overall Height	Shipping Weight	Cubes
TC1309	29.25	19.75	23	60	8
TC1369	35.25	19.75	23	68	9
TC2309	29.25	19.75	23	88	8
TC2369	35.25	19.75	23	102	9

REQUIRED TO SPECIFY

1. Model number (above)
2. Front Style (above)
3. Base Rail (page 523)
4. Pull Style (page 523)
5. Case Color (page 500 note color selection)
6. Fabric Selection
7. Options (below)

TREVISA BENCH OPTIONS

TREVISA BENCH OPTIONS	LIST
Locking Top Drawer or Door - LK	48
Master Key - MK	40
Laminate Drawer - DR	N/C
Moisture Barrier	85

Cushions are priced in COM/Grade 1

Fabric Grades upcharge	2	3 (COL)	4	5	6	7	8 Leather	9
	33	64	127	190	255	318	381	477

COM yardage is 1 yard for both 30" and 36" cushions. Trevisa benches have a load weight rating of 200lbs.

MODEL CODE KEY

Product Line	Description	Style	Width	Base Style	Orientation (hinge side when facing cabinet)
T	C	1	30	9	N
Units without Legs	Cushioned Bench	Open Bench		no legs or casters	Not Applicable
		2	36		
		Bench with 2 Drawers			

TREVISA | BENCHES & WARDROBE COMBINATION

FRONT STYLES

Delphine front is laminate. All others are thermoformed vinyl.

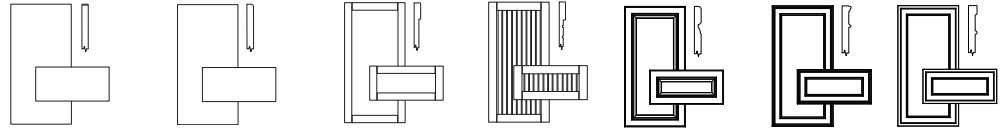

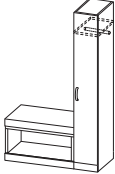
Description/Model	Delphine - D	Lia - L	Como - C	Azzano - A	Bassano - B	Elba - E	Rossano - R
Open Bench with Half Wardrobe 	TC3429L R*	2369	2535	2605	2629	2642	2686
	TC3489L R	2543	2713	2778	2804	2820	2863

Description/Model	Delphine - D	Lia - L	Como - C	Azzano - A	Bassano - B	Elba - E	Rossano - R
Bench, 2 Drawers and Half Wardrobe 	TC4429L R*	2671	2956	3054	3091	3115	3179
	TC4489L R	2828	3134	3238	3279	3305	3373

DIMENSIONS

	Overall Width	Overall Depth	Overall Height of Bench	Overall Height of Wardrobe	Shipping Weight	Cubes
TC3429L/R	41.25	19.75	23	70	167	19
TC3489L/R	47.25	19.75	23	70	175	20
TC4429L/R	41.25	19.75	23	70	195	19
TC4489L/R	47.25	19.75	23	70	209	20

ORDERING NOTES: These units ship as two separate pieces.

REQUIRED TO SPECIFY

1. **Model number** (above)
2. **Front Style** (above)
3. **Base Rail** (page 523)
4. **Pull Style** (page 523)
5. **Case Color** (page 523 note color selection)
6. **Fabric Selection**
7. **Options** (below)

TREVISA BENCH/WARDROBE OPTIONS	LIST	LIST
Locking Top Drawer or Door - LK	48	Lower Mounting Coat Rod and Shelf - AD
Cabinet Mount Corkboard -TB	245	Extended Top Overhang - EX
Laminate Drawer - DR	N/C	Master Key - MK
Cabinet Mount Markerboard - MB	155	Moisture Barrier
Cabinet Mount Mirror - AM	245	

Cushions are priced in COM/Grade 1

Fabric Grades upcharge	(COL)			Leather				
	2	3	4	5	6	7	8	9
	33	64	127	190	255	318	381	477

COM yardage is 1 yard for both 30" and 36" cushions. Trevisa benches have a load weight rating of 200lbs.

MODEL CODE KEY

Product Line	Description	Style	Width	Base Style	Orientation (hinge side when facing cabinet)
T	C	3	42	9	L
Units without Legs	Cushioned Bench	Open Bench		no legs or casters	Hinged Left
		4	48		R
		Bench with 2 Drawers			Hinged Right

TREVISA | WARDROBES AND STORAGE

FRONT STYLES

Delphine front is laminate. All others are thermoformed vinyl.

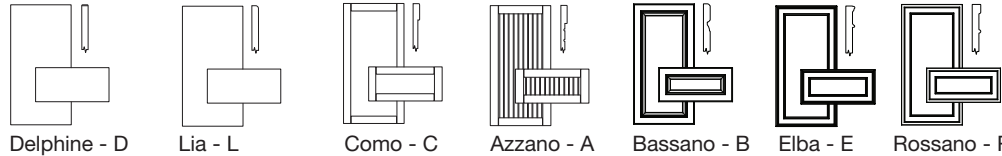

Description/Model	Delphine - D	Lia - L	Como - C	Azzano - A	Bassano - B	Elba - E	Rossano - R
Half Wardrobe w/ Coat Rod	TW1129L R*	1453	1620	1688	1713	1730	1773



Single Door Wardrobe w/ Coat Rod	TW2249L* R	1778	2113	2249	2299	2332	2417	2417
--	---------------	------	------	------	------	------	------	------

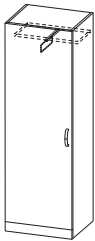

* Indicates model illustrated by line drawing.

DIMENSIONS

	Overall Width	Overall Depth	Overall Height	Shipping Weight	Cubes
TW1129	12	19.75	70	107	11
TW2249	23.25	19.75	70	164	21

REQUIRED TO SPECIFY

1. **Model number** (above)
2. **Front Style** (above)
3. **Base Rail** (page 523)
4. **Pull Style** (page 523)
5. **Case Color** (page 523 note color selection)
6. **Options** (below)

TREVISA WARDROBE OPTIONS

LIST

Locking Top Drawer or Door - LK	48
Cabinet Mount Corkboard -TB	245
Crown Molding 12" door- CM	278
Crown Molding Single door- CM	357

LIST

Cabinet Mount Markerboard - MB	155
Cabinet Mount Mirror - AM	245
Lower Mounting Coat Rod and Shelf - AD	N/C
Master Key - MK	40

MODEL CODE KEY

Product Line	Description	Style	Width	Base Style	Orientation (hinge side when facing cabinet)
T	W	1	12	9	L
Units without Legs	Wardrobe	Half Wardrobe		no legs or casters	Hinged Left
		2	24		R
		Single Door Wardrobe			Hinged Right

TREVISA | WARDROBES & STORAGE

FRONT STYLES

Delphine front is laminate. All others are thermoformed vinyl.

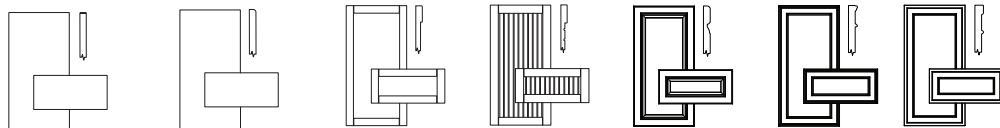

Description/Model	Delphine - D	Lia - L	Como - C	Azzano - A	Bassano - B	Elba - E	Rossano - R
Single Door Storage w/ 4 Fixed Shelves	TW3249L* R	1747	2084	2217	2268	2301	2386

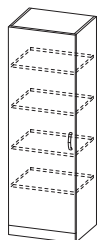

2 Door Wardrobe	TW4369N	2124	2629	2828	2904	2956	3080	3080
-----------------	---------	------	------	------	------	------	------	------

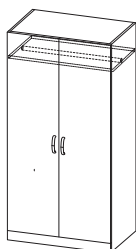

* Indicates model illustrated by line drawing. In the case of the TW5369, "R" has shelves on right.

DIMENSIONS

	Overall Width	Overall Depth	Overall Height	Shipping Weight	Cubes
TW3249	23.25	19.75	70	185	21
TW4369	35.25	23.25	70	243	37

REQUIRED TO SPECIFY

1. Model number (above)
2. Front Style (above)
3. Base Rail (page 523)
4. Pull Style (page 523)
5. Case Color (page 523 note color selection)
6. Options (below)

TREVISA WARDROBE OPTIONS

	LIST		LIST
Locking Top Drawer or Door - LK	48	Cabinet Mount Markerboard - MB	155
Cabinet Mount Corkboard -TB	245	Cabinet Mount Mirror - AM	245
Crown Molding Single door- CM	357	Lower Mounting Coat Rod and Shelf - AD	N/C
Crown Molding 2 door- CM	444	Master Key - MK	40

MODEL CODE KEY

Product Line	Description	Style	Width	Base Style	Orientation (hinge side when facing cabinet)
T	W	3	24	9	L
Units without Legs	Wardrobe	Single Door		no legs or casters	Hinged Left
		4	36		R
		2 Door Wardrobe			Hinged Right
					N
					Not Applicable

TREVISA | WARDROBES & STORAGE

FRONT STYLES

Delphine front is laminate. All others are thermoformed vinyl.

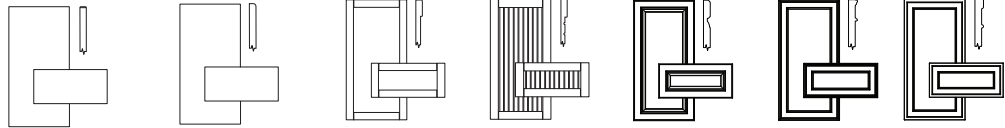

Description/Model	Delphine - D	Lia - L	Como - C	Azzano - A	Bassano - B	Elba - E	Rossano - R
2 Door Wardrobe & Storage w/ 4 Fixed Shelves	TW5369L R*	2427	2932	3133	3208	3257	3383



Description/Model	Delphine - D	Lia - L	Como - C	Azzano - A	Bassano - B	Elba - E	Rossano - R
2 Door Wardrobe w/ Partition	TW6369N	2431	2934	3135	3211	3261	3386

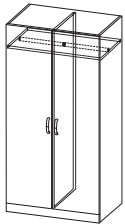

* Indicates model illustrated by line drawing. In the case of the TW5369, "R" has shelves on right.

DIMENSIONS

	Overall Width	Overall Depth	Overall Height	Shipping Weight	Cubes
TW5369	35.25	23.25	70	292	37
TW6369	35.25	23.25	70	272	37

REQUIRED TO SPECIFY

1. **Model number** (above)
2. **Front Style** (above)
3. **Base Rail** (page 523)
4. **Pull Style** (page 523)
5. **Case Color** (page 523 note color selection)
6. **Options** (below)

TREVISA WARDROBE OPTIONS

	LIST		LIST
Locking Top Drawer or Door - LK	48	Cabinet Mount Markerboard - MB	155
Cabinet Mount Corkboard -TB	245	Cabinet Mount Mirror - AM	245
Crown Molding 2 door- CM	444	Lower Mounting Coat Rod and Shelf - AD	N/C
		Master Key - MK	40

MODEL CODE KEY

Product Line	Description	Style	Width	Base Style	Orientation (hinge side when facing cabinet)
T	W	5	36	9	L
Units without Legs	Wardrobe	4 Fixed Shelves		no legs or casters	Hinged Left
		6			R
		Wardrobe w/ Partition			Hinged Right
					N
					Not Applicable

TREVISA - WARDROBES & STORAGE

FRONT STYLES

Delphine front is laminate. All others are thermoformed vinyl.

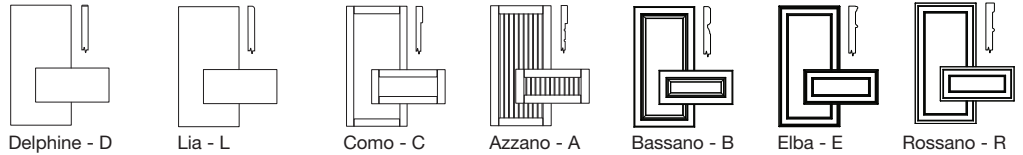

Description/Model	Delphine - D	Lia - L	Como - C	Azzano - A	Bassano - B	Elba - E	Rossano - R
Storage w/ 3 Drawers, TW7329N & 2 Doors w/ 2 Fixed Shelves	2257	2764	2964	3039	3091	3215	3215



Description/Model	Delphine - D	Lia - L	Como - C	Azzano - A	Bassano - B	Elba - E	Rossano - R
Wardrobe w/ Coat Rod & Storage w/ 3 Drawers & 2 Doors w/ 2 Fixed Shelves	TW8429L R*	3158	3742	3978	4066	4125	4271

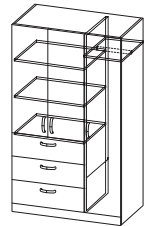

DIMENSIONS

* Indicates model illustrated by line drawing.

	Overall Width	Overall Depth	Overall Height	Shipping Weight	Cubes
TW7329	31.25	19.75	70	252	27
TW8429	41.25	23.25	70	358	43

REQUIRED TO SPECIFY

1. **Model number** (above)
2. **Front Style** (above)
3. **Base Rail** (page 523)
4. **Pull Style** (page 523)
5. **Case Color** (page 523 note color selection)
6. **Options** (below)

TREVISA WARDROBE OPTIONS

	LIST		LIST
Locking Top Drawer or Door - LK	48	Cabinet Mount Markerboard - MB	155
Cabinet Mount Corkboard -TB	245	Cabinet Mount Mirror - AM	245
Crown Molding 2 door/3 drawer- CM	431	Lower Mounting Coat Rod and Shelf - AD	N/C
Crown Molding 3 door/3 drawer- CM	477	Master Key - MK	40

MODEL CODE KEY

Product Line	Description	Style	Width	Base Style	Orientation (hinge side when facing cabinet)
<input type="checkbox"/> T	<input type="checkbox"/> W	<input type="checkbox"/> 7	<input type="checkbox"/> 32	<input type="checkbox"/> 9	<input type="checkbox"/> L
Units without Legs	Wardrobe	3 Drawers & 2 Doors		no legs or casters	Hinged Left
		<input type="checkbox"/> 8	<input type="checkbox"/> 42		<input type="checkbox"/> R
		Wardrobe & 3 Drawers & 2 Doors			Hinged Right
					<input type="checkbox"/> N
					Not Applicable

TREVISA | TV UNITS

FRONT STYLES

Delphine front is laminate. All others are thermoformed vinyl.

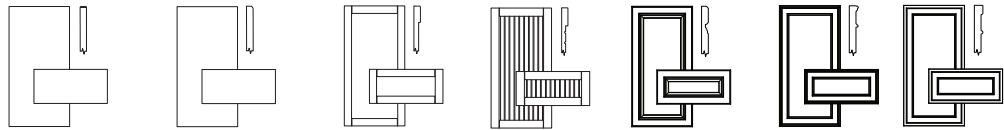

Description/Model	Delphine - D	Lia - L	Como - C	Azzano - A	Bassano - B	Elba - E	Rossano - R
TV Unit w/ 3 Drawers	TE1329N	2580	3028	3207	3271	3319	3429



TV Unit w/ 2 Doors and Shelf	TE2329N	2312	2761	2938	3006	3053	3162	3162
------------------------------	---------	------	------	------	------	------	------	------



DIMENSIONS

	Overall Width	Overall Depth	Overall Height	Shipping Weight	Cubes
TE1329N	31.25	19.75	70	232	28
TE2329N	31.25	19.75	70	209	28

ORDERING NOTES: Inside space for TV units is approximately 29" wide x 17" deep x 23" high.

REQUIRED TO SPECIFY

1. **Model number** (above)
2. **Front Style** (above)
3. **Base Rail** (page 523)
4. **Pull Style** (page 523)
5. **Case Color** (page 523 note color selection)
6. **Options** (below)

TREVISA TV UNIT OPTIONS

LIST

LIST

Locking Top Drawer or Door - LK	48	Laminate Drawer - DR	N/C
Pull-out Swivel TV Tray - SW	309	Master Key - MK	40
Crown Molding 2 door- CM	444		

MODEL CODE KEY

Product Line	Description	Style	Width	Base Style	Orientation (hinge side when facing cabinet)
T	E	1	32	9	N
Units without Legs	TV Unit	3 Drawers		no legs or casters	Not Applicable
		2			
		2 Doors & Shelf			

FRONT STYLES

Delphine front is laminate. All others are thermoformed vinyl.

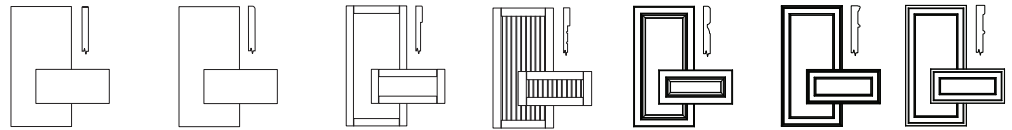

Description/Model	Delphine - D	Lia - L	Como - C	Azzano - A	Bassano - B	Elba - E	Rossano - R
TV Unit w/ 3 Drawers and Pocket Doors	TE3329N	4468	5028	5248	5334	5391	5530

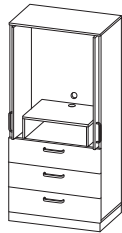

TV Unit w/ 2 Doors, adjustable shelf and Pocket Doors	TE4329N	3953	4518	4736	4819	4874	5013	5013
---	---------	------	------	------	------	------	------	------

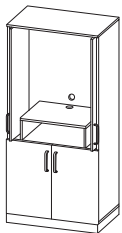

DIMENSIONS

	Overall Width	Overall Depth	Overall Height	Shipping Weight	Cubes
TE1329N	31.25	19.75	70	232	28
TE2329N	31.25	19.75	70	209	28

ORDERING NOTES: Inside space for TV units is approximately 29" wide x 17" deep x 23" high.

REQUIRED TO SPECIFY

1. **Model number** (above)
2. **Front Style** (above)
3. **Base Rail** (page 523)
4. **Pull Style** (page 523)
5. **Case Color** (page 523 note color selection)
6. **Options** (below)

TREVISA TV UNIT OPTIONS

	LIST	LIST
Locking Top Drawer or Door - LK	48	Laminate Drawer - DR
Pull-out Swivel TV Tray - SW	309	Master Key - MK
Crown Molding 2 door- CM	444	N/C
		40

MODEL CODE KEY

Product Line	Description	Style	Width	Base Style	Orientation (hinge side when facing cabinet)
T	E	3	32	9	N
Units without Legs	TV Unit	3 Drawers		no legs or casters	Not Applicable
		4			
		2 Doors & Shelf			

TREVISA | BOOKCASES

Description/Model		Price
Bookcase w/ 1 Fixed Shelf	TS1329N	576

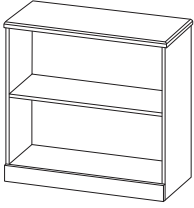

Bookcase Top for 32" Dresser	TS2309N	552
---------------------------------	---------	-----

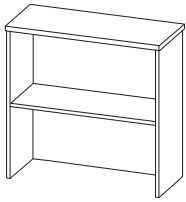

Bookcase Top for 48" Desk	TS3489N	689
------------------------------	---------	-----

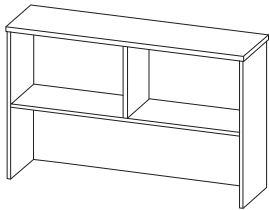

ORDERING NOTE: TS2309N & TS3489N units require wall support or have the back fastened to another case for support.

DIMENSIONS

	Overall Width	Overall Depth	Overall Height	Shipping Weight	Cubes
TS1329N	31.25	12	30	65	8
TS2309N	29.75	10	31.4	50	6
TS3489N	46	10	31.4	75	9

REQUIRED TO SPECIFY

1. Model number
2. Base Rail – TS1329N only (page 523)
3. Top Material – TS1329N only (below)
4. Top Edge Profile – TS1329N only (page 523)
5. Top Color – TS1329N only (page 523)
6. Body Color (page 523)
7. Options (below)

TOP MATERIALS: (page 7)

LIST

Laminate W/ Polymer Edge	- L (with Edge Profile A)	N/C
HP Laminate W/ Polymer Edge	- P (with Edge Profile A)	35
Seamless Thermoformed Vinyl	- B - G (with Edge Profiles B - G)	78

OPTIONS

LIST

Crown Molding - CM	
TS2309N	287
TS3489N	313
Extended Top Overhang - EX	
TS1329N	N/C

FRONT STYLES

Delphine front is laminate. All others are thermoformed vinyl.

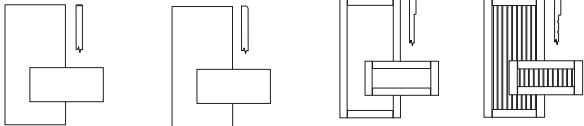

Description/Model	Delphine - D	Lia - L	Como - C	Azzano -A
Desk Shell	TK1489N	669	N/A	

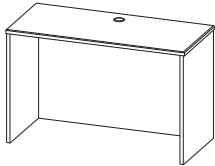

Desk w/ 1 Drawer	TK2489N	897	911	916	917
---------------------	---------	-----	-----	-----	-----

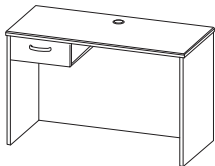

DIMENSIONS

	Overall Width	Overall Depth	Overall Height	Shipping Weight	Cubes
TK1489N	47.25	19.75	30	101	18
TK2489N	47.25	19.75	30	112	18

The dimensions above apply to codes starting with "T" as well.

REQUIRED TO SPECIFY

1. Model number (above)
2. Top Material/Top Edge Profile (below)
3. Front Style (above)
4. Pull Style (page 523)
5. Top Color (page 523 note color selection)
6. Case Color (page 523 note color selection)
7. Options (below)

TOP MATERIALS: (page 7)

	LIST
Laminate W/ Polymer Edge - L (with Edge Profile A)	N/C
HP Laminate W/ Polymer Edge - P (with Edge Profile A)	82
Seamless Thermoformed Vinyl - B or C (with Edge Profiles B or C)	186

DESK OPTIONS

LIST

Locking Top Drawer or Door - LK	48
Laminate Drawer - DR	N/C
Extended Top Overhang - EX	N/C
Master Key - MK	40

MODEL CODE KEY

Product Line	Description	Style	Width	Base Style	Orientation (hinge side when facing cabinet)
T	K	1	48	9	N
Units without Legs	Desk	Shell		no legs or casters	Not Applicable
		2			
		1 Drawer			

TREVISA | HEADBOARD/FOOTBOARD, MARKERBOARD, MIRROR & CORKBOARD

Description/Model	Price	Overall Width	Overall Depth	Overall Height	Shipping Weight	Cubes
Headboard TF1369N	427	36	0.75	22	17	1

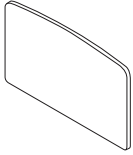

Footboard TF2369N	334	36	0.75	16	13	0.75
-------------------	-----	----	------	----	----	------

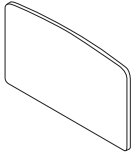

Mounting Legs (2) TF3029N	224	2.375	0.75	30	3	0.25
---------------------------	-----	-------	------	----	---	------



ORDERING NOTES: Legs are used to attach a headboard to a bed frame. Mounting Legs are solid maple in a clear finish. Hardware is not included.

Wall Mount Markerboard TMB209N	466	20	0.75	32	11	1.2
--------------------------------	-----	----	------	----	----	-----

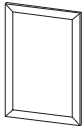

Wall Mount Mirror - Glass TGM209N	536	20	0.75	32	17	1.2
-----------------------------------	-----	----	------	----	----	-----

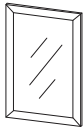

Wall Mount Corkboard TTB209N	466	20	0.75	32	9	1.2
------------------------------	-----	----	------	----	---	-----

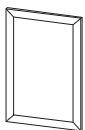

ORDERING NOTES:
Laminate frames are supplied around markerboards, mirrors, and corkboards.

Required to Specify:

1. Model number
2. Color (page 523)
3. Options (below)

HEADBOARD/FOOTBOARD OPTIONS \$LIST

Custom Cutout - CC -per headboard or footboard	\$129
---	-------

TREVISA | OVERBED TABLES - FEATURES & OPTIONS

Top Shape R is available in High-Pressure Laminate with Polymer Edges. Top Shapes K, C, and P are Seamless Thermoformed Vinyl and include a spill-guard edge as standard.

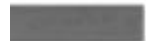

High-Pressure Laminate Edge



Seamless Thermoformed Vinyl with Spill-guard Edge

VINYL COLORS:



Champagne



Hardrock Maple



Copper



Shiraz Cherry



Gingerbread



Park Avenue Walnut

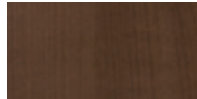

Chocolate

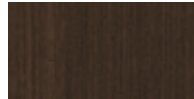

Nutmeg



Dark Walnut



Ash



Portobello



Willow



Platinum

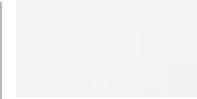

Designer White

BASE COLORS FOR OVERBED TABLES:

Select one:

S - Silver Metallic

G - Graphite

B- Black

A - Almond

N - Nevada

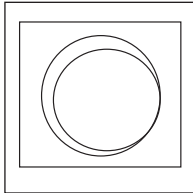

INTEGRATED SEAMLESS CUP HOLDER

The Integrated Seamless Cup Holder is available on the thermoformed vinyl tops. It is 3/8" deep and 2 1/2" in diameter. A drawing must be supplied to show the location. Two cup holders are standard on thermoformed vinyl tops when a dual top model is ordered.

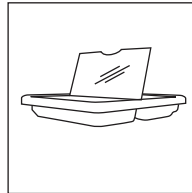

VANITY DRAWER AND MIRROR

Overbed tables have the option of a vanity drawer to store patients personal items. This drawer includes a mirror and is non-locking. Please include on the order.

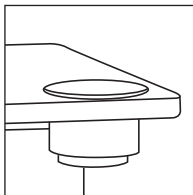

RECESSED CUP HOLDER

The Recessed cup holder is a molded flexible insert with an opening in the bottom. The inner dimensions are 3.5" diameter by 2.6" deep. It fits in a cut-out in the top. The opening is edge banded. A drawing must be supplied to show the required location.

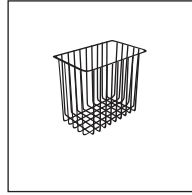

STORAGE BASKETS

Powder-coated wire brackets are available in 3 sizes - 9" x 9" x 10", 10" x 6" x 9" and 5" x 5" x 4".

TREVISA | OVERBED TABLES

TOP SHAPES

Rectangular
High-Pressure Laminate
with Polymer edges.

Kidney, Rectangular and Peanut
Seamless Thermoformed Vinyl.



Description/Model		Rectangular - R	Kidney - K	Rectangular - C	Peanut - P
Overbed Table w/ H - Base	TO1304N	1289	1319	1319	1319

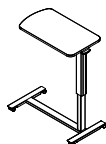

Overbed Table w/ U - Base	TO2304N	1289	1319	1319	1319
------------------------------	---------	------	------	------	------

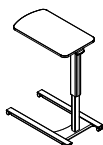

Dual Top Overbed Table w/ H - Base	TO3304N	n/a	n/a	2271	2271
--	---------	-----	-----	------	------



Dual Top Overbed Table w/ U - Base	TO4304N	n/a	n/a	2271	2271
--	---------	-----	-----	------	------



DIMENSIONS

	Overall Width	Overall Depth	Overall Height Range	Shipping Weight	Cubes
TO1304N	30	16	27/43	50	15
TO2304N	30	16	27/43	50	15
TO3304N	30	16	27/43	54	15
TO4304N	30	16	27/43	54	15

ORDERING NOTES: Cubes shown above are for 2 overbed tables per carton. The overall height of the U-base including casters is less than 2" and the H-base is 3.25"

REQUIRED TO SPECIFY

1. Model number (above)
2. Top Shape/Material (above - Kidney please choose left or Right facing)
5. Top Color (page 536 note color selection)
6. Base Color (page 536 note color selection)
7. Options (below)

OVERBED TABLE OPTIONS

	\$LIST
Vanity Drawer & Mirror - VM	357
-per headboard or footboard	
Storage Basket	
9" x 9" x 10" - B1	155
10" x 6" x 9" - B2	155
5" x 5" x 4" - B3	155
Integrated Seamless Cup Holder - IC	N/C
Recessed Cup Holder - RC	123

GENERAL INFORMATION

Terms and Conditions

Net 30 days on approved credit. A late payment charge of 1% per month will be applied on overdue invoices. This charge will be pro-rated to the number of days past 30 days that the invoice is overdue. All applicable sales taxes are extra. Distribution of this price list does not in itself constitute an offer to sell. Orders can be received only from authorized Krug dealers. Acceptance of any order and terms of sale may be established at the discretion of Krug. Deposits are required on orders received from new accounts as well as on large or special orders. Krug reserves the right to discontinue designs, or to change designs, construction, prices, or materials without notice.

Contact Information

Phone: 1.888.578.KRUG (5784) | Fax: 1.519.748.5177

Purchase Order Fax: 1.888.236.4783

Purchase Order E-mail: orders@krug.ca

Web: www.krug.ca E-mail: solutions@krug.ca

Customer Service Hours

Please note customer service hours are:

8:30 am to 5:00 pm est

Customer Satisfaction

It is the primary goal of Krug and our staff to ensure the complete satisfaction of our customers with our products and performance. If a problem arises with a Krug product after the expiration of the limited warranty period, Krug will exercise its best efforts to achieve the satisfaction of the customer in a manner that is fair to all concerned.

Order Acknowledgments

Each order will be acknowledged via e-mail or fax. This acknowledgment is the final agreement between Krug and the customer, superseding all previous communications regarding the purchase order. Where there is a discrepancy on a purchase order between a product code and a description, Krug will make every effort to resolve the discrepancy, but will be ruled by the product code ordered. Please check all acknowledgments for accuracy, and advise Krug of any discrepancies with a purchase order.

Order Cancellation

Krug reserves the right to not accept or allow cancellation of orders. All products are manufactured on a custom-made, make-to-order basis, and the purchasing, engineering and production of orders begins shortly after order placement - and the customer purchase order is a contract that authorizes Krug to manufacture the products. Acceptance of order cancellation (or partial cancellation) is solely at the discretion of Krug, and is dependent on the extent to which engineering, purchasing and manufacturing has been initiated by the time cancellation is requested. No order cancellations (partial or otherwise) are allowable more than 4 weeks from date of order placement (as order production is unable to be terminated by that point), and full payment of the acknowledged order value is required for any orders cancelled after 4 weeks. Cancellations may be allowable in less than 4 weeks after order placement, depending on the extent to which manufacturing has been initiated. An acceptance of order cancellation requires that the purchaser agrees to make payment for all costs incurred to the point of acceptance of cancellation. Cancellation charges include all costs for purchase of dedicated material and components, engineering costs for non-standard products, and all costs for manufacturing completed to that point, as well as a \$367 net charge for processing of the original order and for processing of cancellation invoicing.

Pricing

Krug endeavors to ensure that all prices in this price list reflect accurately our current prices. However, errors do occur and will be rectified through notices to the field. Krug reserves the right to acknowledge pricing that may be different from the price list.

Storage Charges

Krug reserves the right to assess a nominal storage charge if a customer does not accept shipment of an order within a week of the ship date.

Warranty

Krug warrants the construction and the finish of all our products to be free from defects in materials and workmanship for the lifetime of their use. This warranty is applicable to products in use by their original purchaser. This warranty does not apply to components not manufactured by Krug including textiles, which are subject to the specific warranties of those manufacturers, if any. Textiles (fabric, leather, vinyl, or any other covering material) suppliers do not guarantee their products for durability and color fastness, and nor does Krug. Casters, mechanical and electrical components have a warranty of five years from the date of purchase. The Krug warranty does not apply to COM-specified materials, damage caused by a carrier other than Krug, or variation in wood finishes due to natural wood color variation. Krug cannot be held responsible for variations in fabric dye lots from order to order. All fabric is carefully inspected when it is received, but a degree of variation in color should be expected. Repairs or replacement of any defect covered under this warranty by Krug will be made, at our option and method, at no charge to the original purchaser during the warranty period. Krug's judgement is final and binding with respect to the nature or cause of defects or damage, and the necessity or manner of repair or replacement.

This warranty does not apply to defects or damage resulting from:

- normal wear and tear occurring with the use of the product
- negligence, misuse, excessive use, alteration, improper cleaning or repair
- substitution or use of incorrect or unauthorized components or material
- handling or installation that is incorrect, or that causes damage or defect
- damage incurred by a freight carrier other than Krug
- wearing of finishes and fabrics, and normal variations in materials (including dye lot variations)
- properties of natural materials, including wood and leather
- exposure to environments with uncontrolled temperature and humidity (products must be transported, stored and used in climate-controlled conditions)

Note, specific warranties for components and materials not manufactured by Krug:

Jordan Sleepers Heavy-Duty Mechanism, made with heavy gauge steel and minimal moving parts - is backed by a 5-year warranty on the mechanism itself, in addition to the lifetime warranty on the rest of the product. If it does become damaged or degraded, the mechanism can be field-replaced.

Juno and Trevisa Overbed Tables have a 2-year warranty.

Blanket Wrapping

Krug will blanket wrap larger seating orders at customer's request. Please indicate on your purchase order and contact Customer Service.

Export Packaging

Krug is pleased to provide the option for export packaging on all our products, to provide additional protection from damage. For shipments overseas, a quote for export packaging can be provided, based on the products to be ordered and the delivery destination - please contact Customer Service or Bids & Specification Support for more information and a quotation. KRUG is not responsible for shipment damage occurring on overseas shipments

Export Packaging is STRONGLY RECOMMENDED for:

- (A) all shipments outside of the lower 48 states and Canada.
- (B) all shipments that will be held in storage for an extended period prior to installation.

Important: Please note that Krug will not be responsible for damage claims on product shipped or stored in the above conditions but where export packaging has not been utilized.

Dimensions

Dimensions are in inches and approximate, and subject to change without notice. Contact Customer Service if dimensions are critical.

GENERAL INFORMATION

Freight Terms and Conditions

1. All product is shipped FOB the Krug factory. Freight is either pre-paid to the destination or not pre-paid, depending on established customer specific freight terms.

2. Docks at the selected delivery location must be equipped to handle a 53' trailer. If a dock is inadequate for delivery by Krug, Krug will re-deliver to another local location and any additional costs will be charged to the customer.

3. For all deliveries, it is understood that Krug or its agent is making a dock delivery only (equipped to handle a 53' trailer), and any further work of truck unloading, delivery beyond the dock, installation, and removal of packaging is not authorized or paid for by Krug.

4. Drop shipments to the installation site, and timed deliveries, are available on larger shipments (full truckloads or slightly less) at no additional charge. Drop shipments or timed deliveries for smaller shipments may not be available, or if available will require a surcharge. Deliveries on an after hours basis, or on weekends, or any other special requirements, may be subject to a surcharge. Location and contact information, and the requested time of delivery, is required at least one week prior to the acknowledged shipment date. If this information is not provided one week in advance, or if the location or time of the drop shipment is changed less than one week in advance, a surcharge may be applied, and/or the drop shipment may not be scheduled. For deliveries requested Monday to Thursday after 5:00 pm, please apply a surcharge of \$262/shipment. For deliveries requested Monday to Friday before 7:00 am, please apply a surcharge of \$262/shipment. For deliveries requested Friday (after 3:00 pm) or weekends, please apply a surcharge of \$525/shipment. (local times).

5. For all deliveries - whether to the Customer location or drop shipment - any circumstances that result in the delay of our carrier (including unsuitable receiving facilities, or facilities not open or available), service charges will be applied at the rate of \$125/hour. Where re-delivery is necessary because of these circumstances, the full cost of re-delivery will be charged. If Less Than Truck Load is delivering, one hour is allocated to unload. Any additional time required to unload after the first hour is \$125/hour. If a Truck Load is delivering the order, three hours is allocated to unload. Any additional time required to unload is \$125/hour. Direct deliveries to site for large orders are possible, (must exceed \$60,000 net), and accommodate 48 - 53' trailers. Krug is responsible for delivery to the approved delivery address. If an address change is required, this must be authorized by Krug 5 business days prior to ship date. Any additional delivery costs incurred after this time will be charged to the customer.

Product Strength and Durability Testing

All Krug products have been thoroughly tested, and exceed the testing requirements of ANSI/BIFMA seating standard. Specific test results and documentation are available on request.



Installation Support

For assistance please contact Technical Support at 1-888-578-5784 x216 or e-mail installationhelp@krug.ca and you will be directed to the appropriate installation support person.

Damaged Shipments

All Krug product is well engineered, carefully inspected, and expertly loaded onto our trucks at our Distribution Center. If you receive any damaged freight, we ask that you do not refuse the shipment. Krug is not responsible for damage to goods that occurs in transit or

storage. It is the purchaser and/or receiver's responsibility to examine the goods upon receipt and to notify Krug of any damages, overages or shortages. Any discrepancies should be noted on the Bill of Lading. The delivering carrier will not accept responsibility for shortages or damages if signed "clear". Notification of concealed damage claims must be made to Krug Distribution within 5 days of delivery, along with digital pictures if available. All product and packaging must be available for inspection. Krug liability ceases after 5 business days and Krug will not be responsible for concealed damages if shipments are left unopened. Krug is not responsible for the condition of product that is stored or installed in an environment where temperature and humidity are not controlled.

Field Product Report Authorization

Krug's written authorization, in the form of an FPR number, must be obtained prior to incurring charges of any kind if Krug is expected to pay these charges. This includes authorization for returns, field repairs and replacements, post field repairs, installation and delivery charges. Krug reserves the right to have its representative inspect product related to any request for such authorizations, prior to that authorization being provided. Deductions from invoices paid for any charges to Krug, without prior written authorization in the form of an FPR, will not be accepted. Digital photographs may be required to complete the FPR process.

Returns

No merchandise may be returned without Krug's prior written consent. In the event of an authorized return, a Field Product Report (FPR) number will be issued, and a restocking charge will apply. Return transportation charges must be prepaid. Unauthorized returns will not be accepted and will be returned freight collect. All merchandise being returned must be properly packaged in its original or comparable replacement packaging to ensure protection of the product during handling and transportation. Returns on orders duplicated by the customer must be received in their original packaging to be accepted. Product being returned where Krug has authorized its liability for replacement or repair will be thoroughly inspected on its return, and the results compared to the reason for the return stated on the FPR. Any discrepancies, such as additional damage, signs of usage, missing parts, etc., will result in an adjustment to the amount of credit issued.

Custom Capabilities

Over 15% of our orders involve some type of custom work, and we invite our customers to make use of our extensive capabilities.

These include:

- 1) Dimensional customization of standard size products
- 2) Custom finishes
- 3) For larger orders, completely custom-designed products, as well as non-standard wood species can be specified.

Custom orders may require additional production lead times. Contact Engineering at the e-mail address engquotes@krug.ca.

Care and Maintenance Leather

Leather is a natural product and requires very little care during use. Most stains can be removed with a clean dry cloth. For stubborn spots and stains, use a mild non-detergent cleaner, rinse well and let air dry naturally. Do not use saddle soap, cleaning solvents, furniture polish, oils, varnish, abrasive cleaners, soaps or ammonia waters.

Fabric Upholstery

Professional upholstery cleaning is recommended.

Flammability Standards for Krug Textiles - Upholstery Program

- Passes State of California Technical Bulletin CAL 117-2013

Krug Textiles - Stocked Fabric Program

Grade 1

ARLO

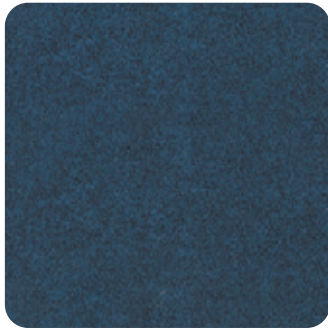

308 MIDNIGHT



306 PETROL



908 CHARCOAL



93 SEAL



601 PEARL



84 NUTMEG



62 OATMEAL



90 LIMESTONE

FRANKLIN



47 CAMEL



3009 MIDNIGHT



67 FAWN



97 CINDER



94 METAL



909 BLACK

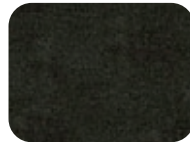

9004 CHARCOAL



308 PETROL



108 ORCHID

COMRADE

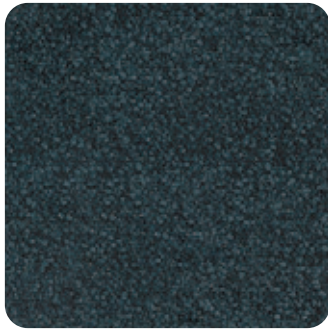

309 MIDNIGHT



84 TEAK



63 LINEN



24 ALPINE



905 IRON



601 SNOW



57 MARIGOLD

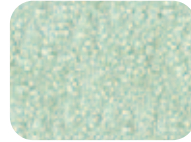

31 DUCK EGG

FELICITY



601 IVORY



305 SKY



603 TAUPE



93 COAL



405 HENNA



64 PUTTY



62 FAWN



36 BLUEBERRY

KRUG TEXTILES - UPHOLSTERY FABRICS



Krug Textiles - Stocked Fabric Program

Grade 2

GRADDY

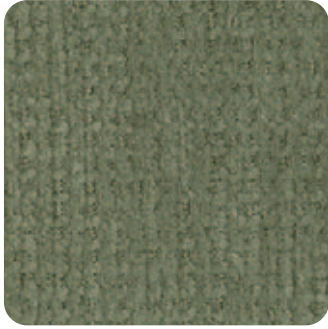

25 CAPER



31 SKY



604 FLAX



901 CHAR



93 GRAY



34 SLATE



84 TEAK



98 NICKLE

YATES



84 BIRCH



44 CLAY



87 TAUPE

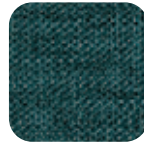

25 JUNIPER

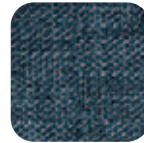

305 INDIGO

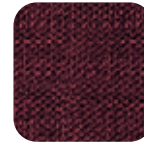

109 CRANBERRY



803 TOAST



92 ZINC



91 SILVER



908 CHARCOAL

MCCOY



608 TUNDRA



601 CREME



908 CHARCOAL



62 COPPER



108 CORDOVAN



32 ROBIN'S EGG



94 MERCURY



84 BARK

ORIS

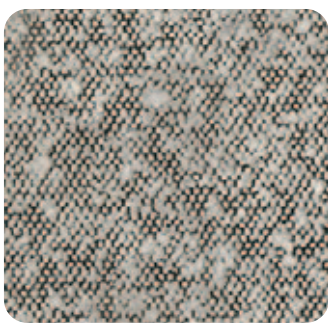

908 DOMINO



604 BARK



601 CREAM



306 DELFT



902 ZINC



305 MIDNIGHT



64 PUTTY

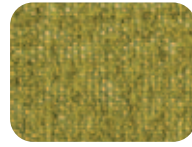

205 CHARTREUSE

Krug Textiles - Stocked Fabric Program

Grade 3

MORITZ



205 SPEARMINT

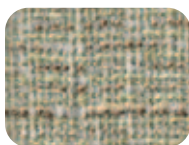

61 OYSTER



306 CADET



104 MULBERRY



31 AEGEAN



9008 CHARCOAL



82 CLAY



304 CAPRI

LORENZO



306 INDIGO



24 ALPINE



64 LINEN



91 FLANNEL



32 MIST

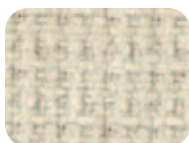

601 CREAM



106 HENNA



604 STUCCO

BISCOTTI



302 CAPRI



45 SPICE



61 DESERT



91 GRANITE

INTRIGUE



601 OYSTER



27 OLIVE



4003 OCHRE



908 CHARCOAL



3009 MIDNIGHT



805 PECAN



608 STUCCO



605 STRAW

KRUG TEXTILES - UPHOLSTERY FABRICS



Krug Textiles - Faux Leather Program - Grade 2



Krug Textiles - Leather Program - Grade 8

Please contact Customer Service for specific information on leathers, available colors and lead times.



Krug Textiles - Cut fabric NET price per yard

Grade 1	\$22
Grade 2	\$34
Grade 3	\$46

LATEX FREE

Krug products are made with latex-free materials to prevent the allergic reaction that latex causes in some people.

CUSTOMER'S OWN MATERIAL - C.O.M.

Customer's Own Material (COM/COL)

COM/COL must be received three weeks prior to the acknowledged ship date. Orders with COM/COL not received by the required deadline will be delayed. A description of the upholstery cover, including supplier name, pattern name, upholstery cover name and color number must be included with the purchase order.

COM/COL testing requires 3 business days and samples are to be directed to Customer Service. The customer has the option of providing the sample COM/COL before, at time of order, or once the sample COM/COL is received. If the customer does not send a sample for approval in advance of sending actual material, Krug will not be responsible for the cost of any upholstery cover or other material that it determines to be unsuitable for the product or our process.

When the COM/COL upholstery cover is received at Krug, it must be clearly identified with the upholstery cover name and color, and tagged with name of the Krug customer and purchase order number. Krug will inspect all COM/COL upholstery covers when received to determine if it will be suitable for upholstery. Where Krug feels that the upholstery cover or leather specified will compromise the quality or integrity of our products, customers will be contacted to direct these concerns. Further, Krug reserves the right to refuse to accept and use any COM upholstery covers or leathers that will compromise our products in any way that is unacceptable to Krug. Krug cannot assume responsibility for the durability or tailoring quality of customer's own material.

Yardage specified in this price guide is approximate. In the case of multiple product orders, multiply the number of items by the COM yardage specified to determine upholstery cover required, unless otherwise indicated. Additional yardage may be needed if the material is less than 54" wide, or patterned or striped and requires matching. All COMs are cut "up the roll" unless otherwise stated by the customer. All striped upholstery covers will be applied vertically unless otherwise stated by the customer and after approval by Krug. Krug will not be responsible for directional or positional problems with its application of COM material, unless it has been provided with explicit instructions by the customer. Special instructions should be sent to Krug Customer Service, including a sample (or photocopy) of the upholstery cover. Krug is not responsible for instructions sent with the upholstery cover rolls, or for the method of upholstery if no instructions have been provided.

Price increases and freight charges to COM/COL acquired on the customer's behalf will be passed onto the customer.

Application of Directional Upholstery cover

Some COM upholstery covers will be considered directional by Krug even though they are not considered directional by the supplier. All COMs are automatically cut "up the roll" unless otherwise stated by the customer (please see below).



Standard-Cut
"up the roll"



Non-Standard-Cut
across the roll "railroad"

COM/COL Shipping Procedures

For seating COM/COL upholstery covers, please send upholstery covers to:

Krug Inc.
111 Ahrens Street
Kitchener, Ontario
Canada N2H 4C2

Attention: RECEIVER

COM/COL orders cannot be scheduled into production until the upholstery cover has arrived and inspection is complete.

All packages must be clearly marked

"For Customs Clearance by Willson International Custom Brokers".

According to the North American Free Trade Agreement (NAFTA), goods shipped between the United States and Canada can qualify for exemption from all duties, or for a reduction in duties, if the goods can be proven to originate in either the United States, Canada or Mexico.

Canada Customs requires that a NAFTA Certificate of Origin and a Commercial Invoice be completed and sent with the upholstery cover shipment. The Commercial Invoice must clearly state the description of the upholstery cover, the selling price, the make-up or content, and the purchaser. The absence of these two documents will delay the shipments at the U.S./Canada border, thereby potentially delaying the customer order. If the total value of the shipment is less than \$1200 U.S., Customs will accept a Low Value Statement of Origin in place of the NAFTA Certificate of Origin. The Low Value Statement must be signed by a representative of the exporting company. This statement may either be included on the commercial invoice or attached to the invoice. Krug is happy to answer any questions or concerns about COM/COL shipping procedures and the required documents.

CAL 133 & Moisture Barrier

California Technical Bulletin 133 is a flammability test for seating. Krug offers a compliance method which, in combination with non-flammable upholstery covers, may enable the products to meet certification requirements for this test. This process at the same time also provides the products with a Moisture Barrier - a treatment that helps to prevent the passage of liquids and moisture to inside of upholstered components - thereby conferring sanitary and anti-infection benefits. So when CAL 133 is specified, the product also automatically has a Moisture Barrier, and when a Moisture Barrier is specified, the product also features the compliance method and low flammability features of CAL 133.

The application of this upcharge and the compliance method does not mean that the specific configuration of product and upholstery cover are tested and officially certified as being CAL 133 compliant. If official certification is required, Krug will provide this (through an independent certified testing laboratory) at a charge of \$917 per item, plus the cost of the product to be tested. Lead time for certification testing is typically 4-8 weeks. Krug assumes no responsibility for the testing of our products in combination with upholstery covers, or for the results of any testing conducted. Some specific configurations of product and upholstery have already been tested. Please contact Customer Service for additional information.

C.O.L. Yardage

To calculate C.O.L. yardage required, please use the following conversions based on COM yardage: Leather must be ordered in square footage.

- 17 square feet in a yard
- Approx. 3 yards in a hide
- Approx. 51 square feet in a hide
- Please use grade 3 pricing for COL

Upholstery Cover Yardage Calculation

To calculate yardage required for COM and other non-standard upholstery cover orders, please contact Krug Customer Service at 1.888.578.5784. Unless otherwise stated, upholstery cover rolls are assumed to be a minimum 54" wide. Please use the guide below to calculate the percentage of extra upholstery cover required to cover large repeats. The repeat is calculated by adding both the vertical and horizontal measurements together and then referring to the chart below for extra yardage required.

		2"-14"	15"-19"	20"-27"	28"-36"
FABRIC	Plain	Repeat	Repeat	Repeat	Repeat
54	0%	10%	15%	20%	25%
53-50	16%	20%	25%	30%	35%
48	16%	25%	30%	35%	40%
45	40%	50%	55%	60%	65%
36	50%	60%	65%	70%	75%

GRADED-IN UPHOLSTERY PROGRAMS

Krug has partnered with several textile brands to grade in their offerings, designed to provide a wide range of upholstery selections for our seating products.

Upholstery pricing and availability is subject to change without notice. We grade this upholstery according to the pricing of the fabric suppliers - when their pricing changes, the Krug grade may change.

When placing an order, a Krug customer must specify the complete upholstery number, along with the appropriate Krug model number and finish. Krug will supply the complete product at the prices listed. Orders specifying graded-in upholstery cannot be cancelled once the upholstery has been ordered.

Upholstery Grades

To determine the price of a product for graded-in upholstery, use the reference lists located on Krug's website under - Products - Textiles, to view the upholstery grade (1-9). Krug is not responsible for the discontinuation of this upholstery. Please contact Customer Service for information on upholstery not listed.

When two upholstery selections are specified for use on seating, the higher grade upholstery price will apply to the order.

High Performance upholstery; Polyurethane, Vinyl or Crypton, is particularly suitable for healthcare and other intensive-use environments.

Upholstery Samples

If you require additional samples or memos for presentation, please contact fabric supplier directly.

Flammability Standards

- Tunnel Test Surface Ratings Class A rating
- Class 1 UFAC
- Passes State of California Technical Bulletin CAL 117-2013

Please contact fabric supplier directly for further flammability information pertaining to specific upholstery.

Special Conditions

Acknowledgments will give the estimated delivery date of the finished product. Some upholstery is imported, and availability may affect estimated delivery time. For large projects, please contact fabric supplier directly for availability of yardage.

KRUG EXPRESS PROGRAM

PROGRAM DETAILS

KrugExpress orders are ready to ship by the date acknowledged. Delivery and shipping schedules may result in actual shipping of orders at a later date. Statutory holidays and scheduled factory vacations may add to acknowledged lead times of *KrugExpress* orders. Unless otherwise specified on the order, the customer's standard method of shipping Krug products will be utilized.

Available factory capacity for *KrugExpress* is filled by orders received on a "first come, first serve" basis. If the normal *KrugExpress* lead time is not available for your order because available capacity has been filled, you will be immediately advised of the earliest available ready-to-ship date. Please consult your Customer Service representative in advance if you wish to confirm the specific lead time availability for a *KrugExpress* order.

Orders must be received by midnight of a given day for that day to be considered the official day the order is received. Order lead times are acknowledged from the date the order is received, but not including the date the order is received.

KrugExpress orders must be "clean" when received in order to be considered officially received on a given day, and lead times will be acknowledged from the date orders are determined to be "clean".

Changes to *KrugExpress* orders are not allowed under any circumstances.

Orders for product on *KrugExpress* must clearly state: "*KrugExpress*".

COM and graded-in upholstery is available on Krug Express. Orders are scheduled on Krug Express, and given the best available date, when the upholstery is received at Krug. Some conditions apply.

SEATING & OCCASIONAL TABLES PROGRAM

Orders for seating products on the *KrugExpress* program may be subject to quantity maximums. Please contact Krug Customer Service for more information.

Quantity maximums are dependent upon available capacity, in order to insure that we ship all orders on time. Please note that the CAL 133 option is not available on *KrugExpress*.

Only standard wood finishes are available for *KrugExpress* orders. Laminates are not available on *KrugExpress*.

Krug Express includes all Krug seating and occasional tables as well as Krug conference and casegood products to complement this seating offering.

WOOD FINISHES

Standard wood finishes are:

Finishes on Beech

Appalachian Cherry
American Cherry
Imperial Cherry
Light Cherry
Medium Cherry
Natural Cherry
Sable Cherry
Standard Cherry
Light Oak
Harvest Oak
Mahogany
Mellow Oak
Espresso
Cordovan Walnut
Natural Walnut
Regular Walnut
SilverGrey on Walnut
Dark Walnut
Clear Beech
Medium Anigre

Finishes on Maple

Clear Maple
Honey Maple
Wheat Maple

PALETTE

Palette finishes available for applicable products.

Black
White
Soft Green
Steel Blue
Slate

WOOD FINISHES TO MATCH STANDARD LAMINATES

Willow on Beech
Copper on Beech
Shiraz Cherry on Beech
Park Avenue Walnut on Beech
Chocolate on Beech
Nutmeg on Beech
Portobello on Beech
Ash on Beech
Dune on Maple

NATURAL CHARACTERISTICS OF WOOD

Wood is a natural product with inherent color variations that will never be fully mitigated by the finishing process. Please anticipate variation in colors within a single unit, from piece to piece, and from Krug wood finish samples. If a very close match is required, a sample must be provided with the order and an upcharge will apply. Exact color matches are not possible.

Custom Wood Finishes

Add 10% list to your order for special finishes, minimum upcharge is \$525 list per finish per order. (For example, on all orders up to \$5250 list, an upcharge of \$525 will apply, on orders \$5000 and up add 10% list to your order.)

Special finish upcharges on seating products are calculated on a grade 1 value. For orders with special finishes, a sample that is a minimum 3" by 3" must be received with the order. Special finishes may add additional lead time to production schedules. Since wood is a natural product, some variations in grain, color and stain acceptance will occur. In our finishing processes, we try to minimize variations, but some variation between samples and finished goods should be anticipated.

Dual Finishes

Add 10% list per item if specifying dual finish.

Standard Wood Finishes

No upcharge will be applied when specifying a finish available as standard on one species onto maple seating and occasional tables. Clear finishes are not available on other species since they are a clear finish on top of the natural veneer color.

LAMINATE PROGRAM

LAMINATES

Krug's in-stock Laminates are available in 17 different laminate selections. Please note that 4 of the colors (Gingerbread, Portobello, Ash and Willow) have textured finishes and may not be appropriate for use in patient areas due to infection control concerns. Minimum order quantities and extended lead times may apply for exotic laminate colors, please check with customer service. Polymer Edge will be selected to match the worksurface. Krug's previous laminate in-stock program will be phased out as in-stock supply depletes. Please contact customer service for availability.

IN-STOCK LAMINATES

Wood Grain Laminates	High Pressure Laminate Supplier	Textured Wood Grain Laminates	High Pressure Laminate Supplier
Champagne	Tafisa T492CR	Gingerbread	Tafisa T556UR
Hardrock Maple	Formica 86992-58	Portobello	Tafisa T557UR
Dune	Tafisa T491CR	Ash	Tafisa T535AT
Copper	Tafisa T521CR	Willow	Tafisa T543AT
Shiraz Cherry	Tafisa T472CR	Solid Laminates	
Park Avenue Walnut	Wilsonart 7984-38	Designer White	Wilsonart D354-60
Chocolate	Tafisa T498CR	Platinum	Tafisa T202CR
Nutmeg	Tafisa T477CR	Earth	Tafisa T767CR
Dark Walnut	Tafisa T469CR	Charcoal	Tafisa T228CR

PHASE OUT LAMINATES

Almond - Black- Shadows - Edgewood Sycamore - Gunstock Walnut

Non-Stocked Laminates

For specific lead time and application questions, please contact Krug Customer Service for your requirement. Upcharges will be applicable for non-stocked laminates, depending on their cost. Non-stock laminates may require a minimum order quantity, please contact customer service. Stocked polymer edges only can be specified for use with non-stocked laminates or tops will be self-edged.

SOLID SURFACE PROGRAM

The Solid Surface option provides an enhanced durability, protection and cleanability. It is available in 8 standard colors and is replaceable if it becomes damaged or degraded. See individual products for list upcharge chart.

GROUP GRADE A - WHITE

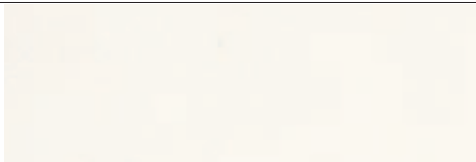

Glacier White



Cameo White

GROUP GRADE A - COLOR

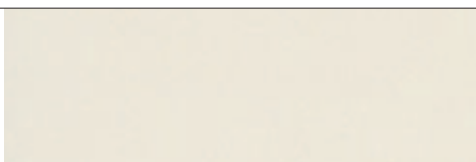

Bisque

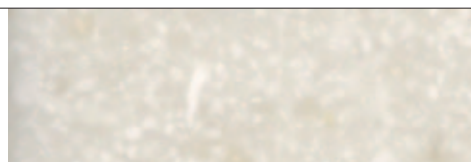

Linen

GROUP GRADE B

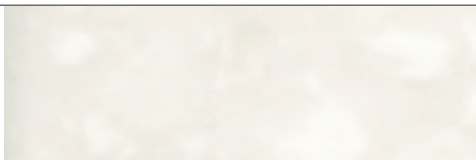

Antarctica



Savannah

GROUP GRADE C

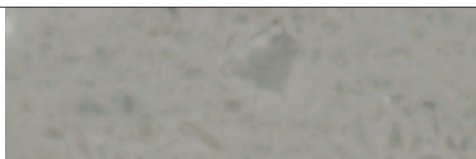

Dove

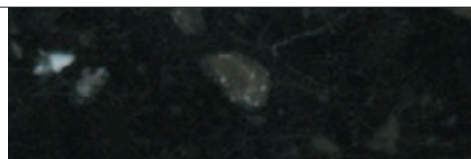

Deep Night Sky

VINYL COLORS



Note: For Overbed Table vinyl selection see page 540.

BASE STYLES

Base Styles	Description
Black Nylon	5 blade glass reinforced molded nylon base with 2 1/4" hooded dual wheel casters.
Polished Aluminum	5 blade polished cast aluminum base with 2 1/4" dual wheel casters (upcharge applies.)
Seat Slider	Seat slider mechanism featuring a 2" range of adjustment front to back when seated. The lever to activate this feature is located under the seat of the user's left side and is activated by a simple twist of the knob.
Wood	5 blade steel bar stock base with finished wood caps and 2" black hooded dual wheel casters.
Chrome	5 blade polished chrome base with 2 1/4" dual wheel casters.
Jury Bases	Jury Bases assembly consists of a black 9" diameter conical/cast base for permanently mounting a chair to the floor. Into the base is inserted a black pneumatic gas cylinder with self returning action from rotation, and self returning height feature when exiting the chair. Allows for full 360 degree rotation. Limited degrees of rotation are not available.
Jury Bases	

Pan Am
Pan1-M11J



Bank of England
177-J



Dorso
D0S1-H2011J



Cadence
CAD1-HW12J



C5
C5E1MB41AJ



Aqua
AQU1M33J





All products are air emissions certified and are available as FSC® certified

krug

solutions@krug.ca | www.krug.ca | 1.888.578.KRUG