

JUNO
Price and Specification Guide
USA

vizient[™]



Effective July 10, 2023

JUNO | TABLE OF CONTENTS

JUNO CASEGOODS

2	Juno LEED Credit Summary
3	Juno & Trevisa Headwalls & Footwalls
4	Juno Features & Options
7	Juno Specifying
9	Juno Bedside Tables
12	Juno Dressers
13	Juno Benches
14	Juno Wardrobe Combinations
15	Juno Wardrobes & Storage
19	Juno TV Units
21	Juno Bookcases
22	Juno Desks
23	Juno Headboards & Footboards
23	Juno Markerboard, Mirror & Corkboard
24	Juno Overbed Tables

GENERAL INFORMATION

26	Terms & Conditions
26	Warranty
28	Wood Finishes
28	Standard Laminates
29	Solid Surface Program
30	KRUG Textiles - Upholstery Fabrics
32	KRUG Textiles - Leather & Faux Leather
34	Customer's Own Material (COM/COL)
34	CAL 133 & Moisture Barrier
35	Graded-In Upholstery Programs
35	<i>KRUGEXPRESS</i> Program

JUNO | LEED CI CREDIT SUMMARY



MATERIAL CONTENT:

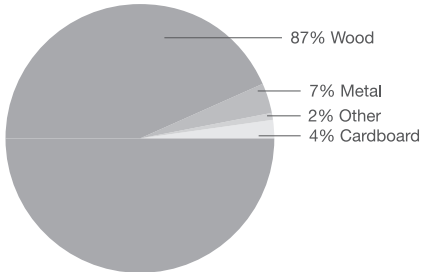

PRE-CONSUMER RECYCLED CONTENT = 88%

POST-CONSUMER RECYCLE CONTENT = 5%

CONTRIBUTES TO

CREDIT 2.1 - 2.2	Construction Waste Management	1-2 point(s)
CREDIT 3.3	Resource Reuse	1 point
CREDIT 4.1	Recycled Content	1 point
CREDIT 4.2	Recycled Content	1 point
CREDIT 4.4	Low Emitting Materials	1 point
	Composite Wood & Laminate Adhesives	1 point
CREDIT 5.1	Regional Materials*	1 point
CREDIT 7	Certified Wood (PLEASE ENQUIRE)	1 point

* This credit is only applicable if in total 20% of the combined value of the procured construction materials and furniture is manufactured within a radius of 500 miles. This credit will apply if the installation of the finished product occurs within 500 miles of Toronto, Ontario.

JUNO & TREVISA | HEADWALLS AND FOOTWALLS

The Juno and Trevisa lines include a custom offering of modular headwalls and footwalls. The offering has been designed around 24", 30" and 36" wide modules that include a back panel, canopy (1 1/2" thick) and cabinets. The overall height is 82". Cabinet height can be 20" (e.g. benches), 30" (e.g. bedsides, dressers and desks) or 36" (e.g. work counters, possibly including a sinks). The cabinets can be taken with slight modification from the Juno and Trevisa offerings of bedside tables, benches, dressers, desks, wardrobes and storage units. As well, other items such as floating shelves can be incorporated. In each case, the cabinet sits on a substantial 4" inset base. Bases are typically in grey laminate. Some combinations of the modules can be freestanding while others need to be fastened to the wall.

Fronts, top profiles and pulls from the Juno and Trevisa line can be incorporated into the headwall or footwall. The tops are only profiled on the front and there is no overhang at the sides. Tops can be laminate, high-pressure laminate, thermoformed vinyl or solid surface.

The modules are designed to accommodate wiring for lighting, TVs and to support other electrical devices such as computers. Similarly, there is space for plumbing.

Advantages of modular footwalls and headwalls may include improved depreciation for tax purposes, the ability to reconfigure at some future point, replaceability of individual components and even individual panels, consistency of design, colors and pulls with freestanding cabinets in the room, and the fact that design and construction meets the same healthcare standards reflected in the balance of the Juno and Trevisa lines. A limited lifetime warranty applies.

Please contact your Krug representative or customer service for a quotation on your specific project. The following are sample project configurations and associated list prices.

Headwalls

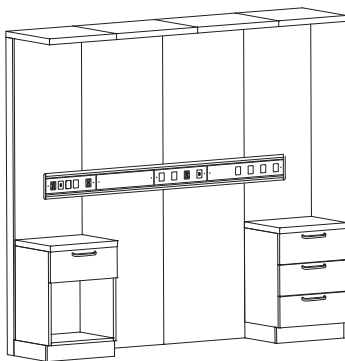

Total List \$7,589

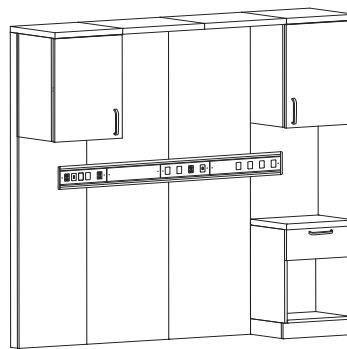

Total List \$7,700

Footwalls

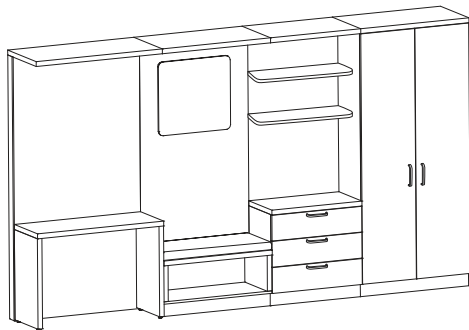

Total List \$10,729

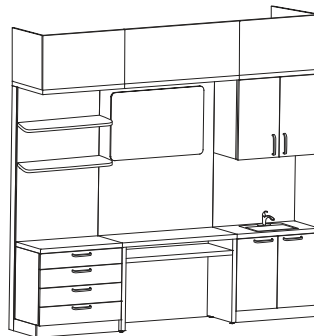

Total List \$10,099

Consultation Station

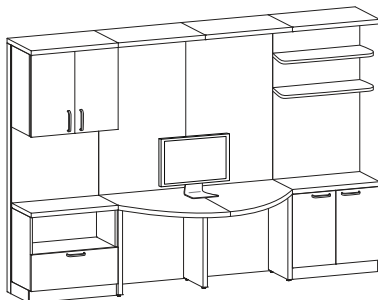

Total List \$10,296

Quiet Area

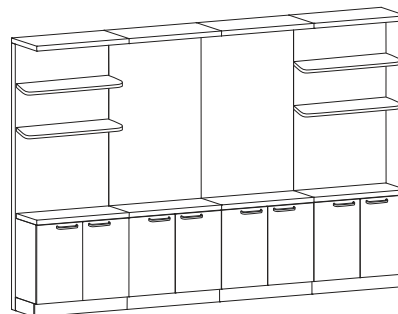

Total List \$10,443

JUNO | FEATURES & OPTIONS

BREADTH OF LINE:

The healthcare casegoods lines offer solutions from contemporary to transitional to traditional styling. Juno is the contemporary version. The lines are extremely wide including 5 bedside table configurations, 3 dressers, 2 benches, 2 combination bench/wardrobes, 8 wardrobe/storage units, 4 TV units, 3 bookcases, 2 desks, a headboard and footboard, a marker board, mirror and corkboard, and 4 overbed tables. In addition custom modular headwalls and footwalls are offered.



CUSTOM CAPABILITY:

Krug can offer both custom sizes of standard product and completely custom units, including modular headwalls and footwalls. For more information, please contact Customer Service.

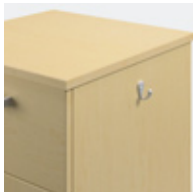

DURABILITY:

Cabinets are constructed of 3/4" thick panels including backs. In contrast to cabinets constructed with 1/8" back panels, the Juno units are more robust and less susceptible to damage. All exposed laminate edges are covered with 2.5 mm polymer edge banding in colors matching the laminates. This thicker edge banding provides an increased level of durability on all edges as well as a 2.5 mm radius on the edge. The softer radius is less likely to bruise or cut the skin of a patient or caregiver. Bottom panels extend under the side and back panels of cabinets with legs and on any units with 4 casters in order to maximize the ability of the cabinet to withstand heavy handling.



DRY FIT CONSTRUCTION:

Cabinets are assembled with mechanical cams. This is known as dry fit construction. The result is that any panel can be replaced if damaged, unlike in the case of cabinets that are glued together where damage to any surface leads to replacement of the entire unit.

VENTS:

There is one 1" diameter vent for each drawer and each door set for air circulation. All vent holes are covered with plastic vents both inside and outside to eliminate exposed particle board, thus preventing moisture and bacteria from entering the core.



SEALED CORE

All unseen particle board edges that are not covered by an adjoining panel are edge banded (i.e. no exposed particle board). As with the vent covers noted above, this prevents moisture and bacteria from seeping into the core.

DRAWERS:

Drawers have white metal sides with white laminate bottoms and backs, and all exposed particle board edges are edge banded. The unobstructed metal sides facilitate cleaning. Bumpers are installed on all drawers and doors to soften the sound of closing.



ENVIRONMENTAL

Juno cabinets have a very high recycled content and contribute to both LEED credits 4.1 and 4.2. The packaging is recyclable. Non-urea-added core is available as an option and Air Emissions certified product is also optionally available. FSC-certified wood may be possible on larger projects.

JUNO | FEATURES & OPTIONS



TOPS:

Tops are 3/4" thick and can be laminate with polymer edge banding, high-pressure laminate with polymer edge banding, or seamless thermoformed vinyl.

- Edge A - Laminate with Polymer Edge, or High-Pressure Laminate with Polymer Edge
- Edge B - Thermoformed Vinyl or High-Pressure Laminate with Wood Edge
- Edge C - Thermoformed Vinyl or High-Pressure Laminate with Wood Edge
- Edge S - Laminate with T-Mold bumper or High-Pressure Laminate with T-Mold bumper

With Edge S the Overhang is 1/2" on all sides

Standard Top Overhang is 1/4" on 4 sides

Optional Top Overhang is 1/2" on 4 sides (to assist with movement of the cabinet) on other edges.

Tops on units over 40" high are laminate only



DOOR / DRAWER FRONTS:

Door / drawer fronts are 3/4" thick and 2 styles are available.

- Delphine - Laminate with Polymer Edge
- Lia - Thermoformed Vinyl

Headboards and footboards are high-pressure laminate on 3/4" plywood with polymer edge banding. HPL and plywood are used in this application for added strength.



LEGS & BASE RAIL:

Cabinets are available with 4 1/4" legs (for ease of cleaning), or sides to the floor with a base-plate Style 1 that is either Laminate with Polymer Edge, or Seamless Thermoformed Vinyl, (based on the Door/Drawer front material selected).



DOOR AND DRAWER PULL STYLES:

Flex is an injection-molded plastic pull designed to offer some "give" or flexibility when inadvertently hit by a patient or caregiver. The color is similar to Silver Metallic.

The Circa offers a very large grip. The pull could be accessed with a closed knuckle. It has a Silver Metallic finish.

The Indus pull eliminates a protrusion that could bruise a patient or caregiver. The finish is Silver Metallic.



BENCH

The cushion for the bench is 3" thick.

Juno benches have a load weight rating of 200 lbs.



OVERBED TABLES:

There are 4 overbed table top shapes in either high-pressure laminate or seamless thermoformed vinyl, with 3 edge profiles (2 are spill-guard edges). There is also a version with a second drop-down surface. The overbed table offering includes 2 alternative steel base styles, each available in 5 standard powdercoat finishes. The overall height of the U-base including casters is less than 2" and the H-base is 3.25".

Baskets are a frequently ordered option. They are commonly used to hold urinals to keep them off table surfaces.

LAMINATES:

"Laminate" is variously known in the marketplace as Thermofused Melamine, Low-Pressure Laminate or LPL.

There are 1 solid color options and 5 wood-grain colors. All colors are available in laminate, high-pressure laminate or thermoformed vinyl. Polymer Edge banding matches the laminate selection. Wood finishes to match the wood-grain laminates are available for Krug Healthcare Seating.

VENEER

Many items in the Juno product line are also available in maple veneer and in a combination of veneer exterior surfaces and laminate interior faces. The veneered version is available with the Delphine front and "A" top edge profile. Both high-pressure laminate and thermoformed vinyl tops can be supplied as options with the veneered cabinets. Please contact your Krug representative or customer service for a quotation on veneered product.

WARRANTY

All cabinets carry a limited lifetime warranty. Overbed tables have a 2-year warranty.

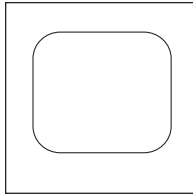

ROUNDED TOPS

A top with rounded corners is available as an option on bedside tables. There is a choice of laminate or high pressure laminate. The edge is polymer to match the laminate color. The overhang is 3/4" on all 4 sides of the top. (Tops specified with T-mold bumper are also rounded at corners. In these cases the overhang is 1/2" on all sides).

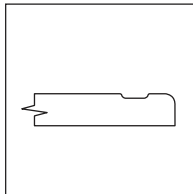

SPILL-GUARD EDGE

Juno bedside tables are available with the spill-guard edge surface on the thermoformed vinyl tops to collect liquids when spills occur.

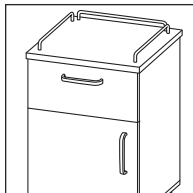

GALLERY RAILS

Optional gallery rails are in satin nickel finish. There is a rail on each side and another across the back.

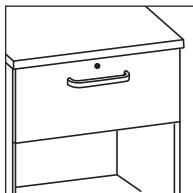

LOCKING TOP DRAWER OR DOOR

Juno cabinets have the option to lock. They can be randomly keyed for security. The lock option is factory installed and must be specified on the order.

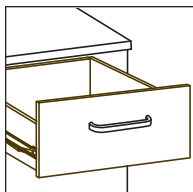

LAMINATE DRAWER

An optional white laminate drawer with a single-action 3/4-extension slide is available at no upcharge. All edges are banded.

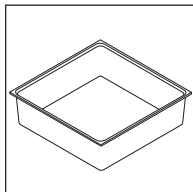

SEAMLESS DRAWER LINER

Juno bedside tables are available with the option of a plastic drawer liner. Ideal for infection control purposes, it can be removed, sterilized or replaced when damaged or degraded.

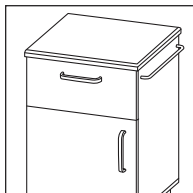

TOWEL BAR

The Towel Bar option fastens to the sides of the bedside tables. It is available in a satin nickel finish. The standard placement is the side opposite the hinge.

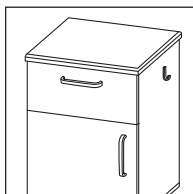

LITTER BAG HOLDER

The Litter Bag Holder option fastens to the sides of the bedside tables. It is available in a satin nickel finish. It holds small paper bags and can be field-installed. The standard placement is the side opposite the hinge.

MASTER KEY

Juno bedside tables have the option to lock with a master key. This must be specified on the order.

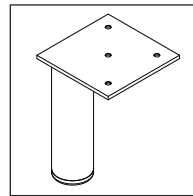

LEG / CASTERS:

Juno Bedside Tables have 5 base options - 4 legs with glides, 2 front legs with glides and 2 back casters, 4 swivel casters (2 locking), no legs and adjustable glides, or no legs and 2 hidden non-swivel casters at the rear of the cabinet.

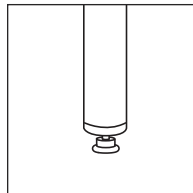
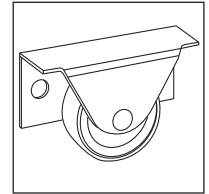
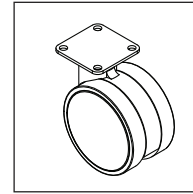
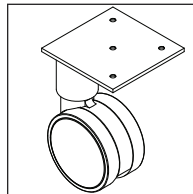

LEG LEVELER

An adjustable glide option is available for legs when there are 4 legs on a cabinet. This is standard on units without legs. This helps ensure the furniture is steady and level on uneven floors.

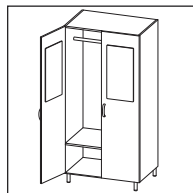

CABINET MOUNT MARKERBOARD

The Markerboards are 24" high by 12" wide. They can be mounted to the inside or outside of the cabinet door (inside is standard).

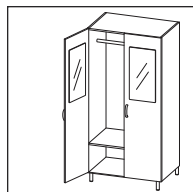

CABINET MOUNT MIRROR OPTION

The Mirrors are 24" high by 12" wide and acrylic. They can be mounted to the inside or outside of the cabinet door (inside is standard).

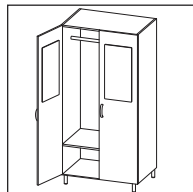

CABINET MOUNT CORKBOARD OPTION

The Corkboards are 24" high by 12" wide. They can be mounted to the inside or outside of the cabinet door (inside is standard).

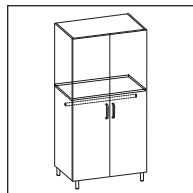

LOWER MOUNTING COAT ROD AND SHELF (ADA)

Juno Wardrobes are available with the lower shelf and coat rod for ADA compliance (shelf is 48" above the floor).

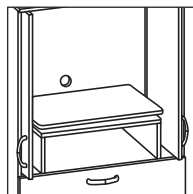

PULL-OUT SWIVEL TV TRAY

Juno TV Units come with the option of a pull-out swivel TV Tray. The swivel tray is factory installed and must be specified at the time of order.

EXTENDED TOP OVERHANG

Rather than the standard 1/4" top overhang on all sides, this can be at 1/2" to facilitate moving of the cabinet for cleaning.

JUNO | SPECIFYING

REQUIRED TO SPECIFY

After each product grouping in the following pages, there is a summary under the title “Required to Specify”. The summary lists the elements that need to be specified including Model Number, Top & Edge Profile, Pull Style and Color, Body Style and Color,

TOP EDGE PROFILES:

Select one:



Edge Profile A



Edge Profile B



Edge Profile C



Edge Profile S

(only offered on bedside tables)

ORDERING NOTES:

Edge Profile A is available in Laminate with Polymer Edge, or High-Pressure Laminate with Polymer Edge.

Edge Profiles B & C are available with the Seamless Thermoformed Vinyl.

Spill-Guard Edge can be ordered on Edge Profiles B & C in Seamless Thermoformed Vinyl.

Edge Profile S is available in Laminate with T-Mold bumper or High-Pressure Laminate with T-Mold bumper.

DOOR AND DRAWER PULL STYLES:



Flex - F



Circa - C



Indus - I

Select one:

No upcharge
Color is similar to
Silver Metallic

\$6 each
Silver Metallic

\$11 each
Silver Metallic

ORDERING NOTES: Silver Metallic Finish matches Juno legs and stanchions.

BASE RAIL:

Select one:



Style 1

ORDERING NOTES: Style 1 is the Juno standard in cases where leg option is not chosen, but it must still be selected to ensure clarity.

LAMINATE:

Select one:



Champagne



Hardrock Maple



Dune



Gingerbread



Portobello



Park Avenue Walnut

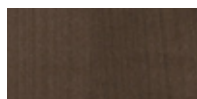

Chocolate



Dark Walnut



Ash



Willow



Nutmeg



Copper



Shiraz Cherry

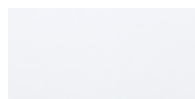

Designer White



Platinum



Earth



Charcoal

VINYL COLORS: (For Overbed Table vinyl selection see page 24)

Select one:



VENEER COLORS:

Select one:



SOLID SURFACE: Please contact customer service for a quote. See [Page 29](#) for color options.

T-MOLD BUMPER COLORS:

Select one: Beige - B Charcoal Grey - C

BASE COLORS FOR OVERBED TABLES:

Select one: S - Silver Metallic G - Graphite B- Black A - Almond N - Nevada

ORDERING NOTES:

A typical selection and the ideal way to enter on your purchase order would be as follows:





REQUIRED TO SPECIFY	SPECIFIED	LIST	
1. Model number (above)	JB1201R	\$904	Bedside Table with 1 drawer/1 door and Lia fronts Right handed Edge Profiles B Seamless Thermoformed Vinyl Lia Flex
2. Top Material/Top Edge Profile (below)	- B	\$73	
3. Front Style (above)	- L	as listed	
4. Pull Style (Page 7)	- F	n/c	
5. Base Rail -TB models note "Style 1"	Top Color (select color)	n/c	
6. Top Color (Page 7 note color selection)	Body Color (select color)	n/c	
7. Case Color (Page 7 note color selection)			
8. T-mold bumper - Edge Profile S note color selection			
9. Options (below)	Options:		
	Locking Top Drawer - LK	\$45	
	Seamless Drawer Liner - SL	\$48	
	Final - JB1201 R B L F LK SL -	\$1071	

JUNO | BEDSIDE TABLES

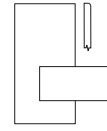
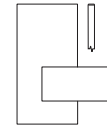
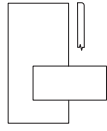
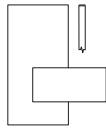
FRONT STYLES

Delphine front is laminate. Lia is thermoformed vinyl.



Description/Model	Delphine - D	Lia - L	Delphine - D	Lia - L
 1 Drawer, 1 Door JB1201L* R JB1202L R	785	904	 1 Drawer, 1 Door TB1209L* R TB1203L R TB1204L R	737 856 784 903 817 935
	830	946		
 1 Drawer, 1 Fixed Shelf JB2201N* JB2202N	687	807	 1 Drawer, 1 Fixed Shelf TB2209N* TB2203N TB2204N	642 758 687 806 721 837
	730	850		

* Indicates model illustrated by line drawing.

DIMENSIONS

	Overall Width	Overall Depth	Overall Height	Shipping Weight	Cubes
1201	19.75	19.75	30	77	8
2201	19.75	19.75	30	74	8

REQUIRED TO SPECIFY

1. Model number (above)
2. Top Material/Top Edge Profile (right)
3. Front Style (above)
4. Pull Style (page 496)
5. Base Rail -TB models note "Style 1"
6. Top Color (page 496 note color selection)
7. Case Color (page 496 note color selection)
8. T-mold bumper - Edge Profile S note color selection
9. Options (below)

TOP MATERIALS: (page 496)

LIST

Laminate W/ Polymer Edge	- L (with Edge Profile A)	N/C
HP Laminate W/ Polymer Edge	- P (with Edge Profile A)	33
Seamless Thermoformed Vinyl	- B or C (with Edge Profiles B or C)	73
Laminate Bumper	- X (with Edge Profile S)	45
HP Laminate Bumper	- Y (with Edge Profile S)	77

JUNO BEDSIDE TABLE OPTIONS

LIST

LIST

Spill Guard Edge - SG	48	Towel Bar - TB	48
NOTE: Available on Seamless Thermoformed Vinyl only.		Master Key - MK	38
Locking Top Drawer or Door - LK	45	Laminate Drawer - DR	N/C
Gallery Rails - GR	185	Rounded Top - RT	N/C
Leg Leveler (per unit, 4 Legs) - LL	14	NOTE: Available with Top Materials Laminate or HPL and Top Edge Profile "A".	
Litter Bag Holder - BH	14	Extended Top Overhang - EX	N/C
Seamless Drawer Liner - SL	48		

MODEL CODE KEY





Product Line	Description	Style	Width	Base Style	Orientation (hinge side when facing cabinet)
J	B	1	20	1	L
Units with Legs	Bedside Table	1 Drawer, 1 Door		4 legs	Hinged Left
T		2		2	R
Units without Legs		1 Drawer, 1 Fixed Shelf		2 legs/2 casters	Hinged Right
				3	N
				2 casters	Not Applicable
				4	
				4 casters	
				9	
				no legs or casters	

JUNO | BEDSIDE TABLES

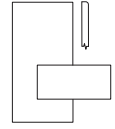
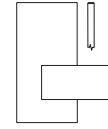
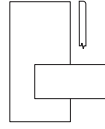
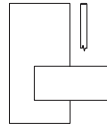
FRONT STYLES

Delphine front is laminate. Lia is thermoformed vinyl.



Description/Model		Delphine - D	Lia -L		Delphine - D	Lia - L		
	1 Drawer	JB3201N*	664	761	1 Drawer	TB3209N*	617	714
		JB3202N	710	806		TB3203N	663	761
						TB3204N	697	792
	3 Drawers	JB4201N*	1040	1157	3 Drawers	TB4209N*	990	1108
		JB4202N	1084	1202		TB4203N	1038	1155
						TB4204N	1071	1188

* Indicates model illustrated by line drawing.

DIMENSIONS

	Overall Width	Overall Depth	Overall Height	Shipping Weight	Cubes
3201	19.75	19.75	24	62	6
4201	19.75	19.75	30	92	8

REQUIRED TO SPECIFY

1. Model number (above)
2. Top Material/Top Edge Profile (right)
3. Front Style (above)
4. Pull Style (page 496)
5. Base Rail -TB models note "Style 1"
6. Top Color (page 496 note color selection)
7. Case Color (page 496 note color selection)
8. T-mold bumper - Edge Profile S note color selection
9. Options (below)

TOP MATERIALS: (page 496)

	LIST
Laminate W/ Polymer Edge - L (with Edge Profile A)	N/C
HP Laminate W/ Polymer Edge - P (with Edge Profile A)	33
Seamless Thermoformed Vinyl - B or C (with Edge Profiles B or C)	73
Laminate Bumper - X (with Edge Profile S)	45
HP Laminate Bumper - Y (with Edge Profile S)	77

JUNO BEDSIDE TABLE OPTIONS

	LIST
Spill Guard Edge - SG	48
NOTE: Available on Seamless Thermoformed Vinyl only.	
Locking Top Drawer or Door - LK	45
Gallery Rails - GR	185
Leg Leveler (per unit, 4 Legs) - LL	14
Litter Bag Holder - BH	14
Seamless Drawer Liner - SL	48

	LIST
Towel Bar - TB	48
Master Key - MK	38
Laminate Drawer - DR	N/C
Rounded Top - RT	N/C
NOTE: Available with Top Materials Laminate or HPL and Top Edge Profile "A".	
Extended Top Overhang - EX	N/C

MODEL CODE KEY



Product Line	Description	Style	Width	Base Style	Orientation (hinge side when facing cabinet)
J	B	3	20	1	L
Units with Legs	Bedside Table	1 Drawer		4 legs	Hinged Left
T		4		2	R
Units without Legs		3 Drawers		2 legs/2 casters	Hinged Right
				3	N
				2 casters	Not Applicable
				4	
				4 casters	
				9	
				no legs or casters	

JUNO | BEDSIDE TABLES

FRONT STYLES

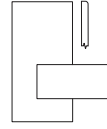
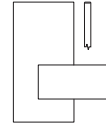
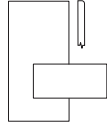
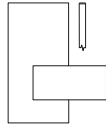
Delphine front is laminate. Lia is thermoformed vinyl.



Description/Model		Delphine - D	Lia -L		Delphine - D	Lia - L		
	1 Drawer, 1 Door	JB5201L* R	1050	1189	1 Drawer, 1 Door	TB5209L* R	1004	1142
		JB5202L R	1093	1234		TB5203L R	1050	1189
						TB5204L R	1083	1221
	1 Drawer, 1 Door	JB6201L* R	1038	1177	1 Drawer, 1 Door	TB6209L* R	990	1130
		JB6202L R	1083	1221		TB6203L R	1038	1177
						TB6204L R	1071	1210

DIMENSIONS

	Overall Width	Overall Depth	Overall Height	Shipping Weight	Cubes
1201	19.75	19.75	35	77	8
2201	19.75	19.75	35	74	8

REQUIRED TO SPECIFY

1. Model number (above)
2. Top Material/Top Edge Profile (right)
3. Front Style (above)
4. Pull Style (Page 7)
5. Base Rail -TB models note "Style 1"
6. Top Color (Page 7 note color selection)
7. Case Color (Page 7 note color selection)
8. T-mold bumper - Edge Profile S note color selection
9. Options (below)

TOP MATERIALS: (page 496)

	LIST
Laminate W/ Polymer Edge - L (with Edge Profile A)	N/C
HP Laminate W/ Polymer Edge - P (with Edge Profile A)	33
Seamless Thermoformed Vinyl - B or C (with Edge Profiles B or C)	73
Laminate Bumper - X (with Edge Profile S)	45
HP Laminate Bumper - Y (with Edge Profile S)	77

JUNO BEDSIDE TABLE OPTIONS

	LIST		LIST
Spill Guard Edge - SG	48	Towel Bar - TB	48
NOTE: Available on Seamless Thermoformed Vinyl only.		Master Key - MK	38
Locking Top Drawer or Door - LK	45	Laminate Drawer - DR	N/C
Gallery Rails - GR	185	Rounded Top - RT	N/C
Leg Leveler (per unit, 4 Legs) - LL	14	NOTE: Available with Top Materials Laminate or HPL and Top Edge Profile "A".	
Litter Bag Holder - BH	14	Extended Top Overhang - EX	N/C
Seamless Drawer Liner - SL	48		

MODEL CODE KEY

Product Line	Description	Style	Width	Base Style	Orientation (hinge side when facing cabinet)
J	B	5	20	1	L
Units with Legs	Bedside Table	1 Drawer, 1 Door		4 legs	Hinged Left
T		6		2	R
Units without Legs		1 Drawer, 1 Door		2 legs/ 2 casters	Hinged Right
				3	N
				2 casters	Not Applicable
				4	
				4 casters	
				9	
				no legs or casters	

FRONT STYLES

Delphine front is laminate. Lia is thermoformed vinyl.

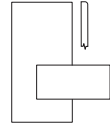
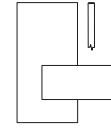
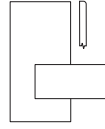
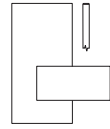

Description/Model		Delphine - D	Lia -L		Delphine - D	Lia - L
3 Drawer	JD1321N	1149	1337	3 Drawer	TD1329N	1102 1288
4 Drawer	JD2321N	1452	1692	4 Drawer	TD2329N	1404 1644
6 Drawer	JD3606N	2080	2432	6 Drawer	TD3609N	2009 2359

DIMENSIONS

	Overall Width	Overall Depth	Overall Height	Shipping Weight	Cubes
1321N	31.75	19.75	30	130	12
2321N	31.75	19.75	38.6	161	15
3601N	59.75	19.75	30	246	23

REQUIRED TO SPECIFY

1. Model number (above)
2. Top Material/Top Edge Profile (right)
3. Front Style (above)
4. Pull Style (Page 7)
5. Base Rail -TB models note "Style 1"
6. Top Color (Page 7 note color selection)
7. Case Color (Page 7 note color selection)
8. Options (below)

TOP MATERIALS: (page 496)

	LIST
Laminate W/ Polymer Edge - L (with Edge Profile A)	N/C
3 or 4 drawer	
HP Laminate W/ Polymer Edge - P (with Edge Profile A)	55
Seamless Thermoformed Vinyl - B or C (with Edge Profiles B or C)	115
6 drawer	
HP Laminate W/ Polymer Edge - P (with Edge Profile A)	97
Seamless Thermoformed Vinyl - B or C (with Edge Profiles B or C)	215

JUNO DRESSER OPTIONS

- Locking Top Drawer or Door - LK
- Leg Leveler (per unit, 4 Legs) - LL
- Leg Leveler (per unit, 6 Legs) - LL

LIST

	LIST
44	Master Key - MK 38
14	Laminate Drawer - DR N/C
18	Extended Top Overhang - EX N/C

MODEL CODE KEY

Product Line	Description	Style	Width	Base Style	Orientation (hinge side when facing cabinet)
J	D	1	32	1	N
Units with Legs	Dresser	3 Drawer		4 legs	Not Applicable
T		2	60	6	
Units without Legs		4 Drawers		6 legs	
		3		9	
		6 Drawers		no legs or casters	

JUNO | BENCHES

FRONT STYLES

Delphine front is laminate. Lia is thermoformed vinyl.

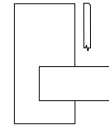
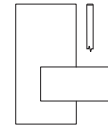
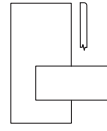
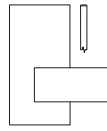

Description/Model		Delphine - D	Lia - L		Delphine - D	Lia - L
Open Bench	JC1301N	899	N/A	Open Bench	TC1309N	850
	JC1361N	1060	N/A		TC1369N	1013
Bench with 2 Drawers	JC2301N	1180	1286	Bench with 2 Drawers	TC2309N	1132
	JC2361N	1326	1452			1237

DIMENSIONS

	Overall Width	Overall Depth	Overall Height	Shipping Weight	Cubes
1301	29.25	19.75	23	60	8
1361	35.25	19.75	23	68	9
2301	29.25	19.75	23	88	8
2361	35.25	19.75	23	102	9

REQUIRED TO SPECIFY

1. **Model number** (above)
2. **Front Style** (above)
3. **Pull Style** (Page 7)
4. **Base Rail** -TB models note "Style 1"
5. **Case Color** (Page 7 note color selection)
6. **Fabric Selection**
7. **Options** (below)

JUNO BENCH OPTIONS

LIST

Locking Top Drawer or Door - LK	45
Leg Leveler (per unit, 4 Legs) - LL	14
Master Key - MK	38
Laminate Drawer - DR	N/C
Moisture Barrier	79

Cushions are priced in COM/Grade 1

Fabric Grades upcharge	2	(COL) 3	4	5	6	7	Leather 8	9
	31	60	118	176	237	295	353	443

COM yardage is 1 yard for both 30" and 36" cushions. Juno and Trevisa benches have a load weight rating of 200lbs.

MODEL CODE KEY



Product Line	Description	Style	Width	Base Style	Orientation (hinge side when facing cabinet)
J	C	1	30	1	N
Units with Legs	Cushioned Bench	Open Bench		4 legs	Not Applicable
T		2	36	9	
Units without Legs		Bench with 2 Drawers		no legs or casters	

JUNO | BENCHES & WARDROBE COMBINATION

FRONT STYLES

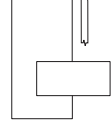
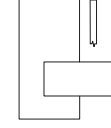
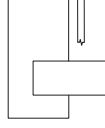
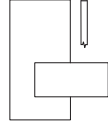
Delphine front is laminate. Lia is thermoformed vinyl.

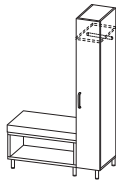
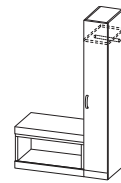
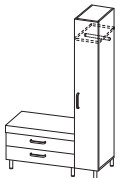

Description/Model	Delphine - D		Lia - L		Delphine - D		Lia - L	
 Open Bench with Half Wardrobe	JC3426L	2293	2450		TC3429L	2199	2352	
	R*				R*			
 Open Bench with Half Wardrobe	JC3486L	2455	2614		TC3489L	2360	2517	
			R				R	
 Bench with 2 Drawers & Half Wardrobe	JC4426L	2574	2837		TC4429L	2478	2741	
	R*				R*			
 Bench with 2 Drawers & Half Wardrobe	JC4486L	2721	3005		TC4489L	2625	2908	
	R				R			

* Indicates model illustrated by line drawing.

DIMENSIONS

	Overall Width	Overall Depth	Overall Height of Bench	Overall Height of Wardrobe	Shipping Weight	Cubes
3426	41.25	19.75	23	70	167	19
3486	47.25	19.75	23	70	175	20
4426	41.25	19.75	23	70	195	19
4486	47.25	19.75	23	70	209	20

ORDERING NOTES These units ship as two separate pieces. Cushions are priced in COM/Grade 1

REQUIRED TO SPECIFY

1. Model number (above)
2. Front Style (above)
3. Pull Style (Page 7)
4. Base Rail -TB models note "Style 1"
5. Case Color (Page 7 note color selection)
6. Fabric Selection
7. Options (below)

JUNO BENCH/WARDROBE OPTIONS

LIST	LIST
Locking Top Drawer or Door - LK	45
Cabinet Mount Corkboard -TB	228
Leg Leveler (per unit) - LL	18
Cabinet Mount Markerboard - MB	144
Cabinet Mount Mirror - AM	228
Laminate Drawer - DR	N/C
Lower Mounting Coat Rod and Shelf - AD	N/C
Extended Top Overhang - EX	N/C
Master Key - MK	38
Moisture Barrier	79

Cushions are priced in COM/Grade 1

Fabric Grades upcharge	(COL)		Leather					
	2	3	4	5	6	7	8	9
	31	60	118	176	237	295	353	443

COM yardage is 1 yard for both 30" and 36" cushions. Juno and Trevisa benches have a load weight rating of 200lbs.

MODEL CODE KEY



Product Line	Description	Style	Width	Base Style	Orientation (hinge side when facing cabinet)
J	C	3	42	6	L
Units with Legs	Cushioned Bench	Open Bench		6 legs	Hinged Left
T		4	48	9	R
Units without Legs		Bench with 2 Drawers		no legs or casters	Hinged Right

JUNO | WARDROBES

FRONT STYLES

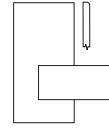
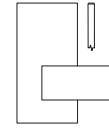
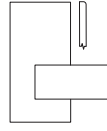
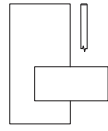
Delphine front is laminate. Lia is thermoformed vinyl.

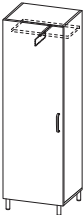
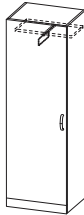

Description/Model		Delphine - D	Lia - L		Delphine - D	Lia - L
Half Wardrobe w/ Coat Rod	JW1121L R*	1396	1551	Half Wardrobe w/ Coat Rod	TW1129L R*	1349 1503
	ORDERING NOTE: 1121L/R units must either be fastened to the wall fastened to another case for support to prevent tipping.				ORDERING NOTE: 1121L/R units must either be fastened to the wall fastened to another case for support to prevent tipping.	
Single Door Wardrobe w/ Coat Rod	JW2241L* R	1700	2010	Single Door Wardrobe w/ Coat Rod	TW2249L* R	1651 1962
	* Indicates model illustrated by line drawing.					

DIMENSIONS

	Overall Width	Overall Depth	Overall Height	Shipping Weight	Cubes
JW1121	12	19.75	70	107	11
JW2241	23.25	19.75	70	164	21

The dimensions above apply to codes starting with "T" as well.

REQUIRED TO SPECIFY

1. Model number (above)
2. Front Style (above)
3. Pull Style (Page 7)
4. Base Rail -TB models note "Style 1"
5. Case Color (Page 7 note color selection)
6. Options (below)

JUNO WARDROBE OPTIONS

LIST

Locking Top Drawer or Door - LK	45
Cabinet Mount Corkboard -TB	228
Leg Leveler (per unit) - LL	14
Cabinet Mount Markerboard - MB	144

LIST

Cabinet Mount Mirror - AM	228
Laminate Drawer - DR	N/C
Lower Mounting Coat Rod and Shelf - AD	N/C
Master Key - MK	38

MODEL CODE KEY

Product Line	Description	Style	Width	Base Style	Orientation (hinge side when facing cabinet)
J	W	1	12	1	L
Units with Legs	Wardrobe	Half Wardrobe		4 legs	Hinged Left
T		2	24	9	R
Units without Legs		Single Door Wardrobe		no legs or casters	Hinged Right

FRONT STYLES

Delphine front is laminate. Lia is thermoformed vinyl.

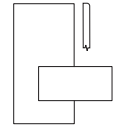
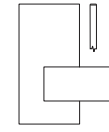
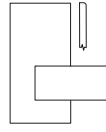
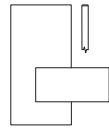

Description/Model	Delphine - D	Lia -L	Delphine - D	Lia - L
Single Door Storage w/ 4 Fixed Shelves JW3241L* R	1672	1981	Single Door Storage w/ 4 Fixed Shelves TW3249L* R	1621 1934
2 Door Wardrobe JW4361N	2018	2487	2 Door Wardrobe TW4369N	1971 2439

* Indicates model illustrated by line drawing.

DIMENSIONS

	Overall Width	Overall Depth	Overall Height	Shipping Weight	Cubes
JW3241	23.25	19.75	70	185	21
JW4361	35.25	23.25	70	243	37

The dimensions above apply to codes starting with "T" as well.

REQUIRED TO SPECIFY

1. Model number (above)
2. Front Style (above)
3. Pull Style (Page 7)
4. Base Rail -TB models note "Style 1"
5. Case Color (Page 7 note color selection)
6. Options (below)

JUNO WARDROBE OPTIONS

	LIST		LIST
Locking Top Drawer or Door - LK	48	Cabinet Mount Mirror - AM	228
Cabinet Mount Corkboard -TB	228	Laminate Drawer - DR	N/C
Leg Leveler (per unit) - LL	14	Lower Mounting Coat Rod and Shelf - AD	N/C
Cabinet Mount Markerboard - MB	144	Master Key - MK	38

MODEL CODE KEY



Product Line	Description	Style	Width	Base Style	Orientation (hinge side when facing cabinet)
J	W	3	32	1	L
Units with Legs	Wardrobe	Single Door		4 legs	Hinged Left
T		4	36	9	R
Units without Legs		2 Door Wardrobe		no legs or casters	Hinged Right

JUNO | WARDROBES

FRONT STYLES

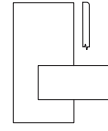
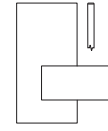
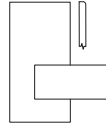
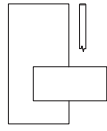
Delphine front is laminate. Lia is thermoformed vinyl.

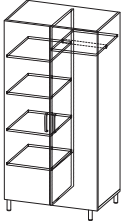

Description/Model	Delphine - D	Lia - L	Delphine - D	Lia - L
2 Door Wardrobe w/ Storage & 4 Fixed Shelves 	JW5361L R*	2313 2768	TW5369L R*	2252 2721
2 Door Wardrobe w/ Partition 	JW6361N	2304 2772	TW6369N	2256 2723

* Indicates model illustrated by line drawing.

DIMENSIONS

	Overall Width	Overall Depth	Overall Height	Shipping Weight	Cubes
JW5361	35.25	23.25	70	292	37
JW6361	35.25	23.25	70	272	37

The dimensions above apply to codes starting with "T" as well.

REQUIRED TO SPECIFY

1. **Model number** (above)
2. **Front Style** (above)
3. **Pull Style** (Page 7)
4. **Base Rail** -TB models note "Style 1"
5. **Case Color** (Page 7 note color selection)
6. **Options** (below)

JUNO WARDROBE OPTIONS

	LIST	LIST
Locking Top Drawer or Door - LK	45	Cabinet Mount Mirror - AM
Cabinet Mount Corkboard -TB	228	Laminate Drawer - DR
Leg Leveler (per unit) - LL	14	Lower Mounting Coat Rod and Shelf - AD
Cabinet Mount Markerboard - MB	144	Master Key - MK



MODEL CODE KEY

Product Line	Description	Style	Width	Base Style	Orientation (hinge side when facing cabinet)
J	W	5	36	1	L
Units with Legs	Wardrobe	4 Fixed Shelves		4 legs	Hinged Left
T		6		9	R
Units without Legs	Wardrobe w/ Partition			no legs or casters	Hinged Right

FRONT STYLES

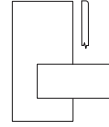
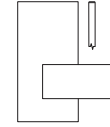
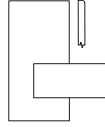
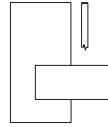
Delphine front is laminate. Lia is thermoformed vinyl.

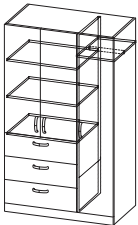

Description/Model	Delphine - D	Lia - L	Delphine - D	Lia - L
Storage w/ 3 Drawers, & 2 Doors w/ 2 Fixed Shelves 	JW7321N 2146	2612	TW7329N 2095	2565
Storage w/ 3 Drawers, & 2 Doors w/ 2 Fixed Shelves 				
Wardrobe w/ Coat Rod & Storage w/ 3 Drawers & 2 Doors w/ 2 Fixed Shelves 	JW8421L R* 2976	3520	TW8429L R* 2930	3473
Wardrobe w/ Coat Rod & Storage w/ 3 Drawers & 2 Doors w/ 2 Fixed Shelves 				

* Indicates model illustrated by line drawing.

DIMENSIONS

	Overall Width	Overall Depth	Overall Height	Shipping Weight	Cubes
JW7321	31.25	19.75	70	252	27
JW8421	41.25	23.25	70	358	43

The dimensions above apply to codes starting with "T" as well.

REQUIRED TO SPECIFY

1. **Model number** (above)
2. **Front Style** (above)
3. **Pull Style** (Page 7)
4. **Base Rail** -TB models note "Style 1"
5. **Case Color** (Page 7 note color selection)
6. **Options** (below)

JUNO WARDROBE OPTIONS

LIST

Locking Top Drawer or Door - LK	45
Cabinet Mount Corkboard -TB	228
Leg Leveler (per unit) - LL	14
Cabinet Mount Markerboard - MB	144

LIST

Cabinet Mount Mirror - AM	228
Laminate Drawer - DR	N/C
Lower Mounting Coat Rod and Shelf - AD	N/C
Master Key - MK	38

MODEL CODE KEY

Product Line	Description	Style	Width	Base Style	Orientation (hinge side when facing cabinet)
J Units with Legs	W Wardrobe	7 3 Drawers & 2 Doors	32	1 4 legs	L Hinged Left
T Units without Legs		8 Wardrobe & 3 Drawers & 2 Doors	42	9 no legs or casters	R Hinged Right

JUNO | TV UNITS

FRONT STYLES

Delphine front is laminate. Lia is thermoformed vinyl.

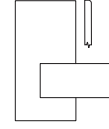
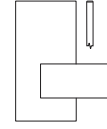
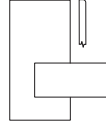
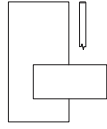

Description/Model		Delphine - D	Lia - L		Delphine - D	Lia - L	
TV Unit w/ 3 Drawers	JE1321N	2442	2857	TV Unit w/ 3 Drawers	TE1329N	2394	2810
TV Unit w/ 2 Doors and Shelf	JE2321N	2192	2608	TV Unit w/ 2 Doors and Shelf	TE2329N	2146	2562

* Indicates model illustrated by line drawing.

DIMENSIONS

	Overall Width	Overall Depth	Overall Height	Shipping Weight	Cubes
JE1321N	31.25	19.75	70	232	28
JE2321N	31.25	19.75	70	209	28

The dimensions above apply to codes starting with "T" as well.

REQUIRED TO SPECIFY

1. **Model number** (above)
2. **Front Style** (above)
3. **Pull Style** (Page 7)
4. **Base Rail** -TB models note "Style 1"
5. **Case Color** (Page 7 note color selection)
6. **Options** (below)

JUNO TV UNIT OPTIONS

	LIST		LIST
Locking Top Drawer or Door - LK	45	Laminate Drawer - DR	N/C
Leg Leveler (per unit) - LL	14	Master Key - MK	38
Pull-out Swivel TV Tray - SW	287		

MODEL CODE KEY

Product Line	Description	Style	Width	Base Style	Orientation (hinge side when facing cabinet)
J	E	1	32	1	N
Units with Legs	TV Unit	3 Drawers		4 legs	Not Applicable
T		2		9	
Units without Legs		2 Doors & Shelf		no legs or casters	

FRONT STYLES

Delphine front is laminate. Lia is thermoformed vinyl.

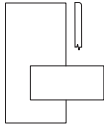
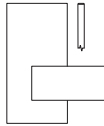
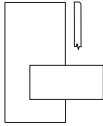
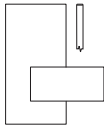

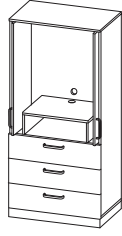
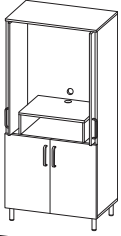
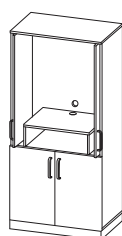
Description/Model		Delphine - D	Lia -L		Delphine - D	Lia - L	
TV Unit w/ 3 Drawers and Pocket Doors	JE3321N	4193	4712	TV Unit w/ 3 Drawers and Pocket Doors	TE3329N	4147	4665
							
TV Unit w/ 2 Doors, Shelf and Pocket Doors	JE4321N	3717	4235	TV Unit w/ 2 Doors, Shelf and Pocket Doors	TE4329N	3668	4193
							

* Indicates model illustrated by line drawing.

DIMENSIONS

	Overall Width	Overall Depth	Overall Height	Shipping Weight	Cubes
JE3321N	40	19.75	70	311	35
JE4321N	40	19.75	70	277	35

The dimensions above apply to codes starting with "T" as well.

REQUIRED TO SPECIFY

1. **Model number** (above)
2. **Front Style** (above)
3. **Pull Style** (Page 7)
4. **Base Rail** -TB models note "Style 1"
5. **Case Color** (Page 7 note color selection)
6. **Options** (below)

JUNO TV UNIT OPTIONS

	LIST	LIST
Locking Top Drawer or Door - LK	45	Laminate Drawer - DR
Leg Leveler (per unit) - LL	14	Master Key - MK
Pull-out Swivel TV Tray - SW	287	N/C
		38

MODEL CODE KEY

Product Line	Description	Style	Width	Base Style	Orientation (hinge side when facing cabinet)
J	E	3	32	1	N
Units with Legs	TV Unit	Pocket Doors & 3 Drawers		4 legs	Not Applicable
T		4		9	
Units without Legs		Pocket Doors & 2 Doors w/ Shelf		no legs or casters	

JUNO | BOOKCASES

FRONT STYLES

Delphine front is laminate. Lia is thermoformed vinyl.

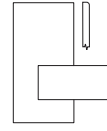
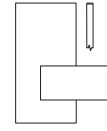
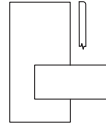
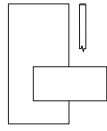

Description/Model	Delphine - D	Lia - L	Delphine - D	Lia - L
Bookcase w/ 1 Fixed Shelf JS1321N 583			Bookcase w/ 1 Fixed Shelf TS1329N 535	
Bookcase Top for 32" Dresser TS2309N 512			Bookcase Top for 48" Desk TS3489N 640	

* Indicates model illustrated by line drawing.

DIMENSIONS

	Overall Width	Overall Depth	Overall Height	Shipping Weight	Cubes
JS1321N	31.25	12	30	65	8
TS2309N	29.75	10	31.4	70	6
TS3489N	46	10	31.4	75	9

The dimensions above apply to codes starting with "T" as well.

REQUIRED TO SPECIFY

1. Model number (above)
2. Top Material/Top Edge Profile -1321N only (right)
4. Base Rail -TS model note "Style 1"
5. Top Color (Page 7 note color selection)
6. Case Color (Page 7 note color selection)
7. Options (below)

TOP MATERIALS: (page 496)

LIST

Laminate W/ Polymer Edge - L (with Edge Profile A)	N/C
HP Laminate W/ Polymer Edge - P (with Edge Profile A)	33
Seamless Thermoformed Vinyl - B or C (with Edge Profiles B or C)	73

JUNO TV UNIT OPTIONS

LIST

Leg Leveler (per unit) - LL	14
Extended Top Overhang - EX JS1321N & TS1329N	N/C

MODEL CODE KEY

Product Line	Description	Style	Width	Base Style	Orientation (hinge side when facing cabinet)
J	S	1	32	1	N
Units with Legs	Bookcase	1 Fixed Shelf		4 legs	Not Applicable
T		2		9	
Units without Legs		2 Doors & Shelf		no legs or casters	

FRONT STYLES

Delphine front is laminate. Lia is thermoformed vinyl.

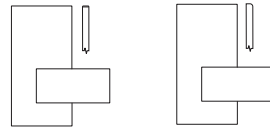

Description/Model	Delphine - D	Lia - L
Desk Shell TK1489N	653	n/a
Desk w/ 1 Drawer TK2489N	833	846

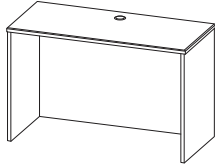

DIMENSIONS

	Overall Width	Overall Depth	Overall Height	Shipping Weight	Cubes
TK1489N	47.25	19.75	30	101	18
TK2489N	47.25	19.75	30	112	18

The dimensions above apply to codes starting with "T" as well.

REQUIRED TO SPECIFY

1. Model number (above)
2. Top Material/Top Edge Profile (below)
3. Front Style (above)
4. Pull Style (Page 7)
5. Top Color (Page 7 note color selection)
6. Case Color (Page 7 note color selection)
7. Options (below)

TOP MATERIALS: (page 496)

	LIST
Laminate W/ Polymer Edge - L (with Edge Profile A)	N/C
HP Laminate W/ Polymer Edge - P (with Edge Profile A)	77
Seamless Thermoformed Vinyl - B or C (with Edge Profiles B or C)	173

JUNO DESK OPTIONS

LIST

Locking Top Drawer or Door - LK	45
Laminate Drawer - DR	N/C
Extended Top Overhang - EX	N/C
Master Key - MK	38

MODEL CODE KEY

Product Line	Description	Style	Width	Base Style	Orientation (hinge side when facing cabinet)
T	K	1	48	9	N
Units without Legs	Desk	Shell		no legs or casters	Not Applicable
		2			
		1 Drawer			

JUNO | HEADBOARD/FOOTBOARD, MARKERBOARD, MIRROR & CORKBOARD

Description/Model	Price	Overall Width	Overall Depth	Overall Height	Shipping Weight	Cubes
Headboard TF1369N	396	36	0.75	22	17	1

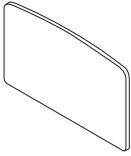

Footboard TF2369N	310	36	0.75	16	13	0.75
-------------------	-----	----	------	----	----	------

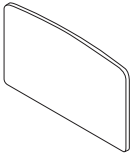

Mounting Legs (2) TF3029N	208	2.375	0.75	30	3	0.25
---------------------------	-----	-------	------	----	---	------



ORDERING NOTES: Legs are used to attach a headboard to a bed frame. Mounting Legs are solid maple in a clear finish. Hardware is not included.

Wall Mount Markerboard TMB209N	432	20	0.75	32	11	1.2
--------------------------------	-----	----	------	----	----	-----

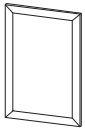

Wall Mount Mirror - Glass TGM209N	498	20	0.75	32	17	1.2
-----------------------------------	-----	----	------	----	----	-----

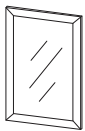

Wall Mount Corkboard TTB209N	432	20	0.75	32	9	1.2
------------------------------	-----	----	------	----	---	-----

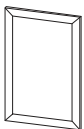

ORDERING NOTES:
Laminate frames are supplied around markerboards, mirrors, and corkboards.

Required to Specify:

1. Model number
2. Color (Page 7)
3. Options (below)

JUNO HEADBOARD/FOOTBOARD OPTIONS \$LIST

Custom Cutout - CC -per headboard or footboard	\$120
---	-------

JUNO | OVERBED TABLES - FEATURES & OPTIONS

Top Shape R is available in High-Pressure Laminate with Polymer Edges. Top Shapes K, C, and P are Seamless Thermoformed Vinyl and include a spill-guard edge as standard.



High-Pressure Laminate Edge



Seamless Thermoformed Vinyl with Spill-guard Edge

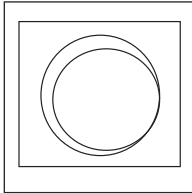

INTEGRATED SEAMLESS CUP HOLDER

The Integrated Seamless Cup Holder is available on the thermoformed vinyl tops. It is 3/8" deep and 2 1/2" in diameter. A drawing must be supplied to show the location. Two cup holders are standard on thermoformed vinyl tops when a dual top model is ordered.

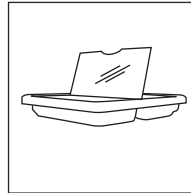

VANITY DRAWER AND MIRROR

Overbed tables have the option of a vanity drawer to store patients personal items. This drawer includes a mirror and is non-locking. Please include on the order.

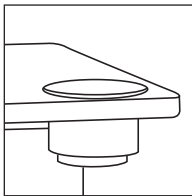

RECESSED CUP HOLDER

The Recessed cup holder is a molded flexible insert with an opening in the bottom. The inner dimensions are 3.5" diameter by 2.6" deep. It fits in a cut-out in the top. The opening is edge banded. A drawing must be supplied to show the required location.

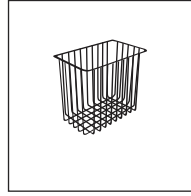

STORAGE BASKETS

Powder-coated wire brackets are available in 3 sizes - 9" x 9" x 10", 10" x 6" x 9" and 5" x 5" x 4".

VINYL COLORS:



Champagne



Hardrock Maple



Copper



Shiraz Cherry



Gingerbread



Park Avenue Walnut

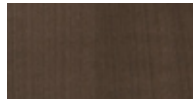

Chocolate

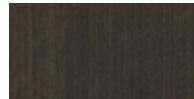

Nutmeg



Dark Walnut



Ash



Portobello



Willow



Platinum

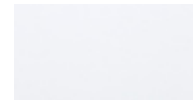

Designer White

JUNO | OVERBED TABLES

TOP SHAPES

Rectangular
High-Pressure Laminate
with Polymer edges.

Kidney, Rectangular and Peanut
Seamless Thermoformed Vinyl.



Description/Model	Rectangular - R	Kidney - K (LorR)	Rectangular - C	Peanut - P
Overbed Table w/ H - Base	TO1304N 1196	1225	1225	1225

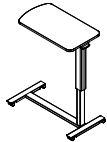

Overbed Table w/ U - Base	TO2304N 1196	1225	1225	1225
------------------------------	-----------------	------	------	------

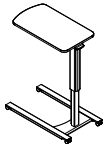

Dual Top Overbed Table w/ H - Base	TO3304N N/A	N/A	2107	2107
--	----------------	-----	------	------



Dual Top Overbed Table w/ U - Base	TO4304N N/A	N/A	2107	2107
--	----------------	-----	------	------

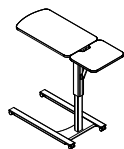

DIMENSIONS

	Overall Width	Overall Depth	Overall Height Range	Shipping Weight	Cubes
TO1304N	30	16	27/43	50	15
TO2304N	30	16	27/43	50	15
TO3304N	30	16	27/43	54	15
TO4304N	30	16	27/43	54	15

ORDERING NOTES: Cubes shown above are for 2 overbed tables per carton. The overall height of the U-base including casters is less than 2" and the H-base is 3.25"

REQUIRED TO SPECIFY

1. Model number (above)
2. Top Shape/Material (above - Kidney please choose left or Right facing)
5. Top Color (Page 7 note color selection)
6. Base Color (Page 7 note color selection)
7. Options (below)

JUNO OVERBED TABLE OPTIONS

	\$LIST
Vanity Drawer & Mirror - VM -per headboard or footboard	324
Storage Basket	
9" x 9" x 10" - B1	144
10" x 6" x 9" - B2	144
5" x 5" x 4" - B3	144
Integrated Seamless Cup Holder - IC	N/C
Recessed Cup Holder - RC	115

GENERAL INFORMATION

Terms and Conditions

Net 30 days on approved credit. A late payment charge of 1% per month will be applied on overdue invoices. This charge will be pro-rated to the number of days past 30 days that the invoice is overdue. All applicable sales taxes are extra. Distribution of this price list does not in itself constitute an offer to sell. Orders can be received only from authorized Krug dealers. Acceptance of any order and terms of sale may be established at the discretion of Krug. Deposits are required on orders received from new accounts as well as on large or special orders. Krug reserves the right to discontinue designs, or to change designs, construction, prices, or materials without notice.

Contact Information

Phone: 1.888.578.KRUG (5784) | Fax: 1.519.748.5177

Purchase Order Fax: 1.888.236.4783

Purchase Order E-mail: orders@krug.ca

Web: www.krug.ca E-mail: solutions@krug.ca

Customer Service Hours

Please note customer service hours are:

8:30 am to 5:00 pm est

Customer Satisfaction

It is the primary goal of Krug and our staff to ensure the complete satisfaction of our customers with our products and performance. If a problem arises with a Krug product after the expiration of the limited warranty period, Krug will exercise its best efforts to achieve the satisfaction of the customer in a manner that is fair to all concerned.

Order Acknowledgments

Each order will be acknowledged via e-mail or fax. This acknowledgment is the final agreement between Krug and the customer, superseding all previous communications regarding the purchase order. Where there is a discrepancy on a purchase order between a product code and a description, Krug will make every effort to resolve the discrepancy, but will be ruled by the product code ordered. Please check all acknowledgments for accuracy, and advise Krug of any discrepancies with a purchase order.

Order Cancellation

Krug reserves the right to not accept or allow cancellation of orders. All products are manufactured on a custom-made, make-to-order basis, and the purchasing, engineering and production of orders begins shortly after order placement - and the customer purchase order is a contract that authorizes Krug to manufacture the products. Acceptance of order cancellation (or partial cancellation) is solely at the discretion of Krug, and is dependent on the extent to which engineering, purchasing and manufacturing has been initiated by the time cancellation is requested. No order cancellations (partial or otherwise) are allowable more than 4 weeks from date of order placement (as order production is unable to be terminated by that point), and full payment of the acknowledged order value is required for any orders cancelled after 4 weeks. Cancellations may be allowable in less than 4 weeks after order placement, depending on the extent to which manufacturing has been initiated. An acceptance of order cancellation requires that the purchaser agrees to make payment for all costs incurred to the point of acceptance of cancellation. Cancellation charges include all costs for purchase of dedicated material and components, engineering costs for non-standard products, and all costs for manufacturing completed to that point, as well as a \$350 net charge for processing of the original order and for processing of cancellation invoicing.

Pricing

Krug endeavors to ensure that all prices in this price list reflect accurately our current prices. However, errors do occur and will be rectified through notices to the field. Krug reserves the right to acknowledge pricing that may be different from the price list.

Storage Charges

Krug reserves the right to assess a nominal storage charge if a customer does not accept shipment of an order within a week of the ship date.

Warranty

Krug warrants the construction and the finish of all our products to be free from defects in materials and workmanship for the lifetime of their use. This warranty is applicable to products in use by their original purchaser. This warranty does not apply to components not manufactured by Krug including textiles, which are subject to the specific warranties of those manufacturers, if any. Textiles (fabric, leather, vinyl, or any other covering material) suppliers do not guarantee their products for durability and color fastness, and nor does Krug. Casters, mechanical and electrical components have a warranty of five years from the date of purchase. The Krug warranty does not apply to COM-specified materials, damage caused by a carrier other than Krug, or variation in wood finishes due to natural wood color variation. Krug cannot be held responsible for variations in fabric dye lots from order to order. All fabric is carefully inspected when it is received, but a degree of variation in color should be expected. Repairs or replacement of any defect covered under this warranty by Krug will be made, at our option and method, at no charge to the original purchaser during the warranty period. Krug's judgement is final and binding with respect to the nature or cause of defects or damage, and the necessity or manner of repair or replacement.

This warranty does not apply to defects or damage resulting from:

- normal wear and tear occurring with the use of the product
- negligence, misuse, excessive use, alteration, improper cleaning or repair
- substitution or use of incorrect or unauthorized components or material
- handling or installation that is incorrect, or that causes damage or defect
- damage incurred by a freight carrier other than Krug
- wearing of finishes and fabrics, and normal variations in materials (including dye lot variations)
- properties of natural materials, including wood and leather
- exposure to environments with uncontrolled temperature and humidity (products must be transported, stored and used in climate-controlled conditions)

Note, specific warranties for components and materials not manufactured by Krug:

Jordan Sleepers Heavy-Duty Mechanism, made with heavy gauge steel and minimal moving parts - is backed by a 5-year warranty on the mechanism itself, in addition to the lifetime warranty on the rest of the product. If it does become damaged or degraded, the mechanism can be field-replaced.

Juno and Trevisa Overbed Tables have a 2-year warranty.

Blanket Wrapping

Krug will blanket wrap larger seating orders at customer's request. Please indicate on your purchase order and contact Customer Service.

Export Packaging

Krug is pleased to provide the option for export packaging on all our products, to provide additional protection from damage. For shipments overseas, a quote for export packaging can be provided, based on the products to be ordered and the delivery destination - please contact Customer Service or Bids & Specification Support for more information and a quotation. KRUG is not responsible for shipment damage occurring on overseas shipments

Export Packaging is STRONGLY RECOMMENDED for:

- (A) all shipments outside of the lower 48 states and Canada.
- (B) all shipments that will be held in storage for an extended period prior to installation.

Important: Please note that Krug will not be responsible for damage claims on product shipped or stored in the above conditions but where export packaging has not been utilized.

Dimensions

Dimensions are in inches and approximate, and subject to change without notice. Contact Customer Service if dimensions are critical.

GENERAL INFORMATION

Freight Terms and Conditions

1. All product is shipped FOB the Krug factory. Freight is either pre-paid to the destination or not pre-paid, depending on established customer specific freight terms.

2. Docks at the selected delivery location must be equipped to handle a 53' trailer. If a dock is inadequate for delivery by Krug, Krug will re-deliver to another local location and any additional costs will be charged to the customer.

3. For all deliveries, it is understood that Krug or its agent is making a dock delivery only (equipped to handle a 53' trailer), and any further work of truck unloading, delivery beyond the dock, installation, and removal of packaging is not authorized or paid for by Krug.

4. Drop shipments to the installation site, and timed deliveries, are available on larger shipments (full truckloads or slightly less) at no additional charge. Drop shipments or timed deliveries for smaller shipments may not be available, or if available will require a surcharge. Deliveries on an after hours basis, or on weekends, or any other special requirements, may be subject to a surcharge. Location and contact information, and the requested time of delivery, is required at least one week prior to the acknowledged shipment date. If this information is not provided one week in advance, or if the location or time of the drop shipment is changed less than one week in advance, a surcharge may be applied, and/or the drop shipment may not be scheduled. For deliveries requested Monday to Thursday after 5:00 pm, please apply a surcharge of \$250/shipment. For deliveries requested Monday to Friday before 7:00 am, please apply a surcharge of \$250/shipment. For deliveries requested Friday (after 3:00 pm) or weekends, please apply a surcharge of \$500/shipment. (local times).

5. For all deliveries - whether to the Customer location or drop shipment - any circumstances that result in the delay of our carrier (including unsuitable receiving facilities, or facilities not open or available), service charges will be applied at the rate of \$75/hour. Where re-delivery is necessary because of these circumstances, the full cost of re-delivery will be charged. If Less Than Truck Load is delivering, one hour is allocated to unload. Any additional time required to unload after the first hour is \$75/hour. If a Truck Load is delivering the order, three hours is allocated to unload. Any additional time required to unload is \$75/hour. Direct deliveries to site for large orders are possible, (must exceed \$60,000 net), and accommodate 48 - 53' trailers. Krug is responsible for delivery to the approved delivery address. If an address change is required, this must be authorized by Krug 5 business days prior to ship date. Any additional delivery costs incurred after this time will be charged to the customer.

Product Strength and Durability Testing

All Krug products have been thoroughly tested, and exceed the testing requirements of ANSI/BIFMA seating standard. Specific test results and documentation are available on request.



Installation Support

For assistance please contact Technical Support at 1-888-578-5784 x216 or e-mail installationhelp@krug.ca and you will be directed to the appropriate installation support person.

Damaged Shipments

All Krug product is well engineered, carefully inspected, and expertly loaded onto our trucks at our Distribution Center. If you receive any damaged freight, we ask that you do not refuse the shipment. Krug is not responsible for damage to goods that occurs in transit or

storage. It is the purchaser and/or receiver's responsibility to examine the goods upon receipt and to notify Krug of any damages, overages or shortages. Any discrepancies should be noted on the Bill of Lading. The delivering carrier will not accept responsibility for shortages or damages if signed "clear". Notification of concealed damage claims must be made to Krug Distribution within 5 days of delivery, along with digital pictures if available. All product and packaging must be available for inspection. Krug liability ceases after 5 business days and Krug will not be responsible for concealed damages if shipments are left unopened. Krug is not responsible for the condition of product that is stored or installed in an environment where temperature and humidity are not controlled.

Field Product Report Authorization

Krug's written authorization, in the form of an FPR number, must be obtained prior to incurring charges of any kind if Krug is expected to pay these charges. This includes authorization for returns, field repairs and replacements, post field repairs, installation and delivery charges. Krug reserves the right to have its representative inspect product related to any request for such authorizations, prior to that authorization being provided. Deductions from invoices paid for any charges to Krug, without prior written authorization in the form of an FPR, will not be accepted. Digital photographs may be required to complete the FPR process.

Returns

No merchandise may be returned without Krug's prior written consent. In the event of an authorized return, a Field Product Report (FPR) number will be issued, and a restocking charge will apply. Return transportation charges must be prepaid. Unauthorized returns will not be accepted and will be returned freight collect. All merchandise being returned must be properly packaged in its original or comparable replacement packaging to ensure protection of the product during handling and transportation. Returns on orders duplicated by the customer must be received in their original packaging to be accepted. Product being returned where Krug has authorized its liability for replacement or repair will be thoroughly inspected on its return, and the results compared to the reason for the return stated on the FPR. Any discrepancies, such as additional damage, signs of usage, missing parts, etc., will result in an adjustment to the amount of credit issued.

Custom Capabilities

Over 15% of our orders involve some type of custom work, and we invite our customers to make use of our extensive capabilities.

These include:

- 1) Dimensional customization of standard size products
- 2) Custom finishes
- 3) For larger orders, completely custom-designed products, as well as non-standard wood species can be specified.

Custom orders may require additional production lead times. Contact Engineering at the e-mail address engquotes@krug.ca.

Care and Maintenance Leather

Leather is a natural product and requires very little care during use. Most stains can be removed with a clean dry cloth. For stubborn spots and stains, use a mild non-detergent cleaner, rinse well and let air dry naturally. Do not use saddle soap, cleaning solvents, furniture polish, oils, varnish, abrasive cleaners, soaps or ammonia waters.

Fabric Upholstery

Professional upholstery cleaning is recommended.

Flammability Standards for Krug Textiles - Upholstery Program

- Passes State of California Technical Bulletin CAL 117-2013

WOOD FINISHES

Standard wood finishes are:

Finishes on Maple

- Clear Maple
- Honey Maple
- Wheat Maple

NATURAL CHARACTERISTICS OF WOOD

Wood is a natural product with inherent color variations that will never be fully mitigated by the finishing process. Please anticipate variation in colors within a single unit, from piece to piece, and from Krug wood finish samples. If a very close match is required, a sample must be provided with the order and an upcharge will apply. Exact color matches are not possible.

Custom Wood Finishes

Add 10% list to your order for special finishes, minimum upcharge is \$525 list per finish per order. (For example, on all orders up to \$5250 list, an upcharge of \$525 will apply, on orders \$5000 and up add 10% list to your order.)

Special finish upcharges on seating products are calculated on a grade 1 value. For orders with special finishes, a sample that is a minimum 3” by 3” must be received with the order. Special finishes may add additional lead time to production schedules. Since wood is a natural product, some variations in grain, color and stain acceptance will occur. In our finishing processes, we try to minimize variations, but some variation between samples and finished goods should be anticipated.

Dual Finishes

Add 10% list per item if specifying dual finish.

Standard Wood Finishes

No upcharge will be applied when specifying a finish available as standard on one species onto maple seating and occasional tables. Clear finishes are not available on other species since they are a clear finish on top of the natural veneer color.

LAMINATES

Krug’s in-stock Laminates are available in 17 different laminate selections. Please note that 4 of the colors (Gingerbread, Portobello, Ash and Willow) have textured finishes and may not be appropriate for use in patient areas due to infection control concerns. Minimum order quantities and extended lead times may apply for exotic laminate colors, please check with customer service. Polymer Edge will be selected to match the worksurface. Krug’s previous laminate in-stock program will be phased out as in-stock supply depletes. Please contact customer service for availability.

IN-STOCK LAMINATES

Wood Grain Laminates	Matching High Pressure Laminate	Textured Wood Grain Laminates	Matching High Pressure Laminate
Champagne	Tafisa T492CR	Gingerbread	Tafisa T556UR
Hardrock Maple	Formica 86992-58	Portobello	Tafisa T557UR
Dune	Tafisa T491CR	Ash	Tafisa T535AT
Copper	Tafisa T521CR	Willow	Tafisa T543AT
Shiraz Cherry	Tafisa T472CR		
Park Avenue Walnut	Wilsonart 7984-38	Solid Laminates	
Chocolate	Tafisa T498CR	Designer White	Wilsonart D354-60
Nutmeg	Tafisa T477CR	Platinum	Tafisa T202CR
Dark Walnut	Tafisa T469CR	Earth	Tafisa T767CR
		Charcoal	Tafisa T228CR

PHASE OUT LAMINATES

Almond - Black- Shadows - Edgewood Sycamore - Gunstock Walnut

Non-Stocked Laminates

For specific lead time and application questions, please contact Krug Customer Service for your requirement. Upcharges will be applicable for non-stocked laminates, depending on their cost. Non-stock laminates may require a minimum order quantity, please contact customer service. Stocked polymer edges only can be specified for use with non-stocked laminates or tops will be self-edged.

JUNO | FINISHES

SOLID SURFACE PROGRAM

The Solid Surface option provides an enhanced durability, protection and cleanability. It is available in 8 standard colors and is replaceable if it becomes damaged or degraded. Please contact Customer Service for a quote.

GROUP GRADE A - WHITE



Glacier White

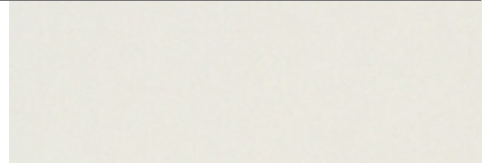

Cameo White

GROUP GRADE A - COLOR

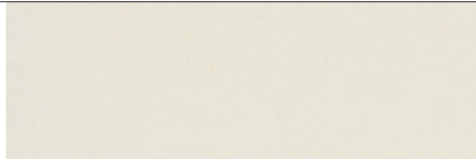

Bisque



Linen

GROUP GRADE B

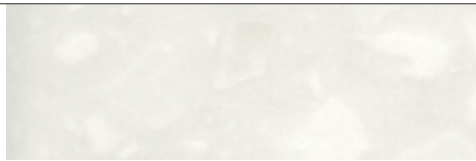

Antarctica

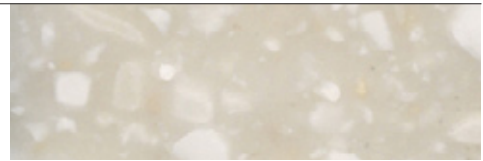

Savannah

GROUP GRADE C

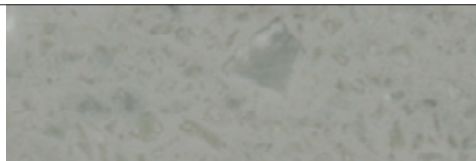

Dove

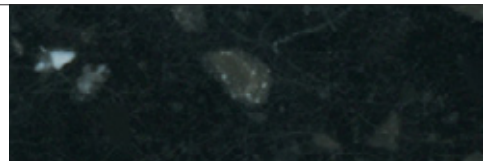

Deep Night Sky

Krug Textiles - Stocked Fabric Program

Grade 1

ARLO

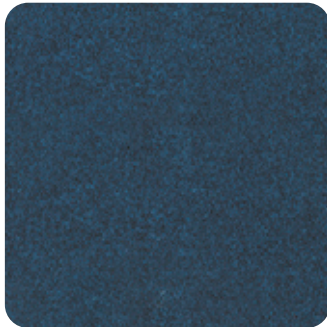

308 MIDNIGHT



306 PETROL



908 CHARCOAL



93 SEAL



601 PEARL



84 NUTMEG



62 OATMEAL



90 LIMESTONE

FRANKLIN



47 CAMEL



3009 MIDNIGHT



67 FAWN

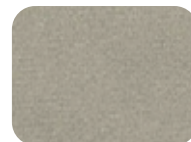

97 CINDER



94 METAL



909 BLACK

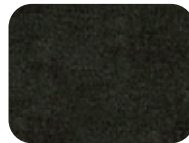

9004 CHARCOAL



308 PETROL



108 ORCHID

COMRADE

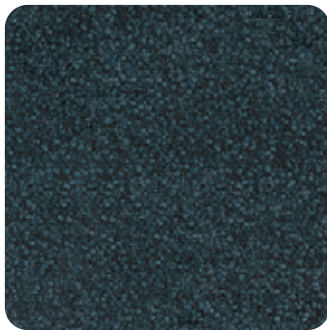

309 MIDNIGHT



84 TEAK



63 LINEN

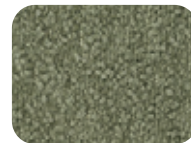

24 ALPINE



905 IRON



601 SNOW



57 MARIGOLD



31 DUCK EGG

FELICITY



601 IVORY



305 SKY



603 TAUPE



93 COAL



405 HENNA



64 PUTTY



62 FAWN



36 BLUEBERRY

KRUG TEXTILES - UPHOLSTERY FABRICS

Krug Textiles - Stocked Fabric Program

Grade 2

GRADY



25 CAPER



31 SKY



604 FLAX



901 CHAR



93 GRAY

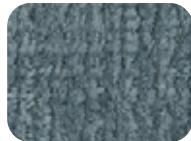

34 SLATE



84 TEAK



98 NICKLE

YATES



84 BIRCH



44 CLAY

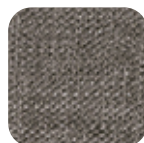

87 TAUPE

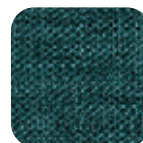

25 JUNIPER

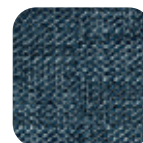

305 INDIGO

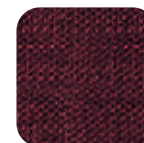

109 CRANBERRY



803 TOAST



92 ZINC



91 SILVER



908 CHARCOAL

MCCOY



608 TUNDRA



601 CREME



908 CHARCOAL



62 COPPER



108 CORDOVAN



32 ROBIN'S EGG

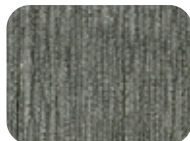

94 MERCURY



84 BARK

ORIS

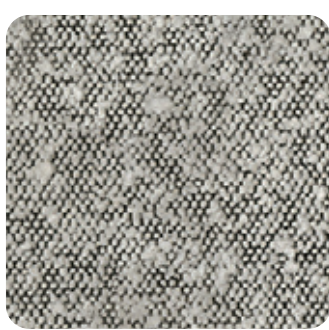

908 DOMINO



604 BARK



601 CREAM

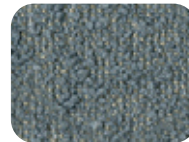

306 DELFT



902 ZINC



305 MIDNIGHT



64 PUTTY

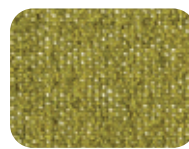

205 CHARTREUSE

Krug Textiles - Stocked Fabric Program

Grade 3

MORITZ

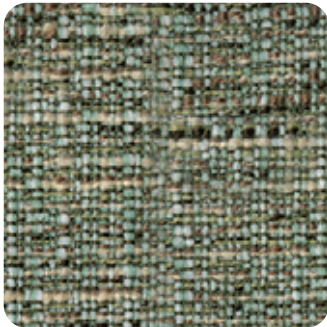

205 SPEARMINT

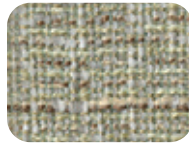

61 OYSTER

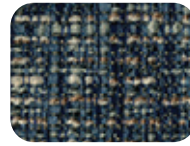

306 CADET

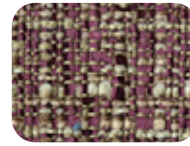

104 MULBERRY



31 AEGEAN

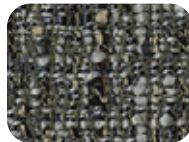

9008 CHARCOAL

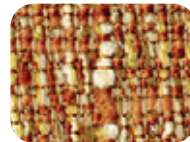

82 CLAY



304 CAPRI

LORENZO



306 INDIGO



24 ALPINE



64 LINEN



91 FLANNEL



32 MIST

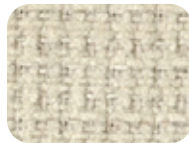

601 CREAM



106 HENNA

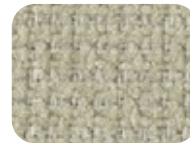

604 STUCCO

BISCOTTI



302 CAPRI



45 SPICE



61 DESERT



91 GRANITE

INTRIGUE



601 OYSTER



27 OLIVE



4003 OCHRE



908 CHARCOAL

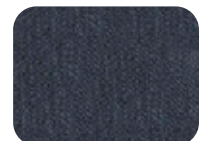

3009 MIDNIGHT



805 PECAN



608 STUCCO



605 STRAW

KRUG TEXTILES - UPHOLSTERY FABRICS



Krug Textiles - Faux Leather Program - Grade 2



Krug Textiles - Leather Program - Grade 8

Please contact Customer Service for specific information on leathers, available colors and lead times.

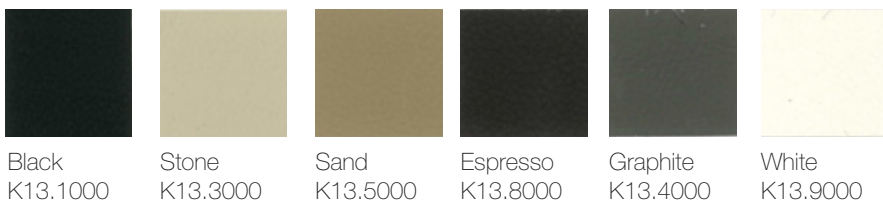

Krug Textiles - Cut fabric NET price per yard

Grade 1	\$21
Grade 2	\$33
Grade 3	\$44

LATEX FREE

Krug products are made with latex-free materials to prevent the allergic reaction that latex causes in some people.

CUSTOMER'S OWN MATERIAL - C.O.M.

Customer's Own Material (COM/COL)

COM/COL must be received three weeks prior to the acknowledged ship date. Orders with COM/COL not received by the required deadline will be delayed. A description of the upholstery cover, including supplier name, pattern name, upholstery cover name and color number must be included with the purchase order.

COM/COL testing requires 3 business days and samples are to be directed to Customer Service. The customer has the option of providing the sample COM/COL before, at time of order, or once the sample COM/COL is received. If the customer does not send a sample for approval in advance of sending actual material, Krug will not be responsible for the cost of any upholstery cover or other material that it determines to be unsuitable for the product or our process.

When the COM/COL upholstery cover is received at Krug, it must be clearly identified with the upholstery cover name and color, and tagged with name of the Krug customer and purchase order number. Krug will inspect all COM/COL upholstery covers when received to determine if it will be suitable for upholstery. Where Krug feels that the upholstery cover or leather specified will compromise the quality or integrity of our products, customers will be contacted to direct these concerns. Further, Krug reserves the right to refuse to accept and use any COM upholstery covers or leathers that will compromise our products in any way that is unacceptable to Krug. Krug cannot assume responsibility for the durability or tailoring quality of customer's own material.

Yardage specified in this price guide is approximate. In the case of multiple product orders, multiply the number of items by the COM yardage specified to determine upholstery cover required, unless otherwise indicated. Additional yardage may be needed if the material is less than 54" wide, or patterned or striped and requires matching. All COMs are cut "up the roll" unless otherwise stated by the customer. All striped upholstery covers will be applied vertically unless otherwise stated by the customer and after approval by Krug. Krug will not be responsible for directional or positional problems with its application of COM material, unless it has been provided with explicit instructions by the customer. Special instructions should be sent to Krug Customer Service, including a sample (or photocopy) of the upholstery cover. Krug is not responsible for instructions sent with the upholstery cover rolls, or for the method of upholstery if no instructions have been provided.

Price increases and freight charges to COM/COL acquired on the customer's behalf will be passed onto the customer.

Application of Directional Upholstery cover

Some COM upholstery covers will be considered directional by Krug even though they are not considered directional by the supplier. All COMs are automatically cut "up the roll" unless otherwise stated by the customer (please see below).



Standard-Cut
"up the roll"

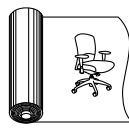

Non-Standard-Cut
across the roll "railroad"

COM/COL Shipping Procedures

For seating COM/COL upholstery covers, please send upholstery covers to:

Krug Inc.
111 Ahrens Street
Kitchener, Ontario
Canada N2H 4C2

Attention: RECEIVER

COM/COL orders cannot be scheduled into production until the upholstery cover has arrived and inspection is complete.

All packages must be clearly marked

"For Customs Clearance by Willson International Custom Brokers".

According to the North American Free Trade Agreement (NAFTA), goods shipped between the United States and Canada can qualify for exemption from all duties, or for a reduction in duties, if the goods can be proven to originate in either the United States, Canada or Mexico.

Canada Customs requires that a NAFTA Certificate of Origin and a Commercial Invoice be completed and sent with the upholstery cover shipment. The Commercial Invoice must clearly state the description of the upholstery cover, the selling price, the make-up or content, and the purchaser. The absence of these two documents will delay the shipments at the U.S./Canada border, thereby potentially delaying the customer order. If the total value of the shipment is less than \$1200 U.S., Customs will accept a Low Value Statement of Origin in place of the NAFTA Certificate of Origin. The Low Value Statement must be signed by a representative of the exporting company. This statement may either be included on the commercial invoice or attached to the invoice. Krug is happy to answer any questions or concerns about COM/COL shipping procedures and the required documents.

CAL 133 & Moisture Barrier

California Technical Bulletin 133 is a flammability test for seating. Krug offers a compliance method which, in combination with non-flammable upholstery covers, may enable the products to meet certification requirements for this test. This process at the same time also provides the products with a Moisture Barrier - a treatment that helps to prevent the passage of liquids and moisture to inside of upholstered components - thereby conferring sanitary and anti-infection benefits. So when CAL 133 is specified, the product also automatically has a Moisture Barrier, and when a Moisture Barrier is specified, the product also features the compliance method and low flammability features of CAL 133.

The application of this upcharge and the compliance method does not mean that the specific configuration of product and upholstery cover are tested and officially certified as being CAL 133 compliant. If official certification is required, Krug will provide this (through an independent certified testing laboratory) at a charge of \$772 per item, plus the cost of the product to be tested. Lead time for certification testing is typically 4-8 weeks. Krug assumes no responsibility for the testing of our products in combination with upholstery covers, or for the results of any testing conducted. Some specific configurations of product and upholstery have already been tested. Please contact Customer Service for additional information.

C.O.L. Yardage

To calculate C.O.L. yardage required, please use the following conversions based on COM yardage: Leather must be ordered in square footage.

- 17 square feet in a yard
- Approx. 3 yards in a hide
- Approx. 51 square feet in a hide
- Please use grade 3 pricing for COL

Upholstery Cover Yardage Calculation

To calculate yardage required for COM and other non-standard upholstery cover orders, please contact Krug Customer Service at 1.888.578.5784. Unless otherwise stated, upholstery cover rolls are assumed to be a minimum 54" wide. Please use the guide below to calculate the percentage of extra upholstery cover required to cover large repeats. The repeat is calculated by adding both the vertical and horizontal measurements together and then referring to the chart below for extra yardage required.

		2"-14"	15"-19"	20"-27"	28"-36"
FABRIC	Plain	Repeat	Repeat	Repeat	Repeat
54	0%	10%	15%	20%	25%
53-50	16%	20%	25%	30%	35%
48	16%	25%	30%	35%	40%
45	40%	50%	55%	60%	65%
36	50%	60%	65%	70%	75%

GRADED-IN UPHOLSTERY PROGRAMS

Krug has partnered with several textile brands to grade in their offerings, designed to provide a wide range of upholstery selections for our seating products.

Upholstery pricing and availability is subject to change without notice. We grade this upholstery according to the pricing of the fabric suppliers - when their pricing changes, the Krug grade may change.

When placing an order, a Krug customer must specify the complete upholstery number, along with the appropriate Krug model number and finish. Krug will supply the complete product at the prices listed. Orders specifying graded-in upholstery cannot be cancelled once the upholstery has been ordered.

Upholstery Grades

To determine the price of a product for graded-in upholstery, use the reference lists located on Krug's website under - Products - Textiles, to view the upholstery grade (1-9). Krug is not responsible for the discontinuation of this upholstery. Please contact Customer Service for information on upholstery not listed.

When two upholstery selections are specified for use on seating, the higher grade upholstery price will apply to the order.

High Performance upholstery; Polyurethane, Vinyl or Crypton, is particularly suitable for healthcare and other intensive-use environments.

Upholstery Samples

If you require additional samples or memos for presentation, please contact fabric supplier directly.

Flammability Standards

- Tunnel Test Surface Ratings Class A rating
- Class 1 UFAC
- Passes State of California Technical Bulletin 117-Section E

Please contact fabric supplier directly for further flammability information pertaining to specific upholstery.

Special Conditions

Acknowledgments will give the estimated delivery date of the finished product. Some upholstery is imported, and availability may affect estimated delivery time. For large projects, please contact fabric supplier directly for availability of yardage.

KRUGEXPRESS PROGRAM

PROGRAM DETAILS

KrugExpress orders are ready to ship by the date acknowledged. Delivery and shipping schedules may result in actual shipping of orders at a later date. Statutory holidays and scheduled factory vacations may add to acknowledged lead times of *KrugExpress* orders. Unless otherwise specified on the order, the customer's standard method of shipping Krug products will be utilized.

Available factory capacity for *KrugExpress* is filled by orders received on a "first come, first serve" basis. If the normal *KrugExpress* lead time is not available for your order because available capacity has been filled, you will be immediately advised of the earliest available ready-to-ship date. Please consult your Customer Service representative in advance if you wish to confirm the specific lead time availability for a *KrugExpress* order.

Orders must be received by midnight of a given day for that day to be considered the official day the order is received. Order lead times are acknowledged from the date the order is received, but not including the date the order is received.

KrugExpress orders must be "clean" when received in order to be considered officially received on a given day, and lead times will be acknowledged from the date orders are determined to be "clean". Changes to *KrugExpress* orders are not allowed under any circumstances.

Orders for product on *KrugExpress* must clearly state: "*KrugExpress*".

COM and graded-in upholstery is available on Krug Express. Orders are scheduled on Krug Express, and given the best available date, when the upholstery is received at Krug. Some conditions apply.

Please note that the CAL 133 option is not available on *KrugExpress*.



www.fsc.org
FSC® C021699

The mark of responsible forestry



All products are air emissions certified and are available as FSC® certified

krug

solutions@krug.ca | www.krug.ca | 1.888.578.KRUG