

LATITUDE
Price and Specification Guide
CANADA



Effective, January 1, 2025

krug

Advancing Design Through Innovation

LATITUDE | TABLE OF CONTENTS

| | |
|-----|---|
| 518 | Environmental Summary |
| 519 | Veneer & Finishes |
| 520 | Non-Standard Product Guidelines for Pricing |
| 520 | Edge Profile & Pulls |
| 521 | General Product Specifications |
| 528 | Sample Configuration |
| 529 | Desks |
| 536 | Height Adjustable Worksurfaces |
| 541 | Desk Runoffs |
| 546 | Returns |
| 547 | Linking |
| 548 | Credenzas |
| 553 | Overheads |
| 557 | Hutches |
| 559 | Wall Mounted Panels |
| 560 | PowerPorts & Cable Management |
| 564 | Pedestals |
| 565 | Bookcases |
| 566 | Storage |
| 570 | Wardrobes |
| 572 | Modular Components |

LATITUDE | ENVIRONMENTAL SUMMARY

LEED CERTIFICATION



MATERIAL CONTENT:

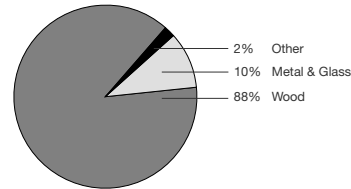

PRE-CONSUMER
RECYCLED CONTENT - 81%

POST-CONSUMER
RECYCLED CONTENT - 3%

| | | CONTRIBUTES To |
|------------------|--|----------------|
| Credit 2.1 - 2.2 | Construction Waste Management | 1- |
| Credit 4.1 | Recycled Content | 1 point |
| Credit 4.2 | Recycled Content | 1 point |
| Credit 4.5 | Low Emitting Materials, (MUST BE REQUESTED) | |
| | Composite Wood & Laminate Adhesives | 1 point |
| Credit 5.1 | Regional Materials* | 1 point |
| Credit 7 | Certified Wood (MUST BE REQUESTED) | 1 point |

*This credit is only applicable if in total 20% of the combined value of the procurement of construction materials and in the furniture are manufactured within a radius of 500 miles. This credit will apply if the installation of the finished product occurs within 500 miles of Kitchener, Ontario.

level® CERTIFICATION



BIFMA's e3 Furniture Sustainability Standard is a voluntary, multi-attribute standard that measures the degree of sustainability of furniture. This standard evaluates product and company environmental attributes and compliance systems in a wide range of elements which include Materials, Energy & Atmosphere, Human & Ecosystem Health and Social Responsibility. Latitude products have earned level®, BIFMA's sustainability certification program for furniture, certification through third-party verification against the e3 standard. All Latitude products can be supplied with level® certification. In order to accomplish this, the product must also be ordered with the air-emissions-certification option. Contact customer service for information and upcharges.

AIR-EMISSIONS

All Latitude products can be supplied with air-emissions-certified materials. Contact customer service for information and upcharges.



FSC
www.fsc.org
FSC® C021699

the mark of responsible forest

FSC®

FSC® In 2005, Krug received Forest Stewardship Council® (FSC®) Chain-of-Custody certification for our manufacturing facilities. The FSC® Chain-of-Custody tracks certified wood from seedling to final sale. It verifies that the material for our FSC® certified products only come from well-managed, FSC®-certified forests and other controlled sources. FSC® is dedicated to the promotion of responsible forest management worldwide helping to take care of forests for future generations. Latitude and other Krug products can be specified with FSC® Certification. Contact customer service for further information, pricing and lead times.



In addition, architects, designers, and building professionals can specify FSC®-certified products in order to achieve a point from the U.S. Green Building Council's Leadership in Energy and Environmental Design (LEED) Rating System.

LATITUDE | VENEERS & FINISHES

WOOD FINISHES

Standard wood finishes are:

| SPECIES | FINISH |
|----------------|------------------------------------|
| OAK | Light Oak |
| | SilverGrey on Oak |
| | Espresso Oak |
| | Harvest Oak |
| | Mahogany Oak |
| | Medium Cherry on Oak Mellow Oak |
| WALNUT | Walnut on Oak |
| | Natural Walnut |
| | SilverGrey on Walnut |
| | Regular Walnut Dark |
| | Walnut Cordovan Walnut |
| PALETTE | Black |
| | White |
| | Sand |
| | Soft Green |
| | Steel Blue |
| | Slate |

Note: Palette is available on door fronts, drawer fronts and 1/2 height modesty panels.

WOOD FINISHES TO MATCH STANDARD LAMINATES

- Willow on Rift Oak
- Dune on Rift Oak
- Portobello on Rift Oak
- Ash on Rift Oak
- Copper on Cherry
- Shiraz Cherry
- Park Avenue Walnut
- Chocolate on Walnut
- Nutmeg on Walnut
- Dark Walnut
- Hardrock Maple

VENEERS

Latitude is available in Quarter Cut Walnut and Rift Cut Oak veneers, and each is priced in this price guide. Maple and Cherry are also available: for Flat Cut Maple or Cherry veneer, use Column 1 pricing; for Quarter Cut Maple or Cherry, use Column 2 pricing. The grain direction of the veneers on vertical faces is vertical - see below for grain direction specifications.

NON-STANDARD VENEER SPECIES

In addition to range of standard wood species, Latitude can be made with virtually any commercially available veneers. To specify Anigre, Mozambique or Zebrano add 5% List, for Sycamore add 10% list to Walnut list price. Anigre is available in clear or medium finish, Mozambique, Zebrano & Sycamore are available in clear finish only. Other veneers are also available on Latitude, please contact customer service for more information and pricing on additional wood species not included in Latitude's standard offering.

NATURAL CHARACTERISTICS OF WOOD

Wood is a natural product with inherent color variations that will never be fully mitigated by the finishing process. Please anticipate variation in colors within a single unit, from piece to piece, and from Krug wood finish samples. If a very close match is required, a sample must be provided with the order and an upcharge will apply. Exact color matches are not possible.

CUSTOM WOOD FINISHES

Add 10% list to your order for special finishes, minimum upcharge is \$600 list per finish per order. (For example, on all orders up to \$6000 list, an upcharge of \$600 will apply, on orders \$6000 and up add 10% list to your order.)

For orders with special finishes, a sample that is a minimum 3" by 3" must be received with the order. Special finishes may add additional lead time to production schedules. Since wood is a natural product, some variations in grain, color and stain acceptance will occur. In our finishing processes, we try to minimize variations, but some variation between samples and finished goods should be anticipated.

FINISH

Latitude Casegoods feature Krug's finish, a proprietary catalyzed varnish formulation, that has repeatedly shown through independent laboratory testing to be the industry leader in durability and abrasion resistance. The Krug finish looks better longer than competitors and is uniquely suited to the demands of high traffic environments.

VENEER GRAIN DIRECTION

Providing a consistent wood grain direction is important in maintaining consistent color on adjacent worksurface. The arrows on the illustrations below show the grain direction on typical worksurfaces and case fronts.

Desks



Open Desks



Runoffs



Drawer and Door Fronts



Credenza



Returns & Linking Units



Hutches and Overheads



Storage



LATITUDE | GUIDELINES AND PRICING METHODS

PRICING METHODS

Custom widths: Apply the price that is one standard size larger than the desired case size (but same depth).

Example: The required custom dimension is 74" x 30". The first standard size above this is 78" x 30", so in this case you would apply the price of the 78" x 30" unit.

Custom depths: Apply the price of the same unit one size deeper (but same width).

Example: The required custom dimension is 72" x 26". The first standard size above this is 72" x 30", so in this case you would apply the price of the 72" x 30" unit.

Custom width & depth: Apply the price of the same unit both one size wider and one size deeper.

Example: The required custom dimension is 74" x 26". The first standard size above this is 84" x 30", so in this case you would apply the price of the 84" x 30" unit.

LATITUDE | NON-STANDARD PRODUCT GUIDELINES FOR PRICING

OTHER PRICING METHODS

Custom height of desk height cases: Add 18% (31-32" hi)

Grommets in non-standard positions, add: **\$152 list**

To remove hutch or overhead doors, deduct: **4% list**

Bookcase with optional vent in back (includes 2 vents and 1 grommet), add: **\$302 list**

2 lateral files and 3 or 4 closed shelves - convert to half open, half closed shelves, add: **15% list**

2 lateral files and 3 or 4 closed shelves - convert to half open, half wardrobe, add: **15% list**

To remove storage doors for open shelves, deduct: **4% list**

EXCEPTIONS TO THE PRICING METHODS ABOVE

Sizes larger than largest shown in Price List.

Glass door – any style.

Cases with curvilinear tops where the radius becomes non-standard.

Please contact Krug Customer Service at 1.888.578.KRUG if you require assistance.

PLEASE NOTE: Cases with non-standard features do not apply to the rules above.

Contact Krug Customer Service if you require assistance.

LATITUDE | EDGE PROFILE & PULLS

LATITUDE EDGE PROFILE



Desks, Credenzas, Curvilinear Desks, Returns, Linking Units, Bookcases and 2Hi Storage units have profiles on all edges.

LATITUDE PULL STYLE



Latitude drawer pulls are Gloss Aluminum finish. Doors feature a touch latch operation.



Latitude drawers have the option of finger pulls in the same finish as the drawer front. To order, note clearly on the purchase order and add **\$276 list** per pedestal.

LATITUDE | GENERAL PRODUCT SPECIFICATIONS

WORK SURFACES

Tops are 1 1/4" thick veneered MDF core with face and back veneer. All worksurfaces height tops have beveled profile edges on all sides.

MODESTY PANELS

Modesty panels are standard on all desks, and optional on shaped tops, returns, linking units and credenzas. Modesty panels on desks and Credenzas are 3/4" thick and 1 1/8" thick on returns and linking units.

VENEER

Latitude veneers are quarter cut, except for White Oak, which is rift cut - both quarter cut and rift cut veneers provide a straight grain appearance. The grain direction of the veneers on vertical faces is vertical.

FINISH

A five step catalyzed varnish finish that when dry has a sheen value of 32°, is applied to all finished cases. A lower sheen topcoat, 20°, can also be specified at standard pricing. All purchase orders must clearly note "lower sheen finish" in order to receive the optional selection.

BASES

The Latitude disc base has a Brushed Stainless finish, O-base and Square base have a Brushed Stainless finish.

LOCKS

Locks are provided as standard features on all pedestals, except bookcase pedestals, including those in desks, credenzas, and lateral file storage units. Satin Aluminum lock plugs are located on the fronts of all cases.

Locks are available on the bookcase doors at an upcharge of **\$152 list** per set of (2) doors, or one single door with an odd number of doors, please specify on the purchase order. Locks for bookcase doors are generally located on the top inside corner of the door front. Locks for hutch and overhead doors are generally located on the lower inside corners. Suites can be keyed alike at no upcharge, please specify on purchase order. For Master key, note clearly on your purchase order and add **\$40 list**.

PULLS

Standard pulls on drawers are Gloss Aluminum. Latitude drawers have the option of finger pulls in the same finish as the drawer front at an upcharge of **\$264 list** per pedestal. Doors feature touch latches.

LATCHES

All hutch, overhead and bookcase hinged doors (above the worksurface height), are equipped with touch latches mounted inside the top edge of the door.

HINGES

Hinges on all hutch, overhead and bookcase doors are European style with 110 degree opening. All hinges are fully adjustable.

DRAWERS

Desk box and file drawers have fully progressive full extension slides and are load rated at 125 lbs per drawer. All drawer interiors are birch components. All file drawers are equipped for letter and legal filing. All box/box/file pedestals in desks are supplied with one molded black pencil tray.

GLIDES

Adjustable glides are 1 1/4" long and allow for a range of adjustment of 1". Glide inserts are installed at factory, glides need to be field installed.

TESTING INFORMATION

Latitude meets or exceeds the testing requirements of ANSI / BIFMA X5.5-2014 and/or X5.9-2012.





POWERPORTS

A PowerPort is a unique worksurface mounted module that can be specified to a location that best serves the user's needs. It includes a UL approved electrical and data power bar, see page 521 for pricing.



ROUND GROMMETS

Round grommets are an aluminum finish with an open and shut mouse hole to provide cable passage for areas not requiring a large opening. Round grommets can be field installed with a power drill, 60 mm hole saw. All cases may be specified with one grommet in a standard position at no upcharge. A **\$152 list** upcharge will apply to additional grommets in standard positions and **\$152 list** for non-standard positions. The grommet position must be indicated for each case on the order. Please specify location of grommet when ordering. Please keep in mind the location of the grommets when specifying piers. For example, a pier on the left-hand side may be used with a "C", "BR" or "AR" grommet.

STANDARD GROMMET & POWERPORT POSITIONS

Desks, Credenzas, Link Units & Returns

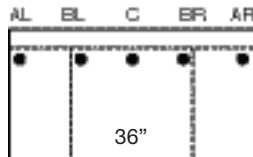
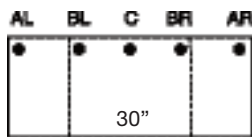

Position Code:

- AL - left corner
- BL - left end beside pedestal gable
- C - center
- BR - right end beside pedestal gable
- AR - right corner

"BR" and "BL" are only available on tops 60" or longer.

3/4 height Credenzas for Mounted Runoffs with Power/Data Option

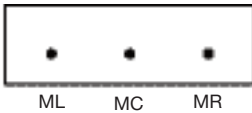

Position Code:

- ML - Mounted Left
- MC - Mounted Center (applies to 90" and 96" tops only)
- MR - Mounted Right

Rectangular Runoff Top Grommet & PowerPort

Guest Side

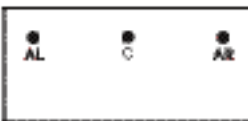

Position code:

- AL - left corner on right hand runoff ("AL" grommet and PowerPort locations apply to **rectangular runoffs**.)
- AR - right corner on left hand runoff
- C - center

Curvilinear Top Grommets & PowerPorts

"AL" and "AR" are the only grommet and PowerPort locations that apply to curvilinear returns. Please note these locations are not applicable on the 36" deep top and fixed modesty panel.

Guest Side



Guest Side



Position code:

- AL - left corner on right hand return
- AR - right corner on left hand return

Curvilinear desk grommets and PowerPorts can only be specified in "C" position.

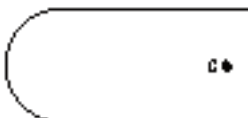

User Side

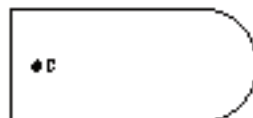

User Side

Position Code: C center

LATITUDE | CABLE MANAGEMENT

PEDESTAL ACCESS CABLE MANAGEMENT



All Latitude casegood desks, returns and credenzas allow for wire management behind the pedestal drawers. Pedestal gables feature a standard cable management opening allowing access to the rear of the pedestal cavity. By specifying a wiring grommet in a standard AL or AR position (see grommet locations above) cable can be conveniently threaded behind the pedestal drawers and through the wire management access grommet.

Velcro Cable Manager

A velcro wire management strip is available to assist in containing the cables



Cable Management PVC Trough

PVC Cable manager is used in credenzas, L and U workstations.



Cable Management for Runoffs

The Silver Metallic Trough is used to route cables from desk runoffs to credenza and out to the source.



HEIGHT ADJUSTABLE WORKSURFACE WITH BASE ENCLOSURE

Single Stage Mechanism With Base Enclosure

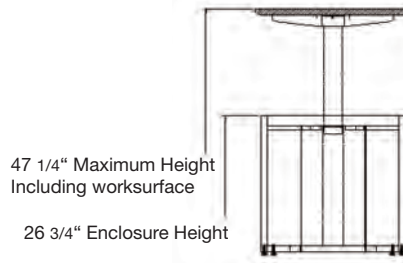
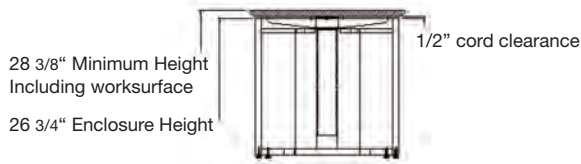

The Single Stage mechanism with Base Enclosure has an adjustable height range of 28 3/8 - 47 1/4 inches. When the worksurface is at the lowest stage - desk height, the space between underside of the worksurface and the top of the Base Enclosure is 1/2 inch.

Dual Stage Mechanism With Base Enclosure

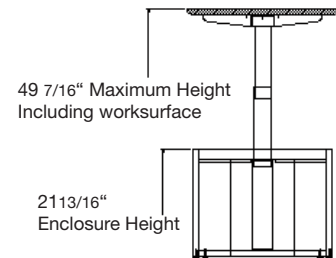
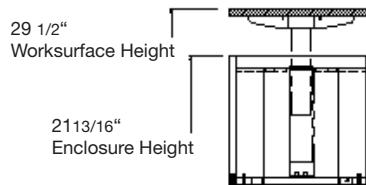
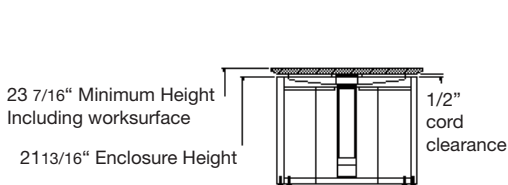

The Dual Stage mechanism with Base Enclosure has an adjustable height range of 23 7/16 - 49 7/16 inches. When the worksurface is at the standard desk height setting of 29 1/2", the space between underside of the worksurface and the top of the Base Enclosure is 6 inches. This allows for the full range of height adjustments.

Custom Base Enclosures for the Dual Stage are available decreasing the gap below the worksurface to 1/2 inch.

Caution: this eliminates the ability to use the lower stage settings.

Custom Base Enclosures to further lower the minimum worksurface height are also available, removing the inside enclosure floor completely and allowing a minimum desk height of 22 7/16". Contact customer service for a quote.

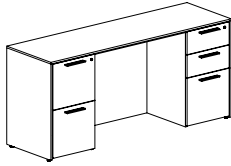

CREDENZAS - Desk Height

Latitude offers a wide variety of credenzas for use as stand alone storage pieces, part of a connected worksurface configuration, or behind a desk.

Choose from single or double pedestal options, with fixed or hinged modesty panel.

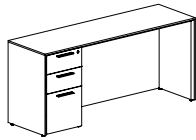

Modesty Panels

Credenzas with modesty panels have an added finished look, and all cases are available with a wiring grommet in a standard position for added cable management, please specify on your order. Credenzas with hinged modesty panels provide easy access to wall mounted electrical sources without wiring difficulties.



Pedestals

Latitude credenzas are available with single, lateral file, combination pedestals or bookcase pedestals. 3/4 height credenzas are available with box/lateral file, open/lateral file, bookcase, open/bookcase and/or open bookcase pedestals.

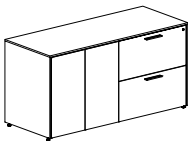

Full Face Credenzas

Full face credenzas are available in a variety of lateral file/bookcase & open bookcase combinations in 3/4 and full height cases.

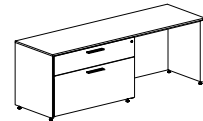

Credenzas - 3/4 Height

A large offering of Credenza sizes and configurations are available in single pedestal and full face versions.

LINKING UNITS AND CORNER UNITS



Linking Units

Latitude linking units are available in a range of sizes for ease of use in configuring a connected worksurface.

Linking Units are for use between desks and credenzas in creating a U-shaped configuration, and must be supported at both ends. They are available with or without modesty panels.

Linking Units, Tops and Returns

It is important that the main units (desk, credenza) to which the linking unit or return is being attached be in their final position and leveled. Units are connected with mending plates under the worksurface from the modesty to the end panels. Attach the mending plates under the worksurface, ensure cases are level and if necessary adjust the glides to achieve flush and firm joints before completing installation of mending plates to the modesty and end panels.

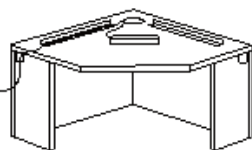

Corner Units

A corner unit can also be used on a U-shaped configuration, or it can be an integral part of a L-shaped work area with returns linked to either side.

Corner units have a standard grommet included in the back corner for ease of cable management, and have additional wire management access grommets in the half gables so that cable can be run to other areas of the connected worksurface. This can be assisted by a cut length of wire management cover.

LATITUDE | HUTCHES, OVERHEADS, & TACKBOARDS



Hutches and Overheads

Latitude offers hutch and overhead options for use in a work area configuration.

All hutches and overheads include L.E.D. tasklights that are factory installed and require no field adjustment.

Tasklights are mounted beneath the cabinet and hidden from view.

All hutches are available with Palette doors at no upcharge.

Doors

Doors are equipped with fully adjustable European style hinges. Locks are optional and can be specified

at time of order for an **upcharge of \$152 per set** of (2) doors. If an uneven amount of doors require

locks, the lock on the single door is **also \$152**. Locks are not available on glass doors.

Flip-Up Doors

Flip-up doors include standard European style hinges and an additional lift and stay mechanism.



Hutch Power/ Data/ Voice Module

Access to power and data is made simple by using a hutch with a power/data/voice module built right

into the tackboard. The module is fully installed at the factory but can be removed to connect data links

on site. It features a flip door that retracts into the case of the unit when open.

Tackboards

All hutches come standard with grade 1 tackboards. For other tackboard grade pricing, see chart on

page 557, please note, not all fabrics are suitable for tackboard application. Tackboard fabric selections

should be supplied with the order information.

Tackboards are not included with overheads, see page 555 for pricing. Overhead tackboards include wall mounting hardware and instructions.

Only hutches and overhead tackboards in Krug panel fabrics are available on *KrugExpress*.

Wall Mounted Back-Painted Glass

Glass panels are 4mm tempered white back-painted glass with aluminum frame. Magnetic back-painted glass is also available.

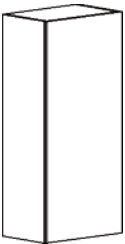

Piers

Piers are used in conjunction with overhead/hutches, glass wall panels & tackboards

L.E.D. Tasklights

Tasklights are included with hutches and overheads. On hutches, the tasklight cord is threaded behind the hutch through a standard access grommet on the upper right hand side of the back panel.

Tasklights are installed on the underside of overhead units. Cords run down the right hand side of the tasklight to the worksurface where they can be routed behind the worksurface top. The use of a wall mounted Overhead tackboard, back-painted glass wall panel or wood wall panel conceals the cord from view.

Installation

Hutch and overhead installation instructions are included with every case.

LATITUDE | FILING CONFIGURATIONS

Drawers will be offered for letter and legal size filing. All units are equipped with file bars that are fixed in place for shipping.



DESK RUNOFFS & DESK PEDESTAL FILE DRAWERS

Filing Capacity

15" drawers:
21" of letter filing front to back or
12" of legal filling side to side
22" pedestal drawer depths allow only one row of side to side files.

Weight capacity of pedestal file drawers is 100 lbs.

CREDENZA AND RETURN PEDESTAL FILE DRAWERS

Filing Capacity

15" drawers:
15" of letter filing front to back or
12" of legal filling side to side
16" pedestal drawer depths allow only one row of side to side files.

Weight capacity of pedestal file drawers is 100 lbs.

CREDENZA, RETURN OR STORAGE LATERAL FILE DRAWERS

Filing Capacity

30" wide drawers:
30" letter filing front to back, or
25" legal filing side to side
15" or legal filing front to back.

When filing front to back, 30" lateral file drawer widths allow two rows of letter filing, but only one row of legal file width.

Filing capacity

36" wide drawers:
30" letter filing front to back, or
36" legal filing side to side, or
30" legal filing front to back.

Weight capacity of lateral file drawers is 130 lbs.

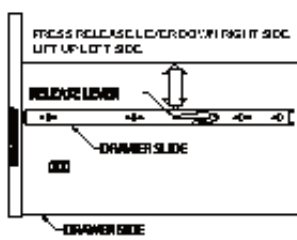

Drawer Removal

Pull drawer and slide out to the full extension position. With index finger, lift up the release lever on the left and press down the release lever on the right side of the drawer (as shown).

Pull out the drawer with the attached drawer channel from the cabinet member.

To re-assemble, insert the drawer through the guide.

LATITUDE | INSTALLATION

Glide Adjustment

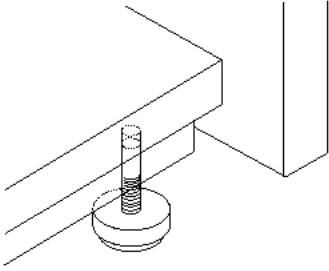

Raise one corner of the unit at a time and adjust the glide to the desired height by turning the glide to the hole. Make sure unit is level after adjusting the glides.

Please note that the maximum adjustment range of the glide is 1 1/4".

When moving units after glides have been inserted, dial the glides to the lowest position to prevent damage.

Hutch Installation

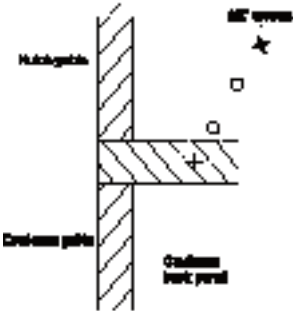

Before installing the hutch, insure that the worksurface has been placed in the final position and leveled. The worksurface should then be moved out a sufficient distance to allow access to the back. It is recommended that the minimum amount of movement be used with the leveling glides extended to prevent damage to the glides.

The hutch comes with self-adhesive foam strips that must be applied to the bottom edge prior to placing the hutch on the credenza. The foam is best applied with the hutch lying on its back. Do not leave any gaps in the foam strip, in order to prevent scratches to the credenza top while placing the hutch.

Place the hutch securely on the worksurface. Try to minimize any movement of the hutch to prevent scratching. Use of a blanket on the front portion of the credenza is recommended.

Using the supplied hardware, screw the flat bracket to the top of the credenza at each end, using the 3/4" screws provided. Swing the bracket up to approximately 60° and screw through the bracket into the hutch back with the 1/2" screws. Tighten all screws. Move combined hutch and credenza back to final location. Check for level again and adjust as required.

Door Adjustments

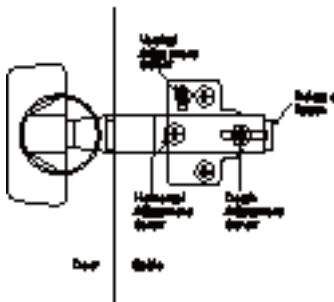

Hinges on all bookcase, overhead and hutch doors are designed to be adjusted for depth, horizontal and vertical alignment. This is easily done by adjusting the appropriate screw. See drawing.

To remove a door, push the release button and pull out the door, disconnecting hinges.

LATITUDE | SAMPLE CONFIGURATIONS

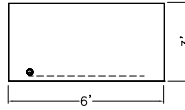
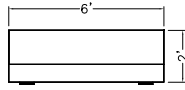
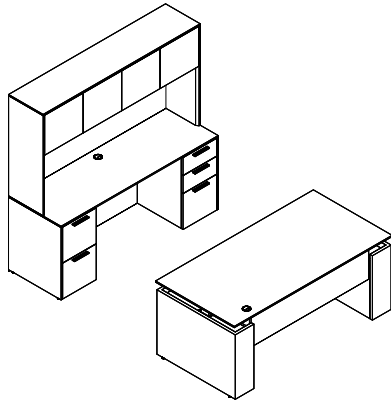

| Model | Quarter Cut | |
|------------------|-----------------|----------------------|
| | Rift Oak | Cherry Maple Walnut* |
| Height Adj. Desk | 65HA7236ETSGV21 | 6894 7239 |
| Hutch | 65HT721640 | 3733 3920 |
| Credenza | 65CY72244XLDRF | 4592 4821 |
| TOTAL | | 15219 15980 |

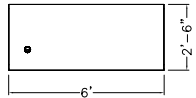
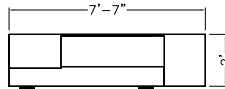
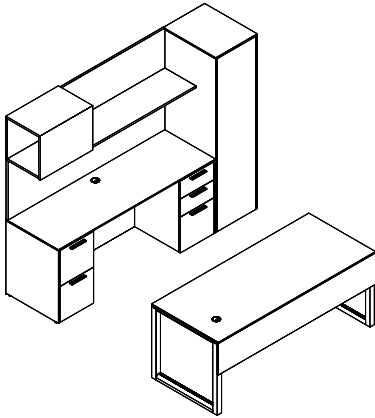

| Model | Quarter Cut | |
|--------------|-----------------|----------------------|
| | Rift Oak | Cherry Maple Walnut* |
| Credenza | 65CY72244XLDRF | 4375 4821 |
| Overhead | 65OMW721718HD30 | 4630 5106 |
| Tackboard | 65TBOHW7224 | 562 591 |
| Storage | 65ST19247011R | 3321 3662 |
| Desk | 65TD7230OBX21 | 5888 6182 |
| TOTAL | | 18776 20362 |

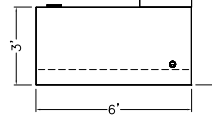
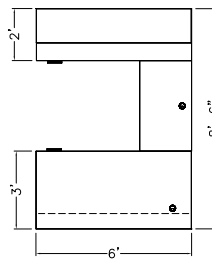
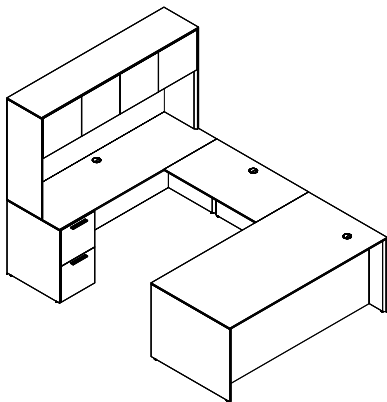

| Model | Quarter Cut | |
|--------------|----------------|----------------------|
| | Rift Oak | Cherry Maple Walnut* |
| Desk | 65D72364LORF | 3771 3960 |
| Link Unit | 65LU4224HX41 | 1417 1487 |
| Hutch | 65HT721640 | 3555 3733 |
| Credenza | 65CY72244XLDR0 | 4067 4269 |
| TOTAL | | 12810 13449 |

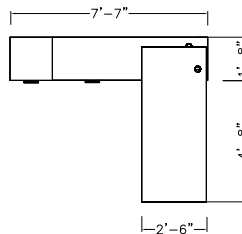
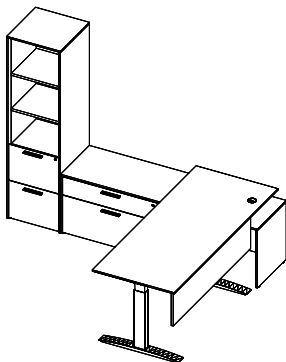



| Model | Quarter Cut | |
|------------------|-------------------|----------------------|
| | Rift Oak | Cherry Maple Walnut* |
| Height Adj. Desk | 65HA7230ETSO16V21 | 4125 4331 |
| Storage | 65ST19207090 | 3360 3530 |
| Credenza | 65CY72203XL3616R0 | 3555 3730 |
| TOTAL | | 11040 11591 |

ORDERING NOTES:

*To specify Anigre, Mozambique or Zebrano add 5% List. For Sycamore add 10% list to Walnut list price. Tops and modesty panels are wood veneer. Work surfaces are shown with grommets at no upcharge.

LATITUDE | DESKS

| Description | Model | Rift | | W | D | H | KW | Shipping Weight | Cubic Feet |
|--|---------------|------|--------|-------|------|------|------|-----------------|------------|
| | | Oak | Walnut | | | | | | |
|  | 65D60304LDRF | 4167 | 4373 | 59.75 | 30 | 29.5 | 27.5 | 218 | 39 |
| | 65D60304LFRD | 4167 | 4373 | 59.75 | 30 | 29.5 | 27.5 | 218 | 39 |
| | 65D60304LFRF | 4167 | 4373 | 59.75 | 30 | 29.5 | 27.5 | 218 | 39 |
| | 65D66304LDRF* | 4194 | 4404 | 65.75 | 30 | 29.5 | 33.5 | 224 | 42.75 |
| | 65D66304LFRD | 4194 | 4404 | 65.75 | 30 | 29.5 | 33.5 | 224 | 42.75 |
| | 65D66304LFRF | 4194 | 4404 | 65.75 | 30 | 29.5 | 33.5 | 224 | 42.75 |
| | 65D66364LDRF | 4217 | 4428 | 65.75 | 36 | 29.5 | 33.5 | 236 | 50 |
| | 65D66364LFRD | 4217 | 4428 | 65.75 | 36 | 29.5 | 33.5 | 236 | 50 |
| | 65D66364LFRF | 4217 | 4428 | 65.75 | 36 | 29.5 | 33.5 | 236 | 50 |
| | 65D72304LDRF | 4231 | 4442 | 71.75 | 30 | 29.5 | 39.5 | 246 | 46.5 |
| | 65D72304LFRD | 4231 | 4442 | 71.75 | 30 | 29.5 | 39.5 | 246 | 46.5 |
| | 65D72304LFRF | 4231 | 4442 | 71.75 | 30 | 29.5 | 39.5 | 246 | 46.5 |
| | 65D72364LDRF | 4277 | 4488 | 71.75 | 36 | 29.5 | 39.5 | 248 | 54.75 |
| | 65D72364LFRD | 4277 | 4488 | 71.75 | 36 | 29.5 | 39.5 | 248 | 54.75 |
| | 65D72364LFRF | 4277 | 4488 | 71.75 | 36 | 29.5 | 39.5 | 248 | 54.75 |
| | 65D78304LDRF | 4297 | 4513 | 77.75 | 30 | 29.5 | 45.5 | 248 | 50 |
| | 65D78304LFRD | 4297 | 4513 | 77.75 | 30 | 29.5 | 45.5 | 248 | 50 |
| | 65D78304LFRF | 4297 | 4513 | 77.75 | 30 | 29.5 | 45.5 | 248 | 50 |
| | 65D78364LDRF | 4323 | 4540 | 77.75 | 36 | 29.5 | 45.5 | 248 | 59 |
| | 65D78364LFRD | 4323 | 4540 | 77.75 | 36 | 29.5 | 45.5 | 248 | 59 |
| | 65D78364LFRF | 4323 | 4540 | 77.75 | 36 | 29.5 | 45.5 | 248 | 59 |
| | 65D84304LFRF | 4428 | 4652 | 83.75 | 30 | 29.5 | 51.5 | 311 | 53.75 |
| | 65D84304LDRF | 4428 | 4652 | 83.75 | 30 | 29.5 | 51.5 | 306 | 53.75 |
| | 65D84304LFRD | 4428 | 4652 | 83.75 | 30 | 29.5 | 51.5 | 306 | 53.75 |
| | 65D84364LDRF | 4455 | 4678 | 83.75 | 36 | 29.5 | 51.5 | 272 | 63 |
| | 65D84364LFRD | 4455 | 4678 | 83.75 | 36 | 29.5 | 51.5 | 272 | 63 |
| 65D84364LFRF | 4455 | 4678 | 83.75 | 36 | 29.5 | 51.5 | 272 | 63 | |
|  | 65D60304LFR0 | 3646 | 3828 | 59.75 | 30 | 29.5 | 43 | 206 | 39 |
| | 65D60304LORF | 3646 | 3828 | 59.75 | 30 | 29.5 | 43 | 206 | 39 |
| | 65D66304LFR0 | 3672 | 3856 | 65.75 | 30 | 29.5 | 49 | 212 | 42.75 |
| | 65D66304LORF* | 3672 | 3856 | 65.75 | 30 | 29.5 | 49 | 212 | 42.75 |
| | 65D66364LFR0 | 3707 | 3891 | 65.75 | 36 | 29.5 | 49 | 224 | 50 |
| | 65D66364LORF | 3707 | 3891 | 65.75 | 36 | 29.5 | 49 | 224 | 50 |
| | 65D72304LFR0 | 3709 | 3894 | 71.75 | 30 | 29.5 | 55 | 224 | 46.5 |
| | 65D72304LORF | 3709 | 3894 | 71.75 | 30 | 29.5 | 55 | 224 | 46.5 |
| | 65D72364LFR0 | 3771 | 3960 | 71.75 | 36 | 29.5 | 55 | 236 | 54.75 |
| | 65D72364LORF | 3771 | 3960 | 71.75 | 36 | 29.5 | 55 | 236 | 54.75 |
| | 65D78304LFR0 | 3792 | 3982 | 77.75 | 30 | 29.5 | 61 | 236 | 50 |
| | 65D78304LORF | 3792 | 3982 | 77.75 | 30 | 29.5 | 61 | 236 | 50 |
| | 65D78364LFR0 | 3837 | 4028 | 77.75 | 36 | 29.5 | 61 | 242 | 59 |
| | 65D78364LORF | 3837 | 4028 | 77.75 | 36 | 29.5 | 61 | 242 | 59 |
| | 65D84304LFR0 | 3907 | 4103 | 83.75 | 30 | 29.5 | 67 | 251 | 53.75 |
| | 65D84304LORF | 3907 | 4103 | 83.75 | 30 | 29.5 | 67 | 251 | 53.75 |
| | 65D84364LFR0 | 3952 | 4147 | 83.75 | 36 | 29.5 | 67 | 260 | 63 |
| 65D84364LORF | 3952 | 4147 | 83.75 | 36 | 29.5 | 67 | 260 | 63 | |

ORDERING NOTES:

Drawer fronts are available in pallet at an upcharge of **\$357 list** per unit, add P at the end of the model number.

ORDERING PROCEDURE

To order, please specify the following:

- 1) Krug product model number
- 2) Wood species and finish
- 3) Grommet location and style if applicable.

* Indicates model illustrated by line drawing

CODE DESCRIPTION

- 4 - full height pedestal
- L - left hand position
- R - right hand position
- D - 2 file drawers
- F - 2 box, 1 file drawer
- 0 - no pedestal



STANDARD FINISHES

For a complete list of standard wood finishes, please see page 518.

GROMMETS

One grommet in a standard position is optional at no charge. See page 521 for more information.

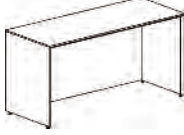
LATITUDE | DESK SHELLS

| Description | Model | Rift | | W | D | H | KW | Shipping Weight | Cubic Feet |
|--|------------------------------------|------|--------|-------|----|------|------|-----------------|------------|
| | | Oak | Walnut | | | | | | |
|  | Rectangular Desk 65SD6030X41* | 2581 | 2712 | 59.75 | 30 | 29.5 | 57.5 | 154 | 39 |
| | Shell, Full Ht Modesty 65SD6630X41 | 2611 | 2742 | 65.75 | 30 | 29.5 | 63.5 | 198 | 42.75 |
| | 65SD6636X41 | 2640 | 2773 | 65.75 | 36 | 29.5 | 63.5 | 215 | 50 |
| | 65SD7230X41 | 2673 | 2807 | 71.75 | 30 | 29.5 | 69.5 | 210 | 46.5 |
| | 65SD7236X41 | 2701 | 2837 | 71.75 | 36 | 29.5 | 69.5 | 228 | 54.75 |
| | 65SD7830X41 | 2753 | 2891 | 77.75 | 36 | 29.5 | 75.5 | 241 | 59 |
| | 65SD7836X41 | 2769 | 2907 | 77.75 | 36 | 29.5 | 75.5 | 241 | 59 |
| | 65SD8430X41 | 2833 | 2977 | 83.75 | 36 | 29.5 | 81.5 | 254 | 63 |
| | 65SD8436X41 | 2852 | 2994 | 83.75 | 36 | 29.5 | 81.5 | 254 | 63 |
|  | Rectangular Desk 65SD6030X31 | 2531 | 2658 | 59.75 | 30 | 29.5 | 57.5 | 146 | 39 |
| | Shell, 3/4 Ht Modesty 65SD6630X31* | 2560 | 2688 | 65.75 | 30 | 29.5 | 63.5 | 198 | 42.75 |
| | 65SD6636X31 | 2587 | 2717 | 65.75 | 36 | 29.5 | 63.5 | 215 | 50 |
| | 65SD7230X31 | 2616 | 2747 | 71.75 | 30 | 29.5 | 69.5 | 210 | 46.5 |
| | 65SD7236X31 | 2646 | 2779 | 71.75 | 36 | 29.5 | 69.5 | 228 | 54.75 |
| | 65SD7830X31 | 2697 | 2832 | 77.75 | 36 | 29.5 | 75.5 | 228 | 54.75 |
| | 65SD7836X31 | 2717 | 2853 | 77.75 | 36 | 29.5 | 75.5 | 241 | 59 |
| | 65SD8430X31 | 2778 | 2917 | 83.75 | 36 | 29.5 | 81.5 | 254 | 63 |
| | 65SD8436X31 | 2798 | 2938 | 83.75 | 36 | 29.5 | 81.5 | 254 | 63 |
|  | Bow Top Option BT65D6030 | 441 | 464 | 59.75 | - | - | - | - | - |
| | BT65D6630* | 460 | 485 | 65.75 | - | - | - | - | - |
| | BT65D6636 | 481 | 507 | 65.75 | - | - | - | - | - |
| | BT65D7230 | 494 | 518 | 71.75 | - | - | - | - | - |
| | BT65D7236 | 515 | 541 | 71.75 | - | - | - | - | - |
| | BT65D7830 | 513 | 539 | 77.75 | - | - | - | - | - |
| | BT65D7836 | 536 | 561 | 77.75 | - | - | - | - | - |
| | BT65D8430 | 517 | 543 | 83.75 | - | - | - | - | - |
| | BT65D8436 | 540 | 568 | 83.75 | - | - | - | - | - |

DIMENSION KEY

W — width
D — depth
H — height of worksurface
KW— kneehole width

Dimensions are in inches and approximate.
Contact Customer Service if dimensions are critical.



CODE DESCRIPTION

X41 - full height wood modesty
X31 - 3/4 height wood modesty
BT - bow top

VENEER



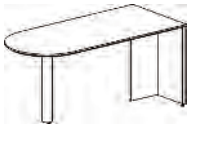

Latitude is available in Quarter Cut Walnut and Rift Cut Oak veneers, and each is priced in this price guide. Maple and Cherry are also available: for Flat Cut Maple or Cherry veneer, use Column 1 pricing; for Quarter Cut Maple or Cherry, use Column 2 pricing. Other veneers are also available on Latitude, please contact us for a quote.

LATITUDE | OPEN DESKS

| Description | Model | Rift | | W | D | H | KW | Shipping Weight | Cubic Feet |
|--|------------|------|--------|-------|----|------|----|-----------------|------------|
| | | Oak | Walnut | | | | | | |
|  Rectangular Top, 4" Diameter Metal Leg | 65DQ6030D8 | 2432 | 2553 | 59.75 | 30 | 29.5 | 42 | 117 | 39.25 |
| | 65DQ6630D8 | 2658 | 2790 | 65.75 | 30 | 29.5 | 48 | 126 | 42.75 |
| | 65DQ6636D8 | 2681 | 2815 | 65.75 | 36 | 29.5 | 48 | 146 | 50 |
| | 65DQ7230D8 | 2701 | 2837 | 71.75 | 30 | 29.5 | 54 | 132 | 46.5 |
| | 65DQ7236D8 | 2764 | 2903 | 71.75 | 36 | 29.5 | 54 | 155 | 54.75 |
| | 65DQ7830D8 | 2794 | 2934 | 77.75 | 30 | 29.5 | 60 | 141 | 50 |
| | 65DQ7836D8 | 2808 | 2949 | 77.75 | 36 | 29.5 | 60 | 163 | 59 |
| | 65DQ8430D8 | 2824 | 2965 | 83.75 | 30 | 29.5 | 66 | 154 | 53.75 |
| | 65DQ8436D8 | 2863 | 3008 | 83.75 | 36 | 29.5 | 66 | 178 | 63 |
|  Arc End Top, 4" Diameter Metal Leg | 65DA6030D8 | 2533 | 2660 | 59.75 | 30 | 29.5 | 42 | 117 | 39.25 |
| | 65DA6630D8 | 2768 | 2906 | 65.75 | 30 | 29.5 | 48 | 126 | 42.75 |
| | 65DA6636D8 | 2791 | 2932 | 65.75 | 36 | 29.5 | 48 | 146 | 50 |
| | 65DA7230D8 | 2816 | 2956 | 71.75 | 30 | 29.5 | 54 | 132 | 46.5 |
| | 65DA7236D8 | 2880 | 3024 | 71.75 | 36 | 29.5 | 54 | 155 | 54.75 |
| | 65DA7830D8 | 2910 | 3056 | 77.75 | 30 | 29.5 | 60 | 141 | 50 |
| | 65DA7836D8 | 2927 | 3073 | 77.75 | 36 | 29.5 | 60 | 163 | 59 |
| | 65DA8430D8 | 2942 | 3090 | 83.75 | 30 | 29.5 | 66 | 154 | 53.75 |
| | 65DA8436D8 | 2984 | 3133 | 83.75 | 36 | 29.5 | 66 | 178 | 63 |
|  Bullet Top, 4" Diameter Metal Leg | 65DB6030D8 | 2716 | 2852 | 59.75 | 30 | 29.5 | 42 | 117 | 39.25 |
| | 65DB6630D8 | 2768 | 2906 | 65.75 | 30 | 29.5 | 48 | 126 | 42.75 |
| | 65DB6636D8 | 2791 | 2932 | 65.75 | 36 | 29.5 | 54 | 146 | 50 |
| | 65DB7230D8 | 2816 | 2956 | 71.75 | 30 | 29.5 | 54 | 132 | 46.5 |
| | 65DB7236D8 | 2880 | 3024 | 71.75 | 36 | 29.5 | 60 | 155 | 54.75 |
| | 65DB7830D8 | 2910 | 3056 | 77.75 | 36 | 29.5 | 60 | 141 | 50 |
| | 65DB7836D8 | 2927 | 3073 | 77.75 | 30 | 29.5 | 66 | 163 | 59 |
| | 65DB8430D8 | 2942 | 3090 | 83.75 | 36 | 29.5 | 66 | 154 | 53.75 |
| | 65DB8436D8 | 3014 | 3164 | 83.75 | 30 | 29.5 | 66 | 178 | 63 |

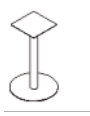
ORDERING NOTES: Open Desks with 4" metal leg (D8) support are not stand alone cases. They must be used in conjunction with returns or linking units. To specify optional bases on Open Desks see option chart below, replace "D8" in the model number with suffix below and add list upcharge. See page 531 for Modesty Panel options. Left or right designation MUST be specified when specifying a modesty panel. Designate by adding left (L) or by adding right (R) after the item size in the item number. i.e. 65DQ6030D8LV21

OPEN DESK BASE OPTION UPCHARGES

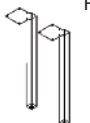
| Description | Model | List | Added Weight | Description | Model | Rift | | Added Weight |
|---|-------|------|--------------|--|-------|------|--------|--------------|
| | | | | | | Oak | Walnut | |
|  Disc Base | DB | 189 | 30 |  Gable Base For Rectangular tops | GB | 481 | 507 | 20 |
| | | | | | | | | |
|  Square Plate Base | SQ | 226 | 30 |  O-Base For Rectangular tops | OB | 643 | | 18 |
| | | | | | | | | |
|  2 - 2" Square Metal Legs For Rectangular tops | M | 565 | 19 | | | | | |

ORDERING PROCEDURE

To order, please specify the following:

- 1) Krug product model number
- 2) Wood species and finish
- 3) Grommet location and style if applicable.
- 4) Base option if applicable.
- 5) Modesty Panel option if applicable.

*Indicates model illustrated by line drawing.

CODE DESCRIPTION

- V21 - 1/2 height floating wood modesty
- V24 - 1/2 height floating back-painted glass modesty
- V29 - 1/2 height floating acrylic modesty





STANDARD FINISHES

For a complete list of standard wood finishes, please see page 518.

GROMMETS

One grommet in a standard position is optional at no charge. See page 521 for more information.

LATITUDE | OPEN DESK MODESTY PANELS

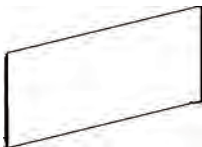
| Description | Model | Rift | | W | D | H | Shipping Weight |
|--|--------|------|--------|-------|------|----|-----------------|
| | | Oak | Walnut | | | | |
|  1/2 Height Floating Wood Modesty | V21-30 | 288 | 302 | 29.75 | 0.75 | 12 | 6 |
| | V21-36 | 297 | 312 | 35.75 | 0.75 | 12 | 6 |
| | V21-42 | 306 | 321 | 41.75 | 0.75 | 12 | 8 |
| | V21-48 | 317 | 331 | 47.75 | 0.75 | 12 | 9 |
| | V21-54 | 326 | 343 | 53.75 | 0.75 | 12 | 10 |
| | V21-60 | 336 | 352 | 59.75 | 0.75 | 12 | 11 |
| | V21-66 | 354 | 372 | 65.75 | 0.75 | 12 | 12 |
| | V21-72 | 396 | 415 | 71.75 | 0.75 | 12 | 14 |
| | V21-78 | 455 | 479 | 77.75 | 0.75 | 12 | 15 |
| | V21-84 | 592 | 622 | 83.75 | 0.75 | 12 | 16 |
|  1/2 Height Floating Palette Modesty | V22-30 | 288 | | 29.75 | 0.75 | 12 | 6 |
| | V22-36 | 297 | | 35.75 | 0.75 | 12 | 6 |
| | V22-42 | 306 | | 41.75 | 0.75 | 12 | 8 |
| | V22-48 | 317 | | 47.75 | 0.75 | 12 | 9 |
| | V22-54 | 326 | | 53.75 | 0.75 | 12 | 10 |
| | V22-60 | 336 | | 59.75 | 0.75 | 12 | 11 |
| | V22-66 | 354 | | 65.75 | 0.75 | 12 | 12 |
| | V22-72 | 396 | | 71.75 | 0.75 | 12 | 14 |
| | V22-78 | 455 | | 77.75 | 0.75 | 12 | 15 |
| | V22-84 | 592 | | 83.75 | 0.75 | 12 | 16 |
|  1/2 Height Floating Back-painted Glass Modesty | V24-30 | 919 | | 29.75 | 0.75 | 12 | 10 |
| | V24-36 | 948 | | 35.75 | 0.75 | 12 | 11 |
| | V24-42 | 977 | | 41.75 | 0.75 | 12 | 12 |
| | V24-48 | 1006 | | 47.75 | 0.75 | 12 | 13 |
| | V24-54 | 1038 | | 53.75 | 0.75 | 12 | 14 |
| | V24-60 | 1068 | | 59.75 | 0.75 | 12 | 15 |
| | V24-66 | 1116 | | 65.75 | 0.75 | 12 | 16 |
| | V24-72 | 1162 | | 71.75 | 0.75 | 12 | 18 |
| | V24-78 | 1205 | | 77.75 | 0.75 | 12 | 19 |
| | V24-84 | 1266 | | 83.75 | 0.75 | 12 | 20 |
|  1/2 Height Floating Acrylic Modesty | V29-30 | 542 | | 29.75 | 0.75 | 12 | 4 |
| | V29-36 | 560 | | 35.75 | 0.75 | 12 | 5 |
| | V29-42 | 577 | | 41.75 | 0.75 | 12 | 6 |
| | V29-48 | 596 | | 47.75 | 0.75 | 12 | 7 |
| | V29-54 | 614 | | 53.75 | 0.75 | 12 | 8 |
| | V29-60 | 633 | | 59.75 | 0.75 | 12 | 9 |
| | V29-66 | 664 | | 65.75 | 0.75 | 12 | 10 |
| | V29-72 | 694 | | 71.75 | 0.75 | 12 | 12 |
| | V29-78 | 723 | | 77.75 | 0.75 | 12 | 13 |
| | V29-84 | 768 | | 83.75 | 0.75 | 12 | 14 |
|  Full Height Fixed Wood Modesty | X41-42 | 612 | 642 | 41.75 | 0.75 | 12 | 10 |
| | X41-48 | 630 | 662 | 47.75 | 0.75 | 12 | 15 |
| | X41-54 | 648 | 681 | 53.75 | 0.75 | 12 | 18 |
| | X41-60 | 670 | 703 | 59.75 | 0.75 | 29 | 20 |
| | X41-66 | 708 | 744 | 65.75 | 0.75 | 29 | 24 |
| | X41-72 | 791 | 832 | 71.75 | 0.75 | 29 | 26 |
| | X41-78 | 910 | 956 | 77.75 | 0.75 | 29 | 30 |
| | X41-84 | 1185 | 1245 | 83.75 | 0.75 | 29 | 36 |

ORDERING NOTES: Full height fixed wood modesty is available on Rectangular Open Desks with O-base.

DIMENSION KEY

W – width
 D – depth
 H – height of worksurface
 KW – kneehole width

Dimensions are in inches and approximate.
 Contact Customer Service if dimensions are critical.



CODE DESCRIPTION

V21 - 1/2 height floating wood modesty
 V22 - 1/2 height floating palette modesty
 V24 - 1/2 height floating back-painted glass modesty
 V29 - 1/2 height floating acrylic modesty
 X41 - full height fixed wood modesty





VENEER

Latitude is available in Quarter Cut Walnut and Rift Cut Oak veneers, and each is priced in this price guide. Maple and Cherry are also available: for Flat Cut Maple or Cherry veneer, use Column 1 pricing; for Quarter Cut Maple or Cherry, use Column 2 pricing. Other veneers are also available on Latitude, please contact us for a quote.

LATITUDE | TABLE DESKS & MODESTY PANELS

| Description | Model | Rift | | W | D | H | KW | Shipping Weight | Cubic Feet |
|---|---------------|------|--------|-------|----|------|----|-----------------|------------|
| | | Oak | Walnut | | | | | | |
|  Table Desk with "O" Base | 65TD6030OB | 4772 | 5010 | 59.75 | 30 | 29.5 | 56 | 177 | 41 |
| | 65TD6036OB* | 4895 | 5140 | 59.75 | 30 | 29.5 | 56 | 190 | 41 |
| | 65TD6630OB | 4986 | 5235 | 65.75 | 30 | 29.5 | 64 | 198 | 45.75 |
| | 65TD6636OB | 5308 | 5574 | 65.75 | 36 | 29.5 | 64 | 198 | 45.75 |
| | 65TD7230OB | 5210 | 5470 | 71.75 | 30 | 29.5 | 70 | 228 | 54 |
| | 65TD7236OB | 5536 | 5812 | 71.75 | 36 | 29.5 | 70 | 228 | 54 |
| | 65TD7830OB | 5453 | 5726 | 77.75 | 30 | 29.5 | 76 | 241 | 58.5 |
| | 65TD7836OB | 5785 | 6075 | 77.75 | 36 | 29.5 | 76 | 241 | 58.5 |
| | 65TD8430OB | 5632 | 5913 | 83.75 | 30 | 29.5 | 82 | 254 | 63 |
| | 65TD8436OB | 5972 | 6271 | 83.75 | 36 | 29.5 | 82 | 254 | 63 |
|  Table Desk with Glass Top & "O" Base | 65TDGP6030OB | 7110 | | 59.75 | 30 | 29.5 | 56 | 177 | 41 |
| | 65TDGP6036OB* | 7656 | | 59.75 | 36 | 29.5 | 56 | 190 | 41 |
| | 65TDGP6630OB | 7534 | | 65.75 | 30 | 29.5 | 64 | 198 | 45.75 |
| | 65TDGP6636OB | 8325 | | 65.75 | 36 | 29.5 | 64 | 198 | 45.75 |
| | 65TDGP7230OB | 8012 | | 71.75 | 30 | 29.5 | 70 | 228 | 54 |
| | 65TDGP7236OB | 8845 | | 71.75 | 36 | 29.5 | 70 | 228 | 54 |
| | 65TDGP7830OB | 8470 | | 77.75 | 30 | 29.5 | 76 | 211 | 58.5 |
| | 65TDGP7836OB | 9351 | | 77.75 | 36 | 29.5 | 76 | 211 | 58.5 |
| | 65TDGP8430OB | 8864 | | 83.75 | 30 | 29.5 | 82 | 254 | 63 |
| | 65TDGP8436OB | 9791 | | 83.75 | 36 | 29.5 | 82 | 254 | 63 |

ORDERING NOTES: To specify optional modesty panels on Table Desks see below, add the model suffix and list upcharge.

| | | | | | | | |
|--|--------|------|------|-------|------|----|-----|
|  1/2 Ht Fixed Wood Modesty | X21-60 | 336 | 352 | 59.75 | 0.75 | 12 | 17 |
| | X21-66 | 354 | 372 | 65.75 | 0.75 | 12 | 19 |
| | X21-72 | 396 | 415 | 71.75 | 0.75 | 12 | 21 |
| | X21-78 | 455 | 479 | 77.75 | 0.75 | 12 | 23 |
| | X21-84 | 592 | 622 | 83.75 | 0.75 | 12 | 24 |
|  Full Ht Fixed Wood Modesty | X41-60 | 670 | 703 | 59.75 | 0.75 | 29 | 41 |
| | X41-66 | 708 | 744 | 65.75 | 0.75 | 29 | 45 |
| | X41-72 | 791 | 832 | 71.75 | 0.75 | 29 | 50 |
| | X41-78 | 910 | 956 | 77.75 | 0.75 | 29 | 54 |
| | X41-84 | 1185 | 1245 | 83.75 | 0.75 | 29 | 58 |
|  1/2 Ht Fixed Glass Modesty | X24-60 | 1068 | | 59.75 | 0.75 | 12 | 34 |
| | X24-66 | 1116 | | 65.75 | 0.75 | 12 | 38 |
| | X24-72 | 1162 | | 71.75 | 0.75 | 12 | 42 |
| | X24-78 | 1205 | | 77.75 | 0.75 | 12 | 46 |
| | X24-84 | 1266 | | 83.75 | 0.75 | 12 | 48 |
|  Full Ht Fixed Glass Modesty | X44-60 | 2139 | | 59.75 | 0.75 | 29 | 82 |
| | X44-66 | 2230 | | 65.75 | 0.75 | 29 | 90 |
| | X44-72 | 2322 | | 71.75 | 0.75 | 29 | 100 |
| | X44-78 | 2410 | | 77.75 | 0.75 | 29 | 108 |
| | X44-84 | 2531 | | 83.75 | 0.75 | 29 | 116 |

ORDERING PROCEDURE

To order, please specify the following:

- 1) Krug product model number
- 2) Wood species and finish
- 3) Grommet location and style if applicable
- 4) Base option if applicable
- 5) Modesty Panel option if applicable

* Indicates model illustrated by line drawing

CODE DESCRIPTION

OB - O base
 X21 - 1/2 height fixed wood modesty
 X41 - full height fixed wood modesty
 X24 - 1/2 height fixed glass Modesty
 X44 - full height fixed glass modesty

STANDARD FINISHES

For a complete list of standard wood finishes, please see page 518.

GROMMETS

One grommet in a standard position is optional at no charge. See page 521 for more information.

LATITUDE | TABLE DESKS & MODESTY PANELS

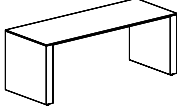
| Description | Model | Rift | | W | D | H | KW | Shipping Weight | Cubic Feet |
|---|----------|------|--------|-------|----|------|----|-----------------|------------|
| | | Oak | Walnut | | | | | | |
|  Table Desk with 4" Rectangular Gables | 65TD6030 | 2405 | 2524 | 59.75 | 30 | 29.5 | 56 | 177 | 41 |
| | 65TD6036 | 2883 | 3029 | 59.75 | 30 | 29.5 | 56 | 190 | 41 |
| | 65TD6630 | 2643 | 2778 | 65.75 | 30 | 29.5 | 64 | 198 | 45.75 |
| | 65TD6636 | 3172 | 3330 | 65.75 | 36 | 29.5 | 64 | 198 | 45.75 |
| | 65TD7230 | 2883 | 3029 | 71.75 | 30 | 29.5 | 70 | 228 | 54 |
| | 65TD7236 | 3371 | 3539 | 71.75 | 36 | 29.5 | 70 | 228 | 54 |
| | 65TD7830 | 3043 | 3194 | 77.75 | 30 | 29.5 | 76 | 241 | 58.5 |
| | 65TD7836 | 3428 | 3598 | 77.75 | 36 | 29.5 | 76 | 241 | 58.5 |
| | 65TD8430 | 3376 | 3543 | 83.75 | 30 | 29.5 | 82 | 254 | 63 |
| | 65TD8436 | 3487 | 3661 | 83.75 | 36 | 29.5 | 82 | 254 | 63 |

ORDERING NOTES: To specify optional modesty panels on Table Desks see below, add the model suffix and list upcharge.

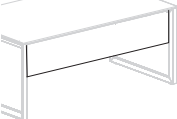
| | | | | | | | |
|---|--------|-----|-----|-------|------|----|----|
|  1/2 Height Floating Wood Modesty | V21-60 | 336 | 352 | 59.75 | 0.75 | 12 | 11 |
| | V21-66 | 354 | 372 | 65.75 | 0.75 | 12 | 12 |
| | V21-72 | 396 | 415 | 71.75 | 0.75 | 12 | 14 |
| | V21-78 | 455 | 479 | 77.75 | 0.75 | 12 | 15 |
| | V21-84 | 592 | 622 | 83.75 | 0.75 | 12 | 16 |

| | | | | | | | |
|---|--------|-----|--|-------|------|----|----|
|  1/2 Height Floating Palette Modesty | V22-60 | 336 | | 59.75 | 0.75 | 12 | 11 |
| | V22-66 | 354 | | 65.75 | 0.75 | 12 | 12 |
| | V22-72 | 396 | | 71.75 | 0.75 | 12 | 14 |
| | V22-78 | 455 | | 77.75 | 0.75 | 12 | 15 |
| | V22-84 | 592 | | 83.75 | 0.75 | 12 | 16 |

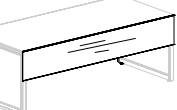
| | | | | | | | |
|--|--------|------|--|-------|------|----|----|
|  1/2 Height Floating Back-painted Glass Modesty | V24-60 | 1068 | | 59.75 | 0.75 | 12 | 15 |
| | V24-66 | 1116 | | 65.75 | 0.75 | 12 | 16 |
| | V24-72 | 1162 | | 71.75 | 0.75 | 12 | 18 |
| | V24-78 | 1205 | | 77.75 | 0.75 | 12 | 19 |
| | V24-84 | 1266 | | 83.75 | 0.75 | 12 | 20 |

| | | | | | | | |
|---|--------|-----|--|-------|------|----|----|
|  1/2 Height Floating Acrylic Modesty | V29-60 | 633 | | 59.75 | 0.75 | 12 | 9 |
| | V29-66 | 664 | | 65.75 | 0.75 | 12 | 10 |
| | V29-72 | 694 | | 71.75 | 0.75 | 12 | 12 |
| | V29-78 | 723 | | 77.75 | 0.75 | 12 | 13 |
| | V29-84 | 768 | | 83.75 | 0.75 | 12 | 14 |

DIMENSION KEY

W — width
 D — depth
 H — height of worksurface
 KW — kneehole width

Dimensions are in inches and approximate. Contact Customer Service if dimensions are critical.

CODE DESCRIPTION

V21 - 1/2 height floating wood modesty
 V22 - 1/2 height floating palette modesty
 V24 - 1/2 height floating back-painted glass modesty
 V29 - 1/2 height floating acrylic modesty

VENEER

Latitude is available in Quarter Cut Walnut and Rift Cut Oak veneers, and each is priced in this price guide. Maple and Cherry are also available: for Flat Cut Maple or Cherry veneer, use Column 1 pricing; for Quarter Cut Maple or Cherry, use Column 2 pricing. Other veneers are also available on Latitude, please contact us for a quote.

LATITUDE | TABLE DESKS & MODESTY PANELS

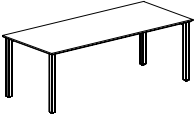
| Description | Model | Rift | | W | D | H | KW | Shipping Weight | Cubic Feet |
|--|-----------|------|--------|-------|----|------|----|-----------------|------------|
| | | Oak | Walnut | | | | | | |
|  Table Desk with 2" Square Metal Leg | 65TD6030M | 2170 | 2278 | 59.75 | 30 | 29.5 | 56 | 177 | 41 |
| | 65TD6036M | 2605 | 2734 | 59.75 | 30 | 29.5 | 56 | 190 | 41 |
| | 65TD6630M | 2387 | 2507 | 65.75 | 30 | 29.5 | 64 | 198 | 45.75 |
| | 65TD6636M | 2865 | 3008 | 65.75 | 36 | 29.5 | 64 | 198 | 45.75 |
| | 65TD7230M | 2605 | 2734 | 71.75 | 30 | 29.5 | 70 | 228 | 54 |
| | 65TD7236M | 3054 | 3206 | 71.75 | 36 | 29.5 | 70 | 228 | 54 |
| | 65TD7830M | 3041 | 3195 | 77.75 | 30 | 29.5 | 76 | 241 | 58.5 |
| | 65TD7836M | 3109 | 3264 | 77.75 | 36 | 29.5 | 76 | 241 | 58.5 |
| | 65TD8430M | 3094 | 3249 | 83.75 | 30 | 29.5 | 82 | 254 | 63 |
| | 65TD8436M | 3162 | 3320 | 83.75 | 36 | 29.5 | 82 | 254 | 63 |

ORDERING NOTES: To specify optional modesty panels on Table Desks see below, add the model suffix and list upcharge.

| | | | | | | | |
|---|--------|-----|-----|-------|------|----|----|
|  1/2 Height Floating Wood Modesty | V21-60 | 336 | 352 | 59.75 | 0.75 | 12 | 11 |
| | V21-66 | 354 | 372 | 65.75 | 0.75 | 12 | 12 |
| | V21-72 | 396 | 415 | 71.75 | 0.75 | 12 | 14 |
| | V21-78 | 455 | 479 | 77.75 | 0.75 | 12 | 15 |
| | V21-84 | 592 | 622 | 83.75 | 0.75 | 12 | 16 |

| | | | | | | | |
|--|--------|-----|--|-------|------|----|----|
|  1/2 Height Floating Palette Modesty | V22-60 | 336 | | 59.75 | 0.75 | 12 | 11 |
| | V22-66 | 354 | | 65.75 | 0.75 | 12 | 12 |
| | V22-72 | 396 | | 71.75 | 0.75 | 12 | 14 |
| | V22-78 | 455 | | 77.75 | 0.75 | 12 | 15 |
| | V22-84 | 592 | | 83.75 | 0.75 | 12 | 16 |

| | | | | | | | |
|---|--------|------|--|-------|------|----|----|
|  1/2 Height Floating Back-painted Glass Modesty | V24-60 | 1068 | | 59.75 | 0.75 | 12 | 15 |
| | V24-66 | 1116 | | 65.75 | 0.75 | 12 | 16 |
| | V24-72 | 1162 | | 71.75 | 0.75 | 12 | 18 |
| | V24-78 | 1205 | | 77.75 | 0.75 | 12 | 19 |
| | V24-84 | 1266 | | 83.75 | 0.75 | 12 | 20 |

| | | | | | | | |
|--|--------|-----|--|-------|------|----|----|
|  1/2 Height Floating Acrylic Modesty | V29-60 | 633 | | 59.75 | 0.75 | 12 | 9 |
| | V29-66 | 664 | | 65.75 | 0.75 | 12 | 10 |
| | V29-72 | 694 | | 71.75 | 0.75 | 12 | 12 |
| | V29-78 | 723 | | 77.75 | 0.75 | 12 | 13 |
| | V29-84 | 768 | | 83.75 | 0.75 | 12 | 14 |

ORDERING PROCEDURE

To order, please specify the following:

- 1) Krug product model number
- 2) Wood species and finish
- 3) Grommet location and style if applicable.
- 4) Base option if applicable.
- 5) Modesty Panel option if applicable.

* Indicates model illustrated by line drawing

CODE DESCRIPTION

- V21 - 1/2 height floating wood modesty
 V22 - 1/2 height floating palette modesty
 V24 - 1/2 height floating back-painted glass modesty
 V29 - 1/2 height floating acrylic modesty

STANDARD FINISHES

For a complete list of standard wood finishes, please see page 518.

GROMMETS

One grommet in a standard position is optional at no charge. See page 521 for more information.

LATITUDE | HEIGHT ADJUSTABLE DESK WORKSURFACES

| Description | Model | Rift | | W | D | H | KW | Shipping Weight | Cubic Feet |
|--|--------------|------|--------|-------|----|----|-------|-----------------|------------|
| | | Oak | Walnut | | | | | | |
| Electronic Height Adjustable Worksurfaces T-Base  | 65HA3024ETS | 2978 | 3127 | 29.75 | 24 | - | 17 | 108.5 | 11.5 |
| | 65HA3624ETS | 3059 | 3214 | 35.75 | 24 | - | 23 | 109 | 14 |
| | 65HA4224ETS | 3118 | 3273 | 41.75 | 24 | - | 29 | 109 | 16.5 |
| | 65HA4824ETS | 3184 | 3342 | 47.75 | 24 | - | 35 | 109.5 | 19 |
| | 65HA5424ETS | 3224 | 3386 | 53.5 | 24 | - | 41 | 110 | 21.5 |
| | 65HA6024ETS | 3313 | 3478 | 59.75 | 24 | - | 47 | 111 | 24 |
| | 65HA6624ETS | 3546 | 3724 | 65.75 | 24 | - | 53 | 114 | 26.5 |
| | 65HA7224ETS | 3714 | 3902 | 71.75 | 24 | - | 59 | 119.5 | 29 |
| | 65HA7824ETS | 3840 | 4030 | 77.75 | 24 | - | 65 | 122.5 | 31.5 |
| | 65HA8424ETS | 3914 | 4110 | 83.75 | 24 | - | 71 | 127 | 34 |
| | 65HA3030ETS | 3115 | 3270 | 29.75 | 30 | - | 17 | 121.5 | 36.75 |
| | 65HA3630ETS | 3192 | 3353 | 35.75 | 30 | - | 23 | 122 | 14.25 |
| | 65HA4230ETS | 3246 | 3409 | 41.75 | 30 | - | 29 | 122 | 17.5 |
| | 65HA4830ETS | 3315 | 3481 | 47.75 | 30 | - | 35 | 122.5 | 20.5 |
| | 65HA5430ETS | 3379 | 3547 | 53.5 | 30 | - | 41 | 123 | 23.5 |
| | 65HA6030ETS* | 3455 | 3627 | 59.75 | 30 | - | 47 | 124 | 26.5 |
| | 65HA6630ETS | 3626 | 3809 | 65.75 | 30 | - | 53 | 131 | 29.75 |
| | 65HA7230ETS | 3788 | 3978 | 71.75 | 30 | - | 59 | 132.5 | 32.75 |
| | 65HA7830ETS | 3920 | 4116 | 77.75 | 30 | - | 65 | 142.5 | 35.75 |
| | 65HA8430ETS | 3997 | 4197 | 83.75 | 30 | - | 71 | 143.5 | 38.75 |
| | 65HA3036ETS | 3307 | 3472 | 29.75 | 36 | - | 17 | 121.5 | 42 |
| | 65HA3636ETS | 3360 | 3530 | 35.75 | 36 | - | 23 | 122 | 45.5 |
| | 65HA4236ETS | 3409 | 3580 | 41.75 | 36 | - | 29 | 122 | 17.25 |
| | 65HA4836ETS | 3505 | 3680 | 47.75 | 36 | - | 35 | 122.5 | 20.75 |
| | 65HA5436ETS | 3577 | 3756 | 53.5 | 36 | - | 41 | 123 | 24.5 |
| | 65HA6036ETS | 3644 | 3827 | 59.75 | 36 | - | 47 | 124 | 28.25 |
| | 65HA6636ETS | 3786 | 3975 | 65.75 | 36 | - | 53 | 134 | 32 |
| | 65HA7236ETS | 3911 | 4108 | 71.75 | 36 | - | 59 | 151.5 | 35.5 |
| 65HA7836ETS | 4219 | 4429 | 77.75 | 36 | - | 65 | 158.5 | 39.25 | |
| 65HA8436ETS | 4311 | 4527 | 83.75 | 36 | - | 71 | 159.5 | 43 | |

ORDERING NOTES:

To order a Height Adjustable return or link unit worksurface (cross grain direction) add "RH" to the model number before the "ETS" e.g. 65HA8436RHETS

Height adjustable worksurfaces, 48" or longer, are available with an optional 16" overhang at one end, add "O16" after "ETS" in the model number. e.g. 65HA8436ETSO16

Standard base is a T-base. To order a C-base on worksurfaces, up to 30" deep only, replace "T" with "C" e.g. 65HA8430ECS

To specify optional modesty panels add the model suffix and list upcharge shown on page 532.

To order dual stage height adjustable base replace "ETS" with "ETD" and add **\$674 list**. e.g. 65HA8436ETD

Height Adjustable bases come standard with a Silver up/down button. Please contact customer service for alternate color availability. A 4 position programmable display is available, see page 557 for list price.

Single stage height adjustable range 27 1/2"-46 1/4"

Dual stage height adjustable range 22 1/2"-48 1/4"

Power cord is 10 feet long.

DIMENSION KEY

W — width
 D — depth
 H — height of worksurface
 KW— kneehole width

Dimensions are in inches and approximate.
 Contact Customer Service if dimensions are critical.

CODE DESCRIPTION

E - electric
 T - T-base
 S - single stage
 RH - return or link unit (cross grain top)
 O16- 16" overhang
 C - C-base
 D - dual stage

VENEER

Latitude is available in Quarter Cut Walnut and Rift Cut Oak veneers, and each is priced in this price guide. Maple and Cherry are also available: for Flat Cut Maple or Cherry veneer, use Column 1 pricing; for Quarter Cut Maple or Cherry, use Column 2 pricing. Other veneers are also available on Latitude, please contact us for a quote.

LATITUDE | HEIGHT ADJUSTABLE WORKSURFACES

| Description | Model | Rift | | W | D | H | KW | Shipping Weight | Cubic Feet |
|---|--------------|------|--------|-------|----|----|-------|-----------------|------------|
| | | Oak | Walnut | | | | | | |
|  Electronic Height Adjustable Worksurfaces, Base Enclosures | 65HA4224ETSG | 5176 | 5436 | 41.75 | 24 | - | 24 | 154 | 16.5 |
| | 65HA4824ETSG | 5244 | 5507 | 47.75 | 24 | - | 30 | 154.5 | 19 |
| | 65HA5424ETSG | 5289 | 5556 | 53.5 | 24 | - | 36 | 155 | 21.5 |
| | 65HA6024ETSG | 5378 | 5646 | 59.75 | 24 | - | 42 | 156 | 24 |
| | 65HA6624ETSG | 5620 | 5903 | 65.75 | 24 | - | 48 | 159 | 26.5 |
| | 65HA7224ETSG | 5792 | 6081 | 71.75 | 24 | - | 54 | 164.5 | 29 |
| | 65HA7824ETSG | 5918 | 6214 | 77.75 | 24 | - | 60 | 167.5 | 31.5 |
| | 65HA8424ETSG | 5998 | 6297 | 83.75 | 24 | - | 66 | 172 | 34 |
| | 65HA4230ETSG | 5546 | 5823 | 41.75 | 30 | - | 24 | 177 | 17.5 |
| | 65HA4830ETSG | 5616 | 5897 | 47.75 | 30 | - | 30 | 177.5 | 20.5 |
| | 65HA5430ETSG | 5679 | 5964 | 53.5 | 30 | - | 36 | 178 | 23.5 |
| | 65HA6030ETSG | 5757 | 6045 | 59.75 | 30 | - | 42 | 179 | 26.5 |
| | 65HA6630ETSG | 5936 | 6232 | 65.75 | 30 | - | 48 | 186 | 29.75 |
| | 65HA7230ETSG | 6102 | 6406 | 71.75 | 30 | - | 54 | 187.5 | 32.75 |
| | 65HA7830ETSG | 6237 | 6548 | 77.75 | 30 | - | 60 | 197.5 | 35.75 |
| | 65HA8430ETSG | 6544 | 6871 | 83.75 | 30 | - | 66 | 198.5 | 38.75 |
| | 65HA4236ETSG | 5939 | 6235 | 41.75 | 36 | - | 24 | 187 | 17.25 |
| | 65HA4836ETSG | 6035 | 6337 | 47.75 | 36 | - | 30 | 187.5 | 20.75 |
| | 65HA5436ETSG | 6109 | 6416 | 53.5 | 36 | - | 36 | 188 | 24.5 |
| | 65HA6036ETSG | 6181 | 6490 | 59.75 | 36 | - | 42 | 189 | 28.25 |
| 65HA6636ETSG | 6328 | 6644 | 65.75 | 36 | - | 48 | 199 | 32 | |
| 65HA7236ETSG | 6229 | 6541 | 71.75 | 36 | - | 54 | 216.5 | 35.5 | |
| 65HA7836ETSG | 6772 | 7110 | 77.75 | 36 | - | 60 | 223.5 | 39.25 | |
| 65HA8436ETSG | 6867 | 7210 | 83.75 | 36 | - | 66 | 224.5 | 43 | |

ORDERING NOTES:

To order a Height Adjustable return or link unit work surface (cross grain direction) add "RH" to the model number before the "ETS" e.g. 65HA8436RHETSG

Height adjustable work surfaces, 48" or longer, are available with an optional 16" overhang at one end, add "O16" after "ETS" in the model number. e.g. 65HA8436ETSO16G

To order dual stage height adjustable base replace "ETS" with "ETD" and add **\$674 list**. e.g. 65HA8436ETD

To specify optional modesty panels add the model suffix and list upcharge shown on page 532. To allow clearance for Base Enclosures order modesty 3 sizes smaller. e.g. 72" work surface - order a 54" modesty.

Height Adjustable bases come standard with a Silver up/down button. Please contact customer service for alternate color availability. A 4 position programmable display is available, see page 557 for list price.

Single stage height adjustable range 28 3/8"-47 1/4"
 Dual stage height adjustable range 23 7/16"-49 7/16"
 Power cord is 10 feet long.

ORDERING PROCEDURE

To order, please specify the following:

- 1) Krug product model number
- 2) Wood species and finish
- 3) Grommet location and style if applicable.
- 4) Base option if applicable.
- 5) Modesty Panel option if applicable.

* Indicates model illustrated by line drawing

CODE DESCRIPTION

- E - electric
- T - T-base
- S - single stage
- G - base enclosure
- RH - return or link unit (cross grain top)
- O16 - 16" overhang
- C - C-base
- D - dual stage

STANDARD FINISHES

For a complete list of standard wood finishes, please see page 518.

GROMMETS

One grommet in a standard position is optional at no charge. See page 521 for more information.

LATITUDE | HEIGHT ADJUSTABLE RETURN WORKSURFACES

| Description | Model | Rift | | W | D | H | KW | Shipping Weight | Cubic Feet |
|---|----------------|------|--------|-------|----|----|-------|-----------------|------------|
| | | Oak | Walnut | | | | | | |
| Electronic Height | 65HA4824RHETS | 3184 | 3342 | 47.75 | 24 | - | 35 | 109.5 | 19 |
| Adjustable Return | 65HA5424RHETS | 3224 | 3386 | 53.5 | 24 | - | 41 | 110 | 21.5 |
| Worksurfaces T-Base | 65HA6024RHETS | 3313 | 3478 | 59.75 | 24 | - | 47 | 111 | 24 |
| | 65HA6624RHETS | 3546 | 3724 | 65.75 | 24 | - | 53 | 114 | 26.5 |
|  | 65HA7224RHETS | 3714 | 3902 | 71.75 | 24 | - | 59 | 119.5 | 29 |
| | 65HA7824RHETS | 3840 | 4030 | 77.75 | 24 | - | 65 | 122.5 | 31.5 |
| | 65HA8424RHETS | 3914 | 4110 | 83.75 | 24 | - | 71 | 127 | 34 |
| | 65HA4830RHETS | 3315 | 3481 | 47.75 | 30 | - | 35 | 122.5 | 20.5 |
| | 65HA5430RHETS | 3379 | 3547 | 53.5 | 30 | - | 41 | 123 | 23.5 |
| | 65HA6030RHETS* | 3455 | 3627 | 59.75 | 30 | - | 47 | 124 | 26.5 |
| | 65HA6630RHETS | 3626 | 3809 | 65.75 | 30 | - | 53 | 131 | 29.75 |
| | 65HA7230RHETS | 3788 | 3978 | 71.75 | 30 | - | 59 | 132.5 | 32.75 |
| | 65HA7830RHETS | 3920 | 4116 | 77.75 | 30 | - | 65 | 142.5 | 35.75 |
| | 65HA8430RHETS | 3997 | 4197 | 83.75 | 30 | - | 71 | 143.5 | 38.75 |
| 65HA4836RHETS | 3505 | 3680 | 47.75 | 36 | - | 35 | 122.5 | 20.75 | |
| 65HA5436RHETS | 3577 | 3756 | 53.5 | 36 | - | 41 | 123 | 24.5 | |
| 65HA6036RHETS | 3644 | 3827 | 59.75 | 36 | - | 47 | 124 | 28.25 | |
| 65HA6636RHETS | 3786 | 3975 | 65.75 | 36 | - | 53 | 134 | 32 | |
| 65HA7236RHETS | 3911 | 4108 | 71.75 | 36 | - | 59 | 151.5 | 35.5 | |
| 65HA7836RHETS | 4219 | 4429 | 77.75 | 36 | - | 65 | 158.5 | 39.25 | |
| 65HA8436RHETS | 4311 | 4527 | 83.75 | 36 | - | 71 | 159.5 | 43 | |

ORDERING NOTES:

To order a Height Adjustable return or link unit work surface (cross grain direction) add "RH" to the model number before the "ETS" e.g. 65HA8436RHETS

Height adjustable work surfaces, 48" or longer, are available with an optional 16" overhang at one end, add "O16" after "ETS" in the model number. e.g. 65HA8436ETSO16

Standard base is a T-base. To order a C-base on work surfaces, up to 30" deep only, replace "T" with "C" e.g. 65HA8430ECS

To specify optional modesty panels add the model suffix and list upcharge shown on page 532.

To order dual stage height adjustable base replace "ETS" with "ETD" and add **\$674 list**. e.g. 65HA8436ETD

Height Adjustable bases come standard with a Silver up/down button. Please contact customer service for alternate color availability. A 4 position programmable display is available, see page 557 for list price.

Single stage height adjustable range 27 1/2"-46 1/4"

Dual stage height adjustable range 22 1/2"-48 1/4"

Power cord is 10 feet long.

DIMENSION KEY

W — width
D — depth
H — height of work surface
KW — kneehole width

Dimensions are in inches and approximate.
Contact Customer Service if dimensions are critical.

CODE DESCRIPTION

RH - return (cross grain)
E - electric
T- T-base
S- single stage
O16 - 16" overhang
C - C-base
D - dual stage

VENEER

Latitude is available in Quarter Cut Walnut and Rift Cut Oak veneers, and each is priced in this price guide. Maple and Cherry are also available: for Flat Cut Maple or Cherry veneer, use Column 1 pricing; for Quarter Cut Maple or Cherry, use Column 2 pricing. Other veneers are also available on Latitude, please contact us for a quote.

LATITUDE | HEIGHT ADJUSTABLE RETURN WORKSURFACES

| Description | Model | Rift | | W | D | H | KW | Shipping Weight | Cubic Feet |
|-------------------------------------|----------------|------|--------|-------|----|---|----|-----------------|------------|
| | | Oak | Walnut | | | | | | |
| Electronic Height Adjustable Return | 65HA4824RHETSG | 5244 | 5507 | 47.75 | 24 | - | 30 | 154.5 | 19 |
| Worksurfaces, Base Enclosures | 65HA5424RHETSG | 5289 | 5556 | 53.5 | 24 | - | 36 | 155 | 21.5 |
| | 65HA6024RHETSG | 5378 | 5646 | 59.75 | 24 | - | 42 | 156 | 24 |
| | 65HA6624RHETSG | 5620 | 5903 | 65.75 | 24 | - | 48 | 159 | 26.5 |
| | 65HA7224RHETSG | 5792 | 6081 | 71.75 | 24 | - | 54 | 164.5 | 29 |
| | 65HA7824RHETSG | 5918 | 6214 | 77.75 | 24 | - | 60 | 167.5 | 31.5 |
| | 65HA8424RHETSG | 5998 | 6297 | 83.75 | 24 | - | 66 | 172 | 34 |
| | 65HA4830RHETSG | 5616 | 5897 | 47.75 | 30 | - | 30 | 177.5 | 20.5 |
| | 65HA5430RHETSG | 5679 | 5964 | 53.5 | 30 | - | 36 | 178 | 23.5 |
| | 65HA6030RHETSG | 5757 | 6045 | 59.75 | 30 | - | 42 | 179 | 26.5 |
| | 65HA6630RHETSG | 5936 | 6232 | 65.75 | 30 | - | 48 | 186 | 29.75 |
| | 65HA7230RHETSG | 6102 | 6406 | 71.75 | 30 | - | 54 | 187.5 | 32.75 |
| | 65HA7830RHETSG | 6237 | 6548 | 77.75 | 30 | - | 60 | 197.5 | 35.75 |
| | 65HA8430RHETSG | 6544 | 6871 | 83.75 | 30 | - | 66 | 198.5 | 38.75 |
| | 65HA4836RHETSG | 6035 | 6337 | 47.75 | 36 | - | 30 | 187.5 | 20.75 |
| | 65HA5436RHETSG | 6109 | 6416 | 53.5 | 36 | - | 36 | 188 | 24.5 |
| | 65HA6036RHETSG | 6181 | 6490 | 59.75 | 36 | - | 42 | 189 | 28.25 |
| | 65HA6636RHETSG | 6328 | 6644 | 65.75 | 36 | - | 48 | 199 | 32 |
| | 65HA7236RHETSG | 6229 | 6541 | 71.75 | 36 | - | 54 | 216.5 | 35.5 |
| | 65HA7836RHETSG | 6772 | 7110 | 77.75 | 36 | - | 60 | 223.5 | 39.25 |
| | 65HA8436RHETSG | 6867 | 7210 | 83.75 | 36 | - | 66 | 224.5 | 43 |



ORDERING NOTES:

To order a Height Adjustable return or link unit work surface (cross grain direction) add "RH" to the model number before the "ETS" e.g. 65HA8436RHETSG

Height adjustable work surfaces, 48" or longer, are available with an optional 16" overhang at one end, add "O16" after "ETS" in the model number. e.g. 65HA8436ETSO16G

To order dual stage height adjustable base replace "ETS" with "ETD" and add **\$674 list.** e.g. 65HA8436ETD

To specify optional modesty panels add the model suffix and list upcharge shown on page 532. To allow clearance for Base Enclosures order modesty 3 sizes smaller. e.g. 72" work surface - order a 54" modesty.

Height Adjustable bases come standard with a Silver up/down button. Please contact customer service for alternate color availability. A 4 position programmable display is available, see page 557 for list price.

Single stage height adjustable range 28 3/8"-47 1/4"

Dual stage height adjustable range 23 7/16"-49 7/16"

Power cord is 10 feet long.

ORDERING PROCEDURE

To order, please specify the following:

- 1) Krug product model number
- 2) Wood species and finish
- 3) Grommet location and style if applicable.
- 4) Base option if applicable.
- 5) Modesty Panel option if applicable.

* Indicates model illustrated by line drawing

542 | CANADA | CASEGOODS

CODE DESCRIPTION

HA - height adjustable
 RH - return (cross grain)
 E - electric
 T - T- base
 C - C- base
 S - single stage
 D - dual stage





STANDARD FINISHES

For a complete list of standard wood finishes, please see page 518.

GROMMETS

One grommet in a standard position is optional at no charge. See page 521 for more information.

LATITUDE | MODESTY PANELS FOR HEIGHT ADJUSTABLE WORKSURFACES WITH BASE ENCLOSURES

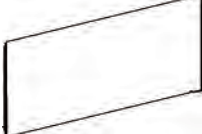
| Description | Model | Rift | | W | D | H | Shipping Weight |
|--|--------|------|--------|-------|------|----|-----------------|
| | | Oak | Walnut | | | | |
| 1/2 Height Floating Wood Modesty  | V21-48 | 297 | 312 | 47.75 | 0.75 | 12 | 9 |
| | V21-54 | 306 | 321 | 53.75 | 0.75 | 12 | 10 |
| | V21-60 | 317 | 331 | 59.75 | 0.75 | 12 | 11 |
| | V21-66 | 326 | 343 | 65.75 | 0.75 | 12 | 12 |
| | V21-72 | 336 | 352 | 71.75 | 0.75 | 12 | 14 |
| | V21-78 | 354 | 372 | 77.75 | 0.75 | 12 | 15 |
| | V21-84 | 396 | 415 | 83.75 | 0.75 | 12 | 16 |
| 1/2 Height Floating Palette Modesty  | V22-48 | 297 | | 47.75 | 0.75 | 12 | 9 |
| | V22-54 | 306 | | 53.75 | 0.75 | 12 | 10 |
| | V22-60 | 317 | | 59.75 | 0.75 | 12 | 11 |
| | V22-66 | 326 | | 65.75 | 0.75 | 12 | 12 |
| | V22-72 | 336 | | 71.75 | 0.75 | 12 | 14 |
| | V22-78 | 354 | | 77.75 | 0.75 | 12 | 15 |
| | V22-84 | 396 | | 83.75 | 0.75 | 12 | 16 |
| 1/2 Height Floating Back-painted Glass Modesty  | V24-48 | 948 | | 47.75 | 0.75 | 12 | 13 |
| | V24-54 | 977 | | 53.75 | 0.75 | 12 | 14 |
| | V24-60 | 1006 | | 59.75 | 0.75 | 12 | 15 |
| | V24-66 | 1038 | | 65.75 | 0.75 | 12 | 16 |
| | V24-72 | 1068 | | 71.75 | 0.75 | 12 | 18 |
| | V24-78 | 1116 | | 77.75 | 0.75 | 12 | 19 |
| | V24-84 | 1162 | | 83.75 | 0.75 | 12 | 20 |
| 1/2 Height Floating Acrylic Modesty  | V29-48 | 560 | | 47.75 | 0.75 | 12 | 7 |
| | V29-54 | 577 | | 53.75 | 0.75 | 12 | 8 |
| | V29-60 | 596 | | 59.75 | 0.75 | 12 | 9 |
| | V29-66 | 614 | | 65.75 | 0.75 | 12 | 10 |
| | V29-72 | 633 | | 71.75 | 0.75 | 12 | 12 |
| | V29-78 | 664 | | 77.75 | 0.75 | 12 | 13 |
| | V29-84 | 694 | | 83.75 | 0.75 | 12 | 14 |
| Full Height Fixed Wood Modesty  | X41-48 | 592 | 622 | 47.75 | 0.75 | 12 | 15 |
| | X41-54 | 612 | 642 | 53.75 | 0.75 | 12 | 18 |
| | X41-60 | 630 | 662 | 59.75 | 0.75 | 29 | 20 |
| | X41-66 | 648 | 681 | 65.75 | 0.75 | 29 | 24 |
| | X41-72 | 670 | 703 | 71.75 | 0.75 | 29 | 26 |
| | X41-78 | 708 | 744 | 77.75 | 0.75 | 29 | 30 |
| | X41-84 | 791 | 832 | 83.75 | 0.75 | 29 | 36 |







| | | |
|---|--|---|
| <p>DIMENSION KEY</p> <p>W – width D – depth H – height of worksurface KW – kneehole width</p> <p>Dimensions are in inches and approximate. Contact Customer Service if dimensions are critical.</p> | <p>CODE DESCRIPTION</p> <p>V21 - 1/2 height floating wood modesty V22 - 1/2 height floating palette modesty V24 - 1/2 height floating back-painted glass modesty V29 - 1/2 height floating acrylic modesty X41 - full height fixed wood modesty</p> | <p>VENEER</p> <p>Latitude is available in Quarter Cut Walnut and Rift Cut Oak veneers, and each is priced in this price guide. Maple and Cherry are also available: for Flat Cut Maple or Cherry veneer, use Column 1 pricing; for Quarter Cut Maple or Cherry, use Column 2 pricing. Other veneers are also available on Latitude, please contact us for a quote.</p> |
|---|--|---|

LATITUDE | DESK RUNOFFS

| Description | Model | Rift | | W | D | H | KW | Shipping Weight | Cubic Feet |
|------------------|--------------|------|--------|-------|----|------|-------|-----------------|------------|
| | | Oak | Walnut | | | | | | |
| Rectangular Desk | 65DR48304LD8 | 1734 | 1821 | 47.75 | 30 | 29.5 | 30.75 | 58 | 8.5 |
| Runoffs, 4" Dia. | 65DR48304RD8 | 1734 | 1821 | 47.75 | 30 | 29.5 | 30.75 | 58 | 8.5 |
| Metal Leg | 65DR48364LD8 | 1748 | 1835 | 47.75 | 36 | 29.5 | 27.75 | 66 | 9.5 |
| | 65DR48364RD8 | 1748 | 1835 | 47.75 | 36 | 29.5 | 27.75 | 66 | 9.5 |
| | 65DR54304LD8 | 1761 | 1852 | 53.75 | 30 | 29.5 | 36.75 | 63 | 9 |
| | 65DR54304RD8 | 1761 | 1852 | 53.75 | 30 | 29.5 | 36.75 | 63 | 9 |
| | 65DR54364LD8 | 1773 | 1861 | 53.75 | 36 | 29.5 | 33.75 | 71 | 10.5 |
| | 65DR54364RD8 | 1773 | 1861 | 53.75 | 36 | 29.5 | 33.75 | 71 | 10.5 |
| | 65DR60304LD8 | 1788 | 1878 | 59.75 | 30 | 29.5 | 42.75 | 68 | 10 |
| | 65DR60304RD8 | 1788 | 1878 | 59.75 | 30 | 29.5 | 42.75 | 68 | 10 |
| | 65DR60364LD8 | 1801 | 1890 | 59.75 | 36 | 29.5 | 39.75 | 77 | 11.5 |
| | 65DR60364RD8 | 1801 | 1890 | 59.75 | 36 | 29.5 | 39.75 | 77 | 11.5 |
| | 65DR66304LD8 | 1811 | 1902 | 65.75 | 30 | 29.5 | 48.75 | 99 | 10.75 |
| | 65DR66304RD8 | 1811 | 1902 | 65.75 | 30 | 29.5 | 48.75 | 99 | 10.75 |
| | 65DR66364LD8 | 1836 | 1928 | 65.75 | 36 | 29.5 | 45.75 | 88 | 12.5 |
| | 65DR66364RD8 | 1836 | 1928 | 65.75 | 36 | 29.5 | 45.75 | 88 | 12.5 |
| | 65DR72304LD8 | 1884 | 1979 | 71.75 | 30 | 29.5 | 54.75 | 104 | 11.5 |
| | 65DR72304RD8 | 1884 | 1979 | 71.75 | 30 | 29.5 | 54.75 | 104 | 11.5 |
| | 65DR72364LD8 | 1932 | 2029 | 71.75 | 36 | 29.5 | 51.75 | 95 | 13.5 |
| | 65DR72364RD8 | 1932 | 2029 | 71.75 | 36 | 29.5 | 51.75 | 95 | 13.5 |
| | 65DR78304LD8 | 1941 | 2037 | 77.75 | 30 | 29.5 | 56.75 | 58 | 8.5 |
| | 65DR78304RD8 | 1941 | 2037 | 77.75 | 30 | 29.5 | 56.75 | 58 | 8.5 |
| | 65DR78364LD8 | 1989 | 2088 | 77.75 | 36 | 29.5 | 56.75 | 66 | 9.5 |
| | 65DR78364RD8 | 1989 | 2088 | 77.75 | 36 | 29.5 | 56.75 | 66 | 9.5 |
| | 65DR84304LD8 | 1999 | 2100 | 83.75 | 30 | 29.5 | 66.75 | 114 | 13 |
| | 65DR84304RD8 | 1999 | 2100 | 83.75 | 30 | 29.5 | 66.75 | 114 | 13 |
| | 65DR84364LD8 | 2048 | 2149 | 83.75 | 36 | 29.5 | 63.75 | 108 | 15 |
| | 65DR84364RD8 | 2048 | 2149 | 83.75 | 36 | 29.5 | 63.75 | 108 | 15 |

ORDERING NOTES: To specify optional bases on desk Runoffs see option chart, replace "D8" in the model number with model suffix below and add list upcharge. When specifying a modesty panel add -20 before modesty panel suffix when runoff is to be used with a 20" deep credenza, add -24 when runoff is to be used with a 24" deep credenza. See page 531 for Modesty Panel options.

DESK RUNOFF BASE OPTION UPCHARGES

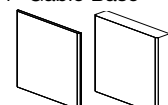
| Description | Model | List | Added Weight | Description | Model | Rift | | Added Weight |
|---|-------|------|--------------|---|-------|------|--------|--------------|
| | | | | | | Oak | Walnut | |
| Disc Base | DB | 189 | 30 | BBF Pedestal | 4F | 1672 | 1757 | 83 |
|  | | | |  | | | | |
| Square Plate Base | SQ | 226 | 30 | FF Pedestal | 4D | 1449 | 1522 | 78 |
|  | | | |  | | | | |
| O-Base | OB | 643 | 18 | BF Pedestal | 3F | 1373 | 1440 | 54 |
|  | | | |  | | | | |
| 2- 2" Square Metal Leg | M | 565 | 19 | Gable Base | GB | 481 | 507 | 20 |
|  | | | | 4" Gable Base | 4G | 515 | 540 | 28 |
| | | | |  | | | | |

ORDERING PROCEDURE

To order, please specify the following:

- 1) Krug product model number
- 2) Wood species and finish
- 3) Grommet location and style if applicable.
- 4) Base option if applicable.
- 5) Modesty Panel option if applicable.

CODE DESCRIPTION

- 4 - Full Height
- L - left hand position
- R - right hand position

STANDARD FINISHES

For a complete list of standard wood finishes, please see page 518.

GROMMETS

One grommet in a standard position is optional at no charge. See page 539 for more information.

* Indicates model illustrated by line drawing
544 | CANADA | CASEGOODS

LATITUDE | DESK RUNOFFS

| Description | Model | Rift | | W | D | H | KW | Shipping Weight | Cubic Feet |
|------------------|---------------|------|--------|-------|----|------|-------|-----------------|------------|
| | | Oak | Walnut | | | | | | |
| Arc End Desk | 65DRA48304LD8 | 1734 | 1821 | 47.75 | 30 | 29.5 | 30.75 | 58 | 8.5 |
| Runoffs, 4" Dia. | 65DRA48304RD8 | 1734 | 1821 | 47.75 | 30 | 29.5 | 30.75 | 58 | 8.5 |
| Metal Leg | 65DRA48364LD8 | 1748 | 1835 | 47.75 | 36 | 29.5 | 27.75 | 66 | 9.5 |
| | 65DRA48364RD8 | 1748 | 1835 | 47.75 | 36 | 29.5 | 27.75 | 66 | 9.5 |
| | 65DRA54304LD8 | 1761 | 1852 | 53.75 | 30 | 29.5 | 36.75 | 63 | 9 |
| | 65DRA54304RD8 | 1761 | 1852 | 53.75 | 30 | 29.5 | 36.75 | 63 | 9 |
| | 65DRA54364LD8 | 1773 | 1861 | 53.75 | 36 | 29.5 | 33.75 | 71 | 10.5 |
| | 65DRA54364RD8 | 1773 | 1861 | 53.75 | 36 | 29.5 | 33.75 | 71 | 10.5 |
| | 65DRA60304LD8 | 1788 | 1878 | 59.75 | 30 | 29.5 | 42.75 | 68 | 10 |
| | 65DRA60304RD8 | 1788 | 1878 | 59.75 | 30 | 29.5 | 42.75 | 68 | 10 |
| | 65DRA60364LD8 | 1801 | 1890 | 59.75 | 36 | 29.5 | 39.75 | 77 | 11.5 |
| | 65DRA60364RD8 | 1801 | 1890 | 59.75 | 36 | 29.5 | 39.75 | 77 | 11.5 |
| | 65DRA66304LD8 | 1811 | 1902 | 65.75 | 30 | 29.5 | 48.75 | 99 | 10.75 |
| | 65DRA66304RD8 | 1811 | 1902 | 65.75 | 30 | 29.5 | 48.75 | 99 | 10.75 |
| | 65DRA66364LD8 | 1836 | 1928 | 65.75 | 36 | 29.5 | 45.75 | 88 | 12.5 |
| | 65DRA66364RD8 | 1836 | 1928 | 65.75 | 36 | 29.5 | 45.75 | 88 | 12.5 |
| | 65DRA72304LD8 | 1884 | 1979 | 71.75 | 30 | 29.5 | 54.75 | 104 | 11.5 |
| | 65DRA72304RD8 | 1884 | 1979 | 71.75 | 30 | 29.5 | 54.75 | 104 | 11.5 |
| | 65DRA72364LD8 | 1932 | 2029 | 71.75 | 36 | 29.5 | 51.75 | 95 | 13.5 |
| | 65DRA72364RD8 | 1932 | 2029 | 71.75 | 36 | 29.5 | 51.75 | 95 | 13.5 |
| | 65DRA78304LD8 | 1941 | 2037 | 77.75 | 30 | 29.5 | 56.75 | 58 | 8.5 |
| | 65DRA78304RD8 | 1941 | 2037 | 77.75 | 30 | 29.5 | 56.75 | 58 | 8.5 |
| | 65DRA78364LD8 | 1989 | 2088 | 77.75 | 36 | 29.5 | 56.75 | 66 | 9.5 |
| | 65DRA78364RD8 | 1989 | 2088 | 77.75 | 36 | 29.5 | 56.75 | 66 | 9.5 |
| | 65DRA84304LD8 | 1999 | 2100 | 83.75 | 30 | 29.5 | 66.75 | 114 | 13 |
| | 65DRA84304RD8 | 1999 | 2100 | 83.75 | 30 | 29.5 | 66.75 | 114 | 13 |
| | 65DRA84364LD8 | 2048 | 2149 | 83.75 | 36 | 29.5 | 63.75 | 108 | 15 |
| | 65DRA84364RD8 | 2048 | 2149 | 83.75 | 36 | 29.5 | 63.75 | 108 | 15 |



ORDERING NOTES: To specify optional Disc base on desk Runoffs see option chart below, replace "D8" in the model number with model suffix below and add list upcharge. When specifying a modesty panel add -20 before modesty panel suffix when runoff is to be used with a 20" deep credenza, add -24 when runoff is to be used with a 24" deep credenza. See page 531 for Modesty Panel options.

OPEN DESK BASE OPTION UPCHARGES

| Description | Model | List | Added Weight |
|-------------|-------|------|--------------|
| Disc Base | DB | 189 | 30 |



DIMENSION KEY

W — width
D — depth
H — height of worksurface
KW— kneehole width

Dimensions are in inches and approximate.
Contact Customer Service if dimensions are critical.

CODE DESCRIPTION

4 - full Height
L - left hand position
R - right hand position

VENEER

Latitude is available in Quarter Cut Walnut and Rift Cut Oak veneers, and each is priced in this price guide. Maple and Cherry are also available: for Flat Cut Maple or Cherry veneer, use Column 1 pricing; for Quarter Cut Maple or Cherry, use Column 2 pricing. Other veneers are also available on Latitude, please contact us for a quote.

LATITUDE | DESK RUNOFFS

| Description | Model | Rift | | W | D | H | KW | Shipping Weight | Cubic Feet |
|--|---------------|------|--------|-------|------|-------|-------|-----------------|------------|
| | | Oak | Walnut | | | | | | |
|  Bullet Desk Runoffs, 4" Dia. Metal Leg | 65DRB48304LD8 | 1734 | 1821 | 47.75 | 30 | 29.5 | 30.75 | 58 | 8.5 |
| | 65DRB48304RD8 | 1734 | 1821 | 47.75 | 30 | 29.5 | 30.75 | 58 | 8.5 |
| | 65DRB48364LD8 | 1748 | 1835 | 47.75 | 36 | 29.5 | 27.75 | 66 | 9.5 |
| | 65DRB48364RD8 | 1748 | 1835 | 47.75 | 36 | 29.5 | 27.75 | 66 | 9.5 |
| | 65DRB54304LD8 | 1761 | 1852 | 53.75 | 30 | 29.5 | 36.75 | 63 | 9 |
| | 65DRB54304RD8 | 1761 | 1852 | 53.75 | 30 | 29.5 | 36.75 | 63 | 9 |
| | 65DRB54364LD8 | 1773 | 1861 | 53.75 | 36 | 29.5 | 33.75 | 71 | 10.5 |
| | 65DRB54364RD8 | 1773 | 1861 | 53.75 | 36 | 29.5 | 33.75 | 71 | 10.5 |
| | 65DRB60304LD8 | 1788 | 1878 | 59.75 | 30 | 29.5 | 42.75 | 68 | 10 |
| | 65DRB60304RD8 | 1788 | 1878 | 59.75 | 30 | 29.5 | 42.75 | 68 | 10 |
| | 65DRB60364LD8 | 1801 | 1890 | 59.75 | 36 | 29.5 | 39.75 | 77 | 11.5 |
| | 65DRB60364RD8 | 1801 | 1890 | 59.75 | 36 | 29.5 | 39.75 | 77 | 11.5 |
| | 65DRB66304LD8 | 1811 | 1902 | 65.75 | 30 | 29.5 | 48.75 | 99 | 10.75 |
| | 65DRB66304RD8 | 1811 | 1902 | 65.75 | 30 | 29.5 | 48.75 | 99 | 10.75 |
| | 65DRB66364LD8 | 1836 | 1928 | 65.75 | 36 | 29.5 | 45.75 | 88 | 12.5 |
| | 65DRB66364RD8 | 1836 | 1928 | 65.75 | 36 | 29.5 | 45.75 | 88 | 12.5 |
| | 65DRB72304LD8 | 1884 | 1979 | 71.75 | 30 | 29.5 | 54.75 | 104 | 11.5 |
| | 65DRB72304RD8 | 1884 | 1979 | 71.75 | 30 | 29.5 | 54.75 | 104 | 11.5 |
| | 65DRB72364LD8 | 1932 | 2029 | 71.75 | 36 | 29.5 | 51.75 | 95 | 13.5 |
| | 65DRB72364RD8 | 1932 | 2029 | 71.75 | 36 | 29.5 | 51.75 | 95 | 13.5 |
| | 65DRB78304LD8 | 1941 | 2037 | 77.75 | 30 | 29.5 | 56.75 | 58 | 8.5 |
| | 65DRB78304RD8 | 1941 | 2037 | 77.75 | 30 | 29.5 | 56.75 | 58 | 8.5 |
| | 65DRB78364LD8 | 1989 | 2088 | 77.75 | 36 | 29.5 | 56.75 | 66 | 9.5 |
| | 65DRB78364RD8 | 1989 | 2088 | 77.75 | 36 | 29.5 | 56.75 | 66 | 9.5 |
| | 65DRB84304LD8 | 1999 | 2100 | 83.75 | 30 | 29.5 | 66.75 | 114 | 13 |
| | 65DRB84304RD8 | 1999 | 2100 | 83.75 | 30 | 29.5 | 66.75 | 114 | 13 |
| | 65DRB84364LD8 | 2048 | 2149 | 83.75 | 36 | 29.5 | 63.75 | 108 | 15 |
| 65DRB84364RD8 | 2048 | 2149 | 83.75 | 36 | 29.5 | 63.75 | 108 | 15 | |

ORDERING NOTES: To specify optional Disc base on desk Runoffs see option chart below, replace "D8" in the model number with model suffix below and add list upcharge. When specifying a modesty panel add -20 before modesty panel suffix when runoff is to be used with a 20" deep credenza, add -24 when runoff is to be used with a 24" deep credenza. See page 531 for Modesty Panel options.

OPEN DESK BASE OPTION UPCHARGES

| Description | Model | List | Added Weight |
|-------------|-------|------|--------------|
| Disc Base | DB | 189 | 30 |



ORDERING PROCEDURE

To order, please specify the following:

- 1) Krug product model number
- 2) Wood species and finish
- 3) Grommet location and style if applicable.
- 4) Base option if applicable.
- 5) Modesty Panel option if applicable.

* Indicates model illustrated by line drawing

CODE DESCRIPTION

- 4 - full Height
- L - left hand position
- R - right hand position

STANDARD FINISHES

For a complete list of standard wood finishes, please see page 518.

GROMMETS







One grommet in a standard position is optional at no charge. See page 521 for more information.

LATITUDE | RECTANGULAR DESK RUNOFFS FOR 3/4 CREDENZAS

| Description | Model | Rift | | W | D | H | KW | Shipping Weight | Cubic Feet |
|--|--------------|------|--------|-------|----|------|------|-----------------|------------|
| | | Oak | Walnut | | | | | | |
|  Rectangular Desk Runoffs, 4" Dia. Metal Leg | 65DR60303LD8 | 1817 | 1908 | 59.75 | 30 | 29.5 | 21.5 | 68 | 10 |
| | 65DR60303RD8 | 1817 | 1908 | 59.75 | 30 | 29.5 | 21.5 | 68 | 10 |
| | 65DR60363LD8 | 1832 | 1922 | 59.75 | 36 | 29.5 | 21.5 | 77 | 11.5 |
| | 65DR60363RD8 | 1832 | 1922 | 59.75 | 36 | 29.5 | 21.5 | 77 | 11.5 |
| | 65DR66303LD8 | 1845 | 1937 | 65.75 | 30 | 29.5 | 27.5 | 99 | 10.75 |
| | 65DR66303RD8 | 1845 | 1937 | 65.75 | 30 | 29.5 | 27.5 | 99 | 10.75 |
| | 65DR66363LD8 | 1886 | 1981 | 65.75 | 36 | 29.5 | 24.5 | 88 | 12.5 |
| | 65DR66363RD8 | 1886 | 1981 | 65.75 | 36 | 29.5 | 24.5 | 88 | 12.5 |
| | 65DR72303LD8 | 1921 | 2017 | 71.75 | 30 | 29.5 | 33 | 104 | 11.5 |
| | 65DR72303RD8 | 1921 | 2017 | 71.75 | 30 | 29.5 | 33 | 104 | 11.5 |
| | 65DR72363LD8 | 1945 | 2103 | 71.75 | 36 | 29.5 | 30 | 95 | 13.5 |
| | 65DR72363RD8 | 1945 | 2103 | 71.75 | 36 | 29.5 | 30 | 95 | 13.5 |
| | 65DR78303LD8 | 2024 | 2124 | 77.75 | 30 | 29.5 | 39 | 58 | 8.5 |
| | 65DR78303RD8 | 2024 | 2124 | 77.75 | 30 | 29.5 | 39 | 58 | 8.5 |
| | 65DR78363LD8 | 2337 | 2453 | 77.75 | 36 | 29.5 | 36 | 66 | 9.5 |
| | 65DR78363RD8 | 2337 | 2453 | 77.75 | 36 | 29.5 | 36 | 66 | 9.5 |
| | 65DR84303LD8 | 2682 | 2816 | 83.75 | 30 | 29.5 | 45 | 114 | 13 |
| | 65DR84303RD8 | 2682 | 2816 | 83.75 | 30 | 29.5 | 45 | 114 | 13 |
| | 65DR84363LD8 | 3242 | 3405 | 83.75 | 36 | 29.5 | 42 | 108 | 15 |
| | 65DR84363RD8 | 3242 | 3405 | 83.75 | 36 | 29.5 | 42 | 108 | 15 |

ORDERING NOTES: To specify optional bases on desk Runoffs see option chart below, replace "D8" in the model number with model suffix below and add list upcharge. When specifying a modesty panel add -20 before modesty panel suffix when runoff is to be used with a 20" deep credenza, add -24 when runoff is to be used with a 24" deep credenza. See page 531 for Modesty Panel options.

DESK RUNOFF BASE OPTION UPCHARGES

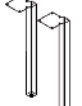
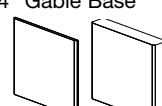
| Description | Model | List | Added Weight | Description | Model | Rift Oak | Walnut | Added Weight |
|--|-------|------|--------------|---|----------|------------|------------|--------------|
|  Disc Base | DB | 189 | 30 |  BBF Pedestal | 4F | 1672 | 1757 | 83 |
|  Square Plate Base | SQ | 226 | 30 |  FF Pedestal | 4D | 1449 | 1522 | 78 |
|  O-Base OB | OB | 643 | 18 |  BF Pedestal | 3F | 1373 | 1440 | 54 |
|  2 - 2" Square Metal Leg M | M | 565 | 19 |  Gable Base 4" Gable Base | GB 4G | 481 515 | 507 540 | 20 28 |

DIMENSION KEY

W — width
 D — depth
 H — height of worksurface
 KW — knee-hole width

Dimensions are in inches and approximate.
 Contact Customer Service if dimensions are critical.

CODE DESCRIPTION

3 - 3/4 Height Pedestal
 L - left hand position
 R - right hand position

VENEER

Latitude is available in Quarter Cut Walnut and Rift Cut Oak veneers, and each is priced in this price guide. Maple and Cherry are also available: for Flat Cut Maple or Cherry veneer, use Column 1 pricing; for Quarter Cut Maple or Cherry, use Column 2 pricing. Other veneers are also available on Latitude, please contact us for a quote.

LATITUDE | DESK RUNOFFS FOR 3/4 HEIGHT CREDENZAS

| Description | Model | Rift | | W | D | H | KW | Shipping Weight | Cubic Feet | |
|------------------|---------------|------|--------|-------|----|------|------|-----------------|------------|--|
| | | Oak | Walnut | | | | | | | |
| Arc End Desk | 65DRA60303LD8 | 1817 | 1908 | 59.75 | 30 | 29.5 | 21.5 | 68 | 10 | |
| Runoffs, 4" Dia. | 65DRA60303RD8 | 1817 | 1908 | 59.75 | 30 | 29.5 | 21.5 | 68 | 10 | |
| Metal Leg | 65DRA60363LD8 | 1832 | 1922 | 59.75 | 36 | 29.5 | 21.5 | 77 | 11.5 | |
| | 65DRA60363RD8 | 1832 | 1922 | 59.75 | 36 | 29.5 | 21.5 | 77 | 11.5 | |
| | 65DRA66303LD8 | 1845 | 1937 | 65.75 | 30 | 29.5 | 27.5 | 99 | 10.75 | |
| | 65DRA66303RD8 | 1845 | 1937 | 65.75 | 30 | 29.5 | 27.5 | 99 | 10.75 | |
| | 65DRA66363LD8 | 1886 | 1981 | 65.75 | 36 | 29.5 | 24.5 | 88 | 12.5 | |
| | 65DRA66363RD8 | 1886 | 1981 | 65.75 | 36 | 29.5 | 24.5 | 88 | 12.5 | |
| | 65DRA72303LD8 | 1921 | 2017 | 71.75 | 30 | 29.5 | 33 | 104 | 11.5 | |
| | 65DRA72303RD8 | 1921 | 2017 | 71.75 | 30 | 29.5 | 33 | 104 | 11.5 | |
| | 65DRA72363LD8 | 1945 | 2103 | 71.75 | 36 | 29.5 | 30 | 95 | 13.5 | |
| | 65DRA72363RD8 | 1945 | 2103 | 71.75 | 36 | 29.5 | 30 | 95 | 13.5 | |
| | 65DRA78303LD8 | 2024 | 2124 | 77.75 | 30 | 29.5 | 39 | 58 | 8.5 | |
| | 65DRA78303RD8 | 2024 | 2124 | 77.75 | 30 | 29.5 | 39 | 58 | 8.5 | |
| | 65DRA78363LD8 | 2337 | 2453 | 77.75 | 36 | 29.5 | 36 | 66 | 9.5 | |
| | 65DRA78363RD8 | 2337 | 2453 | 77.75 | 36 | 29.5 | 36 | 66 | 9.5 | |
| | 65DRA84303LD8 | 2682 | 2816 | 83.75 | 30 | 29.5 | 45 | 114 | 13 | |
| | 65DRA84303RD8 | 2682 | 2816 | 83.75 | 30 | 29.5 | 45 | 114 | 13 | |
| | 65DRA84363LD8 | 3242 | 3405 | 83.75 | 36 | 29.5 | 42 | 108 | 15 | |
| | 65DRA84363RD8 | 3242 | 3405 | 83.75 | 36 | 29.5 | 42 | 108 | 15 | |
| <hr/> | | | | | | | | | | |
| Bullet Desk | 65DRB60303LD8 | 1817 | 1908 | 59.75 | 30 | 29.5 | 21.5 | 68 | 10 | |
| Runoffs, 4" Dia. | 65DRB60303RD8 | 1817 | 1908 | 59.75 | 30 | 29.5 | 21.5 | 68 | 10 | |
| Metal Leg | 65DRB60363LD8 | 1832 | 1922 | 59.75 | 36 | 29.5 | 21.5 | 77 | 11.5 | |
| | 65DRB60363RD8 | 1832 | 1922 | 59.75 | 36 | 29.5 | 21.5 | 77 | 11.5 | |
| | 65DRB66303LD8 | 1845 | 1937 | 65.75 | 30 | 29.5 | 27.5 | 99 | 10.75 | |
| | 65DRB66303RD8 | 1845 | 1937 | 65.75 | 30 | 29.5 | 27.5 | 99 | 10.75 | |
| | 65DRB66363LD8 | 1886 | 1981 | 65.75 | 36 | 29.5 | 24.5 | 88 | 12.5 | |
| | 65DRB66363RD8 | 1886 | 1981 | 65.75 | 36 | 29.5 | 24.5 | 88 | 12.5 | |
| | 65DRB72303LD8 | 1921 | 2017 | 71.75 | 30 | 29.5 | 33 | 104 | 11.5 | |
| | 65DRB72303RD8 | 1921 | 2017 | 71.75 | 30 | 29.5 | 33 | 104 | 11.5 | |
| | 65DRB72363LD8 | 1945 | 2103 | 71.75 | 36 | 29.5 | 30 | 95 | 13.5 | |
| | 65DRB72363RD8 | 1945 | 2103 | 71.75 | 36 | 29.5 | 30 | 95 | 13.5 | |
| | 65DRB78303LD8 | 2024 | 2124 | 77.75 | 30 | 29.5 | 39 | 58 | 8.5 | |
| | 65DRB78303RD8 | 2024 | 2124 | 77.75 | 30 | 29.5 | 39 | 58 | 8.5 | |
| | 65DRB78363LD8 | 2337 | 2453 | 77.75 | 36 | 29.5 | 36 | 66 | 9.5 | |
| | 65DRB78363RD8 | 2337 | 2453 | 77.75 | 36 | 29.5 | 36 | 66 | 9.5 | |
| | 65DRB84303LD8 | 2682 | 2816 | 83.75 | 30 | 29.5 | 45 | 114 | 13 | |
| | 65DRB84303RD8 | 2682 | 2816 | 83.75 | 30 | 29.5 | 45 | 114 | 13 | |
| | 65DRB84363LD8 | 3242 | 3405 | 83.75 | 36 | 29.5 | 42 | 108 | 15 | |
| | 65DRB84363RD8 | 3242 | 3405 | 83.75 | 36 | 29.5 | 42 | 108 | 15 | |

ORDERING NOTES: To specify optional Disc base on desk Runoffs see option chart below, replace "D8" in the model number with model suffix below and add list upcharge. When specifying a modesty panel add -20 before modesty panel suffix when runoff is to be used with a 20" deep credenza, add -24 when runoff is to be used with a 24" deep credenza. See page 531 for Modesty Panel options.

OPEN DESK BASE OPTION UPCHARGES

| Description | Model | List | Added Weight |
|-------------|-------|------|--------------|
| Disc Base | DB | 199 | 30 |



ORDERING PROCEDURE

To order, please specify the following:

- 1) Krug product model number
- 2) Wood species and finish
- 3) Grommet location and style if applicable.

* Indicates model illustrated by line drawing

CODE DESCRIPTION

- 3 - 3/4 Height Pedestal
- L - left hand position
- R - right hand position

STANDARD FINISHES

For a complete list of standard wood finishes, please see page 518.

GROMMETS

One grommet in a standard position is optional at no charge. See page 521 for more information.

MODESTY PANEL

For the hinged modesty panel option add Y after RH and add a 10% upcharge. e.g. 65RHY6024L4DX41.

| Description | Model | Rift | | W | D | H | KW | Shipping Weight | Cubic Feet |
|---|-----------------|------|--------|-------|------|------|-----|-----------------|------------|
| | | Oak | Walnut | | | | | | |
| Return Shell, Fixed Full Ht Wood Modesty | 65SRH3024LX41 | 1318 | 1386 | 29.75 | 24 | 29.5 | 29 | 72.5 | 18.25 |
| | 65SRH3024RX41* | 1318 | 1386 | 29.75 | 24 | 29.5 | 29 | 72.5 | 18 |
| | 65SRH3624LX41 | 1408 | 1479 | 35.75 | 24 | 29.5 | 35 | 87 | 21.5 |
| | 65SRH3624RX41 | 1408 | 1479 | 35.75 | 24 | 29.5 | 35 | 87 | 21.5 |
| | 65SRH4224LX41 | 1570 | 1648 | 41.75 | 24 | 29.5 | 41 | 98 | 24.5 |
| | 65SRH4224RX41 | 1570 | 1648 | 41.75 | 24 | 29.5 | 41 | 98 | 24.5 |
| | 65SRH4824LX41 | 1582 | 1661 | 47.75 | 24 | 29.5 | 47 | 108 | 27.5 |
| | 65SRH4824RX41 | 1582 | 1661 | 47.75 | 24 | 29.5 | 47 | 108 | 27.5 |
| | 65SRH5424LX41 | 1632 | 1713 | 53.75 | 24 | 29.5 | 53 | 114.5 | 30.75 |
| | 65SRH5424RX41 | 1632 | 1713 | 53.75 | 24 | 29.5 | 53 | 114.5 | 30.75 |
| | 65SRH6024LX41 | 1676 | 1760 | 59.75 | 24 | 29.5 | 65 | 124 | 33.75 |
| | 65SRH6024RX41 | 1676 | 1760 | 59.75 | 24 | 29.5 | 65 | 124 | 33.75 |
| | 65SRH6624LX41 | 1727 | 1813 | 65.75 | 24 | 29.5 | 65 | 133 | 37 |
| | 65SRH6624RX41 | 1727 | 1813 | 65.75 | 24 | 29.5 | 65 | 133 | 37 |
| | 65SRH7224LX41 | 1778 | 1867 | 71.75 | 24 | 29.5 | 71 | 142 | 40 |
| | 65SRH7224RX41 | 1778 | 1867 | 71.75 | 24 | 29.5 | 71 | 142 | 40 |
| Single Pedestal Return , Full Height Fixed Wood Modesty | 65RH3620L4DX41 | 2182 | 2291 | 35.75 | 20 | 29.5 | 20 | 104 | 18.25 |
| | 65RH3620L4FX41* | 2182 | 2291 | 35.75 | 20 | 29.5 | 20 | 104 | 18.25 |
| | 65RH3620R4DX41 | 2182 | 2291 | 35.75 | 20 | 29.5 | 20 | 108 | 18.25 |
| | 65RH3620R4FX41 | 2182 | 2291 | 35.75 | 20 | 29.5 | 20 | 108 | 18.25 |
| | 65RH3624L4DX41 | 2252 | 2364 | 35.75 | 24 | 29.5 | 20 | 115 | 21.5 |
| | 65RH3624L4FX41 | 2252 | 2364 | 35.75 | 24 | 29.5 | 20 | 115 | 21.5 |
| | 65RH3624R4DX41 | 2252 | 2364 | 35.75 | 24 | 29.5 | 20 | 119 | 21.5 |
| | 65RH3624R4FX41 | 2252 | 2364 | 35.75 | 24 | 29.5 | 20 | 119 | 21.5 |
| | 65RH4220L4DX41 | 2785 | 2924 | 41.75 | 20 | 29.5 | 26 | 100 | 21 |
| | 65RH4220L4FX41 | 2785 | 2924 | 41.75 | 20 | 29.5 | 26 | 100 | 21 |
| | 65RH4220R4DX41 | 2785 | 2924 | 41.75 | 20 | 29.5 | 26 | 100 | 21 |
| | 65RH4220R4FX41 | 2785 | 2924 | 41.75 | 20 | 29.5 | 26 | 100 | 21 |
| | 65RH4224L4DX41 | 2805 | 2946 | 41.75 | 24 | 29.5 | 26 | 104 | 24.5 |
| | 65RH4224L4FX41 | 2805 | 2946 | 41.75 | 24 | 29.5 | 26 | 104 | 24.5 |
| | 65RH4224R4DX41 | 2805 | 2946 | 41.75 | 24 | 29.5 | 26 | 104 | 24.5 |
| | 65RH4224R4FX41 | 2805 | 2946 | 41.75 | 24 | 29.5 | 26 | 104 | 24.5 |
| | 65RH4820L4DX41 | 2829 | 2970 | 48.75 | 20 | 29.5 | 32 | 104 | 23.75 |
| | 65RH4820L4FX41 | 2829 | 2970 | 48.75 | 20 | 29.5 | 32 | 104 | 23.75 |
| | 65RH4820R4DX41 | 2829 | 2970 | 48.75 | 20 | 29.5 | 32 | 104 | 23.75 |
| | 65RH4820R4FX41 | 2829 | 2970 | 48.75 | 20 | 29.5 | 32 | 104 | 23.75 |
| | 65RH4824L4DX41 | 2839 | 2983 | 48.75 | 24 | 29.5 | 32 | 108 | 27.5 |
| | 65RH4824L4FX41 | 2839 | 2983 | 48.75 | 24 | 29.5 | 32 | 108 | 27.5 |
| | 65RH4824R4DX41 | 2839 | 2983 | 48.75 | 24 | 29.5 | 32 | 108 | 27.5 |
| | 65RH4824R4FX41 | 2839 | 2983 | 48.75 | 24 | 29.5 | 32 | 108 | 27.5 |
| | 65RH5424L4DX41 | 2863 | 3008 | 53.75 | 24 | 29.5 | 38 | 138 | 30.75 |
| | 65RH5424L4FX41 | 2863 | 3008 | 53.75 | 24 | 29.5 | 38 | 138 | 30.75 |
| | 65RH5424R4DX41 | 2863 | 3008 | 53.75 | 24 | 29.5 | 38 | 142 | 30.75 |
| | 65RH5424R4FX41 | 2863 | 3008 | 53.75 | 24 | 29.5 | 38 | 142 | 30.75 |
| | 65RH6024L4DX41 | 2886 | 3031 | 59.75 | 24 | 29.5 | 38 | 146 | 33.75 |
| | 65RH6024L4FX41 | 2886 | 3031 | 59.75 | 24 | 29.5 | 38 | 146 | 33.75 |
| | 65RH6024R4DX41 | 2886 | 3031 | 59.75 | 24 | 29.5 | 38 | 150 | 33.75 |
| | 65RH6024R4FX41 | 2886 | 3031 | 59.75 | 24 | 29.5 | 38 | 150 | 33.75 |
| 65RH6624L4DX41 | 2972 | 3121 | 65.75 | 24 | 29.5 | 50 | 158 | 37 | |
| 65RH6624L4FX41 | 2972 | 3121 | 65.75 | 24 | 29.5 | 50 | 158 | 37 | |
| 65RH6624R4DX41 | 2972 | 3121 | 65.75 | 24 | 29.5 | 50 | 162 | 37 | |
| 65RH6624R4FX41 | 2972 | 3121 | 65.75 | 24 | 29.5 | 50 | 162 | 37 | |
| 65RH7224L4DX41 | 3066 | 3217 | 71.75 | 24 | 29.5 | 50 | 166 | 40 | |
| 65RH7224L4FX41 | 3066 | 3217 | 71.75 | 24 | 29.5 | 50 | 166 | 40 | |
| 65RH7224R4DX41 | 3066 | 3217 | 71.75 | 24 | 29.5 | 50 | 170 | 40 | |
| 65RH7224R4FX41 | 3066 | 3217 | 71.75 | 24 | 29.5 | 50 | 170 | 40 | |

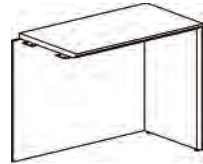

DIMENSION KEY

W — width
 D — depth
 H — height of worksurface
 KW— kneehole width

Dimensions are in inches and approximate. Contact Customer Service if dimensions are critical.

CODE DESCRIPTION

L - left hand position
 R - right hand position
 D - 2 file drawers
 F - 2 box, 1 file drawer
 X41 - full height fixed wood modesty
 X21 - 1/2 height fixed wood modesty

VENEER

Latitude is available in Quarter Cut Walnut and Rift Cut Oak veneers, and each is priced in this price guide. Maple and Cherry are also available: for Flat Cut Maple or Cherry veneer, use Column 1 pricing; for Quarter Cut Maple or Cherry, use Column 2 pricing. Other veneers are also available on Latitude, please contact us for a quote.

LATITUDE | LINKING UNITS AND CORNER UNITS

| Description | Model | Rift | | W | D | H | KW | Shipping Weight | Cubic Feet |
|--|-------------------|------|--------|-------|------|------|----|-----------------|------------|
| | | Oak | Walnut | | | | | | |
|  Single Pedestal Return for Table Desk, Full Height Fixed Wood Modesty | 65RHTD4224L4DX41 | 2611 | 2742 | 42 | 24 | 29.5 | 26 | 61 | 24.5 |
| | 65RHTD4224L4FX41* | 2611 | 2742 | 42 | 24 | 29.5 | 26 | 61 | 24.5 |
| | 65RHTD4224R4DX41 | 2611 | 2742 | 42 | 24 | 29.5 | 26 | 61 | 24.5 |
| | 65RHTD4224R4FX41 | 2611 | 2742 | 42 | 24 | 29.5 | 26 | 61 | 24.5 |
| | 65RHTD4824L4DX41 | 2638 | 2770 | 48 | 24 | 29.5 | 32 | 67 | 27.5 |
| | 65RHTD4824L4FX41 | 2638 | 2770 | 48 | 24 | 29.5 | 32 | 67 | 27.5 |
| | 65RHTD4824R4DX41 | 2638 | 2770 | 48 | 24 | 29.5 | 32 | 67 | 27.5 |
| | 65RHTD4824R4FX41 | 2638 | 2770 | 48 | 24 | 29.5 | 32 | 67 | 27.5 |
| | 65RHTD6024L4DX41 | 2665 | 2800 | 59.75 | 24 | 29.5 | 44 | 78 | 33.75 |
| | 65RHTD6024L4FX41 | 2665 | 2800 | 59.75 | 24 | 29.5 | 44 | 78 | 33.75 |
| | 65RHTD6024R4DX41 | 2665 | 2800 | 59.75 | 24 | 29.5 | 44 | 78 | 33.75 |
| 65RHTD6024R4FX41 | 2665 | 2800 | 59.75 | 24 | 29.5 | 44 | 78 | 33.75 | |

ORDERING NOTES:

For the hinged modesty panel option add Y after RH and add a 10% upcharge. e.g. 65RHYTD6024L4DX41.

| | | | | | | | | | |
|--|-----------|------|------|-------|----|------|--|------|------|
|  Linking Top | 65LU3024H | 589 | 618 | 30 | 24 | 29.5 | | 19.5 | 2 |
| | 65LU3620H | 647 | 680 | 36 | 20 | 29.5 | | 15 | 1.5 |
| | 65LU3624H | 662 | 695 | 36 | 24 | 29.5 | | 16 | 1.75 |
| | 65LU4220H | 678 | 714 | 42 | 20 | 29.5 | | 20 | 1.5 |
| | 65LU4224H | 702 | 737 | 42 | 24 | 29.5 | | 24 | 2 |
| | 65LU4820H | 710 | 746 | 48 | 20 | 29.5 | | 29 | 1.75 |
| | 65LU4824H | 729 | 764 | 48 | 24 | 29.5 | | 36 | 2 |
| | 65LU5424H | 864 | 906 | 54 | 24 | 29.5 | | 35 | 3.5 |
| | 65LU6024H | 913 | 958 | 59.75 | 24 | 29.5 | | 38.5 | 3.75 |
| | 65LU6624H | 962 | 1012 | 65.75 | 24 | 29.5 | | 42.5 | 4 |
| | 65LU7224H | 1041 | 1093 | 71.75 | 24 | 29.5 | | 46.5 | 4.5 |

| | | | | | | | | | |
|--|--------------|------|------|-------|----|------|--|-------|------|
|  Linking Unit with Fixed Modesty | 65LU3024HX41 | 1140 | 1197 | 30 | 24 | 29.5 | | 46 | 3 |
| | 65LU3620HX41 | 1290 | 1356 | 36 | 20 | 29.5 | | 59 | 3 |
| | 65LU3624HX41 | 1348 | 1416 | 36 | 24 | 29.5 | | 64 | 3 |
| | 65LU4220HX41 | 1393 | 1463 | 42 | 20 | 29.5 | | 67 | 3.75 |
| | 65LU4224HX41 | 1417 | 1487 | 42 | 24 | 29.5 | | 72 | 3.75 |
| | 65LU4820HX41 | 1453 | 1527 | 48 | 20 | 29.5 | | 78 | 4 |
| | 65LU4824HX41 | 1543 | 1620 | 48 | 24 | 29.5 | | 80 | 4 |
| | 65LU5424HX41 | 1638 | 1717 | 54 | 24 | 29.5 | | 81 | 4.75 |
| | 65LU6024HX41 | 1728 | 1815 | 59.75 | 24 | 29.5 | | 89 | 5 |
| | 65LU6624HX41 | 1818 | 1909 | 65.75 | 24 | 29.5 | | 97 | 5.5 |
| | 65LU7224HX41 | 1909 | 2004 | 71.75 | 24 | 29.5 | | 105.5 | 6 |

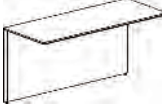
| | | | | | | | | | |
|--|-----------------|------|------|----|----|------|--|----|------|
|  Linking Units for Table Desks | 65LUTD4220HLX41 | 1290 | 1356 | 42 | 20 | 29.5 | | 67 | 20 |
| | 65LUTD4220HRX41 | 1290 | 1356 | 42 | 24 | 29.5 | | 67 | 20 |
| | 65LUTD4224HLX41 | 1310 | 1376 | 48 | 20 | 29.5 | | 71 | 23 |
| | 65LUTD4224HRX41 | 1310 | 1376 | 48 | 24 | 29.5 | | 71 | 23 |
| | 65LUTD4820HLX41 | 1345 | 1412 | 42 | 20 | 29.5 | | 78 | 22.5 |
| | 65LUTD4820HRX41 | 1345 | 1412 | 42 | 24 | 29.5 | | 78 | 22.5 |
| | 65LUTD4824HLX41 | 1362 | 1431 | 48 | 20 | 29.5 | | 79 | 26 |
| | 65LUTD4824HRX41 | 1362 | 1431 | 48 | 24 | 29.5 | | 79 | 26 |

ORDERING NOTES:

For the hinged modesty panel option on linking units add Y after LU and add a 10% upcharge. e.g. 65LUYTD4824HRX41

| | | | | | | | | | |
|--|------------|------|------|----|----|------|-------|-----|-------|
|  Corner Unit | 65CU363620 | 2570 | 2698 | 36 | 20 | 29.5 | 22.5 | 106 | 30.25 |
| | 65CU363624 | 2570 | 2698 | 36 | 24 | 29.5 | 17 | 106 | 30.25 |
| | 65CU424220 | 2824 | 2965 | 42 | 20 | 29.5 | 31 | 131 | 39.75 |
| | 65CU424224 | 2824 | 2965 | 42 | 24 | 29.5 | 25.25 | 131 | 39.75 |

ORDERING PROCEDURE

To order, please specify the following:

- 1) Krug product model number
- 2) Wood species and finish
- 3) Grommet location and style if applicable.

* Indicates model illustrated by line drawing

CODE DESCRIPTION

- L - left hand position
- R - right hand position
- 4D - 2 file drawers
- 4F - 2 box, 1 file drawer
- X21 - 1/2 height fixed wood modesty
- X41 - full height wood modesty panel

STANDARD FINISHES



For a complete list of standard wood finishes, please see page 518.

GROMMETS

One grommet in a standard position is optional at no charge. See page 521 for more information.

PALETTE FINISHES

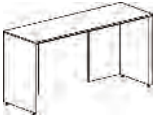
Drawer fronts are available in pallet at an up-charge of **\$357 list** per unit, add P at the end of the model number.

| Description | Model | Rift | | W | D | H | KW | Shipping Weight | Cubic Feet |
|--|----------------|------|--------|-------|------|------|------|-----------------|------------|
| | | Oak | Walnut | | | | | | |
|  | 65SC5424 | 1962 | 2060 | 54 | 24 | 29.5 | 51.5 | 88 | 29 |
| | 65SC6024 | 2109 | 2215 | 59.75 | 24 | 29.5 | 57.5 | 109 | 27.75 |
| | 65SC6624 | 2257 | 2370 | 65.75 | 24 | 29.5 | 63.5 | 104 | 35 |
| | 65SC7224 | 2417 | 2538 | 71.75 | 24 | 29.5 | 69.5 | 112 | 38 |
| | 65SC7824 | 2557 | 2685 | 77.75 | 24 | 29.5 | 75.5 | 120 | 40 |
| | 65SC8424 | 2699 | 2835 | 83.75 | 24 | 29.5 | 81.5 | 128 | 44 |
| | 65SC9624 | 3088 | 3242 | 95.75 | 24 | 29.5 | 93.5 | 128 | 44 |
|  | 65SC3624X41 | 1641 | 1723 | 36 | 24 | 29.5 | 39.5 | 84 | 20 |
| | 65SC4224X41 | 1774 | 1862 | 42 | 24 | 29.5 | 39.5 | 94 | 23 |
| | 65SC4824X41 | 1928 | 2026 | 48 | 24 | 29.5 | 45.5 | 106 | 26 |
| | 65SC5424X41 | 2080 | 2184 | 54 | 24 | 29.5 | 51.5 | 117 | 29 |
| | 65SC6024X41 | 2243 | 2356 | 59.75 | 24 | 29.5 | 57.5 | 116 | 27.75 |
| | 65SC6624X41 | 2396 | 2516 | 65.75 | 24 | 29.5 | 63.5 | 104 | 35 |
| | 65SC7224X41 | 2562 | 2690 | 71.75 | 24 | 29.5 | 69.5 | 112 | 38 |
| | 65SC7824X41 | 2714 | 2848 | 77.75 | 24 | 29.5 | 75.5 | 120 | 40 |
| | 65SC8424X41 | 2864 | 3009 | 83.75 | 24 | 29.5 | 81.5 | 128 | 44 |
| 65SC9624X41 | 3273 | 3437 | 95.75 | 24 | 29.5 | 93.5 | 128 | 44 | |
|  | 65C60204XLDR0 | 3579 | 3759 | 59.75 | 20 | 29.5 | 43 | 120 | 27.75 |
| | 65C60204XLFR0 | 3579 | 3759 | 59.75 | 20 | 29.5 | 43 | 120 | 27.75 |
| | 65C60204XLORD | 3579 | 3759 | 59.75 | 20 | 29.5 | 43 | 120 | 27.75 |
| | 65C60204XLORF | 3579 | 3759 | 59.75 | 20 | 29.5 | 43 | 120 | 27.75 |
| | 65C60244XLDR0 | 3606 | 3787 | 59.75 | 24 | 29.5 | 43 | 128 | 32 |
| | 65C60244XLFR0 | 3606 | 3787 | 59.75 | 24 | 29.5 | 43 | 128 | 32 |
| | 65C60244XLORD | 3606 | 3787 | 59.75 | 24 | 29.5 | 43 | 128 | 32 |
| | 65C60244XLORF | 3606 | 3787 | 59.75 | 24 | 29.5 | 43 | 128 | 32 |
| | 65C66204XLDR0 | 3633 | 3815 | 65.75 | 20 | 29.5 | 49 | 136 | 30 |
| | 65C66204XLFR0* | 3633 | 3815 | 65.75 | 20 | 29.5 | 49 | 136 | 30 |
| | 65C66204XLORD | 3633 | 3815 | 65.75 | 20 | 29.5 | 49 | 136 | 30 |
| | 65C66204XLORF | 3633 | 3815 | 65.75 | 20 | 29.5 | 49 | 136 | 30 |
| | 65C66244XLDR0 | 3648 | 3830 | 65.75 | 24 | 29.5 | 49 | 144 | 35 |
| | 65C66244XLFR0 | 3648 | 3830 | 65.75 | 24 | 29.5 | 49 | 144 | 35 |
| | 65C66244XLORD | 3648 | 3830 | 65.75 | 24 | 29.5 | 49 | 144 | 35 |
| | 65C66244XLORF | 3648 | 3830 | 65.75 | 24 | 29.5 | 49 | 144 | 35 |
| | 65C72204XLDR0 | 3665 | 3848 | 71.75 | 20 | 29.5 | 55 | 152 | 32.75 |
| | 65C72204XLFR0 | 3665 | 3848 | 71.75 | 20 | 29.5 | 55 | 152 | 32.75 |
| | 65C72204XLORD | 3665 | 3848 | 71.75 | 20 | 29.5 | 55 | 152 | 32.75 |
| | 65C72204XLORF | 3665 | 3848 | 71.75 | 20 | 29.5 | 55 | 152 | 32.75 |
| | 65C72244XLDR0 | 3697 | 3881 | 71.75 | 24 | 29.5 | 55 | 160 | 38 |
| 65C72244XLFR0 | 3697 | 3881 | 71.75 | 24 | 29.5 | 55 | 160 | 38 | |
| 65C72244XLORD | 3697 | 3881 | 71.75 | 24 | 29.5 | 55 | 160 | 38 | |
| 65C72244XLORF | 3697 | 3881 | 71.75 | 24 | 29.5 | 55 | 160 | 38 | |
| 65C78204XLDR0 | 3708 | 3892 | 77.75 | 20 | 29.5 | 61 | 168 | 35.5 | |
| 65C78204XLFR0 | 3708 | 3892 | 77.75 | 20 | 29.5 | 61 | 168 | 35.5 | |
| 65C78204XLORD | 3708 | 3892 | 77.75 | 20 | 29.5 | 61 | 168 | 35.5 | |
| 65C78204XLORF | 3708 | 3892 | 77.75 | 20 | 29.5 | 61 | 168 | 35.5 | |
| 65C78244XLDR0 | 3715 | 3903 | 77.75 | 24 | 29.5 | 61 | 172 | 41 | |
| 65C78244XLFR0 | 3715 | 3903 | 77.75 | 24 | 29.5 | 61 | 172 | 41 | |

ORDERING NOTES:

For the hinged modesty panel option add Y after C and add a 10% upcharge. e.g. 65CY60204XLDR0. Unsupported spans greater than 48" require a half gable support. See page 571. Drawer fronts are available in pallet at an upcharge of **\$357 list** per unit, add P at the end of the model number.

DIMENSION KEY

W – width
 D – depth
 H – height of worksurface
 KW – kneehole width

Dimensions are in inches and approximate. Contact Customer Service if dimensions are critical.



CODE DESCRIPTION

X41 - full height fixed wood modesty
 X - modesty panel
 4 - full height pedestal
 L - left hand position
 R - right hand position
 D - 2 file drawers
 F - 2 box, 1 file drawer
 0 - no pedestal

VENEER

Latitude is available in Quarter Cut Walnut and Rift Cut Oak veneers, and each is priced in this price guide. Maple and Cherry are also available: for Flat Cut Maple or Cherry veneer, use Column 1 pricing; for Quarter Cut Maple or Cherry, use Column 2 pricing. Other veneers are also available on Latitude, please contact us for a quote.

LATITUDE | CREDENZAS

| Description | Model | Rift | | W | D | H | KW | Shipping Weight | Cubic Feet |
|--|-----------------|------|--------|-------|----|------|----|-----------------|------------|
| | | Oak | Walnut | | | | | | |
| Single Pedestal | 65C78244XLORD | 3715 | 3903 | 77.75 | 24 | 29.5 | 61 | 172 | 41 |
| Credenza, Fixed | 65C78244XLORF | 3715 | 3903 | 77.75 | 24 | 29.5 | 61 | 172 | 41 |
| Wood Modesty | 65C84204XLDR0 | 3721 | 3908 | 83.75 | 20 | 29.5 | 67 | 184 | 38 |
| cont. | 65C84204XLFR0 | 3721 | 3908 | 83.75 | 20 | 29.5 | 67 | 184 | 38 |
|  | 65C84204XLORD | 3721 | 3908 | 83.75 | 20 | 29.5 | 67 | 184 | 38 |
| | 65C84204XLORF | 3721 | 3908 | 83.75 | 20 | 29.5 | 67 | 184 | 38 |
| | 65C84244XLDR0 | 3731 | 3917 | 83.75 | 24 | 29.5 | 67 | 192 | 44 |
| | 65C84244XLFR0 | 3731 | 3917 | 83.75 | 24 | 29.5 | 67 | 192 | 44 |
| | 65C84244XLORD | 3731 | 3917 | 83.75 | 24 | 29.5 | 67 | 192 | 44 |
| | 65C84244XLORF | 3731 | 3917 | 83.75 | 24 | 29.5 | 67 | 192 | 44 |
| Single Lateral File or | 65C6020XL3011R0 | 3215 | 3376 | 59.75 | 20 | 29.5 | 29 | 107 | 27.75 |
| Bookcase Pedestal | 65C6020XLOR3011 | 3215 | 3376 | 59.75 | 20 | 29.5 | 29 | 107 | 27.75 |
| Credenza, Fixed | 65C6020XL3001R0 | 3487 | 3661 | 59.75 | 20 | 29.5 | 29 | 140 | 27.75 |
| Wood Modesty | 65C6020XLOR3001 | 3487 | 3661 | 59.75 | 20 | 29.5 | 29 | 140 | 27.75 |
|  | 65C6024XL3011R0 | 3334 | 3501 | 59.75 | 24 | 29.5 | 29 | 113 | 32 |
| | 65C6024XLOR3011 | 3334 | 3501 | 59.75 | 24 | 29.5 | 29 | 113 | 32 |
| | 65C6024XL3001R0 | 3608 | 3789 | 59.75 | 24 | 29.5 | 29 | 147 | 32 |
| | 65C6024XLOR3001 | 3608 | 3789 | 59.75 | 24 | 29.5 | 29 | 147 | 32 |
| | 65C6620XL3611R0 | 3353 | 3520 | 65.75 | 20 | 29.5 | 35 | 118 | 30 |
| | 65C6620XLOR3611 | 3353 | 3520 | 65.75 | 20 | 29.5 | 35 | 118 | 30 |
| | 65C6620XL3601R0 | 3626 | 3809 | 65.75 | 20 | 29.5 | 35 | 154 | 30 |
| | 65C6620XLOR3601 | 3626 | 3809 | 65.75 | 20 | 29.5 | 35 | 154 | 30 |
| | 65C6624XL3611R0 | 3369 | 3537 | 65.75 | 24 | 29.5 | 35 | 125 | 35 |
| | 65C6624XLOR3611 | 3369 | 3537 | 65.75 | 24 | 29.5 | 35 | 125 | 35 |
| | 65C6624XL3601R0 | 3642 | 3823 | 65.75 | 24 | 29.5 | 35 | 162 | 35 |
| | 65C6624XLOR3601 | 3642 | 3823 | 65.75 | 24 | 29.5 | 35 | 162 | 35 |
| | 65C7220XL3611R0 | 3411 | 3582 | 71.75 | 20 | 29.5 | 35 | 128 | 32.75 |
| | 65C7220XLOR3611 | 3411 | 3582 | 71.75 | 20 | 29.5 | 35 | 128 | 32.75 |
| | 65C7220XL3601R0 | 3854 | 4047 | 71.75 | 20 | 29.5 | 35 | 168 | 32.75 |
| | 65C7220XLOR3601 | 3854 | 4047 | 71.75 | 20 | 29.5 | 35 | 168 | 32.75 |
| | 65C7224XL3611R0 | 3538 | 3714 | 71.75 | 24 | 29.5 | 35 | 136 | 38 |
| | 65C7224XLOR3611 | 3538 | 3714 | 71.75 | 24 | 29.5 | 35 | 136 | 38 |
| | 65C7224XL3601R0 | 3919 | 4114 | 71.75 | 24 | 29.5 | 35 | 176 | 38 |
| | 65C7224XLOR3601 | 3919 | 4114 | 71.75 | 24 | 29.5 | 35 | 176 | 38 |
| | 65C7820XL3611R0 | 3553 | 3731 | 77.75 | 20 | 29.5 | 41 | 155 | 35.5 |
| | 65C7820XLOR3611 | 3553 | 3731 | 77.75 | 20 | 29.5 | 41 | 155 | 35.5 |
| | 65C7820XL3601R0 | 3981 | 4180 | 77.75 | 20 | 29.5 | 41 | 195 | 35.5 |
| | 65C7820XLOR3601 | 3981 | 4180 | 77.75 | 20 | 29.5 | 41 | 195 | 35.5 |
| | 65C7824XL3611R0 | 3565 | 3743 | 77.75 | 24 | 29.5 | 41 | 174 | 41 |
| | 65C7824XLOR3611 | 3565 | 3743 | 77.75 | 24 | 29.5 | 41 | 174 | 41 |
| | 65C7824XL3601R0 | 4063 | 4265 | 77.75 | 24 | 29.5 | 41 | 199 | 41 |
| | 65C7824XLOR3601 | 4063 | 4265 | 77.75 | 24 | 29.5 | 41 | 199 | 41 |
| | 65C8420XL3611R0 | 3580 | 3760 | 83.75 | 20 | 29.5 | 47 | 181 | 38 |
| | 65C8420XLOR3611 | 3580 | 3760 | 83.75 | 20 | 29.5 | 47 | 181 | 38 |
| | 65C8420XL3601R0 | 4110 | 4315 | 83.75 | 20 | 29.5 | 47 | 221 | 38 |
| | 65C8420XLOR3601 | 4110 | 4315 | 83.75 | 20 | 29.5 | 47 | 221 | 38 |
| | 65C8424XL3611R0 | 3592 | 3771 | 83.75 | 24 | 29.5 | 47 | 212 | 44 |
| | 65C8424XLOR3611 | 3592 | 3771 | 83.75 | 24 | 29.5 | 47 | 212 | 44 |
| | 65C8424XL3601R0 | 4207 | 4418 | 83.75 | 24 | 29.5 | 47 | 252 | 44 |
| | 65C8424XLOR3601 | 4207 | 4418 | 83.75 | 24 | 29.5 | 47 | 252 | 44 |

ORDERING NOTES:

For the hinged modesty panel option add Y after C and add a 10% upcharge. e.g. 65C**Y**6020XL3011R0. Drawer fronts are available in pallet at an upcharge of **\$357 list** per unit, add P at the end of the model number.

ORDERING PROCEDURE

To order, please specify the following:

- 1) Krug product model number
- 2) Wood species and finish
- 3) Grommet location and style if applicable.

* Indicates model illustrated by line drawing

CODE DESCRIPTION

- 4 - full height pedestal
- X - modesty panel
- L - left hand position
- R - right hand position
- D - 2 file drawers
- F - 2 box, 1 file drawer
- 0 - no pedestal
- 01 - lateral file
- 11 - closed bookcase

STANDARD FINISHES



For a complete list of standard wood finishes, please see page 518.

GROMMETS

One grommet in a standard position is optional at no charge. See page 521 for more information.

PALETTE FINISH

Drawer fronts are available in Palette at an up-charge of **\$357 per unit**, add P at the end of the model number.

| Description | Model | Rift | | W | D | H | KW | Shipping Weight | Cubic Feet | |
|--|--|---------------|--------|-------|-------|------|------|-----------------|------------|-------|
| | | Oak | Walnut | | | | | | | |
| Single 36" Combination Pedestal Credenza, Fixed Wood Modesty  | 65C7220XL3602RO | 3581 | 3761 | 71.75 | 20 | 29.5 | 35 | 168 | 32.75 | |
| | 65C7220XLOR3604 | 3581 | 3761 | 71.75 | 20 | 29.5 | 35 | 168 | 32.75 | |
| | 65C7224XL3602RO | 3714 | 3902 | 71.75 | 24 | 29.5 | 35 | 165 | 38 | |
| | 65C7224XLOR3604 | 3714 | 3902 | 71.75 | 24 | 29.5 | 35 | 165 | 38 | |
| | 65C7820XL3602RO | 3634 | 3816 | 77.75 | 20 | 29.5 | 41 | 174 | 35.5 | |
| | 65C7820XLOR3604 | 3634 | 3816 | 77.75 | 20 | 29.5 | 41 | 174 | 35.5 | |
| | 65C7824XL3602RO* | 3744 | 3933 | 77.75 | 24 | 29.5 | 41 | 182 | 41 | |
| | 65C7824XLOR3604 | 3744 | 3933 | 77.75 | 24 | 29.5 | 41 | 182 | 41 | |
| | 65C8420XL3602RO | 3686 | 3871 | 83.75 | 20 | 29.5 | 47 | 180 | 38 | |
| | 65C8420XLOR3604 | 3686 | 3871 | 83.75 | 20 | 29.5 | 47 | 180 | 38 | |
| | 65C8424XL3602RO | 3774 | 3963 | 83.75 | 24 | 29.5 | 47 | 188 | 44 | |
| | 65C8424XLOR3604 | 3774 | 3963 | 83.75 | 24 | 29.5 | 47 | 188 | 44 | |
| | Double Pedestal Credenza, Fixed Wood Modesty  | 65C60204XLDRD | 3846 | 4039 | 59.75 | 20 | 29.5 | 28.5 | 200 | 27.75 |
| | | 65C60204XLDRF | 3846 | 4039 | 59.75 | 20 | 29.5 | 28.5 | 200 | 27.75 |
| 65C60204XLFRD | | 3846 | 4039 | 59.75 | 20 | 29.5 | 28.5 | 200 | 27.75 | |
| 65C60204XLFRF | | 3846 | 4039 | 59.75 | 20 | 29.5 | 28.5 | 200 | 27.75 | |
| 65C60244XLDRD | | 3874 | 4068 | 59.75 | 24 | 29.5 | 28.5 | 208 | 32 | |
| 65C60244XLDRF | | 3874 | 4068 | 59.75 | 24 | 29.5 | 28.5 | 208 | 32 | |
| 65C60244XLFRD | | 3874 | 4068 | 59.75 | 24 | 29.5 | 28.5 | 208 | 32 | |
| 65C60244XLFRF | | 3874 | 4068 | 59.75 | 24 | 29.5 | 28.5 | 208 | 32 | |
| 65C66204XLDRD | | 3907 | 4103 | 65.75 | 20 | 29.5 | 34.5 | 216 | 30 | |
| 65C66204XLDRF* | | 3907 | 4103 | 65.75 | 20 | 29.5 | 34.5 | 216 | 30 | |
| 65C66204XLFRD | | 3907 | 4103 | 65.75 | 20 | 29.5 | 34.5 | 216 | 30 | |
| 65C66204XLFRF | | 3907 | 4103 | 65.75 | 20 | 29.5 | 34.5 | 216 | 30 | |
| 65C66244XLDRD | | 3914 | 4110 | 65.75 | 24 | 29.5 | 34.5 | 224 | 35 | |
| 65C66244XLDRF | | 3914 | 4110 | 65.75 | 24 | 29.5 | 34.5 | 224 | 35 | |
| 65C66244XLFRD | | 3914 | 4110 | 65.75 | 24 | 29.5 | 34.5 | 224 | 35 | |
| 65C66244XLFRF | | 3914 | 4110 | 65.75 | 24 | 29.5 | 34.5 | 224 | 35 | |
| 65C72204XLDRD | | 3941 | 4140 | 71.75 | 20 | 29.5 | 40.5 | 232 | 32.75 | |
| 65C72204XLDRF | | 3941 | 4140 | 71.75 | 20 | 29.5 | 40.5 | 232 | 32.75 | |
| 65C72204XLFRD | | 3941 | 4140 | 71.75 | 20 | 29.5 | 40.5 | 232 | 32.75 | |
| 65C72204XLFRF | | 3941 | 4140 | 71.75 | 20 | 29.5 | 40.5 | 232 | 32.75 | |
| 65C72244XLDRD | | 3977 | 4173 | 71.75 | 24 | 29.5 | 40.5 | 240 | 38 | |
| 65C72244XLDRF | | 3977 | 4173 | 71.75 | 24 | 29.5 | 40.5 | 240 | 38 | |
| 65C72244XLFRD | | 3977 | 4173 | 71.75 | 24 | 29.5 | 40.5 | 240 | 38 | |
| 65C72244XLFRF | | 3977 | 4173 | 71.75 | 24 | 29.5 | 40.5 | 240 | 38 | |
| 65C78204XLDRD | | 3979 | 4177 | 77.75 | 20 | 29.5 | 46.5 | 248 | 35.5 | |
| 65C78204XLDRF | | 3979 | 4177 | 77.75 | 20 | 29.5 | 46.5 | 248 | 35.5 | |
| 65C78204XLFRD | | 3979 | 4177 | 77.75 | 20 | 29.5 | 46.5 | 248 | 35.5 | |
| 65C78204XLFRF | | 3979 | 4177 | 77.75 | 20 | 29.5 | 46.5 | 248 | 35.5 | |
| 65C78244XLDRD | | 3982 | 4182 | 77.75 | 24 | 29.5 | 46.5 | 256 | 41 | |
| 65C78244XLDRF | | 3982 | 4182 | 77.75 | 24 | 29.5 | 46.5 | 256 | 41 | |
| 65C78244XLFRD | | 3982 | 4182 | 77.75 | 24 | 29.5 | 46.5 | 256 | 41 | |
| 65C78244XLFRF | | 3982 | 4182 | 77.75 | 24 | 29.5 | 46.5 | 256 | 41 | |
| 65C84204XLDRD | | 3985 | 4186 | 83.75 | 20 | 29.5 | 52.5 | 264 | 38 | |
| 65C84204XLDRF | | 3985 | 4186 | 83.75 | 20 | 29.5 | 52.5 | 264 | 38 | |
| 65C84204XLFRD | 3985 | 4186 | 83.75 | 20 | 29.5 | 52.5 | 264 | 38 | | |
| 65C84204XLFRF | 3985 | 4186 | 83.75 | 20 | 29.5 | 52.5 | 264 | 38 | | |
| 65C84244XLDRD | 4008 | 4208 | 83.75 | 24 | 29.5 | 52.5 | 272 | 44 | | |
| 65C84244XLDRF | 4008 | 4208 | 83.75 | 24 | 29.5 | 52.5 | 272 | 44 | | |
| 65C84244XLFRD | 4008 | 4208 | 83.75 | 24 | 29.5 | 52.5 | 272 | 44 | | |
| 65C84244XLFRF | 4008 | 4208 | 83.75 | 24 | 29.5 | 52.5 | 272 | 44 | | |

ORDERING NOTES: For the hinged modesty panel option add Y after C and add a 10% upcharge. e.g. 65CY60204XLDRD.

DIMENSION KEY

W — width
 D — depth
 H — height of worksurface
 KW — kneehole width

Dimensions are in inches and approximate. Contact Customer Service if dimensions are critical.



CODE DESCRIPTION

4 - full height pedestal
 X - modesty panel
 L - left hand position
 R - right hand position
 02 - 2 box on right, 1 file drawer left, lateral file
 04 - 1 file drawer right, 2 box on left, lateral file
 D - 2 file drawers
 F - 2 box, 1 file drawer

VENEER

Latitude is available in Quarter Cut Walnut and Rift Cut Oak veneers, and each is priced in this price guide. Maple and Cherry are also available: for Flat Cut Maple or Cherry veneer, use Column 1 pricing; for Quarter Cut Maple or Cherry, use Column 2 pricing. Other veneers are also available on Latitude, please contact us for a quote.

LATITUDE | FULL FACE & 3/4 HEIGHT CREDENZAS

| Description | Model | Rift | | W | D | H | KW | Shipping Weight | Cubic Feet |
|--|---|------------------|--------|-------|-------|------|------|-----------------|------------|
| | | Oak | Walnut | | | | | | |
|  Full Face Credenza | 65C6020L3001R3001 | 4087 | 4291 | 59.75 | 20 | 29.5 | - | 176 | 28 |
| | 65C6020L3001R3011 | 3907 | 4103 | 59.75 | 20 | 29.5 | - | 192 | 28 |
| | 65C6020L3011R3001 | 3907 | 4103 | 59.75 | 20 | 29.5 | - | 192 | 28 |
| | 65C6020L3011R3011 | 3723 | 3909 | 59.75 | 20 | 29.5 | - | 208 | 28 |
| | 65C6024L3001R3001 | 4213 | 4423 | 59.75 | 24 | 29.5 | - | 192 | 33 |
| | 65C6024L3001R3011 | 3995 | 4194 | 59.75 | 24 | 29.5 | - | 210 | 33 |
| | 65C6024L3011R3001 | 3995 | 4194 | 59.75 | 24 | 29.5 | - | 210 | 33 |
| | 65C6024L3011R3011 | 3773 | 3962 | 59.75 | 24 | 29.5 | - | 230 | 33 |
| | 65C7220L3601R3601 | 5346 | 5614 | 71.75 | 20 | 29.5 | - | 208 | 32.75 |
| | 65C7220L3601R3611 | 4877 | 5121 | 71.75 | 20 | 29.5 | - | 228 | 32.75 |
| | 65C7220L3611R3601 | 4877 | 5121 | 71.75 | 20 | 29.5 | - | 228 | 32.75 |
| | 65C7220L3611R3611 | 4154 | 4362 | 71.75 | 20 | 29.5 | - | 248 | 32.75 |
| | 65C7224L3601R3601 | 5416 | 5686 | 71.75 | 24 | 29.5 | - | 224 | 38 |
| | 65C7224L3601R3611 | 4968 | 5216 | 71.75 | 24 | 29.5 | - | 236 | 38 |
| | 65C7224L3611R3601 | 4968 | 5216 | 71.75 | 24 | 29.5 | - | 236 | 38 |
| | 65C7224L3611R3611 | 4208 | 4420 | 71.75 | 24 | 29.5 | - | 256 | 38 |
| |  Single Pedestal 3/4 Height Credenza | 65C60203XL0R3011 | 3032 | 3185 | 59.75 | 20 | 23 | 28 | 191 |
| 65C60203XL0R3016 | | 3103 | 3260 | 59.75 | 20 | 23 | 28 | 202 | 21 |
| 65C60203XL3011R0 | | 3032 | 3185 | 59.75 | 20 | 23 | 28 | 191 | 21 |
| 65C60203XL3016R0 | | 3103 | 3260 | 59.75 | 20 | 23 | 28 | 202 | 21 |
| 65C60243XL0R3011 | | 3469 | 3642 | 59.75 | 24 | 23 | 28 | 204 | 25 |
| 65C60243XL0R3016 | | 3553 | 3731 | 59.75 | 24 | 23 | 28 | 226 | 25 |
| 65C60243XL3011R0 | | 3469 | 3642 | 59.75 | 24 | 23 | 28 | 191 | 25 |
| 65C60243XL3016R0 | | 3553 | 3731 | 59.75 | 24 | 23 | 28 | 242 | 25 |
| 65C66203XL0R3611 | | 3093 | 3247 | 59.75 | 20 | 23 | 28.5 | 191 | 21 |
| 65C66203XL0R3616 | | 3164 | 3323 | 59.75 | 20 | 23 | 28.5 | 202 | 21 |
| 65C66203XL3611R0 | | 3093 | 3247 | 59.75 | 20 | 23 | 28.5 | 191 | 21 |
| 65C66203XL3616R0 | | 3164 | 3323 | 59.75 | 20 | 23 | 28.5 | 202 | 21 |
| 65C66243XL0R3611 | | 3539 | 3715 | 59.75 | 24 | 23 | 28.5 | 204 | 25 |
| 65C66243XL0R3616 | | 3622 | 3803 | 59.75 | 24 | 23 | 28.5 | 226 | 25 |
| 65C66243XL3611R0 | | 3539 | 3715 | 59.75 | 24 | 23 | 28.5 | 191 | 25 |
| 65C66243XL3616R0 | | 3622 | 3803 | 59.75 | 24 | 23 | 28.5 | 242 | 25 |
| 65C72203XL0R3611 | | 3158 | 3315 | 71.75 | 20 | 23 | 34.5 | 191 | 25.5 |
| 65C72203XL0R3616 | | 3231 | 3390 | 71.75 | 20 | 23 | 34.5 | 202 | 25.5 |
| 65C72203XL3611R0 | | 3158 | 3315 | 71.75 | 20 | 23 | 34.5 | 191 | 25.5 |
| 65C72203XL3616R0 | | 3231 | 3390 | 71.75 | 20 | 23 | 34.5 | 202 | 25.5 |
| 65C72243XL0R3611 | | 3610 | 3792 | 71.75 | 24 | 23 | 34.5 | 204 | 30 |
| 65C72243XL0R3616 | | 3697 | 3881 | 71.75 | 24 | 23 | 34.5 | 226 | 30 |
| 65C72243XL3611R0 | | 3610 | 3792 | 71.75 | 24 | 23 | 34.5 | 191 | 30 |
| 65C72243XL3616R0 | | 3697 | 3881 | 71.75 | 24 | 23 | 34.5 | 242 | 30 |
| 65C84203XL0R3611 | | 3598 | 3780 | 83.75 | 20 | 23 | 46.5 | 191 | 29.5 |
| 65C84203XL0R3616 | | 3670 | 3854 | 83.75 | 20 | 23 | 46.5 | 202 | 29.5 |
| 65C84203XL3611R0 | | 3598 | 3780 | 83.75 | 20 | 23 | 46.5 | 191 | 29.5 |
| 65C84203XL3616R0 | | 3670 | 3854 | 83.75 | 20 | 23 | 46.5 | 202 | 29.5 |
| 65C84243XL0R3611 | 4071 | 4277 | 83.75 | 24 | 23 | 46.5 | 204 | 35 | |
| 65C84243XL0R3616 | 4011 | 4213 | 83.75 | 24 | 23 | 46.5 | 226 | 35 | |
| 65C84243XL3611R0 | 4071 | 4277 | 83.75 | 24 | 23 | 46.5 | 191 | 35 | |
| 65C84243XL3616R0 | 4011 | 4213 | 83.75 | 24 | 23 | 46.5 | 242 | 35 | |
| 65C96243XL0R3611 | 4319 | 4536 | 95.5 | 24 | 23 | 58.5 | 254 | 40 | |
| 65C96243XL0R3616 | 4257 | 4468 | 95.5 | 24 | 23 | 58.5 | 240 | 40 | |
| 65C96243XL3611R0 | 4319 | 4536 | 95.5 | 24 | 23 | 58.5 | 240 | 40 | |
| 65C96243XL3616R0 | 4257 | 4468 | 95.5 | 24 | 23 | 58.5 | 254 | 40 | |

ORDERING NOTES: For the hinged modesty panel option add Y after RH and add a 10% upcharge. e.g. 65CY60203XL0R3011.

ORDERING PROCEDURE

To order, please specify the following:

- 1) Krug product model number
- 2) Wood species and finish
- 3) Grommet location and style if applicable.

* Indicates model illustrated by line drawing

CODE DESCRIPTION

- 4 - full height pedestal
- 3 - 3/4 height pedestal
- X - modesty panel
- L - left hand position
- R - right hand position
- 01 - lateral file
- 11 - closed bookcase
- 16 - box, lateral file

STANDARD FINISHES

For a complete list of standard wood finishes, please see page 518.

PALETTE FINISH

Storage unit door fronts are available in Palette finish at no upcharge. Drawer fronts are also available in Palette at an upcharge of **\$357 list** per unit, add P at the end of the model number. See page 518 for color selection..

LATITUDE | 3/4 HEIGHT CREDENZAS

| Description | Model | Rift | | W | D | H | Shipping Weight | Cubic Feet |
|---|--------------------|------|--------|-------|----|-----|-----------------|------------|
| | | Oak | Walnut | | | | | |
|  | 65C60203L3011R3011 | 4112 | 4317 | 59.75 | 20 | 23 | 186 | 21 |
| | 65C60203L3011R3016 | 4159 | 4368 | 59.75 | 20 | 23 | 191 | 21 |
| | 65C60203L3011R3017 | 3679 | 3862 | 59.75 | 20 | 23 | 171 | 21 |
| | 65C60203L3016R3011 | 4138 | 4343 | 59.75 | 24 | 23 | 191 | 21 |
| | 65C60203L3016R3016 | 4111 | 4316 | 59.75 | 20 | 23 | 202 | 21 |
| | 65C60203L3016R3017 | 4027 | 4229 | 59.75 | 20 | 23 | 179 | 21 |
| | 65C60203L3017R3011 | 3679 | 3862 | 59.75 | 20 | 23 | 171 | 21 |
| | 65C60203L3017R3016 | 4608 | 4838 | 59.75 | 20 | 23 | 179 | 21 |
| | 65C60203L3017R3017 | 3121 | 3278 | 59.75 | 20 | 23 | 156 | 21 |
| | 65C60243L3011R3011 | 4194 | 4404 | 59.75 | 24 | 23 | 193 | 25 |
| | 65C60243L3011R3016 | 4289 | 4504 | 59.75 | 24 | 23 | 204 | 25 |
| | 65C60243L3011R3017 | 3753 | 3939 | 59.75 | 24 | 23 | 178 | 25 |
| | 65C60243L3016R3011 | 4289 | 4504 | 59.75 | 24 | 23 | 204 | 25 |
| | 65C60243L3016R3016 | 4263 | 4477 | 59.75 | 24 | 23 | 226 | 25 |
| | 65C60243L3016R3017 | 4152 | 4360 | 59.75 | 24 | 23 | 216 | 25 |
| | 65C60243L3017R3011 | 3753 | 3939 | 59.75 | 24 | 23 | 178 | 25 |
| | 65C60243L3017R3016 | 4152 | 4360 | 59.75 | 24 | 23 | 216 | 25 |
| | 65C60243L3017R3017 | 3244 | 3406 | 59.75 | 24 | 23 | 163 | 25 |
| | 65C72203L3611R3611 | 4277 | 4488 | 71.5 | 24 | 23 | 197 | 25.5 |
| | 65C72203L3611R3616 | 4437 | 4659 | 71.75 | 20 | 23 | 213.5 | 25.5 |
| | 65C72203L3611R3617 | 3881 | 4077 | 71.5 | 20 | 23 | 182 | 25.5 |
| | 65C72203L3616R3611 | 4437 | 4659 | 71.75 | 20 | 23 | 213.5 | 25.5 |
| | 65C72203L3616R3616 | 4411 | 4632 | 71.75 | 20 | 23 | 218.5 | 25.5 |
| | 65C72203L3616R3617 | 4292 | 4507 | 71.75 | 20 | 23 | 218.5 | 25.5 |
| | 65C72203L3617R3611 | 3864 | 4057 | 71.5 | 20 | 23 | 182 | 25.5 |
| | 65C72203L3617R3616 | 4292 | 4507 | 71.75 | 20 | 23 | 199 | 25.5 |
| | 65C72203L3617R3617 | 3343 | 3510 | 71.5 | 20 | 23 | 167 | 25.5 |
| | 65C72243L3611R3611 | 4411 | 4632 | 71.5 | 24 | 23 | 200 | 30 |
| | 65C72243L3611R3616 | 4604 | 4835 | 71.75 | 24 | 23 | 240 | 30 |
| | 65C72243L3611R3617 | 3903 | 4098 | 71.5 | 24 | 23 | 185 | 30 |
| | 65C72243L3616R3611 | 4604 | 4835 | 71.75 | 24 | 23 | 240 | 30 |
| | 65C72243L3616R3616 | 4574 | 4803 | 71.75 | 24 | 23 | 237 | 30 |
| | 65C72243L3616R3617 | 4452 | 4672 | 71.75 | 24 | 23 | 224.5 | 30 |
| | 65C72243L3617R3611 | 3903 | 4098 | 71.5 | 24 | 23 | 185 | 30 |
| | 65C72243L3617R3616 | 4452 | 4672 | 71.75 | 24 | 23 | 224.5 | 30 |
| 65C72243L3617R3617 | 3442 | 3614 | 71.5 | 24 | 23 | 170 | 30 | |

ORDERING NOTES: The -15 open/lateral file module can be used in place of the -16 box/file at the same price. The -18 open/closed bookcase module can be used in place of the -11 closed module at the same price. If a runoff with power/data option is to be mounted onto a 3/4 height credenza please specify location ML -Mounted Left or MR-Mounted Right. This will ensure that access grommets will be drilled in the credenza top and back. Full Face 3/4 height credenzas larger than 72" must be specified modularly, please see page 569.

DIMENSION KEY

W — width
D — depth
H — height of worksurface
KW— kneehole width

Dimensions are in inches and approximate.
Contact Customer Service if dimensions are critical.

CODE DESCRIPTION

3 - 3/4 height pedestal
L - left hand position
R - right hand position
11 - closed bookcase
16 - box, lateral file
17 - open bookcase
15 - top open, lateral file
18 - top open, closed bookcase

VENEER

Latitude is available in Quarter Cut Walnut and Rift Cut Oak veneers, and each is priced in this price guide. Maple and Cherry are also available: for Flat Cut Maple or Cherry veneer, use Column 1 pricing; for Quarter Cut Maple or Cherry, use Column 2 pricing. Other veneers are also available on Latitude, please contact us for a quote.

LATITUDE | CORNER CREDENZAS & OVERHEADS

| Description | Model | Rift | | W | D | H | KW | Shipping Weight | Cubic Feet |
|---|---------------|------|--------|-------|-------|------|-----|-----------------|------------|
| | | Oak | Walnut | | | | | | |
| Corner Credenza | 65CC7224XL4D | 3194 | 3355 | 71.75 | 24 | 29.5 | 32 | 192 | 38 |
| Single Pedestal | 65CC7224XL4F | 3194 | 3355 | 71.75 | 24 | 29.5 | 32 | 192 | 38 |
| Fixed Wood Modesty Panel | 65CC7224XR4D | 3194 | 3355 | 71.75 | 24 | 29.5 | 32 | 192 | 38 |
| | 65CC7224XR4F | 3194 | 3355 | 71.75 | 24 | 29.5 | 32 | 192 | 38 |
| | 65CC7824XL4D | 3227 | 3388 | 77.75 | 24 | 29.5 | 38 | 200 | 41 |
| | 65CC7824XL4F | 3227 | 3388 | 77.75 | 24 | 29.5 | 38 | 200 | 41 |
| | 65CC7824XR4D | 3227 | 3388 | 77.75 | 24 | 29.5 | 38 | 200 | 41 |
| | 65CC7824XR4F | 3227 | 3388 | 77.75 | 24 | 29.5 | 38 | 200 | 41 |
| | 65CC8424XL4D | 3261 | 3424 | 83.75 | 24 | 29.5 | 44 | 208 | 44 |
| | 65CC8424XL4F | 3261 | 3424 | 83.75 | 24 | 29.5 | 44 | 208 | 44 |
| | 65CC8424XR4D | 3261 | 3424 | 83.75 | 24 | 29.5 | 44 | 208 | 44 |
| | 65CC8424XR4F | 3261 | 3424 | 83.75 | 24 | 29.5 | 44 | 208 | 44 |
| Curved Corner Credenza Single Pedestal Fixed Wood Modesty Panel | 65CCC7224XL4D | 3260 | 3423 | 71.75 | 24 | 29.5 | 32 | 192 | 38 |
| | 65CCC7224XL4F | 3260 | 3423 | 71.75 | 24 | 29.5 | 32 | 192 | 38 |
| | 65CCC7224XR4D | 3260 | 3423 | 71.75 | 24 | 29.5 | 32 | 192 | 38 |
| | 65CCC7224XR4F | 3260 | 3423 | 71.75 | 24 | 29.5 | 32 | 192 | 38 |
| | 65CCC7824XL4D | 3294 | 3459 | 77.75 | 24 | 29.5 | 38 | 200 | 41 |
| | 65CCC7824XL4F | 3294 | 3459 | 77.75 | 24 | 29.5 | 38 | 200 | 41 |
| | 65CCC7824XR4D | 3294 | 3459 | 77.75 | 24 | 29.5 | 38 | 200 | 41 |
| | 65CCC7824XR4F | 3294 | 3459 | 77.75 | 24 | 29.5 | 38 | 200 | 41 |
| | 65CCC8424XL4D | 3327 | 3494 | 83.75 | 24 | 29.5 | 44 | 208 | 44 |
| | 65CCC8424XL4F | 3327 | 3494 | 83.75 | 24 | 29.5 | 44 | 208 | 44 |
| 65CCC8424XR4D | 3327 | 3494 | 83.75 | 24 | 29.5 | 44 | 208 | 44 | |
| 65CCC8424XR4F | 3327 | 3494 | 83.75 | 24 | 29.5 | 44 | 208 | 44 | |
| Doors | | | | | | | | | |
| Single Height Overhead, Wood Doors | 65OHW361616 | 1231 | 1294 | 35.75 | 15.75 | 16 | 2 | 64 | 7 |
| | 65OHW421616 | 1290 | 1356 | 41.75 | 15.75 | 16 | 2 | 71 | 8.5 |
| | 65OHW481616 | 1389 | 1458 | 47.75 | 15.75 | 16 | 3 | 82 | 9 |
| | 65OHW541616 | 1437 | 1508 | 54 | 16 | 16 | 4 | 89.5 | 10.75 |
| | 65OHW601616 | 1484 | 1559 | 59.75 | 15.75 | 16 | 4 | 96 | 11.5 |
| | 65OHW661616 | 1565 | 1643 | 65.75 | 15.75 | 16 | 4 | 102 | 12.75 |
| | 65OHW721616 | 1645 | 1729 | 71.75 | 15.75 | 16 | 4 | 109 | 13.75 |
| | 65OHW781616 | 1729 | 1816 | 77.75 | 15.75 | 16 | 4 | 109 | 13.75 |
| | 65OHW841616 | 2587 | 2717 | 83.75 | 16 | 16 | 4 | 129 | 16.25 |
| | 65OHW901616 | 2154 | 2261 | 89.5 | 15.75 | 16 | 6 | 109 | 13.75 |
| 65OHW961616 | 2263 | 2376 | 95.5 | 16 | 16 | 6 | 129 | 16.25 | |
| Single Height Overhead, Wood Flip Doors | 65OHFW361616 | 1371 | 1439 | 35.75 | 15.75 | 16 | 1 | 64 | 7 |
| | 65OHFW421616 | 1429 | 1501 | 41.75 | 15.75 | 16 | 1 | 71 | 8.5 |
| | 65OHFW481616 | 1527 | 1603 | 47.75 | 15.75 | 16 | 1 | 82 | 9 |
| | 65OHFW541616 | 1713 | 1797 | 54 | 16 | 16 | 2 | 89.5 | 10.75 |
| | 65OHFW601616 | 1760 | 1849 | 59.75 | 15.75 | 16 | 2 | 96 | 11.5 |
| | 65OHFW661616 | 1840 | 1934 | 65.75 | 15.75 | 16 | 2 | 102 | 12.75 |
| | 65OHFW721616 | 1922 | 2018 | 71.75 | 15.75 | 16 | 2 | 109 | 13.75 |
| | 65OHFW781616 | 2004 | 2106 | 77.75 | 15.75 | 16 | 2 | 109 | 13.75 |
| | 65OHFW841616 | 2430 | 2551 | 83.75 | 16 | 16 | 2 | 129 | 16.25 |
| | 65OHFW901616 | 2538 | 2664 | 89.5 | 15.75 | 16 | 2 | 109 | 13.75 |
| 65OHFW961616 | 2863 | 3008 | 95.5 | 16 | 16 | 2 | 180 | 16.5 | |

ORDERING NOTES: Overheads and Hutches come standard with LED lights.

ORDERING PROCEDURE

To order, please specify the following:

- 1) Krug product model number
- 2) Wood species and finish
- 3) Grommet location and style if applicable.

* Indicates model illustrated by line drawing

CODE DESCRIPTION

- 4 - full height pedestal
 L - left hand position
 R - right hand position

STANDARD FINISHES





For a complete list of standard wood finishes, please see page 518.

LOCKS

Locks are available at an upcharge of **\$152 list**. Locks not available on sliding hood over-heads.

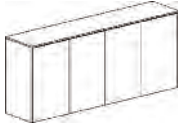
PALETTE FINISH

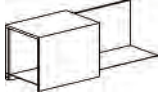
Door fronts are available in Palette at no upcharge, add P at the end of the model number.

| Description | Model | Rift Oak | Walnut | W | D | H | Doors | Shipping Weight | Cubic Feet |
|--|------------------|----------|--------|---------|-------|----|-------|-----------------|------------|
|  Double Height, Wood Doors | 65OHW361630 | 1728 | 1815 | 35.75 | 15.75 | 16 | 2 | 64 | 7 |
| | 65OHW421630 | 1892 | 1987 | 41.75 | 15.75 | 16 | 2 | 71 | 8.5 |
| | 65OHW481630 | 2029 | 2131 | 47.75 | 15.75 | 16 | 3 | 82 | 9 |
| | 65OHW541630 | 2131 | 2237 | 53.75 | 15.75 | 16 | 4 | 89.5 | 10.75 |
| | 65OHW601630 | 2237 | 2347 | 59.75 | 15.75 | 16 | 4 | 96 | 11.5 |
| | 65OHW661630 | 2347 | 2464 | 65.75 | 15.75 | 16 | 4 | 102 | 12.75 |
| | 65OHW721630 | 2464 | 2587 | 71.75 | 15.75 | 16 | 4 | 109 | 13.75 |
| | 65OHW781630 | 2587 | 2717 | 83.75 | 15.75 | 16 | 4 | 129 | 16.25 |
| | 65OHW841630 | 2717 | 2853 | 71.75 | 15.75 | 16 | 6 | 109 | 13.75 |
| | 65OHW901630 | 2853 | 2996 | 83.75 | 15.75 | 16 | 6 | 129 | 16.25 |
| 65OHW961630 | 2996 | 3146 | | | | | | | |
|  Double Height, Wood Flip Doors | 65OHFFW361630 | 1865 | 1959 | 35.75 | 15.75 | 30 | 2 | 107 | 7 |
| | 65OHFFW421630 | 2030 | 2132 | 41.75 | 15.75 | 30 | 2 | 117 | 8.5 |
| | 65OHFFW481630 | 2166 | 2274 | 47.75 | 15.75 | 30 | 2 | 132 | 9 |
| | 65OHFFW541630 | 2406 | 2526 | 53.75 | 15.75 | 30 | 4 | 143 | 10.75 |
| | 65OHFFW601630 | 2511 | 2637 | 59.75 | 15.75 | 30 | 4 | 153 | 11.5 |
| | 65OHFFW661630 | 2623 | 2754 | 65.75 | 15.75 | 30 | 4 | 163 | 12.75 |
| | 65OHFFW721630 | 2741 | 2878 | 71.75 | 15.75 | 30 | 4 | 174 | 13.75 |
| | 65OHFFW781630 | 2863 | 3008 | 83.75 | 15.75 | 30 | 4 | 177 | 16.25 |
| | 65OHFFW841630 | 2992 | 3142 | 71.75 | 15.75 | 30 | 4 | 185 | 13.75 |
| | 65OHFFW901630 | 3131 | 3287 | 83.75 | 15.75 | 30 | 4 | 201 | 16.25 |
| 65OHFFW961630 | 3271 | 3435 | 95.75 | 1' 3/4' | 30 | 4 | 209 | 17.75 | |
|  Double Height, Wood Flip Doors/ Open | 65OHFOW361630 | 2003 | 2105 | 35.75 | 15.75 | 16 | 1 | 64 | 7 |
| | 65OHFOW421630 | 2167 | 2277 | 41.75 | 15.75 | 16 | 1 | 71 | 8.5 |
| | 65OHFOW481630 | 2303 | 2419 | 47.75 | 15.75 | 16 | 1 | 82 | 9 |
| | 65OHFOW541630 | 2682 | 2816 | 53.75 | 15.75 | 16 | 2 | 89.5 | 10.75 |
| | 65OHFOW601630 | 2788 | 2927 | 59.75 | 15.75 | 16 | 2 | 96 | 11.5 |
| | 65OHFOW661630 | 2899 | 3043 | 65.75 | 15.75 | 16 | 2 | 102 | 12.75 |
| | 65OHFOW721630 | 3015 | 3165 | 71.75 | 15.75 | 16 | 2 | 109 | 13.75 |
| | 65OHFOW781630 | 3138 | 3295 | 83.75 | 15.75 | 16 | 2 | 129 | 16.25 |
| | 65OHFOW841630 | 3268 | 3432 | 71.75 | 15.75 | 16 | 2 | 109 | 13.75 |
| | 65OHFOW901630 | 3405 | 3577 | 83.75 | 15.75 | 16 | 2 | 129 | 16.25 |
| 65OHFOW961630 | 3547 | 3727 | 95.75 | 15.75 | 16 | 2 | 250 | 46 | |
|  Single Height Over-head, Sliding 30" Hood, Metal Shelf | 65OMW481718HD30* | 4162 | 4371 | 47.75 | 17 | 18 | | 95 | 10 |
| | 65OMW601718HD30 | 4407 | 4630 | 59.75 | 17 | 18 | | 112 | 12 |
| | 65OMW661718HD30 | 4518 | 4744 | 65.75 | 17 | 18 | | 121 | 13 |
| | 65OMW721718HD30 | 4630 | 4861 | 71.5 | 17 | 18 | | 129 | 14.5 |
| | 65OMW781718HD30 | 4755 | 4992 | 77.5 | 17 | 18 | | 148 | 15.5 |
| | 65OMW841718HD30 | 4846 | 5090 | 83.5 | 17 | 18 | | 157 | 16.5 |
| | 65OMW901718HD30 | 4957 | 5205 | 89.5 | 17 | 18 | | 166 | 17.5 |
| | 65OMW961718HD30 | 5040 | 5293 | 95.5 | 17 | 18 | | 174 | 19 |
|  Single Height Over-head, Sliding 36" Hood, Metal Shelf | 65OMW481718HD36 | 4190 | 4399 | 47.75 | 17 | 18 | | 95 | 10 |
| | 65OMW601718HD36 | 4433 | 4655 | 59.75 | 17 | 18 | | 112 | 12 |
| | 65OMW661718HD36 | 4545 | 4772 | 65.75 | 17 | 18 | | 121 | 13 |
| | 65OMW721718HD36 | 4655 | 4888 | 71.5 | 17 | 18 | | 129 | 14.5 |
| | 65OMW781718HD36 | 4781 | 5020 | 77.5 | 17 | 18 | | 148 | 15.5 |
| | 65OMW841718HD36 | 4874 | 5117 | 83.5 | 17 | 18 | | 157 | 16.5 |
| | 65OMW901718HD36 | 4983 | 5233 | 89.5 | 17 | 18 | | 166 | 17.5 |
| | 65OMW961718HD36* | 5066 | 5320 | 95.5 | 17 | 18 | | 174 | 19 |

ORDERING NOTES: Overheads come standard with LED lights. "90" and "96" Overheads are available with 2 hoods, add -2 to the end of the model number and **\$1778 list** for 30" and **\$1834 list** for 36".

DIMENSION KEY

W — width
 D — depth
 H — height of worksurface
 KW — kneehole width

Dimensions are in inches and approximate. Contact Customer Service if dimensions are critical.





CODE DESCRIPTION

HD - sliding hood
 FF - double flip doors
 FO - flip doors upper, open lower

VENEER

Latitude is available in Quarter Cut Walnut and Rift Cut Oak veneers, and each is priced in this price guide. Maple and Cherry are also available: for Flat Cut Maple or Cherry veneer, use Column 1 pricing; for Quarter Cut Maple or Cherry, use Column 2 pricing. Other veneers are also available on Latitude, please contact us for a quote.



LATITUDE | OVERHEADS

| Description | Model | Rift | | W | D | H | Shipping Weight | Cubic Feet |
|--|---|-----------------|--------|-------|-------|----|-----------------|------------|
| | | Oak | Walnut | | | | | |
|  Single Height Overhead, Open Metal Shelf | 65OMW481718 | 3161 | 3320 | 47.75 | 16 | 16 | 95 | 10 |
| | 65OMW601718 | 3374 | 3542 | 59.75 | 16 | 16 | 112 | 12 |
| | 65OMW661718 | 3497 | 3671 | 65.75 | 16 | 16 | 121 | 13 |
| | 65OMW721718 | 3596 | 3774 | 71.5 | 16 | 16 | 129 | 14.5 |
| | 65OMW781718 | 3710 | 3895 | 77.5 | 16 | 16 | 148 | 15.5 |
| | 65OMW841718 | 3786 | 3975 | 83.5 | 16 | 16 | 157 | 16.5 |
| | 65OMW901718 | 3882 | 4079 | 89.5 | 16 | 16 | 166 | 17.5 |
| | 65OMW961718 | 3969 | 4168 | 95.5 | 16 | 16 | 174 | 19 |
| |  Double Height Overhead, Wood Sliding 30" Hood, Metal Shelf | 65OMW481731HD30 | 5365 | 5634 | 47.75 | 17 | 31 | 95 |
| 65OMW601731HD30 | | 5636 | 5917 | 59.75 | 17 | 31 | 112 | 12 |
| 65OMW661731HD30 | | 5738 | 6023 | 65.75 | 17 | 31 | 121 | 13 |
| 65OMW721731HD30 | | 5975 | 6273 | 71.5 | 17 | 31 | 129 | 14.5 |
| 65OMW781731HD30 | | 6002 | 6303 | 77.5 | 17 | 31 | 148 | 15.5 |
| 65OMW841731HD30 | | 6108 | 6414 | 83.5 | 17 | 31 | 157 | 16.5 |
| 65OMW901731HD30 | | 6230 | 6542 | 89.5 | 17 | 31 | 166 | 17.5 |
| 65OMW961731HD30 | | 6315 | 6630 | 95.5 | 17 | 31 | 174 | 19 |
|  Double Height Overhead, Wood Sliding 36" Hood, Metal Shelf | 65OMW481731HD36 | 5398 | 5668 | 47.75 | 17 | 31 | 95 | 10 |
| | 65OMW601731HD36 | 5671 | 5955 | 59.75 | 17 | 31 | 112 | 12 |
| | 65OMW661731HD36 | 5770 | 6059 | 65.75 | 17 | 31 | 121 | 13 |
| | 65OMW721731HD36 | 6009 | 6311 | 71.5 | 17 | 31 | 129 | 14.5 |
| | 65OMW781731HD36 | 6035 | 6337 | 77.5 | 17 | 31 | 148 | 15.5 |
| | 65OMW841731HD36 | 6141 | 6449 | 83.5 | 17 | 31 | 157 | 16.5 |
| | 65OMW901731HD36 | 6266 | 6579 | 89.5 | 17 | 31 | 166 | 17.5 |
| | 65OMW961731HD36 | 6348 | 6665 | 95.5 | 17 | 31 | 174 | 19 |
|  Double Height Overhead, Open Metal Shelf | 65OMW481731 | 4427 | 4649 | 47.75 | 16 | 30 | 95 | 10 |
| | 65OMW601731 | 4698 | 4932 | 59.75 | 16 | 30 | 112 | 12 |
| | 65OMW661731 | 4799 | 5038 | 65.75 | 16 | 30 | 121 | 13 |
| | 65OMW721731 | 5037 | 5289 | 71.5 | 16 | 30 | 129 | 14.5 |
| | 65OMW781731 | 5065 | 5319 | 77.5 | 16 | 30 | 148 | 15.5 |
| | 65OMW841731 | 5170 | 5429 | 83.5 | 16 | 30 | 157 | 16.5 |
| | 65OMW901731 | 5293 | 5558 | 89.5 | 16 | 30 | 166 | 17.5 |
| | 65OMW961731 | 5378 | 5646 | 95.5 | 16 | 30 | 174 | 19 |

ORDERING NOTES: Overheads come standard with LED lights. "90" and "96" Overheads are available with 2 hoods, add -2 to the end of the model number and **\$1778 list for 30"** and **\$1834 list for 36"**.

| ORDERING PROCEDURE | CODE DESCRIPTION | STANDARD FINISHES |
|---|---|---|
| To order, please specify the following: 1) Krug product model number 2) Wood species and finish 3) Grommet location and style if applicable. | HD - sliding hood FF - double flip doors | For a complete list of standard wood finishes, please see page 518. |
| * Indicates model illustrated by line drawing | | |

LATITUDE | TACKBOARDS FOR OVERHEADS

| Description | Model | GRADES | | | | | | | | | W | H | COM | WT |
|--|-------------|--------|------|------|------|------|------|------|------|------|-------|----|------|------|
| | | 1 | 2 | 3 | 4 | 5 | 6 | 7 | 8 | 9 | | | | |
| Wall Mounted Tackboard 24" High  | 65TBOHW3624 | 333 | 369 | 407 | 465 | 605 | 741 | 875 | 1018 | 1198 | 35.75 | 24 | 1.5 | 1.5 |
| | 65TBOHW4224 | 369 | 497 | 529 | 654 | 785 | 908 | 1038 | 1199 | 1421 | 41.75 | 24 | 1.5 | 1.75 |
| | 65TBOHW4824 | 411 | 512 | 536 | 673 | 807 | 924 | 1066 | 1228 | 1478 | 47.75 | 24 | 1.75 | 2 |
| | 65TBOHW5424 | 434 | 537 | 561 | 706 | 846 | 971 | 1120 | 1288 | 1551 | 53.75 | 24 | 2 | 2.25 |
| | BOHW6024 | 468 | 624 | 655 | 816 | 982 | 1163 | 1345 | 1527 | 1815 | 59.75 | 24 | 2 | 2.5 |
| | BOHW6624 | 513 | 697 | 746 | 909 | 1089 | 1295 | 1473 | 1683 | 2006 | 65.75 | 24 | 2 | 2.75 |
| | BOHW7224 | 562 | 864 | 898 | 1192 | 1464 | 1483 | 1702 | 1942 | 2264 | 71.75 | 24 | 2.25 | 3 |
| | BOHW7824 | 619 | 949 | 988 | 1311 | 1612 | 1633 | 1872 | 2135 | 2491 | 77.75 | 24 | 2.25 | 3.25 |
| | BOHW8424 | 723 | 1109 | 1155 | 1534 | 1884 | 1908 | 2191 | 2500 | 2913 | 83.75 | 24 | 2.5 | 3.5 |
| | BOHW9024 | 761 | 1165 | 1215 | 1611 | 1982 | 2004 | 2302 | 2629 | 3061 | 89.75 | 24 | 2.75 | 3.75 |
| | BOHW9624 | 791 | 1212 | 1265 | 1676 | 2061 | 2087 | 2396 | 2736 | 3188 | 95.75 | 24 | 3 | 4 |
| Wall Mounted Tackboard 30" High  | 65TBOHW3630 | 399 | 444 | 488 | 559 | 727 | 888 | 1222 | 1222 | 1437 | 35.75 | 24 | 1.5 | 2 |
| | 65TBOHW4230 | 444 | 552 | 633 | 784 | 943 | 1088 | 1439 | 1439 | 1697 | 41.75 | 24 | 1.5 | 2.25 |
| | 65TBOHW4830 | 493 | 614 | 642 | 806 | 967 | 1108 | 1473 | 1473 | 1771 | 47.75 | 24 | 1.75 | 2.5 |
| | 65TBOHW5430 | 520 | 644 | 674 | 848 | 1016 | 1165 | 1547 | 1547 | 1860 | 53.75 | 24 | 2 | 2.75 |
| | BOHW6030 | 561 | 749 | 784 | 979 | 1177 | 1394 | 1833 | 1833 | 2177 | 59.75 | 24 | 2 | 3 |
| | BOHW6630 | 615 | 837 | 894 | 1090 | 1307 | 1555 | 2018 | 2018 | 2407 | 65.75 | 24 | 2 | 3.25 |
| | BOHW7230 | 674 | 1033 | 1074 | 1428 | 1755 | 1778 | 2329 | 2329 | 2715 | 71.75 | 24 | 2.25 | 3.5 |
| | BOHW7830 | 741 | 1138 | 1187 | 1572 | 1935 | 1957 | 2566 | 2566 | 2989 | 77.75 | 24 | 2.5 | 3.75 |
| | BOHW8430 | 869 | 1331 | 1386 | 1841 | 2261 | 2287 | 2999 | 2999 | 3495 | 83.75 | 24 | 2.5 | 4 |
| | BOHW9030 | 913 | 1398 | 1458 | 1934 | 2378 | 2407 | 3153 | 3153 | 3673 | 89.75 | 24 | 2.75 | 4.75 |
| | BOHW9630 | 952 | 1456 | 1518 | 2014 | 2478 | 2506 | 3280 | 3280 | 3825 | 95.75 | 24 | 3 | 5 |

DIMENSION KEY

W — width
 D — depth
 H — height of worksurface
 KW — kneehole width

Dimensions are in inches and approximate.
 Contact Customer Service if dimensions are critical.

VENEER

Latitude is available in Quarter Cut Walnut and Rift Cut Oak veneers, and each is priced in this price guide. Maple and Cherry are also available: for Flat Cut Maple or Cherry veneer, use Column 1 pricing; for Quarter Cut Maple or Cherry, use Column 2 pricing. Other veneers are also available on Latitude, please contact us for a quote.

LATITUDE | HUTCHES

| Description | Model | Rift | | W | D | H | Doors | Shipping Weight | Cubic Feet |
|--|-------------|------|--------|-------|-------|----|-------|-----------------|------------|
| | | Oak | Walnut | | | | | | |
| 5 Hi Hutch with Wood Doors  | 65HT601640 | 2922 | 3069 | 59.75 | 15.75 | 40 | 4 | 117 | 23 |
| | 65HT661640 | 3112 | 3267 | 65.75 | 15.75 | 40 | 4 | 126 | 26 |
| | 65HT721640 | 3555 | 3733 | 71.75 | 15.75 | 40 | 4 | 135 | 28 |
| | 65HT781640 | 3831 | 4023 | 77.75 | 15.75 | 40 | 4 | 146 | 30 |
| | 65HT841640 | 4108 | 4313 | 83.75 | 15.75 | 40 | 4 | 154 | 32 |
| | 65HT961640 | 4173 | 4381 | 95.5 | 15.75 | 40 | 6 | 211 | 39 |
| | 65HT1021640 | 5106 | 5361 | 102 | 15.75 | 40 | 6 | 296 | 43 |
| | 65HT1081640 | 5302 | 5566 | 108 | 15.75 | 40 | 6 | 310 | 58.5 |

ORDERING NOTES: Hutches 102" and longer are 2 piece units.

| | | | | | | | | | |
|---|-------------|------|------|-------|-------|----|---|-----|----|
| 5 Hi Hutch with Wood Flip Doors  | 65HTF601640 | 3197 | 3357 | 59.75 | 15.75 | 40 | 2 | 117 | 23 |
| | 65HTF661640 | 3386 | 3557 | 65.75 | 15.75 | 40 | 2 | 126 | 26 |
| | 65HTF721640 | 3830 | 4022 | 71.75 | 15.75 | 40 | 2 | 135 | 28 |
| | 65HTF781640 | 4108 | 4313 | 77.75 | 15.75 | 40 | 2 | 146 | 30 |
| | 65HTF841640 | 4382 | 4603 | 83.75 | 15.75 | 40 | 2 | 154 | 32 |
| | 65HTF961640 | 4449 | 4670 | 95.5 | 15.75 | 40 | 2 | 211 | 39 |

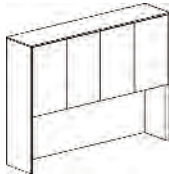
| | | | | | | | | | |
|---|------------|------|------|-------|-------|------|---|-----|-------|
| 6 Hi Hutch with Wood Doors  | 65HT601653 | 3012 | 3162 | 59.75 | 15.75 | 53.5 | 4 | 249 | 34.5 |
| | 65HT661653 | 3269 | 3433 | 65.75 | 15.75 | 53.5 | 4 | 269 | 37.75 |
| | 65HT721653 | 3714 | 3902 | 71.75 | 15.75 | 53.5 | 4 | 289 | 41 |
| | 65HT781653 | 4016 | 4217 | 77.75 | 15.75 | 53.5 | 4 | 298 | 44.5 |
| | 65HT841653 | 4315 | 4531 | 83.75 | 15.75 | 53.5 | 4 | 328 | 47.75 |
| | 65HT961653 | 4498 | 4721 | 95.5 | 15.75 | 53.5 | 6 | 358 | 52.5 |

| | | | | | | | | | |
|---|--------------|------|------|-------|-------|------|---|-----|-------|
| 6 Hi Hutch with Wood Flip Doors  | 65HTFF601653 | 3289 | 3453 | 59.75 | 15.75 | 53.5 | 4 | 249 | 34.5 |
| | 65HTFF661653 | 3545 | 3723 | 65.75 | 15.75 | 53.5 | 4 | 269 | 37.75 |
| | 65HTFF721653 | 3991 | 4190 | 71.75 | 15.75 | 53.5 | 4 | 289 | 41 |
| | 65HTFF781653 | 4292 | 4507 | 77.75 | 15.75 | 53.5 | 4 | 298 | 44.5 |
| | 65HTFF841653 | 4590 | 4819 | 83.75 | 15.75 | 53.5 | 4 | 328 | 47.75 |
| | 65HTFF961653 | 4772 | 5010 | 95.5 | 15.75 | 53.5 | 4 | 358 | 52.5 |

| | | | | | | | | | |
|--|--------------|------|------|-------|-------|------|---|-----|-------|
| 6 Hi Hutch with Wood Flip Doors/Open  | 65HTFO601653 | 3563 | 3741 | 59.75 | 15.75 | 53.5 | 2 | 249 | 35.5 |
| | 65HTFO661653 | 3820 | 4013 | 65.75 | 15.75 | 53.5 | 2 | 269 | 37.75 |
| | 65HTFO721653 | 4266 | 4481 | 71.75 | 15.75 | 53.5 | 2 | 289 | 41 |
| | 65HTFO781653 | 4567 | 4796 | 77.75 | 15.75 | 53.5 | 2 | 298 | 44.5 |
| | 65HTFO841653 | 4866 | 5110 | 83.75 | 15.75 | 53.5 | 2 | 328 | 47.75 |
| | 65HTFO961653 | 5049 | 5300 | 95.5 | 15.75 | 53.5 | 2 | 358 | 52.5 |

ORDERING NOTES: Hutches come standard with LED lights. To specify a Voice/Power/Data module with any hutch, please add "W" at the end of the model number and a **\$252 list** upcharge. Locks are available at an upcharge of **\$152 list**.

ORDERING PROCEDURE

To order, please specify the following:

- 1) Krug product model number
- 2) Wood species and finish
- 3) Grommet location and style if applicable.

* Indicates model illustrated by line drawing

CODE DESCRIPTION

- F - flip doors
- FF - double flip doors
- FO - flip doors upper, open lower

STANDARD FINISHES

For a complete list of standard wood finishes, please see page 518.

KRUG TEXTILES

For a Krug Panel Fabric program, please see page 4.

LATITUDE | PIERS, ACCESSORIES & TACKBOARD FABRIC UPGRADE

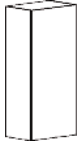
| Description | Model | Rift | | W | D | H | Shipping Weight | Cubic Feet |
|---|---------------|------|--------|----|-------|----|-----------------|------------|
| | | Oak | Walnut | | | | | |
|  Pier Closed, Hinged Wood Door | 65PR24164011L | 1227 | 1289 | 24 | 15.75 | 40 | 123 | 11.25 |
| | 65PR24164011R | 1227 | 1289 | 24 | 15.75 | 40 | 123 | 11.25 |
| | 65PR24164611L | 1285 | 1349 | 24 | 15.75 | 46 | 134 | 12.75 |
| | 65PR24164611R | 1285 | 1349 | 24 | 15.75 | 46 | 134 | 12.75 |
| | 65PR24165311L | 1345 | 1412 | 24 | 15.75 | 53 | 148 | 14.75 |
| | 65PR24165311R | 1345 | 1412 | 24 | 15.75 | 53 | 148 | 14.75 |
| | 65PR24165911L | 1403 | 1474 | 24 | 15.75 | 59 | 159 | 16.5 |
| | 65PR24165911R | 1403 | 1474 | 24 | 15.75 | 59 | 159 | 16.5 |

| | | | | | | | | |
|----------------------------------|--------------|-----|--|----|---|------|----|--|
| Keyboard Tray for Standard Units | 65KBAMT1912 | 411 | | 28 | - | 8.25 | 20 | |
| | 65KBAMT1912S | 483 | | 28 | - | 8.25 | 20 | |



| | | | | | | | | |
|---|--------------|-----|--|----|---|------|----|--|
| Keyboard Tray for Angled & Curved Units | 65KBAMT1912X | 428 | | 28 | - | 8.25 | 20 | |
|---|--------------|-----|--|----|---|------|----|--|



| | | | | | | | | |
|---------------|-----------|-----|--|----|----|---|---|---|
| Pencil Drawer | 65PD2119 | 345 | | 21 | 19 | 2 | 2 | 1 |
| | 65PD2119S | 381 | | 21 | 19 | 2 | 2 | 1 |



| | | | | | | | | |
|------------|-------|-----|--|--|--|--|---|------|
| Pencil Cup | 65APH | 193 | | | | | 1 | 0.25 |
|------------|-------|-----|--|--|--|--|---|------|



| | | | | | | | | | |
|---|--------|-----|--|--|--|--|--|--|--|
| Height Adjustable Table Programmable Display- 4 Position Memory | 88HAPD | 376 | | | | | | | |
|---|--------|-----|--|--|--|--|--|--|--|



| Description | Model | GRADES | | | | | | | | COM |
|-----------------------|-------|--------|-----|------|------|------|------|------|------|------|
| | | 2 | 3 | 4 | 5 | 6 | 7 | 8 | 9 | |
| Tackboard Fabric | 60 | 143 | 309 | 468 | 633 | 799 | 962 | 1131 | 1327 | 2 |
| Upcharges for Hutches | 66 | 165 | 359 | 521 | 697 | 869 | 1021 | 1199 | 1487 | 2 |
| | 72 | 199 | 426 | 622 | 837 | 1036 | 1236 | 1437 | 1727 | 2.25 |
| | 78 | 234 | 500 | 735 | 974 | 1206 | 1443 | 1677 | 2003 | 2.5 |
| | 84 | 278 | 580 | 859 | 1136 | 1414 | 1690 | 1965 | 2322 | 2.5 |
| | 90 | 287 | 601 | 894 | 1179 | 1467 | 1755 | 2043 | 2415 | 2.75 |
| | 96 | 299 | 626 | 930 | 1228 | 1528 | 1827 | 2126 | 2634 | 3 |
| | 102 | 331 | 714 | 1048 | 1403 | 1743 | 2070 | 2433 | 2988 | 3 |
| | 108 | 363 | 781 | 1149 | 1536 | 1909 | 2271 | 2638 | 3273 | 3 |



DIMENSION KEY

W — width
 D — depth
 H — height of worksurface
 KW — kneehole width

Dimensions are in inches and approximate. Contact Customer Service if dimensions are critical.

CODE DESCRIPTION

11 - closed bookcase
 L - left hand position
 R - right hand position

VENEER

Latitude is available in Quarter Cut Walnut and Rift Cut Oak veneers, and each is priced in this price guide. Maple and Cherry are also available: for Flat Cut Maple or Cherry veneer, use Column 1 pricing; for Quarter Cut Maple or Cherry, use Column 2 pricing. Other veneers are also available on Latitude, please contact us for a quote.

LATITUDE | WALL MOUNTED BACK-PAINTED GLASS

| Description | Model | Price | W | D | H | Shipping Weight | Cubic Feet |
|--------------|-----------|-------|-------|---|------|-----------------|------------|
| Wall Mounted | 65GPW3624 | 1765 | 35.75 | - | 23.5 | 48 | 1.5 |
| Back-painted | 65GPW4224 | 1852 | 41.75 | - | 23.5 | 56 | 1.75 |
| Glass 23.5" | 65GPW4824 | 1936 | 47.75 | - | 23.5 | 64 | 2 |
| | 65GPW5424 | 2023 | 53.75 | - | 23.5 | 72 | 2.25 |
| | 65GPW6024 | 2136 | 59.75 | - | 23.5 | 80 | 2.5 |
| | 65GPW6624 | 2295 | 65.75 | - | 23.5 | 88 | 2.75 |
| | 65GPW7224 | 2452 | 71.5 | - | 23.5 | 96 | 3 |
| | 65GPW7824 | 2638 | 77.5 | - | 23.5 | 104 | 3.25 |
| | 65GPW8424 | 2810 | 83.5 | - | 23.5 | 112 | 3.5 |
| | 65GPW9024 | 3255 | 89.5 | - | 23.5 | 120 | 3.75 |
| | 65GPW9624 | 3384 | 95.5 | - | 23.5 | 128 | 4 |

ORDERING NOTES: Use between wall mounted overhangs and full height credenzas. Wall mounted Back-Painted glass panels 90" and longer are 2-pieces. Standard finish is white

| | | | | | | | |
|--------------|-----------|------|-------|---|----|-----|------|
| Wall Mounted | 65GPW3630 | 2108 | 35.75 | - | 30 | 60 | 2 |
| Back-painted | 65GPW4230 | 2221 | 41.75 | - | 30 | 70 | 2.25 |
| Glass 30" | 65GPW4830 | 2323 | 47.75 | - | 30 | 80 | 2.5 |
| | 65GPW5430 | 2410 | 53.75 | - | 30 | 90 | 2.75 |
| | 65GPW6030 | 2567 | 59.75 | - | 30 | 100 | 3.25 |
| | 65GPW6630 | 2768 | 65.75 | - | 30 | 110 | 3.5 |
| | 65GPW7230 | 2984 | 71.5 | - | 30 | 120 | 3.75 |
| | 65GPW7830 | 3184 | 77.5 | - | 30 | 130 | 4 |
| | 65GPW8430 | 3428 | 83.5 | - | 30 | 140 | 4.25 |
| | 65GPW9030 | 3628 | 89.5 | - | 30 | 150 | 4.75 |
| | 65GPW9630 | 3798 | 95.5 | - | 30 | 160 | 5 |

ORDERING NOTES: Use between wall mounted overhangs and 3/4 height credenzas. Wall mounted Back-Painted glass panels 90" and longer are 2-pieces. Standard finish is white

| | | | | | | | |
|--|------------|------|-------|---|------|-----|------|
| Wall Mounted Mag- netic Back-painted Glass 23.5" | 65GPW3624M | 1936 | 35.75 | - | 23.5 | 48 | 1.5 |
| | 65GPW4224M | 2053 | 41.75 | - | 23.5 | 56 | 1.75 |
| | 65GPW4824M | 2166 | 47.75 | - | 23.5 | 64 | 2 |
| | 65GPW5424M | 2280 | 53.75 | - | 23.5 | 72 | 2.25 |
| | 65GPW6024M | 2422 | 59.75 | - | 23.5 | 80 | 2.5 |
| | 65GPW6624M | 2625 | 65.75 | - | 23.5 | 88 | 2.75 |
| | 65GPW7224M | 2824 | 71.5 | - | 23.5 | 96 | 3 |
| | 65GPW7824M | 3055 | 77.5 | - | 23.5 | 104 | 3.25 |
| | 65GPW8424M | 3269 | 83.5 | - | 23.5 | 112 | 3.5 |
| | 65GPW9024M | 3757 | 89.5 | - | 23.5 | 120 | 3.75 |
| | 65GPW9624M | 3930 | 95.5 | - | 23.5 | 128 | 4 |

ORDERING NOTES: Use between wall mounted overhangs and full height credenzas. Strong magnets (not supplied) are recommended. Wall mounted Back-Painted glass panels 90" and longer are 2-pieces. Standard finish is white.

| | | | | | | | |
|--|------------|------|-------|---|----|-----|------|
| Wall Mounted Mag- netic Back-painted Glass 30" | 65GPW3630M | 2323 | 35.75 | - | 30 | 60 | 2 |
| | 65GPW4230M | 2465 | 41.75 | - | 30 | 70 | 2.25 |
| | 65GPW4830M | 2595 | 47.75 | - | 30 | 80 | 2.5 |
| | 65GPW5430M | 2723 | 53.75 | - | 30 | 90 | 2.75 |
| | 65GPW6030M | 2911 | 59.75 | - | 30 | 100 | 3.25 |
| | 65GPW6630M | 3156 | 65.75 | - | 30 | 110 | 3.5 |
| | 65GPW7230M | 3412 | 71.5 | - | 30 | 120 | 3.75 |
| | 65GPW7830M | 3656 | 77.5 | - | 30 | 130 | 4 |
| | 65GPW8430M | 3941 | 83.5 | - | 30 | 140 | 4.25 |
| | 65GPW9030M | 4186 | 89.5 | - | 30 | 150 | 4.75 |
| | 65GPW9630M | 4401 | 95.5 | - | 30 | 160 | 5 |

ORDERING NOTES: Use between wall mounted overhangs and 3/4 height credenzas. Strong magnets (not supplied) are recommended. Wall mounted Back-Painted glass panels 90" and longer are 2-pieces. Standard finish is white.

ORDERING PROCEDURE

To order, please specify the following:
 1) Krug product model number
 2) Wood species and finish
 3) Grommet location and style if applicable.

* Indicates model illustrated by line drawing



CODE DESCRIPTION

M - Magnetic

STANDARD FINISHES

For a complete list of standard wood finishes, please see page 518.

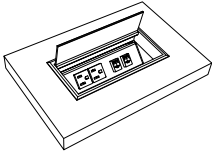
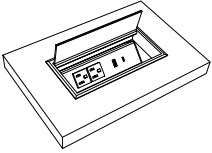
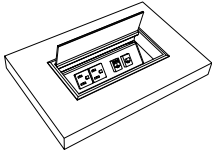
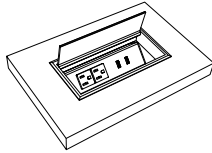
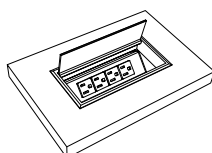
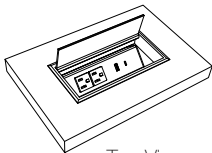
POWERPORTS

| Description | Model | Price | W | D | H | Shipping Weight | Cubic Feet |
|--|--|-------|---|---|---|-----------------|------------|
| PowerPort 1 - 2 RJ45s (Category 5/6) | PORT1 | 278 | 8 | 4 | - | - | - |
|  | <p>Port Includes: 2 accessible power outlets & 1 side utility outlet powered by a 10' plug-in cord; 2 RJ45 (category 5/6) each with hard wired 10' data cords; 2 velcro wire managers and metal PowerPort shroud. PortPort lid is Silver Metallic.</p> <p>NOTE: RJ45 jacks with hard wired data cords included here must be within 10' of building utilities source to be functional.</p> | | | | | | |
| PowerPort 2 - USB-A & USB-C | PORT2 | 280 | 8 | 4 | - | - | - |
|  | <p>Port Includes: 2 accessible power outlets & 1 side utility outlet; 1 USB-A & 1 USB-C charging ports all powered by a 10' plug-in cord; 2 velcro wire managers and metal PowerPort shroud. PortPort lid is Silver Metallic.</p> | | | | | | |
| PowerPort 3 - RJ11 & RJ45 | PORT3 | 269 | 8 | 4 | - | - | - |
|  | <p>Port Includes: 2 accessible power outlets & 1 side utility outlet; 1 RJ11 & 1 RJ45 (Category 5/6); 2 Velcro wire managers & PowerPort Shroud; 1 x 10 Foot Data Cords (T568A) & 1 x 14 Foot RJ11 (Telecomm); powered by a 10' plug-in cord. PortPort lid is Silver Metallic.</p> <p>NOTE: RJ45 & RJ11 jacks with hard wired data cords included here must be within 10' of building utilities source to be functional.</p> | | | | | | |
| PowerPort 4 - 2 USB-A | PORT4 | 286 | 8 | 4 | - | - | - |
|  | <p>Port Includes: 2 accessible power outlets & 1 side utility outlet; 2- USB-A charging ports all powered by a 10' plug-in cord; 2 velcro wire managers and metal PortPort shroud. PortPort lid is Silver Metallic.</p> | | | | | | |
| PowerPort 5 - 4 Receptacles | PORT5 | 280 | 8 | 4 | - | - | - |
|  | <p>Port Includes: 4 accessible power outlets & 1 side utility outlet powered by a 10' plug-in cord; 2 velcro wire managers and metal power port shroud. PortPort lid is Silver Metallic.</p> | | | | | | |
| PowerPort 6 - USB-A, USB-C & RJ45 | PORT6 | 406 | 8 | 4 | - | - | - |
|   | <p>Port Includes: 2 accessible power outlets & 1 side utility outlet 1 USB-A, 1 USB-C charging ports all powered by a 10' plug-in power cord. Includes 2 velcro wire managers and metal PortPort shroud with 2 data plate knock outs, 1 #M02 plate insert & 2 #S01W RJ45 female input, punch down terminal output snap in jacks. 2nd data plate knock out is blank for future use. PortPort lid is Silver Metallic.</p> | | | | | | |

POWERPORTS

| Description | Model | Price | W | D | H | Shipping Weight | Cubic Feet |
|--------------------|-------|-------|---|---|---|-----------------|------------|
| Port - no Powerbar | Port0 | 137 | 8 | 4 | - | - | - |

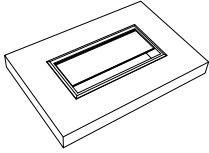

Port Includes: Port lid & Shroud only.

ORDERING NOTE: Velcro wire managers not included, see below for pricing. Port lid is Silver Metallic.

| | | | | | | | |
|---|-----------|------------------------------------|---|---|---|---|---|
| PowerPort Shroud with 2 Data Plate Knock-outs | SHROUD2KO | Must be requested - no upcharge | - | - | - | - | - |
|---|-----------|------------------------------------|---|---|---|---|---|

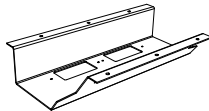

Angled PowerPort Shroud Includes: shroud with 2 data plate knock-outs in the bottom.

ORDERING NOTE: Please refer to data plate, data and AV integration options on page XX.

| | | | | | | | |
|-----------------------------|------|----|---|-----|-----|---|---|
| Velcro Wire Manager (qty 1) | WM-4 | 26 | 2 | 4.5 | 0.5 | - | - |
|-----------------------------|------|----|---|-----|-----|---|---|

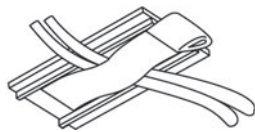

2 velcro wire managers are included with Ports 1-5.

| | | | | | | | |
|------------------------|-------|-----|----|---|---|---|---|
| Wire Management Trough | WM-72 | 182 | 72 | 3 | 1 | - | - |
|------------------------|-------|-----|----|---|---|---|---|



Wire Management Trough is standard in a 72" length & can be cut to specific length; double-sided tape installation.

| | | | | | | | |
|---------------------------|-------|-----|----|---|---|---|---|
| 4-Channel Wire Management | CM-72 | 231 | 72 | 3 | 1 | - | - |
|---------------------------|-------|-----|----|---|---|---|---|

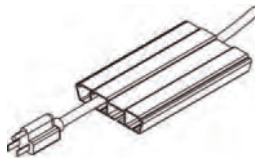



4-Channel Wire Management is standard in a 72" length & can be cut to specific length; double-sided tape installation.

| | | | | | | | |
|---------------|---------------------------------|-----|---|---|---|---|---|
| Round Grommet | Round Grommet - Silver Metallic | 152 | - | - | - | - | - |
| | Round Grommet - Black | 152 | - | - | - | - | - |

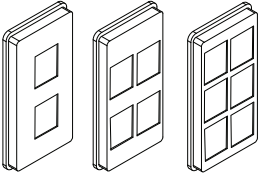

One 60mm Grommet in a standard position is available at no charge per table.

POWER/DATA

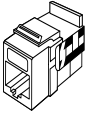
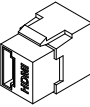
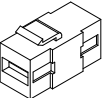
| SNAP IN PORTS | Reference Code | Description | List Price |
|---|----------------|---|------------|
| ADAPTOR PLATES | | | |
|  | M02 | Adaptor Plate (2) - accepts two snap in data ports | 38 |
| | M04 | Adaptor Plate (4) - accepts four snap in data ports | 38 |
| | M06 | Adaptor Plate (6) - accepts six snap in data ports | 38 |
| ORDERING NOTES: Blank covers are required when port is not in use, please see page 55. | | | |
|  | | RJ-45 - Category 6 data connection. This connector is also downwards compatible with Category 5 cabling. Connector is a female input with a #110 punch-down terminal block output (back side of Console interface) for on-site hard wire connection. | 47 |
| | S01W | RJ45-CAT6 (White) | |
| | S01B | RJ45-CAT6 (Blue) | |
| | S01R | RJ45-CAT6 (Red) | |
|  | | RJ11 - Telephone type connection. Connector is a female input with a #110 punch-down terminal block output (back side of Console interface) for on-site hard wire connection. | 32 |
| | S02W | RJ11 (White) | |
| | S02B | RJ11-B (Black) | |
| | S02G | RJ11-G (Green) | |
| | S02R | RJ11-R (Red) | |
| | S02Y | RJ11-Y (Yellow) | |
|  | S04 | HDMI - High Definition Multimedia Interface connection. Connector carries both HD audio and video data. Connector is a female-to-female pass through. | 173 |
| | | | |
|  | S08 | USB-A - Full size USB "A" style connection. Connector is a female-to-female pass through. | 61 |
| | | | |

LATITUDE | POWER & CABLE MANAGEMENT

| Description | Model | Price | W | D | H | Shipping Weight | Cubic Feet |
|---|--------|-------|----|---|---|-----------------|------------|
|  | 65CT36 | 59 | 30 | 2 | - | .25 | - |
| | 65CT42 | 74 | 36 | 2 | - | .25 | - |
| | 65CT48 | 91 | 36 | 2 | - | .25 | - |
| | 65CT54 | 105 | 48 | 2 | - | .5 | - |
| | 65CT60 | 121 | 48 | 2 | - | .5 | - |
| | 65CT66 | 137 | 52 | 2 | - | .5 | - |
| | 65CT72 | 152 | 60 | 2 | - | .75 | - |
| | 65CT84 | 168 | 60 | 2 | - | .75 | - |

NOTE: For Desk Runoffs only.

| | | | | | | | |
|--|--------|----|---|---|------|---|-----|
| Height Adjustable Work Surface Cable Manager | 65HACM | 89 | 4 | 3 | 21.5 | 5 | .25 |
|--|--------|----|---|---|------|---|-----|

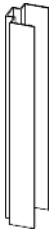

| | | | | | | | |
|---------------------------|--------|-----|---|---|---|---|---|
| Power, Data, Voice Module | 65PDVM | 226 | - | - | - | - | - |
|---------------------------|--------|-----|---|---|---|---|---|



| | | | | | | | |
|---|--------|-----|---|---|---|---|---|
| Height Adjustable Table Programmable Display- 4 Position Memory | 88HAPD | 376 | - | - | - | - | - |
|---|--------|-----|---|---|---|---|---|



ORDERING PROCEDURE

To order, please specify the following:





- 1) Krug product model number
- 2) Wood species and finish
- 3) Grommet location and style if applicable.

* Indicates model illustrated by line drawing

STANDARD FINISHES

For a complete list of standard wood finishes, please see page 518.

LATITUDE | PEDESTALS FOR SHELLS

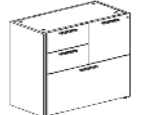
| Description | Model | Rift | | W | D | H | Shipping Weight | Cubic Feet |
|---|------------|------|--------|-------|------|------|-----------------|------------|
| | | Oak | Walnut | | | | | |
| Pedestal Box/Box/File | 65P16184F* | 1378 | 1447 | 15.75 | 18 | 28.5 | 61 | 6.5 |
| | 65P16284F | 1592 | 1671 | 15.75 | 27.5 | 28.5 | 66 | 9 |
|  | | | | | | | | |
| Pedestal File/File | 65P16184D* | 1272 | 1335 | 15.75 | 18 | 28.5 | 61 | 6.5 |
| | 65P16284D | 1484 | 1559 | 15.75 | 27.5 | 28.5 | 66 | 9 |
|  | | | | | | | | |
| Pedestal Bookcase | 65P301811* | 1477 | 1551 | 30 | 18 | 28.5 | 104 | 11.5 |
| | 65P361811 | 1653 | 1735 | 36 | 18 | 28.5 | 112 | 13.5 |
|  | | | | | | | | |
| Pedestal Lateral File | 65P301801* | 1695 | 1780 | 30 | 18 | 28.5 | 104 | 11.5 |
| | 65P361801 | 1899 | 1995 | 36 | 18 | 28.5 | 112 | 13.5 |
|  | | | | | | | | |
| Pedestal 36" File/2 Box, Lateral File Combination | 65P361802 | 1866 | 1960 | 36 | 18 | 28.5 | 112 | 13.5 |
| | 65P361804* | 1866 | 1960 | 36 | 18 | 28.5 | 112 | 13.5 |
|  | | | | | | | | |

ORDERING NOTES: When specifying modular pedestals please state left, center or right. For a pedestal in the left position add L to the end of the model number, for a pedestal in the center position add C to the end of the model number and for a pedestal in the right position add R to the end of the model number.

DIMENSION KEY

W — width
D — depth
H — height of worksurface
KW— kneehole width

Dimensions are in inches and approximate.
Contact Customer Service if dimensions are critical.

CODE DESCRIPTION

4 - full height pedestal
D - 2 file drawers
F - 2 box, 1 file drawer
11 - closed bookcase
01 - lateral file
02 - 2 box on right, 1 file drawer left, lateral file
04 - 1 file drawer right, 2 box on left, lateral file
L - left hand position
R - right hand position
C - center position

VENEER

Latitude is available in Quarter Cut Walnut and Rift Cut Oak veneers, and each is priced in this price guide. Maple and Cherry are also available; for Flat Cut Maple or Cherry veneer, use Column 1 pricing; for Quarter Cut Maple or Cherry, use Column 2 pricing. Other veneers are also available on Latitude, please contact us for a quote.

LATITUDE | BOOKCASES

| Description | Model | Rift | | W | D | H | Shipping Weight | Cubic Feet |
|--------------------|------------|------|--------|----|----|----|-----------------|------------|
| | | Oak | Walnut | | | | | |
| 2 Hi Open Bookcase | 65BC301629 | 1715 | 1801 | 30 | 16 | 29 | 48 | 10 |
| | 65BC361629 | 1761 | 1852 | 36 | 16 | 29 | 56 | 12 |



| | | | | | | | | |
|---------------------|------------|------|------|----|----|-------|----|-------|
| 3 Hi Bookcase, Open | 65BC361643 | 2085 | 2190 | 36 | 16 | 42.75 | 72 | 21.75 |
|---------------------|------------|------|------|----|----|-------|----|-------|



| | | | | | | | | |
|---------------------|------------|------|------|----|----|----|-----|-------|
| 4 Hi Bookcase, Open | 65BC301656 | 2122 | 2229 | 30 | 16 | 56 | 64 | 18 |
| | 65BC361656 | 2170 | 2280 | 36 | 16 | 56 | 120 | 20.75 |



| | | | | | | | | |
|---------------------|------------|------|------|----|----|------|-----|------|
| 5 Hi Bookcase, Open | 65BC301670 | 2301 | 2415 | 30 | 16 | 69.5 | 100 | 22.5 |
| | 65BC361670 | 2347 | 2464 | 36 | 16 | 69.5 | 112 | 27 |



| | | | | | | | | |
|---------------------|------------|------|------|----|----|----|-----|-------|
| 6 Hi Bookcase, Open | 65BC301683 | 2699 | 2835 | 30 | 16 | 83 | 163 | 28.25 |
| | 65BC361683 | 2765 | 2904 | 36 | 16 | 83 | 178 | 33 |



ORDERING NOTES:

Bookcases must be fastened to the wall. Hardware is not supplied.

ORDERING PROCEDURE

To order, please specify the following:

- 1) Krug product model number
- 2) Wood species and finish
- 3) Grommet location and style if applicable.

* Indicates model illustrated by line drawing

STANDARD FINISHES

For a complete list of standard wood finishes, please see page 518.

| Description | Model | Rift | | W | D | H | Shipping Weight | Cubic Feet |
|---------------------------------|--------------|------|--------|----|----|----|-----------------|------------|
| | | Oak | Walnut | | | | | |
| 1.5 Hi Storage, Closed Bookcase | 65ST30242311 | 2046 | 2046 | 30 | 24 | 23 | 96 | 11 |
| | 65ST36242311 | 2209 | 2209 | 36 | 24 | 23 | 98 | 13 |



| | | | | | | | | |
|----------------------------------|---------------|------|------|----|----|----|-----|----|
| 1.5 Hi Storage, Box/Lateral File | 65ST30242316 | 2390 | 2390 | 30 | 24 | 23 | 159 | 11 |
| | 65ST36242316* | 2557 | 2557 | 36 | 24 | 23 | 165 | 13 |

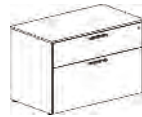

| | | | | | | | | |
|----------------------|--------------|------|------|----|----|----|-----|----|
| 1.5 Hi Storage, Open | 65ST30242317 | 1836 | 1836 | 30 | 24 | 23 | 100 | 11 |
| | 65ST36242317 | 1985 | 1985 | 36 | 24 | 23 | 112 | 13 |



| | | | | | | | | |
|-----------------------------------|--------------|------|------|----|----|----|-----|-------|
| 2 Hi Storage Unit Closed Bookcase | 65ST36202911 | 2124 | 2124 | 36 | 20 | 29 | 163 | 13.75 |
| | 65ST36242911 | 2302 | 2302 | 36 | 24 | 29 | 175 | 16.25 |

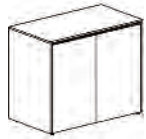

| | | | | | | | | |
|--------------------------------|---------------|------|------|----|----|----|-----|-------|
| 2 Hi Storage Unit Lateral File | 65ST30202901 | 2481 | 2481 | 30 | 20 | 29 | 112 | 11.5 |
| | 65ST30242901 | 2605 | 2605 | 30 | 24 | 29 | 116 | 13.75 |
| | 65ST36202901* | 2800 | 2800 | 36 | 20 | 29 | 116 | 13.75 |
| | 65ST36242901 | 2839 | 2839 | 36 | 24 | 29 | 120 | 16.75 |



| | | | | | | | | |
|-----------------------------|--------------|------|------|----|----|-------|-----|-------|
| 3 Hi Storage, Lateral Files | 65ST36204301 | 3735 | 3920 | 36 | 20 | 42.75 | 175 | 19.75 |
| | 65ST36244301 | 3979 | 4177 | 36 | 24 | 42.75 | 187 | 23.5 |



DIMENSION KEY

W – width
 D – depth
 H – height of worksurface
 KW – kneehole width

Dimensions are in inches and approximate. Contact Customer Service if dimensions are critical.

CODE DESCRIPTION

11 - closed bookcase
 16 - box, lateral file
 01 - lateral file

VENEER

Latitude is available in Quarter Cut Walnut and Rift Cut Oak veneers, and each is priced in this price guide. Maple and Cherry are also available: for Flat Cut Maple or Cherry veneer, use Column 1 pricing; for Quarter Cut Maple or Cherry, use Column 2 pricing. Other veneers are also available on Latitude, please contact us for a quote.

LATITUDE | STORAGE

| Description | Model | Rift | | W | D | H | Shipping Weight | Cubic Feet |
|-----------------------------|--------------|------|--------|----|----|----|-----------------|------------|
| | | Oak | Walnut | | | | | |
| 4 Hi Storage, Lateral Files | 65ST30205601 | 3418 | 3589 | 30 | 20 | 56 | 151 | 21.75 |
| | 65ST36205601 | 3845 | 4037 | 36 | 20 | 56 | 176 | 25.75 |
| | 65ST36245601 | 4088 | 4292 | 36 | 24 | 56 | 196 | 30.75 |



| | | | | | | | | |
|---------------------------------|---------------|------|------|----|----|------|-----|----|
| 5 Hi 19" Storage Closed Shelves | 65ST19247011L | 3321 | 3487 | 19 | 24 | 69.5 | 132 | 20 |
| | 65ST19247011R | 3321 | 3487 | 19 | 24 | 69.5 | 132 | 20 |



| | | | | | | | | |
|--|--------------|------|------|----|----|------|-----|----|
| 5 Hi 19" Storage, 2 File, 3 Open Shelves | 65ST19247090 | 3360 | 3530 | 19 | 24 | 69.5 | 132 | 20 |
|--|--------------|------|------|----|----|------|-----|----|



| | | | | | | | | |
|--|---------------|------|------|----|----|------|-----|-------|
| 5 Hi 19" Storage, 2 File, 3 Closed Shelves | 65ST19247091L | 3604 | 3785 | 19 | 24 | 69.5 | 132 | 21.75 |
| | 65ST19247091R | 3604 | 3785 | 19 | 24 | 69.5 | 132 | 21.75 |



ORDERING PROCEDURE

To order, please specify the following:

- 1) Krug product model number
- 2) Wood species and finish
- 3) Grommet location and style if applicable.

* Indicates model illustrated by line drawing

CODE DESCRIPTION

- L - left hand position
- R - right hand position
- 01 - lateral file

STANDARD FINISHES

For a complete list of standard wood finishes, please see page 518.

PALETTE FINISH

Storage full fronts are available in Palette finish.

Door fronts only at no upcharge. Drawer fronts or combination Drawer/Door fronts at **\$357 list** per unit.

Add a "P" to the end of the model number and include color selection. See Page 518 for standard colors.

| Description | Model | Rift | | W | D | H | Shipping Weight | Cubic Feet |
|--|--------------|------|--------|----|----|------|-----------------|------------|
| | | Oak | Walnut | | | | | |
| 5 Hi Storage, 2 Lateral File, 3 Open Shelves | 65ST36207003 | 4192 | 4401 | 36 | 20 | 69.5 | 180 | 33.5 |
| | 65ST36247003 | 4239 | 4454 | 36 | 24 | 69.5 | 188 | 39.75 |



| | | | | | | | | |
|--|--------------|------|------|----|----|------|-----|-------|
| 5 Hi Storage, 2 Lateral File, 3 Closed Shelves | 65ST30247004 | 4042 | 4245 | 30 | 24 | 69.5 | 240 | 31.25 |
| | 65ST36207004 | 4678 | 4912 | 36 | 20 | 69.5 | 192 | 33.5 |
| | 65ST36247004 | 4733 | 4970 | 36 | 24 | 69.5 | 200 | 39.75 |



| | | | | | | | | |
|--|--------------|------|------|----|----|------|-----|-------|
| 5 Hi Storage, 2 Closed, 3 Open Shelves | 65ST36207013 | 3353 | 3520 | 36 | 20 | 69.5 | 192 | 33.5 |
| | 65ST36247013 | 3390 | 3561 | 36 | 24 | 69.5 | 200 | 39.75 |

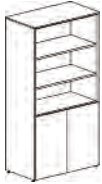

| | | | | | | | | |
|--|--------------|------|------|----|----|------|-----|-------|
| 5 Hi Storage, 3 Lateral file, 2 Closed Shelves | 65ST36247008 | 4817 | 5059 | 36 | 24 | 69.5 | 192 | 39.75 |
|--|--------------|------|------|----|----|------|-----|-------|

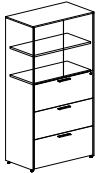

DIMENSION KEY

W – width
 D – depth
 H – height of worksurface
 KW – kneehole width

Dimensions are in inches and approximate. Contact Customer Service if dimensions are critical.

VENEER

Latitude is available in Quarter Cut Walnut and Rift Cut Oak veneers, and each is priced in this price guide. Maple and Cherry are also available: for Flat Cut Maple or Cherry veneer, use Column 1 pricing; for Quarter Cut Maple or Cherry, use Column 2 pricing. Other veneers are also available on Latitude, please contact us for a quote.

LATITUDE | STORAGE

| Description | Model | Rift | | W | D | H | Shipping Weight | Cubic Feet |
|------------------------------|---------------|------|--------|----|----|----|-----------------|------------|
| | | Oak | Walnut | | | | | |
| 6 Hi Storage, Closed Shelves | 65ST19248311L | 3626 | 3809 | 19 | 24 | 83 | 160 | 26 |
| | 65ST19248311R | 3626 | 3809 | 19 | 24 | 83 | 160 | 26 |



| | | | | | | | | |
|--------------------------------------|--------------|------|------|----|----|----|-----|----|
| 6 Hi Storage, 2 File, 4 Open Shelves | 65ST19248390 | 3664 | 3847 | 19 | 24 | 83 | 160 | 26 |
|--------------------------------------|--------------|------|------|----|----|----|-----|----|



| | | | | | | | | |
|--|---------------|------|------|----|----|----|-----|----|
| 6 Hi Storage, 2 File, 4 Closed Shelves | 65ST19248391L | 3920 | 4116 | 19 | 24 | 83 | 160 | 26 |
| | 65ST19248391R | 3920 | 4116 | 19 | 24 | 83 | 160 | 26 |



| | | | | | | | | |
|--|--------------|------|------|----|----|----|-----|------|
| 6 Hi Storage, 2 Lateral File, 4 Open Shelves | 65ST36208303 | 4287 | 4500 | 36 | 20 | 83 | 216 | 40 |
| | 65ST36248303 | 4355 | 4573 | 36 | 24 | 83 | 224 | 47.5 |



ORDERING PROCEDURE

To order, please specify the following:

- 1) Krug product model number
- 2) Wood species and finish
- 3) Grommet location and style if applicable.

* Indicates model illustrated by line drawing

CODE DESCRIPTION

- L - left hand position
- R - right hand position

STANDARD FINISHES

For a complete list of standard wood finishes, please see page 518.

LOCKS

Locks are available for an upcharge of **\$152 list**

PALETTE FINISH

Storage full fronts are available in Palette finish. Door fronts only at no upcharge. Drawer fronts or combination Drawer/Door fronts at **\$357 list** per unit.

Add a "P" to the end of the model number and include color selection. See Page 518 for standard colors.

LATITUDE | STORAGE & WARDROBES

| Description | Model | Rift | | W | D | H | Shipping Weight | Cubic Feet |
|--|--------------|------|--------|----|----|----|-----------------|------------|
| | | Oak | Walnut | | | | | |
| 6 Hi Storage, 2 Lateral File, 4 Closed Shelves | 65ST30248304 | 4268 | 4483 | 30 | 24 | 83 | 279 | 37.5 |
| | 65ST36208304 | 4706 | 4942 | 36 | 20 | 83 | 220 | 40 |
| | 65ST36248304 | 4758 | 4996 | 36 | 24 | 83 | 228 | 47.5 |

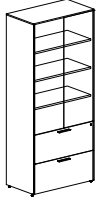

| | | | | | | | | |
|--|--------------|------|------|----|----|----|-----|----|
| 6 Hi Storage, 2 Closed, 4 Open Shelves | 65ST36208313 | 3507 | 3682 | 36 | 20 | 83 | 200 | 40 |
| | 65ST36248313 | 3547 | 3727 | 36 | 24 | 83 | 208 | 40 |



| | | | | | | | | |
|--|--------------|------|------|----|----|----|-----|----|
| 6 Hi Storage, 3 Lateral File, 3 Closed Shelves | 65ST36248308 | 4998 | 5247 | 36 | 20 | 83 | 220 | 40 |
|--|--------------|------|------|----|----|----|-----|----|



| | | | | | | | | |
|---------------|---------------|------|------|----|----|------|-----|----|
| 5 Hi Wardrobe | 65WR19247002L | 2756 | 2893 | 19 | 24 | 69.5 | 172 | 20 |
| | 65WR19247002R | 2756 | 2893 | 19 | 24 | 69.5 | 172 | 20 |



| | | | | | | | | |
|--|---------------|------|------|----|----|------|-----|-------|
| 5 Hi Wardrobe, 2 Files 3 Closed Shelves with Wood Door | 65WR24247014 | 4093 | 4297 | 24 | 24 | 69.5 | 260 | 25.25 |
| | 65WR24247015 | 4093 | 4297 | 24 | 24 | 69.5 | 260 | 25.25 |
| | 65WR30247014 | 4437 | 4659 | 30 | 24 | 69.5 | 266 | 31.25 |
| | 65WR30247015* | 4437 | 4659 | 30 | 24 | 69.5 | 266 | 31.25 |
| | 65WR36247014 | 4580 | 4810 | 36 | 24 | 69.5 | 272 | 39.75 |
| | 65WR36247015 | 4580 | 4810 | 36 | 24 | 69.5 | 272 | 39.75 |

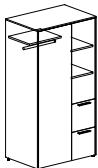

ORDERING NOTES: Center hinged storage units require 2 locks.

DIMENSION KEY

W — width
 D — depth
 H — height of worksurface
 KW— kneehole width

Dimensions are in inches and approximate.
 Contact Customer Service if dimensions are critical.





CODE DESCRIPTION

L - left hand position
 R - right hand position
 14 - left closed shelves, 2 file drawers & right closed wardrobe. Hinged center.
 15 - right closed shelves, 2 file drawers & left closed wardrobe. Hinged center.

VENEER

Latitude is available in Quarter Cut Walnut and Rift Cut Oak veneers, and each is priced in this price guide. Maple and Cherry are also available: for Flat Cut Maple or Cherry veneer, use Column 1 pricing; for Quarter Cut Maple or Cherry, use Column 2 pricing. Other veneers are also available on Latitude, please contact us for a quote.

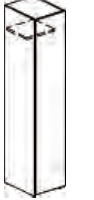
LATITUDE | WARDROBES

| Description | Model | Rift | | W | D | H | Shipping Weight | Cubic Feet |
|---|---|--|--|----------------------------------|----------------------------------|----------------------------------|--|--|
| | | Oak | Walnut | | | | | |
| 5 Hi Wardrobe with Closed Shelves  | 65WR30247001 | 3160 | 3319 | 30 | 24 | 69.5 | 240 | 31.25 |
| | 65WR30247003* | 3160 | 3319 | 30 | 24 | 69.5 | 240 | 31.25 |
| | 65WR36247001 | 3514 | 3688 | 36 | 24 | 69.5 | 164 | 39.75 |
| | 65WR36247003 | 3514 | 3688 | 36 | 24 | 69.5 | 164 | 39.75 |
| 5 Hi Full Width Wardrobe  | 65WR36247002 | 2936 | 3083 | 36 | 24 | 69.5 | 135 | 39.75 |
| 6 Hi Wardrobe  | 65WR19248302L 65WR19248302R | 2921 2921 | 3068 3068 | 19 | 24 | 83 | 172 | 23.75 |
| 6 Hi Wardrobe with Closed Shelves  | 65WR30248301* 65WR30248303 65WR36248301 65WR36248303 | 4407 4407 4677 4677 | 4630 4630 4911 4911 | 30 30 36 36 | 24 24 24 24 | 83 83 83 83 | 286 286 272 272 | 37.5 37.5 44.5 44.5 |
| 6 Hi Wardrobe, 2 Files 4 Closed Shelves with Wood Door  | 65WR24248314 65WR24248315 65WR30248314 65WR30248315* 65WR36248314 65WR36248315 | 4474 4474 4603 4603 4741 4741 | 4697 4697 4834 4834 4979 4979 | 24 24 30 30 36 36 | 24 24 24 24 24 24 | 83 83 83 83 83 83 | 280 280 286 286 292 292 | 35 35 37.5 37.5 44.5 44.5 |

ORDERING NOTES: Center hinged storage units require 2 locks.

ORDERING PROCEDURE

To order, please specify the following:

- 1) Krug product model number
- 2) Wood species and finish
- 3) Grommet location and style if applicable.

* Indicates model illustrated by line drawing

CODE DESCRIPTION

- 01 - left shelves, right wardrobe
- 03 - right shelves, left wardrobe
- 14 - left closed shelves, 2 file drawers & right closed wardrobe. Hinged center.
- 15 - right closed shelves, 2 file drawers & left closed wardrobe. Hinged center.



STANDARD FINISHES

For a complete list of standard wood finishes, please see page 518.

LOCKS

Locks are available on all wood doors at **\$152 list** per lock. 24", 30" & 36" wardrobes require 2 locks.

LATITUDE | MODULAR COMPONENTS - TOPS

| Description | Model | Rift | | W | D | H | Shipping Weight | Cubic Feet |
|---|----------|------|--------|-------|------|------|-----------------|------------|
| | | Oak | Walnut | | | | | |
|  | 650536 | 1482 | 1557 | 36 | 36 | 1.13 | 50 | 5.75 |
| | 650542 | 1728 | 1815 | 42 | 42 | 1.13 | 62 | 7.5 |
| | 650548 | 1886 | 1981 | 48 | 48 | 1.13 | 80 | 9.5 |
| | 650554 | 2051 | 2152 | 54 | 54 | 1.13 | 98 | 11.5 |
| <hr/> | | | | | | | | |
|  | 65TP3624 | 751 | 786 | 35.75 | 24 | 1.13 | 47 | 3 |
| | 65TP3630 | 844 | 887 | 35.75 | 30 | 1.13 | 57 | 3.75 |
| | 65TP3636 | 1014 | 1064 | 35.75 | 36 | 1.13 | 57 | 3.75 |
| | 65TP4224 | 789 | 829 | 41.75 | 24 | 1.13 | 47 | 3 |
| | 65TP4230 | 883 | 928 | 41.75 | 30 | 1.13 | 57 | 3.75 |
| | 65TP4236 | 1061 | 1113 | 41.75 | 36 | 1.13 | 57 | 3.75 |
| | 65TP4824 | 827 | 869 | 47.75 | 24 | 1.13 | 47 | 3 |
| | 65TP4830 | 928 | 974 | 47.75 | 30 | 1.13 | 57 | 3.75 |
| | 65TP4836 | 1114 | 1169 | 47.75 | 36 | 1.13 | 57 | 3.75 |
| | 65TP5424 | 869 | 913 | 53.75 | 24 | 1.13 | 47 | 3 |
| | 65TP5430 | 983 | 1033 | 53.75 | 30 | 1.13 | 57 | 3.75 |
| | 65TP5436 | 1180 | 1240 | 53.75 | 36 | 1.13 | 57 | 3.75 |
| | 65TP6020 | 889 | 933 | 59.75 | 20 | 1.13 | 40 | 3.25 |
| | 65TP6024 | 952 | 997 | 59.75 | 24 | 1.13 | 47 | 3.75 |
| | 65TP6030 | 1038 | 1090 | 59.75 | 30 | 1.13 | 57 | 4.5 |
| | 65TP6036 | 1246 | 1309 | 59.75 | 36 | 1.13 | 57 | 3.75 |
| | 65TP6620 | 1131 | 1187 | 65.75 | 20 | 1.13 | 43 | 3.5 |
| | 65TP6624 | 1169 | 1227 | 65.75 | 24 | 1.13 | 50 | 4 |
| | 65TP6630 | 1210 | 1271 | 65.75 | 30 | 1.13 | 64 | 4.75 |
| | 65TP6636 | 1372 | 1440 | 65.75 | 36 | 1.13 | 77 | 5.5 |
| | 65TP7220 | 1290 | 1356 | 71.75 | 20 | 1.13 | 44 | 3.75 |
| | 65TP7224 | 1335 | 1402 | 71.75 | 24 | 1.13 | 55 | 4.25 |
| | 65TP7230 | 1373 | 1441 | 71.75 | 30 | 1.13 | 65 | 5.25 |
| | 65TP7236 | 1494 | 1568 | 71.75 | 36 | 1.13 | 84 | 6 |
| | 65TP7820 | 1412 | 1482 | 77.75 | 20 | 1.13 | 46 | 4 |
| | 65TP7824 | 1453 | 1527 | 77.75 | 24 | 1.13 | 58 | 4.75 |
| | 65TP7830 | 1497 | 1570 | 77.75 | 30 | 1.13 | 75 | 5.5 |
| | 65TP7836 | 1798 | 1887 | 77.75 | 36 | 1.13 | 91 | 6.5 |
| | 65TP8420 | 1483 | 1558 | 83.75 | 20 | 1.13 | 53.5 | 4.25 |
| | 65TP8424 | 1524 | 1598 | 83.75 | 24 | 1.13 | 62.5 | 5 |
| | 65TP8430 | 1567 | 1645 | 83.75 | 30 | 1.13 | 76 | 6 |
| | 65TP8436 | 1882 | 1976 | 83.75 | 36 | 1.13 | 76 | 5 |
| | 65TP9024 | 1632 | 1714 | 89.75 | 24 | 1.13 | 47 | 3 |
| 65TP9030 | 1683 | 1767 | 89.75 | 30 | 1.13 | 57 | 3.75 | |
| 65TP9036 | 2017 | 2117 | 89.75 | 36 | 1.13 | 57 | 3.75 | |
| 65TP9620 | 1704 | 1790 | 95.75 | 20 | 1.13 | 60 | 5 | |
| 65TP9624 | 1751 | 1839 | 95.75 | 24 | 1.13 | 75 | 5.75 | |
| 65TP9630 | 1803 | 1893 | 95.75 | 30 | 1.13 | 85.5 | 6.75 | |
| 65TP9636 | 2163 | 2269 | 95.75 | 36 | 1.13 | 85.5 | 7 | |

DIMENSION KEY

W — width
D — depth
H — height of worksurface
KW— kneehole width

Dimensions are in inches and approximate.
Contact Customer Service if dimensions are critical.

VENEER

Latitude is available in Quarter Cut Walnut and Rift Cut Oak veneers, and each is priced in this price guide. Maple and Cherry are also available: for Flat Cut Maple or Cherry veneer, use Column 1 pricing; for Quarter Cut Maple or Cherry, use Column 2 pricing. Other veneers are also available on Latitude, please contact us for a quote.

LATITUDE | MODULAR COMPONENTS - TOPS

| Description | Model | Rift | | W | D | H | Shipping Weight | Cubic Feet |
|--|------------|------|--------|-------|----|------|-----------------|------------|
| | | Oak | Walnut | | | | | |
| Modular Return | 65TPR3624L | 751 | 786 | 35.75 | 24 | 1.13 | 43 | 2.75 |
| Tops | 65TPR3624R | 751 | 786 | 35.75 | 24 | 1.13 | 43 | 2.75 |
| | 65TPR3630L | 844 | 887 | 35.75 | 30 | 1.13 | 43 | 2.75 |
|  | 65TPR3630R | 844 | 887 | 35.75 | 30 | 1.13 | 43 | 2.75 |
| | 65TPR3636L | 1014 | 1064 | 35.75 | 36 | 1.13 | 43 | 2.75 |
| | 65TPR3636R | 1014 | 1064 | 35.75 | 36 | 1.13 | 43 | 2.75 |
| | 65TPR4220L | 689 | 723 | 41.75 | 20 | 1.13 | 28 | 1.75 |
| | 65TPR4220R | 689 | 723 | 41.75 | 20 | 1.13 | 28 | 1.75 |
| | 65TPR4224L | 789 | 829 | 41.75 | 24 | 1.13 | 33 | 2.25 |
| | 65TPR4224R | 789 | 829 | 41.75 | 24 | 1.13 | 33 | 2.25 |
| | 65TPR4230L | 883 | 928 | 41.75 | 30 | 1.13 | 43 | 2.75 |
| | 65TPR4230R | 883 | 928 | 41.75 | 30 | 1.13 | 43 | 2.75 |
| | 65TPR4236L | 1061 | 1113 | 41.75 | 36 | 1.13 | 43 | 2.75 |
| | 65TPR4236R | 1061 | 1113 | 41.75 | 36 | 1.13 | 43 | 2.75 |
| | 65TPR4820L | 714 | 749 | 47.75 | 20 | 1.13 | 31 | 2 |
| | 65TPR4820R | 714 | 749 | 47.75 | 20 | 1.13 | 31 | 2 |
| | 65TPR4824L | 827 | 869 | 47.75 | 24 | 1.13 | 36 | 2.5 |
| | 65TPR4824R | 827 | 869 | 47.75 | 24 | 1.13 | 36 | 2.5 |
| | 65TPR4830L | 928 | 974 | 47.75 | 30 | 1.13 | 43 | 2.75 |
| | 65TPR4830R | 928 | 974 | 47.75 | 30 | 1.13 | 43 | 2.75 |
| | 65TPR4836L | 1114 | 1169 | 47.75 | 36 | 1.13 | 43 | 2.75 |
| | 65TPR4836R | 1114 | 1169 | 47.75 | 36 | 1.13 | 43 | 2.75 |
| | 65TPR5424L | 869 | 913 | 53.75 | 24 | 1.13 | 43 | 2.75 |
| | 65TPR5424R | 869 | 913 | 53.75 | 24 | 1.13 | 43 | 2.75 |
| | 65TPR5430L | 983 | 1033 | 53.75 | 30 | 1.13 | 43 | 2.75 |
| | 65TPR5430R | 983 | 1033 | 53.75 | 30 | 1.13 | 43 | 2.75 |
| | 65TPR5436L | 1180 | 1240 | 53.75 | 36 | 1.13 | 43 | 2.75 |
| | 65TPR5436R | 1180 | 1240 | 53.75 | 36 | 1.13 | 43 | 2.75 |
| | 65TPR6024L | 952 | 997 | 59.75 | 24 | 1.13 | 47 | 3 |
| | 65TPR6024R | 952 | 997 | 59.75 | 24 | 1.13 | 47 | 3 |
| | 65TPR6030L | 1038 | 1090 | 59.75 | 30 | 1.13 | 47 | 3 |
| | 65TPR6030R | 1038 | 1090 | 59.75 | 30 | 1.13 | 47 | 3 |
| | 65TPR6036L | 1246 | 1309 | 59.75 | 36 | 1.13 | 47 | 3 |
| | 65TPR6036R | 1246 | 1309 | 59.75 | 36 | 1.13 | 47 | 3 |
| | 65TPR6624L | 1169 | 1227 | 65.75 | 24 | 1.13 | 50 | 3.25 |
| | 65TPR6624R | 1169 | 1227 | 65.75 | 24 | 1.13 | 50 | 3.25 |
| | 65TPR6630L | 1210 | 1271 | 65.75 | 30 | 1.13 | 50 | 3.25 |
| | 65TPR6630R | 1210 | 1271 | 65.75 | 30 | 1.13 | 50 | 3.25 |
| | 65TPR6636L | 1372 | 1440 | 65.75 | 36 | 1.13 | 50 | 3.25 |
| | 65TPR6636R | 1372 | 1440 | 65.75 | 36 | 1.13 | 50 | 3.25 |
| | 65TPR7224L | 1335 | 1402 | 71.75 | 24 | 1.13 | 55 | 3.5 |
| | 65TPR7224R | 1335 | 1402 | 71.75 | 24 | 1.13 | 55 | 3.5 |
| | 65TPR7230L | 1373 | 1441 | 71.75 | 30 | 1.13 | 55 | 3.5 |
| | 65TPR7230R | 1373 | 1441 | 71.75 | 30 | 1.13 | 55 | 3.5 |
| | 65TPR7236L | 1494 | 1568 | 71.75 | 36 | 1.13 | 55 | 3.5 |
| | 65TPR7236R | 1494 | 1568 | 71.75 | 36 | 1.13 | 55 | 3.5 |
| | 65TPR8424L | 1524 | 1598 | 83.75 | 24 | 1.13 | 65.5 | 4.25 |
| | 65TPR8424R | 1524 | 1598 | 83.75 | 24 | 1.13 | 65.5 | 4.25 |
| | 65TPR8430L | 1567 | 1645 | 83.75 | 30 | 1.13 | 65.5 | 4.25 |
| | 65TPR8430R | 1567 | 1645 | 83.75 | 30 | 1.13 | 65.5 | 4.25 |
| | 65TPR8436L | 1882 | 1976 | 83.75 | 36 | 1.13 | 65.5 | 4.25 |
| | 65TPR8436R | 1882 | 1976 | 83.75 | 36 | 1.13 | 65.5 | 4.25 |

ORDERING PROCEDURE

To order, please specify the following:

- 1) Krug product model number
- 2) Wood species and finish
- 3) Grommet location and style if applicable.

* Indicates model illustrated by line drawing







CODE DESCRIPTION

- L - left hand position
- R - right hand position

STANDARD FINISHES

For a complete list of standard wood finishes, please see page 518.

LATITUDE | MODULAR COMPONENTS - SUPPORT

| Description | Model | Rift | | W | D | H | Shipping Weight | Cubic Feet |
|---|--|----------------|--------|-------|-------|------|-----------------|------------|
| | | Oak | Walnut | | | | | |
| Half Gable, Desk Height, used with Modesty Panel  | 65HG0829 | 369 | 388 | 8 | 1.12 | 29 | 4 | 1.5 |
| | 65HG1229 | 408 | 429 | 12 | 1.12 | 29 | 4 | 1.5 |
| | Without modesty panel 65HG1029NMP | 527 | 553 | 10 | 1.12 | 29 | 4 | 1.5 |
| L Support  | 65LB2029L | 703 | 739 | 17 | 20 | 29.5 | 55 | 2 |
| | 65LB2029R | 703 | 739 | 17 | 20 | 29.5 | 55 | 2 |
| | 65LB2429L | 744 | 782 | 17 | 24 | 29.5 | 60 | 3 |
| | 65LB2429R | 744 | 782 | 17 | 24 | 29.5 | 60 | 3 |
| | 65LB3029L | 789 | 829 | 17 | 30 | 29.5 | 70 | 3.5 |
| | 65LB3029R | 789 | 829 | 17 | 30 | 29.5 | 70 | 3.5 |
| | 65LB3629L | 833 | 873 | 17 | 36 | 29.5 | 76 | 4 |
| | 65LB3629R | 833 | 873 | 17 | 36 | 29.5 | 76 | 4 |
| Wood Modesty Panel  | 65MP60X41 | 670 | 703 | 28 | 0.75 | 28.5 | 22 | 1.5 |
| | 65MP66X41 | 708 | 744 | 34 | 0.75 | 28.5 | 26 | 4.5 |
| | 65MP72X41 | 791 | 832 | 40 | 0.75 | 28.5 | 30 | 5 |
| | 65MP78X41 | 910 | 956 | 46 | 0.75 | 28.5 | 30 | 5 |
| | 65MP84X41 | 1185 | 1245 | 52 | 0.75 | 28.5 | 28.5 | 3.25 |
| | 65MP90X41 | 1222 | 1283 | 58 | 0.75 | 28.5 | 29 | 3.75 |
| | 65MP96X41 | 1258 | 1320 | 64 | 0.75 | 28.5 | 32 | 4 |
| | Pedestal with Finished Back  | 65PFB16204D* | 1538 | 1615 | 15.75 | 20 | 28.5 | 59 |
| 65PFB16204F | | 1747 | 1834 | 15.75 | 20 | 28.5 | 61 | 6.5 |
| 65PFB16244D | | 1648 | 1732 | 15.75 | 24 | 28.5 | 70 | 6.5 |
| 65PFB16244F | | 1872 | 1967 | 15.75 | 24 | 28.5 | 72 | 6.5 |
| 65PFB16304D | | 1988 | 2087 | 15.75 | 30 | 28.5 | 78 | 9.5 |
| 65PFB16304F | | 1988 | 2087 | 15.75 | 30 | 28.5 | 83 | 9.5 |
| Pedestal with Finished Back, 2 Lateral File  | | 65PFB30202801* | 2023 | 2122 | 29.75 | 20 | 28 | 187 |
| | 65PFB30242801 | 2070 | 2173 | 29.75 | 24 | 28 | 190 | 13.5 |
| | 65PFB36202801 | 2160 | 2266 | 35.75 | 20 | 28 | 187 | 11.25 |
| | 65PFB36242801 | 2197 | 2308 | 35.75 | 24 | 28 | 190 | 13.5 |
| | Pedestal with Finished Back Closed Bookcase  | 65PFB30202811* | 1780 | 1870 | 29.75 | 20 | 28 | 172 |
| 65PFB30242811 | | 1841 | 1935 | 29.75 | 24 | 28 | 174 | 13.5 |
| 65PFB36202811 | | 1887 | 1984 | 35.75 | 20 | 28 | 172 | 11.25 |
| 65PFB36242811 | | 1901 | 1997 | 35.75 | 24 | 28 | 174 | 13.5 |
| Combination Pedestal with Finished Back  | | 65PFB36202802 | 2377 | 2495 | 29.75 | 20 | 28 | 178 |
| | 65PFB36242802 | 2419 | 2541 | 29.75 | 24 | 28 | 178 | 13.5 |
| | 65PFB36202804* | 2377 | 2495 | 35.75 | 20 | 28 | 162 | 11.25 |
| | 65PFB36242804 | 2419 | 2541 | 35.75 | 24 | 28 | 162 | 13.5 |

ORDERING NOTES: When specifying modular pedestals please state left, center or right. For a pedestal in the left position add L to the end of the model number, for a pedestal in the center position add C to the end of the model number and for a pedestal in the right position add R to the end of the model number. ie. 65PFB36202811L

DIMENSION KEY

W — width
D — depth
H — height of worksurface
KW— kneehole width

Dimensions are in inches and approximate. Contact Customer Service if dimensions are critical.







CODE DESCRIPTION

L - left hand position
R - right hand position
4 - full height pedestal
C - center position
01 - lateral file
11 - closed bookcase
02 - 2 box on right, 1 file drawer left, lateral file
04 - 1 file drawer right, 2 box on left, lateral file

VENEER

Latitude is available in Quarter Cut Walnut and Rift Cut Oak veneers, and each is priced in this price guide. Maple and Cherry are also available: for Flat Cut Maple or Cherry veneer, use Column 1 pricing; for Quarter Cut Maple or Cherry, use Column 2 pricing. Other veneers are also available on Latitude, please contact us for a quote.

LATITUDE | MODULAR COMPONENTS - 3/4 HEIGHT SUPPORT

| Description | Model | Rift | | W | D | H | Shipping Weight | Cubic Feet |
|--|---|---------------|--------|------|------|----|-----------------|------------|
| | | Oak | Walnut | | | | | |
|  L Support 3/4 Height | 65LB2023L | 636 | 667 | 16 | 20 | 23 | 55 | 2 |
| | 65LB2023R | 636 | 667 | 16 | 20 | 23 | 55 | 2 |
| | 65LB2423L | 696 | 731 | 16 | 24 | 23 | 60 | 3 |
| | 65LB2423R | 696 | 731 | 16 | 24 | 23 | 60 | 3 |
| | 65LB3023L | 603 | 634 | 16 | 30 | 23 | 70 | 3.5 |
| | 65LB3023R | 603 | 634 | 16 | 30 | 23 | 70 | 3.5 |
| | 65LB3623L | 640 | 670 | 16 | 36 | 23 | 76 | 4 |
| | 65LB3623R | 640 | 670 | 16 | 36 | 23 | 76 | 4 |
|  Wood Modesty Panel 3/4 Height | 65MP60 | 656 | 689 | 60 | 1.16 | 23 | 22 | 1.5 |
| | 65MP66 | 695 | 730 | 66 | 1.16 | 23 | 26 | 4.5 |
| | 65MP72 | 778 | 815 | 72 | 1.16 | 23 | 30 | 5 |
| | 65MP78 | 892 | 935 | 78 | 1.16 | 23 | 30 | 5 |
| | 65MP84 | 1163 | 1221 | 84 | 1.16 | 23 | 28.5 | 3.25 |
| | 65MP90 | 1197 | 1256 | 90 | 1.16 | 23 | 29 | 3.75 |
| | 65MP96 | 1232 | 1295 | 96 | 1.16 | 23 | 32 | 4 |
| |  3/4 Height Pedestals Finished Back Box/ Lateral File | 65PFB24242316 | 2657 | 2789 | 24 | 24 | 23 | 148 |
| 65PFB30202316 | | 2740 | 2877 | 30 | 20 | 23 | 154 | 9.25 |
| 65PFB30242316 | | 2829 | 2970 | 30 | 24 | 23 | 185 | 11 |
| 65PFB36202316 | | 2844 | 2985 | 36 | 20 | 23 | 185 | 11 |
| 65PFB36242316 | | 2934 | 3080 | 36 | 24 | 23 | 222 | 13 |
|  3/4 Height Pedestals Finished Back Open/ Lateral File | 65PFB24202315 | 2577 | 2705 | 24 | 20 | 23 | 136 | 7 |
| | 65PFB24242315 | 2657 | 2789 | 24 | 24 | 23 | 142 | 9 |
| | 65PFB30202315 | 2740 | 2877 | 30 | 20 | 23 | 148 | 9.25 |
| | 65PFB30242315 | 2829 | 2970 | 30 | 24 | 23 | 179 | 11 |
| | 65PFB36202315 | 2844 | 2985 | 36 | 20 | 23 | 179 | 11 |
| | 65PFB36242315 | 2934 | 3080 | 36 | 24 | 23 | 216 | 13 |
|  3/4 Height Pedestals Finished Back Bookcase | 65PFB24202311 | 1558 | 1638 | 24 | 20 | 23 | 142 | 7 |
| | 65PFB24242311 | 1603 | 1683 | 24 | 24 | 23 | 146 | 9 |
| | 65PFB30202311 | 1673 | 1758 | 30 | 20 | 23 | 152 | 9.25 |
| | 65PFB30242311 | 1691 | 1776 | 30 | 24 | 23 | 183 | 11 |
| | 65PFB36202311 | 1728 | 1815 | 36 | 20 | 23 | 183 | 11 |
| | 65PFB36242311 | 1780 | 1870 | 36 | 24 | 23 | 219 | 13 |
|  3/4 Height Pedestals Finished Back Open/ Bookcase | 65PFB24202318 | 1558 | 1638 | 24 | 20 | 23 | 133 | 7 |
| | 65PFB24242318 | 1603 | 1683 | 24 | 24 | 23 | 139 | 9 |
| | 65PFB30202318 | 1673 | 1758 | 30 | 20 | 23 | 145 | 9.25 |
| | 65PFB30242318 | 1691 | 1776 | 30 | 24 | 23 | 176 | 11 |
| | 65PFB36202318 | 1728 | 1815 | 36 | 20 | 23 | 176 | 11 |
| | 65PFB36242318 | 1780 | 1870 | 36 | 24 | 23 | 213 | 13 |

ORDERING NOTES: When specifying modular pedestals please state left, center or right. For a pedestal in the left position add L to the end of the model number, for a pedestal in the center position add C to the end of the model number and for a pedestal in the right position add R to the end of the model number. ie. 65PFB36202811L

ORDERING PROCEDURE

To order, please specify the following:

- 1) Krug product model number
- 2) Wood species and finish
- 3) Grommet location and style if applicable.

* Indicates model illustrated by line drawing

CODE DESCRIPTION

- L - left hand position
- R - right hand position
- C - center position
- 16 - box, lateral file
- 15 - top open, lateral file
- 11 - closed bookcase
- 18 - top open, closed bookcase

STANDARD FINISHES

For a complete list of standard wood finishes, please see page 518.

PALETTE FINISH

Storage unit door fronts are available in Palette finish at no upcharge. Drawer fronts are also available in Palette at an upcharge of **\$357 list** per unit, add P at the end of the model number. See page 518 for color selection.

LATITUDE | MODULAR COMPONENTS - BASES

| Description | Model | Rift | | W | D | H | Shipping Weight | Cubic Feet |
|--|---------------|------|--------|----|----|----|-----------------|------------|
| | | Oak | Walnut | | | | | |
| 3/4 Height Pedestals w/ Finished Back Open Bookcase  | 65PFB24202317 | 1495 | 1569 | 24 | 20 | 23 | 128 | 7 |
| | 65PFB24242317 | 1538 | 1615 | 24 | 24 | 23 | 130 | 9 |
| | 65PFB30202317 | 1609 | 1688 | 30 | 20 | 23 | 136 | 9.25 |
| | 65PFB30242317 | 1623 | 1705 | 30 | 24 | 23 | 167 | 11 |
| | 65PFB36202317 | 1660 | 1743 | 36 | 20 | 23 | 167 | 11 |
| | 65PFB36242317 | 1709 | 1795 | 36 | 24 | 23 | 204 | 13 |

ORDERING NOTES: When specifying modular pedestals please state left, center or right. For a pedestal in the left position add L to the end of the model number, for a pedestal in the center position add C to the end of the model number and for a pedestal in the right position add R to the end of the model number. ie. 65PFB36202811L

| | | | | | | | | |
|---|-----------|----------|-----|------|---|----|------|------|
|  | Disc Base | 65141828 | 313 | 18D | - | 28 | 25 | 7.5 |
| | | 65142428 | 334 | \$&D | - | 28 | 11.5 | 11.5 |
| | | 65142828 | 483 | \$*D | - | 28 | 40 | 14.5 |
| | | | | | | | | |

| | | | | | | | | |
|---|-------------------|----------|-----|----|----|----|----|------|
|  | Square Plate Base | 65SQ1828 | 362 | 18 | 18 | 28 | 25 | 7.5 |
| | | 65SQ2428 | 424 | 24 | 24 | 28 | 35 | 11.5 |

| | | | | | | | | | |
|---|-----------|-------------|------|------|-----|-----|------|-----|----|
|  | Drum Base | 65101829 | 805 | 844 | 18 | 18 | 28.5 | 97 | 7 |
| | | 65101829WMD | 1146 | 1203 | #* | #* | 28.5 | 97 | 7 |
| | | 65102429 | 1245 | 1307 | \$& | \$& | 28.5 | #&" | 12 |
| | | 65102429WMD | 1922 | 2018 | 24 | 24 | 28.5 | #&" | 12 |

| | | | | | | | | | |
|---|-----------------|-------------|------|------|-------|-------|----|-----|---|
|  | Mobile Pedestal | 65MP161927F | 1433 | 1505 | 15.75 | 19.75 | 28 | 61 | 7 |
| | | 65MP161927D | 1487 | 1562 | 15.75 | 19.75 | 28 | 61 | 7 |
| | | 65MP162827F | 1717 | 1803 | 15.75 | 28.5 | 28 |) (| 8 |
| | | 65MP162827D | 1797 | 1886 | 15.75 | 28.5 | 28 |) (| * |

DIMENSION KEY

W — width
D — depth
H — height of worksurface
KW — kneehole width

Dimensions are in inches and approximate.
Contact Customer Service if dimensions are critical.

STANDARD FINISHES

For a complete list of standard wood finishes, please see page 518.

GROMMETS

One grommet in a standard position is optional at no charge. See page 518 for more information.

GENERAL INFORMATION

Terms and Conditions

Net 30 days on approved credit. A late payment charge of 1% per month will be applied on overdue invoices. This charge will be pro-rated to the number of days past 30 days that the invoice is overdue. All applicable sales taxes are extra. Distribution of this price list does not in itself constitute an offer to sell. Orders can be received only from authorized Krug dealers. Acceptance of any order and terms of sale may be established at the discretion of Krug. Deposits are required on orders received from new accounts as well as on large or special orders. Krug reserves the right to discontinue designs, or to change designs, construction, prices, or materials without notice.

Contact Information

Phone: 1.888.578.KRUG (5784) | Fax: 1.519.748.5177

Purchase Order Fax: 1.888.236.4783

Purchase Order E-mail: orders@krug.ca

Web: www.krug.ca E-mail: solutions@krug.ca

Customer Service Hours

Please note customer service hours are:

8:30 am to 5:00 pm est

Customer Satisfaction

It is the primary goal of Krug and our staff to ensure the complete satisfaction of our customers with our products and performance. If a problem arises with a Krug product after the expiration of the limited warranty period, Krug will exercise its best efforts to achieve the satisfaction of the customer in a manner that is fair to all concerned.

Order Acknowledgments

Each order will be acknowledged via e-mail or fax. This acknowledgment is the final agreement between Krug and the customer, superseding all previous communications regarding the purchase order. Where there is a discrepancy on a purchase order between a product code and a description, Krug will make every effort to resolve the discrepancy, but will be ruled by the product code ordered. Please check all acknowledgments for accuracy, and advise Krug of any discrepancies with a purchase order.

Order Cancellation

Krug reserves the right to not accept or allow cancellation of orders. All products are manufactured on a custom-made, make-to-order basis, and the purchasing, engineering and production of orders begins shortly after order placement - and the customer purchase order is a contract that authorizes Krug to manufacture the products. Acceptance of order cancellation (or partial cancellation) is solely at the discretion of Krug, and is dependent on the extent to which engineering, purchasing and manufacturing has been initiated by the time cancellation is requested. No order cancellations (partial or otherwise) are allowable more than 4 weeks from date of order placement (as order production is unable to be terminated by that point), and full payment of the acknowledged order value is required for any orders cancelled after 4 weeks. Cancellations may be allowable in less than 4 weeks after order placement, depending on the extent to which manufacturing has been initiated. An acceptance of order cancellation requires that the purchaser agrees to make payment for all costs incurred to the point of acceptance of cancellation. Cancellation charges include all costs for purchase of dedicated material and components, engineering costs for non-standard products, and all costs for manufacturing completed to that point, as well as a \$350 net charge for processing of the original order and for processing of cancellation invoicing.

Pricing

Krug endeavors to ensure that all prices in this price list reflect accurately our current prices. However, errors do occur and will be rectified through notices to the field. Krug reserves the right to acknowledge pricing that may be different from the price list.

Warranty

Krug warrants the construction and the finish of all our products to be free from defects in materials and workmanship for a period of 10 years from the date of purchase. This warranty is applicable to products in use by their original purchaser. This warranty does not apply to components not manufactured by Krug including textiles, which are subject to the specific warranties of those manufacturers,

if any. Textiles (fabric, leather, vinyl, or any other covering material) suppliers do not guarantee their products for durability and color fastness, and nor does Krug. Casters, mechanical and electrical components have a warranty of five years from the date of purchase. The Krug warranty does not apply to COM-specified materials, damage caused by a carrier other than Krug, or variation in wood finishes due to natural wood color variation. Krug cannot be held responsible for variations in fabric dye lots from order to order. All fabric is carefully inspected when it is received, but a degree of variation in color should be expected. Repairs or replacement of any defect covered under this warranty by Krug will be made, at our option and method, at no charge to the original purchaser during the warranty period. Krug's judgement is final and binding with respect to the nature or cause of defects or damage, and the necessity or manner of repair or replacement.

This warranty does not apply to defects or damage resulting from:

- normal wear and tear occurring with the use of the product
- negligence, misuse, excessive use, alteration, improper cleaning or repair
- substitution or use of incorrect or unauthorized components or material
- handling or installation that is incorrect, or that causes damage or defect
- damage incurred by a freight carrier other than Krug
- wearing of finishes and fabrics, and normal variations in material (including dye lot variations)
- properties of natural materials, including wood and leather
- exposure to environments with uncontrolled temperature and humidity (products must be transported, stored and used in climate-controlled conditions)

Note, specific warranties for components and materials not manufactured by Krug:

Height Adjustable Mechanism Warranty

Krug warrants to the original consumer purchaser its Height Adjustable Mechanism that it will be free from defects in material and workmanship. This limited warranty covers material and manufacturing defects, which cause a non-conformance in the function of a table base and is limited to the following products and warranty term determined from their dates of purchase:

- a) Electronic components such as control boxes, hand switches and motors – two (2) years
- b) Mechanical components such as crank drives, spindles – five (5) years
- c) Structural components such as J-channels, feet and top supports – ten (10) years

The start of the warranty period is the documented date of your purchase of the product. The warranty herein is made to and for the benefit of the original consumer purchaser of the product and is non-transferable. If you discover a defect in material or workmanship during the warranty period, and Krug agrees that the defect exists, Krug will, at its option, repair or replace the Product at no charge to you, provided it is returned during the warranty period. In the unlikely event that your product should require repair or replacement during the warranty period, please contact Krug to obtain warranty service. The warranty period on replacement products is the remainder of the warranty on the original product or 30 days, whichever is longer.

Testing

All Krug Conference products meet or exceed the testing requirements of ANSI/BIFMA X5.5-2014 or X5.9-2012.



Dimensions

Dimensions are in inches and approximate, and subject to change without notice. Contact Customer Service if dimensions are critical.

Installation Support

For assistance please contact Technical Support at 1-888-578-5784 x216 or e-mail installationhelp@krug.ca and you will be directed to the appropriate installation support person.

Storage Charges

Krug reserves the right to assess a nominal storage charge if a customer does not accept shipment of an order within a week of the ship date.

Export Packaging

Krug is pleased to provide the option for export packaging on all our products, to provide additional protection from damage. For shipments overseas, a quote for export packaging can be provided, based on the products to be ordered and the delivery destination - please contact Customer Service or Bids & Specification Support for more information and a quotation. KRUG is not responsible for shipment damage occurring on overseas shipments

Export Packaging is **STRONGLY RECOMMENDED** for:

- (A) all shipments outside of the lower 48 states and Canada
 - (B) all shipments that will be held in storage for an extended period prior to installation. Important: Please note that Krug will not be responsible for damage claims on product shipped or stored in the above conditions where export packaging has not been utilized.
- Please contact Customer Service for specifications or any other assistance regarding export packaging.

Freight Terms and Conditions

1. All product is shipped FOB the Krug factory. Freight is either pre-paid to the destination or not pre-paid, depending on established customer specific freight terms.
2. Docks at the selected delivery location must be equipped to handle a 53' trailer. If a dock is inadequate for delivery by Krug, Krug will re-deliver to another local location and any additional costs will be charged to the customer.
3. For all deliveries, it is understood that Krug or its agent is making a dock delivery only (equipped to handle a 53' trailer), and any further work of truck unloading, delivery beyond the dock, installation, and removal of packaging is not authorized or paid for by Krug.
4. Drop shipments to the installation site, and timed deliveries, are available on larger shipments (full truckloads or slightly less) at no additional charge. Drop shipments or timed deliveries for smaller shipments may not be available, or if available will require a surcharge. Deliveries on an after hours basis, or on weekends, or any other special requirements, may be subject to a surcharge. Location and contact information, and the requested time of delivery, is required at least one week prior to the acknowledged shipment date. If this information is not provided one week in advance, or if the location or time of the drop shipment is changed less than one week in advance, a surcharge may be applied, and/or the drop shipment may not be scheduled.
5. For all deliveries - whether to the Customer location or drop shipment - any circumstances that result in the delay of our carrier (including unsuitable receiving facilities, or facilities not open or available), service charges will be applied at the rate of \$75/hour. Where re-delivery is necessary because of these circumstances, the full cost of re-delivery will be charged. If Less Than Truck Load is delivering, one hour is allocated to unload. Any additional time required to unload after the first hour is \$75/hour. If a Truck Load is delivering the order, three hours is allocated to unload. Any additional time required to unload is \$75/hour. Direct deliveries to site for net orders are possible, must exceed \$60,000 net, and accommodate 48-53' trailers. Krug is responsible for delivery to the approved delivery address. If an address change is required, this must be authorized by Krug 5 business days prior to ship date. Any additional delivery costs incurred after this time will be charged to the customer. Additional costs for partial shipment of orders are the responsibility of the customer, and will be added to invoices. This includes any part shipment costs due to delays from textile suppliers. Additional costs for partial order shipments will normally not be assessed if there is a delay caused by Krug.

Damaged Shipments

All Krug product is well engineered, carefully inspected, and expertly loaded onto our trucks at our Distribution Center. If you receive any damaged freight, we ask that you do not refuse the shipment. Krug is not responsible for damage to goods that occurs in transit or storage. It is the purchaser and/or receiver's responsibility to examine the goods upon receipt and to notify Krug of any damages, overages or shortages. Any discrepancies should be noted on the Bill of Lading. The delivering carrier will not accept responsibility for shortages or damages if signed "clear". Notification of concealed damage claims must be made to Krug Distribution within 5 days of delivery, along with digital pictures if available. All product and

packaging must be available for inspection. Krug liability ceases after 5 business days and Krug will not be responsible for concealed damages if shipments are left unopened. Krug is not responsible for the condition of product that is stored or installed in an environment where temperature and humidity are not controlled.

Field Product Report Authorization

Krug's written authorization, in the form of an FPR number, must be obtained prior to incurring charges of any kind if Krug is expected to pay these charges. This includes authorization for returns, field repairs and replacements, post field repairs, installation and delivery charges. Krug reserves the right to have its representative inspect product related to any request for such authorizations, prior to that authorization being provided. Deductions from invoices paid for any charges to Krug, without prior written authorization in the form of an FPR, will not be accepted. Digital photographs may be required to complete the FPR process.

Care and Maintenance

Wood Finishes - Although Krug's extensive finishing process ensures a durable finish on all our products, there are several steps that can be taken to protect and prolong the life and beauty of the finish. Protect the top by placing felt pads on the bottom of any accessories and mechanical equipment. Rubber and oil will permanently mark surfaces. Use a desk pad to prevent possible damage and imprinting caused by writing instruments and sharp objects. Dust only with a clean, dry cloth, going with the grain. Clean any marks with a damp cloth, using a small quantity of mild soap or detergent. Do not use any wax-based polish, spray or silicone. Eventually, a film will build up and discolor the top. Do not place your furniture in a position of permanent exposure to direct sunlight.

Plastic Laminates - Clean plastic laminates with mild soap and warm water. Do not use steel wool, hot water, or any abrasive cleaning product.

Custom Capabilities

Over 15% of our orders involve some type of custom work, and we invite our customers to make use of our extensive capabilities. These include:

- 1) Dimensional customization of standard size products
 - 2) Custom wood finishes
 - 3) For larger orders, completely custom-designed products, as well as non-standard wood species can be specified.
- Custom orders may require additional production lead times. Contact Customer Service for more information.

Krug Panel Fabric Program

Tackboards can be upholstered in COM material supplied by the customer, and in a selection of stocked tackboard fabrics supplied by Momentum. The Momentum Panel fabrics are available on Krug Express. They are 100% polyester. For additional information and color selections, please refer to our Panel Fabrics card and Krug's website. www.krug.ca The Momentum panel fabrics pass ASTM-E84-87 Fire Codes. If memo samples are required please call Momentum at 1-800-366-6839.

Program Details

KrugExpress orders are ready to ship by the date acknowledged. Delivery and shipping schedules may result in actual shipping of orders at a later date. Statutory holidays and scheduled factory vacations may add to acknowledged lead times of *KrugExpress* orders. Unless otherwise specified on the order, the customer's standard method of shipping Krug products will be utilized. Available factory capacity for *KrugExpress* is filled by orders received on a "first come, first serve" basis. If the normal *KrugExpress* lead time is not available for your order because available capacity has been filled, you will be immediately advised of the earliest available ready-to-ship date. Please consult your Customer Service representative in advance if you wish to confirm the specific lead time availability for a *KrugExpress* order. Orders must be received by midnight of a given day for that day to be considered the official day the order is received. Order lead times are acknowledged from the date the order is received, but not including the date the order is received. *KrugExpress* orders must be "clean" when received in order to be considered officially received on a given day, and lead times will be acknowledged from the date orders are determined to be "clean". Changes to *KrugExpress* orders are not allowed under any circumstances. Orders for product on *KrugExpress* must clearly state: "*KrugExpress*".



Krug Textiles - Leather Program

Grade 8

| | | | |
|-------|----------|----------|----------|
| Black | K13.1000 | Graphite | K13.4000 |
| Stone | K13.3000 | Espresso | K13.8000 |
| Sand | K13.5000 | White | K13.9000 |

Please contact Customer Service for specific information on leathers, available colors and lead times.

Krug Textiles - Faux Leather Program

Grade 2

| | | | | | |
|-----------|----------|-----------|--------|------------|--------------|
| White | Taupe | Bisque | Wine | Sprig | Lagoon |
| Cream | Mocha | Chocolate | Garnet | Chinchilla | Pacific Blue |
| Parchment | Tan | Black | Rust | Steel | Navy |
| Sandstone | Chestnut | Earth | Citron | Grey | Plum |
| Vanilla | | Brick | | | |

GRADED-IN UPHOLSTERY PROGRAMS

Krug has partnered with several textile brands to grade in their offerings, designed to provide a wide range of upholstery selections for our seating products.

Upholstery pricing and availability is subject to change without notice. We grade this upholstery according to the pricing of the fabric suppliers - when their pricing changes, the Krug grade may change. When placing an order, a Krug customer must specify the complete upholstery number, along with the appropriate Krug model number and finish. Krug will supply the complete product at the prices listed. Orders specifying graded-in upholstery cannot be cancelled once the upholstery has been ordered.

Upholstery Grades

To determine the price of a product for graded-in upholstery, use the reference lists located on Krug’s website under - Products - Textiles, to view the upholstery grade (1-9). Krug is not responsible for the discontinuation of this upholstery. Please contact Customer Service for information on upholstery not listed.

When two upholstery selections are specified for use on seating, the higher grade upholstery price will apply to the order.

High Performance upholstery; Polyurethane, Vinyl or Crypton, is particularly suitable for healthcare and other intensive-use environments.

Upholstery Samples

If you require additional samples or memos for presentation, please contact fabric supplier directly.

Flammability Standards

- Tunnel Test Surface Ratings Class A rating
- Class 1 UFAC
- Passes State of California Technical Bulletin CAL 117-2013

Please contact fabric supplier directly for further flammability information pertaining to specific upholstery.

Special Conditions

Acknowledgements will give the estimated delivery date of the finished product. Some upholstery is imported, and availability may affect estimated delivery time. For large projects, please contact fabric supplier directly for availability of yardage.

TACKBOARD FABRICS

KRUG PANEL FABRIC PROGRAM

Tackboards can be upholstered in COM material supplied by the customer, and in a selection of stocked tackboard fabrics supplied by Momentum. The in-stock Momentum fabrics are priced at Grade 1 and are available on Krug Express. They are 100% polyester. For additional information and color selections, please refer to our Panel Fabrics card and Krug’s website. www.krug.ca If memo samples are required please call Momentum at 1-800-366-6839. The Momentum panel fabrics pass ASTM-E84-87 Fire Codes.

PROGRAM DETAILS

KrugExpress orders are ready to ship by the date acknowledged. Delivery and shipping schedules may result in actual shipping of orders at a later date. Statutory holidays and scheduled factory vacations may add to acknowledged lead times of KrugExpress orders. Unless otherwise specified on the order, the customer’s standard method of shipping Krug products will be utilized. Available factory capacity for KrugExpress is filled by orders received on a “first come, first serve” basis. If the normal KrugExpress lead time is not available for your order because available capacity has been filled, you will be immediately advised of the earliest available ready-to-ship date. Please consult your Customer Service representative in advance if you wish to confirm the specific lead time availability for a KrugExpress order. Orders must be received by midnight of a given day for that day to be considered the official day the order is received. Order lead times are acknowledged from the date the order is received, but not including the date the order is received. KrugExpress orders must be “clean” when received in order to be considered officially received on a given day, and lead times will be acknowledged from the date orders are determined to be “clean”. Changes to KrugExpress orders are not allowed under any

KRUGEXPRESS

circumstances. Orders for product on KrugExpress must clearly state: “KrugExpress”. *Some conditions apply. Please note PALETTE finishes are not available on KrugExpress.

CASEGOODS PROGRAM

Orders for casegood products on the KrugExpress program may be subject to quantity maximums. Please contact Krug Customer Service for more information. Quantity maximums are dependent upon available capacity, in order to insure that we ship all orders on time. Only actual casegood pieces and conference tables tops and bases are considered “units”. Items such as tasklights, tackboards, keyboard trays and drawers, electrical and wire management components, etc., are not considered under the quantity restrictions. For example, a typical office configuration that includes a desk, linking unit, credenza and hutch/overhead, equals a total of four units for the purposes of the quantity maximum. Only Krug In-stock panel fabric is available on the KrugExpress program. Only standard wood finishes are available for KrugExpress orders. Grommets can be specified in standard positions only. KrugExpress also includes all Krug seating and occasional tables as well as Krug conference products to complement this casegoods offering.

CUSTOMER'S OWN MATERIAL - C.O.M.

Customer's Own Material (COM)

COM must be received three weeks prior to the acknowledged ship date. Orders with COM not received by the required deadline will be delayed.

A description of the fabric, including supplier name, fabric name and color number must be included with the purchase order. When the COM fabric is received at Krug, it must be clearly identified with the fabric name and color, and tagged with name of the Krug customer and purchase order number. Krug will inspect all COM fabric when received to determine if it will be suitable for upholstery. Where Krug feels that the fabric or leather specified will compromise the quality or integrity of our products, customers will be contacted to direct these concerns. Further, Krug reserves the right to refuse to accept and use any COM fabrics or leathers that will compromise our products in any way that is unacceptable to Krug. Krug cannot assume responsibility for the durability or tailoring quality of customer's own material.

Yardage specified in this price guide is approximate. In the case of multiple product orders, multiply the number of items by the COM yardage specified to determine fabric required, unless otherwise indicated. Additional yardage may be needed if the material is less than 54" wide, or patterned or striped and requires matching. As fabric is applied horizontally, non-directional fabrics are recommended. COM fabrics are applied as they come off the roll unless otherwise specified. All striped fabrics will be applied vertically unless otherwise stated by the customer and after approval by Krug. It is the customer's responsibility to advise Krug if the upholstery is to be applied otherwise, and to advise Krug of any special upholstery instructions. Special instructions should be sent to Krug Customer Service, including a sample (or photocopy) of the fabric. Krug is not responsible for instructions sent with the fabric rolls, or for the method of upholstery if no instructions have been provided. COM fabrics for tackboards may be specified in either Maharam or Momentum panel fabrics. Krug is not responsible for determining if a fabric is not ideal for tackboard application.

Please contact Maharam at 1-800-645-3943 or Momentum at

COM Shipping Procedures

For tackboard COM fabrics, please send fabrics to:

Krug Inc.

111 Ahrens Street

Kitchener, Ontario

Canada N2H 4C2

Attention: RECEIVER

All packages must be clearly marked "For Customs Clearance by Willson International Custom Brokers". According to the North American Free Trade Agreement (NAFTA), goods shipped between the United States and Canada can qualify for exemption from all duties, or for a reduction in duties, if the goods can be proven to originate in either the United States, Canada or Mexico.

Canada Customs requires that a NAFTA Certificate of Origin and Commercial Invoice be completed and sent with the fabric shipment. The Commercial Invoice must clearly state the description of the fabric, the selling price, the make-up or content, and the purchaser. The absence of these two documents will delay the shipments at the U.S./Canada border, thereby potentially delaying the customer order. If the total value of the shipment is less than \$1200 U.S., Customs will accept a Low Value Statement of Origin in place of the NAFTA Certificate of Origin. The Low Value Statement must be signed by a representative of the exporting company. This statement may either be included on the commercial invoice or attached to the invoice.

Krug is happy to answer any questions or concerns about COM shipping procedures and the required documents. Please contact our Customs Specialist at 1.888.578.5784.

LAMINATES

LAMINATES

Krug's in-stock Laminates are available in 17 different laminate selections. Please note that 4 of the colors (Gingerbread, Portobello, Ash and Willow) have textured finishes and may not be appropriate for use in patient areas due to infection control concerns. Minimum order quantities and extended lead times may apply for exotic laminate colors, please check with customer service. Polymer Edge will be selected to match the worksurface. Krug's previous laminate in-stock program will be phased out as in-stock supply depletes. Please contact customer service for availability.

IN-STOCK LAMINATES

| Wood Grain Laminates | High Pressure Laminate Supplier | Textured Wood Grain Laminates | High Pressure Laminate Supplier |
|----------------------|---------------------------------|-------------------------------|---------------------------------|
| Champagne | Tafisa T492CR | Gingerbread | Tafisa T556UR |
| Hardrock Maple | Formica 86992-58 | Portobello | Tafisa T557UR |
| Dune | Tafisa T491CR | Ash | Tafisa T535AT |
| Copper | Tafisa T521CR | Willow | Tafisa T543AT |
| Shiraz Cherry | Tafisa T472CR | Solid Laminates | |
| Park Avenue Walnut | Wilsonart 7984-38 | Designer White | Wilsonart D354-60 |
| Chocolate | Tafisa T498CR | Platinum | Tafisa T202CR |
| Nutmeg | Tafisa T477CR | Earth | Tafisa T767CR |
| Dark Walnut | Tafisa T469CR | Charcoal | Tafisa T228CR |

PHASE OUT LAMINATES

Almond - Black- Shadows - Edgewood Sycamore - Gunstock Walnut

Non-Stocked Laminates

For specific lead time and application questions, please contact Krug Customer Service for your requirement. Upcharges will be applicable for non-stocked laminates, depending on their cost. Non-stock laminates may require a minimum order quantity, please contact customer service. Stocked polymer edges only can be specified for use with non-stocked laminates or tops will be self-edged.



The mark of responsible forestry

All products are air emissions certified and are available as FSC® certified

krug