

MILLENNIUM
Price and Specification Guide
CANADA



Effective, January 1, 2025

krug

Advancing Design Through Innovation

MILLENNIUM | TABLE OF CONTENTS

245	Environmental Summary
246	Finishes
247	Custom Sizing & Pricing Methods
248	General Product Specification
249	Edge Detail Profile
249	Drawer Pulls & Locks
250	Grommets, PowerPorts & Wire Mgmt
251	Laminate Worksurfaces Desks Overheads Hutches
252	Filing Instructions & Installation
253	Height Adjustable Worksurface with Base Enclosure
254	Sample Configuration
255	Product Enhancements
257	Desks
267	Height Adjustable Worksurfaces
275	Returns
280	Linking & Corner Units
282	Credenzas
290	Overheads
291	Hutches
297	Shells
300	Mobile Tables
301	Accessories
303	PowerPorts
306	Bookcases
309	Storage
314	Wardrobes
315	Modular Tops
317	Pedestals
319	Reception

MILLENNIUM CASEGOODS | ENVIRONMENTAL SUMMARY

LEED CERTIFICATION



MATERIAL CONTENT:

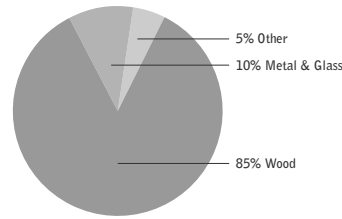

PRE-CONSUMER RECYCLED CONTENT - 81%

POST-CONSUMER RECYCLED CONTENT - 3%

		CONTRIBUTES TO
Credit 2.1 - 2.2	Construction Waste Management	1-2 point(s)
Credit 3.3	Resource Reuse	1 point
Credit 4.1	Recycled Content	1 point
Credit 4.2	Recycled Content	1 point
Credit 4.5	Low Emitting Materials, (MUST BE REQUESTED) Composite Wood & Laminate Adhesives	1 point
Credit 5.1	Regional Materials*	1 point
Credit 6	Rapidly Renewable Materials (MUST BE REQUESTED)	1 point
Credit 7	Certified Wood (MUST BE REQUESTED)	1 point

*This credit is only applicable if in total 20% of the combined value of the procurement of construction materials and in the furniture are manufactured within a radius of 500 miles. This credit will apply if the installation of the finished product occurs within 500 miles of Kitchener, Ontario.

level® CERTIFICATION



BIFMA's e3 Furniture Sustainability Standard is a voluntary, multi-attribute standard that measures the degree of sustainability of furniture. This standard evaluates product and company environmental attributes and compliance systems in a wide range of elements which include Materials, Energy & Atmosphere, Human & Ecosystem Health and Social Responsibility. Millennium products have earned level®, BIFMA's sustainability certification program for furniture, certification through third-party verification against the e3 standard. All Millennium products can be supplied with level® certification. In order to accomplish this, the product must also be ordered with the air-emissions-certification option. Contact customer service for information and upcharges.

AIR-EMISSIONS

All Millennium products can be supplied with air-emissions-certified materials. Contact customer service for information and upcharges.



the mark of responsible forest

FSC®

In 2005, Krug received Forest Stewardship Council® (FSC®) Chain-of-Custody certification for our manufacturing facilities. The FSC® Chain-of-Custody tracks certified wood from seedling to final sale. It signifies that the growth, harvesting and production of goods are entirely achieved through responsible forestry, which guarantees a healthy supply of forest resources for generations to come. Millennium and other Krug products can be specified with one of two types of FSC® Certification:

- (a) FSC®-certified (which includes FSC®-certified lumber, veneer and substrate material)
- (b) FSC®-mix certified (which includes substrate material only, and is a lower cost option certification)

Contact customer service for further information, pricing and lead times.



In addition, architects, designers, and building professionals can specify FSC®-certified products in order to achieve a point from the U.S. Green Building Council's Leadership in Energy and Environmental Design (LEED) Rating System.

WOOD FINISHES

Standard wood finishes are:

SPECIES FINISH

Cherry	Light Cherry Natural Cherry American Cherry Medium Cherry Standard Cherry Imperial Cherry Appalachian Cherry Sable Cherry
Maple	Clear Maple Honey Maple Wheat Maple
Walnut	Natural Walnut Regular Walnut Mahogany on Walnut Dark Walnut Cordovan Walnut

WOOD FINISHES TO MATCH STANDARD LAMINATES

Copper on Cherry
Shiraz Cherry
Park Avenue Walnut
Chocolate on Walnut
Nutmeg on Walnut
Dark Walnut
Hardrock Maple

NATURAL CHARACTERISTICS OF WOOD

Wood is a natural product with inherent color variations that will never be fully mitigated by the finishing process. Please anticipate variation in colors within a single unit, from piece to piece, and from Krug wood finish samples. If a very close match is required, a sample must be provided with the order and an upcharge will apply. Exact color matches are not possible.

CUSTOM WOOD FINISHES

Add 10% list to your order for special finishes, minimum upcharge is \$600 list per finish per order. (For example, on all orders up to \$6000 list, an upcharge of \$600 will apply, on orders \$6000 and up add 10% list to your order.)

For orders with special finishes, a sample that is a minimum 3" by 3" must be received with the order. Special finishes may add additional lead time to production schedules. Since wood is a natural product, some variations in grain, color, and stain acceptance will occur. In our finishing processes, we try to minimize variations, but some variation between samples and finished goods should be anticipated.

BIRDSEYE MAPLE

Bookmatched Birdseye Maple veneer is available on Millennium at an upcharge of **\$73 list per square foot**. Specify clearly on order. Birdseye Maple is recommended in clear finish only. Birdseye Maple only applies to tops.

DUAL FINISH

Add 10% net per item if specifying dual finish

VENEER

Millennium veneer is flat cut

MILLENNIUM | CUSTOM SIZING & PRICING METHODS

CUSTOM SIZING

Now you can customize the sizing of most components and obtain prices immediately using a few simple guidelines. Customized products may require an extended lead time if they have not been previously engineered. Please see following page for instructions.

Products that can be custom sized:

Desks, Table Desks, Curvilinear Desks (excluding curvilinear shaped units with a non-standard radius)

Linking Units

Returns, Curvilinear Returns (excluding curvilinear shaped units with a non-standard radius), Kneehole Credenzas, Full Face Credenzas Shells

Modular Tops

Modesty Panels (excluding perforated modesty panels)

Hutches, Wall Units, Wood Door Overheads, Wood Door Work Walls

Bookcases, Wood Door Storage Units

Gallery Desks, Gallery Kneehole Credenzas, Gallery Linking Units, Gallery Returns

Paper Managers 6800, 6900, & 9800 (excluding those with drawers)

PRICING METHOD

Custom widths: Apply the price of the same unit in the price list that is one standard size larger than the desired case size (but same depth). For example: The required custom dimension is 74" x 24". The first standard size above this is 78" x 24", so in this case, you would apply the price of the 78" x 24" unit.

Custom depths: Apply the price for the same unit one size deeper (but same width). For example: The required custom dimension is 72" x 26". The first standard size above this is 72" x 30", so in this case, you would apply the price of the 72" x 30" unit.

Custom width & depths: Apply the price for the same unit both one size wider and one size deeper.

For example: The required custom dimension is 74" x 26". The first standard size above this is 84" x 30", so in this case, you would apply the price of the 84" x 30" unit.

Custom height of desk height cases: Add 18%. (31-32" HI)

OTHER PRICING METHODS

cases where tops are flush left/right or both, add	\$115 list
Grommets in non-standard positions, add:	\$145 list
To remove hutch or overhead doors, deduct:	4% list
convert 5-hi hutch to 6-hi hutch, add:	20% list
Bookcases with optional pull out printer shelf at standard shelf height, add:	\$227 list
Bookcases with optional vent in back (includes 2 vents and 1 grommet), add:	\$288 list
2 lateral file and 3 or 4 closed shelves - convert to half open, half closed shelves, add	15% list
2 lateral file and 3 or 4 closed shelves - convert to half open, half wa drobe, add:	15% list
To remove storage doors for open shelves, deduct:	4% list
glass transition tops, add:	\$1044 list (30" & under)
- glass transition tops are affixed via brushe	\$1206 list (Over 30" up to 60")
metal stanchions, and finished with brushed metal caps	\$1356 list (over 60" up to 84")
	\$1508 list (over 84" up to 96")
glass tops on buffets, add:	\$2261 list (for 60, 72, & 84" cases)
Angire, add:	20% list on Maple pricing

EXCEPTIONS TO THE PRICING METHODS ABOVE

Sizes larger than the largest shown Price List.

Non-standard extension on drawer slides.

Non-standard drawer depths in standard depth pedestals.

Glass door - any style.

Glass - face mounted modesty panels.

Perforated modesty panels.

Cases with curvilinear tops where the radius becomes non-standard.

A/V cabinets.

Any case with flipper doors

Please contact Specials Coordinator or Krug Customer Service at 1.888.578.KRUG if you require assistance.

PLEASE NOTE: Cases with non-standard features do not apply to the rules above.

Contact Krug Customer Service if you require assistance.

MILLENNIUM | GENERAL PRODUCT SPECIFICATIONS

WORKSURFACES

Tops are made of 1 1/2" - 45 lbs. per cubic foot density particle board core with face and back veneer. All edges have 1 1/2" wide 3/4" thick Walnut, Cherry or Maple headers.

GABLES

Gables are 1 1/8" thick - 45 lbs. per cubic foot density particle board core, 3 ply. Edges are banded with veneer.

VENEER

External face veneers are #1 grade flat sliced Black Walnut, Cherry or Maple book-matched and of uniform color and grain pattern.

SOLIDS

All solids used shall be American Black Walnut, Cherry or Maple kiln-dried by the manufacturer to a 6% moisture content.

FINISH

All finished surfaces are well sanded before applying finishing materials. The procedure begins by applying a base color via an N.G.R. stain. A wash coat follows to further enhance the color. A filter coat is applied to fill open pores and wipe clean. A sealer coat is applied and scuff-sanded to prepare for the top coat (finish). The final procedure is to apply catalyzed varnish that when dry has a sheen value of 32°.

LOCKS

Locks are standard on all pedestals and storage unit lateral file drawers
Locks are optional on door fronts and must be specified at time of order.
For Master Key, note clearly on p.o. and **add \$40 list.**

DRAWERS

Desk box drawers have fully progressive full extension slides and are load rated at 100 lbs. per drawer.
Desk files drawers have a load bearing capacity of 130 lbs. and box drawers have a load bearing capacity of 100 lbs
Other pedestal file drawers have fully progressive, full extension slides and are load rated at 100 lbs. per drawer.
All drawer interiors are clear finished Birch on particle board constructed with dowels.
All file drawers are equipped for letter and legal filing
All box/box/file pedestals in desks only are supplied with one matching pencil tray.

GLIDES

Adjustable glides are installed at factory and allow for 3/4" adjustment.

HINGES

Doors have a European style hinges with a 95° opening.

PULLS

Pulls are available in Satin Nickel, Matte Black, Polished Chrome, Black Chrome and Brushed Brass.
Please specify on your order.

TESTING INFORMATION

Millennium meets or exceeds the testing requirements of ANSI/BIFMA X5.5-2014 and/or X5.9 - 2012.



MILLENNIUM | EDGE DETAIL PROFILES, DRAWER PULLS & LOCKS

An edge detail profile must be selected for every Millennium product.
Millennium product is available in the following profile options



Seville - contrasting crisp and rounded sculpted edge



Valen - transitional beveled edge



Torrens - softened square edge



Madrid - ribbon fluted edge



Barcelona - half round edge



Zamora - bull nose edge



Williamsburg - traditional edge

PROFILE LOCATIONS

Desk, Credenzas and Shells: profile is located on all side

Curvilinear Shaped Tops: profile is located on all four side

Bookcase and Storage Units: profile is located on all four side

Hutches: profile is located on all three sides

Link Units, Curvilinear Returns and Returns: when units are connected to create a larger worksurface area, some profile options have coved edges to create a smooth transition from one surface to another.

The following profiles have coved edges on connecting ends of return and linking units: Seville, Valen, Barcelona, Williamsburg, Zamora All other profile options will appear on all sides of the case, meeting each other face to face at worksurface connection points

DRAWER PULLS

Luna, Eclipse and Crescent Pulls are available in Satin Nickel, Matte Black, Polished Chrome, Black Chrome, and Brushed Brass. Pull color and style must be stated clearly on the purchase order. Pulls are located on all drawer fronts, storage wood doors, and bookcase wood doors. Glass door bookcases feature the Luna knob in the same finish as pulls on the order. Glass door hutches and wood door hutches do not have pulls.



Luna



Eclipse



Crescent



Oyster pulls are available in Matte Black, Polished Chrome, and Brushed Brass.



WILLIAMSBURG

A Williamsburg pull in Polished Brass is standard on all products specified with the Williamsburg edge detail.

LOCKS

Locks are provided as a standard features on all pedestals, including those in desks, credenzas and lateral file storage units. Lock plugs on desks are located in the kneespace on the pedestal side panel. Locks are not available on all glass doors. Locks are available on bookcase doors at an upcharge of **\$145 list** per set of (2) doors, please specify at time of order. If a hutch or overhead has an uneven amount of doors the single lock required is also **\$145**. Lock plugs for bookcase doors are generally located on the top inside corner of the door front. Lock plugs for hutch and overhead doors are generally located on the lower inside corners. Suites can be keyed alike at no upcharge, please specify on your purchase order

MILLENNIUM | GROMMETS & POWERPORTS

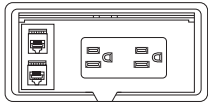

POWER / DATA / VOICE MODULE (SUPPLIED WITH WIRED HUTCHES)

Black, rectangular with flip down cove . Includes two power outlets, one voice port, and one data port.

POWER DETAILS:
two Simplex outlets
15 Amp, 10 ft. cord

COMMUNICATION DETAILS:
one 6-pin and one 8-pin connector

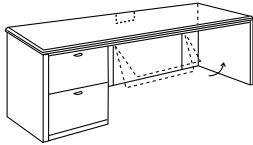

WIRE MANAGEMENT CUT-OUT AND HINGED MODESTY PANELS

Returns, link units and credenzas with fixed modesty panels can be specified with an 8" x 1 1/2" wire management cut-out. All hinged modesty panels feature a cut-out as a standard. The discreet cut-out allows for clean and easy access to power, data and communication sources.

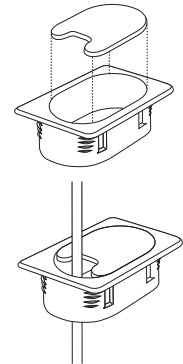

GROMMETS

All cases may be specified with one grommet in a standard position at no upcharge. A **\$145 list upcharge** will apply to additional grommets in standard positions and for grommets requested in non-standard positions a **\$145 list upcharge** will apply.

The grommet position must be indicated for each case on the purchase order.

Standard Grommet

Black or Grey, rectangular, 4 1/8" x 2 11/16". Please note grommet color on purchase order.

Please specify grommet color when ordering, Grommets can also be field installed with power drill 2 1/4 hole saw and rasp or saber saw. Template for drilling is available.

Please keep in mind the location of grommets when specifying paper managers for use with worksurfaces. For example, a paper manager on the left hand side may be used with a "C", "BR" or "AR" grommet.

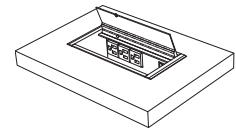

POWERPORT

A PowerPort is a unique worksurface mounted module that can be specified to a location that best serves the user's needs. It includes a UL approved electrical, voice and data power bar, containing two 115 - volt electrical simplex outlets which are accessible from the work surface, plus a utility outlet at the end for daisy chaining purposes. 3 data versions are available.

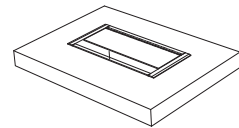

PORT

A service module having no power bar will serve as a large grommet. A hinged lid easily enables the passage of several cables and devices

STANDARD GROMMET POSITIONS

Desks, Credenzas, Link Units & Returns

30" Deep Desks:

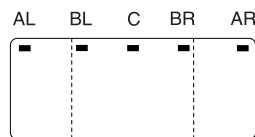

Position Code:

AL – left corner
BL – left end beside pedestal gable
C – center
BR – right end beside pedestal gable
AR – right corner

36" Deep Desks:

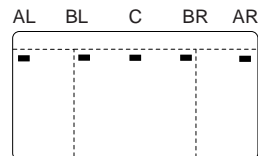

Position Code:

AL – left corner
BL – left end beside pedestal gable
C – center
BR – right end beside pedestal gable
AR – right corner

NOTE

Please do not specify grommets in the "C" position for 60-71" ganged pedestal returns and credenzas. In these cases, the "C" position is over the top of a pedestal.

"BL" and "BR" are only available on tops 42" or longer.



CURVILINEAR TOPS

Position Code:

C – center

This key applies to all B, P, Q, and K shaped tops.

The support panel is notched out to accommodate wire management.

MILLENNIUM | LAMINATE, DESKS, OVERHEADS & HUTCHES

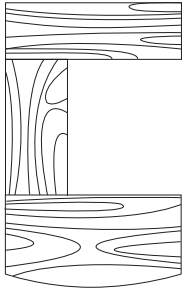

LAMINATE WORKSURFACES

Laminate worksurfaces are available at an upcharge of 10% (a higher upcharge may apply to specially priced plastic laminates. Where there are wood profile edges on worksurface tops, they will remain as wood profile on laminate tops. Krug will order and procure laminates. Purchase orders with a plastic laminate option must include Laminate name.

When specifying laminate worksurfaces, the grain direction is such that the grain pattern runs the length of each surface, as shown in the diagram on the left.

Please contact Krug Customer Service for questions pertaining to laminate grain direction.

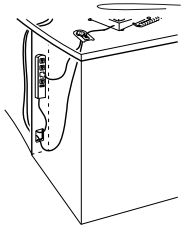

DESKS WIRE MANAGEMENT CAVITY

Millennium desks can also be specified with a hidden wire management cavity. This finished cavity is accessed from the front of the desk by a hinged door and is completely concealed in the closed position. The wire management cavity includes a four receptacle power bar mounted on the inside pedestal gable. This feature allows the use of several powered items on the desk surface and greatly reduces the number of cables routed to the primary power source. The hinged cavity also effectively conceals all excess cables from view.

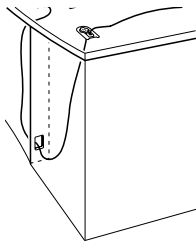

PEDESTAL ACCESS WIRING GROMMET

All Millennium desks allow for wire management behind the pedestal drawers. Pedestal gables feature a standard cable management opening allowing access to the rear of the pedestal cavity. By specifying a wiring grommet in a standard AL or AR position (see grommet locations on page 251, cable can be conveniently threaded behind the pedestal drawers and through the wire management access grommet.

Combined with our standard wire management cover, all cables are neatly tucked out of view.

BIRDSEYE MAPLE

Birdseye Maple Veneer is available on 6800 Millennium worksurfaces at an upcharge of **\$73 list per square foot**. Birdseye Maple is recommended in a clear finish only. This option could extend regular lead times.

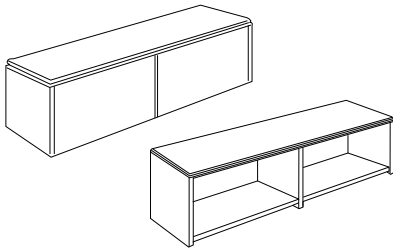

OVERHEADS

Overheads include tasklights that are factory installed and require no field adjustment. Tasklights are mounted beneath the cabinet and hidden from view. Cords run down the right hand side of the tasklight to the worksurface where they can be routed behind the worksurface top. The use of a wall mounted tackboard conceals the cord from view. Tackboards must be ordered separately and can be specified in any fabric grade (1-9. Wall mounted tackboards for overheads are supplied with all necessary hardware for installation. Locks are optional on overheads and can be specified at time of order for an upcharge of **\$145 list per set** of (2) doors.

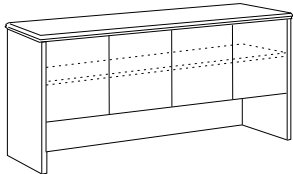

HUTCHES

Hutches include tasklights that are factory installed and require no field adjustment. Tasklights are mounted beneath the cabinet and hidden from view. Glass doors on hutches are wood framed clear glass. A tackboard in Krug Momentum Panel grade 1 fabric is included with every hutch. Upcharges for higher graded fabrics are listed on page 297. Tackboard fabric selections should be supplied with the order information, fabric options are listed on page 4 of this price guide. Tackboards for hutches are installed at the factory and require no additional set up on site.

Hutches over 84" in length are made in two pieces and require special installation.

Hutches are available with a finished inside back panel at standard list price, but must be clearly specified on order. This option is available on hutches up to 84" in length only. This option does not include a tackboard. Locks are optional on overheads and can be specified at time of order for an upcharge of **\$145 list per set** of (2) doors.

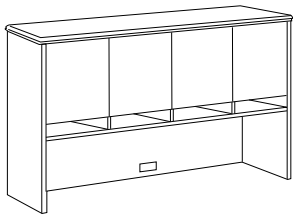

HUTCH POWER DATA OPTION

Access to power and data is made simple by using a hutch with a power data module built right into the tackboard. The module is fully installed at the factory but can be removed to connect data links on site. It features a flip door that retracts into the case of the unit when open. See page 251 in the grommets section for complete power specifications

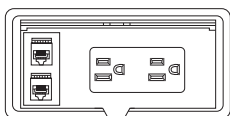

INSTALLATION

Hutch and overhead installation instructions are included with every case, basic installation instructions can be found in this guide on page 253. All required mounting hardware is included with all hutches.

MILLENNIUM | FILING INSTRUCTIONS & INSTALLATION

FILING INSTRUCTIONS

All file drawers will accept both letter and legal size filling. All units are equipped with file bars to accommodate either direction. File bars are shipped taped to the inside of the drawer for safety.



DESK PEDESTAL FILE DRAWERS

Filing Capacity:

25.5" of letter filing from front to back, or
12" of legal filing side to side

Pedestal drawer depths allow only one row of side to side files

Legal files can be positioned in the side to side direction only.

Weight capacity of pedestal file drawers is 130 lbs

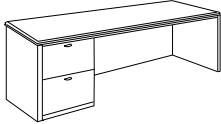

CREDENZA AND RETURN PEDESTAL FILE DRAWERS

Filing Capacity:

15" of letter filing from front to back, or
12" of legal filing side to side

Pedestal drawer depths can be positioned in the side to side direction only.

Weight capacity of pedestal file drawers is 100 lbs

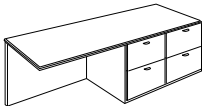

CREDENZA, RETURN OR STORAGE LATERAL FILE DRAWERS

Filing Capacity for 30" wide drawers:

30" of letter filing front to back, or
25" of legal filing side to side, or
15" of legal filing front to back

When filing front to back, 30" lateral file drawer widths allow two rows of letter filing, but only one row of legal file width

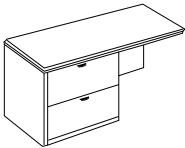

Filing Capacity for 36" wide drawers:

30" of letter filing front to back, or
36" of legal filing side to side, or
30" of legal filing front to back

Weight capacity of lateral file drawers is 150 lbs

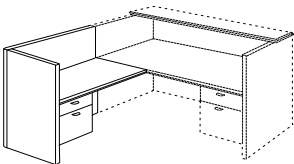

CONNECTING WORKSURFACES

It is important that the product is in its final position and the primary worksurface is leveled before connecting other joining pieces.

Detailed installation instructions are included with each unit, or available from Krug Customer Service.

Units are connected with mending plates under worksurfaces, and linking brackets on modesty and end panels. Locate connections and attach the mending plates under the worksurface. Level pieces if necessary by adjusting the glides to achieve flush and firm joints before completing installation of all hardware.

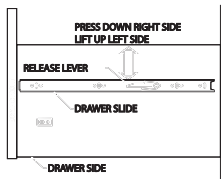

DRAWER REMOVAL

To remove pedestal drawers, open to the extended position, press down on the right side nylon release lever and pull the drawers up on the left side lever at the same time. Continue pulling the drawers out of the case.

GLIDE ADJUSTMENT

Raise one corner of the unit at a time and adjust the glide to the desired height by turning the glide in the hole. Make sure unit is level after adjusting the glides. Please note that the maximum adjustment range of the glides is 1 1/2". When moving units after glides have been inserted, dial the glides to the lowest position to prevent damage to the case.

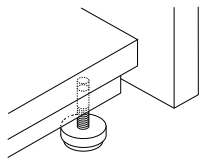

BOOKCASE OR HUTCH DOOR ADJUSTMENT

Hinges on all hutch and bookcase doors are designed to be adjusted for depth, horizontal and vertical adjustment by means of screws into the hinge mounting plates.

To remove a door, squeeze the release clip and pull out the door, disconnecting the hinges.

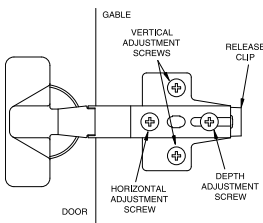

OVERHEAD INSTALLATION

The wall mount overhead storage units must be installed on wall studs. The first step for installation is to locate the studs in the wall where the overhead is to be mounted. Measure the stud center line location and use this measurement to mark the hole locations on the mounting rail and the overhead back. Drill clearance holes at the hole locations. Hole requirements will depend on the fasteners chosen by the installer. 2 1/2" x #10 wood screws are adequate if going into wood studs. If studs cannot be accessed, then appropriate drywall plugs or butterfly bolts should be used. We recommend 2 fasteners per stud.

Fasten the mounting rail to the wall ensuring that it is level. Hang the overhead on the mounting rail and then fasten it to the wall. This prevents accidental removal and also allows for some leveling adjustment.

MILLENNIUM | HEIGHT ADJUSTABLE WORKSURFACE WITH BASE ENCLOSURE

Single Stage Mechanism With Base Enclosure

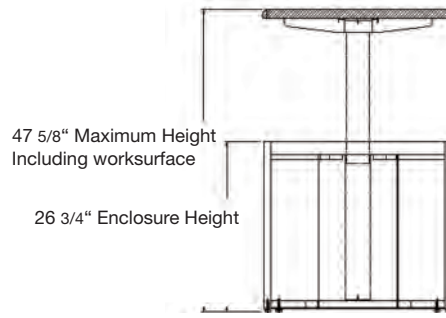
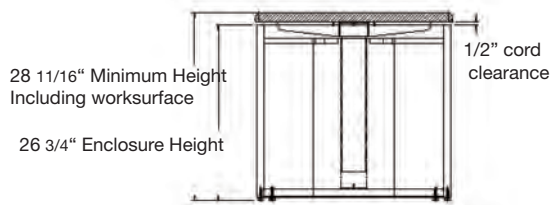

The Single Stage mechanism with Base Enclosure has an adjustable height range of 28 11/16 - 47 5/8 inches. When the work surface is at the lowest stage - desk height, the space between underside of the work surface and the top of the Base Enclosure is 1/2 inch.

Dual Stage Mechanism With Base Enclosure

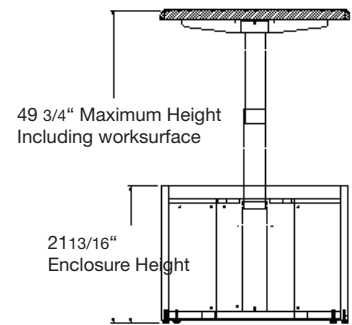
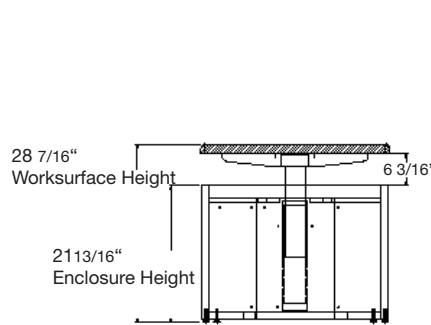
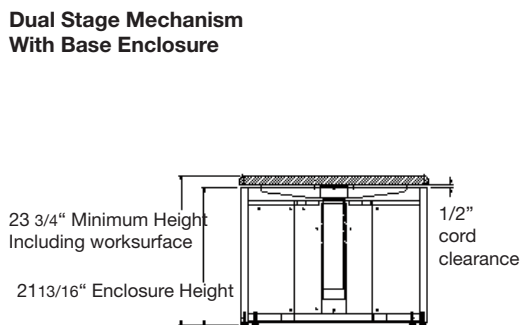

The Dual Stage mechanism with Base Enclosure has an adjustable height range of 23 3/4 - 49 3/4 inches. When the work surface is at the standard desk height setting of 28 7/16", the space between underside of the work surface and the top of the Base Enclosure is 6 inches. This allows for the full range of height adjustments.

Custom Base Enclosures for the Dual Stage are available decreasing the gap below the work surface to 1/2 inch.

Caution: this eliminates the ability to use the lower stage settings.

Custom Base Enclosures to further lower the minimum work surface height are also available, removing the inside enclosure floor completely and allowing a minimum desk height of 22 7/16". Contact customer service for a quote.

MILLENNIUM | SAMPLE CONFIGURATIONS

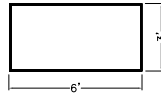
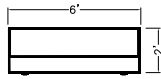
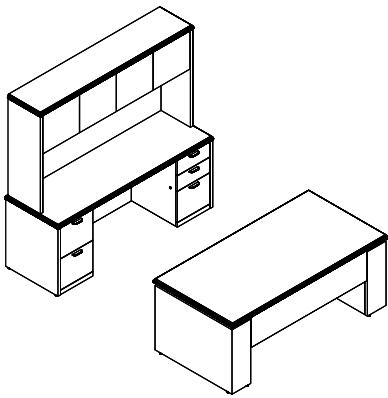

	Model	Cherry Maple Walnut
Height Adj. Desk	68HA7136ETSGV21	7434
Hutch	68HT7115	5390
Credenza	68CY71244LDRF	6329
TOTAL		19,153

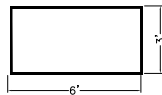
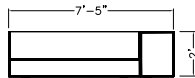
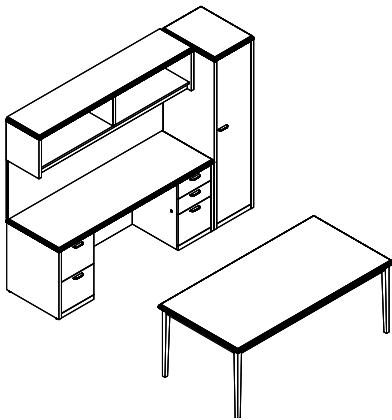

	Model	Cherry Maple Walnut
Desk	68TDE7136	5160
Overhead	68OO711517	2658
Tackboard	68TBOH71	610
Credenza	68CY71244LDRF	6329
Flush Right	option	120
Storage	68ST18246811R	3890
TOTAL		18,767

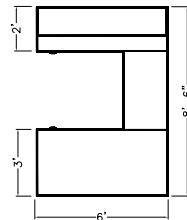
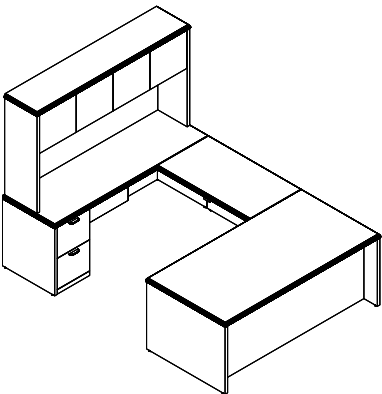

	Model	Cherry Maple Walnut
Desk	68D71364LORF	5443
Link Unit	68LU4224H	2055
Hutch	68HT7115	5390
Credenza	68CY71244LDR0	5347
TOTAL		18,235

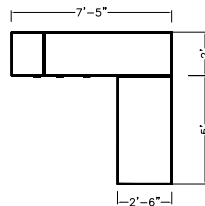
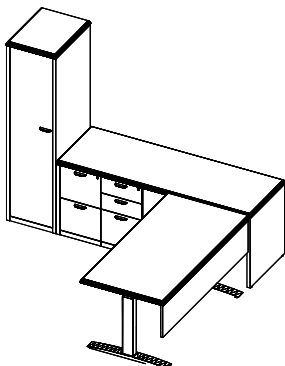

	Model	Cherry Maple Walnut
Height Adj. Desk	68HA6030ETSV21	4683
Credenza	68C71204LDFR0	6244
Flush Left	option	120
Storage	68ST18246811L	3890
TOTAL		14,937

MILLENNIUM PRODUCT ENHANCEMENTS

Please follow the instructions below to enhance Millennium with optional product features.

INSTRUCTIONS

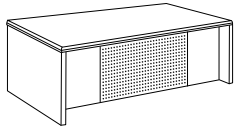

DESK WITH PERFORATED METAL MODESTY PANEL
 Not available on 3/4 Height Pedestal Desks
 Available on Desks 66" and up
 Add 'P' to model number prefix
 Example: 68-DP-6030-LDRD
10% list upcharge

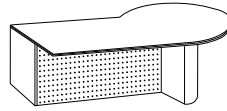

CURVILINEAR RETURNS WITH PERFORATED METAL MODESTY PANEL
 Only available on 71" & 84" units and only available in conjunction with Half Drum Base
 Add 'P' to model number prefix
 Example: 68PPRL-7130-DB
20% list upcharge

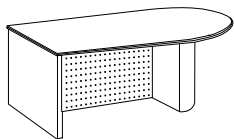

CURVILINEAR DESKS WITH PERFORATED METAL MODESTY PANEL
 Only available on 71" & 84" units and only available in conjunction with Half Drum Base
 Add 'P' to model number prefix
 Example: 68BDP-7130-DB
20% list upcharge

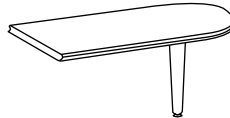

CURVILINEAR RETURNS WITH TAPERED BRUSHED ALUMINUM POST LEG
 Only available on Returns without Modesty Panels
 Add 'T' to model number suffix
 Example: 68BR-6630-T
No upcharge

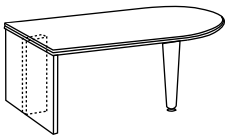

CURVILINEAR DESKS WITH TAPERED BRUSHED ALUMINUM POST LEG
 Only available on Desks without Modesty Panels
 Add 'T' to model number suffi
 Example: 68BD-6630-T
No upcharge

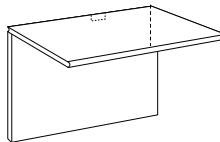

LINK UNIT WITH WIRE MANAGEMENT CUT-OUT ON MODESTY PANEL
 Available in standard center position
 Note clearly on purchase order
\$185 list upcharge

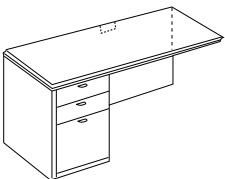

RETURNS WITH WIRE MANAGEMENT CUT-OUT ON MODESTY PANEL
 Not available on Desk Depth Returns
 Available in standard center position on modesty panel
 Note clearly on purchase order
\$185 list upcharge

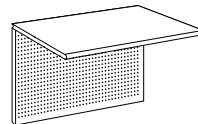

LINK UNITS WITH PERFORATED METAL MODESTY PANEL
 Add 'P' to model number prefix
 Example: 68-LUP-3024-H
40% list upcharge

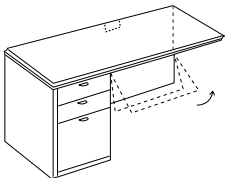

RETURNS WITH HINGED WOOD MODESTY PANEL OPTION
 Add 'Y' to model number prefix
 Example: 68RHY-4220-L4D
10% list upcharge

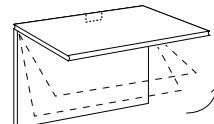

LINK UNITS WITH HINGED WOOD MODESTY PANEL
 Add 'Y' to model number prefix
 Example: 68-LUY-3024-H
10% list upcharge

ORDERING PROCEDURE

To order, please specify the following:

- 1) Krug product model number
- 2) Wood species and finish
- 3) Wood edge detail - S, V, T, M, B, Z or W, see page 250

*Indicates model illustrated by line drawing.

CODE DESCRIPTION

- P — perforated metal modesty panel
- T — tapered brushed aluminum panel
- Y — hinged wood modesty panel

The metal finish on perforated metal modesty panels, tapered brushed aluminum post legs, tackboard organizer rail, and accessories all match the Millennium satin nickel pull finish.

STANDARD FINISHES

For a complete list of standard wood finishes please see page 247

PERFORATED METAL MODESTY PANEL

Perforated metal modesty panels are 16 gage thick steel panels with a brushed metal finish

MILLENNIUM | PRODUCT ENHANCEMENTS

Please follow the instructions below to enhance Millennium with optional product features.

INSTRUCTIONS

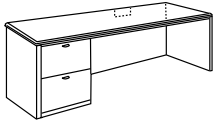

CRENZAS WITH CUT-OUT GROMMET OPTION ON MODESTY PANEL
Note clearly on purchase order
\$185 list upcharge

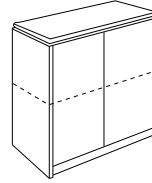

DOUBLE HEIGHT OVERHEADS
Only available on 36", 42" and 48" hinged door and open models Add '33' to model number suffix
Example: 680H-3633
25% list upcharge

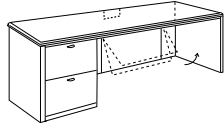

CRENZAS WITH HINGED WOOD MODESTY PANEL
Not available on Ganged Pedestal, or Lateral File/Bookcase Credenzas
Add 'Y' to model number prefi
Example: 68CY-6020-4-LDR0
10% list upcharge

DOUBLE HEIGHT PAPER MANAGEMENT OVERHEADS
Only available on 36", 42" and 48" hinged door and open models Add 'PM' to model number suffix
Example: 680HPM-3629
35% list upcharge

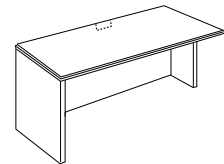

OPEN RETURNS WITH WIRE MANAGEMENT CUT-OUT ON MODESTY PANEL
Available in standard center position
Note clearly on purchase order
\$185 list upcharge

PAPER MANAGEMENT OVERHEADS
Not available on Flipper Door Models Add 'PM' to model number prefix
Example: 680HPM-36
10% list upcharge

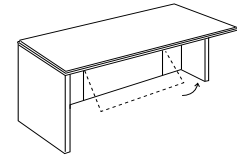

OPEN RETURNS WITH HINGED WOOD MODESTY PANEL
Add 'Y' to model number prefi
Example: 68RHY-4224
10% list upcharge



SHELLS WITH WIRE MANAGEMENT CUT-OUT ON MODESTY PANEL
Wire Management Cut-Out: 7 7/8" x 4 9/16"
Available in standard center position and also available on Corner Credenza Shell Model
Note clearly on purchase order
\$185 list upcharge



MOBILE PEDESTAL WITH UPHOLSTERED SEAT
Reference model #: 68MPSU-4F
Available in a shallow version only

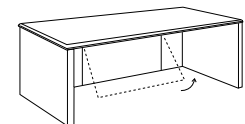

SHELLS WITH HINGED WOOD MODESTY PANEL
Width of hinged modesty panel allows for installation of 16" pedestals
Also available on Corner Credenza Shell Model
Add 'Y' to model number prefi
Example: 68SY-3020
10% list upcharge

FABRIC GRADES

MODEL	1	2	3	4	5	6	7	8	9
Cherry/Maple/Walnut									
	2618	2664	2713	2757	2805	2850	2898	3036	3172
MODEL	W	D	H	SHIP WT.	CU.FT.	COM			
MPSU-4F	16	18.5	25.25	76	6	1			

DIMENSION KEY

W - width
D - depth
H - height

CODE DESCRIPTION





P — perforated metal modesty panel
Y — hinged wood modesty panel
X — hinged glass doors
29 — double height overheads
PM — paper manager
The metal finish on perforated metal modesty panels, tapered brushed aluminum post legs, tackboard organizer rail, and accessories match the Millennium satin nickel pull finish

STANDARD FINISHES

For a complete list of standard wood finishes please see page 247.

HINGED WOOD MODESTY PANEL Hinged wood modesty panels come standard with a center positioned wire management cut-out.

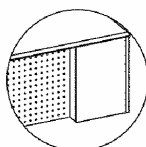
MILLENNIUM | DESKS

Description	Model	Cherry Walnut Maple	W	D	H	KW	Shipping	
							Weight	Cubic Feet
Double Pedestal Desk with Full Height Pedestals   	68D60304LDRD	6707	60	30.25	28.5	27.5	296	36
	68D60304LDRF	6707	60	30.25	28.5	27.5	296	36
	68D60304LFRD	6707	60	30.25	28.5	27.5	296	36
	68D60304LFRF	6707	60	30.25	28.5	27.5	296	36
	68D66304LDRD	6730	65.75	30.25	28.5	33.25	314	39
	68D66304LDRF	6730	65.75	30.25	28.5	33.25	314	39
	68D66304LFRD*	6730	65.75	30.25	28.5	33.25	314	39
	68D66304LFRF	6730	65.75	30.25	28.5	33.25	314	39
	68D66364LDRD	6765	65.75	36.25	28.5	33.25	354	46
	68D66364LDRF	6765	65.75	36.25	28.5	33.25	354	46
	68D66364LFRD	6765	65.75	36.25	28.5	33.25	354	46
	68D66364LFRF	6765	65.75	36.25	28.5	33.25	354	46
	68D71304LDRD	6770	71	30.25	28.5	38.25	329	42
	68D71304LDRF	6770	71	30.25	28.5	38.25	329	42
	68D71304LFRD	6770	71	30.25	28.5	38.25	329	42
	68D71304LFRF	6770	71	30.25	28.5	38.25	329	42
	68D71364LDRD	6882	71	36.25	28.5	38.35	372	50
	68D71364LDRF	6882	71	36.25	28.5	38.35	372	50
	68D71364LFRD	6882	71	36.25	28.5	38.35	372	50
	68D71364LFRF	6882	71	36.25	28.5	38.35	372	50
	68D78304LDRD	6892	78	30.25	28.5	45.5	350	46
	68D78304LDRF	6892	78	30.25	28.5	45.5	350	46
	68D78304LFRD	6892	78	30.25	28.5	45.5	350	46
	68D78304LFRF	6892	78	30.25	28.5	45.5	350	46
	68D78364LDRD	6969	78	36.25	28.5	45.5	397	36
	68D78364LDRF	6969	78	36.25	28.5	45.5	397	36
	68D78364LFRD	6969	78	36.25	28.5	45.5	397	36
	68D78364LFRF	6969	78	36.25	28.5	45.5	397	36
68D84364LDRD	7000	84	36.25	28.5	51.5	399	39	
68D84364LDRF	7000	84	36.25	28.5	51.5	399	39	
68D84364LFRD	7000	84	36.25	28.5	51.5	399	39	
68D84364LFRF	7000	84	36.25	28.5	51.5	399	39	
Double Pedestal Desk with Full Height Pedestals & Breakfront Modesty Panel  	68DBF66364LDRD	7498	65.75	36.25	28.5	33.25	354	46
	68DBF66364LDRF	7498	65.75	36.25	28.5	33.25	354	46
	68DBF66364LFRD*	7498	65.75	36.25	28.5	33.25	354	46
	68DBF66364LFRF	7498	65.75	36.25	28.5	33.25	354	46
	68DBF71364LDRD	7599	71	36.25	28.5	38.25	372	50
	68DBF71364LDRF	7599	71	36.25	28.5	38.25	372	50
	68DBF71364LFRD	7599	71	36.25	28.5	38.25	372	50
	68DBF71364LFRF	7599	71	36.25	28.5	38.25	372	50
	68DBF78364LDRD	7715	78	36.25	28.5	45.5	397	36
	68DBF78364LDRF	7715	78	36.25	28.5	45.5	397	36
	68DBF78364LFRD	7715	78	36.25	28.5	45.5	397	36
	68DBF78364LFRF	7715	78	36.25	28.5	45.5	397	36
	68DBF84364LDRD	7713	84	36.25	28.5	51.5	399	39
	68DBF84364LDRF	7713	84	36.25	28.5	51.5	399	39
68DBF84364LFRD	7713	84	36.25	28.5	51.5	399	39	
68DBF84364LFRF	7713	84	36.25	28.5	51.5	399	39	

ORDERING NOTES:

30" deep desks have flush modesty panels, 36" deep desks have recessed modesty panels. Please see page 256 for perforated metal modesty panel option. Laminate worksurfaces are available at a 10% upcharge.

ORDERING PROCEDURE

To order, please specify the following:

- 1) Krug product model number
- 2) Wood species and finish, see page 247
- 3) Wood edge detail- I, H, L or P, see page 250
- 4) Pull style, see page 250
- 5) Grommet location if applicable

*Indicates model illustrated by line drawing.

CODE DESCRIPTION

- 4 - full height pedestal
- L - left handed pedestal position
- R - right handed pedestal position
- D - 2 file drawer
- F - 2 box, 1 file drawer
- BF- break front modesty panel

STANDARD FINISHES

For a complete list of standard wood finishes please see page 247.

GROMMETS

One wiring grommet in standard position is optional at no charge. See page 251 for more power management information.

MILLENNIUM | DESKS

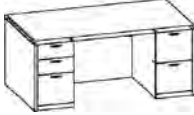
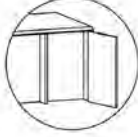
Description	Model	Cherry	W	D	H	KW	Shipping Weight	Cubic Feet
		Walnut Maple						
Double Pedestal Desk with Full Height Pedestals & Breakfront	68DBF66364LDWRD	9038	65.75	36.25	28.5	33.25	354	46
	68DBF66364LDRDW	9038	65.75	36.25	28.5	33.25	354	46
Modesty Panel with Wire Management Cavity	68DBF66364LFRWD*	9038	65.75	36.25	28.5	33.25	354	46
	68DBF66364LFRDW	9038	65.75	36.25	28.5	33.25	354	46
	68DBF66364LDRFW	9038	65.75	36.25	28.5	33.25	354	46
	68DBF66364LFRFW	9038	65.75	36.25	28.5	33.25	354	46
	68DBF71364LDWRD	9172	71	36.25	28.5	38.25	372	50
	68DBF71364LDRDW	9172	71	36.25	28.5	38.25	372	50
	68DBF71364LDWRF	9172	71	36.25	28.5	38.25	372	50
	68DBF71364LDRFW	9172	71	36.25	28.5	38.25	372	50
	68DBF71364LFRWD	9172	71	36.25	28.5	38.25	372	50
	68DBF71364LFRDW	9172	71	36.25	28.5	38.25	372	50
	68DBF71364LFRWF	9172	71	36.25	28.5	38.25	372	50
	68DBF71364LFRFW	9172	71	36.25	28.5	38.25	372	50
	68DBF78364LDWRD	9258	78	36.25	28.5	45.5	397	36
	68DBF78364LDRDW	9258	78	36.25	28.5	45.5	397	36
	68DBF78364LDWRF	9258	78	36.25	28.5	45.5	397	36
	68DBF78364LDRFW	9258	78	36.25	28.5	45.5	397	36
	68DBF78364LFRWD	9258	78	36.25	28.5	45.5	397	36
	68DBF78364LFRDW	9258	78	36.25	28.5	45.5	397	36
	68DBF78364LFRWF	9258	78	36.25	28.5	45.5	397	36
	68DBF78364LFRFW	9258	78	36.25	28.5	45.5	397	36
	68DBF84364LDWRD	9295	84	36.25	28.5	51.5	399	39
	68DBF84364LDRDW	9295	84	36.25	28.5	51.5	399	39
	68DBF84364LDWRF	9295	84	36.25	28.5	51.5	399	39
	68DBF84364LDRFW	9295	84	36.25	28.5	51.5	399	39
	68DBF84364LFRWD	9295	84	36.25	28.5	51.5	399	39
	68DBF84364LFRDW	9295	84	36.25	28.5	51.5	399	39
	68DBF84364LFRWF	9295	84	36.25	28.5	51.5	399	39
	68DBF84364LFRFW	9295	84	36.25	28.5	51.5	399	39

DIMENSION KEY

W - width
D - depth
H - height

CODE DESCRIPTION

4 - full height pedestal
L - left handed pedestal position
R - right handed pedestal position
D - 2 file drawer
F - 2 box, 1 file drawer
BF- break front modesty panel
W - Wire Management Cavity

STANDARD FINISHES

For a complete list of standard wood finishes please see page 247.

GLASS DOORS

All storage glass doors come standard with a vertical Massa pull. Other pull options are not available on glass doors.

MILLENNIUM | DESKS

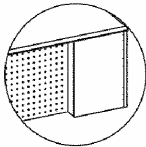
Description	Model	Cherry Walnut Maple	W	D	H	KW	Shipping Weight	Cubic Feet
Single Pedestal Desk with Full Height Pedestal	68D60304LDR0	5261	60	30.25	28.5	27.5	239	36
	68D60304LFR0	5261	60	30.25	28.5	27.5	239	36
	68D60304LORD	5261	60	30.25	28.5	27.5	239	36
	68D60304LORF	5261	60	30.25	28.5	27.5	239	36
	68D66304LDR0	5307	65.75	30.25	28.5	33.25	257	39
	68D66304LFR0	5307	65.75	30.25	28.5	33.25	257	39
	68D66304LORD	5307	65.75	30.25	28.5	33.25	257	39
	68D66304LORF	5307	65.75	30.25	28.5	33.25	257	39
	68D66364LDR0	5352	65.75	36.25	28.5	33.25	297	46
	68D66364LFR0*	5352	65.75	36.25	28.5	33.25	297	46
	68D66364LORD	5352	65.75	36.25	28.5	33.25	297	46
	68D66364LORF	5352	65.75	36.25	28.5	33.25	297	46
	68D71304LDR0	5363	71	30.25	28.5	38.25	272	42
	68D71304LFR0	5363	71	30.25	28.5	38.25	272	42
	68D71304LORD	5363	71	30.25	28.5	38.25	272	42
	68D71304LORF	5363	71	30.25	28.5	38.25	272	42
	68D71364LDR0	5443	71	36.25	28.5	38.35	315	50
	68D71364LFR0	5443	71	36.25	28.5	38.35	315	50
	68D71364LORD	5443	71	36.25	28.5	38.35	315	50
	68D71364LORF	5443	71	36.25	28.5	38.35	315	50
	68D78304LDR0	5507	78	30.25	28.5	45.5	293	46
	68D78304LFR0	5507	78	30.25	28.5	45.5	293	46
	68D78304LORD	5507	78	30.25	28.5	45.5	293	46
	68D78304LORF	5507	78	30.25	28.5	45.5	293	46
	68D78364LDR0	5539	78	36.25	28.5	45.5	340	36
	68D78364LFR0	5539	78	36.25	28.5	45.5	340	36
	68D78364LORD	5539	78	36.25	28.5	45.5	340	36
	68D78364LORF	5539	78	36.25	28.5	45.5	340	36
	68D84364LDR0	5605	84	36.25	28.5	51.5	342	39
	68D84364LFR0	5605	84	36.25	28.5	51.5	342	39
	68D84364LORD	5605	84	36.25	28.5	51.5	342	39
	68D84364LORF	5605	84	36.25	28.5	51.5	342	39

ORDERING NOTES:

30" deep desks have flush modesty panels, 36" deep desks have recessed modesty panels. Please see page 256 for perforated metal modesty panel option. Laminate worksurfaces are available at a 10% upcharge.

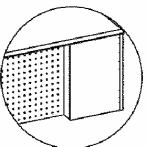
Single Pedestal Desk with Full Height Pedestal & Breakfront Modesty Panel	68DBF66364LDR0	6064	65.75	36.25	28.5	33.25	297	46
	68DBF66364LFR0*	6064	65.75	36.25	28.5	33.25	297	46
	68DBF66364LORD	6064	65.75	36.25	28.5	33.25	297	46
	68DBF66364LORF	6064	65.75	36.25	28.5	33.25	297	46
	68DBF71364LDR0	6183	71	36.25	28.5	38.25	315	50
	68DBF71364LFR0	6183	71	36.25	28.5	38.25	315	50
	68DBF71364LORD	6183	71	36.25	28.5	38.25	315	50
	68DBF71364LORF	6183	71	36.25	28.5	38.25	315	50
	68DBF78364LDR0	6264	78	36.25	28.5	45.5	340	36
	68DBF78364LFR0	6264	78	36.25	28.5	45.5	340	36
	68DBF78364LORD	6264	78	36.25	28.5	45.5	340	36
	68DBF78364LORF	6264	78	36.25	28.5	45.5	340	36
	68DBF84364LDR0	6346	84	36.25	28.5	51.5	342	39
	68DBF84364LFR0	6346	84	36.25	28.5	51.5	342	39
	68DBF84364LORD	6346	84	36.25	28.5	51.5	342	39
	68DBF84364LORF	6346	84	36.25	28.5	51.5	342	39

ORDERING PROCEDURE

To order, please specify the following:

- 1) Krug product model number
- 2) Wood species and finish, see page 247
- 3) Wood edge detail- I, H, L or P, see page 250
- 4) Pull style, see page 250
- 5) Grommet location if applicable

*Indicates model illustrated by line drawing.

CODE DESCRIPTION

- 4 - full height pedestal
- L - left handed pedestal position
- R - right handed pedestal position
- 0 - no pedestal
- D - 2 file drawer
- F - 2 box, 1 file drawer
- BF- break front modesty panel

STANDARD FINISHES

For a complete list of standard wood finishes please see page 247.

GROMMETS

One wiring grommet in standard position is optional at no charge. See page 251 for more power management information.

MILLENNIUM | DESKS

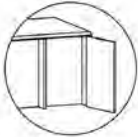
Description	Model	Cherry		W	D	H	KW	Shipping Weight	Cubic Feet
		Walnut	Maple						
Single Pedestal Desk with Full Height Pedestal	68DBF66364LDWR0	7669		65.75	36.25	28.5	33.25	307	46
	68DBF66364LFWR0*	7669		65.75	36.25	28.5	33.25	307	46
Breakfront Modesty Panel with Wire Management Cavity	68DBF66364LORDW	7669		65.75	36.25	28.5	33.25	307	46
	68DBF66364LDR0W	7669		65.75	36.25	28.5	33.25	307	46
	68DBF66364LFR0W	7669		65.75	36.25	28.5	33.25	307	46
	68DBF66364LOWRD	7669		65.75	36.25	28.5	33.25	307	46
	68DBF66364LOWRF	7669		65.75	36.25	28.5	33.25	307	46
	68DBF71364LDWR0	7739		71	36.25	28.5	38.25	325	50
	68DBF71364LFWR0	7739		71	36.25	28.5	38.25	325	50
	68DBF71364LORDW	7739		71	36.25	28.5	38.25	325	50
	68DBF71364LORFW	7739		71	36.25	28.5	38.25	325	50
	68DBF71364LDR0W	7739		71	36.25	28.5	38.25	325	50
	68DBF71364LFR0W	7739		71	36.25	28.5	38.25	325	50
	68DBF71364LOWRD	7739		71	36.25	28.5	38.25	325	50
	68DBF71364LOWRF	7739		71	36.25	28.5	38.25	325	50
	68DBF78364LDWR0	7860		78	36.25	28.5	45.5	350	36
	68DBF78364LFWR0	7860		78	36.25	28.5	45.5	350	36
	68DBF78364LORDW	7860		78	36.25	28.5	45.5	350	36
	68DBF78364LORFW	7860		78	36.25	28.5	45.5	350	36
	68DBF78364LDR0W	7860		78	36.25	28.5	45.5	350	36
	68DBF78364LFR0W	7860		78	36.25	28.5	45.5	350	36
	68DBF78364LOWRD	7860		78	36.25	28.5	45.5	350	36
	68DBF78364LOWRF	7860		78	36.25	28.5	45.5	350	36
	68DBF84364LDWR0	7907		78	36.25	28.5	51.5	352	39
	68DBF84364LFWR0	7907		78	36.25	28.5	51.5	352	39
	68DBF84364LORDW	7907		78	36.25	28.5	51.5	352	39
	68DBF84364LORFW	7907		78	36.25	28.5	51.5	352	39
	68DBF84364LDR0W	7907		78	36.25	28.5	51.5	352	39
	68DBF84364LFR0W	7907		78	36.25	28.5	51.5	352	39
	68DBF84364LOWRD	7907		78	36.25	28.5	51.5	352	39
	68DBF84364LOWRF	7907		78	36.25	28.5	51.5	352	39

ORDERING NOTES:

30" deep desks have flush modesty panels, 36" deep desks have recessed modesty panels. Please see page 256 for perforated metal modesty panel option. Laminate worksurfaces are available at a 10% upcharge.

Bow Top Option	Model		W	D	H	KW	Shipping Weight	Cubic Feet
	BT68D6630	678	-	-	-	-	-	-
	BT68D6636	714	-	-	-	-	-	-
	BT68D7130	740	-	-	-	-	-	-
	BT68D7136*	764	-	-	-	-	-	-
	BT68D7830	782	-	-	-	-	-	-
	BT68D7836	793	-	-	-	-	-	-
	BT68D8436	805	-	-	-	-	-	-

ORDERING NOTES:

Add BT before any standard desk model number and apply upcharge. Add 15lbs to standard desk weight for bow top option.

DIMENSION KEY

W - width
D - depth
H - height

CODE DESCRIPTION

4 - full height pedestal
L - left handed pedestal position
R - right handed pedestal position
0 - no pedestal
D - 2 file drawer
F - 2 box, 1 file drawer
BF - break front modesty panel
W - Wire Management Cavity

STANDARD FINISHES

For a complete list of standard wood finishes please see page 247.

MILLENNIUM | TABLE DESKS & CURVILINEAR DESKS

Description	Model	Cherry Walnut Maple	W	D	H	KW	Shipping Weight	Cubic Feet	
	Table Desk	68TD6030	3454	60	30.25	28.5	57	280	38
		68TB6630	3490	65.75	30.25	28.5	63.25	290	41
		68TD7130	3562	71	30.25	28.5	68.25	300	45
		68TD7136*	3566	71	36.25	28.5	68.25	310	54
		68TD8436	3603	84	36.25	28.5	81.25	320	63

ORDERING NOTES:

This item includes a 68PD2116 pencil drawer.

	Table Desk Executive Style	68TDE6630	5045	65.75	36.25	29.5		180	41
		68TDE7136*	5160	71	36.25	29.5		238	54
		68TDE8436	5250	84	36.25	29.5		265	63

ORDERING NOTES:

This item includes a 68PD2116 pencil drawer. Table desk has a clearance height of 25.25". Does not fit a pedestal underneath.

	Bullet Desk with Wood Post Leg	68BD6030	3568	60	30.25	28.5	41.5	156	36
		68BD6630	3641	65.75	30.25	28.5	47.5	174	39
		68BD6636*	3670	65.75	36.25	28.5	44.5	214	46
		68BD7130	3713	71	30.25	28.5	52.5	159	42
		68BD7136	3787	71	36.25	28.5	49.5	232	50



ORDERING NOTES:

Please see page 256 for brushed aluminum tapered post leg option.

	Bullet Desk with 3/4 Modesty Panel & Wood Post Leg	68BD60303LGM	3922	60	30.25	28.5	14.75	189	36
		68BD66303LGM	3962	65.75	30.25	28.5	14.75	159	39
		68BD66364LGM	3996	65.75	36.25	28.5	17.75	229	46
		68BD71303LGM	4024	71	30.25	28.5	14.75	204	42
		68BD71363LGM*	4045	71	36.25	28.5	17.75	247	50
		68BD84303LGM	4068	84	30.25	28.5	14.75	331	49
	68BD84363LGM	4116	84	36.25	28.5	17.75	274	59	

ORDERING PROCEDURE

To order, please specify the following:

- 1) Krug product model number
- 2) Wood species and finish, see page 247
- 3) Wood edge detail- I,H, L or P, see page 250
- 4) Pull style, see page 250
- 5) Grommet location if applicable

*Indicates model illustrated by line drawing.

CODE DESCRIPTION

LGM - wood leg and modesty panel

STANDARD FINISHES

For a complete list of standard wood finishes please see page 247

GROMMETS

One wiring grommet in standard position is optional at no charge. Additional wiring grommets are available at an **upcharge of \$152.**

MILLENNIUM | CURVILINEAR DESKS

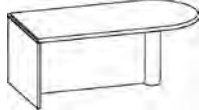
Description	Model	Cherry Walnut Maple	W	D	H	KW	Shipping	
							Weight	Cubic Feet
 Bullet Desk with Full Height Modesty Panel & Wood Post Leg	68BD60304LGM	4044	60	30.25	28.5	14.75	176	36
	68BD66304LGM	4088	65.75	30.25	28.5	14.75	194	39
	68BD66364LGM	4085	65.75	36.25	28.5	14.75	234	46
	68BD71304LGM	4131	71	30.25	28.5	14.75	209	42
	68BD71364LGM*	4160	71	36.25	28.5	17.75	252	50
	68BD84304LGM	4204	84	30.25	28.5	14.75	232	49
	68BD84364LGM	4244	84	36.25	28.5	17.75	279	59

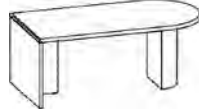
 Bullet Desk with Half Drum Base	68BD6630DB	3996	65.75	30.25	28.5	37.25	194	39
	68BD6636DB	4024	65.75	36.25	28.5	34.25	234	46
	68DB7130DB	4061	71	30.25	28.5	42.5	209	42
	68BD7136DB*	4131	71	36.25	28.5	39.5	252	50
	68BD8430DB	4200	84	30.25	28.5	55.5	232	49
	68BD8436DB	4350	84	36.25	28.5	52.5	279	59
	68BD9636DB	4494	96	36.25	28.5	64.25	320	67

ORDERING NOTES:

All curvilinear post legs are 6" in diameter. Laminate worksurfaces are available at a 10% upcharge.

 Bullet Desk with Half Drum Base & Full Height Modesty Panel	68BD6630DBML	4488	65.75	30.25	28.5	23.25	209	39
	68BD6630DBMR	4488	65.75	30.25	28.5	23.25	209	39
	68BD6636DBML	4515	65.75	36.25	28.5	26.25	249	46
	68BD6636DBMR	4515	65.75	36.25	28.5	26.25	249	46
	68BD7130DBML	4551	71	30.25	28.5	23.25	224	42
	68BD7130DBMR	4551	71	30.25	28.5	23.25	224	42
	68BD7136DBML	4591	71	36.25	28.5	26.25	267	50
	68BD7136DBMR*	4591	71	36.25	28.5	26.25	267	50
	68BD8430DBML	4626	84	30.25	28.5	23.25	247	49
	68BD8430DBMR	4626	84	30.25	28.5	23.25	247	49
	68BD8436DBML	4736	84	36.25	28.5	26.25	294	59
	68BD8436DBMR	4736	84	36.25	28.5	26.25	294	59
	68BD9636DBML	4883	96	36.25	28.5	26.25	335	67
	68BD9636DBMR	4883	96	36.25	28.5	26.25	335	67

ORDERING NOTES:

Please see page 256 for perforated metal modesty panel option.

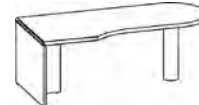
 Curved Corner Bullet Desk with Wood Post Leg	68CCB7130L	4897	71	36.25	28.5	51.25	232	45
	68CCB7130R	4897	71	36.25	28.5	51.25	232	45
	68CCB7830L	4998	78	36.25	28.5	58.25	257	50
	68CCB7830R*	4998	78	36.25	28.5	58.25	257	50
	68CCB8430L	5091	84	36.25	28.5	64.25	268	55
	68CCB8430R	5091	84	36.25	28.5	64.25	268	55



ORDERING NOTES:

Please see page 256 for brushed aluminum tapered post leg option.

DIMENSION KEY

W - width
D - depth
H - height

CODE DESCRIPTION

4 - full height modesty panel
L - half drum base in left-hand position
R - right drum base in right-hand position
DB - half drum base
LGM - wood base and modesty panel
DBM - half drum base and modesty panel

STANDARD FINISHES

For a complete list of standard wood finishes please see page 247.

RETURN OPTIONS

Curved corner bullet desks, "Q" desks, and "K" desks, accept 24" deep run-off units, returns and linking units.

MILLENNIUM | DESKS

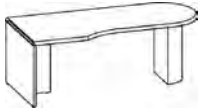
Description	Model	Cherry		W	D	H	KW	Shipping Weight	Cubic Feet
		Walnut	Maple						
	68CCB7130LDB	5235		71	36.25	28.5	51.25	232	45
	68CCB7130RDB	5235		71	36.25	28.5	51.25	232	45
	68CCB7830LDB	5329		78	36.25	28.5	58.25	257	50
	68CCB7830RDB*	5329		78	36.25	28.5	58.25	257	50
	68CCB8430LDB	5429		84	36.25	28.5	64.25	268	55
	68CCB8430RDB	5429		84	36.25	28.5	64.25	268	55

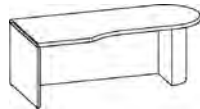
	68CCB7130LDBM	5536		71	36.25	28.5	51.25	232	45
	68CCB7130RDBM	5536		71	36.25	28.5	51.25	232	45
	68CCB7830LDBM	5634		78	36.25	28.5	58.25	257	50
	68CCB7830RDBM*	5634		78	36.25	28.5	58.25	257	50
	68CCB8430LDBM	5745		84	36.25	28.5	64.25	268	55
	68CCB8430RDBM	5745		84	36.25	28.5	64.25	268	55

ORDERING NOTES:

Please see page 256 for perforated metal modesty panel option.

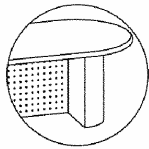

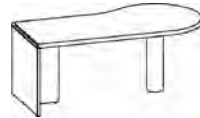
	68PDL7130	4667		71	30	28.5	50	189	50
	68PDR7130*	4667		71	30	28.5	50	189	50
	68PDL7136	4736		71	36	28.5	47.25	232	58
	68PDR7136	4736		71	36	28.5	47.25	232	58



ORDERING NOTES:

Please see page 256 for brushed aluminum tapered post leg option.

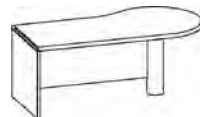
	68PDL71303LGM	4958		71	30	28.5		204	50
	68PDR71303LGM*	4958		71	30	28.5		204	50
	68PDL71363LGM	5084		71	36	28.5		247	58
	68PDR71363LGM	5084		71	36	28.5		247	58
	68PDL84303LGM	5205		84	30	28.5		227	59
	68PDR84303LGM	5205		84	30	28.5		227	59
	68PDL84363LGM	5248		84	36	28.5		274	68
	68PDR84363LGM	5248		84	36	28.5		274	68

ORDERING PROCEDURE

To order, please specify the following:

- 1) Krug product model number
- 2) Wood species and finish, see page 247
- 3) Wood edge detail- I,H, L or P, see page 250
- 4) Pull style, see page 250
- 5) Grommet location if applicable

*Indicates model illustrated by line drawing.

CODE DESCRIPTION

- 4 - full height modesty panel
- L - half drum base in left-hand position
- R - right drum base in right-hand position
- DB - half drum base
- LGM - wood base and modesty panel
- DBM - half drum base and modesty panel

STANDARD FINISHES

For a complete list of standard wood finishes please see page 247.

GROMMETS

One wiring grommet in standard position is optional at no charge. Additional wiring grommets are available at an **upcharge of \$152**

MILLENNIUM | DESKS

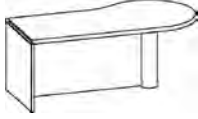
Description	Model	Cherry Walnut Maple			W	D	H	KW	Shipping Weight	Cubic Feet
 'P' Desk with Full Height Modesty Panel & Wood Post Leg	68PDL71304LGM	5071			71	30	28.5		209	50
	68PDR71304LGM*	5071			71	30	28.5		209	50
	68PDL71364LGM	5164			71	36	28.5		252	58
	68PDR71364LGM	5164			71	36	28.5		252	58
	68PDL84304LGM	5338			84	30	28.5		232	59
	68PDR84304LGM	5338			84	30	28.5		232	59
	68PDL84364LGM	5374			84	36	28.5		279	68
	68PDR84364LGM	5374			84	36	28.5		279	68
	68PDL96364LGM	5566			96	30	28.5		320	77
	68PDR96364LGM	5566			96	30	28.5		320	77

 'P' Desk with Half Drum Base	68PDL8430DB	5324			84	36	28.5		232	59
	68PDR8430DB*	5324			84	30	28.5		247	59
	68PDL8436DB	5363			84	30	28.5		279	68
	68PDR8436DB	5363			84	36	28.5		294	68
	68PDL9636DB	5757			96	36	28.5		320	77
	68PDR9636DB	5757			96	36	28.5		335	77

 'P' Desk with Half Drum Base & Full Height Modesty Panel	68PDL8430DBM	5460			84	36	28.5		247	59
	68PDR8430DBM*	5460			84	30	28.5		247	59
	68PDL8436DBM	5815			84	36	28.5		294	68
	68PDR8436DBM	5815			84	36	28.5		294	68
	68PDL9636DBM	6254			96	36	28.5		335	77
	68PDR9636DBM	6254			96	36	28.5		335	77

ORDERING NOTES:

Please see page 256 for perforated metal modesty panel option.

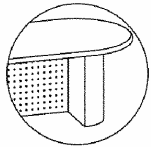

 'Q' Desk with Wood Post Leg	68QDL7130	4667			71	30	28.5	49.5	189	50
	68QDR7130*	4667			71	30	28.5	49.5	189	50
	68QDL8436	4968			84	36	28.5	59.75	232	68
	68QDR8436	4968			84	36	28.5	59.75	232	68



ORDERING NOTES:

Please see page 256 for brushed aluminum tapered post leg option.

DIMENSION KEY

W - width
D - depth
H - height

CODE DESCRIPTION

4 - full height modesty panel
DB - half drum base
LGM - wood base and modesty panel
DBM - half drum base and modesty panel

STANDARD FINISHES

For a complete list of standard wood finishes please see page 247.

RETURN OPTIONS

Curved corner bullet desks, "Q" desks, and "K" desks, accept 24" deep run-off units, returns and linking units.

MILLENNIUM | CURVILINEAR DESKS

Description	Model	Cherry		W	D	H	KW	Shipping Weight	Cubic Feet
		Walnut	Maple						
'Q' Desk with 3/4 Modesty Panel & Wood Post Leg	68QDL71303LGM	5084		71	30	28.5		204	50
	68QDR71303LGM*	5084		71	30	28.5		204	50
	68QDL84363LGM	5248		84	36	28.5		274	68
	68QDR84363LGM	5248		84	36	28.5		274	68

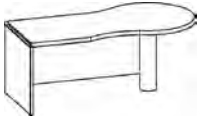

ORDERING NOTES:

All curvilinear posts are 6" in diameter. Laminate worksurfaces are available at a 10% upcharge.

'Q' Desk with Full Height Modesty Panel & Wood Post Leg	68QDL71304LGM	5164		71	30	28.5		269	50
	68QDR71304LGM*	5164		71	30	28.5		269	50
	68QDL84364LGM	5374		84	36	28.5		279	68
	68QDR84364LGM	5374		84	36	28.5		279	68

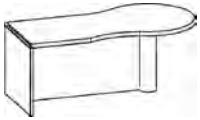

ORDERING NOTES:

All curvilinear posts are 6" in diameter. Laminate worksurfaces are available at a 10% upcharge.

'Q' Desk with Half Drum Base	68QDL8436DB	5363		84	36	28.5	49.5	279	68
	68QDR8436DB*	5363		84	36	28.5	49.5	279	68
	68QDL9636DB	5765		96	36	28.5	59.75	320	68
	68QDR9636DB	5765		96	36	28.5	59.75	320	68

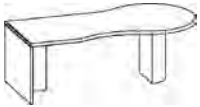

ORDERING NOTES:

Laminate worksurfaces are available at a 10% upcharge.

'Q' Desk with Half Drum Base & Full Height Modesty Panel	68QDL8436DBM	5815		84	36	28.5	46.5	294	68
	68QDR8436DBM*	5815		84	36	28.5	46.5	294	68
	68QDL9636DBM	6254		96	36	28.5	68	335	68
	68QDR9636DBM	6254		96	36	28.5	68	335	68

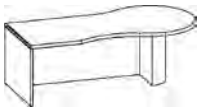

ORDERING NOTES:

Please see page 256 for perforated metal modesty panel option.



'K' Desk with Wood Post Leg	68KDL7130	4667		71	30	28.5	49.5	189	50
	68KDR7130*	4667		71	30	28.5	49.5	189	50
	68KDL8436	4968		84	36	28.5	59.75	232	68
	68KDR8436	4968		84	36	28.5	59.75	232	68

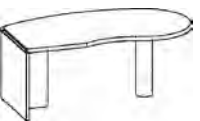

ORDERING NOTES:

Please see page 256 for brushed aluminum tapered post leg option.

ORDERING PROCEDURE

To order, please specify the following:

- 1) Krug product model number
- 2) Wood species and finish, see page 247
- 3) Wood edge detail- I, H, L or P, see page 250
- 4) Pull style, see page 250
- 5) Grommet location if applicable

*Indicates model illustrated by line drawing.

CODE DESCRIPTION

- 3 - 3/4 height modesty panel
- 4 - full height modesty panel
- D - 2 file drawers, 1 file draw
- F - 2 box, 1 file drawer
- DB - half drum base
- LGM - wood base and modesty panel
- DBM - half drum base and modesty panel

STANDARD FINISHES

For a complete list of standard wood finishes please see page 247.

GROMMETS

One wiring grommet in standard position is optional at no charge. Additional wiring grommets are available at an **upcharge of \$152**. See page 251 for more power management information.

MILLENNIUM | CURVILINEAR DESKS

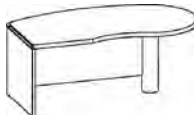
Description	Model	Cherry		W	D	H	KW	Shipping Weight	Cubic Feet
		Walnut	Maple						
 'K' Desk with 3/4 Modesty Panel & Wood Post Leg	68KDL71303LGM	5064		71	30	28.5	49.5	204	50
	68KDR71303LGM*	5064		71	30	28.5	49.5	204	50
	68KDL84363LGM	5248		84	36	28.5	59.75	274	68
	68KDR84363LGM	5248		84	36	28.5	59.75	274	68

 'K' Desk with Full Height Modesty Panel & Wood Post Leg	68KDL71304LGM	5176		71	30	28.5	49.5	209	50
	68KDR71304LGM*	5176		71	30	28.5	49.5	209	50
	68KDL84364LGM	5374		84	36	28.5	59.75	274	68
	68KDR84364LGM	5374		84	36	28.5	59.75	224	68

ORDERING NOTES:

Please see page 256 for perforated metal modesty panel option. Laminate worksurfaces are available at a 10% upcharge. Overhang on the 'K' desk is 23" from the modesty panel.

 'K' Desk with Half Drum Base	68KDL8436DB	5363		84	36	28.5	61.75	279	68
	68KDR8436DB*	5363		84	36	28.5	61.75	279	68
	68KDL9636DB	5765		96	36	28.5	68	320	68
	68KDR9636DB	5765		96	36	28.5	68	320	68

ORDERING NOTES:

Laminate worksurfaces are available at a 10% upcharge. Overhang on the 'K' desk is 23" from the modesty panel.

 'K' Desk with Half Drum Base & Full Height Modesty Panel	68KDL8436DBM	5807		84	36	28.5	61.75	294	68
	68KDR8436DBM*	5807		84	36	28.5	61.75	294	68
	68KDL9636DBM	6254		96	36	28.5	68	335	68
	68KDR9636DBM	6254		96	36	28.5	68	335	68

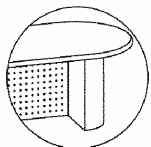

ORDERING NOTES:

Please see page 256 for perforated metal modesty panel option. Laminate worksurfaces are available at a 10% upcharge. Overhang on the 'K' desk is 23" from the modesty panel.

DIMENSION KEY

W - width
D - depth
H - height

CODE DESCRIPTION

3 - 3/4 height modesty panel
4 - full height modesty panel
DB - half drum base
LGM - wood base and modesty panel
DBM - half drum base and modesty panel

STANDARD FINISHES

For a complete list of standard wood finishes please see page 247.

RETURN OPTIONS

Curved corner bullet desks, "Q" desks, and "K" desks, except 24" deep run-off units, returns and linking units.

MILLENNIUM | HEIGHT ADJUSTABLE DESK WORKSURFACES

Description	Model	Cherry	W	D	H	KW	Shipping Weight	Cubic Feet	
		Walnut Maple							
	Electronic Height Adjustable Worksurface	68HA3024ETS	3290	29.75	24	-	17	108.5	11.5
	68HA3624ETS	3321	35.75	24	-	23	109	14	
	68HA4224ETS	3412	41.75	24	-	29	109	16.5	
	68HA4824ETS	3501	47.75	24	-	35	109.5	19	
	68HA5424ETS	3564	53.5	24	-	41	110	21.5	
	68HA6024ETS	3644	59.75	24	-	47	111	24	
	68HA6624ETS	4008	2719	24	-	53	114	26.5	
	68HA7124ETS	4219	71.75	24	-	59	119.5	29	
	68HA7824ETS	4242	77.75	24	-	65	122.5	31.5	
	68HA8424ETS	4566	83.75	24	-	71	127	34	
	68HA3030ETS	4248	29.75	30	-	17	121.5	36.75	
	68HA3630ETS	3620	35.75	30	-	23	122	14.25	
	68HA4230ETS	3687	41.75	30	-	29	122	17.5	
	68HA4830ETS	3771	47.75	30	-	35	122.5	20.5	
	68HA5430ETS	3880	53.5	30	-	41	123	23.5	
	68HA6030ETS	3949	59.75	30	-	47	124	26.5	
	68HA6630ETS	4170	65.75	30	-	53	131	29.75	
	68HA7130ETS*	4381	71.75	30	-	59	132.5	32.75	
	68HA7830ETS	4402	77.75	30	-	65	142.5	35.75	
	68HA8430ETS	4649	83.75	30	-	71	143.5	38.75	
	68HA3036ETS	4322	29.75	36	-	17	121.5	42	
	68HA3636ETS	3693	35.75	36	-	23	122	45.5	
	68HA4236ETS	3939	41.75	36	-	29	122	17.25	
	68HA4836ETS	4019	47.75	36	-	35	122.5	20.75	
	68HA5436ETS	4110	53.5	36	-	41	123	24.5	
	68HA6036ETS	4198	59.75	36	-	47	124	28.25	
	68HA6636ETS	4496	65.75	36	-	53	134	32	
	68HA7136ETS	4542	71.75	36	-	59	151.5	35.5	
68HA7836ETS	4584	77.75	36	-	65	158.5	39.25		
68HA8436ETS	5063	83.75	36	-	71	159.5	43		

ORDERING NOTES:

To order a height adjustable work surface with a top overhang of 16" at one end add O16 to the end of the model number. eg. 68HA6024ETSO16. Please note that this option is not available on height adjustable work surfaces that are 42" or less in length. This option is not available on dual stage electronic height adjustable worksurfaces. To order a dual stage height adjustable base **add \$674 to the list price** and replace ETS with ETD. eg. 68HA6030ETD.

Lifts come standard with an up/down button. Standard colors are Silver Metallic & Black, please contact customer service for other available colors. A 4 position programmable display is available, please see page 303 for price and model number. Standard base is a T-base. A C base can be specified at the same price. To order a C-base on worksurfaces, up to 30" deep only, replace "T" with "C" e.g. 68HA8430ECS

Single stage height adjustable range: 26" - 45.5"

Dual stage height adjustable range: 21" - 47"

Power cord is 10 feet long.

ORDERING PROCEDURE

To order, please specify the following:

- 1) Krug product model number
- 2) Wood species and finish, see page 26
- 3) Wood edge detail- I, H, L or P, see page 264
- 4) Pull style, see page 265
- 5) Grommet location if applicable

*Indicates model illustrated by line drawing.

CODE DESCRIPTION

HA - height adjustable
 E - electric
 T - T- base
 C - C- base
 S - single stage
 D - dual stage
 RH - return top with cross grain
 V21- half height floating wood modesty panel
 V26- half height floating laminate modesty panel

STANDARD FINISHES

For a complete list of standard wood finishes please see page 247.

STORAGE SHELVES

Storage units feature shelves that are adjustable in increments of approximately 1 1/4".

MILLENNIUM | HEIGHT ADJUSTABLE DESK WORKSURFACES

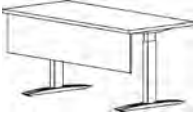
Description	Model	Cherry	W	D	H	KW	Shipping Weight	Cubic Feet
		Walnut Maple						
	68HA3024ETSV21	3638	29.75	24	-	17	114.5	11.5
	68HA3624ETSV21	3739	35.75	24	-	23	117	14
	68HA4224ETSV21	3898	41.75	24	-	29	118	16.5
	68HA4824ETSV21	4059	47.75	24	-	35	119.5	19
	68HA5424ETSV21	4190	53.5	24	-	41	122	21.5
	68HA6024ETSV21	4380	59.75	24	-	47	124	24
	68HA6624ETSV21	4749	65.75	24	-	53	128	26.5
	68HA7124ETSV21	4972	71.75	24	-	59	134.5	29
	68HA7824ETSV21	5009	77.75	24	-	65	139.5	31.5
	68HA8424ETSV21	5349	83.75	24	-	71	145	34
	68HA3030ETSV21	4600	29.75	30	-	17	127.5	36.75
	68HA3630ETSV21	4037	35.75	30	-	23	130	14.25
	68HA4230ETSV21	4176	41.75	30	-	29	131	17.5
	68HA4830ETSV21	4331	47.75	30	-	35	132.5	20.5
	68HA5430ETSV21	4478	53.5	30	-	41	135	23.5
	68HA6030ETSV21	4683	59.75	30	-	47	137	26.5
	68HA6630ETSV21	4906	65.75	30	-	53	145	29.75
	68HA7130ETSV21*	5138	71.75	30	-	59	147.5	32.75
	68HA7830ETSV21	5155	77.75	30	-	65	159.5	35.75
	68HA8430ETSV21	5420	83.75	30	-	71	161.5	38.75
	68HA3036ETSV21	5107	29.75	36	-	17	127.5	42
	68HA3636ETSV21	4041	35.75	36	-	23	130	45.5
	68HA4236ETSV21	4360	41.75	36	-	29	131	17.25
	68HA4836ETSV21	4520	47.75	36	-	35	132.5	20.75
	68HA5436ETSV21	4667	53.5	36	-	41	135	24.5
	68HA6036ETSV21	4933	59.75	36	-	47	137	28.25
	68HA6636ETSV21	5260	65.75	36	-	53	148	32
	68HA7136ETSV21	5298	71.75	36	-	59	166.5	35.5
	68HA7836ETSV21	5366	77.75	36	-	65	175.5	39.25
	68HA8436ETSV21	5903	83.75	36	-	71	177.5	43

ORDERING NOTES:

To order a height adjustable work surface with a top overhang of 16" at one end insert O16 into the model number after ETS. e.g. 68HA6024ETSO16V21. Please note that this option is not available on height adjustable work surfaces that are 42" or less in length. This option is not available on dual stage electronic height adjustable work surfaces.

To order a dual stage height adjustable base add **\$674 to the list price** and replace ETS with ETD. eg. 68HA6030ETDV21.

Lifts come standard with an up/down button. Standard colors are Silver Metallic & Black, please contact customer service for other available colors. A 4 position programmable display is available, please see page 303 for price and model number. Standard base is a T-base. A C base can be specified at the same price. To order a C-base on work surfaces, up to 30" deep only, replace "T" with "C" e.g. 68HA6630ECSV21

Modesty panels are available in low pressure laminate, please replace V21 with V26 for this option. Modesty panels are also available in palette, please replace V21 with V22 for this option.

Single stage height adjustable range: 26" - 45.5"

Dual stage height adjustable range: 21" - 47"

Power cord is 10 feet long.

DIMENSION KEY

W - width
D - depth
H - height

CODE DESCRIPTION

HA - height adjustable
E - electric
T - T- base
C - C- base
S - single stage
D - dual stage
RH - return top with cross grain
V21- half height floating wood modesty panel
V26- half height floating laminate modesty panel

STANDARD FINISHES

For a complete list of standard wood finishes please see page 247.

GLASS DOORS

All storage glass doors come standard with a vertical Massa pull. Other pull options are not available on glass doors.

MILLENNIUM | HEIGHT ADJUSTABLE DESK WORKSURFACES

Description	Model	Cherry			W	D	H	KW	Shipping Weight	Cubic Feet
		Walnut	Maple							
Electronic Height Adjustable Work Surface with Base Enclosure	68HA4224ETSG	5457			41.75	24	-	24	154	16.5
	68HA4824ETSG	5547			47.75	24	-	30	154.5	19
	68HA5424ETSG	5612			53.5	24	-	36	155	21.5
	68HA6024ETSG	5692			59.75	24	-	42	156	24
	68HA6624ETSG	6055			65.75	24	-	48	159	26.5
	68HA7124ETSG	6266			71.75	24	-	54	164.5	29
	68HA7824ETSG	6288			77.75	24	-	60	167.5	31.5
	68HA8424ETSG	6611			83.75	24	-	66	172	34
	68HA4230ETSG	5977			41.75	30	-	24	177	17.5
	68HA4830ETSG	6060			47.75	30	-	30	177.5	20.5
	68HA5430ETSG	6139			53.5	30	-	36	178	23.5
	68HA6030ETSG	6235			59.75	30	-	42	179	26.5
	68HA6630ETSG	6461			65.75	30	-	42	186	29.75
	68HA7130ETSG*	6671			71.75	30	-	54	187.5	32.75
	68HA7830ETSG	6690			77.75	30	-	60	197.5	35.75
	68HA8430ETSG	6939			83.75	30	-	66	198.5	38.75
	68HA4236ETSG	6466			41.75	36	-	24	187	17.25
	68HA4836ETSG	6541			47.75	36	-	30	187.5	20.75
	68HA5436ETSG	6633			53.5	36	-	36	188	24.5
	68HA6036ETSG	6723			59.75	36	-	42	189	28.25
	68HA6636ETSG	7046			65.75	36	-	48	199	32
	68HA7136ETSG	7067			71.75	36	-	54	216.5	35.5
	68HA7836ETSG	7109			77.75	36	-	60	223.5	39.25
	68HA8436ETSG	7587			83.75	36	-	66	224.5	43



ORDERING NOTES:

To order a height adjustable work surface with a top overhang of 16" at one end insert O16 into the model number after ETS. eg. 68HA6024ETSO16G. Please note that this option is not available on height adjustable work surfaces that have base enclosures and are 54" or less in length. This option is not available on dual stage electronic height adjustable worksurfaces.

To order a dual stage height adjustable base **add \$674 to the list price** and replace ESTA with ETD. eg. 68HA6030ETDG.

Lifts come standard with an up/down button. Standard colors are Silver Metallic & Black, please contact customer service for other available colors. A 4 position programmable display is available, please see page 303 for price and model number.

Single stage height adjustable range: 26" - 45.5"

Dual stage height adjustable range: 21" - 47"

Power cord is 10 feet long.

ORDERING PROCEDURE

To order, please specify the following:

- 1) Krug product model number
- 2) Wood species and finish, see page 26
- 3) Wood edge detail- I, H, L or P, see page 264
- 4) Pull style, see page 265
- 5) Grommet location if applicable

*Indicates model illustrated by line drawing.

CODE DESCRIPTION

HA - height adjustable
 E - electric
 T - T- base
 C - C- base
 S - single stage
 D - dual stage
 RH - return top with cross grain
 V21- half height floating wood modesty panel
 V26- half height floating laminate modest panel

STANDARD FINISHES

For a complete list of standard wood finishes please see page 238.

MILLENNIUM | HEIGHT ADJUSTABLE DESK WORKSURFACES

Description	Model	Cherry	W	D	H	KW	Shipping Weight	Cubic Feet
		Walnut Maple						
Electronic Height Adjustable Work Surface with Base Enclosure and Floating Modesty Panel	68HA4224ETSGV21	5760	41.75	24	-	24	163	16.5
	68HA4824ETSGV21	5865	47.75	24	-	30	164.5	19
	68HA5424ETSGV21	5941	53.5	24	-	36	167	21.5
	68HA6024ETSGV21	6042	59.75	24	-	42	169	24
	68HA6624ETSGV21	6421	65.75	24	-	48	173	26.5
	68HA7124ETSGV21	6649	71.75	24	-	54	179.5	29
	68HA7824ETSGV21	6690	77.75	24	-	60	184.5	31.5
	68HA8424ETSGV21	7038	83.75	24	-	66	190	34
	68HA4230ETSGV21	6277	41.75	30	-	24	186	17.5
	68HA4830ETSGV21	6377	47.75	30	-	30	187.5	20.5
	68HA5430ETSGV21	6470	53.5	30	-	36	190	23.5
	68HA6030ETSGV21	6584	59.75	30	-	42	192	26.5
	68HA6630ETSGV21	6823	65.75	30	-	48	200	29.75
	68HA7130ETSGV21*	7053	71.75	30	-	54	202.5	32.75
	68HA7830ETSGV21	7094	77.75	30	-	60	214.5	35.75
	68HA8430ETSGV21	7343	83.75	30	-	66	216.5	38.75
	68HA4236ETSGV21	6766	41.75	36	-	24	196	17.25
	68HA4836ETSGV21	6842	47.75	36	-	30	197.5	20.75
	68HA5436ETSGV21	6948	53.5	36	-	36	200	24.5
	68HA6036ETSGV21	7056	59.75	36	-	42	202	28.25
	68HA6636ETSGV21	7397	65.75	36	-	48	213	32
	68HA7136ETSGV21	7434	71.75	36	-	54	231.5	35.5
	68HA7836ETSGV21	7512	77.75	36	-	60	240.5	39.25
	68HA8436ETSGV21	7806	83.75	36	-	66	242.5	43



ORDERING NOTES:

To order a height adjustable work surface with a top overhang of 16" at one end insert O16 into the model number after ETS. eg. 68HA6024ETSO16GV21. Please note that this option is not available on height adjustable work surfaces that have base enclosures and are 54" or less in length. This option is not available on dual stage electronic height adjustable worksurfaces.

To order a dual stage height adjustable base **add \$674 to the list price** and replace ETS with ETD. eg. 68HA6030ETDGV21. Lifts come standard with an up/down button. Standard colors are Silver Metallic & Black, please contact customer service for other available colors. A 4 position programmable display is available, please see page 303 for price and model number.

Modesty panels are available in low pressure laminate, please replace V21 with V26 for this option. Modesty panels are also available in palette, please replace V21 with V22 for this option.

Single stage height adjustable range: 26" - 45.5"

Dual stage height adjustable range: 21" - 47"

Power cord is 10 feet long.

DIMENSION KEY

W - width
D - depth
H - height

CODE DESCRIPTION

HA - height adjustable
E - electric
T - T- base
C - C- base
S - single stage
D - dual stage
RH - return top with cross grain
V21- half height floating wood modesty panel
V26- half height floating laminate modest panel

STANDARD FINISHES

For a complete list of standard wood finishes please see page 238.

MILLENNIUM | HEIGHT ADJUSTABLE RETURN WORKSURFACES

Description	Model	Cherry		W	D	H	KW	Shipping Weight	Cubic Feet
		Walnut	Maple						
 Electronic Height Adjustable Return Worksurface	68HA4824RHETS	3501		47.75	24	-	35	109.5	19
	68HA5424RHETS	3564		53.5	24	-	41	110	21.5
	68HA6024RHETS	3644		59.75	24	-	47	111	24
	68HA6624RHETS	4008		27.19	24	-	53	114	26.5
	68HA7124RHETS	4219		71.75	24	-	59	119.5	29
	68HA7824RHETS	4242		77.75	24	-	65	122.5	31.5
	68HA8424RHETS	4566		83.75	24	-	71	127	34
	68HA4830RHETS	3771		47.75	30	-	35	122.5	20.5
	68HA5430RHETS	3880		53.5	30	-	41	123	23.5
	68HA6030RHETS	3949		59.75	30	-	47	124	26.5
68HA6630RHETS	4170		65.75	30	-	53	131	29.75	
68HA7130RHETS*	4381		71.75	30	-	59	132.5	32.75	
68HA7830RHETS	4402		77.75	30	-	65	142.5	35.75	
68HA8430RHETS	4649		83.75	30	-	71	143.5	38.75	
68HA4836RHETS	3939		47.75	36	-	35	122.5	20.75	
68HA5436RHETS	4019		53.5	36	-	41	123	24.5	
68HA6036RHETS	4110		59.75	36	-	47	124	28.25	
68HA6636RHETS	4198		65.75	36	-	53	134	32	
68HA7136RHETS	4496		71.75	36	-	59	151.5	35.5	
68HA7836RHETS	4542		77.75	36	-	65	158.5	39.25	
68HA8436RHETS	4584		83.75	36	-	71	159.5	43	

ORDERING NOTES:

To order a height adjustable work surface with a top overhang of 16" at one end add O16 to the end of the model number. eg. 68HA6024ETSO16. Please note that this option is not available on height adjustable work surfaces that are 42" or less in length. This option is not available on dual stage electronic height adjustable worksurfaces. To order a dual stage height adjustable base **add \$674 to the list price** and replace ETS with ETD. eg. 68HA6030ETD.

Lifts come standard with an up/down button. Standard colors are Silver Metallic & Black, please contact customer service for other available colors. A 4 position programmable display is available, please see page 303 for price and model number. . Standard base is a T-base. A C base can be specified at the same price. To order a C-base on worksurfaces, up to 30" deep only, replace "T" with "C" e.g. 68HA8430ECS

Single stage height adjustable range: 26" - 45.5"

Dual stage height adjustable range: 21" - 47"

Power cord is 10 feet long.

ORDERING PROCEDURE

To order, please specify the following:

- 1) Krug product model number
- 2) Wood species and finish, see page 247
- 3) Wood edge detail- I,H, L or P, see page 250
- 4) Pull style, see page 250
- 5) Grommet location if applicable

*Indicates model illustrated by line drawing.

CODE DESCRIPTION

HA - height adjustable
 RH - return (cross grain)
 E - electric
 T - T- base
 C - C- base
 S - single stage
 D - dual stage

STANDARD FINISHES

For a complete list of standard wood finishes please see page 247.

STORAGE SHELVES

Storage units feature shelves that are adjustable in increments of approximately 1 1/4".

MILLENNIUM | HEIGHT ADJUSTABLE RETURN WORKSURFACES

Description	Model	Cherry	W	D	H	KW	Shipping Weight	Cubic Feet
		Walnut Maple						
	68HA4824RHETSV21	4059	47.75	24	-	35	119.5	19
	68HA5424RHETSV21	4190	53.5	24	-	41	122	21.5
	68HA6024RHETSV21	4380	59.75	24	-	47	124	24
	68HA6624RHETSV21	4749	65.75	24	-	53	128	26.5
	68HA7124RHETSV21	4972	71.75	24	-	59	134.5	29
	68HA7824RHETSV21	5009	77.75	24	-	65	139.5	31.5
	68HA8424RHETSV21	5349	83.75	24	-	71	145	34
	68HA4830RHETSV21	4331	47.75	30	-	35	132.5	20.5
	68HA5430RHETSV21	4478	53.5	30	-	41	135	23.5
	68HA6030RHETSV21	4683	59.75	30	-	47	137	26.5
	68HA6630RHETSV21	4906	65.75	30	-	53	145	29.75
	68HA7130RHETSV21*	5138	71.75	30	-	59	147.5	32.75
	68HA7830RHETSV21	4402	77.75	30	-	65	159.5	35.75
	68HA8430RHETSV21	5420	83.75	30	-	71	161.5	38.75
	68HA4836RHETSV21	4520	47.75	36	-	35	132.5	20.75
	68HA5436RHETSV21	4667	53.5	36	-	41	135	24.5
	68HA6036RHETSV21	4933	59.75	36	-	47	137	28.25
	68HA6636RHETSV21	5260	65.75	36	-	53	148	32
68HA7136RHETSV21	5298	71.75	36	-	59	166.5	35.5	
68HA7836RHETSV21	5366	77.75	36	-	65	175.5	39.25	
68HA8436RHETSV21	5903	83.75	36	-	71	177.5	43	

ORDERING NOTES:

To order a height adjustable work surface with a top overhang of 16" at one end insert O16 into the model number after ETS. eg. 68HA6024ETSO16V21. Please note that this option is not available on height adjustable work surfaces that are 42" or less in length. This option is not available on dual stage electronic height adjustable work surfaces.

To order a dual stage height adjustable base **add \$674 to the list price** and replace ETS with ETD. eg. 68HA6030ETDV21. .

Lifts come standard with an up/down button. Standard colors are Silver Metallic & Black, please contact customer service for other available colors. A 4 position programmable display is available, please see page 303 for price and model number. Standard base is a T-base. A C base can be specified at the same price. To order a C-base on work surfaces, up to 30" deep only, replace "T" with "C" e.g. 68HA6630ECSV21

Modesty panels are available in low pressure laminate, please replace V21 with V26 for this option. e.g. 68HA6030ETSV26.

Please see page 373 for Low-Pressure Laminate options.

Single stage height adjustable range: 26" - 45.5"

Dual stage height adjustable range: 21" - 47"

Power cord is 10 feet long.

DIMENSION KEY

W - width
D - depth
H - height

CODE DESCRIPTION

HA - height adjustable
RH - return (cross grain)
E - electric
T - T- base
C - C- base
S - single stage
D - dual stage
V21 - 1/2 height floating wood modesty panel

STANDARD FINISHES

For a complete list of standard wood finishes please see page 247.

GLASS DOORS

All storage glass doors come standard with a vertical Massa pull. Other pull options are not available on glass doors.

MILLENNIUM | HEIGHT ADJUSTABLE RETURN WORKSURFACES

Description	Model	Cherry		W	D	H	KW	Shipping Weight	Cubic Feet
		Walnut	Maple						
 Electronic Height Adjustable Return Worksurface with Base Enclosure	68HA4824RHETSG	5547		47.75	24	-	30	154.5	19
	68HA5424RHETSG	5612		53.5	24	-	36	155	21.5
	68HA6024RHETSG	5692		59.75	24	-	42	156	24
	68HA6624RHETSG	6055		65.75	24	-	48	159	26.5
	68HA7124RHETSG	6266		71.75	24	-	54	164.5	29
	68HA7824RHETSG	6288		77.75	24	-	60	167.5	31.5
	68HA8424RHETSG	6611		83.75	24	-	66	172	34
	68HA4830RHETSG	6060		47.75	30	-	30	177.5	20.5
	68HA5430RHETSG	6139		53.5	30	-	36	178	23.5
	68HA6030RHETSG	6235		59.75	30	-	42	179	26.5
	68HA6630RHETSG	6461		65.75	30	-	42	186	29.75
	68HA7130RHETSG*	6671		71.75	30	-	54	187.5	32.75
	68HA7830RHETSG	6690		77.75	30	-	60	197.5	35.75
	68HA8430RHETSG	6939		83.75	30	-	66	198.5	38.75
	68HA4836RHETSG	6541		47.75	36	-	30	187.5	20.75
	68HA5436RHETSG	6633		53.5	36	-	36	188	24.5
	68HA6036RHETSG	6723		59.75	36	-	42	189	28.25
	68HA6636RHETSG	7046		65.75	36	-	48	199	32
68HA7136RHETSG	7067		71.75	36	-	54	216.5	35.5	
68HA7836RHETSG	7109		77.75	36	-	60	223.5	39.25	
68HA8436RHETSG	7587		83.75	36	-	66	224.5	43	

ORDERING NOTES:

To order a height adjustable work surface with a top overhang of 16" at one end insert O16 into the model number after ETS. e.g. 68HA6024ETSO16G. Please note that this option is not available on height adjustable work surfaces that have base enclosures and are 54" or less in length. This option is not available on dual stage electronic height adjustable worksurfaces.

To order a dual stage height adjustable base **add \$674 to the list price** and replace ESTA with ETD. eg. 68HA6030ETDG. .

Lifts come standard with an up/down button. Standard colors are Silver Metallic & Black, please contact customer service for other available colors. A 4 position programmable display is available, please see page 303 for price and model number.

Single stage height adjustable range: 26" - 45.5"

Dual stage height adjustable range: 21" - 47"

Power cord is 10 feet long.

ORDERING PROCEDURE

To order, please specify the following:

- 1) Krug product model number
- 2) Wood species and finish, see page 247
- 3) Wood edge detail- I,H, L or P, see page 250
- 4) Pull style, see page 250
- 5) Grommet location if applicable

*Indicates model illustrated by line drawing.

CODE DESCRIPTION

HA - height adjustable
 RH - return (cross grain)
 E - electric
 T - T- base
 C - C- base
 S - single stage
 D - dual stage

STANDARD FINISHES

For a complete list of standard wood finishes please see page 247.

MILLENNIUM | HEIGHT ADJUSTABLE RETURN WORKSURFACES

Description	Model	Cherry		W	D	H	KW	Shipping Weight	Cubic Feet
		Walnut	Maple						
Electronic Height Adjustable Return Worksurface with Base Enclosure and Floating Modesty Panel	68HA4824RHETSGV21	5865		47.75	24	-	30	164.5	19
	68HA5424RHETSGV21	5941		53.5	24	-	36	167	21.5
	68HA6024RHETSGV21	6042		59.75	24	-	42	169	24
	68HA6624RHETSGV21	6421		65.75	24	-	48	173	26.5
	68HA7124RHETSGV21	6649		71.75	24	-	54	179.5	29
	68HA7824RHETSGV21	6690		77.75	24	-	60	184.5	31.5
	68HA8424RHETSGV21	7038		83.75	24	-	66	190	34
	68HA4830RHETSGV21	6377		47.75	30	-	30	187.5	20.5
	68HA5430RHETSGV21	6470		53.5	30	-	36	190	23.5
	68HA6030RHETSGV21	6584		59.75	30	-	42	192	26.5
	68HA6630RHETSGV21	6823		65.75	30	-	48	200	29.75
	68HA7130RHETSGV21*	7053		71.75	30	-	54	202.5	32.75
	68HA7830RHETSGV21	7094		77.75	30	-	60	214.5	35.75
	68HA8430RHETSGV21	7343		83.75	30	-	66	216.5	38.75
	68HA4836RHETSGV21	6842		47.75	36	-	30	197.5	20.75
	68HA5436RHETSGV21	6948		53.5	36	-	36	200	24.5
	68HA6036RHETSGV21	7056		59.75	36	-	42	202	28.25
68HA6636RHETSGV21	7397		65.75	36	-	48	213	32	
68HA7136RHETSGV21	7434		71.75	36	-	54	231.5	35.5	
68HA7836RHETSGV21	7512		77.75	36	-	60	240.5	39.25	
68HA8436RHETSGV21	7806		83.75	36	-	66	242.5	43	

ORDERING NOTES:

To order a height adjustable work surface with a top overhang of 16" at one end insert O16 into the model number after ETS. eg. 68HA6024ETSO16GV21. Please note that this option is not available on height adjustable work surfaces that have base enclosures and are 54" or less in length. This option is not available on dual stage electronic height adjustable work surfaces.

To order a dual stage height adjustable base **add \$674 to the list price** and replace ETS with ETD. eg. 68HA6030ETDGV21. Lifts come standard with an up/down button. Standard colors are Silver Metallic & Black, please contact customer service for other available colors. A 4 position programmable display is available, please see page 303 for price and model number.

Modesty panels are available in low pressure laminate, please replace V21 with V26 for this option. e.g. 68HA6030ETSGV26.

Please see page 373 for Low-Pressure Laminate options.

Modesty panels are also available in palette, please replace V21 with V22 for this option. e.g. 68HA6030ETSGV22..

Single stage height adjustable range: 26" - 45.5"

Dual stage height adjustable range: 21" - 47"

Power cord is 10 feet long.

DIMENSION KEY

W - width
D - depth
H - height

CODE DESCRIPTION

HA - height adjustable
RH - return (cross grain)
E - electric
T - T- base
C - C- base
S - single stage
D - dual stage
V21 - 1/2 height floating wood modesty panel

STANDARD FINISHES

For a complete list of standard wood finishes please see page 247.

MILLENNIUM | RETURNS

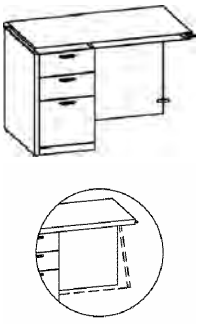
Description	Model	Cherry		W	D	H	KW	Shipping Weight	Cubic Feet
		Walnut	Maple						
Return, Desk Height with Full Height Pedestal	68RH3620L4D	3958		36	20.25	28.5	19.5	101	15
	68RH3620L4F	3958		36	20.25	28.5	19.5	101	15
	68RH3620R4D	3958		36	20.25	28.5	19.5	101	15
	68RH3620R4F	3958		36	20.25	28.5	19.5	101	15
	68RH3624L4D	3993		36	24.25	28.5	19.5	115	18
	68RH3624L4F	3993		36	24.25	28.5	19.5	115	18
	68RH3624R4D	3993		36	24.25	28.5	19.5	115	18
	68RH3624R4F	3993		36	24.25	28.5	19.5	115	18
	68RH3630L4D	4027		36	30.25	28.5	19.5	136	21
	68RH3630L4F	4027		36	30.25	28.5	19.5	136	21
	68RH3630R4D	4027		36	30.25	28.5	19.5	136	21
	68RH3630R4F	4027		36	30.25	28.5	19.5	136	21
	68RH4220L4D	4024		42	20.25	28.5	25.5	113	17
	68RH4220L4F	4024		42	20.25	28.5	25.5	113	17
	68RH4220R4D	4024		42	20.25	28.5	25.5	113	17
	68RH4220R4F	4024		42	20.25	28.5	25.5	113	17
	68RH4224L4D	4088		42	24.25	28.5	25.5	129	20
	68RH4224L4F*	4088		42	24.25	28.5	25.5	129	20
	68RH4224R4D	4088		42	24.25	28.5	25.5	129	20
	68RH4224R4F	4088		42	24.25	28.5	25.5	129	20
	68RH4230L4D	4108		42	30.25	28.5	25.5	154	25
	68RH4230L4F	4108		42	30.25	28.5	25.5	154	25
	68RH4230R4D	4108		42	30.25	28.5	25.5	154	25
	68RH4230R4F	4108		42	30.25	28.5	25.5	154	25
	68RH4820L4D	4138		48	20.25	28.5	31.5	125	20
	68RH4820L4F	4138		48	20.25	28.5	31.5	125	20
	68RH4820R4D	4138		48	20.25	28.5	31.5	125	20
	68RH4820R4F	4138		48	20.25	28.5	31.5	125	20
	68RH4824L4D	4139		48	24.25	28.5	31.5	144	23
	68RH4824L4F	4139		48	24.25	28.5	31.5	144	23
	68RH4824R4D	4139		48	24.25	28.5	31.5	144	23
	68RH4824R4F	4139		48	24.25	28.5	31.5	144	23
68RH4830L4D	4160		48	30.25	28.5	31.5	172	29	
68RH4830L4F	4160		48	30.25	28.5	31.5	172	29	
68RH4830R4D	4160		48	30.25	28.5	31.5	172	29	
68RH4830R4F	4160		48	30.25	28.5	31.5	172	29	
68RH5420L4D	4171		54	20.25	28.5	37.5	137	22	
68RH5420L4F	4171		54	20.25	28.5	37.5	137	22	
68RH5420R4D	4171		54	20.25	28.5	37.5	137	22	
68RH5420R4F	4171		54	20.25	28.5	37.5	137	22	
68RH5424L4D	4205		54	24.25	28.5	37.5	158	15	
68RH5424L4F	4205		54	24.25	28.5	37.5	158	15	
68RH5424R4D	4205		54	24.25	28.5	37.5	158	15	
68RH5424R4F	4205		54	24.25	28.5	37.5	158	15	
68RH5430L4D	4264		54	30.25	28.5	37.5	190	18	
68RH5430L4F	4264		54	30.25	28.5	37.5	190	18	
68RH5430R4D	4264		54	30.25	28.5	37.5	190	18	
68RH5430R4F	4264		54	30.25	28.5	37.5	190	18	

ORDERING NOTES:

Please see page 256 for wire management cut-out option and for hinged modesty panel option. Laminate worksurfaces are available at a 10% upcharge. For reverse grain direction on returns use list price and note Reverse Grain on p.o.

ORDERING PROCEDURE

To order, please specify the following:

- 1) Krug product model number
- 2) Wood species and finish, see page 247
- 3) Wood edge detail- I, H, L or P, see page 250
- 4) Pull style, see page 250
- 5) Grommet location if applicable

*Indicates model illustrated by line drawing.

CODE DESCRIPTION

- 4 - full height pedestal
- L - left handed pedestal position
- R - right handed pedestal position
- D - 2 file drawer
- F - 2 box, 1 file drawer

STANDARD FINISHES

For a complete list of standard wood finishes please see page 247.

GROMMETS

One wiring grommet in standard position is optional at no charge. Additional wiring grommets are available at **an upcharge of \$152.**

MILLENNIUM | RETURNS

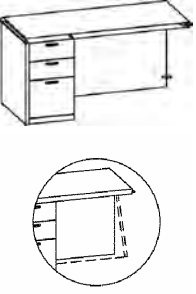
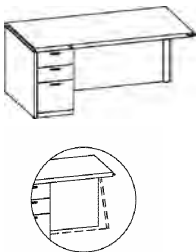
Description	Model	Cherry		W	D	H	KW	Shipping Weight	Cubic Feet
		Walnut	Maple						
Return, Desk Height with Full Height Pedestal 	68RH6020L4D	4327		60	20.25	28.5	43.5	147	17
	68RH6020L4F	4327		60	20.25	28.5	43.5	147	17
	68RH6020R4D	4327		60	20.25	28.5	43.5	147	17
	68RH6020R4F	4327		60	20.25	28.5	43.5	147	17
	68RH6024L4D	4395		60	24.25	28.5	43.5	170	20
	68RH6024L4F	4395		60	24.25	28.5	43.5	170	20
	68RH6024R4D	4395		60	24.25	28.5	43.5	170	20
	68RH6024R4F	4395		60	24.25	28.5	43.5	170	20
	68RH6030L4D	4512		60	30.25	28.5	43.5	205	20
	68RH6030L4F*	4512		60	30.25	28.5	43.5	205	20
	68RH6030R4D	4512		60	30.25	28.5	43.5	205	20
	68RH6030R4F	4512		60	30.25	28.5	43.5	205	20
	68RH6620L4D	4606		65.75	20.25	28.5	49.25	159	23
	68RH6620L4F	4606		65.75	20.25	28.5	49.25	159	23
	68RH6620R4D	4606		65.75	20.25	28.5	49.25	159	23
	68RH6620R4F	4606		65.75	20.25	28.5	49.25	159	23
	68RH6624L4D	4669		65.75	24.25	28.5	49.25	184	22
	68RH6624L4F	4669		65.75	24.25	28.5	49.25	184	22
	68RH6624R4D	4669		65.75	24.25	28.5	49.25	184	22
	68RH6624R4F	4669		65.75	24.25	28.5	49.25	184	22
	68RH6630L4D	4722		65.75	30.25	28.5	49.25	223	26
	68RH6630L4F	4722		65.75	30.25	28.5	49.25	223	26
	68RH6630R4D	4722		65.75	30.25	28.5	49.25	223	26
	68RH6630R4F	4722		65.75	30.25	28.5	49.25	223	26
	68RH7124L4D	4813		71	24.25	28.5	54.5	227	34
	68RH7124L4F	4813		71	24.25	28.5	54.5	227	34
	68RH7124R4D	4813		71	24.25	28.5	54.5	227	34
	68RH7124R4F	4813		71	24.25	28.5	54.5	227	34
	68RH7130L4D	4853		71	30.25	28.5	54.5	268	42
	68RH7130L4F	4853		71	30.25	28.5	54.5	268	42
	68RH7130R4D	4853		71	30.25	28.5	54.5	268	42
	68RH7130R4F	4853		71	30.25	28.5	54.5	268	42
	68RH8424L4D	4932		83.75	24.25	28.5	67.5	227	34
	68RH8424L4F	4932		83.75	24.25	28.5	67.5	227	34
	68RH8424R4D	4932		83.75	24.25	28.5	67.5	227	34
	68RH8424R4F	4932		83.75	24.25	28.5	67.5	227	34
	68RH8430L4D	4980		83.75	30.25	28.5	67.5	260	50
	68RH8430L4F	4980		83.75	30.25	28.5	67.5	260	50
	68RH8430R4D	4980		83.75	30.25	28.5	67.5	260	50
	68RH8430R4F	4980		83.75	30.25	28.5	67.5	260	50
Return, Desk Height & Depth with Full Height Pedestal 	68RD6636L4D	5005		65.75	36.25	28.5	48.75	255	42
	68RD6636L4F*	5005		65.75	36.25	28.5	48.75	255	42
	68RD6636R4D	5005		65.75	36.25	28.5	48.75	255	42
	68RD6636R4F	5005		65.75	36.25	28.5	48.75	255	42
	68RD7136L4D	5112		71	36.25	28.5	54.5	252	50
	68RD7136L4F	5112		71	36.25	28.5	54.5	252	50
	68RD7136R4D	5112		71	36.25	28.5	54.5	252	50
	68RD7136R4F	5112		71	36.25	28.5	54.5	252	50
	68RD8436L4D	5318		83.75	36.25	28.5	67.5	270	60
	68RD8436L4F	5318		83.75	36.25	28.5	67.5	270	60
	68RD8436R4D	5318		83.75	36.25	28.5	67.5	270	60
	68RD8436R4F	5318		83.75	36.25	28.5	67.5	270	60

ORDERING NOTES: For reverse grain direction on returns use list price and note Reverse Grain on p.o.

DIMENSION KEY

W - width
D - depth
H - height

CODE DESCRIPTION

4 - full height pedestal
L - left handed pedestal position
R - right handed pedestal position
D - 2 file drawer
F - 2 box, 1 file drawer



STANDARD FINISHES

For a complete list of standard wood finishes please see page 247.

OPEN/DESK RETURNS

Open returns can be found in the shell section on page 298. Desk depth returns have a recessed modesty panel.

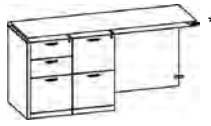
MILLENNIUM | RETURNS

Description	Model	Cherry		W	D	H	KW	Shipping Weight	Cubic Feet
		Walnut	Maple						
Return, Full Height	68RH6020L4DD**	5548		60	20.25	28.5	28.5	179	25
Ganged Pedestals	68RH6020L4DF*	5548		60	20.25	28.5	28.5	179	25
	68RH6020L4FD	5548		60	20.25	28.5	28.5	179	25
	68RH6020L4FF	5548		60	20.25	28.5	28.5	179	25
	68RH6020R4DD	5548		60	20.25	28.5	28.5	179	25
	68RH6020R4DF	5548		60	20.25	28.5	28.5	179	25
	68RH6020R4FD	5548		60	20.25	28.5	28.5	179	25
	68RH6020R4FF	5548		60	20.25	28.5	28.5	179	25
	68RH6024L4DD	5586		60	24.25	28.5	28.5	202	29
	68RH6024L4DF	5586		60	24.25	28.5	28.5	202	29
	68RH6024L4FD	5586		60	24.25	28.5	28.5	202	29
	68RH6024L4FF	5586		60	24.25	28.5	28.5	202	29
	68RH6024R4DD	5586		60	24.25	28.5	28.5	202	29
	68RH6024R4DF	5586		60	24.25	28.5	28.5	202	29
	68RH6024R4FD	5586		60	24.25	28.5	28.5	202	29
	68RH6024R4FF	5586		60	24.25	28.5	28.5	202	29
	68RH6030L4DD	5605		60	30.25	28.5	28.5	237	36
	68RH6030L4DF	5605		60	30.25	28.5	28.5	237	36
	68RH6030L4FD	5605		60	30.25	28.5	28.5	237	36
	68RH6030L4FF	5605		60	30.25	28.5	28.5	237	36
	68RH6030R4DD	5605		60	30.25	28.5	28.5	237	36
	68RH6030R4DF	5605		60	30.25	28.5	28.5	237	36
	68RH6030R4FD	5605		60	30.25	28.5	28.5	237	36
	68RH6030R4FF	5605		60	30.25	28.5	28.5	237	36
	68RH6620L4DD	5631		65.75	20.25	28.5	34.25	191	27
	68RH6620L4DF	5631		65.75	20.25	28.5	34.25	191	27
	68RH6620L4FD*	5631		65.75	20.25	28.5	34.25	191	27
	68RH6620L4FF	5631		65.75	20.25	28.5	34.25	191	27
	68RH6620R4DD	5631		65.75	20.25	28.5	34.25	191	27
	68RH6620R4DF	5631		65.75	20.25	28.5	34.25	191	27
	68RH6620R4FD	5631		65.75	20.25	28.5	34.25	191	27
	68RH6620R4FF	5631		65.75	20.25	28.5	34.25	191	27
	68RH6624L4DD	5673		65.75	24.25	28.5	34.25	216	32
	68RH6624L4DF	5673		65.75	24.25	28.5	34.25	216	32
	68RH6624L4FD	5673		65.75	24.25	28.5	34.25	216	32
	68RH6624L4FF	5673		65.75	24.25	28.5	34.25	216	32
	68RH6624R4DD	5673		65.75	24.25	28.5	34.25	216	32
	68RH6624R4DF	5673		65.75	24.25	28.5	34.25	216	32
	68RH6624R4FD	5673		65.75	24.25	28.5	34.25	216	32
	68RH6624R4FF	5673		65.75	24.25	28.5	34.25	216	32
	68RH6630L4DD	5692		65.75	30.25	28.5	34.25	255	39
	68RH6630L4DF	5692		65.75	30.25	28.5	34.25	255	39
	68RH6630L4FD	5692		65.75	30.25	28.5	34.25	255	39
	68RH6630L4FF	5692		65.75	30.25	28.5	34.25	255	39
	68RH6630R4DD	5692		65.75	30.25	28.5	34.25	255	39
	68RH6630R4DF	5692		65.75	30.25	28.5	34.25	255	39
	68RH6630R4FD	5692		65.75	30.25	28.5	34.25	255	39
	68RH6630R4FF	5692		65.75	30.25	28.5	34.25	255	39
	68RH7124L4DD	5741		71	24.25	28.5	39.5	227	34
	68RH7124L4DF	5741		71	24.25	28.5	39.5	227	34

ORDERING NOTES:

Please see page 256 for wire management cut-out option and for hinged modesty panel option. Laminate work-surfaces are available at a 10% upcharge.

ORDERING PROCEDURE

To order, please specify the following:

- 1) Krug product model number
- 2) Wood species and finish, see page 247
- 3) Wood edge detail- I, H, L or P, see page 250
- 4) Pull style, see page 250
- 5) Grommet location if applicable

*Indicates model illustrated by line drawing.

CODE DESCRIPTION

- 4 - full height pedestal
- L - left handed pedestal position
- R - right handed pedestal position
- D - 2 file drawer
- F - 2 box, 1 file drawer

STANDARD FINISHES

For a complete list of standard wood finishes please see page 247.

GROMMETS

One wiring grommet in standard position is optional at no charge. Additional wiring grommets are available at an **upcharge of \$152.**

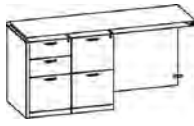
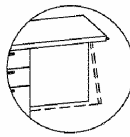
Description	Model	Cherry Walnut Maple			W	D	H	KW	Shipping Weight	Cubic Feet
Return, Full Height	68RH7124L4FD	5741			71	24.25	28.5	39.5	227	34
Ganged Pedestals	68RH7124L4FF	5741			71	24.25	28.5	39.5	227	34
Continued	68RH7124R4DD	5741			71	24.25	28.5	39.5	227	34
	68RH7124R4DF	5741			71	24.25	28.5	39.5	227	34
	68RH7124R4FD	5741			71	24.25	28.5	39.5	227	34
	68RH7124R4FF	5741			71	24.25	28.5	39.5	227	34
	68RH7130L4DD	5812			71	30.25	28.5	39.5	268	42
	68RH7130L4DF	5812			71	30.25	28.5	39.5	268	42
	68RH7130L4FD	5812			71	30.25	28.5	39.5	268	42
	68RH7130L4FF	5812			71	30.25	28.5	39.5	268	42
	68RH7130R4DD	5812			71	30.25	28.5	39.5	268	42
	68RH7130R4DF	5812			71	30.25	28.5	39.5	268	42
	68RH7130R4FD*	5812			71	30.25	28.5	39.5	268	42
	68RH7130R4FF	5812			71	30.25	28.5	39.5	268	42
	68RH8424L4DD	5912			83.75	24.25	28.5	52.5	260	40
	68RH8424L4DF	5912			83.75	24.25	28.5	52.5	260	40
	68RH8424L4FD	5912			83.75	24.25	28.5	52.5	260	40
	68RH8424L4FF	5912			83.75	24.25	28.5	52.5	260	40
	68RH8424R4DD	5912			83.75	24.25	28.5	52.5	260	40
	68RH8424R4DF	5912			83.75	24.25	28.5	52.5	260	40
	68RH8424R4FD	5912			83.75	24.25	28.5	52.5	260	40
	68RH8424R4FF	5912			83.75	24.25	28.5	52.5	260	40
	68RH8430L4DD	5965			83.75	30.25	28.5	52.5	309	50
	68RH8430L4DF	5965			83.75	30.25	28.5	52.5	309	50
	68RH8430L4FD	5965			83.75	30.25	28.5	52.5	309	50
	68RH8430L4FF	5965			83.75	30.25	28.5	52.5	309	50
	68RH8430R4DD	5965			83.75	30.25	28.5	52.5	309	50
	68RH8430R4DF	5965			83.75	30.25	28.5	52.5	309	50
	68RH8430R4FD	5965			83.75	30.25	28.5	52.5	309	50
	68RH8430R4FF	5965			83.75	30.25	28.5	52.5	309	50

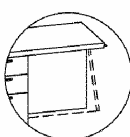
Return, Lateral File Pedestal  	68RH6024LLF*	5314			60	24.25	28.5	24	218	29
	68RH6024RLF	5314			60	24.25	28.5	24	218	29
	68RH7124LLF	5363			71	24.25	28.5	35	243	34
	68RH7124RLF	5363			71	24.25	28.5	35	243	34
	68RH8424LLF	5428			84	24.25	28.5	48	279	36
	68RH8424RLF	5428			84	24.25	28.5	48	279	36

ORDERING NOTES:

Please see page 256 for wire management cut-out option and for hinged modesty panel option. Laminate work-surfaces are available at a 10% upcharge. For reverse grain direction on returns use list price and note Reverse Grain on p.o.

DIMENSION KEY

W - width
D - depth
H - height

CODE DESCRIPTION

4 - full height pedestal
L - left handed pedestal position
R - right handed pedestal position
D - 2 file drawer
F - 2 box, 1 file drawer

STANDARD FINISHES

For a complete list of standard wood finishes please see page 247.

OPEN/DESK RETURNS

Open returns can be found in the shell section on page 298. Desk depth returns have a recessed modesty panel.

MILLENNIUM | RETURNS

Description	Model	Cherry Walnut Maple	W	D	H	KW	Shipping Weight	Cubic Feet
 Bullet Return with Post Leg	68BR6030*	2265	60	30.25	28.5		131	4
	68BR6630	2304	65.75	30.25	28.5		149	4
	68BR6636	2321	65.75	36.25	28.5		189	5
	68BR7130	2373	71	30.25	28.5		164	4
	68BR7136	2451	71	36.25	28.5		207	4

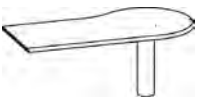
 P' Return with Post Leg	68PRL7130	3242	71	30	28.5	48.6	184	50
	68PRR7130*	3242	71	30	28.5	48.6	184	50
	68PRL7136	3397	71	36	28.5	48.6	227	58
	68PRR7136	3397	71	36	28.5	48.6	227	58
	68PRL8430	3714	84	30	28.5	65.25	207	59
	68PRR8430	3714	84	30	28.5	65.25	207	59
	68PRL8436	3839	84	36	28.5	62.5	254	68
68PRR8436	3839	84	36	28.5	62.5	254	68	

ORDERING NOTES:

Please see page 256 for brushed aluminum tapered post leg option.

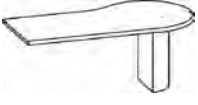
 P' Return with Half Drum Base	68PRL7130DB	3628	71	30	28.5	48.6	184	50
	68PRR7130DB*	3628	71	30	28.5	48.6	184	50
	68PRL7136DB	3787	71	36	28.5	48.6	227	58
	68PRR7136DB	3787	71	36	28.5	48.6	227	58
	68PRL8430DB	4105	84	30	28.5	65.25	207	59
	68PRR8430DB	4105	84	30	28.5	65.25	207	59
	68PRL8436DB	4224	84	36	28.5	62.5	254	68
	68PRR8436DB	4224	84	36	28.5	62.5	254	68
	68PRL9630DB	4411	96	30	28.5	70.75	241	74
	68PRR9630DB	4411	96	30	28.5	70.75	241	74
	68PRL9636DB	4782	96	36	28.5	68	295	77
	68PRR9636DB	4782	96	36	28.5	68	295	77

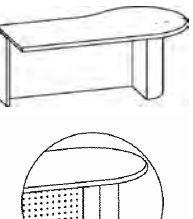
 'P' Return with Half Drum Base & Full Modesty Panel	68PRL7130DBM	4862	71	30	28.5	48.6	204	50
	68PRR7130DBM*	4862	71	30	28.5	48.6	204	50
	68PRL7136DBM	4899	71	36	28.5	48.6	247	58
	68PRR7136DBM	4899	71	36	28.5	48.6	247	58
	68PRL8430DBM	5257	84	30	28.5	65.25	232	59
	68PRR8430DBM	5257	84	30	28.5	65.25	232	59
	68PRL8436DBM	4981	84	36	28.5	62.5	274	68
	68PRR8436DBM	4981	84	36	28.5	62.5	274	68
	68PRL9630DBM	5309	96	30	28.5	70.75	261	74
	68PRR9630DBM	5309	96	30	28.5	70.75	261	74
	68PRL9636DBM	5713	96	36	28.5	68	310	77
	68PRR9636DBM	5713	96	36	28.5	68	310	77

ORDERING NOTES:

Please see page 256 for perforated metal modesty panel option. For reverse grain direction on returns use list price and note Reverse Grain on p.o.

ORDERING PROCEDURE

To order, please specify the following:

- 1) Krug product model number
- 2) Wood species and finish, see page 247
- 3) Wood edge detail- I,H, L or P, see page 250
- 4) Pull style, see page 250
- 5) Grommet location if applicable

*Indicates model illustrated by line drawing.

CODE DESCRIPTION

4 - full height pedestal
 DB - Half Drum Base
 DBM - Half Drum Base & Full Modesty Panel

STANDARD FINISHES

For a complete list of standard wood finishes please see page 247.

GROMMETS

One wiring grommet in standard position is optional at no charge. Additional wiring grommets are available at an **upcharge of \$152.**

MILLENNIUM | LINKING TOPS

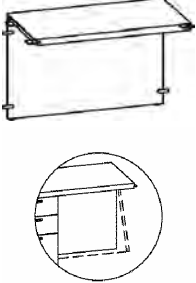
Description	Model	Cherry Walnut Maple			W	D	H	KW	Shipping Weight	Cubic Feet
	68LU3024H	1815			29.5	24.25	28.5		57	6
	68LU3620H	1899			35.5	20.25	28.5		54	6
	68LU3624H	1960			35.5	24.25	28.5		68	7
	68LU4220H	1988			41.5	20.25	28.5		66	7
	68LU4224H	2055			41.5	24.25	28.5		82	8
	68LU4820H*	2096			47.5	20.25	28.5		78	8
	68LU4824H	2133			47.5	24.25	28.5		97	9
	68LU5420H	2161			53.5	20.25	28.5		90	9
	68LU5424H	2190			53.5	24.25	28.5		111	10
	68LU6020H	2210			59.5	20.25	28.5		100	10
	68LU6024H	2243			59.5	24.25	28.5		123	11
	68LU6624H	2385			65.5	24.25	28.5		137	12
	68LU7124H	2543			70.5	24.25	28.5		148	13

ORDERING NOTES:

Please see page 256 for wire management cut-out option. Please see page 256 for hinged modesty panel option and perforated metal modesty panel option.

	68LUC3624H	2307			35.5	24.25	28.5		68	7
	68LUC4224H	2353			41.5	24.25	28.5		82	8
	68LUC4824H*	2483			47.5	24.25	28.5		97	9

ORDERING NOTES:

Please see page 256 for wire management cut-out option. Please see page 256 for hinged modesty panel option and for perforated metal modesty panel option. Linking unit is 21.25" deep at the center of the curve.

	68LT3620H	943			35.5	20.25	28.5		34	6
	68LT3624H	952			35.5	24.25	28.5		48	6
	68LT4220H	981			41.5	20.25	28.5		46	7
	68LT4224H	1011			41.5	24.25	28.5		62	8
	68LT4820H*	1036			47.5	20.25	28.5		58	8
	68LT4824H	1054			47.5	24.25	28.5		77	9
	68LT5420H	1066			53.5	20.25	28.5		70	9
	68LT5424H	1074			53.5	24.25	28.5		91	10
	68LT6020H	1090			59.5	20.25	28.5		80	10
	68LT6024H	1124			59.5	24.25	28.5		93	11
	68LT6620H	1141			65.5	20.25	28.5		82	11
	68LT6624H	1161			65.5	24.25	28.5		107	12
	68LT7124H	1181			70.5	24.25	28.5		118	13

ORDERING NOTES: For reverse grain direction on returns use list price and note Reverse Grain on p.o.

	68LTC3624H	1092			35.5	24.25	28.5		48	6
	68LTC4224H	1151			41.5	24.25	28.5		62	8
	68LTC4824H*	1213			47.5	24.25	28.5		77	9

ORDERING NOTES: Linking unit is 21.25" deep at the center of the curve. For reverse grain direction on returns use list price and note Reverse Grain on p.o.

DIMENSION KEY

W - width
D - depth
H - height

CODE DESCRIPTION

H - desk height

STANDARD FINISHES

For a complete list of standard wood finishes please see page 256.

GABLE SUPPORT

A half gable support is required on any open spans greater than 60" that don't have a modesty panel.

MILLENNIUM | CORNER UNITS

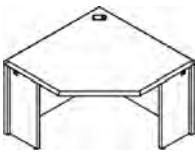
Description	Model	Cherry		W	D	H	KW	Shipping Weight	Cubic Feet
		Walnut	Maple						
	68CU363620	3732		36.25	36.25	28.5	22.5	132	26
	68CU363624	3732		36.25	36.25	28.5	17	132	26
	68CU424224*	4085		42.25	42.25	28.5	25.5	164	35
	68CU4242L24R30	4147		42.25	42.25	28.5	21.5	164	35
	68CU4242L30R24	4147		42.25	42.25	28.5	21.5	164	35

ORDERING NOTES: Includes a standard grommet in the "C" position. Laminate worksurfaces are available at a 10% upcharge. When ordering a keyboard for use with a corner unit, please specify a 68KBAC2110 with an extended mechanism.

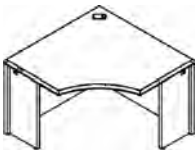
Description	Model	Cherry		W	D	H	KW	Shipping Weight	Cubic Feet
		Walnut	Maple						
	68CUC363620	3896		36.25	36.25	28.5	22.5	132	26
	68CUC363624	3896		36.25	36.25	28.5	17	132	26
	68CUC424224*	4292		42.25	42.25	28.5	25.5	164	35
	68CUC4242L24R30	4402		42.25	42.25	28.5	21.5	132	35
	68CUC4242L30R24	4402		42.25	42.25	28.5	21.5	132	35

ORDERING NOTES: Includes a standard grommet in the "C" position. Laminate worksurfaces are available at a 10% upcharge. When ordering a keyboard for use with a corner unit, please specify a 68KBAC2110 with an extended mechanism.

ORDERING PROCEDURE

To order, please specify the following:

- 1) Krug product model number
- 2) Wood species and finish, see page 247
- 3) Wood edge detail- I,H, L or P, see page 250
- 4) Pull style, see page 250
- 5) Grommet location if applicable

*Indicates model illustrated by line drawing.

STANDARD FINISHES

For a complete list of standard wood finishes please see page 247.

GROMMETS

One wiring grommet in standard position is optional at no charge. Additional wiring grommets are available at an **upcharge of \$152.**

MILLENNIUM | CREDENZAS

Description	Model	Cherry		W	D	H	KW	Shipping	
		Walnut	Maple					Weight	Cubic Feet
Single Pedestal Credenza	68C60204LDRO	5179		60	20.25	28.5	42	154	24
	68C60204LFR0	5179		60	20.25	28.5	42	154	24
with Full Height Pedestals	68C60204LORD	5179		60	20.25	28.5	42	154	24
	68C60204LORF	5179		60	20.25	28.5	42	154	24
	68C60244LDRO	5217		60	24.25	28.5	42	178	29
	68C60244LFR0	5217		60	24.25	28.5	42	178	29
	68C60244LORD	5217		60	24.25	28.5	42	178	29
	68C60244LORF	5217		60	24.25	28.5	42	178	29
	68C66204LDRO	5255		65.75	20.25	28.5	48	165	27
	68C66204LFR0	5255		65.75	20.25	28.5	48	165	27
	68C66204LORD	5255		65.75	20.25	28.5	48	165	27
	68C66204LORF	5255		65.75	20.25	28.5	48	165	27
	68C66244LDRO	5269		65.75	24.25	28.5	48	192	32
	68C66244LFR0	5269		65.75	24.25	28.5	48	192	32
	68C66244LORD	5269		65.75	24.25	28.5	48	192	32
	68C66244LORF	5269		65.75	24.25	28.5	48	192	32
	68C71204LDRO*	5296		71	20.25	28.5	53.25	175	29
	68C71204LFR0	5296		71	20.25	28.5	53.25	175	29
	68C71204LORD	5296		71	20.25	28.5	53.25	175	29
	68C71204LORF	5296		71	20.25	28.5	53.25	175	29
	68C71244LDRO	5347		71	24.25	28.5	53.25	204	34
	68C71244LFR0	5347		71	24.25	28.5	53.25	204	34
	68C71244LORD	5347		71	24.25	28.5	53.25	204	34
	68C71244LORF	5347		71	24.25	28.5	53.25	204	34
	68C78204LDRO	5393		78	20.25	28.5	60.5	193	26
	68C78204LFR0	5393		78	20.25	28.5	60.5	193	26
	68C78204LORD	5393		78	20.25	28.5	60.5	193	26
	68C78204LORF	5393		78	20.25	28.5	60.5	193	26
	68C78244LDRO	5439		78	24.25	28.5	60.5	224	32
	68C78244LFR0	5439		78	24.25	28.5	60.5	224	32
	68C78244LORD	5439		78	24.25	28.5	60.5	224	32
	68C78244LORF	5439		78	24.25	28.5	60.5	224	32
	68C84204LDRO	5492		83.75	20.25	28.5	66.25	191	34
	68C84204LFR0	5492		83.75	20.25	28.5	66.25	191	34
	68C84204LORD	5492		83.75	20.25	28.5	66.25	191	34
	68C84204LORF	5492		83.75	20.25	28.5	66.25	191	34
	68C84244LDRO	5498		83.75	24.25	28.5	66.25	222	38
	68C84244LFR0	5498		83.75	24.25	28.5	66.25	222	38
	68C84244LORD	5498		83.75	24.25	28.5	66.25	222	38
	68C84244LORF	5498		83.75	24.25	28.5	66.25	222	38

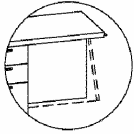
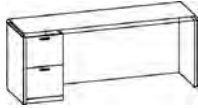

ORDERING NOTES:

Please see page 256 for wire management cut-out and/or hinged modesty panel option.

DIMENSION KEY

W - width
D - depth
H - height

CODE DESCRIPTION

0 - no pedestal
4 - full height pedestal
L - left handed pedestal position
R - right handed pedestal position
D - 2 file drawer
F - 2 box, 1 file drawer

STANDARD FINISHES

For a complete list of standard wood finishes please see page 247.

OPEN/DESK RETURNS

Open returns can be found in the shell section on page 298. Desk depth returns have a recessed modesty panel.

MILLENNIUM | CREDENZAS

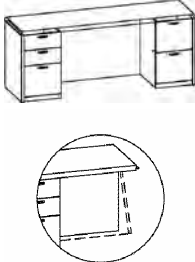
Description	Model	Cherry		W	D	H	KW	Shipping Weight	Cubic Feet
		Walnut	Maple						
Double Pedestal Credenza with Full Height Pedestals	68C60204LDRD	5593		60	20.25	28.5	27.25	186	24
	68C60204LDRF	5593		60	20.25	28.5	27.25	186	24
	68C60204LFRD	5593		60	20.25	28.5	27.25	186	24
	68C60204LFRF	5593		60	20.25	28.5	27.25	186	24
	68C60244LDRD	5611		60	24.25	28.5	27.25	210	29
	68C60244LDRF	5611		60	24.25	28.5	27.25	210	29
	68C60244LFRD	5611		60	24.25	28.5	27.25	210	29
	68C60244LFRF	5611		60	24.25	28.5	27.25	210	29
	68C66204LDRD	5656		65.75	20.25	28.5	33.25	197	27
	68C66204LDRF	5656		65.75	20.25	28.5	33.25	197	27
	68C66204LFRD	5656		65.75	20.25	28.5	33.25	197	27
	68C66204LFRF	5656		65.75	20.25	28.5	33.25	197	27
	68C66244LDRD	5671		65.75	24.25	28.5	33.25	210	32
	68C66244LDRF	5671		65.75	24.25	28.5	33.25	210	32
	68C66244LFRD	5671		65.75	24.25	28.5	33.25	210	32
	68C66244LFRF	5671		65.75	24.25	28.5	33.25	210	32
	68C71204LDRD	5688		71	20.25	28.5	38.5	207	29
	68C71204LDRF	5688		71	20.25	28.5	38.5	207	29
	68C71204LFRD*	5688		71	20.25	28.5	38.5	207	29
	68C71204LFRF	5688		71	20.25	28.5	38.5	207	29
	68C71244LDRD	5752		71	24.25	28.5	38.5	236	34
	68C71244LDRF	5752		71	24.25	28.5	38.5	236	34
	68C71244LFRD	5752		71	24.25	28.5	38.5	236	34
	68C71244LFRF	5752		71	24.25	28.5	38.5	236	34
	68C78204LDRD	5767		78	20.25	28.5	42.5	205	26
	68C78204LDRF	5767		78	20.25	28.5	42.5	205	26
	68C78204LFRD	5767		78	20.25	28.5	42.5	205	26
	68C78204LFRF	5767		78	20.25	28.5	42.5	205	26
	68C78244LDRD	5854		78	24.25	28.5	42.5	253	32
	68C78244LDRF	5854		78	24.25	28.5	42.5	253	32
68C78244LFRD	5854		78	24.25	28.5	42.5	253	32	
68C78244LFRF	5854		78	24.25	28.5	42.5	253	32	
68C84204LDRD	5811		83.75	20.25	28.5	51.75	223	34	
68C84204LDRF	5811		83.75	20.25	28.5	51.75	223	34	
68C84204LFRD	5811		83.75	20.25	28.5	51.75	223	34	
68C84204LFRF	5811		83.75	20.25	28.5	51.75	223	34	
68C84244LFRD	5954		83.75	24.25	28.5	51.75	254	38	
68C84244LDRF	5954		83.75	24.25	28.5	51.75	254	38	
68C84244LDRD	5954		83.75	24.25	28.5	51.75	254	38	
68C84244LFRF	5954		83.75	24.25	28.5	51.75	254	38	

ORDERING NOTES:

The pencil drawer can not be used in 20" deep knee hole credenzas and/or shells. Please see page 256 for wire management cut-out option and for hinged modesty panel option.

ORDERING PROCEDURE

To order, please specify the following:

- 1) Krug product model number
- 2) Wood species and finish, see page 247
- 3) Wood edge detail- I,H, L or P, see page 250
- 4) Pull style, see page 250
- 5) Grommet location if applicable

*Indicates model illustrated by line drawing.

CODE DESCRIPTION

- 4 - full height pedestal
- L - left handed pedestal position
- R - right handed pedestal position
- D - 2 file drawer
- F - 2 box, 1 file drawer

STANDARD FINISHES

For a complete list of standard wood finishes please see page 247.

GROMMETS

One wiring grommet in standard position is optional at no charge. Additional wiring grommets are available at an **upcharge of \$152.**

MILLENNIUM | CREDENZAS

Description	Model	Cherry	W	D	H	KW	Shipping Weight	Cubic Feet
		Walnut Maple						
Bow Top, Double Pedestal Credenza with Full Height Pedestals	68CX71204LDRD	6085	71	20.5	28.5	38.5	217	29
	68CX71204LDRF	6085	71	20.5	28.5	38.5	217	29
	68CX71204LFRD	6085	71	20.5	28.5	38.5	217	29
	68CX71204LFRF	6085	71	20.5	28.5	38.5	217	29
	68CX71244LDRD	6219	71	24.5	28.5	38.5	246	24
	68CX71244LDRF	6219	71	24.5	28.5	38.5	246	24
	68CX71244LFRD	6219	71	24.5	28.5	38.5	246	24
	68CX71244LFRF	6219	71	24.5	28.5	38.5	246	24
	68CX78204LDRD	6250	78	20.5	28.5	42.5	224	26
	68CX78204LDRF	6250	78	20.5	28.5	42.5	224	26
	68CX78204LFRD*	6250	78	20.5	28.5	42.5	224	26
	68CX78204LFRF	6250	78	20.5	28.5	42.5	224	26
	68CX78244LDRD	6258	78	24.5	28.5	42.5	257	38
	68CX78244LDRF	6258	78	24.5	28.5	42.5	257	38
	68CX78244LFRD	6258	78	24.5	28.5	42.5	257	38
	68CX78244LFRF	6258	78	24.5	28.5	42.5	257	38
	68CX84204LDRD	6357	83.75	20.5	28.5	51.75	233	34
	68CX84204LDRF	6357	83.75	20.5	28.5	51.75	233	34
	68CX84204LFRD	6357	83.75	20.5	28.5	51.75	233	34
	68CX84204LFRF	6357	83.75	20.5	28.5	51.75	233	34
	68CX84244LDRD	6365	83.75	24.5	28.5	51.75	264	38
	68CX84244LDRF	6365	83.75	24.5	28.5	51.75	264	38
	68CX84244LFRD	6365	83.75	24.5	28.5	51.75	264	38
	68CX84244LFRF	6365	83.75	24.5	28.5	51.75	264	38

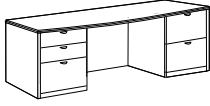

ORDERING NOTES:

The pencil drawer can not be used in 20" deep knee hole credenzas and/or shells. Please see page 256 for wire management cut-out option and for hinged modesty panel option.

Description	Model	Cherry	W	D	H	KW	Shipping Weight	Cubic Feet
Credenza, Ganged Pedestals	68C66204LDDR0	6179	65.75	20.25	28.5	33.25	197	27
	68C66204LDFR0	6179	65.75	20.25	28.5	33.25	197	27
	68C66204LFDR0	6179	65.75	20.25	28.5	33.25	197	27
	68C66204LFFR0**	6179	65.75	20.25	28.5	33.25	197	27
	68C66204LORDD	6179	65.75	20.25	28.5	33.25	197	27
	68C66204LORDF	6179	65.75	20.25	28.5	33.25	197	27
	68C66204LORFD*	6179	65.75	20.25	28.5	33.25	197	27
	68C66204LORFF	6179	65.75	20.25	28.5	33.25	197	27
	68C66244LDDR0	6213	65.75	24.5	28.5	33.25	224	32
	68C66244LDFR0	6213	65.75	24.5	28.5	33.25	224	32
	68C66244LFDR0	6213	65.75	24.5	28.5	33.25	224	32
	68C66244LFFR0	6213	65.75	24.5	28.5	33.25	224	32
	68C66244LORDD	6213	65.75	24.5	28.5	33.25	224	32
	68C66244LORDF	6213	65.75	24.5	28.5	33.25	224	32
	68C66244LORFD	6213	65.75	24.5	28.5	33.25	224	32
	68C66244LORFF	6213	65.75	24.5	28.5	33.25	224	32
	68C71204LDDR0	6244	71	20.25	28.5	38.5	207	29
	68C71204LDFR0	6244	71	20.25	28.5	38.5	207	29
	68C71204LFDR0	6244	71	20.25	28.5	38.5	207	29
	68C71204LFFR0	6244	71	20.25	28.5	38.5	207	29
	68C71204LORDD	6244	71	20.25	28.5	38.5	207	29

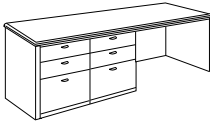
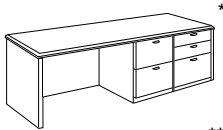

ORDERING NOTES:

"C" position grommets are not available on 60-71" Ganged Pedestal Credenzas. Ganged pedestals are specified in the product code beginning with the pedestal closest to the end panel.

DIMENSION KEY

W - width
D - depth
H - height

CODE DESCRIPTION

0 - no pedestal
4 - full height pedestal
L - left handed pedestal position
R - right handed pedestal position
D - 2 file drawer
F - 2 box, 1 file drawer

STANDARD FINISHES

For a complete list of standard wood finishes please see page 247.

GABLE SUPPORT

A half gable support is required on any open spans greater than 60" that don't have a modesty panel.

MILLENNIUM | CREDENZAS

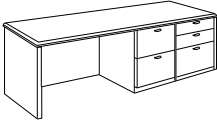
Description	Model	Cherry		W	D	H	KW	Shipping Weight	Cubic Feet
		Walnut	Maple						
	68C71204LORDF	6244		71	20.25	28.5	38.5	207	29
	68C71204LORFD*	6244		71	24.5	28.5	38.5	207	29
	68C71204LORFF	6244		71	24.5	28.5	38.5	207	29
	68C71244LDDRO	6281		71	24.5	28.5	38.5	236	34
	68C71244LDFRO	6281		71	24.5	28.5	38.5	236	34
	68C71244LFDR0	6281		71	24.5	28.5	38.5	236	34
	68C71244LFFR0	6281		71	24.5	28.5	38.5	236	34
	68C71244LORDD	6281		71	24.5	28.5	38.5	236	34
	68C71244LORDF	6281		71	24.5	28.5	38.5	236	34
	68C71244LORFD	6281		71	20.25	28.5	38.5	236	34
	68C71244LORFF	6281		71	20.25	28.5	38.5	236	34
	68C78204LDDRO	6286		78	20.5	28.5	42.5	217	26
	68C78204LDFRO	6286		78	20.5	28.5	42.5	217	26
	68C78204LFDR0	6286		78	20.5	28.5	42.5	217	26
	68C78204LFFR0	6286		78	20.5	28.5	42.5	217	26
	68C78204LORDD	6286		78	20.5	28.5	42.5	217	26
	68C78204LORDF	6286		78	20.5	28.5	42.5	217	26
	68C78204LORFD	6286		78	20.5	28.5	42.5	217	26
	68C78204LORFF	6286		78	20.5	28.5	42.5	217	26
	68C78244LDDRO	6291		78	24.5	28.5	42.5	253	32
	68C78244LDFRO	6291		78	24.5	28.5	42.5	253	32
	68C78244LFDR0	6291		78	24.5	28.5	42.5	253	32
	68C78244LFFR0	6291		78	24.5	28.5	42.5	253	32
	68C78244LORDD	6291		78	24.5	28.5	42.5	253	32
	68C78244LORDF	6291		78	24.5	28.5	42.5	253	32
	68C78244LORFD	6291		78	24.5	28.5	42.5	253	32
	68C78244LORFF	6291		78	24.5	28.5	42.5	253	32
	68C84204LDDRO	6365		83.75	20.5	28.5	51.5	223	34
	68C84204LDFRO	6365		83.75	20.5	28.5	51.5	223	34
	68C84204LFDR0	6365		83.75	20.5	28.5	51.5	223	34
	68C84204LFFR0	6365		83.75	20.5	28.5	51.5	223	34
	68C84204LORDD	6365		83.75	20.5	28.5	51.5	223	34
	68C84204LORDF	6365		83.75	20.5	28.5	51.5	223	34
	68C84204LORFD	6365		83.75	20.5	28.5	51.5	223	34
68C84204LORFF	6365		83.75	20.5	28.5	51.5	223	34	
68C84244LDDRO	6397		83.75	24.5	28.5	51.5	223	34	
68C84244LDFRO	6397		83.75	24.5	28.5	51.5	223	34	
68C84244LFDR0	6397		83.75	24.5	28.5	51.5	223	34	
68C84244LFFR0	6397		83.75	24.5	28.5	51.5	223	34	
68C84244LORDD	6397		83.75	24.5	28.5	51.5	223	34	
68C84244LORDF	6397		83.75	24.5	28.5	51.5	223	34	
68C84244LORFD	6397		83.75	24.5	28.5	51.5	223	34	
68C84244LORFF	6397		83.75	24.5	28.5	51.5	223	34	

ORDERING NOTES:

"C" position grommets are not available on 60-71" Ganged Pedestal Credenzas. Ganged pedestals are specified in the product code beginning with the pedestal closest to the end panel.

ORDERING PROCEDURE

To order, please specify the following:

- 1) Krug product model number
- 2) Wood species and finish, see page 247
- 3) Wood edge detail- I,H, L or P, see page 250
- 4) Pull style, see page 250
- 5) Grommet location if applicable

*Indicates model illustrated by line drawing.

CODE DESCRIPTION

- 0 - no pedestal
- 4 - full height pedestal
- L - left handed pedestal position
- R - right handed pedestal position
- D - 2 file drawer
- F - 2 box, 1 file drawer

STANDARD FINISHES

For a complete list of standard wood finishes please see page 247.

GROMMETS

One wiring grommet in standard position is optional at no charge. Additional wiring grommets are available at an **upcharge of \$152.**

MILLENNIUM | CREDENZAS

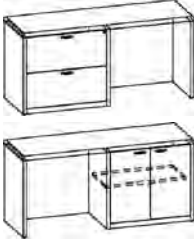
Description	Model	Cherry		W	D	H	KW	Shipping Weight	Cubic Feet
		Walnut	Maple						
Credenza, Lateral File or Bookcase Pedestals 	68C6020LBR0	4698		60	20.5	28.5	28	174	24
	68C6020LFR0	5206		60	20.5	28.5	28	205	24
	68C6020LORB	4698		60	20.5	28.5	28	172	24
	68C6020LORF	5206		60	20.5	28.5	28	205	24
	68C6024LBR0	4723		60	24.5	28.5	28	198	29
	68C6024LFR0	5235		60	24.5	28.5	28	229	29
	68C6024LORB	4723		60	24.5	28.5	28	198	29
	68C6024LORF	5235		60	24.5	28.5	28	229	29
	68C6620LBR0	4822		65.75	20.5	28.5	33.75	185	28
	68C6620LFR0	5339		65.75	20.5	28.5	33.75	216	28
	68C6620LORB	4822		65.75	20.5	28.5	33.75	185	28
	68C6620LORF	5339		65.75	20.5	28.5	33.75	216	28
	68C6624LBR0	4919		65.75	24.5	28.5	33.75	212	32
	68C6624LFR0	5450		65.75	24.5	28.5	33.75	243	32
	68C6624LORB	4919		65.75	24.5	28.5	33.75	212	32
	68C6624LORF	5450		65.75	24.5	28.5	33.75	243	32
	68C7120LBR0	5000		71	20.5	28.5	33.5	195	31
	68C7120LFR0	5584		71	20.5	28.5	33.5	226	31
	68C7120LORB	5000		71	20.5	28.5	33.5	195	31
	68C7120LORF	5584		71	20.5	28.5	33.5	226	31
	68C7124LBR0	5132		71	24.5	28.5	33.5	224	34
	68C7124LFR0	5674		71	24.5	28.5	33.5	257	34
	68C7124LORB	5132		71	24.5	28.5	33.5	224	34
	68C7124LORF	5674		71	24.5	28.5	33.5	257	34
	68C7820LBR0	5117		78	20.5	28.5	41.5	196	26
	68C7820LFR0	5684		78	20.5	28.5	41.5	227	26
	68C7820LORB	5117		78	20.5	28.5	41.5	196	26
	68C7820LORF	5684		78	20.5	28.5	41.5	227	26
	68C7824LBR0	5191		78	24.5	28.5	41.5	221	32
	68C7824LFR0	5807		78	24.5	28.5	41.5	252	32
	68C7824LORB	5191		78	24.5	28.5	41.5	221	32
	68C7824LORF	5807		78	24.5	28.5	41.5	252	32
	68C8420LBR0	5281		83.75	20.5	28.5	39.5	211	34
	68C8420LFR0	5833		83.75	20.5	28.5	39.5	242	34
	68C8420LORB	5281		83.75	20.5	28.5	39.5	211	34
	68C8420LORF	5833		83.75	20.5	28.5	39.5	242	34
	68C8424LBR0	5389		83.75	24.5	28.5	39.5	242	40
	68C8424LFR0	5953		83.75	24.5	28.5	39.5	273	40
	68C8424LORB	5389		83.75	24.5	28.5	39.5	242	40
	68C8424LORF	5953		83.75	24.5	28.5	39.5	273	40

ORDERING NOTES:

"C" position grommets are not available on 60-71" Lateral File/ Bookcase Pedestal Credenzas.

DIMENSION KEY

W - width
D - depth
H - height

CODE DESCRIPTION

0 - no pedestal
H - desk height
4 - full height pedestal
L - left handed pedestal position
R - right handed pedestal position
D - 2 file drawer
BC - bookcase
F - 2 box, 1 file drawer: when preceded in the model number by -4.
F - 2 lateral file drawers: when it directly follows the size classified.

STANDARD FINISHES

For a complete list of standard wood finishes please see page 247.

GABLE SUPPORT

A half gable support is required on any open spans greater than 60" that don't have a modesty panel.

MILLENNIUM | CREDENZAS

Description	Model	Cherry		W	D	H	Shipping Weight	Cubic Feet
		Walnut	Maple					
 Credenza, Full Face	68C66244DBCD	6575	6575	65.75	24.5	28.5	295	31
	68C66244DBCF	6575	6575	65.75	24.5	28.5	295	31
	68C66244FBCD	6575	6575	65.75	24.5	28.5	295	31
	68C66244FBCF*	6575	6575	65.75	24.5	28.5	295	31
	68C71204DBCD	6792	6792	71	20.5	28.5	295	30
	68C71204DBCF	6792	6792	71	20.5	28.5	295	30
	68C71204FBCD	6792	6792	71	20.5	28.5	295	30
	68C71204FBCF	6792	6792	71	20.5	28.5	295	30
	68C71244DBCD	6986	6986	71	24.5	28.5	305	34
	68C71244DBCF	6986	6986	71	24.5	28.5	305	34
	68C71244FBCD	6986	6986	71	24.5	28.5	305	34
	68C71244FBCF	6986	6986	71	24.5	28.5	305	34
	68C78204DBCD	6973	6973	78	20.5	28.5	305	30
	68C78204DBCF	6973	6973	78	20.5	28.5	305	30
	68C78204FBCD	6973	6973	78	20.5	28.5	305	30
	68C78204FBCF	6973	6973	78	20.5	28.5	305	30
	68C78244DBCD	7199	7199	78	24.5	28.5	315	34
	68C78244DBCF	7199	7199	78	24.5	28.5	315	34
	68C78244FBCD	7199	7199	78	24.5	28.5	315	34
	68C78244FBCF	7199	7199	78	24.5	28.5	315	34
	68C84204DBCD	7159	7159	83.75	20.5	28.5	315	36
	68C84204DBCF	7159	7159	83.75	20.5	28.5	315	36
	68C84204FBCD	7159	7159	83.75	20.5	28.5	315	36
	68C84204FBCF	7159	7159	83.75	20.5	28.5	315	36
	68C84244DBCD	7364	7364	83.75	24.5	28.5	325	40
	68C84244DBCF	7364	7364	83.75	24.5	28.5	325	40
68C84244FBCD	7364	7364	83.75	24.5	28.5	325	40	
68C84244FBCF	7364	7364	83.75	24.5	28.5	325	40	

 Bow Top Full Face Credenza	68CX66204DBCD	7000	65.75	20.5	28.5	264	27
	68CX66204FBCF*	7000	65.75	20.5	28.5	264	27
	68CX66204FBCD	7000	65.75	20.5	28.5	264	27
	68CX66204DBCF	7000	65.75	20.5	28.5	264	27
	68CX66244DBCD	7130	65.75	24.5	28.5	291	30
	68CX66244FBCF	7130	65.75	24.5	28.5	291	30
	68CX66244FBCD	7130	65.75	24.5	28.5	291	30
	68CX66244DBCF	7130	65.75	24.5	28.5	291	30
	68CX71204DBCD	7357	71	20.5	28.5	271	32
	68CX71204FBCF	7357	71	20.5	28.5	271	32
	68CX71204FBCD	7357	71	20.5	28.5	271	32
	68CX71204DBCF	7357	71	20.5	28.5	271	32
	68CX71244DBCD	7534	71	24.5	28.5	303	34
	68CX71244FBCF	7534	71	24.5	28.5	303	34
	68CX71244FBCD	7534	71	24.5	28.5	303	34
	68CX71244DBCF	7534	71	24.5	28.5	303	34
	68CX78204DBCD	7647	78	20.5	28.5	278	37
	68CX78204FBCF	7647	78	20.5	28.5	278	37
	68CX78204FBCD	7647	78	20.5	28.5	278	37
	68CX78204DBCF	7647	78	20.5	28.5	278	37
	68CX78244DBCD	7999	78	24.5	28.5	315	38
	68CX78244FBCF	7999	78	24.5	28.5	315	38
	68CX78244FBCD	7999	78	24.5	28.5	315	38
	68CX78244DBCF	7999	78	24.5	28.5	315	38

ORDERING PROCEDURE

To order, please specify the following:

- 1) Krug product model number
- 2) Wood species and finish, see page 247
- 3) Wood edge detail- I,H, L or P, see page 250
- 4) Pull style, see page 250
- 5) Grommet location if applicable

*Indicates model illustrated by line drawing.

CODE DESCRIPTION

0 - no pedestal
 4 - full height pedestal
 L - left handed pedestal position
 R - right handed pedestal position
 D - 2 file drawer
 BC - bookcase
 F - 2 box, 1 file drawer

STANDARD FINISHES

For a complete list of standard wood finishes please see page 247.

GROMMETS

One wiring grommet in standard position is optional at no charge. Additional wiring grommets are available at an **upcharge of \$152.**

MILLENNIUM | CREDENZAS

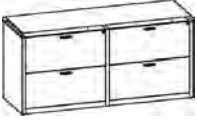
Description	Model	Cherry Walnut Maple	W	D	H	KW	Shipping Weight	Cubic Feet
	68C6020LBRB	5640	60	20.5	28.5		226	24
	68C6020LBRF	6600	60	20.5	28.5		257	24
	68C6020LFRB	6616	60	20.5	28.5		257	24
	68C6020LFRF	7271	60	20.5	28.5		288	24
	68C6024LBRB	5640	60	24.5	28.5		250	29
	68C6024LBRF	6665	60	24.5	28.5		281	29
	68C6024LFRB	6665	60	24.5	28.5		281	29
	68C6024LFRF	7300	60	24.5	28.5		312	29
	68C7120LBRB	6012	71	20.5	28.5		247	31
	68C7120LBRF	7060	71	20.5	28.5		278	31
	68C7120LFRB	7060	71	20.5	28.5		278	31
	68C7120LFRF	7736	71	20.5	28.5		309	31
	68C7124LBRB	6097	71	24.5	28.5		271	34
	68C7124LBRF	7191	71	24.5	28.5		307	34
	68C7124LFRB	7191	71	24.5	28.5		307	34
	68C7124LFRF	7837	71	24.5	28.5		338	34
	68C8420LBRB	6216	83.75	20.5	28.5		263	34
	68C8420LBRF	7365	83.75	20.5	28.5		294	34
	68C8420LFRB	7365	83.75	20.5	28.5		294	34
	68C8420LFRF	7973	83.75	20.5	28.5		325	34
68C8424LBRB	6298	83.75	24.5	28.5		294	40	
68C8424LBRF	7525	83.75	24.5	28.5		325	40	
68C8424LFRB	7525	83.75	24.5	28.5		325	40	
68C8424LFRF	8062	83.75	24.5	28.5		356	40	

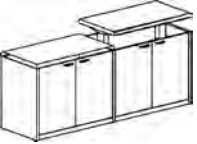
	68C6024LBRHAES*	7358	59.75	24	29.5		176	28
	68C6024LHAESRB	7358	59.75	24	29.5		192	28
	68C6024LFRHAES	7653	59.75	24	29.5		192	28
	68C6024LHAESRF	7653	59.75	24	29.5		248	28
	68C7224LBRHAES	8094	71.75	24	29.5		192	33
	68C7224LHAESRB	8094	71.75	24	29.5		210	33
	68C7224LFRHAES	8264	71.75	24	29.5		210	33
	68C7224LHAESRF	8264	71.75	24	29.5		230	33

	68CX6020LBRB	6484	60	20.5	28.5		241	24
	68CX6020LBRF	7633	60	20.5	28.5		272	24
	68CX6020LFRB	7633	60	20.5	28.5		272	24
	68CX6020LFRF	8371	60	20.5	28.5		303	24
	68CX6024LBRB	6555	60	24.5	28.5		265	29
	68CX6024LBRF	7789	60	24.5	28.5		296	29
	68CX6024LFRB	7789	60	24.5	28.5		296	29
	68CX6024LFRF	8472	60	24.5	28.5		327	29
	68CX7120LBRB	6710	71	20.5	28.5		262	31
	68CX7120LBRF	7938	71	20.5	28.5		293	31
	68CX7120LFRB	7938	71	20.5	28.5		293	31
	68CX7120LFRF	8640	71	20.5	28.5		324	31
	68CX7124LBRB	6839	71	24.5	28.5		291	34
	68CX7124LBRF	8108	71	24.5	28.5		322	34
	68CX7124LFRB	8108	71	24.5	28.5		322	34
	68CX7124LFRF	8695	71	24.5	28.5		353	34

ORDERING NOTES: Height range of electric lift is 29.5" to 46.5".

DIMENSION KEY

W - width
D - depth
H - height

CODE DESCRIPTION

4 - full height pedestal
L - left handed pedestal position
R - right handed pedestal position
B - bookcase
F - 2 lateral file drawers

STANDARD FINISHES

For a complete list of standard wood finishes please see page 247.

MILLENNIUM | CREDENZAS

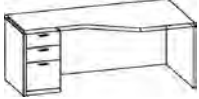
Description	Model	Cherry			Shipping Weight	Cubic Feet	
		Walnut	Maple				
		W	D	H			
	68CC6624L4D	4504	65.75	36.25	28.5	230	45
	68CC6624L4F	4504	65.75	36.25	28.5	230	45
	68CC6624R4D	4504	65.75	36.25	28.5	230	45
	68CC6624R4F	4504	65.75	36.25	28.5	230	45
	68CC7124L4D	4608	71	36.25	28.5	240	50
	68CC7124L4F	4608	71	36.25	28.5	240	50
	68CC7124R4D	4608	71	36.25	28.5	240	50
	68CC7124R4F	4608	71	36.25	28.5	240	50
	68CC7824L4D	4669	78	36.25	28.5	250	55
	68CC7824L4F	4669	78	36.25	28.5	250	55
	68CC7824R4D	4669	78	36.25	28.5	250	55
	68CC7824R4F	4669	78	36.25	28.5	250	55
	68CC8424L4D	4728	82.75	36.25	28.5	260	59
	68CC8424L4F	4728	82.75	36.25	28.5	260	59
	68CC8424R4D	4728	82.75	36.25	28.5	260	59
	68CC8424R4F	4728	82.75	36.25	28.5	260	59

ORDERING NOTES:

For a curved corner version of this credenza, please add 5% list to above list prices and add an extra C to the model number prefix. Example: 68CCC7124L4D**

ORDERING PROCEDURE

To order, please specify the following:

- 1) Krug product model number
- 2) Wood species and finish, see page 247
- 3) Wood edge detail- I, H, L or P, see page 250
- 4) Pull style, see page 250
- 5) Grommet location if applicable

*Indicates model illustrated by line drawing.

CODE DESCRIPTION

- 4 - full height pedestal
- L - left handed pedestal position
- R - right handed pedestal position
- D - 2 file drawer
- F - 2 box, 1 file drawer

STANDARD FINISHES

For a complete list of standard wood finishes please see page 247.

GROMMETS

One wiring grommet in standard position is optional at no charge. Additional wiring grommets are available at an **upcharge of \$152**

MILLENNIUM | OVERHEADS

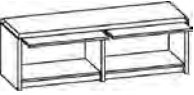
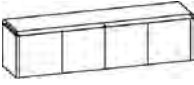
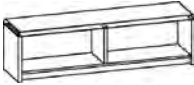
Description	Model	Cherry		W	D	H	Doors	Shipping Weight	Cubic Feet
		Walnut	Maple						
Overhead with Flipper Doors 	68OF3619*	2217		36	18	19.25		140	9
	68OF4219	2359		42	18	19.25		151	10
	68OF4819	2444		48	18	19.25		162	12
	68OF6019**	2860		58.5	18	19.25		173	15
	68OF6619	3008		64.25	18	19.25		184	16
	68OF7119	3166		70.5	18	19.25		195	17
									
Single Height Overhead with Hinged Doors 	68OH361517*	2218		36	15	16.75	2	127	9
	68OH421517	2359		42	15	16.75	2	136	10
	68OH481517	2447		48	15	16.75	3	145	12
	68OH601517**	2849		58.5	15	16.75	4	154	15
	68OH661517	3008		64.25	15	16.75	4	163	16
	68OH711517	3118		70.5	15	16.75	4	172	17
	Overhead, Open 	68OO361517*	1822		36	15	16.75	2	117
68OO421517		1924		42	15	16.75	2	126	10
68OO481517		1998		48	15	16.75	3	135	12
68OO601517**		2362		58.5	15	16.75	4	124	15
68OO661517		2502		64.25	15	16.75	4	143	16
68OO711517		2658		70.5	15	16.75	4	152	17

ORDERING NOTES: Please see page 257 for double height option and paper management option. All overheads include factory installed tasklights and mounting hardware. Locks are available on wood door overheads at **\$152 list per set** of (2) doors. Please specify at time of order.

Tackboards for Overheads with Flipper Doors		1	2	3	4	5	6	7	8	9	W	H	COM	WT
	68TBOF36	359	402	441	502	655	805	948	1102	1295	38	24	1.5	10
	68TBOF42	402	540	569	708	851	982	1124	1297	1529	44	24	1.5	12
	68TBOF48	446	555	580	725	872	1003	1153	1327	1596	50	24	1.75	13
	68TBOF60	507	676	708	882	1060	1254	1452	1651	1959	61	24	2	15
	68TBOF66	555	751	739	983	1179	1398	1592	1818	2166	67	24	2	16
	68TBOF71	610	931	942	1288	1583	1601	1839	2098	2447	74	24	2.25	18

Tackboards for Overheads with Hinged Doors		1	2	3	4	5	6	7	8	9	W	H	COM	WT
	68TBOH36	359	402	441	502	655	805	948	1102	1295	38	24	1.5	10
	68TBOH42	402	540	569	708	851	982	1124	1297	1529	44	24	1.5	12
	68TBOH48	446	555	580	725	872	1003	1153	1327	1596	50	24	1.75	13
	68TBOH60	507	676	708	882	1060	1254	1452	1651	1959	61	24	2	15
	68TBOH66	555	751	739	983	1179	1398	1592	1818	2166	67	24	2	16
	68TBOH71	610	931	942	1288	1583	1601	1839	2098	2447	74	24	2.25	18

ORDERING NOTES:

Please contact Customer Service for information on yardage required when ordering two or more tackboards. Please note either tackboard code 68TBOF or 68TBOH can be used for an open overheads.

DIMENSION KEY

W - width
D - depth
H - height

STANDARD FINISHES

For a complete list of standard wood finishes please see page 247.

MILLENNIUM | HUTCHES

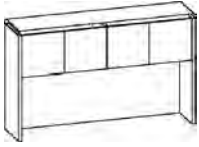
Description	Model	Cherry Walnut Maple	W	D	H	TH	Shipping Weight	Cubic Feet	
	Hutches, Hinged Doors	68HT3615	2757	35.25	15	39.75	23	147	15
		68HT4215	3036	41	15	39.75	23	156	18
		68HT4815	3579	47	15	39.75	23	165	20
		68HT5415	3828	53	15	39.75	23	174	22
		68HT6015*	4200	58.75	15	39.75	23	183	25
		68HT6615	4592	64.75	15	39.75	23	192	27
		68HT7115	5390	70	15	39.75	23	201	30
		68HT7815	5713	77	15	39.75	23	210	32
		68HT8415	6033	83	15	39.75	23	215	35
		68HT9018-2	7766	89	18	39.75	23	274	44
		68HT9618-2	8754	95	18	39.75	23	293	47
		68HT10218-2	9308	101	18	39.75	23	311	50
		68HT11018-2	9973	109	18	39.75	23	336	54

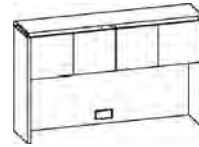
	Hutches, Hinged Doors & Power/Data/Voice Grommet	68HT3615W	2986	35.25	15	39.75	23	147	15
		68HT4215W	3252	41	15	39.75	23	156	18
		68HT4815W	3802	47	15	39.75	23	165	20
		68HT5415W	4028	53	15	39.75	23	174	22
		68HT6015W*	4417	58.75	15	39.75	23	183	25
		68HT6615W	4807	64.75	15	39.75	23	192	27
		68HT7115W	5609	70	15	39.75	23	201	30
		68HT7815W	5905	77	15	39.75	23	210	32
		68HT8415W	6253	83	15	39.75	23	215	35
		68HT9018-2W	8038	89	18	39.75	23	274	44
		68HT9618-2W	9012	95	18	39.75	23	293	47
		68HT10218-2W	9511	101	18	39.75	23	311	50
		68HT11018-2W	10261	109	18	39.75	23	336	54

ORDERING NOTES:

Hinged door hutches include factory installed tasklights and tackboard. "TH" column above represents the clearance height for the tackboard. Hutches over 84" in length will be made in two pieces. Hutches are inset 3/4" on each side when sitting on the worksurface. Locks are available on wood door hutches at **\$152 list per (2) doors**. Please specify at time of order.

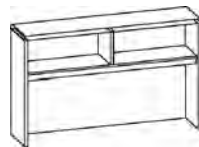
	Hutch, Open	68HTO3615	2609	35.25	15	39.75	23	137	15
		68HTO4215	2957	41	15	39.75	23	146	18
		68HTO4815	3303	47	15	39.75	23	155	20
		68HTO5415	3465	53	15	39.75	23	164	22
		68HTO6015	3721	58.75	15	39.75	23	173	25
		68HTO6615*	4114	64.75	15	39.75	23	192	28
		68HTO7115	4548	70	15	39.75	23	181	30
		68HTO7815	4746	77	15	39.75	23	190	32
		68HTO8415	4939	83	15	39.75	23	199	35
		68HTO9018-2	6400	89	18	39.75	23	254	44
		68HTO9618-2	7235	95	18	39.75	23	273	47
		68HTO10218-2	7903	101	18	39.75	23	291	50

ORDERING PROCEDURE

To order, please specify the following:

- 1) Krug product model number
- 2) Wood species and finish, see page 247
- 3) Wood edge detail- I, H, L or P, see page 250
- 4) Pull style, see page 250
- 5) Grommet location if applicable

*Indicates model illustrated by line drawing.

CODE DESCRIPTION

W - includes power/data/voice grommet in tackboard
 -2 - Hutches over 84" in length will be made in two pieces.

STANDARD FINISHES

For a complete list of standard wood finishes please see page 247.

INSIDE FINISHED BACKS

Optional inside finished backs are available up to a maximum of 84" hutches at the standard list price. This option does not include the tackboard.

MILLENNIUM | HUTCHES

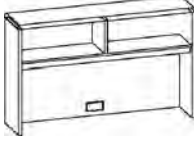
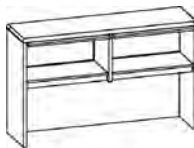
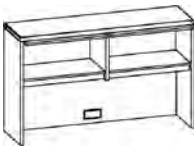
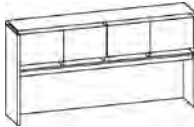
Description	Model	Cherry		W	D	H	TH	Shipping Weight	Cubic Feet
		Walnut	Maple						
 Hutch, Open & Power/ Data/Voice Grommet	68HTO3615W	2838		35.25	18	39.75	23	137	15
	68HTO4215W	3165		41	15	39.75	23	146	18
	68HTO4815W	3501		47	15	39.75	23	155	20
	68HTO5415W	3687		53	15	39.75	23	164	22
	68HTO6015W	3939		58.75	15	39.75	23	173	25
	68HTO6615W*	4331		64.75	15	39.75	23	192	28
	68HTO7115W	4790		70	15	39.75	23	181	30
	68HTO7815W	4946		77	15	39.75	23	190	32
	68HTO8415W	5137		83	15	39.75	23	199	35
	68HTO9018-2W	6685		89	18	39.75	23	254	44
	68HTO9618-2W	7515		95	18	39.75	23	254	47
	68HTO10218-2W	8191		101	18	39.75	23	291	50
	 Hutch, Flipper Doors	68HTF3618	2735		35.25	18	39.75	22	158
68HTF4218		3066		41	18	39.75	22	167	18
68HTF4818		3532		47	18	39.75	22	176	20
68HTF5418		3870		53	18	39.75	22	185	23
68HTF6018		4533		58.75	18	39.75	22	194	25
68HTF6618*		4870		64.75	18	39.75	22	203	27
68HTF7118		5638		70	18	39.75	22	212	30
68HTF7818		6042		77	18	39.75	22	221	33
68HTF8418		6516		83	18	39.75	22	230	35
68HTF9018		8293		89	18	39.75	22	239	44
 Hutch, Flipper Doors & Power/Data/Voice Grommet		68HTF3618W	2944		35.25	18	39.75	22	158
	68HTF4218W	3303		41	18	39.75	22	167	18
	68HTF4818W	3736		47	18	39.75	22	176	20
	68HTF5418W	4068		53	18	39.75	22	185	23
	68HTF6018W	4767		58.75	18	39.75	22	194	25
	68HTF6618W*	5110		64.75	18	39.75	22	203	27
	68HTF7118W	5854		70	18	39.75	22	212	30
	68HTF7818W	6221		77	18	39.75	22	221	33
	68HTF8418W	6693		83	18	39.75	22	230	35
	68HTF9018W	8506		89	18	39.75	22	239	44
 Hutch, Paper Management	68HTPM6015	5406		58.75	15	39.75	19.75	204	25
	68HTPM6615	5561		64.75	15	39.75	19.75	214	27
	68HTPM7115	5755		70	15	39.75	19.75	232	30
	68HTPM7815*	6179		77	15	39.75	19.75	241	33
	68HTPM8415	6616		83	15	39.75	19.75	250	35
	68HTPM9618-2	10939		95	18	39.75	19.75	300	35
	68HTPM10218-2	11632		101	18	39.75	19.75	320	35
	68HTPM11018-2	12463		109	18	39.75	19.75	340	35

ORDERING NOTES:

All hutches include factory installed tasklights and tackboard. "TH" column above represents the clearance height for the tackboard. Hutches over 84" in length will be made in two pieces. Hutches are inset 3/4" on each side when sitting on the worksurface.

DIMENSION KEY

W - width
D - depth
H - height

CODE DESCRIPTION

G - wood framed clear glass doors
OF- flipper door
OH- hinged door
OO- open, no doors
W - includes power/data/voice grommet in tackboard
PM- paper manager
PS- paper shelf

STANDARD FINISHES

For a complete list of standard wood finishes please see page 247.

TACKBOARD FABRIC OPTIONS

See page 297 for tackboard fabric options and grading information.

MILLENNIUM | HUTCHES

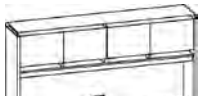
Description	Model	Cherry Walnut Maple	W	D	H	TH	Shipping Weight	Cubic Feet
 Hutch, Paper Management with Power/Data/Voice Grommet	68HTPM6015W	5586	58.75	15	39.75	19.75	204	25
	68HTPM6615W	5789	64.75	15	39.75	19.75	214	27
	68HTPM7115W	5955	70	15	39.75	19.75	232	30
	68HTPM7815W*	6402	77	15	39.75	19.75	241	33
	68HTPM8415W	6817	83	15	39.75	19.75	250	35
	68HTPM9618-2W	11138	95	18	39.75	19.75	300	35
	68HTPM10218-2W	11857	101	18	39.75	19.75	320	35
	68HTPM11018-2W	12688	109	18	39.75	19.75	340	35

ORDERING NOTES:

Hutches include factory installed tasklights and tackboard. "TH" column above represents the clearance height for the tackboard.

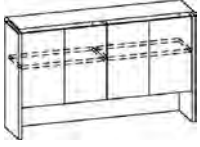
 Bookcase Hutch, Hinged Doors	68HTBC3615**	2955	35.25	15	39.75	11.5	167	15
	68HTBC4215	3343	41	15	39.75	11.5	176	18
	68HTBC4815	3738	47	15	39.75	11.5	185	22
	68HTBC5415	3918	53	15	39.75	11.5	194	25
	68HTBC6015	4130	58.75	15	39.75	11.5	203	25
	68HTBC6615*	4646	64.75	15	39.75	11.5	212	27
	68HTBC7115	5132	70	15	39.75	11.5	221	30
	68HTBC7815	5692	77	15	39.75	11.5	230	34
	68HTBC8415	6295	83	15	39.75	11.5	248	37

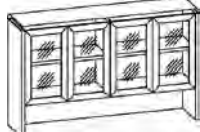
 Bookcase Hutch, Hinged Glass Doors	68HTBC3615G**	3103	35.25	15	39.75	11.5	117	15
	68HTBC4215G	3507	41	15	39.75	11.5	176	18
	68HTBC4815G	3924	47	15	39.75	11.5	185	22
	68HTBC5415G	4154	53	15	39.75	11.5	194	25
	68HTBC6015G	4380	58.75	15	39.75	11.5	203	25
	68HTBC6615G*	4888	64.75	15	39.75	11.5	212	27
	68HTBC7115G	5398	70	15	39.75	11.5	221	30
	68HTBC7815G	5995	77	15	39.75	11.5	230	34
	68HTBC8415G	6611	83	15	39.75	11.5	248	37

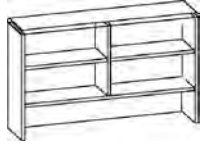
 Bookcase Hutch, Open	68HTBCO3615**	2465	35.25	15	39.75	11.5	157	15
	68HTBCO4215	2837	41	15	39.75	11.5	166	18
	68HTBCO4815	3200	47	15	39.75	11.5	175	20
	68HTBCO5415	3265	53	15	39.75	11.5	184	23
	68HTBCO6015	3336	58.75	15	39.75	11.5	183	25
	68HTBCO6615*	3819	64.75	15	39.75	11.5	192	27
	68HTBCO7115	4297	70	15	39.75	11.5	201	30
	68HTBCO7815	4789	77	15	39.75	11.5	210	33
	68HTBCO8415	5332	73	15	39.75	11.5	219	35

ORDERING NOTES:

Bookcase hutches include a finished back panel. Bookcase hutches cannot accept tackboards or tasklights. Hutches over 84" in length will be made in two pieces. Hutches are inset 3/4" on each side when sitting on the worksurface.

ORDERING PROCEDURE

To order, please specify the following:

- 1) Krug product model number
- 2) Wood species and finish, see page 247
- 3) Wood edge detail- I, H, L or P, see page 250
- 4) Pull style, see page 250
- 5) Grommet location if applicable

*Indicates model illustrated by line drawing.

CODE DESCRIPTION

G - wood framed clear glass doors
 W - includes power/data/voice grommet in tackboard
 -2 - Hutches over 84" in length will be made in two pieces.

STANDARD FINISHES

For a complete list of standard wood finishes please see page 247.

INSIDE FINISHED BACKS

Optional inside finished backs are available up to a maximum of 84" hutches at the standard list price. This option does not include the tackboard.

MILLENNIUM | HUTCHES

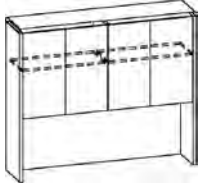
Description	Model	Cherry		W	D	H	TH	Shipping Weight	Cubic Feet
		Walnut	Maple						
 6-Hi Hutch, Hinged Doors	68HT601555	5106		58.75	15	55.5	23	260	25
	68HT661555*	5673		64.75	15	55.5	23	273	27
	68HT711555	6492		70	15	55.5	23	281	30
	68HT781555	6987		77	15	55.5	23	290	32
	68HT841555	7480		83	15	55.5	23	299	35

 6-Hi Hutch, Hinged Doors & Power/Data/Voice Grommet	68HT601555W	5303		58.75	15	55.5	23	260	25
	68HT661555W*	5868		64.75	15	55.5	23	273	27
	68HT711555W	6736		70	15	55.5	23	281	30
	68HT781555W	7235		77	15	55.5	23	290	32
	68HT841555W	7699		83	15	55.5	23	299	35

 6-Hi Hutch, Hinged Glass Doors	68HT601555G	5410		58.75	15	55.5	23	176	25
	68HT661555G*	6014		64.75	15	55.5	23	188	27
	68HT711555G	6875		70	15	55.5	23	199	30
	68HT781555G	7399		77	15	55.5	23	212	32
	68HT841555G	7927		83	15	55.5	23	232	35

ORDERING NOTES:

Hinged door hutches include factory installed tasklights and tackboard. Hutches over 84" in length will be made in two pieces. Hutches are inset 3/4" on each side when sitting on the worksurface. Locks are available on wood door hutches at **\$145 list per (2) doors**. Please specify at time of order.

 Hutch with Pier	68HTPD8418	6674		83	18	39.75	23	290	41
	68HTPD9018-2*	8699		89	18	39.75	23	305	44
	68HTPD9618-2	9313		95	18	39.75	23	320	47
	68HTPD11018-2	10653		109	18	39.75	23	350	51

ORDERING NOTES:

Pier door hutches include factory installed tasklights and a tackboard. "TH" column above represents the clearance height for the tackboard. Hutches over 84" in length will be made in two pieces. Hutches are inset 3/4" on each side when sitting on the worksurface.

DIMENSION KEY

W - width
D - depth
H - height

CODE DESCRIPTION

G - wood framed clear glass doors
W - includes power/data/voice grommet in tackboard
-2 - Hutches over 84" in length will be made in two pieces

STANDARD FINISHES

For a complete list of standard wood finishes please see page 247.

TACKBOARD FABRIC OPTIONS

See page 297 for hutch fabric grade upcharges.

MILLENNIUM | HUTCHES

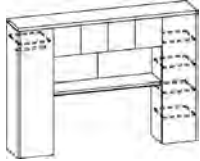
Description	Model	Cherry Walnut Maple			W	D	H	Shipping Weight	Cubic Feet
	68WU9618LWRB*	11371	95.75	24.25	68	665	60		
	68WU9618LBRW	11371	95.75	24.25	68	665	60		
	68WU10818LWRB	12124	108	24.25	68	705	70		
	68WU10818LBRW	12124	108	24.25	68	705	70		

Paper Manager	68PM18132001	1815	17	12.5	19.75	50	3
							

Paper Manager	68PM18122002	1467	17	12	19.75	50	3
							

Paper Manager	68PM18122003	1467	17	12	19.75	50	3
							

ORDERING PROCEDURE

To order, please specify the following:

- 1) Krug product model number
- 2) Wood species and finish, see page 247
- 3) Wood edge detail- I,H, L or P, see page 250
- 4) Pull style, see page 250
- 5) Grommet location if applicable

*Indicates model illustrated by line drawing.

CODE DESCRIPTION

W - includes power/data/voice grommet in tackboard
 L/RW - left or right wardrobe
 L/RB - left or right bookcase storage

STANDARD FINISHES

For a complete list of standard wood finishes please see page 247.

MILLENNIUM | HUTCH TACKBOARDS

Tackboard upcharges for hutches and wall units. Use this chart to find the upcharge for tackboard fabrics graded 2–9 and add it to the cost of the hutch or wall unit.

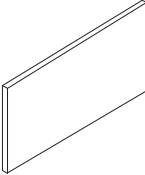
		FABRIC GRADES								
		2	3	4	5	6	7	8	9	com
	36" hutch tackboard	176	378	547	732	908	1082	1257	1528	1.5
	42" hutch tackboard	176	378	547	732	908	1082	1257	1528	1.5
	48" hutch tackboard	176	378	547	732	908	1082	1257	1528	1.75
	54" hutch tackboard	176	378	547	732	908	1082	1257	1528	1.75
	60" hutch tackboard	176	378	547	732	908	1082	1257	1528	2
	66" hutch tackboard	198	424	620	832	1031	1227	1422	1771	2.25
	71" hutch tackboard	238	505	740	992	1230	1467	1705	2055	2
	78" hutch tackboard	284	597	882	1170	1458	1737	2020	2408	2
	84" hutch tackboard	331	687	1018	1349	1680	2004	2337	2764	2.5
	90" hutch tackboard	374	771	1143	1513	1884	2254	2623	3043	2.75
	96" hutch tackboard	409	846	1258	1664	2069	2481	2881	3346	3
	102" hutch tackboard	449	931	1387	1835	2278	2726	3173	3638	3
	110" hutch tackboard	491	1030	1527	2017	2506	2996	3488	3993	3.25
	84" pier door hutch tackboard	176	378	547	732	908	1082	1257	1528	2
90" pier door hutch tackboard	176	378	547	732	908	1082	1257	1528	2.25	
96" pier door hutch tackboard	176	378	547	732	908	1082	1257	1528	2.5	
110" pier door hutch tackboard	278	592	873	1158	1158	1433	1995	2343	2.75	
96" wall unit tackboard	176	378	547	732	908	1082	1257	1528	2.5	
108" wall unit tackboard	278	592	873	1158	1158	1433	1995	2343	2.5	

On single piece hutches, the yardage requirement for two tackboards is the same as for one tackboard. Please keep this in mind when ordering more than one tackboard. For example, if the number of tackboards required is 7 and the COM requirement for 1 tackboard is 1.5 yards, the calculation for COM yardage is as follows: 4.5 yards are required for 6 tackboards + 1.5 yards for the 7th tackboard for a total of 6 yards. In the case of an even number of tackboards, divide the number of tackboards required by 2 and multiply that number by COM requirement on the chart. The fabric must be at least 54" wide in order to qualify for this procedure. If the fabric is less than 54" wide, the COM yardage listed on the chart is the amount required for each tackboard.

Quantity of Tackboards Required (example: 60")	Number of Yards Required per Tackboard (example: 60")	Number of Yards Required in Total (example: 60")
one	2 yards	2
two	2 yards	2
three	2 yards	4
four	2 yards	4
fiv	2 yards	6
six	2 yards	6
seven	2 yards	8
eight	2 yards	8

DIMENSION KEY

W - width
D - depth
H - height

STANDARD FINISHES

For a complete list of standard wood finishes please see page 247.

MILLENNIUM | SHELLS

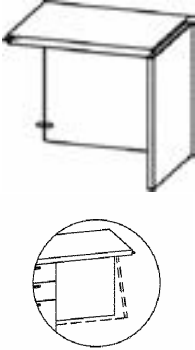
Description	Model	Cherry Walnut Maple	W	D	H	KW	Shipping Weight	Cubic Feet
Open Return, Desk Height	68RH2420L	2051	23.75	20.25	28.5	22	46	13
	68RH2420R	2051	23.75	20.25	28.5	22	46	13
	68RH2424L	2088	23.75	24.25	28.5	22	55	15
	68RH2424R	2088	23.75	24.25	28.5	22	55	15
	68RH3020L	2160	30	20.25	28.5	28.13	58	15
	68RH3020R	2160	30	20.25	28.5	28.13	58	15
	68RH3024L*	2194	30	24.25	28.5	28.13	70	17
	68RH3024R	2194	30	24.25	28.5	28.13	70	17
	68RH3620L	2272	36	20.25	28.5	34.13	69	17
	68RH3620R	2272	36	20.25	28.5	34.13	69	17
	68RH3624L	2306	36	24.25	28.5	34.13	83	20
	68RH3624R	2306	36	24.25	28.5	34.13	83	20
	68RH3630L	2334	36	30.25	28.5	34.13	104	22
	68RH3630R	2334	36	30.25	28.5	34.13	104	22
	68RH4220L	2376	42	20.25	28.5	40.13	81	20
	68RH4220R	2376	42	20.25	28.5	40.13	81	20
	68RH4224L	2433	42	24.25	28.5	40.13	97	22
	68RH4224R	2433	42	24.25	28.5	40.13	97	22
	68RH4230L	2462	42	30.25	28.5	40.13	122	24
	68RH4230R	2462	42	30.25	28.5	40.13	122	24
	68RH4820L	2488	48	20.25	28.5	46.13	93	22
	68RH4820R	2488	48	20.25	28.5	46.13	93	22
	68RH4824L	2549	48	24.25	28.5	46.13	112	24
	68RH4824R	2549	48	24.25	28.5	46.13	112	24
	68RH4830L	2557	48	30.25	28.5	46.13	140	26
	68RH4830R	2557	48	30.25	28.5	46.13	140	26
	68RH5420L	2590	54	20.25	28.5	52.13	105	24
	68RH5420R	2590	54	20.25	28.5	52.13	105	24
	68RH5424L	2629	54	24.25	28.5	52.13	126	26
	68RH5424R	2629	54	24.25	28.5	52.13	126	26
	68RH5430L	2631	54	30.25	28.5	52.13	158	30
	68RH5430R	2631	54	30.25	28.5	52.13	158	30
68RH6020L	2646	60	20.25	28.5	58.38	115	26	
68RH6020R	2646	60	20.25	28.5	58.38	115	26	
68RH6024L	2701	60	24.25	28.5	58.38	138	30	
68RH6024R	2701	60	24.25	28.5	58.38	138	30	
68RH6030L	2739	60	30.25	28.5	58.38	173	33	
68RH6030R	2739	60	30.25	28.5	58.38	173	33	
68RH6620L	2754	65.75	20.25	28.5	63.88	126	30	
68RH6620R	2754	65.75	20.25	28.5	63.88	126	30	
68RH6624L	2816	65.75	24.25	28.5	63.88	152	33	
68RH6624R	2816	65.75	24.25	28.5	63.88	152	33	
68RH6630L	2844	65.75	30.25	28.5	63.88	191	36	
68RH6630R	2844	65.75	30.25	28.5	63.88	191	36	
68RH7120L	2877	71	20.25	28.5	69.13	136	33	
68RH7120R	2877	71	20.25	28.5	69.13	136	33	
68RH7124L	2917	71	24.25	28.5	69.13	163	36	
68RH7124R	2917	71	24.25	28.5	69.13	163	36	
68RH7130L	2937	71	30.25	28.5	69.13	204	38	
68RH7130R	2937	71	30.25	28.5	69.13	204	38	

ORDERING NOTES:

Please see page 256 for wire management cut-out option. Please see page 256 for hinged modesty panel option. For Universal Return Shells replace RH with RHU. Grommets are not available on Universal Return shells.

ORDERING PROCEDURE

To order, please specify the following:

- 1) Krug product model number
- 2) Wood species and finish, see page 247
- 3) Wood edge detail- I, H, L or P, see page 250
- 4) Pull style, see page 250
- 5) Grommet location if applicable

*Indicates model illustrated by line drawing.

CODE DESCRIPTION

L - left hand runoff
R - right hand runoff

STANDARD FINISHES

For a complete list of standard wood finishes please see page 247.



MODESTY PANELS

Open returns are available with 9", 1/2" or 3/4" modesty panels at no upcharge. Please specify at time of order.

PEDESTALS

Pedestals for use with open shells can be found on page 316.

MILLENNIUM | SHELLS

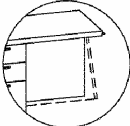
Description	Model	Cherry Walnut Maple	W	D	H	KW	Shipping			
							Weight	Cubic Feet		
	Open Return, Desk Height continued	68RH8420L	2970	84	20.25	28.5	82.13	163	36	
		68RH8420R	2970	84	20.25	28.5	82.13	163	36	
		68RH8424L	3001	84	24.25	28.5	82.13	196	38	
		68RH8424R	3001	84	24.25	28.5	82.13	196	38	
		68RH8430L	3036	84	30.25	28.5	82.13	245	45	
		68RH8430R	3036	84	30.25	28.5	82.13	245	45	
		68RH9024L	3040	90	24.25	28.5	88.13	210	45	
		68RH9024R	3040	90	24.25	28.5	88.13	210	45	
		68RH9030L	3096	90	30.25	28.5	88.13	247	49	
		68RH9030R	3096	90	30.25	28.5	88.13	247	49	
		68RH9624L	3155	96	24.25	28.5	93.88	221	49	
		68RH9624R	3155	96	24.25	28.5	93.88	221	49	
		68RH9630L	3209	96	30.25	28.5	93.88	249	52	
		68RH9630R	3209	96	30.25	28.5	93.88	249	52	
		68RH10220L	3312	102	20.25	28.5	100.25	195	49	
		68RH10220R	3312	102	20.25	28.5	100.25	195	49	
	 	Open Shell, Accepts Shallow Pedestals	68S3020	2377	30	20.25	28.5	27	61	13
			68S3024	2410	30	24.25	28.5	27	73	15
		68S3620	2436	36.25	20.25	28.5	33.25	73	15	
		68S3624	2458	36.25	24.25	28.5	33.25	88	18	
		68S4220	2476	42	20.25	28.5	39	86	17	
		68S4224	2506	42	24.25	28.5	39	103	21	
		68S4820	2531	48	20.25	28.5	45	98	20	
		68S4824	2563	48	24.25	28.5	45	118	23	
		68S5020	2580	50	20.25	28.5	47	102	22	
		68S5024	2610	50	24.25	28.5	47	122	24	
		68S5420	2636	54	20.25	28.5	51	110	22	
		68S5424	2650	54	24.25	28.5	51	132	26	
		68S6020	2732	60	20.25	28.5	56.75	122	24	
		68S6024	2800	60	24.25	28.5	56.75	146	29	
		68S6320	2831	63.5	20.25	28.5	60.5	128	25	
		68S6324	2873	63.5	24.25	28.5	60.5	153	30	
		68S6620	2916	65.75	20.25	28.5	62.75	122	27	
		68S6624	3011	65.75	24.25	28.5	62.75	146	32	
		68S7120	3153	71	20.25	28.5	68	131	29	
		68S7124*	3255	71	24.25	28.5	68	157	34	
		68S7420	3330	74.25	20.25	28.5	71.25	134	30	
		68S7424	3456	74.25	24.25	28.5	71.25	161	35	
		68S7820	3539	78	20.25	28.5	75	141	32	
		68S7824	3618	78	24.25	28.5	75	189	37	
		68S8420	3643	82.75	20.25	28.5	81	159	34	
		68S8424	3697	82.75	24.25	28.5	81	190	40	
		68S9020	3859	90	20.25	28.5	87	170	36	
		68S9024	3904	90	24.25	28.5	87	204	43	
		68S9320	3939	93.5	20.25	28.5	90.75	176	39	
		68S9324	3977	93.5	24.25	28.5	90.75	212	45	
		68S9620	4013	95.75	20.25	28.5	93	181	43	
		68S9624	4080	95.75	24.25	28.5	93	217	49	
		68S10220	4161	102	20.25	28.5	99.25	184	51	
		68S10224	4223	102	24.25	28.5	99.25	221	55	
		68S11020	4291	109.75	20.25	28.5	106.75	199	54	
		68S11024	4407	109.75	24.25	28.5	106.75	239	60	

ORDERING NOTES:

The pencil drawer can not be used in the 20" deep knee hole credenzas and/or shells. Please see page 256 for wire management cut-out option. Please see page 256 for hinged modesty panel option.

DIMENSION KEY

W - width
D - depth
H - height

CODE DESCRIPTION

L - left hand runoff
R - right hand runoff

STANDARD FINISHES

For a complete list of standard wood finishes please see page 247.

PEDESTALS

Pedestals for use with open shells can be found on page 316.

HALF GABLE

Half gable at connecting end of open return is standard at sizes greater than 54" in length.

MILLENNIUM | SHELLS

Description	Model	Cherry		W	D	H	KW	Shipping Weight	Cubic Feet
		Walnut	Maple						
Half Gable	68HG2710*	473		10	27	27		11	1
	68HG2716	540		16	27	27		16	1



ORDERING NOTES:

This unit should be ordered to center-support open spans greater than 60". Use 68HG2710 with 20" & 24" deep cases and 68HG2716 with 30" deep cases.

Open Shell, Accepts Deep Pedestals			W	D	H	KW	Shipping Weight	Cubic Feet
	Model							
	68S3630	2581	36.25	30.25	28.5	33.5	110	21
	68S4230	2712	42	30.25	28.5	39.25	129	25
	68S4830	2812	48	30.25	28.5	44.75	147	29
	68S6030	2924	63.5	30.25	28.5	56.75	182	36
	68S6630	3037	65.75	30.25	28.5	62.75	200	39
	68S6636	3180	65.75	36.25	28.5	62.75	240	46
	68S7130	3345	71	30.25	28.5	68	215	42
	68S7136*	3507	71	36.25	28.5	68	255	50
	68S8430	3683	82.75	30.25	28.5	81	342	50
	68S8436	3927	84	36.25	28.5	81	285	59
	68S9030	4098	90	30.25	28.5	87	255	53
	68S9630	4345	93.5	30.25	28.5	92.75	272	56
	68S10230	4591	102	30.25	28.5	99.25	276	60

ORDERING NOTES:

The pencil drawer can not be used in the 20" deep knee hole credenzas and/or shells. Please see page 256 for wire management cut-out option. Please see page 256 for hinged modesty panel option.

Corner Credenza Shell			W	D	H	KW	Shipping Weight	Cubic Feet
	Model							
	68CC6624L	3452	65.75	36.25	28.5		180	45
	68CC6624R	3452	65.75	36.25	28.5		180	45
	68CC7124L	3490	71	36.25	28.5		190	50
	68CC7124R	3490	71	36.25	28.5		190	50
	68CC7824L	3535	78	36.25	28.5		200	55
	68CC7824R*	3535	78	36.25	28.5		200	55
	68CC8424L	3568	82.75	36.25	28.5		210	59
	68CC8424R	3568	82.75	36.25	28.5		210	59

Corner Return Shell			W	D	H	KW	Shipping Weight	Cubic Feet
	Model							
	68CR7124L*	3435	71	24.25	28.5		190	55
	68CR7124R	3435	71	24.25	28.5		190	55
	68CR8424L	3490	84	24.25	28.5		210	59
	68CR8424R	3490	84	24.25	28.5		210	59

ORDERING NOTES:

Corner Returns are designated left or right by the location of it's connection to a primary work surface. For a curved corner version of this products, please add 5% to above list price and add an extra C to the model number prefix i.e. 68CCC7124L

ORDERING PROCEDURE

To order, please specify the following:

- 1) Krug product model number
- 2) Wood species and finish, see page 247
- 3) Wood edge detail- I,H, L or P, see page 250
- 4) Pull style, see page 250
- 5) Grommet location if applicable

*Indicates model illustrated by line drawing.

CODE DESCRIPTION

- L - left hand runoff
- R - right hand runoff

STANDARD FINISHES

For a complete list of standard wood finishes please see page 247.

PEDESTALS

Pedestals for use with open shells can be found on pages 316.

MILLENNIUM | MOBILE TABLES

Description	Model	Cherry		W	D	H	Shipping Weight	Cubic Feet
		Walnut	Maple					
 Machine Stand, Desk Height with Casters	68THC3020	2552		30	20.25	28.5	61	12
	68THC3024	2571		30	24.25	28.5	73	15
	68THC3620	2586		36.25	20.25	28.5	73	15
	68THC3624	2610		36.25	24.25	28.5	88	18
	68THC4220	2634		42	20.25	28.5	86	18
	68THC4224	2628		42	24.25	28.5	103	21
	68THC4820	2654		48	20.25	28.5	98	21
	68THC4824*	2676		48	24.25	28.5	118	23

ORDERING NOTES:

Optional paper slot in "C" position at **\$172 list upcharge.**

 Printer Stand	68PT3024	2798		30.25	24.25	28.5	76	15
	68PT3624*	2886		36.25	24.25	28.5	103	18
	68PT3630	2973		36.25	30.25	28.5	103	22

ORDERING NOTES:

Optional paper slot in "C" position at **\$172 list upcharge.**

 Round Mobile Table	68MTH36D	1719		36.25	36.25	28.5	69	6
	68MTH42D*	1731		42.25	42.25	28.5	75	8

ORDERING NOTES:

Casters optional for **\$172 list upcharge.**

 Delta Mobile Table	68MDTH32	1823		31.25	32	28.5	50	5
	68MDTH36	1841		35	35.75	28.5	57	6
	68MDTH42*	1854		41	41.75	28.5	71	8

 Arc Square Mobile Table	68MATH3030	1706		30.25	30.25	28.5	60	4.5
	68MATH3636	1719		36.25	36.25	28.5	75	6
	68MATH4242*	1731		42.25	42.25	28.5	90	8

 Square Mobile Table	68MTH3030	1706		30.25	30.25	28.5	65	4.5
	68MTH3636	1719		36.25	36.25	28.5	80	6
	68MTH4242*	1731		42.25	42.25	28.5	97	8

DIMENSION KEY

W - width
D - depth
H - height

STANDARD FINISHES

For a complete list of standard wood finishes please see page 247.

HALF GABLE

Half gable at connecting end of open return is standard at sizes greater than 54" in length.

MILLENNIUM | ACCESSORIES

Description	Model	Price	W	D	H	Shipping Weight	Cubic Feet
 Tackboard Organizer Rail	68AOB36HT	100	31	-	2.5	-	-
	68AOB42HT	100	37	-	2.5	-	-
	68AOB48HT	100	43	-	2.5	-	-
	68AOB54HT	100	49	-	2.5	-	-
	68AOB60HT	100	55	-	2.5	-	-
	68AOB66HT	100	61	-	2.5	-	-
	68AOB71HT	100	66	-	2.5	-	-
	68AOB78HT	100	73	-	2.5	-	-
	68AOB84HT	100	79	-	2.5	-	-
	68AOB90HT	100	85	-	2.5	-	-
	68AOB96HT	100	91	-	2.5	-	-
	68AOB102HT	100	97	-	2.5	-	-
68AOB110HT	100	105	-	2.5	-	-	

 Paper Tray	68APT	100	12	10.75	2	1.75	0.5
---	-------	-----	----	-------	---	------	-----

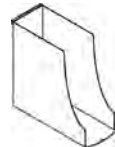
 Binder Bin	68ABB	140	10	4	10	3	0.5
--	-------	-----	----	---	----	---	-----

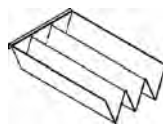
 File Organizer	68AFO	114	6	9.75	2.5	1.75	0.5
---	-------	-----	---	------	-----	------	-----

ORDERING NOTES:

This accessory can not be specified in combination with Paper Management Hutches due to space requirements.

 Hanging File Bars	68AFB	114	1.75	7.5	0.75	0.5	0.25
--	-------	-----	------	-----	------	-----	------

ORDERING PROCEDURE

To order, please specify the following:

- 1) Krug product model number
- 2) Wood species and finish, see page 247
- 3) Wood edge detail- I,H, L or P, see page 250
- 4) Pull style, see page 250
- 5) Grommet location if applicable

*Indicates model illustrated by line drawing.

CODE DESCRIPTION

APT - paper tray
 ABB - binder bin
 AFO - file organizer
 AFB - file bar
 The metal finish on perforated metal modesty panels, tapered brushed aluminum post legs, metal accent option on hutches, tack-board organizer rail, accessories and hinge caps on frameless glass doors match the Millennium satin nickel pull finish.

STANDARD FINISHES

For a complete list of standard wood finishes please see page 247.

ACCESSORIES

Accessories feature a brushed aluminum finish.

TACKBOARD ORGANIZER RAIL

Please specify clearly on purchase order which products are to receive Organizer Rail and Accessory options.

MILLENNIUM | ACCESSORIES & ELECTRICAL

Description	Model	Cherry Walnut Maple			W	D	H	Shipping Weight	Cubic Feet
Wood Pencil Drawer	68PD2116	654			21.25	21.25	1	2	1



ORDERING NOTES:

Millennium pencil drawer is available in Oak, Cherry, Maple or Walnut, please clearly mark P.O. with species and finish selection.

Articulating Keyboard	68KBA20	995			21	11	1	18	2
	68KBA30	1073			30	11	1	20	2

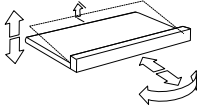

Articulating Keyboard w/ extended mechanism	68KBAC-2110	1059			21	11	1	18	2
---	-------------	------	--	--	----	----	---	----	---

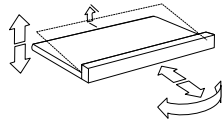

ORDERING NOTES:

This articulating keyboard is equipped with a deeper extension mechanism and should be used on corner units and corner credenzas.

Description	Model				W	D	H	Shipping Weight	Cubic Feet
Articulating Keyboard with Palm Rest & Mouse Tray	68KBMT1912	694			27	-	7	20	2



Height Adjustable Table Programmable Display- 4 Position Memory	88HAPD	376			-	-	-	-	-
--	--------	-----	--	--	---	---	---	---	---

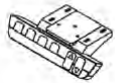



DIMENSION KEY

W - width
D - depth
H - height





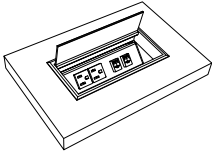
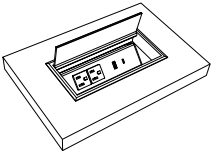
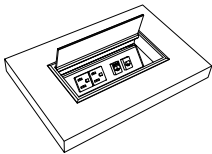
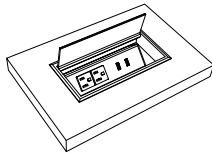
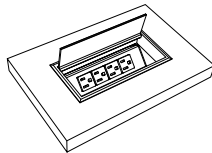
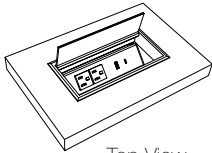

STANDARD FINISHES

For a complete list of standard wood finishes please see page 247.

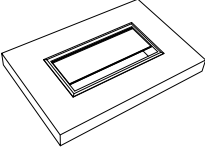
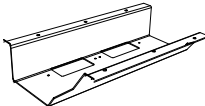
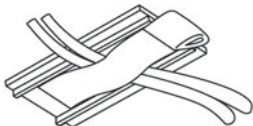

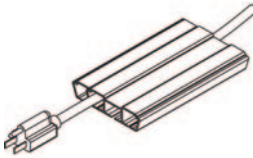
POWERPORTS

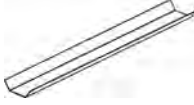
Description	Model	Price	W	D	H	Shipping Weight	Cubic Feet
PowerPort 1 - 2 RJ45s (Category 5/6)	PORT1	278	8	4	-	-	-
	Port Includes: 2 accessible power outlets & 1 side utility outlet powered by a 10' plug-in cord; 2 RJ45 (category 5/6) each with hard wired 10' data cords; 2 velcro wire managers and metal PowerPort shroud. PortPort lid is Silver Metallic. NOTE: RJ45 jacks with hard wired data cords included here must be within 10' of building utilities source to be functional.						
PowerPort 2 - USB-A & USB-C	PORT2	280	8	4	-	-	-
	Port Includes: 2 accessible power outlets & 1 side utility outlet; 1 USB-A & 1 USB-C charging ports all powered by a 10' plug-in cord; 2 velcro wire managers and metal PowerPort shroud. PortPort lid is Silver Metallic.						
PowerPort 3 - RJ11 & RJ45	PORT3	269	8	4	-	-	-
	Port Includes: 2 accessible power outlets & 1 side utility outlet; 1 RJ11 & 1 RJ45 (Category 5/6); 2 Velcro wire managers & PowerPort Shroud; 1 x 10 Foot Data Cords (T568A) & 1 x 14 Foot RJ11 (Telecomm); powered by a 10' plug-in cord. PortPort lid is Silver Metallic. NOTE: RJ45 & RJ11 jacks with hard wired data cords included here must be within 10' of building utilities source to be functional.						
PowerPort 4 - 2 USB-A	PORT4	286	8	4	-	-	-
	Port Includes: 2 accessible power outlets & 1 side utility outlet; 2- USB-A charging ports all powered by a 10' plug-in cord; 2 velcro wire managers and metal PortPort shroud. PortPort lid is Silver Metallic.						
PowerPort 5 - 4 Receptacles	PORT5	280	8	4	-	-	-
	Port Includes: 4 accessible power outlets & 1 side utility outlet powered by a 10' plug-in cord; 2 velcro wire managers and metal power port shroud. PortPort lid is Silver Metallic.						
PowerPort 6 - USB-A, USB-C & RJ45	PORT6	406	8	4	-	-	-
 	Port Includes: 2 accessible power outlets & 1 side utility outlet 1 USB-A, 1 USB-C charging ports all powered by a 10' plug-in power cord. Includes 2 velcro wire managers and metal PortPort shroud with 2 data plate knock outs, 1 #M02 plate insert & 2 #S01W RJ45 female input, punch down terminal output snap in jacks. 2nd data plate knock out is blank for future use. PortPort lid is Silver Metallic.						



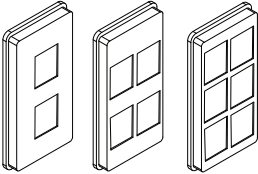

POWERPORTS

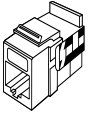
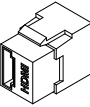
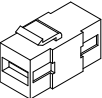
Description	Model	Price	W	D	H	Shipping Weight	Cubic Feet
Port - no Powerbar	Port0	137	8	4	-	-	-
	Port Includes: Port lid & Shroud only.						
ORDERING NOTE: Velcro wire managers not included, see below for pricing. Port lid is Silver Metallic.							
PowerPort Shroud with 2 Data Plate Knock-outs	SHROUD2KO	Must be requested - no upcharge	-	-	-	-	-
	Angled PowerPort Shroud Includes: shroud with 2 data plate knock-outs in the bottom.						
ORDERING NOTE: Please refer to data plate, data and AV integration options on page XX.							
Velcro Wire Manager (qty 1)	WM-4	26	2	4.5	0.5	-	-
	2 velcro wire managers are included with Ports 1-5.						
Wire Management Trough	WM-72	182	72	3	1	-	-
	Wire Management Trough is standard in a 72" length & can be cut to specific length; double-sided tape installation.						
4-Channel Wire Management	CM-72	231	72	3	1	-	-
	4-Channel Wire Management is standard in a 72" length & can be cut to specific length; double-sided tape installation.						
Round Grommet	Round Grommet - Silver Metallic	152	-	-	-	-	-
	Round Grommet - Black	152	-	-	-	-	-
One 60mm Grommet in a standard position is available at no charge per table.							
Silver Metallic Trough	68CT36	59	30	2	-	0.25	-
	68CT42	74	36	2	-	0.25	-
	68CT48	91	36	2	-	0.25	-
	68CT54	105	48	2	-	0.5	-
	68CT60	121	48	2	-	0.5	-
	68CT66	137	52	2	-	0.5	-
	68CT72	152	60	2	-	0.75	-
	68CT84	168	60	2	-	0.75	-
Height Adjustable Work Surface Cable Manager	68HACM1	89	4	3	21.5	5	0.25
							

POWER/DATA

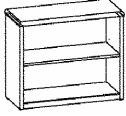
SNAP IN PORTS	Reference Code	Description	List Price
ADAPTOR PLATES			
	M02	Adaptor Plate (2) - accepts two snap in data ports	38
	M04	Adaptor Plate (4) - accepts four snap in data ports	38
	M06	Adaptor Plate (6) - accepts six snap in data ports	38
ORDERING NOTES: Blank covers are required when port is not in use, please see page 55.			
		RJ-45 - Category 6 data connection. This connector is also downwards compatible with Category 5 cabling. Connector is a female input with a #110 punch-down terminal block output (back side of Console interface) for on-site hard wire connection.	47
	S01W	RJ45-CAT6 (White)	
	S01B	RJ45-CAT6 (Blue)	
	S01R	RJ45-CAT6 (Red)	
		RJ11 - Telephone type connection. Connector is a female input with a #110 punch-down terminal block output (back side of Console interface) for on-site hard wire connection.	32
	S02W	RJ11 (White)	
	S02B	RJ11-B (Black)	
	S02G	RJ11-G (Green)	
	S02R	RJ11-R (Red)	
	S02Y	RJ11-Y (Yellow)	
	S04	HDMI - High Definition Multimedia Interface connection. Connector carries both HD audio and video data. Connector is a female-to-female pass through.	173
	S08	USB-A - Full size USB "A" style connection. Connector is a female-to-female pass through.	61

MILLENNIUM | BOOKCASES

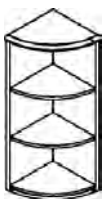
Description	Model	Cherry		W	D	H	Shipping Weight	Cubic Feet
		Walnut	Maple					
	68BC301529	2176		30	15	29.25	60	9
	68BC361529*	2232		35.25	15	29.25	70	11
	68BC481529	2457		48	15	29.25	90	14
	68BC601529	2680		60	15	29.25	110	17
	68BC711529	2936		71	15	29.25	130	20
	68BC301529-11G	2315		30	15	29.25	70	9
	68BC361529-11G*	2369		35.25	15	29.25	80	11
	68BC301543	2473		30	15	42.5	80	13
	68BC361543*	2522		35.25	15	42.5	90	15
	68BC481543	2779		48	15	42.5	110	17
	68BC601543	3052		60	15	42.5	130	21
	68BC711543	3354		71	15	42.5	150	25
	68BC301543-11G	2612		30	15	43	100	13
	68BC361543-11G*	2672		35.25	15	43	115	15
	68BCCE151543-17R	2912		15	15	43	55	7.5
	68BCCE151543-17L*	2912		15	15	43	55	7.5

DIMENSION KEY

W - width
D - depth
H - height

CODE DESCRIPTION

L - hinged left
R - hinged right
G - glass doors

STANDARD FINISHES

For a complete list of standard wood finishes please see page 247.





SHELVES

Shelves are adjustable in 1.25" increments.

PULLS/LOCKS

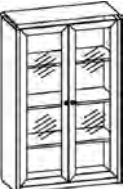
Wood door bookcases have pulls, glass door bookcases feature the Luna knob. Lateral file drawers include locks. Locks may be added to wood doors at an **upcharge of \$152 list.**

MILLENNIUM | BOOKCASES

Description	Model	Cherry Walnut Maple	W	D	H	Shipping Weight	Cubic Feet
4-Hi Open Bookcase 	68BC301556	2778	30	15	56	100	13
	68BC361556*	2837	35.25	15	56	120	15
4-Hi Bookcase with Glass Doors 	68BC301556-11G	2929	30	15	56	125	13
	68BC361556-11G*	3004	35.25	15	56	148	15
5-Hi Open Bookcase 	68BC301569	3016	30	15	69	150	21
	68BC361569*	3074	35.25	15	69	180	24
5-Hi Bookcase with 3 Open & 2 Closed Shelves 	68BC301569-13	3165	30	15	69	160	21
	68BC361569-13*	3229	35.25	15	69	190	24
5-Hi Bookcase with 3 Library & 2 Closed Shelves 	68BC301569-43	3699	30	15	69	175	21
	68BC361569-43*	3717	35.25	15	69	205	24

ORDERING PROCEDURE

To order, please specify the following:

- 1) Krug product model number
- 2) Wood species and finish, see page 247
- 3) Wood edge detail- I,H, L or P, see page 250
- 4) Pull style, see page 250
- 5) Grommet location if applicable

*Indicates model illustrated by line drawing.

STANDARD FINISHES

For a complete list of standard wood finishes please see page 247.

PULLS/LOCKS

Wood door bookcases have pulls, glass door bookcases feature the Luna knob. Lateral file drawers include locks. Locks may be added to wood doors at an **upcharge of \$152 list.**

MILLENNIUM | BOOKCASES

Description	Model	Cherry Walnut Maple	W	D	H	Shipping		Cubic Feet
						KW	Weight	
6-Hi Open Bookcase	68BC301584	3160	30	15	84		180	26
	68BC361584*	3223	35.25	15	84		215	30



Description	Model	Cherry Walnut Maple	W	D	H	Shipping		Cubic Feet
						KW	Weight	
Curved Corner Storage	68STCE20202917L	2531	20.25	20.25	28.25		56	9
	68STCE20202917R	2531	20.25	20.25	28.25		56	9
	68STCE24242917L	2657	24.25	24.25	28.25		65	12.5
	68STCE24242917R*	2657	24.25	24.25	28.25		65	12.5
	68STCE20204217L	2881	20.25	20.25	40.5		64	13
	68STCE20204217R	2881	20.25	20.25	40.5		64	13
	68STCE24244217L	3009	24.25	24.25	40.5		75	17.5
	68STCE24244217R	3009	24.25	24.25	40.5		75	17.5
	68STCE20205417L	3286	20.25	20.25	54		117	17
	68STCE20205417R	3286	20.25	20.25	54		117	17
	68STCE24245417L	3433	24.25	24.25	54		126	23.5
	68STCE24245417R	3433	24.25	24.25	54		126	23.5
	68STCE20206817L	3754	20.25	20.25	68.25		130	21
	68STCE20206817R	3754	20.25	20.25	68.25		130	21
	68STCE24246817L	3919	24.25	24.25	68.25		138	29
	68STCE24246817R	3919	24.25	24.25	68.25		138	29
	68STCE20208417L	4222	20.25	20.25	82.25		150	25.5
	68STCE20208417R	4222	20.25	20.25	82.25		150	25.5
	68STCE24248417L	4418	24.25	24.25	82.25		159	35
68STCE24248417R	4418	24.25	24.25	82.25		159	35	

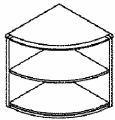

Description	Model	Cherry Walnut Maple	W	D	H	Shipping		Cubic Feet
						KW	Weight	
2 Lateral Files	68ST30202901	3895	30	20.25	28.5		129	13
	68ST30242901	3952	30	24.25	28.5		155	15
	68ST36202901	4042	36.25	20.25	28.5		151	15
	68ST36242901*	4102	36.25	24.25	28.5		181	18
	68ST42202901	4170	42	20.25	28.5		174	17
	68ST42242901	4227	42	24.25	28.5		205	21



Description	Model	Cherry Walnut Maple	W	D	H	Shipping		Cubic Feet
						KW	Weight	
2 Closed Shelves	68ST30202911	2982	30	20.25	28.5		94	13
	68ST30242911	3029	30	24.25	28.5		120	15
	68ST36202911	3077	36.25	20.25	28.5		116	15
	68ST36242911*	3135	36.25	24.25	28.5		146	18



ORDERING NOTES:

Shelf is adjustable in increments of approximately 1-1/4". Locks are available on all wood bookcase doors at \$152 list.

DIMENSION KEY

W - width
D - depth
H - height

CODE DESCRIPTION

L - hinged left
R - hinged right

STANDARD FINISHES

For a complete list of standard wood finishes please see page 247.

SHELVES

Shelves are adjustable in 1.25" increments.

MILLENNIUM | STORAGE

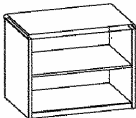
Description	Model	Cherry	W	D	H	Shipping	Cubic
		Walnut Maple					
	68ST30202917	2094	30	20.25	28.5	80	13
	68ST30242917	2135	30	24.25	28.5	100	15
	68ST36202917	2185	36.25	20.25	28.5	96	15
	68ST36242917*	2228	36.25	24.25	28.5	111	18

ORDERING NOTES:

Shelf is adjustable in increments of approximately 1-1/4".

Description	Model	Cherry	W	D	H	Shipping	Cubic
		Walnut Maple					
	68ST30204201	4831	30	20.25	41.75	164	18
	68ST30244201	4951	30	24.25	41.75	183	22
	68ST36204201	5095	36.25	20.25	41.75	196	21
	68ST36244201*	5201	36.25	24.25	41.75	218	25

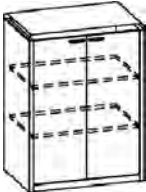
Description	Model	Cherry	W	D	H	Shipping	Cubic
		Walnut Maple					
	68ST30204211	3343	30	20.25	41.75	134	15
	68ST30244211	3415	30	24.25	41.75	153	22
	68ST36204211	3509	36.25	20.25	41.75	166	21
	68ST36244211*	3519	36.25	24.25	41.75	188	25

ORDERING NOTES:

Both interior shelves are adjustable in increments of approximately 1-1/4". Locks are available on all wood bookcase doors at **\$14642 list**.

Description	Model	Cherry	W	D	H	Shipping	Cubic
		Walnut Maple					
	68ST30204217	2995	30	20.25	41.75	114	18
	68ST30244217	3031	30	24.25	41.75	133	22
	68ST36204217	3099	36.25	20.25	41.75	146	21
	68ST36244217*	3147	36.25	24.25	41.75	168	25

ORDERING NOTES:

Shelf is adjustable in increments of approximately 1-1/4".

Description	Model	Cherry	W	D	H	Shipping	Cubic
		Walnut Maple					
	68ST30205401*	5552	30	20.25	54	220	23
	68ST30245401	5686	30	24.25	54	245	28
	68ST36205401	5912	36.25	20.25	54	245	26
	68ST36245401	6034	36.25	24.25	54	270	33

ORDERING PROCEDURE

To order, please specify the following:

- 1) Krug product model number
- 2) Wood species and finish, see page 247
- 3) Wood edge detail- I,H, L or P, see page 250
- 4) Pull style, see page 250
- 5) Grommet location if applicable

*Indicates model illustrated by line drawing.

CODE DESCRIPTION

- L - hinged left
- R - hinged right

STANDARD FINISHES

For a complete list of standard wood finishes please see page 247.

MILLENNIUM | STORAGE

Description	Model	Cherry Walnut Maple	W	D	H	Shipping		Cubic Feet
						KW	Weight	
4-Hi 2 Lateral Files & 2 Closed Shelves	68ST30205404*	4656	30	20.25	54		210	23
	68ST30245404	4773	30	24.25	54		235	28
	68ST36205404	4929	36.25	20.25	54		235	26
	68ST36245404	5024	36.25	24.25	54		260	33



ORDERING NOTES:

Interior shelf is adjustable in increments of approximately 1-1/4". Locks are available on all wood bookcase doors at **\$152 list.**

4-Hi Closed Shelves	68ST30205411*	3937	30	20.25	54		185	23
	68ST30245411	4035	30	24.25	54		205	28
	68ST36205411	4118	36.25	20.25	54		205	26
	68ST36245411	4216	36.25	24.25	54		235	33



ORDERING NOTES:

Center shelf is fixed, upper and lower shelves are adjustable in increments of approximately 1-1/4". Locks are available on all wood bookcase doors at **\$152 list.**

4-Hi Open Shelves	68ST30205417*	3543	30	20.25	54		175	23
	68ST30245417	3641	30	24.25	54		195	28
	68ST36205417	3723	36.25	20.25	54		195	26
	68ST36245417	3810	36.25	24.25	54		205	33

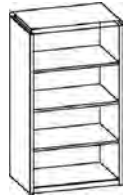

ORDERING NOTES:

Center shelf is fixed, upper and lower shelves are adjustable in increments of approximately 1-1/4".

5-Hi 4 Lateral Files & 1 Flip-Up Storage	68ST30206801*	7134	30	20.25	68		250	29
	68ST30246801	6933	30	24.25	68		300	35
	68ST36206801	7358	36.25	20.25	68		300	34
	68ST36246801	7448	36.25	24.25	68		360	40



5-Hi 2 Lateral Files, 2 Open Shelves & 1 Flip Up Door	68ST30206802*	6214	30	20.25	68		210	29
	68ST30246802	6254	30	24.25	68		220	35
	68ST36206802	6391	36.25	20.25	68		220	34
	68ST36246802	6468	36.25	24.25	68		230	40

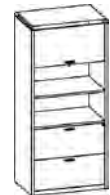

ORDERING NOTES:

Shelf is adjustable in increments of approximately 1-1/4".

DIMENSION KEY

W - width
D - depth
H - height

CODE DESCRIPTION

L - hinged left
R - hinged right

STANDARD FINISHES

For a complete list of standard wood finishes please see page 247.

MILLENNIUM | STORAGE

Description	Model	Cherry	W	D	H	Shipping Weight	Cubic Feet
		Walnut Maple					
5-Hi 2 Lateral Files & 3 Open Shelves	68ST30206803*	5911	30	20.25	68.25	190	29
	68ST30246803	5985	30	24.25	68.25	200	35
	68ST36206803	6057	36.25	20.25	68.25	200	34
	68ST36246803	6135	36.25	24.25	68.25	210	40



5-Hi 2 Lateral Files & 3 Closed Shelves	68ST30206804*	6619	30	20.25	68.25	213	29
	68ST30246804	6685	30	24.25	68.25	255	35
	68ST36206804	6764	36.25	20.25	68.25	255	34
	68ST36246804	6841	36.25	24.25	68.25	306	40



ORDERING NOTES:

Open shelves are adjustable in increments of approximately 1-1/4".

5-Hi 4 Lateral Files & 1 Open Shelf	68ST30206805*	7267	30	20.25	68.25	240	29
	68ST30246805	7309	30	24.25	68.25	290	35
	68ST36206805	7434	36.25	20.25	68.25	290	34
	68ST36246805	7534	36.25	24.25	68.25	350	40



ORDERING NOTES:

Interior shelves are adjustable in increments of approximately 1-1/4". Locks are available on all wood bookcase doors at **\$152 list**.

5-Hi 3 Lateral Files & 2 Open Shelves	68ST30206806*	7191	30	20.25	68.25	188	29
	68ST30246806	7284	30	24.25	68.25	225	35
	68ST36206806	7360	36.25	20.25	68.25	225	34
	68ST36246806	7424	36.25	24.25	68.25	270	40



ORDERING NOTES:

Open shelf is adjustable in increments of approximately 1-1/4".

5-Hi 3 Lateral Files & 2 Closed Shelves	68ST30206808*	7533	30	20.25	68.25	220	29
	68ST30246808	7684	30	24.25	68.25	230	35
	68ST36206808	7843	36.25	20.25	68.25	230	34
	68ST36246808	7997	36.25	24.25	68.25	240	40

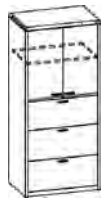

ORDERING NOTES:

Shelf is adjustable in increments of approximately 1-1/4". Locks are available on all wood bookcase doors at **\$152 list**.

ORDERING PROCEDURE

To order, please specify the following:

- 1) Krug product model number
- 2) Wood species and finish, see page 247
- 3) Wood edge detail- I,H, L or P, see page 250
- 4) Pull style, see page 250
- 5) Grommet location if applicable

*Indicates model illustrated by line drawing.

CODE DESCRIPTION

- L - hinged left
- R - hinged right

STANDARD FINISHES

For a complete list of standard wood finishes please see page 247.

PULLS/LOCKS

Wood door bookcases have pulls, glass door bookcases feature the Luna knob. Lateral file drawers include locks. Locks may be added to wood doors at an upcharge of **\$152 list**.

MILLENNIUM | STORAGE

Description	Model	Cherry Walnut Maple			W	D	H	Shipping Cubic	
								Weight	Feet
 5 Closed Shelves	68ST30206811*	5448	30	20.25	68.25	220	29		
	68ST30246811	5517	30	24.25	68.25	230	35		
	68ST36206811	5598	36.25	20.25	68.25	230	34		
	68ST36246811	5668	36.25	24.25	68.25	240	40		

ORDERING NOTES:

Second lowest shelf is fixed, all others are adjustable in increments of approximately 1-1/4". Locks are available on all wood bookcase doors at **\$152 list**.

 5-Hi 2 Closed Shelves, 2 Open & 1 Flip Up Door	68ST30206812*	5779	30	20.25	68.25	215	29
	68ST30246812	5819	30	24.25	68.25	225	35
	68ST36206812	5868	36.25	20.25	68.25	225	34
	68ST36246812	5944	36.25	24.25	68.25	235	40

ORDERING NOTES:

Open and interior shelves are adjustable in increments of approximately 1-1/4". Locks are available on all wood bookcase doors at **\$152 list**.

 5-Hi 2 Closed, 3 Open Shelves	68ST30206813*	4957	30	20.25	68.25	210	29
	68ST30246813	5042	30	24.25	68.25	220	35
	68ST36206813	5134	36.25	20.25	68.25	220	34
	68ST36246813	5213	36.25	24.25	68.25	230	40

ORDERING NOTES:

Open and interior shelves are adjustable in increments of approximately 1-1/4". Locks are available on all wood bookcase doors at **\$152 list**.

 5 Open Shelves	68ST30206817*	4634	30	20.25	68.25	200	29
	68ST30246817	4722	30	24.25	68.25	210	35
	68ST36206817	4755	36.25	20.25	68.25	210	34
	68ST36246817	4862	36.25	24.25	68.25	220	40

ORDERING NOTES:

Second lowest shelf is fixed, all others are adjustable in increments of approximately 1-1/4".

 5-Hi 2 Lateral Files & 3 Closed Shelves with Pocket Doors	68ST30206827*	7171	30	20.25	68.25	241	29
	68ST30246827	7314	30	24.25	68.25	291	35
	68ST36206827	7466	36.25	20.25	68.25	291	34
	68ST36246827	7612	36.25	24.25	68.25	350	40

ORDERING NOTES:

Interior shelves are adjustable in increments of approximately 1-1/4". Locks are available on all wood doors at **\$152 list**.

DIMENSION KEY

W - width
D - depth
H - height

CODE DESCRIPTION

L - hinged left
R - hinged right

STANDARD FINISHES

For a complete list of standard wood finishes please see page 247.

PULLS/LOCKS

Wood door bookcases have pulls, glass door bookcases feature the Luna knob. Lateral file drawers include locks. Locks may be added to wood doors at an upcharge of **\$152 list**.

MILLENNIUM | STORAGE

Description	Model	Cherry	W	D	H	Shipping Weight	Cubic Feet
		Walnut Maple					
5-Hi 2 Closed Shelves	68ST30206828*	5982	30	20.25	68.25	230	29
& 3 Closed Shelves	68ST30246828	6154	30	24.25	68.25	280	35
with Pocket Doors	68ST36206828	6284	36.25	20.25	68.25	280	34
	68ST36246828	6432	36.25	24.25	68.25	340	40



ORDERING NOTES:

Interior shelves are adjustable in increments of approximately 1-1/4". Locks are available on all wood doors at **\$152 list**.

5-Hi 5 Single Width Closed Shelves	68ST18246811L*	3890	18	24.25	68.25	186	21
	68ST18246811R	3890	18	24.25	68.25	186	21



ORDERING NOTES:

Second lowest shelf is fixed, all others are adjustable in increments of approximately 1-1/4". Locks are available on all wood doors at **\$152 list**.

6 Hi Open Shelves	68ST30208417*	6216	30.5	20.25	84	173	34
	68ST30248417	6298	30.5	24.25	84	208	40
	68ST36208417	6260	36	20.25	84	208	40
	68ST36248417	6378	36	24.25	84	250	47



ORDERING NOTES:

Second lowest shelf is fixed, all others are adjustable in increments of approximately 1-1/4".

6-Hi 4 Lateral Files & 2 Open Shelves	68ST30208405*	7332	30.5	20.25	84	257	34
	68ST30248405	7427	30.5	24.25	84	308	40
	68ST36208405	7375	36	20.25	84	308	40
	68ST36248405	7513	36	24.25	84	370	47

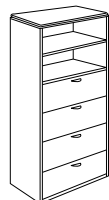

ORDERING NOTES:

Open shelves are adjustable in increments of approximately 1-1/4".

6-Hi 2 Lateral Files & 4 Open Shelves	68ST30208403*	6765	30.5	20.25	84	240	34
	68ST30248403	6862	30.5	24.25	84	250	40
	68ST36208403	6829	36	20.25	84	250	40
	68ST36248403	6936	36	24.25	84	270	47



ORDERING NOTES:

Open shelves are adjustable in increments of approximately 1-1/4".

ORDERING PROCEDURE

To order, please specify the following:

- 1) Krug product model number
- 2) Wood species and finish, see page 247
- 3) Wood edge detail- I,H, L or P, see page 250
- 4) Pull style, see page 250
- 5) Grommet location if applicable

*Indicates model illustrated by line drawing.

CODE DESCRIPTION

L - hinged left
R - hinged right

STANDARD FINISHES

For a complete list of standard wood finishes please see page 247.

PULLS/LOCKS

Wood door bookcases have pulls, glass door bookcases feature the Luna knob. Lateral file drawers include locks. Locks may be added to wood doors at an upcharge of **\$152 list**.

MILLENNIUM | STORAGE & WARDROBES

Description	Model	Cherry Walnut Maple			W	D	H	Shipping Weight	Cubic Feet
6-Hi 2 Lateral Files & 4 Closed Shelves 	68ST30208404*	7020			30.5	20.25	84	250	34
	68ST30248404	7114			30.5	24.25	84	260	40
	68ST36208404	7084			36	20.25	84	260	40
	68ST36248404	7195			36	24.25	84	280	47

6 Closed Shelves 	68ST18208411L*	4349			18	20.25	84	185	22
	68ST18208411R	4349			18	20.25	84	185	22
	68ST18248411L	4470			18	20.25	84	195	26
	68ST18248411R	4470			18	20.25	84	195	26

ORDERING NOTES:

Second lowest shelf is fixed, all others are adjustable in increments of approximately 1-1/4". Locks are available on all wood bookcase doors at **\$152 list**.

6 Open Shelves 	68ST18208417*	3762			18	20.25	84	168	22
	68ST18248417	4312			18	24.25	84	188	26

ORDERING NOTES:

Second lowest shelf is fixed, all others are adjustable in increments of approximately 1-1/4".

5 Hi Wardrobe 	68WR18246802L*	3353			18	24.25	68.25	150	21
	68WR18246802R	3353			18	24.25	68.25	150	21

ORDERING NOTES:

Locks are available on all wood doors at **\$152 list** per lock.

Wardrobe & Closed Shelves 	68WR30246801*	5134			30.5	24.25	68.25	237	35
	68WR36246801	5338			36	24.25	68.25	285	40

ORDERING NOTES:

Locks are available on all wood doors at **\$152 list** per lock. 24", 30" & 36" wardrobes require 2 locks.

DIMENSION KEY

W - width
D - depth
H - height

CODE DESCRIPTION

L - hinged left
R - hinged right

STANDARD FINISHES

For a complete list of standard wood finishes please see page 247.

PULLS/LOCKS

Wood door bookcases have pulls, glass door bookcases feature the Luna knob. Lateral file drawers include locks. Locks may be added to wood doors at an upcharge of **\$152 list** per lock.

MILLENNIUM | MODULAR TOPS

Description	Model	Cherry Walnut Maple			W	D	H	Shipping Weight	Cubic Feet
Full Width Wardrobe	68WR30246802*	4728	30.5	24.25	68.25	217	35		
	68WR36246802	4977	36	24.25	68.25	265	40		

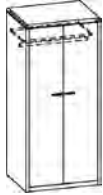

ORDERING NOTES:

Locks are available on all wood doors at **\$152 list** per lock. 24", 30" & 36" wardrobes require 2 locks.

Modular Tops	Model		Cherry Walnut Maple			W	D	H	Shipping Weight	Cubic Feet
	68TP3624	982	35.75	24	-	31.5	2.25			
	68TP3630	1106	35.75	30	-	37.5	2.75			
	68TP3636	1328	35.75	36	-	43.5	3.25			
	68TP4224	1032	41.75	24	-	35.5	2.25			
	68TP4230	1155	41.75	30	-	42.5	2.75			
	68TP4236	1386	41.75	36	-	49.5	3.25			
	68TP4824	1083	47.75	24	-	39.5	3.75			
	68TP4830	1212	47.75	30	-	47.5	2.5			
	68TP4836	1456	47.75	36	-	55.5	3			
	68TP5424	1136	53.75	24	-	43.5	3.5			
	68TP5430	1284	53.75	30	-	52.5	4.25			
	68TP5436	1540	53.75	36	-	61.5	3.25			
	68TP6020	1164	59.75	20	-	41.5	4			
	68TP6024	1244	59.75	24	-	47.5	4.75			
	68TP6030	1584	59.75	30	-	57.5	3.25			
	68TP6036	1632	59.75	36	-	67.5	3.75			
	68TP6620	1479	65.75	20	-	44.5	4.5			
	68TP6624	1528	65.75	24	-	51.5	5.25			
	68TP6630	1584	65.75	30	-	62.5	3.5			
	68TP6636	1791	65.75	36	-	72.5	4			
	68TP7120	1689	71.75	20	-	47.5	4.75			
	68TP7124	1745	71.75	24	-	55.5	5.5			
	68TP7130	1792	71.75	30	-	67.5	3.75			
	68TP7136	1955	71.75	36	-	78.5	4.25			
	68TP7820	1845	77.75	20	-	59	5.25			
	68TP7824	1902	77.75	24	-	68	6			
	68TP7830	1957	77.75	30	-	80	4.25			
	68TP7836	2353	77.75	36	-	93	5			
	68TP8420	1938	83.75	20	-	63	6			
	68TP8424	1991	83.75	24	-	72	7			
68TP8430	2048	83.75	30	-	85	4				
68TP8436	2461	83.75	36	-	99	6.5				
68TP9024	1755	89.75	24	-	76	5				
68TP9030	2197	89.75	30	-	90	5.75				
68TP9036	2636	89.75	36	-	105	6.75				
68TP9620	2228	95.75	20	-	69	5				
68TP9624	2291	95.75	24	-	79	5				
68TP9630	2359	95.75	30	-	95	5.75				
68TP9636	2828	95.75	36	-	111	6.75				

ORDERING PROCEDURE

To order, please specify the following:

- 1) Krug product model number
- 2) Wood species and finish, see page 247
- 3) Wood edge detail- I, H, L or P, see page 250
- 4) Pull style, see page 250
- 5) Grommet location if applicable

*Indicates model illustrated by line drawing.

CODE DESCRIPTION

L - hinged left
 R - hinged right
 G - glass doors
 BC - bookcase
 ST - storage
 STCE- curved corner storage unit

STANDARD FINISHES

For a complete list of standard wood finishes please see page 247.

PULLS/LOCKS

Wood door bookcases have pulls, glass door bookcases feature the Luna knob. Lateral file drawers include locks. Locks may be added to wood doors at an upcharge of **\$152 list per lock**.

MILLENNIUM | MODULAR TOPS

Description	Model	Cherry	W	D	H	Shipping Weight	Cubic Feet
		Walnut Maple					
	68TPR3624L	982	35.75	24	-	31.5	2.25
	68TPR3624R	982	35.75	24	-	31.5	2.25
	68TPR3630L	1106	35.75	30	-	37.5	2.75
	68TPR3630R	1106	35.75	30	-	37.5	2.75
	68TPR3636L	1328	35.75	36	-	43.5	3.25
	68TPR3636R	1328	35.75	36	-	43.5	3.25
	68TPR4220L	901	41.75	20	-	31.5	2.25
	68TPR4220R	901	41.75	20	-	31.5	2.25
	68TPR4224L	1032	41.75	24	-	35.5	2.75
	68TPR4224R	1032	41.75	24	-	35.5	2.75
	68TPR4230L	1155	41.75	30	-	42.5	3.25
	68TPR4230R	1155	41.75	30	-	42.5	3.25
	68TPR4236L	1386	41.75	36	-	49.5	3.75
	68TPR4236R	1386	41.75	36	-	49.5	3.75
	68TPR4820L	932	47.75	20	-	34.5	2.5
	68TPR4820R	932	47.75	20	-	34.5	2.5
	68TPR4824L	979	47.75	24	-	39.5	3
	68TPR4824R	979	47.75	24	-	39.5	3
	68TPR4830L	1212	47.75	30	-	47.5	3.25
	68TPR4830R	1212	47.75	30	-	47.5	3.25
	68TPR4836R	1456	47.75	36	-	55.5	3.75
	68TPR4836L	1456	47.75	36	-	55.5	3.75
	68TPR5424L	1207	53.75	24	-	47.5	2.5
	68TPR5424R	1207	53.75	24	-	47.5	2.5
	68TPR5430L	1284	53.75	30	-	55.5	3
	68TPR5430R	1540	53.75	30	-	55.5	3
	68TPR5436L	1284	53.75	36	-	43.5	3.5
	68TPR5436R	1540	53.75	36	-	43.5	3.5
	68TPR6024R	1244	59.75	24	-	52.5	4.25
	68TPR6024L	1244	59.75	24	-	52.5	4.25
	68TPR6030L	1378	59.75	30	-	61.5	3.25
	68TPR6030R	1378	59.75	30	-	61.5	3.25
	68TPR6036L	1632	59.75	36	-	41.5	4
	68TPR6036R	1632	59.75	36	-	41.5	4
	68TPR6624L	1461	65.75	24	-	47.5	4.75
	68TPR6624R	1461	65.75	24	-	47.5	4.75
	68TPR6630L	1584	65.75	30	-	57.5	3.25
	68TPR6630R	1584	65.75	30	-	57.5	3.25
	68TPR6636L	1452	65.75	36	-	67.5	3.75
	68TPR6636R	1452	65.75	36	-	67.5	3.75
68TPR7124L	1669	71.75	24	-	44.5	4.5	
68TPR7124R	1669	71.75	24	-	44.5	4.5	
68TPR7130L	1792	71.75	30	-	51.5	5.25	
68TPR7130R	1792	71.75	30	-	51.5	5.25	
68TPR7136L	1955	71.75	36	-	62.5	3.5	
68TPR7136R	1955	71.75	36	-	62.5	3.5	
68TPR7824L	1686	77.75	24	-	44.5	4.5	
68TPR7824R	1686	77.75	24	-	44.5	4.5	
68TPR7830L	1809	77.75	30	-	51.5	5.25	
68TPR7830R	1809	77.75	30	-	51.5	5.25	
68TPR7836L	1990	77.75	36	-	62.5	3.5	
68TPR7836R	1990	77.75	36	-	62.5	3.5	
68TPR8424L	2004	83.75	24	-	72	4	
68TPR8424R	2004	83.75	24	-	72	4	
68TPR8430L	2048	83.75	30	-	85	4.75	
68TPR8430R	2048	83.75	30	-	85	4.75	
68TPR8436L	2461	83.75	36	-	99	5.5	
68TPR8436R	2461	83.75	36	-	99	5.5	

DIMENSION KEY

W - width
D - depth
H - height

CODE DESCRIPTION

L - left handed
R - right handed

STANDARD FINISHES

For a complete list of standard wood finishes please see page 247.

MILLENNIUM | PEDESTALS

Description	Model	Cherry	W	D	H	Shipping Weight	Cubic Feet
		Walnut Maple					
Deep Pedestal	68PD4D*	2243	15.75	28.75	26.75	108	9
	68PD4F	2388	15.75	28.75	26.75	110	9

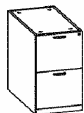

ORDERING NOTES:

Deep pedestals have unfinished tops and backs. Backs may be finished at an upcharge of **\$173 per list**. Please specify at time of order.

Shallow Pedestal	68PS4D	2084	15.75	18.75	26.75	74	6
	68PS4F*	2230	15.75	18.75	26.75	76	6

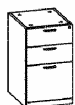

ORDERING NOTES:

Shallow pedestals have unfinished tops and backs. Backs may be finished at an upcharge of **\$173 per list**. Please specify at time of order.

Bookcase Pedestal	68PS4BC15L*	1698	15.75	18.75	26.75	70	6
	68PS4BC15R	1698	15.75	18.75	26.75	70	6



ORDERING NOTES:

Bookcase pedestals have unfinished tops and backs. Backs may be finished at an upcharge of **\$173 list**. Please specify at time of order. Locks on bookcase pedestal doors are available at **\$152 list**. Please specify at time of order.

Shallow Bookcase Pedestal	68PS4BC30	2377	30	18.75	27	90	11
	68PS4BC36*	2533	35.5	18.75	27	107	13
	68PS4BC42	2684	41.5	18.75	27	125	15

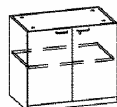

ORDERING NOTES:

Bookcase pedestals have unfinished tops and backs. Backs may be finished at an upcharge of **\$255 list**. Please specify at time of order. Locks on bookcase pedestal doors are available at **\$152 list**. Please specify at time of order.

Lateral File Pedestal - Shallow	68PS4LF30*	2839	30	18.75	27	114	11
	68PS4LF36	2999	35.5	18.75	27	135	13
	68PS4LF42	3160	41.5	18.75	27	158	15

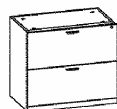

ORDERING NOTES:

Lateral file pedestals have unfinished tops and backs. Backs may be finished at an upcharge of **\$255 list**. Please specify at time of order.

ORDERING PROCEDURE

To order, please specify the following:

- 1) Krug product model number
- 2) Wood species and finish, see page 247
- 3) Wood edge detail- I, H, L or P, see page 250
- 4) Pull style, see page 250
- 5) Grommet location if applicable

*Indicates model illustrated by line drawing.

CODE DESCRIPTION

4 - full height pedestal
 L - hinged left
 R - hinged right
 D - 2 file drawer
 , 1 file drawer
 LF- lateral file
 BC - bookcase

STANDARD FINISHES

For a complete list of standard wood finishes please see page 247.

PEDESTALS

Pedestals are designed for use with open shells or open returns. Pedestals require field installation in shell units and are secured in place with the provided hardware.

MILLENNIUM | PEDESTALS

Description	Model	Cherry	W	D	H	Shipping Weight	Cubic Feet
		Walnut Maple					
Lateral File Storage Pedestal	68PLF36192901	3294	35.5	18.75	27	117	13



ORDERING NOTES:

Only lower lateral file drawer locks. Storage pedestals have unfinished tops and backs. Backs may be finished at an upcharge of **\$255 list**. Please specify at time of order.

Combination Storage Pedestal	68PLF36192902*	3363	35.5	18.75	27	117	13
	68PLF36192904	3363	35.5	18.75	27	117	-



ORDERING NOTES:

Only lower lateral file drawer locks. Storage pedestals have unfinished tops and backs. Backs may be finished at an upcharge of **\$255 list**. Please specify at time of order.

Ganged Pedestal	68PS4DD	4016	31.5	18.75	26.75	148	12
	68PS4DF	4193	31.5	18.75	26.75	152	12
	68PS4FD*	4193	31.5	18.75	26.75	150	12
	68PS4FF	4328	31.5	18.75	26.75	152	12

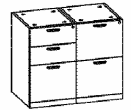

ORDERING NOTES:

Ganged pedestals have unfinished tops and backs. Backs may be finished at an upcharge of **\$255 list**. Please specify at time of order.

Mobile Pedestal	68MPD4D	2397	15.75	28.75	26.75	108	9
	68MPD4F**	2549	15.75	28.75	26.75	110	9
	68MPS4D*	2219	15.75	18.75	26.75	74	6
	68MPS4F	2370	15.75	18.75	26.75	76	6

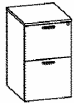

ORDERING NOTES:

Mobile pedestals have finished tops and backs. Please see page 257 for upholstered seat option.

CPU Pedestal	68MPCPU22L	1240	15.75	22	26.75	75	6
	68MPCPU22R*	1240	15.75	22	26.75	75	6



ORDERING NOTES:

This unit will not fit under a 20" worksurface. Dimensions inside unit are 11.5" wide, 21" deep and 23.5" high.

DIMENSION KEY

W - width
D - depth
H - height

CODE DESCRIPTION

4 - full height pedestal
L - hinged left
R - hinged right
D - 2 file drawer
F - 2 box, 1 file drawer
LF- lateral file
BC- bookcase

STANDARD FINISHES

For a complete list of standard wood finishes please see page 247.

PEDESTALS

Pedestals are designed for use with open shells or open returns. Pedestals require field installation in shell units and are secured in place with the provided hardware..

MILLENNIUM | RECEPTION

Description	Model	Cherry Walnut Maple	W	D	H	KW	Shipping Weight	Cubic Feet	
	Reception Desk, Full Height Pedestals	68GD60304LFRF	7677	60	30	28.5	27.5	270	44
		68GD60304LORF	6439	60	30	28.5	42.5	270	44
		68GD60304LFR0	6439	60	30	28.5	42.5	270	44
		68GD66304LFRF	7846	65.75	30	28.5	33.25	290	48
		68GD66304LORF	6659	65.75	30	28.5	48.25	290	48
		68GD66304LFR0	6633	65.75	30	28.5	48.25	290	48
		68GD71304LFRF	7971	72.75	30	28.5	40	310	51
		68GD71304LORF*	6713	72.25	30	28.5	54.75	310	51
		68GD71304LFR0	6713	72.75	30	28.5	54.75	310	51
		68GD84304LFRF	8118	84	30	28.5	51.5	330	61
		68GD84304LORF	6806	84	30	28.5	66.5	330	61
		68GD84304LFR0	6806	84	30	28.5	66.5	330	61
		68GD96304LFRF	8366	95.75	30	28.5	63.25	350	69
		68GD96304LORF	7198	95.75	30	28.5	78.25	350	69
		68GD96304LFR0	7198	95.75	30	28.5	78.25	350	69

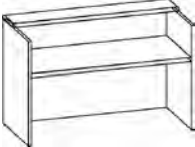
	Reception Desk Shell	68GDS6630	4306	65.25	30	28.5	63	235	45
		68GDS7130	4402	70.5	30	28.5	69.75	250	48
		68GDS8430*	4527	83.5	30	28.5	81.25	275	58
		68GDS9630	4654	95.5	30	28.5	93	295	66

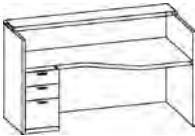
	Reception Corner Desk with Full Height Pedestals	68GCD7124L4F	6616	72.5	36.25	28.5	54.75	280	54
		68GCD7124L4D	6616	72.5	36.25	28.5	54.75	280	54
		68GCD7124R4F	6616	72.5	36.25	28.5	54.75	280	54
		68GCD7124R4D	6616	72.5	36.25	28.5	54.75	280	54
		68GCD8424L4F*	6808	84	36.25	28.5	66.5	310	64
		68GCD8424L4D	6808	84	36.25	28.5	66.5	310	64
		68GCD8424R4F	6808	84	36.25	28.5	66.5	310	64
		68GCD8424R4D	6808	84	36.25	28.5	66.5	310	64
		68GCD9624L4F	7228	95.75	36.25	28.5	78.25	330	73
		68GCD9624L4D	7228	95.75	36.25	28.5	78.25	330	73
		68GCD9624R4F	7228	95.75	36.25	28.5	78.25	330	73
		68GCD9624R4D	7228	95.75	36.25	28.5	78.25	330	73

ORDERING NOTES:

Laminate worksurfaces are available at a 10% upcharge. Optional reveals are available at an upcharge of **\$290 list** per running foot of surface area.

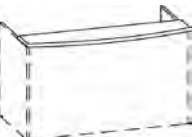
	Bow Shaped Transaction Top Option	BT60	227	-	-	-	-	-
		BT66	233	-	-	-	-	-
		BT72	235	-	-	-	-	-
		BT84	267	-	-	-	-	-
		BT96*	302	-	-	-	-	-

ORDERING PROCEDURE

To order, please specify the following:

- 1) Krug product model number
- 2) Wood species and finish, see page 247
- 3) Wood edge detail- I, H, L or P, see page 250
- 4) Pull style, see page 250
- 5) Grommet location if applicable

*Indicates model illustrated by line drawing.

CODE DESCRIPTION

- 0 - no pedestal
- 3 - 3/4 height pedestal
- 4 - full height pedestal
- L - left handed pedestal position
- R - right handed pedestal position
- D - 2 file drawer
- F - 2 box, 1 file drawer

STANDARD FINISHES

For a complete list of standard wood finishes please see page 247.

RECEPTION PANELS

Reception desks, returns, linking units and credenzas have 43" high perimeter panels.

INLAY OPTION

Add 10% list for optional laminate inlay.

MILLENNIUM | RECEPTION

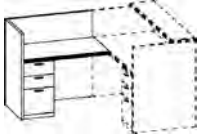
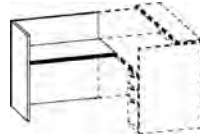
Description	Model	Cherry Walnut Maple	W	D	H	KW	Shipping Weight	Cubic Feet	
Reception Return, Desk Height with Full Height Pedestals 	68GRH3624L4D	3924	36.25	24.25	28.5	20	154	25	
	68GRH3624L4F	3924	36.25	24.25	28.5	20	154	25	
	68GRH3624R4D	3924	36.25	24.25	28.5	20	154	25	
	68GRH3624R4F	3924	36.25	24.25	28.5	20	154	25	
	68GRH4224L4D	4155	42.5	24.25	28.5	26.5	176	29	
	68GRH4224L4F*	4155	42.5	24.25	28.5	26.5	176	29	
	68GRH4224R4D	4155	42.5	24.25	28.5	26.5	176	29	
	68GRH4224R4F	4155	42.5	24.25	28.5	26.5	176	29	
	68GRH4824L4D	4277	48.5	24.25	28.5	32.25	202	33	
	68GRH4824L4F	4277	48.5	24.25	28.5	32.25	202	33	
	68GRH4824R4D	4277	48.5	24.25	28.5	32.25	202	33	
	68GRH4824R4F	4277	48.5	24.25	28.5	32.25	202	33	
	68GRH5424L4D	4369	54.25	24.25	28.5	38	224	37	
	68GRH5424L4F	4369	54.25	24.25	28.5	38	224	37	
	68GRH5424R4D	4369	54.25	24.25	28.5	38	224	37	
	68GRH5424R4F	4369	54.25	24.25	28.5	38	224	37	
	68GRH6024L4D	4458	60	24.25	28.5	44	245	41	
	68GRH6024L4F	4458	60	24.25	28.5	44	245	41	
	68GRH6024R4D	4458	60	24.25	28.5	44	245	41	
	68GRH6024R4F	4458	60	24.25	28.5	44	245	41	
	68GRH6624L4D	4560	66.25	24.25	28.5	54	269	46	
	68GRH6624L4F	4560	66.25	24.25	28.5	54	269	46	
	68GRH6624R4D	4560	66.25	24.25	28.5	54	269	46	
	68GRH6624R4F	4560	66.25	24.25	28.5	54	269	46	
	68GRH7124L4D	4707	72	24.25	28.5	59	292	50	
	68GRH7124L4F	4707	72	24.25	28.5	59	292	50	
	68GRH7124R4D	4707	72	24.25	28.5	59	292	50	
	68GRH7124R4F	4707	72	24.25	28.5	59	292	50	
	Open Reception Return, Desk Height 	68GRH3620L	2168	36.25	20.25	28.5	35	102	21
		68GRH3620R	2168	36.25	20.25	28.5	35	102	21
		68GRH3624L	2201	36.25	24.25	28.5	35	122	25
		68GRH3624R	2201	36.25	24.25	28.5	35	122	25
		68GRH4220L*	2239	42.5	20.25	28.5	41	120	25
68GRH4220R		2239	42.5	20.25	28.5	41	120	25	
68GRH4224L		2271	42.5	24.25	28.5	41	144	29	
68GRH4224R		2271	42.5	24.25	28.5	41	144	29	
68GRH4820L		2297	48.5	20.25	28.5	47	142	28	
68GRH4820R		2297	48.5	20.25	28.5	47	142	28	
68GRH4824L		2326	48.5	24.25	28.5	47	170	33	
68GRH4824R		2326	48.5	24.25	28.5	47	170	33	
68GRH5420L		2366	54.25	20.25	28.5	53	160	32	
68GRH5420R		2366	54.25	20.25	28.5	53	160	32	
68GRH5424L		2398	54.25	24.25	28.5	53	192	37	
68GRH5424R		2398	54.25	24.25	28.5	53	192	37	
68GRH6020L		2422	60	20.25	28.5	58.75	178	41	
68GRH6020R		2422	60	20.25	28.5	58.75	178	41	
68GRH6024L		2427	60	24.25	28.5	58.75	213	41	
68GRH6024R		2427	60	24.25	28.5	58.75	213	41	
68GRH6620L		2464	66.25	20.25	28.5	65	198	39	
68GRH6620R		2464	66.25	20.25	28.5	65	198	39	
68GRH6624L		2526	66.25	24.25	28.5	65	237	46	
68GRH6624R		2526	66.25	24.25	28.5	65	237	46	
68GRH7120L		2555	72	20.25	28.5	70.75	217	42	
68GRH7120R		2555	72	20.25	28.5	70.75	217	42	
68GRH7124L		2597	72	24.25	28.5	70.75	260	50	
68GRH7124R		2597	72	24.25	28.5	70.75	260	50	

DIMENSION KEY

W - width
D - depth
H - height

CODE DESCRIPTION

0 - no pedestal
H - desk height
4 - full height pedestal



STANDARD FINISHES

For a complete list of standard wood finishes please see page 247.

LAMINATE

Laminate worksurfaces are available at a 10% upcharge. Optional reveals are available at an upcharge of **\$290 list** per running foot of surface area.

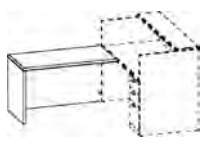
MILLENNIUM | RECEPTION

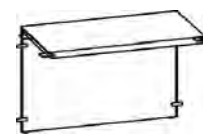
Description	Model	Cherry Walnut Maple	W	D	H	KW	Shipping	Cubic
							Weight	Feet
 Open Return, Desk Height for Reception Unit	68RHD2024L	2161	20	24.25	28.5	18.75	50	11
	68RHD2024R	2161	20	24.25	28.5	18.75	50	11
	68RHD2424L	2211	24	24.25	28.5	22.75	55	13
	68RHD2424R	2211	24	24.25	28.5	22.75	55	13
	68RHD3024L	2263	30	24.25	28.5	28.5	60	15
	68RHD3024R	2263	30	24.25	28.5	28.5	60	15
	68RHD3624L	2328	36	24.25	28.5	34.5	67	18
	68RHD3624R	2328	36	24.25	28.5	34.5	67	18
	68RHD4224L*	2359	42	24.25	28.5	40.5	75	21
	68RHD4224R	2359	42	24.25	28.5	40.5	75	21
	68RHD4824L	2415	48	24.25	28.5	46.5	82	23
	68RHD4824R	2415	48	24.25	28.5	46.5	82	23
	68RHD5424L	2462	54	24.25	28.5	52.5	90	26
	68RHD5424R	2462	54	24.25	28.5	52.5	90	26
	68RHD6024L	2531	60	24.25	28.5	58.5	97	29
	68RHD6024R	2531	60	24.25	28.5	58.5	97	29
	68RHD6624L	2593	65.75	24.25	28.5	64.5	105	32
	68RHD6624R	2593	65.75	24.25	28.5	64.5	105	32
	68RHD7124L	2659	71	24.25	28.5	69.5	113	34
	68RHD7124R	2659	71	24.25	28.5	69.5	113	34
68RHD8424L	2756	84	24.25	28.5	82.75	120	40	
68RHD8424R	2756	84	24.25	28.5	82.75	120	40	
 Reception Linking Unit, Desk Height	68GLU3624H	2148	35.25	24.25	28.5		90	24
	68GLU4224H	2252	41.5	24.25	28.5		100	28
	68GLU4824H*	2373	47.5	24.25	28.5		110	32
	68GLU6024H	2684	59.5	24.25	28.5		130	41
	68GLU6624H	2768	65.25	24.25	28.5		140	45
	68GLU7124H	2877	70.5	24.25	28.5		150	49
 Linking Unit, Desk Height for Reception Unit	68LUD3024HL	1957	29.75	24.25	28.5		57	6
	68LUD3024HR	1957	29.75	24.25	28.5		57	6
	68LUD3624HL	1991	35.75	24.25	28.5		68	7
	68LUD3624HR	1991	35.75	24.25	28.5		68	7
	68LUD4224HL	2145	41.75	24.25	28.5		82	8
	68LUD4224HR*	2145	41.75	24.25	28.5		82	8
	68LUD4824HL	2193	47.75	24.25	28.5		97	9
	68LUD4824HR	2193	47.75	24.25	28.5		97	9
	68LUD5424HL	2272	54.5	24.25	28.5		111	10
	68LUD5424HR	2272	54.5	24.25	28.5		111	10
	68LUD6024HL	2301	59.75	24.25	28.5		123	11
	68LUD6024HR	2301	59.75	24.25	28.5		123	11
	68LUD6624HL	2337	65.5	24.25	28.5		137	12
	68LUD6624HR	2337	65.5	24.25	28.5		137	12
68LUD7124HL	2376	70.75	24.25	28.5		148	13	
68LUD7124HR	2376	70.75	24.25	28.5		148	13	

ORDERING NOTES:

Laminate worksurfaces are available at a 10% upcharge.

ORDERING PROCEDURE

To order, please specify the following:

- 1) Krug product model number
- 2) Wood species and finish, see page 247
- 3) Wood edge detail- I, H, L or P, see page 250
- 4) Pull style, see page 250
- 5) Grommet location if applicable

*Indicates model illustrated by line drawing.

CODE DESCRIPTION

- 4 - full height pedestal
- L - hinged left
- R - hinged right
- D - 2 file drawer
- F - 2 box, 1 file drawer

STANDARD FINISHES

For a complete list of standard wood finishes please see page 247.

PEDESTALS

Pedestals are designed for use with open shells or open returns. Pedestals require field installation in shell units and are secured in place with the provided hardware.

MILLENNIUM | RECEPTION

Description	Model	Cherry		W	D	H	Shipping Weight	Cubic Feet
		Walnut	Maple					
	68GRT60	1180		60.5	12	-	25	1
	68GRT66	1244		66.5	12	-	35	1
	68GRT71*	1314		72.5	12	-	45	2
	68GRT78	1394		78.5	12	-	48	2.5
	68GRT84	1479		84.5	12	-	53	3
	68GRT90	1539		90	12	-	56	3

ORDERING NOTES:

Reception Return Transaction Top is designed to be used with a 42" return.

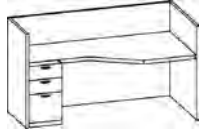
Description	Model	Cherry		W	D	H	Shipping Weight	Cubic Feet	
		Walnut	Maple						
	68GCC7124L4F	5825		71.75	36.25	28.5	54.75	270	54
	68GCC7124R4F	5825		71.75	36.25	28.5	54.75	270	54
	68GCC7124L4D	5825		71.75	36.25	28.5	54.75	270	54
	68GCC7124R4D	5825		71.75	36.25	28.5	54.75	270	54
	68GCC8424L4F	6463		83.5	36.25	28.5	66.5	290	54
	68GCC8424R4F	6463		83.5	36.25	28.5	66.5	290	54
	68GCC8424L4D	6463		83.5	36.25	28.5	66.5	290	54
	68GCC8424R4D	6463		83.5	36.25	28.5	66.5	290	54
	68GCC9024L4F*	6615		89.5	36.25	28.5	72.5	300	64
	68GCC9024R4F	6615		89.5	36.25	28.5	72.5	300	64
	68GCC9024L4D	6615		89.5	36.25	28.5	72.5	300	64
	68GCC9024R4D	6615		89.5	36.25	28.5	72.5	300	64
	68GCC9624L4F	7474		95.25	36.25	28.5	78.25	310	69
	68GCC9624R4F	7474		95.25	36.25	28.5	78.25	310	69
	68GCC9624L4D	7474		95.25	36.25	28.5	78.25	310	69
68GCC9624R4D	7474		95.25	36.25	28.5	78.25	310	69	

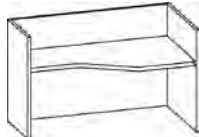
Description	Model	Cherry		W	D	H	Shipping Weight	Cubic Feet	
		Walnut	Maple						
	68GCC6624L	4287		65.25	36.25	28.5	63	250	69
	68GCC6624R	4287		65.25	36.25	28.5	63	250	69
	68GCC7124L*	4369		71.75	36.25	28.5	69.75	260	73
	68GCC7124R	4369		71.75	36.25	28.5	69.75	260	73
	68GCC8424L	4420		83.5	36.25	28.5	81.25	270	73
	68GCC8424R	4420		83.5	36.25	28.5	81.25	270	73
	68GCC9624L	4684		85.25	36.25	28.5	93	290	73
	68GCC9624R	4684		85.25	36.25	28.5	93	290	73

Description	Model	Cherry		W	D	H	Shipping Weight	Cubic Feet	
		Walnut	Maple						
	68GCS6624	3733		65.25	24.25	28.5	63	235	45
	68GCS7124	3839		71.75	24.25	28.5	69.75	255	47
	68GCS8424*	3885		83.5	24.25	28.5	81.25	275	58
	68GCS9624	4039		95.25	24.25	28.5	93	295	66

ORDERING NOTES:

Laminate worksurfaces are available at a 10% upcharge. Optional reveals are available at an upcharge of **\$290 list** per running foot of surface area.

DIMENSION KEY

W - width
D - depth
H - height

CODE DESCRIPTION

0 - no pedestal
3 - 3/4 height pedestal
4 - full height pedestal
L - left handed pedestal position
R - right handed pedestal position
D - 2 file drawer
F - 2 box, 1 file drawer

STANDARD FINISHES

For a complete list of standard wood finishes please see page 247.

RECEPTION PANELS

Reception desks, returns, linking units and credenzas have 43" high perimeter panels.

INLAY OPTION

Add 10% list for optional laminate inlay.

GENERAL INFORMATION

Terms and Conditions

Net 30 days on approved credit. A late payment charge of 1% per month will be applied on overdue invoices. This charge will be pro-rated to the number of days past 30 days that the invoice is overdue. All applicable sales taxes are extra. Distribution of this price list does not in itself constitute an offer to sell. Orders can be received only from authorized Krug dealers. Acceptance of any order and terms of sale may be established at the discretion of Krug. Deposits are required on orders received from new accounts as well as on large or special orders. Krug reserves the right to discontinue designs, or to change designs, construction, prices, or materials without notice.

Contact Information

Phone: 1.888.578.KRUG (5784) | Fax: 1.519.748.5177

Purchase Order Fax: 1.888.236.4783

Purchase Order E-mail: orders@krug.ca

Web: www.krug.ca E-mail: solutions@krug.ca

Customer Service Hours

Please note customer service hours are:

8:30 am to 5:00 pm est

Customer Satisfaction

It is the primary goal of Krug and our staff to ensure the complete satisfaction of our customers with our products and performance. If a problem arises with a Krug product after the expiration of the limited warranty period, Krug will exercise its best efforts to achieve the satisfaction of the customer in a manner that is fair to all concerned.

Order Acknowledgments

Each order will be acknowledged via e-mail or fax. This acknowledgment is the final agreement between Krug and the customer, superseding all previous communications regarding the purchase order. Where there is a discrepancy on a purchase order between a product code and a description, Krug will make every effort to resolve the discrepancy, but will be ruled by the product code ordered. Please check all acknowledgments for accuracy, and advise Krug of any discrepancies with a purchase order.

Order Cancellation

Krug reserves the right to not accept or allow cancellation of orders. All products are manufactured on a custom-made, make-to-order basis, and the purchasing, engineering and production of orders begins shortly after order placement - and the customer purchase order is a contract that authorizes Krug to manufacture the products. Acceptance of order cancellation (or partial cancellation) is solely at the discretion of Krug, and is dependent on the extent to which engineering, purchasing and manufacturing has been initiated by the time cancellation is requested. No order cancellations (partial or otherwise) are allowable more than 4 weeks from date of order placement (as order production is unable to be terminated by that point), and full payment of the acknowledged order value is required for any orders cancelled after 4 weeks. Cancellations may be allowable in less than 4 weeks after order placement, depending on the extent to which manufacturing has been initiated. An acceptance of order cancellation requires that the purchaser agrees to make payment for all costs incurred to the point of acceptance of cancellation. Cancellation charges include all costs for purchase of dedicated material and components, engineering costs for non-standard products, and all costs for manufacturing completed to that point, as well as a \$350 net charge for processing of the original order and for processing of cancellation invoicing.

Pricing

Krug endeavors to ensure that all prices in this price list reflect accurately our current prices. However, errors do occur and will be rectified through notices to the field. Krug reserves the right to acknowledge pricing that may be different from the price list.

Warranty

Krug warrants the construction and the finish of all our products to be free from defects in materials and workmanship for a period of 10 years from the date of purchase. This warranty is applicable to products in use by their original purchaser. This warranty does not apply to components not manufactured by Krug including textiles, which are subject to the specific warranties of those manufacturers,

if any. Textiles (fabric, leather, vinyl, or any other covering material) suppliers do not guarantee their products for durability and color fastness, and nor does Krug. Casters, mechanical and electrical components have a warranty of five years from the date of purchase. The Krug warranty does not apply to COM-specified materials, damage caused by a carrier other than Krug, or variation in wood finishes due to natural wood color variation. Krug cannot be held responsible for variations in fabric dye lots from order to order. All fabric is carefully inspected when it is received, but a degree of variation in color should be expected. Repairs or replacement of any defect covered under this warranty by Krug will be made, at our option and method, at no charge to the original purchaser during the warranty period. Krug's judgement is final and binding with respect to the nature or cause of defects or damage, and the necessity or manner of repair or replacement.

This warranty does not apply to defects or damage resulting from:

- normal wear and tear occurring with the use of the product
- negligence, misuse, excessive use, alteration, improper cleaning or repair
- substitution or use of incorrect or unauthorized components or material
- handling or installation that is incorrect, or that causes damage or defect
- damage incurred by a freight carrier other than Krug
- wearing of finishes and fabrics, and normal variations in material (including dye lot variations)
- properties of natural materials, including wood and leather
- exposure to environments with uncontrolled temperature and humidity (products must be transported, stored and used in climate-controlled conditions)

Note, specific warranties for components and materials not manufactured by Krug:

Height Adjustable Mechanism Warranty

Krug warrants to the original consumer purchaser its Height Adjustable Mechanism that it will be free from defects in material and workmanship. This limited warranty covers material and manufacturing defects, which cause a non-conformance in the function of a table base and is limited to the following products and warranty term determined from their dates of purchase:

- a) Electronic components such as control boxes, hand switches and motors – two (2) years
- b) Mechanical components such as crank drives, spindles – five (5) years
- c) Structural components such as J-channels, feet and top supports – ten (10) years

The start of the warranty period is the documented date of your purchase of the product. The warranty herein is made to and for the benefit of the original consumer purchaser of the product and is non-transferable. If you discover a defect in material or workmanship during the warranty period, and Krug agrees that the defect exists, Krug will, at its option, repair or replace the Product at no charge to you, provided it is returned during the warranty period. In the unlikely event that your product should require repair or replacement during the warranty period, please contact Krug to obtain warranty service. The warranty period on replacement products is the remainder of the warranty on the original product or 30 days, whichever is longer.

Testing

All Krug Conference products meet or exceed the testing requirements of ANSI/BIFMA X5.5-2014 or X5.9-2012.



Dimensions

Dimensions are in inches and approximate, and subject to change without notice. Contact Customer Service if dimensions are critical.

Installation Support

For assistance please contact Technical Support at 1-888-578-5784 x216 or e-mail installationhelp@krug.ca and you will be directed to the appropriate installation support person.

Storage Charges

Krug reserves the right to assess a nominal storage charge if a customer does not accept shipment of an order within a week of the ship date.

Export Packaging

Krug is pleased to provide the option for export packaging on all our products, to provide additional protection from damage. For shipments overseas, a quote for export packaging can be provided, based on the products to be ordered and the delivery destination - please contact Customer Service or Bids & Specification Support for more information and a quotation. KRUG is not responsible for shipment damage occurring on overseas shipments

Export Packaging is **STRONGLY RECOMMENDED** for:

- (A) all shipments outside of the lower 48 states and Canada
 - (B) all shipments that will be held in storage for an extended period prior to installation. Important: Please note that Krug will not be responsible for damage claims on product shipped or stored in the above conditions where export packaging has not been utilized.
- Please contact Customer Service for specifications or any other assistance regarding export packaging.

Freight Terms and Conditions

1. All product is shipped FOB the Krug factory. Freight is either pre-paid to the destination or not pre-paid, depending on established customer specific freight terms.
2. Docks at the selected delivery location must be equipped to handle a 53' trailer. If a dock is inadequate for delivery by Krug, Krug will re-deliver to another local location and any additional costs will be charged to the customer.
3. For all deliveries, it is understood that Krug or its agent is making a dock delivery only (equipped to handle a 53' trailer), and any further work of truck unloading, delivery beyond the dock, installation, and removal of packaging is not authorized or paid for by Krug.
4. Drop shipments to the installation site, and timed deliveries, are available on larger shipments (full truckloads or slightly less) at no additional charge. Drop shipments or timed deliveries for smaller shipments may not be available, or if available will require a surcharge. Deliveries on an after hours basis, or on weekends, or any other special requirements, may be subject to a surcharge. Location and contact information, and the requested time of delivery, is required at least one week prior to the acknowledged shipment date. If this information is not provided one week in advance, or if the location or time of the drop shipment is changed less than one week in advance, a surcharge may be applied, and/or the drop shipment may not be scheduled.
5. For all deliveries - whether to the Customer location or drop shipment - any circumstances that result in the delay of our carrier (including unsuitable receiving facilities, or facilities not open or available), service charges will be applied at the rate of \$75/hour. Where re-delivery is necessary because of these circumstances, the full cost of re-delivery will be charged. If Less Than Truck Load is delivering, one hour is allocated to unload. Any additional time required to unload after the first hour is \$75/hour. If a Truck Load is delivering the order, three hours is allocated to unload. Any additional time required to unload is \$75/hour. Direct deliveries to site for net orders are possible, must exceed \$60,000 net, and accommodate 48-53' trailers. Krug is responsible for delivery to the approved delivery address. If an address change is required, this must be authorized by Krug 5 business days prior to ship date. Any additional delivery costs incurred after this time will be charged to the customer. Additional costs for partial shipment of orders are the responsibility of the customer, and will be added to invoices. This includes any part shipment costs due to delays from textile suppliers. Additional costs for partial order shipments will normally not be assessed if there is a delay caused by Krug.

Damaged Shipments

All Krug product is well engineered, carefully inspected, and expertly loaded onto our trucks at our Distribution Center. If you receive any damaged freight, we ask that you do not refuse the shipment. Krug is not responsible for damage to goods that occurs in transit or storage. It is the purchaser and/or receiver's responsibility to examine the goods upon receipt and to notify Krug of any damages, overages or shortages. Any discrepancies should be noted on the Bill of Lading. The delivering carrier will not accept responsibility for shortages or damages if signed "clear". Notification of concealed damage claims must be made to Krug Distribution within 5 days of delivery, along with digital pictures if available. All product and

packaging must be available for inspection. Krug liability ceases after 5 business days and Krug will not be responsible for concealed damages if shipments are left unopened. Krug is not responsible for the condition of product that is stored or installed in an environment where temperature and humidity are not controlled.

Field Product Report Authorization

Krug's written authorization, in the form of an FPR number, must be obtained prior to incurring charges of any kind if Krug is expected to pay these charges. This includes authorization for returns, field repairs and replacements, post field repairs, installation and delivery charges. Krug reserves the right to have its representative inspect product related to any request for such authorizations, prior to that authorization being provided. Deductions from invoices paid for any charges to Krug, without prior written authorization in the form of an FPR, will not be accepted. Digital photographs may be required to complete the FPR process.

Care and Maintenance

Wood Finishes - Although Krug's extensive finishing process ensures a durable finish on all our products, there are several steps that can be taken to protect and prolong the life and beauty of the finish. Protect the top by placing felt pads on the bottom of any accessories and mechanical equipment. Rubber and oil will permanently mark surfaces. Use a desk pad to prevent possible damage and imprinting caused by writing instruments and sharp objects. Dust only with a clean, dry cloth, going with the grain. Clean any marks with a damp cloth, using a small quantity of mild soap or detergent. Do not use any wax-based polish, spray or silicone. Eventually, a film will build up and discolor the top. Do not place your furniture in a position of permanent exposure to direct sunlight.

Plastic Laminates - Clean plastic laminates with mild soap and warm water. Do not use steel wool, hot water, or any abrasive cleaning product.

Custom Capabilities

Over 15% of our orders involve some type of custom work, and we invite our customers to make use of our extensive capabilities. These include:

- 1) Dimensional customization of standard size products
- 2) Custom wood finishes
- 3) For larger orders, completely custom-designed products, as well as non-standard wood species can be specified.

Custom orders may require additional production lead times.

Contact Customer Service for more information.

Krug Panel Fabric Program

Tackboards can be upholstered in COM material supplied by the customer, and in a selection of stocked tackboard fabrics supplied by Momentum. The Momentum Panel fabrics are available on Krug Express. They are 100% polyester. For additional information and color selections, please refer to our Panel Fabrics card and Krug's website. www.krug.ca The Momentum panel fabrics pass ASTM-E84-87 Fire Codes. If memo samples are required please call Momentum at 1-800-366-6839.

Program Details

KrugExpress orders are ready to ship by the date acknowledged. Delivery and shipping schedules may result in actual shipping of orders at a later date. Statutory holidays and scheduled factory vacations may add to acknowledged lead times of *KrugExpress* orders. Unless otherwise specified on the order, the customer's standard method of shipping Krug products will be utilized. Available factory capacity for *KrugExpress* is filled by orders received on a "first come, first serve" basis. If the normal *KrugExpress* lead time is not available for your order because available capacity has been filled, you will be immediately advised of the earliest available ready-to-ship date. Please consult your Customer Service representative in advance if you wish to confirm the specific lead time availability for a *KrugExpress* order. Orders must be received by midnight of a given day for that day to be considered the official day the order is received. Order lead times are acknowledged from the date the order is received, but not including the date the order is received. *KrugExpress* orders must be "clean" when received in order to be considered officially received on a given day, and lead times will be acknowledged from the date orders are determined to be "clean". Changes to *KrugExpress* orders are not allowed under any circumstances. Orders for product on *KrugExpress* must clearly state: "*KrugExpress*".



Krug Textiles - Leather Program

Grade 8

Black	K13.1000	Graphite	K13.4000
Stone	K13.3000	Espresso	K13.8000
Sand	K13.5000	White	K13.9000

Please contact Customer Service for specific information on leathers, available colors and lead times.

Krug Textiles - Faux Leather Program

Grade 2

White	Taupe	Bisque	Wine	Sprig	Lagoon
Cream	Mocha	Chocolate	Garnet	Chinchilla	Pacific Blue
Parchment	Tan	Black	Rust	Steel	Navy
Sandstone	Chestnut	Earth	Citron	Grey	Plum
Vanilla		Brick			

GRADED-IN UPHOLSTERY PROGRAMS

Krug has partnered with several textile brands to grade in their offerings, designed to provide a wide range of upholstery selections for our seating products.

Upholstery pricing and availability is subject to change without notice. We grade this upholstery according to the pricing of the fabric suppliers - when their pricing changes, the Krug grade may change. When placing an order, a Krug customer must specify the complete upholstery number, along with the appropriate Krug model number and finish. Krug will supply the complete product at the prices listed. Orders specifying graded-in upholstery cannot be cancelled once the upholstery has been ordered.

Upholstery Grades

To determine the price of a product for graded-in upholstery, use the reference lists located on Krug’s website under - Products - Textiles, to view the upholstery grade (1-9). Krug is not responsible for the discontinuation of this upholstery. Please contact Customer Service for information on upholstery not listed.

When two upholstery selections are specified for use on seating, the higher grade upholstery price will apply to the order.

High Performance upholstery; Polyurethane, Vinyl or Crypton, is particularly suitable for healthcare and other intensive-use environments.

Upholstery Samples

If you require additional samples or memos for presentation, please contact fabric supplier directly.

Flammability Standards

- Tunnel Test Surface Ratings Class A rating
- Class 1 UFAC
- Passes State of California Technical Bulletin CAL 117-2013

Please contact fabric supplier directly for further flammability information pertaining to specific upholstery.

Special Conditions

Acknowledgements will give the estimated delivery date of the finished product. Some upholstery is imported, and availability may affect estimated delivery time. For large projects, please contact fabric supplier directly for availability of yardage.

TACKBOARD FABRICS

KRUG PANEL FABRIC PROGRAM

Tackboards can be upholstered in COM material supplied by the customer, and in a selection of stocked tackboard fabrics supplied by Momentum. The in-stock Momentum fabrics are priced at Grade 1 and are available on Krug Express. They are 100% polyester. For additional information and color selections, please refer to our Panel Fabrics card and Krug’s website. www.krug.ca If memo samples are required please call Momentum at 1-800-366-6839. The Momentum panel fabrics pass ASTM-E84-87 Fire Codes.

PROGRAM DETAILS

KrugExpress orders are ready to ship by the date acknowledged. Delivery and shipping schedules may result in actual shipping of orders at a later date. Statutory holidays and scheduled factory vacations may add to acknowledged lead times of KrugExpress orders. Unless otherwise specified on the order, the customer’s standard method of shipping Krug products will be utilized. Available factory capacity for KrugExpress is filled by orders received on a “first come, first serve” basis. If the normal KrugExpress lead time is not available for your order because available capacity has been filled, you will be immediately advised of the earliest available ready-to-ship date. Please consult your Customer Service representative in advance if you wish to confirm the specific lead time availability for a KrugExpress order. Orders must be received by midnight of a given day for that day to be considered the official day the order is received. Order lead times are acknowledged from the date the order is received, but not including the date the order is received. KrugExpress orders must be “clean” when received in order to be considered officially received on a given day, and lead times will be acknowledged from the date orders are determined to be “clean”. Changes to KrugExpress orders are not allowed under any

KRUGEXPRESS

circumstances. Orders for product on KrugExpress must clearly state: “KrugExpress”. *Some conditions apply. Please note PALETTE finishes are not available on KrugExpress.

CASEGOODS PROGRAM

Orders for casegood products on the KrugExpress program may be subject to quantity maximums. Please contact Krug Customer Service for more information. Quantity maximums are dependent upon available capacity, in order to insure that we ship all orders on time. Only actual casegood pieces and conference tables tops and bases are considered “units”. Items such as tasklights, tackboards, keyboard trays and drawers, electrical and wire management components, etc., are not considered under the quantity restrictions. For example, a typical office configuration that includes a desk, linking unit, credenza and hutch/overhead, equals a total of four units for the purposes of the quantity maximum. Only Krug In-stock panel fabric is available on the KrugExpress program. Only standard wood finishes are available for KrugExpress orders. Grommets can be specified in standard positions only. KrugExpress also includes all Krug seating and occasional tables as well as Krug conference products to complement this casegoods offering.

CUSTOMER'S OWN MATERIAL - C.O.M.

Customer's Own Material (COM)

COM must be received three weeks prior to the acknowledged ship date. Orders with COM not received by the required deadline will be delayed.

A description of the fabric, including supplier name, fabric name and color number must be included with the purchase order. When the COM fabric is received at Krug, it must be clearly identified with the fabric name and color, and tagged with name of the Krug customer and purchase order number. Krug will inspect all COM fabric when received to determine if it will be suitable for upholstery. Where Krug feels that the fabric or leather specified will compromise the quality or integrity of our products, customers will be contacted to direct these concerns. Further, Krug reserves the right to refuse to accept and use any COM fabrics or leathers that will compromise our products in any way that is unacceptable to Krug. Krug cannot assume responsibility for the durability or tailoring quality of customer's own material.

Yardage specified in this price guide is approximate. In the case of multiple product orders, multiply the number of items by the COM yardage specified to determine fabric required, unless otherwise indicated. Additional yardage may be needed if the material is less than 54" wide, or patterned or striped and requires matching. As fabric is applied horizontally, non-directional fabrics are recommended. COM fabrics are applied as they come off the roll unless otherwise specified. All striped fabrics will be applied vertically unless otherwise stated by the customer and after approval by Krug. It is the customer's responsibility to advise Krug if the upholstery is to be applied otherwise, and to advise Krug of any special upholstery instructions. Special instructions should be sent to Krug Customer Service, including a sample (or photocopy) of the fabric. Krug is not responsible for instructions sent with the fabric rolls, or for the method of upholstery if no instructions have been provided. COM fabrics for tackboards may be specified in either Maharam or Momentum panel fabrics. Krug is not responsible for determining if a fabric is not ideal for tackboard application.

Please contact Maharam at 1-800-645-3943 or Momentum at

COM Shipping Procedures

For tackboard COM fabrics, please send fabrics to:

Krug Inc.

111 Ahrens Street

Kitchener, Ontario

Canada N2H 4C2

Attention: RECEIVER

All packages must be clearly marked "For Customs Clearance by Willson International Custom Brokers". According to the North American Free Trade Agreement (NAFTA), goods shipped between the United States and Canada can qualify for exemption from all duties, or for a reduction in duties, if the goods can be proven to originate in either the United States, Canada or Mexico.

Canada Customs requires that a NAFTA Certificate of Origin and Commercial Invoice be completed and sent with the fabric shipment. The Commercial Invoice must clearly state the description of the fabric, the selling price, the make-up or content, and the purchaser. The absence of these two documents will delay the shipments at the U.S./Canada border, thereby potentially delaying the customer order. If the total value of the shipment is less than \$1200 U.S., Customs will accept a Low Value Statement of Origin in place of the NAFTA Certificate of Origin. The Low Value Statement must be signed by a representative of the exporting company. This statement may either be included on the commercial invoice or attached to the invoice.

Krug is happy to answer any questions or concerns about COM shipping procedures and the required documents. Please contact our Customs Specialist at 1.888.578.5784.

LAMINATES

LAMINATES

Krug's in-stock Laminates are available in 17 different laminate selections. Please note that 4 of the colors (Gingerbread, Portobello, Ash and Willow) have textured finishes and may not be appropriate for use in patient areas due to infection control concerns. Minimum order quantities and extended lead times may apply for exotic laminate colors, please check with customer service. Polymer Edge will be selected to match the worksurface. Krug's previous laminate in-stock program will be phased out as in-stock supply depletes. Please contact customer service for availability.

IN-STOCK LAMINATES

Wood Grain Laminates	High Pressure Laminate Supplier	Textured Wood Grain Laminates	High Pressure Laminate Supplier
Champagne	Tafisa T492CR	Gingerbread	Tafisa T556UR
Hardrock Maple	Formica 86992-58	Portobello	Tafisa T557UR
Dune	Tafisa T491CR	Ash	Tafisa T535AT
Copper	Tafisa T521CR	Willow	Tafisa T543AT
Shiraz Cherry	Tafisa T472CR		
Park Avenue Walnut	Wilsonart 7984-38	Solid Laminates	
Chocolate	Tafisa T498CR	Designer White	Wilsonart D354-60
Nutmeg	Tafisa T477CR	Platinum	Tafisa T202CR
Dark Walnut	Tafisa T469CR	Earth	Tafisa T767CR
		Charcoal	Tafisa T228CR

PHASE OUT LAMINATES

Almond - Black- Shadows - Edgewood Sycamore - Gunstock Walnut

Non-Stocked Laminates

For specific lead time and application questions, please contact Krug Customer Service for your requirement. Upcharges will be applicable for non-stocked laminates, depending on their cost. Non-stock laminates may require a minimum order quantity, please contact customer service. Stocked polymer edges only can be specified for use with non-stocked laminates or tops will be self-edged.



The mark of responsible forestry

All products are air emissions certified and are available as FSC® certified

krug