

MILLENNIUM CASEGOODS
Price and Specification Guide
USA



krug

Advancing Design Through Innovation

MILLENNIUM TABLE OF CONTENTS

2	Environmental Summary
3	Product Features & Options
4	Finishes & Laminates
6	Product Enhancements
5	Sample Configurations
8	Desks
17	Height Adjustable Desk Worksurfaces
21	Height Adjustable Return Worksurfaces
25	Returns
32	Linking Tops
33	Corner Units
34	Credenzas
42	Overheads
43	Hutches
49	Bookcases
51	Storage
58	Wardrobes
60	Modular Tops
61	Modular Pedestals
55	Mobile Pedestals & Tables
65	Reception
69	PowerPorts & Cable Management

General Information

72	Grommets, Powerports & positions
73	Desks, Overheads & Hutches
74	Installation Instructions
67	Custom Pricing Methods
75	Terms & Conditions
75	Warranty
77	Custom Pricing Methods
77	KrugExpress
78	Panel Fabric, COM & Graded-in Upholstery Programs

MILLENNIUM ENVIRONMENTAL SUMMARY

LEED CERTIFICATION



MATERIAL CONTENT:

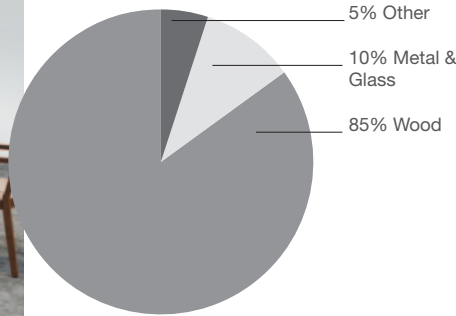

PRE-CONSUMER RECYCLED CONTENT = 81%

POST-CONSUMER RECYCLED CONTENT = 3%

		CONTRIBUTES TO
CREDIT 2.1 - 2.2	Construction Waste Management	1-2 point(s)
CREDIT 4.1	Recycled Content	1 point
CREDIT 4.2	Recycled Content	1 point
CREDIT 4.5	Low Emitting Materials, (MUST BE REQUESTED) Systems Furniture & Seating	1 point
CREDIT 5.1	Regional Materials*	1 point
CREDIT 7	Certified Wood (PLEASE ENQUIRE)	1 point

* This credit is only applicable if in total 20% of the combined value of the procurement of construction materials and in the furniture are manufactured within a radius of 500 miles. This credit will apply if the installation of the finished product occurs within 500 miles of Toronto, Ontario.



level® CERTIFICATION

BIFMA's e3 Furniture Sustainability Standard is a voluntary, multi-attribute standard that measures the degree of sustainability of furniture. This standard evaluates product and company environmental attributes and compliance systems in a wide range of elements which include Materials, Energy & Atmosphere, Human & Ecosystem Health and Social Responsibility. Millennium products have earned level®, BIFMA's sustainability certification program for furniture, certification through third-party verification against the e3 standard.



the mark of responsible forest

AIR EMISSIONS

All Millennium products can be supplied with air emissions-certification. Contact customer service for information and upcharges.

FSC®

FSC® In 2005, Krug received Forest Stewardship Council® (FSC®) Chain-of-Custody certification for our manufacturing facilities. The FSC® Chain-of-Custody tracks certified wood from seedling to final sale. It verifies that the material for our FSC® certified products only come from well-managed, FSC®-certified forests and other controlled sources. FSC® is dedicated to the promotion of responsible forest management worldwide helping to take care of forests for future generations. Millennium and other Krug products can be specified with FSC® Certification. Contact customer service for further information, pricing and lead times.



In addition, architects, designers, and building professionals can specify FSC®-certified products in order to achieve a point from the US Green Building Council's Leadership in Energy and Environmental Design (LEED) Rating System.

MILLENNIUM FEATURES & OPTIONS

WORKSURFACES

Tops are made of 1 1/2" - 45 lbs. per cubic foot density particle board core with face and back veneer. All edges have 1 1/2" wide 3/4" thick solid Oak, Walnut, Cherry or Maple headers.

EDGE PROFILES

An edge detail profile must be selected for every Millennium product. Millennium product is available in the following profile options:



Desk, Curvilinear Shaped Tops, Credenzas, Shells, Bookcase and Storage Units profile is located on all sides.

Hutches: profile is located on all three sides. Link Units, Curvilinear Returns and Returns; when units are connected to create a larger work surface area, some profile options have coved edges to create a smooth transition from one surface to another. The following profiles have coved edges on connecting ends of return and linking units: Seville, Valen, Barcelona, Williamsburg, Zamora All other profile options will appear on all sides of the case, meeting each other face to face at work surface connection points.

GABLES

Gables are 1 1/8" thick - 45 lbs. per cubic foot density particle board core, 3 ply. Edges are banded with veneer.

VENEER

External face veneers are #1 grade flat sliced Red Oak, Black Walnut, Cherry or Maple book-matched and of uniform color and grain pattern. Birdseye Maple Veneer is available on Millennium work surfaces at an upcharge of \$76 list per square foot. Birdseye Maple is recommended in a clear finish only. This option could extend regular lead times.

SOLIDS

All solids used shall be Appalachian Red Oak, American Black Walnut, Cherry or Maple kiln-dried by the manufacturer to a 6% moisture content, using U.S.D.A. Bulletin #FP-1136.

FINISH

All finished surfaces are well sanded before applying finishing materials. The procedure begins by applying a base color via an N.G.R. stain. A wash coat follows to further enhance the color. A filter coat is applied to fill open pores and wipe clean. A sealer coat is applied and scuff-sanded to prepare for the top coat (finish). The final procedure is to apply catalyzed varnish that when dry has a sheen value of 32°.

LOCKS

Locks are a standard feature on all pedestals, including those in desks, credenzas and lateral file storage units. Lock plugs on desks are located in the kneespace on the pedestal side panel. Locks are not available on all glass doors. Locks are available on bookcase doors at an upcharge of **\$152 list** per set of 2 doors, please specify at time of order. If a hutch or overhead has an uneven amount of doors the single lock required is also **\$152**. Lock plugs for bookcase doors are standard on the top inside corner of the door front. Lock plugs for hutch and overhead doors are standard on the lower inside corners. Suites can be keyed alike at no upcharge, please specify on the purchase order.

DRAWERS

Desk box drawers have fully progressive full extension slides and are load rated at 100 lbs. per drawer. Desk files drawers have a load bearing capacity of 130 lbs. and box drawers have a load bearing capacity of 100 lbs. Other pedestal file drawers have fully progressive, full extension slides and are load rated at 100 lbs. per drawer. All drawer interiors are clear finished Birch on particle board constructed with dowels. All file drawers are equipped for letter and legal filing. All box/box/file pedestals in desks only are supplied with one pencil tray.

PULLS

Luna, Eclipse and Crescent Pulls are available in Satin Nickel, Matte Black, Polished Chrome, Black Chrome, and Brushed Brass. Pull color and style must be stated clearly on the purchase order. Pulls are located on all drawer fronts and bookcase wood doors. Glass door bookcases feature the Luna knob in the same finish as pulls on the order. Glass door and wood door hutches/overheads do not have pulls.

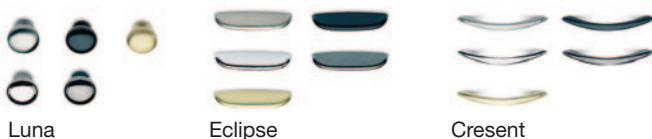

Oyster pulls are available in Matte Black, Polished Chrome, and Brushed Brass.



A Williamsburg pull in Polished Brass is standard on all products specified with the Williamsburg edge detail.

HINGES

Doors have a European style hinges with a 95° opening.

GLIDES

Adjustable glides are installed at factory and allow for 3/4" adjustment.

TESTING INFORMATION

Millennium meets or exceeds the testing requirements of ANSI/BIFMA X5.5-2014 and/or X5.9 - 2012.



MILLENNIUM FINISHES & LAMINATES

WOOD FINISHES

Standard wood finishes are:

SPECIES	FINISH
Cherry	Light Cherry
	Natural Cherry
	American Cherry
	Medium Cherry
	Standard Cherry
	Imperial Cherry
	Appalachian Cherry
	Sable Cherry
Maple	Clear Maple
	Honey Maple
	Wheat Maple
Walnut	Natural Walnut
	Regular Walnut
	Mahogany on Walnut
	Dark Walnut
	Cordovan Walnut

WOOD FINISHES TO MATCH STANDARD LAMINATES

Copper on Cherry
Shiraz Cherry
Park Avenue Walnut
Chocolate on Walnut
Nutmeg on Walnut
Dark Walnut
Hardrock Maple

NATURAL CHARACTERISTICS OF WOOD

Wood is a natural product with inherent color variations that will never be fully mitigated by the finishing process. Please anticipate variation in colors within a single unit, from piece to piece, and from Krug wood finish samples. If a very close match is required, a sample must be provided with the order and an upcharge will apply. Exact color matches are not possible.

CUSTOM WOOD FINISHES

Add 10% list to your order for special finishes, minimum upcharge is \$600 list per finish per order. (For example, on all orders up to \$6000 list, an upcharge of \$600 will apply, on orders \$6000 and up add 10% list to your order.)

For orders with special finishes, a sample that is a minimum 3" by 3" must be received with the order. Special finishes may add additional lead time to production schedules. Since wood is a natural product, some variations in grain, color and stain acceptance will occur. In our finishing processes, we try to minimize variations, but some variation between samples and finished goods should be anticipated.

DUAL FINISHES

Add 10% list per item if specifying dual finish.

VENEER

Millennium veneer is flat cut

BIRDSEYE MAPLE OPTION

Bookmatched Birdseye Maple veneer is available on Millennium at an upcharge of \$76 list per square foot. Specify clearly on order. Birdseye Maple is recommended in clear finish only. Birdseye Maple only applies to tops.

LAMINATE WORKSURFACE OPTION

Millennium worksurfaces are available laminate at an upcharge of 10% (a higher upcharge may apply to specially priced plastic laminates). Where there are wood profile edges on worksurface tops, they will remain as wood profile on laminate tops. Krug will order and procure laminates. Purchase orders with a plastic laminate option must include Laminate name. When specifying laminate worksurfaces, the grain direction is such that the grain pattern runs the length of each surface, as shown in the diagram on the right. Please contact Krug Customer Service for questions pertaining to laminate grain direction.

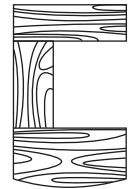

LAMINATES

Krug's in-stock Laminates are available in 17 different laminate selections. Please note that 4 of the colors (Gingerbread, Portobello, Ash and Willow) have textured finishes and may not be appropriate for use in patient areas due to infection control concerns. Minimum order quantities and extended lead times may apply for exotic laminate colors, please check with customer service. Polymer Edge will be selected to match the worksurface. Krug's previous laminate in-stock program will be phased out as in-stock supply depletes. Please contact customer service for availability.

IN-STOCK LAMINATES

Wood Grain Laminates	High Pressure Laminate Supplier	Textured Wood Grain Laminates	High Pressure Laminate Supplier
Champagne	Tafisa T492CR	Gingerbread	Tafisa T556UR
Hardrock Maple	Formica 86992-58	Portobello	Tafisa T557UR
Dune	Tafisa T491CR	Ash	Tafisa T535AT
Copper	Tafisa T521CR	Willow	Tafisa T543AT
Shiraz Cherry	Tafisa T472CR	Solid Laminates	
Park Avenue Walnut	Wilsonart 7984-38	Designer White	Wilsonart D354-60
Chocolate	Tafisa T498CR	Platinum	Tafisa T202CR
Nutmeg	Tafisa T477CR	Earth	Tafisa T767CR
Dark Walnut	Tafisa T469CR	Charcoal	Tafisa T228CR

PHASE OUT LAMINATES

Almond - Black- Shadows - Edgewood Sycamore - Gunstock Walnut

NON-STOCKED LAMINATES

For specific lead time and application questions, please contact Krug Customer Service for your requirement. Upcharges will be applicable for non-stocked laminates, depending on their cost. Non-stock laminates may require a minimum order quantity, please contact customer service. Stocked polymer edges only can be specified for use with non-stocked laminates or tops will be self-edged.

MILLENNIUM SAMPLE CONFIGURATIONS

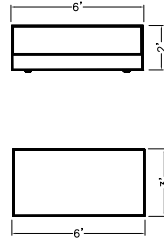
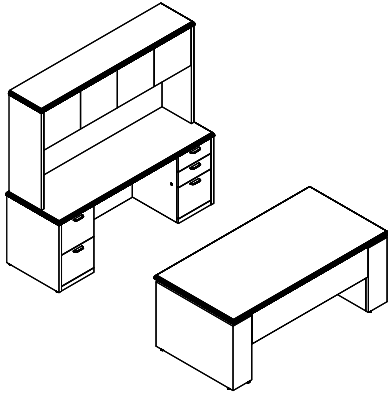

	Model	Cherry Maple Walnut
Height Adj. Desk	68HA7136ETSGV21	6945
Hutch	68HT7115	5036
Credenza	68CY71244LDRF	5912
TOTAL		\$17,893

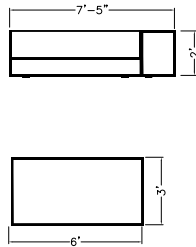
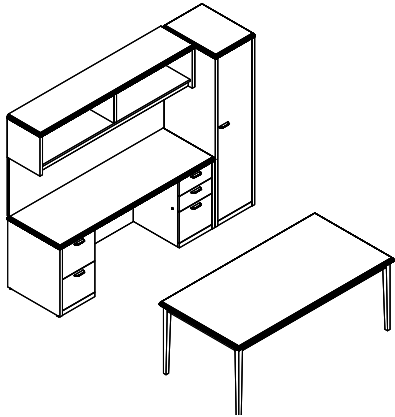

	Model	Cherry Maple Walnut
Desk	68TDE7136	4822
Overhead	68OO711517	2485
Tackboard	68TBOH71	568
Credenza	68CY71244LDRF	5912
Flush Right Storage	option 68ST18246811R	120 3635
TOTAL		\$17,542

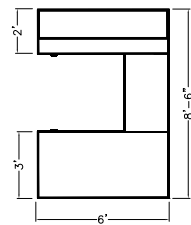
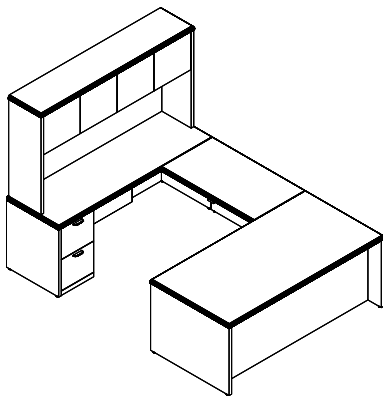

	Model	Cherry Maple Walnut
Desk	68D71364L0RF	5087
Link Unit	68LU4224H	1920
Hutch	68HT7115	5036
Credenza	68CY71244LDR0	5498
TOTAL		\$17,541

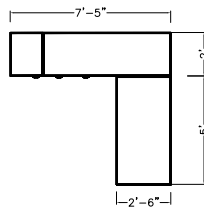
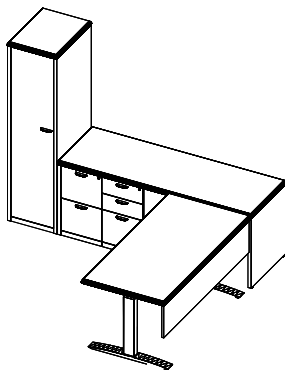

	Model	Cherry Maple Walnut
Height Adj. Desk	68HA6030ETSV21	4377
Credenza	68C71204LDFR0	5835
Flush Left Storage	option 68ST18246811L	120 3636
TOTAL		\$13,968

MILLENNIUM PRODUCT ENHANCEMENTS

Please follow the instructions below to enhance Millennium with optional product features.

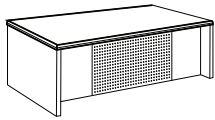

DESK WITH PERFORATED METAL MODESTY PANEL
 Not available on 3/4 Height Pedestal Desks
 Available on Desks 66" and up
 Add 'P' to model number prefix
 Example: 68-DP-6030-LDRD
10% list upcharge

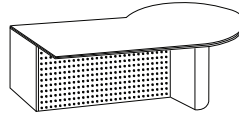

CURVILINEAR RETURNS WITH PERFORATED METAL MODESTY PANEL
 Only available on 71" & 84" units and only available in conjunction with Half Drum Base
 Add 'P' to model number prefix
 Example: 68PPRL-7130-DB
20% list upcharge

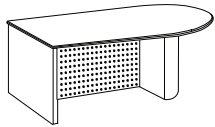

CURVILINEAR DESKS WITH PERFORATED METAL MODESTY PANEL
 Only available on 71" & 84" units and only available in conjunction with Half Drum Base
 Add 'P' to model number prefix
 Example: 68BDP-7130-DB
20% list upcharge

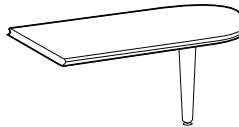

CURVILINEAR RETURNS WITH TAPERED BRUSHED ALUMINUM POST LEG
 Only available on Returns without Modesty Panels
 Add 'T' to model number suffix
 Example: 68BR-6630-T
No upcharge

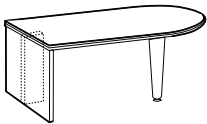

CURVILINEAR DESKS WITH TAPERED BRUSHED ALUMINUM POST LEG
 Only available on Desks without Modesty Panels
 Add 'T' to model number suffix
 Example: 68BD-6630-T
No upcharge

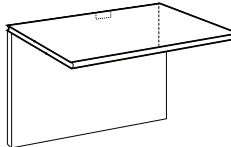

LINK UNIT WITH WIRE MANAGEMENT CUT-OUT ON MODESTY PANEL
 Available in standard center position
 Note clearly on purchase order
\$194 list upcharge

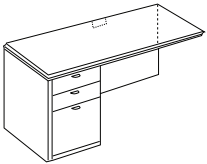

RETURNS WITH WIRE MANAGEMENT CUT-OUT ON MODESTY PANEL
 Not available on Desk Depth Returns
 Available in standard center position on modesty panel
 Note clearly on purchase order
\$194 list upcharge

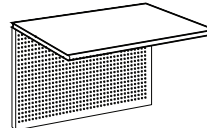

LINK UNITS WITH PERFORATED METAL MODESTY PANEL
 Add 'P' to model number prefix
 Example: 68-LUP-3024-H
40% list upcharge

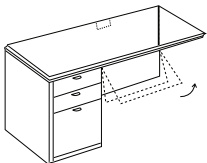

RETURNS WITH HINGED WOOD MODESTY PANEL OPTION
 Add 'Y' to model number prefix
 Example: 68RHY-4220-L4D
10% list upcharge

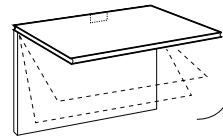

LINK UNITS WITH HINGED WOOD MODESTY PANEL
 Add 'Y' to model number prefix
 Example: 68-LUY-3024-H
10% list upcharge

ORDERING PROCEDURE

To order, please specify the following:

- 1) Krug product model number
- 2) Wood species and finish
- 3) Wood edge detail - S, V, T, M, B, Z or W, see page 3.

*Indicates model illustrated by line drawing.

CODE DESCRIPTION

- P — perforated metal modesty panel
- T — tapered brushed aluminum panel
- Y — hinged wood modesty panel

The metal finish on perforated metal modesty panels, tapered brushed aluminum post legs, tackboard organizer rail, and accessories all match the Millennium satin nickel pull finish.

STANDARD FINISHES

For a complete list of standard wood finishes please see page 4.

PERFORATED METAL MODESTY PANEL

Perforated metal modesty panels are 16 gage thick steel panels with a brushed metal finish.

MILLENNIUM PRODUCT ENHANCEMENTS

Please follow the instructions below to enhance Millennium with optional product features.

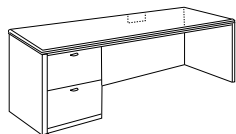

CREDENZAS WITH CUT-OUT GROMMET OPTION ON MODESTY PANEL
Note clearly on purchase order
\$194 list upcharge

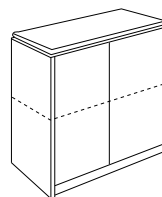

DOUBLE HEIGHT OVERHEADS
Only available on 36", 42" and 48" hinged door and open models
Add '29' to model number suffix
Example: 680H-3629
25% list upcharge

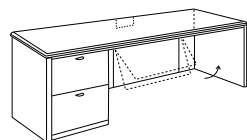

CREDENZAS WITH HINGED WOOD MODESTY PANEL
Not available on Ganged Pedestal, or Lateral File/Bookcase Credenzas
Add 'Y' to model number prefix
Example: 68CY-6020-4-LDR0
10% list upcharge

DOUBLE HEIGHT PAPER MANAGEMENT OVERHEADS
Only available on 36", 42" and 48" hinged door and open models
Add 'PM' to model number suffix
Example: 680HPM-3629
35% list upcharge

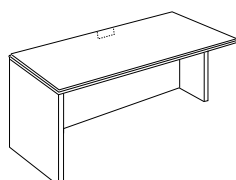

OPEN RETURNS WITH WIRE MANAGEMENT CUT-OUT ON MODESTY PANEL
Available in standard center position
Note clearly on purchase order
\$194 list upcharge

PAPER MANAGEMENT OVERHEADS
Not available on Flipper Door Models
Add 'PM' to model number prefix
Example: 680HPM-36
10% list upcharge

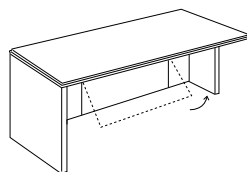

OPEN RETURNS WITH HINGED WOOD MODESTY PANEL
Add 'Y' to model number prefix
Example: 68RHY-4224
10% list upcharge

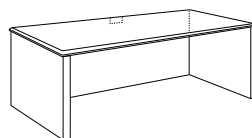

SHELLS WITH WIRE MANAGEMENT CUT-OUT ON MODESTY PANEL
Wire Management Cut-Out: 7 7/28" x 4 9/16"
Available in standard center position and also available on Corner Credenza Shell Model
Note clearly on purchase order
\$194 list upcharge



MOBILE PEDESTAL WITH UPHOLSTERED SEAT
Reference model #: 68MPSU-4F
Available in a shallow version only

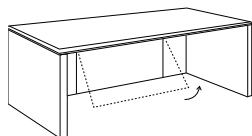

SHELLS WITH HINGED WOOD MODESTY PANEL
Width of hinged modesty panel allows for installation of 16" pedestals
Also available on Corner Credenza Shell Model
Add 'Y' to model number prefix
Example: 68SY-3020
10% list upcharge

FABRIC GRADES

MODEL	1	2	3	4	5	6	7	8	9
MPSU-4F	2618	2664	2713	2757	2805	2850	2898	3036	3172
Cherry/Maple/Walnut									

MODEL	W	D	H	SHIP WT.	CU.FT.	COM
MPSU-4F	16	18.5	25.25	76	6	1

DIMENSION KEY

W - width
D - depth
H - height

CODE DESCRIPTION

P — perforated metal modesty panel
Y — hinged wood modesty panel
X — hinged glass doors
29 — double height overheads
PM — paper manager
The metal finish on perforated metal modesty panels, tapered brushed aluminum post legs, tackboard organizer rail, and accessories match the Millennium satin nickel pull finish.



STANDARD FINISHES

For a complete list of standard wood finishes please see page 4.

HINGED WOOD MODESTY PANEL

Hinged wood modesty panels come standard with a center positioned wire management cut-out.

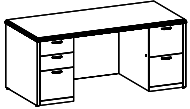
MILLENNIUM DESKS

Description	Model	Cherry	W	D	H	KW	Shipping Weight	Cubic Feet
		Maple Walnut						
Double Pedestal Desk with Full Height Pedestals	68D60304LDRD	6267	60	30.25	28.5	27.5	296	36
	68D60304LDRF	6267	60	30.25	28.5	27.5	296	36
 	68D60304LFRD	6267	60	30.25	28.5	27.5	296	36
	68D60304LFRF	6267	60	30.25	28.5	27.5	296	36
	68D66304LDRD	6289	65.75	30.25	28.5	33.25	314	39
	68D66304LDRF	6289	65.75	30.25	28.5	33.25	314	39
	68D66304LFRD*	6289	65.75	30.25	28.5	33.25	314	39
	68D66304LFRF	6289	65.75	30.25	28.5	33.25	314	39
	68D66364LDRD	6322	65.75	36.25	28.5	33.25	354	46
	68D66364LDRF	6322	65.75	36.25	28.5	33.25	354	46
	68D66364LFRD	6322	65.75	36.25	28.5	33.25	354	46
	68D66364LFRF	6322	65.75	36.25	28.5	33.25	354	46
	68D71304LDRD	6330	71	30.25	28.5	38.25	329	42
	68D71304LDRF	6330	71	30.25	28.5	38.25	329	42
	68D71304LFRD	6330	71	30.25	28.5	38.25	329	42
	68D71304LFRF	6330	71	30.25	28.5	38.25	329	42
	68D71364LDRD	6432	71	36.25	28.5	38.35	372	50
	68D71364LDRF	6432	71	36.25	28.5	38.35	372	50
	68D71364LFRD	6432	71	36.25	28.5	38.35	372	50
	68D71364LFRF	6432	71	36.25	28.5	38.35	372	50
	68D78304LDRD	6442	78	30.25	28.5	45.5	350	46
	68D78304LDRF	6442	78	30.25	28.5	45.5	350	46
68D78304LFRD	6442	78	30.25	28.5	45.5	350	46	
68D78304LFRF	6442	78	30.25	28.5	45.5	350	46	
68D78364LDRD	6514	78	36.25	28.5	45.5	397	36	
68D78364LDRF	6514	78	36.25	28.5	45.5	397	36	
68D78364LFRD	6514	78	36.25	28.5	45.5	397	36	
68D78364LFRF	6514	78	36.25	28.5	45.5	397	36	
68D84364LDRD	6543	84	36.25	28.5	51.5	399	39	
68D84364LDRF	6543	84	36.25	28.5	51.5	399	39	
68D84364LFRD	6543	84	36.25	28.5	51.5	399	39	
68D84364LFRF	6543	84	36.25	28.5	51.5	399	39	
Double Pedestal Desk with Full Height Pedestals & Breakfront Modesty Panel	68DBF66364LDRD	7007	65.75	36.25	28.5	33.25	354	46
	68DBF66364LDRF	7007	65.75	36.25	28.5	33.25	354	46
	68DBF66364LFRD*	7007	65.75	36.25	28.5	33.25	354	46
	68DBF66364LFRF	7007	65.75	36.25	28.5	33.25	354	46
	68DBF71364LDRD	7104	71	36.25	28.5	38.25	372	50
	68DBF71364LDRF	7104	71	36.25	28.5	38.25	372	50
	68DBF71364LFRD	7104	71	36.25	28.5	38.25	372	50
	68DBF71364LFRF	7104	71	36.25	28.5	38.25	372	50
	68DBF78364LDRD	7212	78	36.25	28.5	45.5	397	36
	68DBF78364LDRF	7212	78	36.25	28.5	45.5	397	36
	68DBF78364LFRD	7212	78	36.25	28.5	45.5	397	36
	68DBF78364LFRF	7212	78	36.25	28.5	45.5	397	36
	68DBF84364LDRD	7210	84	36.25	28.5	51.5	399	39
	68DBF84364LDRF	7210	84	36.25	28.5	51.5	399	39
68DBF84364LFRD	7210	84	36.25	28.5	51.5	399	39	
68DBF84364LFRF	7210	84	36.25	28.5	51.5	399	39	

ORDERING PROCEDURE

To order, please specify the following:

- 1) Krug product model number
- 2) Wood species and finish, see page 4
- 3) Wood edge detail, see page 3
- 4) Pull style, see page 3
- 5) Grommet location if applicable

*Indicates model illustrated by line drawing.

CODE DESCRIPTION

- 4 - full height pedestal
- L - left handed pedestal position
- R - right handed pedestal position
- D - 2 file drawer
- F - 2 box, 1 file drawer
- BF- break front modesty panel

STANDARD FINISHES

For a complete list of standard wood finishes please see page 4. Standard Laminate work-surfaces are available at a 10% upcharge.

GROMMETS

One grommet in standard position is optional at no charge. Additional grommets are available at an upcharge of **\$152 List**.

MILLENNIUM DESKS

Description	Model	Cherry Maple Walnut	W	D	H	KW	Shipping		Cubic Feet
							Weight		
Double Pedestal Desk	68DBF66364LDWRD	8447	65.75	36.25	28.5	33.25	354	46	
with Full Height Pedestals & Breakfront Modesty Panel & Wire Management Cavity	68DBF66364LDRDW	8447	65.75	36.25	28.5	33.25	354	46	
	68DBF66364LFWRD*	8447	65.75	36.25	28.5	33.25	354	46	
	68DBF66364LFRDW	8447	65.75	36.25	28.5	33.25	354	46	
	68DBF66364LDWRF	8447	65.75	36.25	28.5	33.25	354	46	
	68DBF66364LDRFW	8447	65.75	36.25	28.5	33.25	354	46	
	68DBF66364LFWRF	8447	65.75	36.25	28.5	33.25	354	46	
	68DBF66364LFRFW	8447	65.75	36.25	28.5	33.25	354	46	
	68DBF71364LDWRD	8572	71	36.25	28.5	38.25	372	50	
	68DBF71364LDRDW	8572	71	36.25	28.5	38.25	372	50	
	68DBF71364LDWRF	8572	71	36.25	28.5	38.25	372	50	
	68DBF71364LDRFW	8572	71	36.25	28.5	38.25	372	50	
	68DBF71364LFWRD	8572	71	36.25	28.5	38.25	372	50	
	68DBF71364LFRDW	8572	71	36.25	28.5	38.25	372	50	
	68DBF71364LFWRF	8572	71	36.25	28.5	38.25	372	50	
	68DBF71364LFRFW	8572	71	36.25	28.5	38.25	372	50	
	68DBF78364LDWRD	8654	78	36.25	28.5	45.5	397	36	
	68DBF78364LDRDW	8654	78	36.25	28.5	45.5	397	36	
	68DBF78364LDWRF	8654	78	36.25	28.5	45.5	397	36	
	68DBF78364LDRFW	8654	78	36.25	28.5	45.5	397	36	
	68DBF78364LFWRD	8654	78	36.25	28.5	45.5	397	36	
	68DBF78364LFRDW	8654	78	36.25	28.5	45.5	397	36	
	68DBF78364LFWRF	8654	78	36.25	28.5	45.5	397	36	
	68DBF78364LFRFW	8654	78	36.25	28.5	45.5	397	36	
	68DBF84364LDWRD	8687	84	36.25	28.5	51.5	399	39	
	68DBF84364LDRDW	8687	84	36.25	28.5	51.5	399	39	
	68DBF84364LDWRF	8687	84	36.25	28.5	51.5	399	39	
	68DBF84364LDRFW	8687	84	36.25	28.5	51.5	399	39	
	68DBF84364LFWRD	8687	84	36.25	28.5	51.5	399	39	
	68DBF84364LFRDW	8687	84	36.25	28.5	51.5	399	39	
	68DBF84364LFWRF	8687	84	36.25	28.5	51.5	399	39	
	68DBF84364LFRFW	8687	84	36.25	28.5	51.5	399	39	

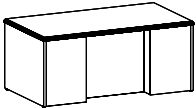
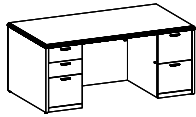

DIMENSION KEY

W - width
D - depth
H - height

*Indicates model illustrated by line drawing.

CODE DESCRIPTION

4 - full height pedestal
L - left handed pedestal position
R - right handed pedestal position
D - 2 file drawer
F - 2 box, 1 file drawer
BF- break front modesty panel
W - Wire Management Cavity

STANDARD FINISHES

For a complete list of standard wood finishes please see page 4. Standard Laminate work-surfaces are available at a 10% upcharge.

GROMMETS

One grommet in standard position is optional at no charge. Additional grommets are available at an upcharge of **\$152 List**.

MILLENNIUM DESKS

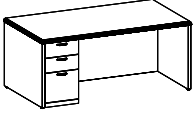
Description	Model	Cherry Maple Walnut	W	D	H	KW	Shipping Weight	Cubic Feet
Single Pedestal Desk with Full Height Pedestal	68D60304LDR0	4919	60	30.25	28.5	27.5	239	36
	68D60304LFR0	4919	60	30.25	28.5	27.5	239	36
	68D60304LORD	4919	60	30.25	28.5	27.5	239	36
	68D60304LORF	4919	60	30.25	28.5	27.5	239	36
	68D66304LDR0	4959	65.75	30.25	28.5	33.25	257	39
	68D66304LFR0	4959	65.75	30.25	28.5	33.25	257	39
	68D66304LORD	4959	65.75	30.25	28.5	33.25	257	39
	68D66304LORF	4959	65.75	30.25	28.5	33.25	257	39
	68D66364LDR0	5003	65.75	36.25	28.5	33.25	297	46
	68D66364LFR0*	5003	65.75	36.25	28.5	33.25	297	46
	68D66364LORD	5003	65.75	36.25	28.5	33.25	297	46
	68D66364LORF	5003	65.75	36.25	28.5	33.25	297	46
	68D71304LDR0	5010	71	30.25	28.5	38.25	272	42
	68D71304LFR0	5010	71	30.25	28.5	38.25	272	42
	68D71304LORD	5010	71	30.25	28.5	38.25	272	42
	68D71304LORF	5010	71	30.25	28.5	38.25	272	42
	68D71364LDR0	5087	71	36.25	28.5	38.35	315	50
	68D71364LFR0	5087	71	36.25	28.5	38.35	315	50
	68D71364LORD	5087	71	36.25	28.5	38.35	315	50
	68D71364LORF	5087	71	36.25	28.5	38.35	315	50
	68D78304LDR0	5147	78	30.25	28.5	45.5	293	46
	68D78304LFR0	5147	78	30.25	28.5	45.5	293	46
68D78304LORD	5147	78	30.25	28.5	45.5	293	46	
68D78304LORF	5147	78	30.25	28.5	45.5	293	46	
68D78364LDR0	5178	78	36.25	28.5	45.5	340	36	
68D78364LFR0	5178	78	36.25	28.5	45.5	340	36	
68D78364LORD	5178	78	36.25	28.5	45.5	340	36	
68D78364LORF	5178	78	36.25	28.5	45.5	340	36	
68D84364LDR0	5238	84	36.25	28.5	51.5	342	39	
68D84364LFR0	5238	84	36.25	28.5	51.5	342	39	
68D84364LORD	5238	84	36.25	28.5	51.5	342	39	
68D84364LORF	5238	84	36.25	28.5	51.5	342	39	

ORDERING NOTES:

30" deep desks have flush modesty panels, 36" deep desks have recessed modesty panels. Please see page 6 for perforated metal modesty panel option.

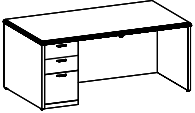
Single Pedestal Desk with Full Height Pedestal & Breakfront Modesty Panel	68DBF66364LDR0	5667	65.75	36.25	28.5	33.25	297	46
	68DBF66364LFR0*	5667	65.75	36.25	28.5	33.25	297	46
	68DBF66364LORD	5667	65.75	36.25	28.5	33.25	297	46
	68DBF66364LORF	5667	65.75	36.25	28.5	33.25	297	46
	68DBF71364LDR0	5780	71	36.25	28.5	38.25	315	50
	68DBF71364LFR0	5780	71	36.25	28.5	38.25	315	50
	68DBF71364LORD	5780	71	36.25	28.5	38.25	315	50
	68DBF71364LORF	5780	71	36.25	28.5	38.25	315	50
	68DBF78364LDR0	5854	78	36.25	28.5	45.5	340	36
	68DBF78364LFR0	5854	78	36.25	28.5	45.5	340	36
	68DBF78364LORD	5854	78	36.25	28.5	45.5	340	36
	68DBF78364LORF	5854	78	36.25	28.5	45.5	340	36
	68DBF84364LDR0	5931	84	36.25	28.5	51.5	342	39
	68DBF84364LFR0	5931	84	36.25	28.5	51.5	342	39
	68DBF84364LORD	5931	84	36.25	28.5	51.5	342	39
	68DBF84364LORF	5931	84	36.25	28.5	51.5	342	39

ORDERING PROCEDURE

To order, please specify the following:

- 1) Krug product model number
- 2) Wood species and finish, see page 4
- 3) Wood edge detail, see page 3
- 4) Pull style, see page 3
- 5) Grommet location if applicable

*Indicates model illustrated by line drawing.

CODE DESCRIPTION

- 4 - full height pedestal
- L - left handed pedestal position
- R - right handed pedestal position
- 0 - no pedestal
- D - 2 file drawers
- F - 2 box, 1 file drawer
- BF- break front modesty panel

STANDARD FINISHES

For a complete list of standard wood finishes please see page 4. Standard Laminate work-surfaces are available at a 10% upcharge.

GROMMETS

One grommet in standard position is optional at no charge. Additional grommets are available at an upcharge of **\$152 List**.

MILLENNIUM DESKS

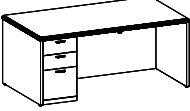
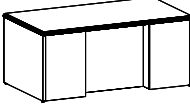
Description	Model	Cherry Maple Walnut	W	D	H	KW	Shipping Weight	Cubic Feet
Single Pedestal Desk	68DBF66364LDWRO	7166	65.75	36.25	28.5	33.25	307	46
with Full Height Pedestal	68DBF66364LFWRO*	7166	65.75	36.25	28.5	33.25	307	46
& Breakfront Modesty Panel	68DBF66364LORDW	7166	65.75	36.25	28.5	33.25	307	46
with Wire Management	68DBF66364LORFW	7166	65.75	36.25	28.5	33.25	307	46
Cavity	68DBF66364LDR0W	7166	65.75	36.25	28.5	33.25	307	46
	68DBF66364LFR0W	7166	65.75	36.25	28.5	33.25	307	46
	68DBF66364LOWRD	7166	65.75	36.25	28.5	33.25	307	46
	68DBF66364LOWRF	7166	65.75	36.25	28.5	33.25	307	46
	68DBF71364LDWRO	7234	71	36.25	28.5	38.25	325	50
	68DBF71364LFWRO	7234	71	36.25	28.5	38.25	325	50
	68DBF71364LORDW	7234	71	36.25	28.5	38.25	325	50
	68DBF71364LORFW	7234	71	36.25	28.5	38.25	325	50
	68DBF71364LDR0W	7234	71	36.25	28.5	38.25	325	50
	68DBF71364LFR0W	7234	71	36.25	28.5	38.25	325	50
	68DBF71364LOWRD	7234	71	36.25	28.5	38.25	325	50
	68DBF71364LOWRF	7234	71	36.25	28.5	38.25	325	50
	68DBF78364LDWRO	7343	78	36.25	28.5	45.5	350	36
	68DBF78364LFWRO	7343	78	36.25	28.5	45.5	350	36
	68DBF78364LORDW	7343	78	36.25	28.5	45.5	350	36
	68DBF78364LORFW	7343	78	36.25	28.5	45.5	350	36
	68DBF78364LDR0W	7343	78	36.25	28.5	45.5	350	36
	68DBF78364LFR0W	7343	78	36.25	28.5	45.5	350	36
	68DBF78364LOWRD	7343	78	36.25	28.5	45.5	350	36
	68DBF78364LOWRF	7343	78	36.25	28.5	45.5	350	36
	68DBF84364LDWRO	7390	78	36.25	28.5	51.5	352	39
	68DBF84364LFWRO	7390	78	36.25	28.5	51.5	352	39
	68DBF84364LORDW	7390	78	36.25	28.5	51.5	352	39
	68DBF84364LORFW	7390	78	36.25	28.5	51.5	352	39
	68DBF84364LDR0W	7390	78	36.25	28.5	51.5	352	39
	68DBF84364LFR0W	7390	78	36.25	28.5	51.5	352	39
	68DBF84364LOWRD	7390	78	36.25	28.5	51.5	352	39
	68DBF84364LOWRF	7390	78	36.25	28.5	51.5	352	39

ORDERING NOTES:

30" deep desks have flush modesty panels, 36" deep desks have recessed modesty panels. Please see page 6 for perforated metal modesty panel option.

Bow Top Option	Model	Weight	W	D	H	KW	Shipping Weight	Cubic Feet
	BT68D6030	606	-	-	-	-	-	-
	BT68D6630	634	-	-	-	-	-	-
	BT68D6636	666	-	-	-	-	-	-
	BT68D7130	693	-	-	-	-	-	-
	BT68D7136	714	-	-	-	-	-	-
	BT68D7830	731	-	-	-	-	-	-
	BT68D7836	740	-	-	-	-	-	-
	BT68D8436	752	-	-	-	-	-	-

ORDERING NOTES:

Add BT before any standard desk model number and apply upcharge. Add 15lbs to standard desk weight for bow top option.

DIMENSION KEY

W - width
D - depth
H - height

*Indicates model illustrated by line drawing.

CODE DESCRIPTION

4 - full height pedestal
L - left handed pedestal position
R - right handed pedestal position
0 - no pedestal
D - 2 file drawer
F - 2 box, 1 file drawer
BF- break front modesty panel
W - Wire Management Cavity

STANDARD FINISHES

For a complete list of standard wood finishes please see page 4. Standard Laminate work-surfaces are available at a 10% upcharge.

GROMMETS

One grommet in standard position is optional at no charge. Additional grommets are available at an upcharge of **\$152 List**.

MILLENNIUM DESKS

Description	Model	Cherry		W	D	H	KW	Shipping Weight	Cubic Feet
		Maple	Walnut						
	68TD6030	3224		60	30.25	28.5	57	280	38
	68TB6630	3263		65.75	30.25	28.5	63.25	290	41
	68TD7130	3327		71	30.25	28.5	68.25	300	45
	68TD7136	3333		71	36.25	28.5	68.25	310	54
	68TD8436	3366		84	36.25	28.5	81.25	320	63

ORDERING NOTES: This item includes a 68PD2116 pencil drawer.

	68TDE6630	4715		65.75	36.25	29.5	63	180	41
	68TDE7136	4822		71	36.25	29.5	68	238	54
	68TDE8436	4905		84	36.25	29.5	81	265	63

ORDERING NOTES: This item includes a 68PD2116 pencil drawer. Table desk has a clearance height of 25.25". Does not fit a pedestal underneath.

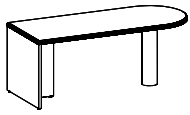
	68BD6030	3339		60	30.25	28.5	41.5	156	36
	68BD6630	3403		65.75	30.25	28.5	47.5	174	39
	68BD6636	3431		65.75	36.25	28.5	44.5	214	46
	68BD7130	3470		71	30.25	28.5	52.5	159	42
	68BD7136	3539		71	36.25	28.5	49.5	232	50

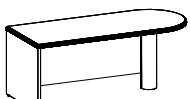

ORDERING NOTES: Please see page 6 for brushed aluminum tapered post leg option.

	68BD60303LGM	3666		60	30.25	28.5	14.75	189	36
	68BD66303LGM	3706		65.75	30.25	28.5	14.75	159	39
	68BD66364LGM	3736		65.75	36.25	28.5	17.75	229	46
	68BD71303LGM	3761		71	30.25	28.5	14.75	204	42
	68BD71363LGM	3784		71	36.25	28.5	17.75	247	50
	68BD84303LGM	3804		84	30.25	28.5	14.75	331	49
	68BD84363LGM	3847		84	36.25	28.5	17.75	274	59

	68BD60304LGM	3783		60	30.25	28.5	14.75	176	36
	68BD66304LGM	3820		65.75	30.25	28.5	14.75	194	39
	68BD66364LGM	3818		65.75	36.25	28.5	14.75	234	46
	68BD71304LGM	3859		71	30.25	28.5	14.75	209	42
	68BD71364LGM	3890		71	36.25	28.5	17.75	252	50
	68BD84304LGM	3929		84	30.25	28.5	14.75	232	49
	68BD84364LGM	3965		84	36.25	28.5	17.75	279	59

ORDERING NOTES: All curvilinear post legs are 6" in diameter.

ORDERING PROCEDURE

- To order, please specify the following:
- 1) Krug product model number
 - 2) Wood species and finish, see page 4
 - 3) Wood edge detail, see page 3
 - 4) Pull style, see page 3
 - 5) Grommet location if applicable

CODE DESCRIPTION

LGM - wood leg and modesty panel

STANDARD FINISHES

For a complete list of standard wood finishes please see page 4. Standard Laminate work-surfaces are available at a 10% upcharge.

GROMMETS

One grommet in standard position is optional at no charge. Additional grommets are available at an upcharge of **\$152 List**.

MILLENNIUM DESKS

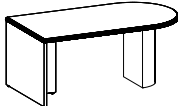
Description	Model	Cherry Maple Walnut	W	D	H	KW	Shipping	Cubic
							Weight	Feet
 Bullet Desk with Half Drum Base	68BD6630DB	3736	65.75	30.25	28.5	37.25	194	39
	68BD6636DB	3761	65.75	36.25	28.5	34.25	234	46
	68DB7130DB	3795	71	30.25	28.5	42.5	209	42
	68BD7136DB	3859	71	36.25	28.5	39.5	252	50
	68BD8430DB	3924	84	30.25	28.5	55.5	232	49
	68BD8436DB	4065	84	36.25	28.5	52.5	279	59
	68BD9636DB	4200	96	36.25	28.5	64.25	320	67

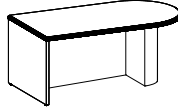
 Bullet Desk with Half Drum Base & Full Height Modesty Panel	68BD6630DBML	4196	65.75	30.25	28.5	23.25	209	39
	68BD6630DBMR	4196	65.75	30.25	28.5	23.25	209	39
	68BD6636DBML	4221	65.75	36.25	28.5	26.25	249	46
	68BD6636DBMR	4221	65.75	36.25	28.5	26.25	249	46
	68BD7130DBML	4256	71	30.25	28.5	23.25	224	42
	68BD7130DBMR	4256	71	30.25	28.5	23.25	224	42
	68BD7136DBML	4290	71	36.25	28.5	26.25	267	50
	68BD7136DBMR*	4290	71	36.25	28.5	26.25	267	50
	68BD8430DBML	4322	84	30.25	28.5	23.25	247	49
	68BD8430DBMR	4322	84	30.25	28.5	23.25	247	49
	68BD8436DBML	4426	84	36.25	28.5	26.25	294	59
	68BD8436DBMR	4426	84	36.25	28.5	26.25	294	59
	68BD9636DBML	4562	96	36.25	28.5	26.25	335	67
	68BD9636DBMR	4562	96	36.25	28.5	26.25	335	67

ORDERING NOTES: Please see page 6 for perforated metal modesty panel option.

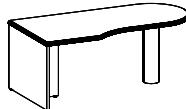
 Curved Corner Bullet Desk with Wood Post Leg	68CCB7130L	4576	71	36.25	28.5	51.25	232	45
	68CCB7130R	4576	71	36.25	28.5	51.25	232	45
	68CCB7830L	4670	78	36.25	28.5	58.25	257	50
	68CCB7830R*	4670	78	36.25	28.5	58.25	257	50
	68CCB8430L	4758	84	36.25	28.5	64.25	268	55
	68CCB8430R	4758	84	36.25	28.5	64.25	268	55

ORDERING NOTES: Please see page 6 for brushed aluminum tapered post leg option.

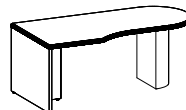
 Curved Corner Bullet Desk with Half Drum Base	68CCB7130LDB	4891	71	36.25	28.5	51.25	232	45
	68CCB7130RDB	4891	71	36.25	28.5	51.25	232	45
	68CCB7830LDB	4980	78	36.25	28.5	58.25	257	50
	68CCB7830RDB*	4980	78	36.25	28.5	58.25	257	50
	68CCB8430LDB	5077	84	36.25	28.5	64.25	268	55
	68CCB8430RDB	5077	84	36.25	28.5	64.25	268	55

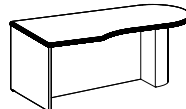
 Curved Corner Bullet Desk with Half Drum Base & Full Height Modesty Panel	68CCB7130LDBM	5174	71	36.25	28.5	51.25	232	45
	68CCB7130RDBM	5174	71	36.25	28.5	51.25	232	45
	68CCB7830LDBM	5263	78	36.25	28.5	58.25	257	50
	68CCB7830RDBM*	5263	78	36.25	28.5	58.25	257	50
	68CCB8430LDBM	5368	84	36.25	28.5	64.25	268	55
	68CCB8430RDBM	5368	84	36.25	28.5	64.25	268	55

ORDERING NOTES: Please see page 6 for perforated metal modesty panel option.

DIMENSION KEY

W - width
D - depth
H - height

*Indicates model illustrated by line drawing.

CODE DESCRIPTION

L - left handed pedestal position
R - right handed pedestal position
DB - half drum base
DBM - half drum base and modesty panel

STANDARD FINISHES

For a complete list of standard wood finishes please see page 4. Standard Laminate work-surfaces are available at a 10% upcharge.

RETURN OPTIONS

Curved corner bullet desks, "Q" desks, and "K" desks, accept 24" deep run-off units, returns and linking units..

MILLENNIUM DESKS

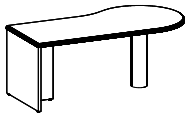
Description	Model	Cherry Maple Walnut	W	D	H	KW	Shipping Weight	Cubic Feet
 'P' Desk with Wood Post Leg	68PDL7130	4362	71	30	28.5	50	189	50
	68PDR7130	4362	71	30	28.5	50	189	50
	68PDL7136	4426	71	36	28.5	47.25	232	58
	68PDR7136	4426	71	36	28.5	47.25	232	58

ORDERING NOTES: Please see page 6 for brushed aluminum tapered post leg option.

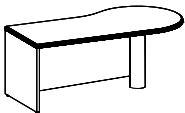
 'P' Desk with 3/4 Modesty Panel with Wood Post Leg	68PDL71303LGM	4635	71	30	28.5	50	204	50
	68PDR71303LGM	4635	71	30	28.5	50	204	50
	68PDL71363LGM	4752	71	36	28.5	47.25	247	58
	68PDR71363LGM	4752	71	36	28.5	47.25	247	58
	68PDL84303LGM	4863	84	30	28.5		227	59
	68PDR84303LGM	4863	84	30	28.5		227	59
	68PDL84363LGM	4904	84	36	28.5		274	68
	68PDR84363LGM	4904	84	36	28.5		274	68

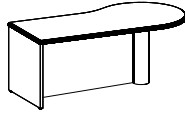
 'P' Desk with Full Height Modesty Panel & Wood Post Leg	68PDL71304LGM	4740	71	30	28.5	50	209	50
	68PDR71304LGM	4740	71	30	28.5	50	209	50
	68PDL71364LGM	4826	71	36	28.5	47.25	252	58
	68PDR71364LGM	4826	71	36	28.5	47.25	252	58
	68PDL84304LGM	4990	84	30	28.5		232	59
	68PDR84304LGM	4990	84	30	28.5		232	59
	68PDL84364LGM	5027	84	36	28.5		279	68
	68PDR84364LGM	5027	84	36	28.5		279	68
	68PDL96364LGM	5203	96	30	28.5		320	77
68PDR96364LGM	5203	96	30	28.5		320	77	

ORDERING NOTES: Please see page 6 for perforated metal modesty panel option.

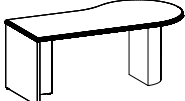
 'P' Desk with Half Drum Base	68PDL8430DB	4977	84	36	28.5		232	59
	68PDR8430DB*	4977	84	30	28.5		247	59
	68PDL8436DB	5010	84	30	28.5		279	68
	68PDR8436DB	5010	84	36	28.5		294	68
	68PDL9636DB	5382	96	36	28.5		320	77
	68PDR9636DB	5382	96	36	28.5		335	77

 'P' Desk with Half Drum Base & Full Height Modesty Panel	68PDL8430DBM	5105	84	36	28.5		247	59
	68PDR8430DBM	5105	84	30	28.5		247	59
	68PDL8436DBM	5436	84	36	28.5		294	68
	68PDR8436DBM	5436	84	36	28.5		294	68
	68PDL9636DBM	5846	96	36	28.5		335	77
	68PDR9636DBM	5846	96	36	28.5		335	77

ORDERING NOTES: Please see page 6 for perforated metal modesty panel option.

ORDERING PROCEDURE

- To order, please specify the following:
- 1) Krug product model number
 - 2) Wood species and finish, see page 4
 - 3) Wood edge detail, see page 3
 - 4) Pull style, see page 3
 - 5) Grommet location if applicable

*Indicates model illustrated by line drawing.

CODE DESCRIPTION

- 4 - full height modesty panel
- 3 - 3/4 modesty panel
- LGM - wood leg and modesty panel
- DBM - half drum base and modesty panel

STANDARD FINISHES

For a complete list of standard wood finishes please see page 4. Standard Laminate work-surfaces are available at a 10% upcharge.

GROMMETS

One grommet in standard position is optional at no charge. Additional grommets are available at an upcharge of **\$152 List**.

MILLENNIUM DESKS

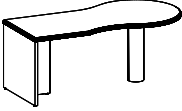
Description	Model	Cherry	W	D	H	KW	Shipping Weight	Cubic Feet
		Maple Walnut						
 'Q' Desk with Wood Post Leg	68QDL7130	4362	71	30	28.5	49.5	189	50
	68QDR7130*	4362	71	30	28.5	49.5	189	50
	68QDL8436	4643	84	36	28.5	59.75	232	68
	68QDR8436	4643	84	36	28.5	59.75	232	68

ORDERING NOTES: Please see page 6 for brushed aluminum tapered post leg option. All curvilinear posts are 6" in diameter.

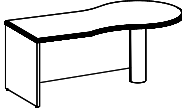
 'Q' Desk with 3/4 Modesty Panel & Wood Post Leg	68QDL71303LGM	4752	71	30	28.5	204	50
	68QDR71303LGM*	4752	71	30	28.5	204	50
	68QDL84363LGM	4904	84	36	28.5	274	68
	68QDR84363LGM	4904	84	36	28.5	274	68

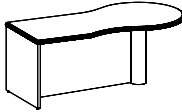
 'Q' Desk with Full Height Modesty Panel & Wood Post Leg	68QDL71304LGM	4826	71	30	28.5	269	50
	68QDR71304LGM*	4826	71	30	28.5	269	50
	68QDL84364LGM	5027	84	36	28.5	279	68
	68QDR84364LGM	5027	84	36	28.5	279	68

ORDERING NOTES: Please see page 6 for perforated metal modesty panel option.

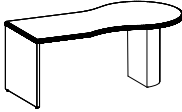
 'Q' Desk with Half Drum Base	68QDL8436DB	5010	84	36	28.5	49.5	279	68
	68QDR8436DB*	5010	84	36	28.5	49.5	279	68
	68QDL9636DB	5389	96	36	28.5	59.75	320	68
	68QDR9636DB"	5389	96	36	28.5	59.75	320	68

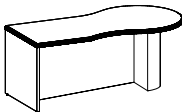
 'Q' Desk with Half Drum Base & Full Height Modesty Panel	68QDL8436DBM	5436	84	36	28.5	46.5	294	68
	68QDR8436DBM*	5436	84	36	28.5	46.5	294	68
	68QDL9636DBM	5846	96	36	28.5	68	335	68
	68QDR9636DBM	5846	96	36	28.5	68	335	68

ORDERING NOTES: Please see page 6 for perforated metal modesty panel option.

DIMENSION KEY

W - width
D - depth
H - height

*Indicates model illustrated by line drawing.

CODE DESCRIPTION

3 - 3/4 height modesty panel
4 - full height modesty panel
D - 2 file drawers, 1 file draw
F - 2 box, 1 file drawer
DB - half drum base
LGM - wood leg and modesty panel
DBM - half drum base

STANDARD FINISHES

For a complete list of standard wood finishes please see page 4. Standard Laminate work-surfaces are available at a 10% upcharge.

RETURN OPTIONS

Curved corner bullet desks, "Q" desks, and "K" desks, accept 24" deep run-off units, returns and linking units.

MILLENNIUM DESKS

Description	Model	Cherry Maple Walnut	W	D	H	KW	Shipping Weight	Cubic Feet
'K' Desk with Wood Post Leg	68KDL7130	4362	71	30	28.5	49.5	189	50
	68KDR7130*	4362	71	30	28.5	49.5	189	50
	68KDL8436	4643	84	36	28.5	59.75	232	68
	68KDR8436	4643	84	36	28.5	59.75	232	68

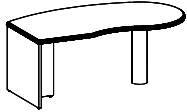

ORDERING NOTES: Please see page 6 for brushed aluminum tapered post leg option.

'K' Desk with 3/4 Modesty Panel with Wood Post Leg	68KDL71303LGM	4734	71	30	28.5	49.5	204	50
	68KDR71303LGM*	4734	71	30	28.5	49.5	204	50
	68KDL84363LGM	4904	84	36	28.5	59.75	274	68
	68KDR84363LGM	4904	84	36	28.5	59.75	274	68

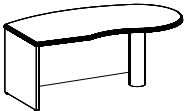

'K' Desk with Full Height Modesty Panel & Wood Post Leg	68KDL71304LGM	4838	71	30	28.5	49.5	209	50
	68KDR71304LGM*	4838	71	30	28.5	49.5	209	50
	68KDL84364LGM	5027	84	36	28.5	59.75	274	68
	68KDR84364LGM	5027	84	36	28.5	59.75	224	68

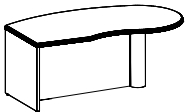

ORDERING NOTES: Please see page 6 for perforated metal modesty panel option. Overhang on the 'K' desk is 23" from the modesty panel.

'K' Desk with Half Drum Base	68KDL8436DB	5010	84	36	28.5	61.75	279	68
	68KDR8436DB*	5010	84	36	28.5	61.75	279	68
	68KDL9636DB	5389	96	36	28.5	68	320	68
	68KDR9636DB	5389	96	36	28.5	68	320	68

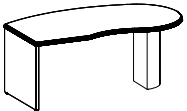

'K' Desk with Half Drum Base & Full Height Modesty Panel	68KDL8436DBM	5427	84	36	28.5	61.75	294	68
	68KDR8436DBM*	5427	84	36	28.5	61.75	294	68
	68KDL9636DBM	5846	96	36	28.5	68	335	68
	68KDR9636DBM	5846	96	36	28.5	68	335	68

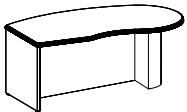

ORDERING NOTES: Please see page 6 for perforated metal modesty panel option. Overhang on the 'K' desk is 23" from the modesty panel.

ORDERING PROCEDURE

- To order, please specify the following:
- 1) Krug product model number
 - 2) Wood species and finish, see page 4
 - 3) Wood edge detail, see page 3
 - 4) Pull style, see page 3
 - 5) Grommet location if applicable

*Indicates model illustrated by line drawing.

CODE DESCRIPTION

- 3 - 3/4 height modesty panel
- 4 - full height modesty panel
- DB - half drum base
- LGM - wood leg and modesty panel
- DBM - half drum base and

STANDARD FINISHES

For a complete list of standard wood finishes please see page 4. Standard Laminate work-surfaces are available at a 10% upcharge.

RETURN OPTIONS

Curved corner bullet desks, "Q" desks, and "K" desks, except 24" deep run-off units, returns and linking units.

MILLENNIUM HEIGHT ADJUSTABLE DESK WORKSURFACES

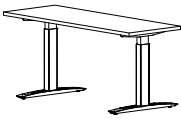
Description	Model	Cherry	W	D	H	KW	Shipping Weight	Cubic Feet
		Maple Walnut						
Electronic Height Adjustable Worksurface	68HA3024ETS	3074	29.75	24	"-	17	108.5	11.5
	68HA3624ETS	3103	35.75	24	"-	23	109	14
	68HA4224ETS	3188	41.75	24	"-	29	109	16.5
	68HA4824ETS	3271	47.75	24	"-	35	109.5	19
	68HA5424ETS	3330	53.5	24	"-	41	110	21.5
	68HA6024ETS	3408	59.75	24	"-	47	111	24
	68HA6624ETS	3746	2719	24	"-	53	114	26.5
	68HA7124ETS	3941	71.75	24	"-	59	119.5	29
	68HA7824ETS	3962	77.75	24	"-	65	122.5	31.5
	68HA8424ETS	4268	83.75	24	"-	71	127	34
	68HA3030ETS	3972	29.75	30	"-	17	121.5	36.75
	68HA3630ETS	3383	35.75	30	"-	23	122	14.25
	68HA4230ETS	3448	41.75	30	"-	29	122	17.5
	68HA4830ETS	3528	47.75	30	"-	35	122.5	20.5
	68HA5430ETS	3627	53.5	30	"-	41	123	23.5
	68HA6030ETS	3688	59.75	30	"-	47	124	26.5
	68HA6630ETS	3896	65.75	30	"-	53	131	29.75
	68HA7130ETS	4095	71.75	30	"-	59	132.5	32.75
68HA7830ETS	4114	77.75	30	"-	65	142.5	35.75	
68HA8430ETS	4347	83.75	30	"-	71	143.5	38.75	
68HA3036ETS	4040	29.75	36	"-	17	121.5	42	
68HA3636ETS	3454	35.75	36	"-	23	122	45.5	
68HA4236ETS	3684	41.75	36	"-	29	122	17.25	
68HA4836ETS	3754	47.75	36	"-	35	122.5	20.75	
68HA5436ETS	3841	53.5	36	"-	41	123	24.5	
68HA6036ETS	3924	59.75	36	"-	47	124	28.25	
68HA6636ETS	4227	65.75	36	"-	53	134	32	
68HA7136ETS	4245	71.75	36	"-	59	151.5	35.5	
68HA7836ETS	4286	77.75	36	"-	65	158.5	39.25	
68HA8436ETS	4732	83.75	36	"-	71	159.5	43	

Programmable Display-4 Position Memory	68HAPD	376	-	-	-	-	-	-
--	--------	-----	---	---	---	---	---	---

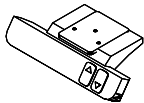

ORDERING NOTES & OPTIONS

Lifts come standard with an up/down button. Standard colors are Silver Metallic & Black, please contact customer service for other available colors. An optional 4 position programmable display can be specified above.

To order a height adjustable work surface with a top overhang of 16" at one end add O16 to the end of the model number. eg. 68HA6024ETSO16. Please note that this option is not available on height adjustable work surfaces that are 42" or less in length or on dual stage electronic height adjustable worksurfaces.

To order a dual stage height adjustable base add **\$674** to the list price and replace ETS with ETD. eg. 68HA6030ETD.

Standard base is a T-base. A C base can be specified at the same price. To order a C-base on worksurfaces, up to 30" deep only, replace "T" with "C" e.g. 68HA8430ECS

Single stage height adjustable range: 26" - 45.5" & Dual stage height adjustable range: 21" - 47"
Power cord is 10 feet long.

DIMENSION KEY

W - width
D - depth
H - height

CODE DESCRIPTION

HA - height adjustable
E - electric
T - T- base
C - C- base
S - single stage
D - dual stage

STANDARD FINISHES

For a complete list of standard wood finishes please see page 4. Standard Laminate work-surfaces are available at a 10% upcharge.

GROMMETS

One grommet in standard position is optional at no charge. Additional grommets are available at an upcharge of **\$152 List**.

MILLENNIUM HEIGHT ADJUSTABLE DESK WORKSURFACES

Description	Model	Cherry Maple Walnut	W	D	H	KW	Shipping Weight	Cubic Feet
Electronic Height Adjustable	68HA3024ETSV21	3399	29.75	24	"-	17	114.5	11.5
Work Surface with Wood	68HA3624ETSV21	3493	35.75	24	"-	23	117	14
Modesty Panel	68HA4224ETSV21	3643	41.75	24	"-	29	118	16.5
	68HA4824ETSV21	3792	47.75	24	"-	35	119.5	19
	68HA5424ETSV21	3917	53.5	24	"-	41	122	21.5
	68HA6024ETSV21	4093	59.75	24	"-	47	124	24
	68HA6624ETSV21	4437	65.75	24	"-	53	128	26.5
	68HA7124ETSV21	4648	71.75	24	"-	59	134.5	29
	68HA7824ETSV21	4681	77.75	24	"-	65	139.5	31.5
	68HA8424ETSV21	5000	83.75	24	"-	71	145	34
	68HA3030ETSV21	4295	29.75	30	"-	17	127.5	36.75
	68HA3630ETSV21	3772	35.75	30	"-	23	130	14.25
	68HA4230ETSV21	3902	41.75	30	"-	29	131	17.5
	68HA4830ETSV21	4045	47.75	30	"-	35	132.5	20.5
	68HA5430ETSV21	4184	53.5	30	"-	41	135	23.5
	68HA6030ETSV21	4377	59.75	30	"-	47	137	26.5
	68HA6630ETSV21	4587	65.75	30	"-	53	145	29.75
	68HA7130ETSV21*	4799	71.75	30	"-	59	147.5	32.75
	68HA7830ETSV21	4114	77.75	30	"-	65	159.5	35.75
	68HA8430ETSV21	5064	83.75	30	"-	71	161.5	38.75
	68HA3036ETSV21	4772	29.75	36	"-	17	127.5	42
	68HA3636ETSV21	3780	35.75	36	"-	23	130	45.5
	68HA4236ETSV21	4072	41.75	36	"-	29	131	17.25
	68HA4836ETSV21	4222	47.75	36	"-	35	132.5	20.75
	68HA5436ETSV21	4361	53.5	36	"-	41	135	24.5
	68HA6036ETSV21	4611	59.75	36	"-	47	137	28.25
	68HA6636ETSV21	4918	65.75	36	"-	53	148	32
	68HA7136ETSV21	4951	71.75	36	"-	59	166.5	35.5
	68HA7836ETSV21	5013	77.75	36	"-	65	175.5	39.25
	68HA8436ETSV21	5517	83.75	36	"-	71	177.5	43
Programmable Display- 4 Position Memory	68HAPD	376	-	-	-	-	-	-

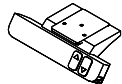
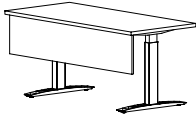

ORDERING NOTES & OPTIONS

Lifts come standard with an up/down button. Standard colors are Silver Metallic & Black, please contact customer service for other available colors. An optional 4 position programmable display can be specified above.

To order a height adjustable work surface with a top overhang of 16" at one end add O16 to the end of the model number. eg. 68HA8436ETSO16G. Please note that this option is not available on height adjustable work surfaces that are 42" or less in length or on dual stage electronic height adjustable worksurfaces.

To order a dual stage height adjustable base add **\$674** to the list price and replace ETS with ETD. eg.68HA8436ETDG.

Standard base is a T-base. A C base can be specified at the same price. To order a C-base on worksurfaces, up to 30" deep only, replace "T" with "C" e.g. 68HA8436ECSG

Modesty panels are available in low pressure laminate, please replace V21 with V26 for this option or in palette, please replace V21 with V22 for this option.

Single stage height adjustable range: 26" - 45.5" & Dual stage height adjustable range: 21" - 47"
Power cord is 10 feet long.

ORDERING PROCEDURE

- To order, please specify the following:
- 1) Krug product model number
 - 2) Wood species and finish, see page 4
 - 3) Wood edge detail, see page 3
 - 4) Pull style, see page 3
 - 5) Grommet location if applicable

CODE DESCRIPTION

- HA - height adjustable
- E - electric
- T - T- base
- C - C- base
- S - single stage
- D - dual stage
- V21- half height floating wood modesty panel
- V26- half height floating laminate modesty panel

STANDARD FINISHES

For a complete list of standard wood finishes please see page 4. Standard Laminate worksurfaces are available at a 10% upcharge.

GROMMETS

One grommet in standard position is optional at no charge. Additional grommets are available at an upcharge of **\$152 List**.

MILLENNIUM HEIGHT ADJUSTABLE DESK WORKSURFACES

Description	Model	Cherry Maple Walnut	W	D	H	KW	Shipping Weight	Cubic Feet
Electronic Height Adjustable Work Surface with Base Enclosure	68HA4224ETSG	5103	41.75	24	"-	24	154	16.5
	68HA4824ETSG	5185	47.75	24	"-	30	154.5	19
	68HA5424ETSG	5243	53.5	24	"-	36	155	21.5
	68HA6024ETSG	5319	59.75	24	"-	42	156	24
	68HA6624ETSG	5660	65.75	24	"-	48	159	26.5
	68HA7124ETSG	5856	71.75	24	"-	54	164.5	29
	68HA7824ETSG	5874	77.75	24	"-	60	167.5	31.5
	68HA8424ETSG	6182	83.75	24	"-	66	172	34
	68HA4230ETSG	5586	41.75	30	"-	24	177	17.5
	68HA4830ETSG	5664	47.75	30	"-	30	177.5	20.5
	68HA5430ETSG	5739	53.5	30	"-	36	178	23.5
	68HA6030ETSG	5828	59.75	30	"-	42	179	26.5
	68HA6630ETSG	6035	65.75	30	"-	42	186	29.75
	68HA7130ETSG	6233	71.75	30	"-	54	187.5	32.75
	68HA7830ETSG	6254	77.75	30	"-	60	197.5	35.75
	68HA8430ETSG	6484	83.75	30	"-	66	198.5	38.75
	68HA4236ETSG	6044	41.75	36	"-	24	187	17.25
	68HA4836ETSG	6113	47.75	36	"-	30	187.5	20.75
	68HA5436ETSG	6199	53.5	36	"-	36	188	24.5
68HA6036ETSG	6285	59.75	36	"-	42	189	28.25	
68HA6636ETSG	6585	65.75	36	"-	48	199	32	
68HA7136ETSG	6605	71.75	36	"-	54	216.5	35.5	
68HA7836ETSG	6644	77.75	36	"-	60	223.5	39.25	
68HA8436ETSG	7091	83.75	36	"-	66	224.5	43	
Programmable Display- 4 Position Memory	68HAPD	376	-	-	-	-	-	-

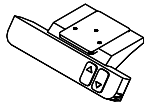
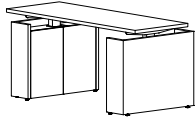

ORDERING NOTES:

Lifts come standard with an up/down button. Standard colors are Silver Metallic & Black, please contact customer service for other available colors. An optional 4 position programmable display can be specified above.

To order a height adjustable work surface with a top overhang of 16" at one end insert O16 into the model number after ETS. eg. 68HA6024ETSO16G. Please note that this option is not available on height adjustable work surfaces with base enclosures that are 54" or less in length. This option is not available on dual stage electronic height adjustable work surfaces.

To order a dual stage height adjustable base add **\$674** to the list price and replace ESTA with ETD. eg. 68HA6030ETDG.

Single stage height adjustable range: 26" - 45.5"

Dual stage height adjustable range: 21" - 47"

Power cord is 10 feet long.

DIMENSION KEY

W - width

D - depth

H - height

CODE DESCRIPTION

HA - height adjustable

E - electric

T - T- base

C - C- base

S - single stage

D - dual stage

G - base enclosure

STANDARD FINISHES

For a complete list of standard wood finishes please see page 4. Standard Laminate work-surfaces are available at a 10% upcharge.

GROMMETS

One grommet in standard position is optional at no charge. Additional grommets are available at an upcharge of **\$152 List**.

MILLENNIUM HEIGHT ADJUSTABLE DESK WORKSURFACES

Description	Model	Cherry	W	D	H	KW	Shipping Weight	Cubic Feet
		Maple Walnut						
Electronic Height	68HA4224ETSGV21	5384	41.75	24	"-	24	163	16.5
Adjustable Worksurface with Base Enclosure and Floating Modesty Panel	68HA4824ETSGV21	5479	47.75	24	"-	30	164.5	19
	68HA5424ETSGV21	5553	53.5	24	"-	36	167	21.5
	68HA6024ETSGV21	5644	59.75	24	"-	42	169	24
	68HA6624ETSGV21	6002	65.75	24	"-	48	173	26.5
	68HA7124ETSGV21	6213	71.75	24	"-	54	179.5	29
	68HA7824ETSGV21	6253	77.75	24	"-	60	184.5	31.5
	68HA8424ETSGV21	6578	83.75	24	"-	66	190	34
	68HA4230ETSGV21	5867	41.75	30	"-	24	186	17.5
	68HA4830ETSGV21	5961	47.75	30	"-	30	187.5	20.5
	68HA5430ETSGV21	6048	53.5	30	"-	36	190	23.5
	68HA6030ETSGV21	6155	59.75	30	"-	42	192	26.5
	68HA6630ETSGV21	6377	65.75	30	"-	48	200	29.75
	68HA7130ETSGV21	6594	71.75	30	"-	54	202.5	32.75
68HA7830ETSGV21	6630	77.75	30	"-	60	214.5	35.75	
68HA8430ETSGV21	6862	83.75	30	"-	66	216.5	38.75	
68HA4236ETSGV21	6323	6323	41.75	36	"-	24	196	17.25
68HA4836ETSGV21	6394	6394	47.75	36	"-	30	197.5	20.75
68HA5436ETSGV21	6495	6495	53.5	36	"-	36	200	24.5
68HA6036ETSGV21	6595	6595	59.75	36	"-	42	202	28.25
68HA6636ETSGV21	6912	6912	65.75	36	"-	48	213	32
68HA7136ETSGV21	6945	6945	71.75	36	"-	54	231.5	35.5
68HA7836ETSGV21	7020	7020	77.75	36	"-	60	240.5	39.25
68HA8436ETSGV21	7294	7294	83.75	36	"-	66	242.5	43
Programmable Display- 4 Position Memory	68HAPD	376	-	-	-	-	-	-

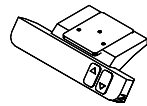
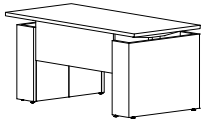

ORDERING NOTES:

Lifts come standard with an up/down button. Standard colors are Silver Metallic & Black, please contact customer service for other available colors. An optional 4 position programmable display can be specified above.

To order a height adjustable work surface with a top overhang of 16" at one end insert O16 into the model number after ETS. eg. 68HA8436ETSO16GV21. Please note that this option is not available on height adjustable work surfaces with base enclosures that are 54" or less in length. This option is not available on dual stage electronic height adjustable worksurfaces.

To order a dual stage height adjustable base add **\$674** to the list price and replace ETS with ETD. eg. 68HA6030ETDGV21.

Standard base is a T-base. A C base can be specified at the same price. To order a C-base on worksurfaces, up to 30" deep only, replace "T" with "C" e.g. 68HA6630ECSV21

Modesty panels are available in low pressure laminate, please replace V21 with V26 for this option or in palette, please replace V21 with V22 for this option.

Single stage height adjustable range: 26" - 45.5"

Dual stage height adjustable range: 21" - 47"

Power cord is 10 feet long.

ORDERING PROCEDURE

To order, please specify the following:

- 1) Krug product model number
- 2) Wood species and finish, see page 4
- 3) Wood edge detail, see page 3
- 4) Pull style, see page 3
- 5) Grommet location if applicable

CODE DESCRIPTION

HA - height adjustable
 E - electric
 T - T- base
 C - C- base
 S - single stage
 D - dual stage
 G - base enclosure
 V21- half height floating wood modesty panel

STANDARD FINISHES

For a complete list of standard wood finishes please see page 4. Standard Laminate work-surfaces are available at a 10% upcharge.

GROMMETS

One grommet in standard position is optional at no charge. Additional grommets are available at an upcharge of **\$152 List**.

MILLENNIUM HEIGHT ADJUSTABLE RETURN WORKSURFACES

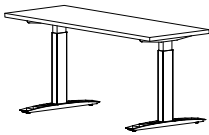
Description	Model	Cherry Maple Walnut	W	D	H	KW	Shipping Weight	Cubic Feet	
	Electronic Height Adjustable Return Worksurface	68HA4824RHETS	3271	47.75	24	"-	35	109.5	19
		68HA5424RHETS	3330	53.5	24	"-	41	110	21.5
		68HA6024RHETS	3408	59.75	24	"-	47	111	24
		68HA6624RHETS	3746	2719	24	"-	53	114	26.5
		68HA7124RHETS	3941	71.75	24	"-	59	119.5	29
		68HA7824RHETS	3962	77.75	24	"-	65	122.5	31.5
		68HA8424RHETS	4268	83.75	24	"-	71	127	34
		68HA4830RHETS	3528	47.75	30	"-	35	122.5	20.5
		68HA5430RHETS	3627	53.5	30	"-	41	123	23.5
		68HA6030RHETS	3688	59.75	30	"-	47	124	26.5
		68HA6630RHETS	3896	65.75	30	"-	53	131	29.75
		68HA7130RHETS	4095	71.75	30	"-	59	132.5	32.75
		68HA7830RHETS	4114	77.75	30	"-	65	142.5	35.75
		68HA8430RHETS	4347	83.75	30	"-	71	143.5	38.75
		68HA4836RHETS	3754	47.75	36	"-	35	122.5	20.75
		68HA5436RHETS	3841	53.5	36	"-	41	123	24.5
		68HA6036RHETS	3924	59.75	36	"-	47	124	28.25
		68HA6636RHETS	4227	65.75	36	"-	53	134	32
		68HA7136RHETS	4245	71.75	36	"-	59	151.5	35.5
		68HA7836RHETS	4286	77.75	36	"-	65	158.5	39.25
	68HA8436RHETS	4732	83.75	36	"-	71	159.5	43	

Programmable Display- 4 Position Memory	68HAPD	376	-	-	-	-	-	-
--	--------	-----	---	---	---	---	---	---

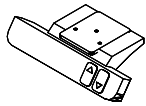

ORDERING NOTES & OPTIONS

Lifts come standard with an up/down button. Standard colors are Silver Metallic & Black, please contact customer service for other available colors. An optional 4 position programmable display can be specified above.

To order a height adjustable work surface with a top overhang of 16" at one end add O16 to the end of the model number. eg. 68HA6024RHETSO16. Please note that this option is not available on height adjustable work surfaces that are 42" or less in length or on dual stage electronic height adjustable work surfaces.

To order a dual stage height adjustable base add **\$674** to the list price and replace ETS with ETD. eg. 68HA603RH0ETD.

Standard base is a T-base. A C base can be specified at the same price. To order a C-base on work surfaces, up to 30" deep only, replace "T" with "C" e.g. 68HA8430RHECS

Single stage height adjustable range: 26" - 45.5" & Dual stage height adjustable range: 21" - 47"
Power cord is 10 feet long.

DIMENSION KEY

W - width
D - depth
H - height

CODE DESCRIPTION

HA - height adjustable
RH - return (cross grain)
E - electric
T - T- base
C - C- base
S - single stage
D - dual stage

STANDARD FINISHES

For a complete list of standard wood finishes please see page 4. Standard Laminate work surfaces are available at a 10% upcharge.

GROMMETS

One grommet in standard position is optional at no charge. Additional grommets are available at an upcharge of **\$152 List**.

MILLENNIUM HEIGHT ADJUSTABLE RETURN WORKSURFACES

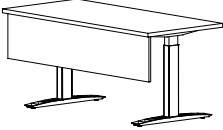
Description	Model	Cherry		W	D	H	KW	Shipping Weight	Cubic Feet
		Maple	Walnut						
	Electronic Height Adjustable Return Worksurface with Wood Modesty Panel	68HA4824RHETSV21	3792	47.75	24	"-	35	119.5	19
		68HA5424RHETSV21	3917	53.5	24	"-	41	122	21.5
		68HA6024RHETSV21	4093	59.75	24	"-	47	124	24
		68HA6624RHETSV21	4437	65.75	24	"-	53	128	26.5
		68HA7124RHETSV21	4648	71.75	24	"-	59	134.5	29
		68HA7824RHETSV21	4681	77.75	24	"-	65	139.5	31.5
		68HA8424RHETSV21	5000	83.75	24	"-	71	145	34
		68HA4830RHETSV21	4045	47.75	30	"-	35	132.5	20.5
		68HA5430RHETSV21	4184	53.5	30	"-	41	135	23.5
		68HA6030RHETSV21	4377	59.75	30	"-	47	137	26.5
		68HA6630RHETSV21	4587	65.75	30	"-	53	145	29.75
		68HA7130RHETSV21	4799	71.75	30	"-	59	147.5	32.75
		68HA7830RHETSV21	4114	77.75	30	"-	65	159.5	35.75
		68HA8430RHETSV21	5064	83.75	30	"-	71	161.5	38.75
		68HA4836RHETSV21	4222	47.75	36	"-	35	132.5	20.75
		68HA5436RHETSV21	4361	53.5	36	"-	41	135	24.5
		68HA6036RHETSV21	4611	59.75	36	"-	47	137	28.25
		68HA6636RHETSV21	4918	65.75	36	"-	53	148	32
		68HA7136RHETSV21	4951	71.75	36	"-	59	166.5	35.5
		68HA7836RHETSV21	5013	77.75	36	"-	65	175.5	39.25
	68HA8436RHETSV21	5517	83.75	36	"-	71	177.5	43	

Programmable Display-4 Position Memory	68HAPD	376	-	-	-	-	-	-	-
--	--------	-----	---	---	---	---	---	---	---

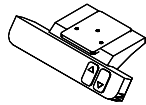

ORDERING NOTES & OPTIONS

Lifts come standard with an up/down button. Standard colors are Silver Metallic & Black, please contact customer service for other available colors. An optional 4 position programmable display can be specified above.

To order a height adjustable work surface with a top overhang of 16" at one end add O16 to the end of the model number. eg. 68HA843RH6ETSO16G. Please note that this option is not available on height adjustable work surfaces that are 42" or less in length or on dual stage electronic height adjustable worksurfaces.

To order a dual stage height adjustable base add **\$674** to the list price and replace ETS with ETD. eg.68HA8436RHETD.G.

Standard base is a T-base. A C base can be specified at the same price. To order a C-base on worksurfaces, up to 30" deep only, replace "T" with "C" e.g. 68HA8436RHECSG

Modesty panels are available in low pressure laminate, please replace V21 with V26 for this option or in palette, please replace V21 with V22 for this option.

Single stage height adjustable range: 26" - 45.5" & Dual stage height adjustable range: 21" - 47"
Power cord is 10 feet long.

ORDERING PROCEDURE

- To order, please specify the following:
- 1) Krug product model number
 - 2) Wood species and finish, see page 4
 - 3) Wood edge detail, see page 3
 - 4) Pull style, see page 3
 - 5) Grommet location if applicable

*Indicates model illustrated by line drawing.

CODE DESCRIPTION

- HA - height adjustable
- RH - return (cross grain)
- E - electric
- T - T- base
- C - C- base
- S - single stage
- D - dual stage
- V21 - 1/2 height floating wood modesty panel

STANDARD FINISHES

For a complete list of standard wood finishes please see page 4. Standard Laminate work-surfaces are available at a 10% upcharge.

GROMMETS

One grommet in standard position is optional at no charge. Additional grommets are available at an upcharge of **\$152 List**.

MILLENNIUM HEIGHT ADJUSTABLE RETURN WORKSURFACES

Description	Model	Cherry Maple Walnut	W	D	H	KW	Shipping Weight	Cubic Feet
Electronic Height Adjustable Return Worksurface with Base Enclosure	68HA4824RHETSG	5185	47.75	24	"-"	30	154.5	19
	68HA5424RHETSG	5243	53.5	24	"-"	36	155	21.5
	68HA6024RHETSG	5319	59.75	24	"-"	42	156	24
	68HA6624RHETSG	5660	65.75	24	"-"	48	159	26.5
	68HA7124RHETSG	5856	71.75	24	"-"	54	164.5	29
	68HA7824RHETSG	5874	77.75	24	"-"	60	167.5	31.5
	68HA8424RHETSG	6182	83.75	24	"-"	66	172	34
	68HA4830RHETSG	5664	47.75	30	"-"	30	177.5	20.5
	68HA5430RHETSG	5739	53.5	30	"-"	36	178	23.5
	68HA6030RHETSG	5828	59.75	30	"-"	42	179	26.5
	68HA6630RHETSG	6035	65.75	30	"-"	42	186	29.75
	68HA7130RHETSG	6233	71.75	30	"-"	54	187.5	32.75
	68HA7830RHETSG	6254	77.75	30	"-"	60	197.5	35.75
	68HA8430RHETSG	6484	83.75	30	"-"	66	198.5	38.75
	68HA4836RHETSG	6113	47.75	36	"-"	30	187.5	20.75
	68HA5436RHETSG	6199	53.5	36	"-"	36	188	24.5
68HA6036RHETSG	6285	59.75	36	"-"	42	189	28.25	
68HA6636RHETSG	6585	65.75	36	"-"	48	199	32	
68HA7136RHETSG	6605	71.75	36	"-"	54	216.5	35.5	
68HA7836RHETSG	6644	77.75	36	"-"	60	223.5	39.25	
68HA8436RHETSG	7091	83.75	36	"-"	66	224.5	43	

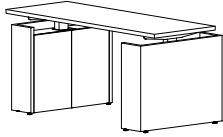

Programmable Display-
4 Position Memory

68HAPD

376

- - - - -

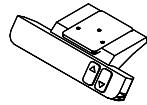

ORDERING NOTES:

Lifts come standard with an up/down button. Standard colors are Silver Metallic & Black, please contact customer service for other available colors. An optional 4 position programmable display can be specified above.

To order a height adjustable work surface with a top overhang of 16" at one end insert O16 into the model number after ETS.

eg. 68HA6024RHETSO16G. Please note that this option is not available on height adjustable work surfaces with base enclosures that are 54" or less in length. This option is not available on dual stage electronic height adjustable worksurfaces.

To order a dual stage height adjustable base add **\$674** to the list price and replace ESTA with ETD. eg. 68HA6030RHETDG.

Single stage height adjustable range: 26" - 45.5"

Dual stage height adjustable range: 21" - 47"

Power cord is 10 feet long.

DIMENSION KEY

W - width

D - depth

H - height

CODE DESCRIPTION

HA - height adjustable

RH - return (cross grain)

E - electric

T - T- base

C - C- base

S - single stage

D - dual stage

G - base enclosure

STANDARD FINISHES

For a complete list of standard wood finishes please see page 4. Standard Laminate work-surfaces are available at a 10% upcharge.

GROMMETS

One grommet in standard position is optional at no charge. Additional grommets are available at an upcharge of **\$152 List**.

MILLENNIUM HEIGHT ADJUSTABLE RETURN WORKSURFACES

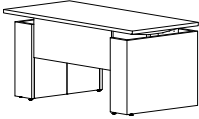
Description	Model	Cherry Maple Walnut	W	D	H	KW	Shipping Weight	Cubic Feet
	68HA4824RHETSGV21	5479	47.75	24	"-	30	164.5	19
	68HA5424RHETSGV21	5553	53.5	24	"-	36	167	21.5
	68HA6024RHETSGV21	5644	59.75	24	"-	42	169	24
	68HA6624RHETSGV21	6002	65.75	24	"-	48	173	26.5
	68HA7124RHETSGV21	6213	71.75	24	"-	54	179.5	29
	68HA7824RHETSGV21	6253	77.75	24	"-	60	184.5	31.5
	68HA8424RHETSGV21	6578	83.75	24	"-	66	190	34
	68HA4830RHETSGV21	5961	47.75	30	"-	30	187.5	20.5
	68HA5430RHETSGV21	6048	53.5	30	"-	36	190	23.5
	68HA6030RHETSGV21	6155	59.75	30	"-	42	192	26.5
	68HA6630RHETSGV21	6377	65.75	30	"-	48	200	29.75
	68HA7130RHETSGV21	6594	71.75	30	"-	54	202.5	32.75
	68HA7830RHETSGV21	6630	77.75	30	"-	60	214.5	35.75
	68HA8430RHETSGV21	6862	83.75	30	"-	66	216.5	38.75
	68HA4836RHETSGV21	6394	47.75	36	"-	30	197.5	20.75
	68HA5436RHETSGV21	6495	53.5	36	"-	36	200	24.5
	68HA6036RHETSGV21	6595	59.75	36	"-	42	202	28.25
	68HA6636RHETSGV21	6912	65.75	36	"-	48	213	32
68HA7136RHETSGV21	6945	71.75	36	"-	54	231.5	35.5	
68HA7836RHETSGV21	7020	77.75	36	"-	60	240.5	39.25	
68HA8436RHETSGV21	7294	83.75	36	"-	66	242.5	43	

Programmable Display- 4 Position Memory	68HAPD	376	-	-	-	-	-	-
--	--------	-----	---	---	---	---	---	---

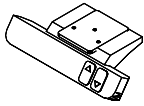

ORDERING NOTES:

Lifts come standard with an up/down button. Standard colors are Silver Metallic & Black, please contact customer service for other available colors. An optional 4 position programmable display can be specified above.

To order a height adjustable work surface with a top overhang of 16" at one end insert O16 into the model number after ETS. eg. 68HA8436RHETSO16GV21. Please note that this option is not available on height adjustable work surfaces with base enclosures that are 54" or less in length. This option is not available on dual stage electronic height adjustable work surfaces.

To order a dual stage height adjustable base add **\$674** to the list price and replace ETS with ETD. eg. 68HA6030RHETDGV21.

Standard base is a T-base. A C base can be specified at the same price. To order a C-base on work surfaces, up to 30" deep only, replace "T" with "C" e.g. 68HA6630RHECSV21

Modesty panels are available in low pressure laminate, please replace V21 with V26 for this option or in palette, please replace V21 with V22 for this option.

Single stage height adjustable range: 26" - 45.5"

Dual stage height adjustable range: 21" - 47"

Power cord is 10 feet long.

ORDERING PROCEDURE

To order, please specify the following:

- 1) Krug product model number
- 2) Wood species and finish, see page 4
- 3) Wood edge detail, see page 3
- 4) Pull style, see page 3
- 5) Grommet location if applicable

CODE DESCRIPTION

HA - height adjustable
 RH - return (cross grain)
 E - electric
 T - T- base
 C - C- base
 S - single stage
 D - dual stage
 G - base enclosure
 V21 - 1/2 height floating wood modesty panel

STANDARD FINISHES

For a complete list of standard wood finishes please see page 4. Standard Laminate work surfaces are available at a 10% upcharge.

GROMMETS

One grommet in standard position is optional at no charge. Additional grommets are available at an upcharge of **\$152 List**.

MILLENNIUM RETURNS

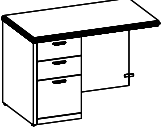
Description	Model	Cherry Maple Walnut	W	D	H	KW	Shipping	Cubic
							Weight	Feet
 Return, Desk Height with Full Height Pedestal	68RH3620L4D	3698	36	20.25	28.5	19.5	101	15
	68RH3620L4F	3698	36	20.25	28.5	19.5	101	15
	68RH3620R4D	3698	36	20.25	28.5	19.5	101	15
	68RH3620R4F	3698	36	20.25	28.5	19.5	101	15
	68RH3624L4D	3732	36	24.25	28.5	19.5	115	18
	68RH3624L4F	3732	36	24.25	28.5	19.5	115	18
	68RH3624R4D	3732	36	24.25	28.5	19.5	115	18
	68RH3624R4F	3732	36	24.25	28.5	19.5	115	18
	68RH3630L4D	3762	36	30.25	28.5	19.5	136	21
	68RH3630L4F	3762	36	30.25	28.5	19.5	136	21
	68RH3630R4D	3762	36	30.25	28.5	19.5	136	21
	68RH3630R4F	3762	36	30.25	28.5	19.5	136	21
	68RH4220L4D	3761	42	20.25	28.5	25.5	113	17
	68RH4220L4F	3761	42	20.25	28.5	25.5	113	17
	68RH4220R4D	3761	42	20.25	28.5	25.5	113	17
	68RH4220R4F	3761	42	20.25	28.5	25.5	113	17
	68RH4224L4D	3819	42	24.25	28.5	25.5	129	20
	68RH4224L4F*	3819	42	24.25	28.5	25.5	129	20
	68RH4224R4D	3819	42	24.25	28.5	25.5	129	20
	68RH4224R4F	3819	42	24.25	28.5	25.5	129	20
	68RH4230L4D	3840	42	30.25	28.5	25.5	154	25
	68RH4230L4F	3840	42	30.25	28.5	25.5	154	25
	68RH4230R4D	3840	42	30.25	28.5	25.5	154	25
	68RH4230R4F	3840	42	30.25	28.5	25.5	154	25
	68RH4820L4D	3866	48	20.25	28.5	31.5	125	20
	68RH4820L4F	3866	48	20.25	28.5	31.5	125	20
	68RH4820R4D	3866	48	20.25	28.5	31.5	125	20
	68RH4820R4F	3866	48	20.25	28.5	31.5	125	20
	68RH4824L4D	3867	48	24.25	28.5	31.5	144	23
	68RH4824L4F	3867	48	24.25	28.5	31.5	144	23
	68RH4824R4D	3867	48	24.25	28.5	31.5	144	23
	68RH4824R4F	3867	48	24.25	28.5	31.5	144	23
	68RH4830L4D	3888	48	30.25	28.5	31.5	172	29
	68RH4830L4F	3888	48	30.25	28.5	31.5	172	29
	68RH4830R4D	3888	48	30.25	28.5	31.5	172	29
	68RH4830R4F	3888	48	30.25	28.5	31.5	172	29
	68RH5420L4D	3898	54	20.25	28.5	37.5	137	22
	68RH5420L4F	3898	54	20.25	28.5	37.5	137	22
	68RH5420R4D	3898	54	20.25	28.5	37.5	137	22
	68RH5420R4F	3898	54	20.25	28.5	37.5	137	22
68RH5424L4D	3931	54	24.25	28.5	37.5	158	15	
68RH5424L4F	3931	54	24.25	28.5	37.5	158	15	
68RH5424R4D	3931	54	24.25	28.5	37.5	158	15	
68RH5424R4F	3931	54	24.25	28.5	37.5	158	15	
68RH5430L4D	3985	54	30.25	28.5	37.5	190	18	
68RH5430L4F	3985	54	30.25	28.5	37.5	190	18	
68RH5430R4D	3985	54	30.25	28.5	37.5	190	18	
68RH5430R4F	3985	54	30.25	28.5	37.5	190	18	

ORDERING NOTES:

Please see page 7 for wire management cut-out option and for hinged modesty panel option. For reverse grain direction on returns use list price and note **Reverse Grain** on p.o.

DIMENSION KEY

W - width
D - depth
H - height

*Indicates model illustrated by line drawing.

CODE DESCRIPTION

4 - full height pedestal
L - left handed pedestal position
R - right handed pedestal position
D - 2 file drawer
F - 2 box, 1 file drawer

STANDARD FINISHES

For a complete list of standard wood finishes please see page 4. Standard Laminate work-surfaces are available at a 10% upcharge.

GROMMETS

One grommet in standard position is optional at no charge. Additional grommets are available at an upcharge of **\$152 List**.

MILLENNIUM RETURNS

Description	Model	Cherry		W	D	H	KW	Shipping Weight	Cubic Feet
		Maple	Walnut						
Return, Desk Height with Full Height Pedestal -Continued	68RH6020L4D		4044	60	20.25	28.5	43.5	147	17
	68RH6020L4F		4044	60	20.25	28.5	43.5	147	17
	68RH6020R4D		4044	60	20.25	28.5	43.5	147	17
	68RH6020R4F		4044	60	20.25	28.5	43.5	147	17
	68RH6024L4D		4107	60	24.25	28.5	43.5	170	20
	68RH6024L4F		4107	60	24.25	28.5	43.5	170	20
	68RH6024R4D		4107	60	24.25	28.5	43.5	170	20
	68RH6024R4F		4107	60	24.25	28.5	43.5	170	20
	68RH6030L4D		4217	60	30.25	28.5	43.5	205	20
	68RH6030L4F*		4217	60	30.25	28.5	43.5	205	20
	68RH6030R4D		4217	60	30.25	28.5	43.5	205	20
	68RH6030R4F		4217	60	30.25	28.5	43.5	205	20
	68RH6620L4D		4306	65.75	20.25	28.5	49.25	159	23
	68RH6620L4F		4306	65.75	20.25	28.5	49.25	159	23
	68RH6620R4D		4306	65.75	20.25	28.5	49.25	159	23
	68RH6620R4F		4306	65.75	20.25	28.5	49.25	159	23
	68RH6624L4D		4365	65.75	24.25	28.5	49.25	184	22
	68RH6624L4F		4365	65.75	24.25	28.5	49.25	184	22
	68RH6624R4D		4365	65.75	24.25	28.5	49.25	184	22
	68RH6624R4F		4365	65.75	24.25	28.5	49.25	184	22
	68RH6630L4D		4416	65.75	30.25	28.5	49.25	223	26
	68RH6630L4F		4416	65.75	30.25	28.5	49.25	223	26
	68RH6630R4D		4416	65.75	30.25	28.5	49.25	223	26
	68RH6630R4F		4416	65.75	30.25	28.5	49.25	223	26
	68RH7124L4D		4498	71	24.25	28.5	54.5	227	34
	68RH7124L4F		4498	71	24.25	28.5	54.5	227	34
	68RH7124R4D		4498	71	24.25	28.5	54.5	227	34
	68RH7124R4F		4498	71	24.25	28.5	54.5	227	34
	68RH7130L4D		4534	71	30.25	28.5	54.5	268	42
	68RH7130L4F		4534	71	30.25	28.5	54.5	268	42
	68RH7130R4D		4534	71	30.25	28.5	54.5	268	42
	68RH7130R4F		4534	71	30.25	28.5	54.5	268	42
68RH8424L4D		4611	83.75	24.25	28.5	67.5	227	34	
68RH8424L4F		4611	83.75	24.25	28.5	67.5	227	34	
68RH8424R4D		4611	83.75	24.25	28.5	67.5	227	34	
68RH8424R4F		4611	83.75	24.25	28.5	67.5	227	34	
68RH8430L4D		4655	83.75	30.25	28.5	67.5	260	50	
68RH8430L4F		4655	83.75	30.25	28.5	67.5	260	50	
68RH8430R4D		4655	83.75	30.25	28.5	67.5	260	50	
68RH8430R4F		4655	83.75	30.25	28.5	67.5	260	50	
Return, Desk Height & Depth with Full Height Pedestal	68RD6636L4D		4678	65.75	36.25	28.5	48.75	255	42
	68RD6636L4F*		4678	65.75	36.25	28.5	48.75	255	42
	68RD6636R4D		4678	65.75	36.25	28.5	48.75	255	42
	68RD6636R4F		4678	65.75	36.25	28.5	48.75	255	42
	68RD7136L4D		4778	71	36.25	28.5	54.5	252	50
	68RD7136L4F		4778	71	36.25	28.5	54.5	252	50
	68RD7136R4D		4778	71	36.25	28.5	54.5	252	50
	68RD7136R4F		4778	71	36.25	28.5	54.5	252	50
	68RD8436L4D		4970	83.75	36.25	28.5	67.5	270	60
	68RD8436L4F		4970	83.75	36.25	28.5	67.5	270	60
	68RD8436R4D		4970	83.75	36.25	28.5	67.5	270	60
	68RD8436R4F		4970	83.75	36.25	28.5	67.5	270	60

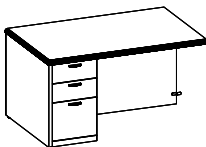
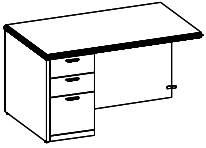

ORDERING NOTES: Please see page 7 for wire management cut-out option and for hinged modesty panel option. For reverse grain direction on returns use list price and note **Reverse Grain** on p.o.

ORDERING PROCEDURE	CODE DESCRIPTION	STANDARD FINISHES
To order, please specify the following: 1) Krug product model number 2) Wood species and finish, see page 4 3) Wood edge detail, see page 3 4) Pull style, see page 3 5) Grommet location if applicable	4 - full height pedestal L - left handed pedestal position R - right handed pedestal position D - 2 file drawer F - 2 box, 1 file drawer	For a complete list of standard wood finishes please see page 4. Standard Laminate work-surfaces are available at a 10% upcharge. GROMMETS One grommet in standard position is optional at no charge. Additional grommets are available at an upcharge of \$152 List .

*Indicates model illustrated by line drawing.

MILLENNIUM RETURNS

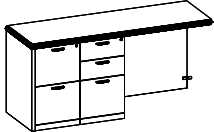
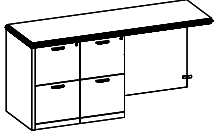
Description	Model	Cherry Maple Walnut	W	D	H	KW	Shipping	Cubic
							Weight	Feet
Return, Full Height	68RH6020L4DD**	5187	60	20.25	28.5	28.5	179	25
Ganged Pedestals	68RH6020L4DF*	5187	60	20.25	28.5	28.5	179	25
	68RH6020L4FD	5187	60	20.25	28.5	28.5	179	25
	68RH6020L4FF	5187	60	20.25	28.5	28.5	179	25
	68RH6020R4DD	5187	60	20.25	28.5	28.5	179	25
	68RH6020R4DF	5187	60	20.25	28.5	28.5	179	25
	68RH6020R4FD	5187	60	20.25	28.5	28.5	179	25
	68RH6020R4FF	5187	60	20.25	28.5	28.5	179	25
	68RH6024L4DD	5219	60	24.25	28.5	28.5	202	29
	68RH6024L4DF	5219	60	24.25	28.5	28.5	202	29
	68RH6024L4FD	5219	60	24.25	28.5	28.5	202	29
	68RH6024L4FF	5219	60	24.25	28.5	28.5	202	29
	68RH6024R4DD	5219	60	24.25	28.5	28.5	202	29
	68RH6024R4DF	5219	60	24.25	28.5	28.5	202	29
	68RH6024R4FD	5219	60	24.25	28.5	28.5	202	29
	68RH6024R4FF	5219	60	24.25	28.5	28.5	202	29
	68RH6030L4DD	5240	60	30.25	28.5	28.5	237	36
	68RH6030L4DF	5240	60	30.25	28.5	28.5	237	36
	68RH6030L4FD	5240	60	30.25	28.5	28.5	237	36
	68RH6030L4FF	5240	60	30.25	28.5	28.5	237	36
	68RH6030R4DD	5240	60	30.25	28.5	28.5	237	36
	68RH6030R4DF	5240	60	30.25	28.5	28.5	237	36
	68RH6030R4FD	5240	60	30.25	28.5	28.5	237	36
	68RH6030R4FF	5240	60	30.25	28.5	28.5	237	36
	68RH6620L4DD	5260	65.75	20.25	28.5	34.25	191	27
	68RH6620L4DF	5260	65.75	20.25	28.5	34.25	191	27
	68RH6620L4FD*	5260	65.75	20.25	28.5	34.25	191	27
	68RH6620L4FF	5260	65.75	20.25	28.5	34.25	191	27
	68RH6620R4DD	5260	65.75	20.25	28.5	34.25	191	27
	68RH6620R4DF	5260	65.75	20.25	28.5	34.25	191	27
	68RH6620R4FD	5260	65.75	20.25	28.5	34.25	191	27
	68RH6620R4FF	5260	65.75	20.25	28.5	34.25	191	27
	68RH6624L4DD	5300	65.75	24.25	28.5	34.25	216	32
	68RH6624L4DF	5300	65.75	24.25	28.5	34.25	216	32
	68RH6624L4FD	5300	65.75	24.25	28.5	34.25	216	32
	68RH6624L4FF	5300	65.75	24.25	28.5	34.25	216	32
	68RH6624R4DD	5300	65.75	24.25	28.5	34.25	216	32
	68RH6624R4DF	5300	65.75	24.25	28.5	34.25	216	32
	68RH6624R4FD	5300	65.75	24.25	28.5	34.25	216	32
	68RH6624R4FF	5300	65.75	24.25	28.5	34.25	216	32
	68RH6630L4DD	5319	65.75	30.25	28.5	34.25	255	39
	68RH6630L4DF	5319	65.75	30.25	28.5	34.25	255	39
	68RH6630L4FD	5319	65.75	30.25	28.5	34.25	255	39
	68RH6630L4FF	5319	65.75	30.25	28.5	34.25	255	39
	68RH6630R4DD	5319	65.75	30.25	28.5	34.25	255	39
	68RH6630R4DF	5319	65.75	30.25	28.5	34.25	255	39
	68RH6630R4FD	5319	65.75	30.25	28.5	34.25	255	39
	68RH6630R4FF	5319	65.75	30.25	28.5	34.25	255	39
	68RH7124L4DD	5365	71	24.25	28.5	39.5	227	34
	68RH7124L4DF	5365	71	24.25	28.5	39.5	227	34

ORDERING NOTES: Please see page 7 for wire management cut-out option and for hinged modesty panel option. For reverse grain direction on returns use list price and note **Reverse Grain** on p.o.

DIMENSION KEY

W - width
D - depth
H - height

*Indicates model illustrated by line drawing.

CODE DESCRIPTION

4 - full height pedestal
L - left handed pedestal position
R - right handed pedestal position
D - 2 file drawer
F - 2 box, 1 file drawer

STANDARD FINISHES

For a complete list of standard wood finishes please see page 4. Standard Laminate work-surfaces are available at a 10% upcharge.

GROMMETS

One grommet in standard position is optional at no charge. Additional grommets are available at an upcharge of **\$152 List**.

MILLENNIUM RETURNS

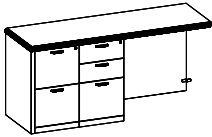
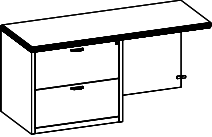
Description	Model	Cherry	W	D	H	KW	Shipping Weight	Cubic Feet
		Maple Walnut						
Return, Full Height Ganged Pedestals, continued 	68RH7124L4FD	5365	71	24.25	28.5	39.5	227	34
	68RH7124L4FF	5365	71	24.25	28.5	39.5	227	34
	68RH7124R4DD	5365	71	24.25	28.5	39.5	227	34
	68RH7124R4DF*	5365	71	24.25	28.5	39.5	227	34
	68RH7124R4FD	5365	71	24.25	28.5	39.5	227	34
	68RH7124R4FF	5365	71	24.25	28.5	39.5	227	34
	68RH7130L4DD	5430	71	30.25	28.5	39.5	268	42
	68RH7130L4DF	5430	71	30.25	28.5	39.5	268	42
	68RH7130L4FD	5430	71	30.25	28.5	39.5	268	42
	68RH7130L4FF	5430	71	30.25	28.5	39.5	268	42
	68RH7130R4DD	5430	71	30.25	28.5	39.5	268	42
	68RH7130R4DF	5430	71	30.25	28.5	39.5	268	42
	68RH7130R4FD	5430	71	30.25	28.5	39.5	268	42
	68RH7130R4FF	5430	71	30.25	28.5	39.5	268	42
	68RH8424L4DD	5525	83.75	24.25	28.5	52.5	260	40
	68RH8424L4DF	5525	83.75	24.25	28.5	52.5	260	40
	68RH8424L4FD	5525	83.75	24.25	28.5	52.5	260	40
	68RH8424L4FF	5525	83.75	24.25	28.5	52.5	260	40
	68RH8424R4DD	5525	83.75	24.25	28.5	52.5	260	40
	68RH8424R4DF	5525	83.75	24.25	28.5	52.5	260	40
	68RH8424R4FD	5525	83.75	24.25	28.5	52.5	260	40
	68RH8424R4FF	5525	83.75	24.25	28.5	52.5	260	40
	68RH8430L4DD	5574	83.75	30.25	28.5	52.5	309	50
	68RH8430L4DF	5574	83.75	30.25	28.5	52.5	309	50
	68RH8430L4FD	5574	83.75	30.25	28.5	52.5	309	50
	68RH8430L4FF	5574	83.75	30.25	28.5	52.5	309	50
	68RH8430R4DD	5574	83.75	30.25	28.5	52.5	309	50
	68RH8430R4DF	5574	83.75	30.25	28.5	52.5	309	50
	68RH8430R4FD	5574	83.75	30.25	28.5	52.5	309	50
	68RH8430R4FF	5574	83.75	30.25	28.5	52.5	309	50
Return, Lateral File Pedestal 	68RH6024LLF*	4966	60	24.25	28.5	24	218	29
	68RH6024RLF	4966	60	24.25	28.5	24	218	29
	68RH7124LLF	5010	71	24.25	28.5	35	243	34
	68RH7124RLF	5010	71	24.25	28.5	35	243	34
	68RH8424LLF	5075	84	24.25	28.5	48	279	36
	68RH8424RLF	5075	84	24.25	28.5	48	279	36

ORDERING NOTES: Please see page 7 for wire management cut-out option and for hinged modesty panel option. For reverse grain direction on returns use list price and note **Reverse Grain** on p.o.

ORDERING PROCEDURE

- To order, please specify the following:
- 1) Krug product model number
 - 2) Wood species and finish, see page 4
 - 3) Wood edge detail, see page 3
 - 4) Pull style, see page 3
 - 5) Grommet location if applicable

*Indicates model illustrated by line drawing.

CODE DESCRIPTION

- 4 - full height pedestal
- L - left handed pedestal position
- R - right handed pedestal position
- D - 2 file drawer
- F - 2 box, 1 file drawer
- LF - lateral file

STANDARD FINISHES

For a complete list of standard wood finishes please see page 4. Standard Laminate work-surfaces are available at a 10% upcharge.

GROMMETS

One grommet in standard position is optional at no charge. Additional grommets are available at an upcharge of **\$152 List**.

MILLENNIUM RETURNS

Description	Model	Cherry Maple Walnut	W	D	H	KW	Shipping Weight	Cubic Feet
	68BR6030*	2114	60	30.25	28.5	131	4	
	68BR6630	2155	65.75	30.25	28.5	149	4	
	68BR6636	2168	65.75	36.25	28.5	189	5	
	68BR7130	2217	71	30.25	28.5	164	4	
	68BR7136	2291	71	36.25	28.5	207	4	

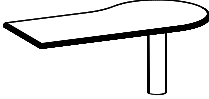
	68PRL7130	3030	71	30	28.5	48.6	184	50
	68PRR7130*	3030	71	30	28.5	48.6	184	50
	68PRL7136	3175	71	36	28.5	48.6	227	58
	68PRR7136	3175	71	36	28.5	48.6	227	58
	68PRL8430	3472	84	30	28.5	65.25	207	59
	68PRR8430	3472	84	30	28.5	65.25	207	59
	68PRL8436	3587	84	36	28.5	62.5	254	68
	68PRR8436	3587	84	36	28.5	62.5	254	68

ORDERING NOTES: Please see page 6 for brushed aluminum tapered post leg option.

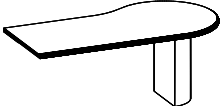
	68PRL7130DB	3389	71	30	28.5	48.6	184	50
	68PRR7130DB*	3389	71	30	28.5	48.6	184	50
	68PRL7136DB	3538	71	36	28.5	48.6	227	58
	68PRR7136DB	3538	71	36	28.5	48.6	227	58
	68PRL8430DB	3839	84	30	28.5	65.25	207	59
	68PRR8430DB	3839	84	30	28.5	65.25	207	59
	68PRL8436DB	3950	84	36	28.5	62.5	254	68
	68PRR8436DB	3950	84	36	28.5	62.5	254	68
	68PRL9630DB	4119	96	30	28.5	70.75	241	74
	68PRR9630DB	4119	96	30	28.5	70.75	241	74
	68PRL9636DB	4469	96	36	28.5	68	295	77
	68PRR9636DB	4469	96	36	28.5	68	295	77

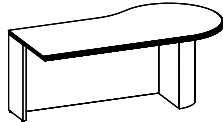
	68PRL7130DBM	4545	71	30	28.5	48.6	204	50
	68PRR7130DBM	4545	71	30	28.5	48.6	204	50
	68PRL7136DBM	4579	71	36	28.5	48.6	247	58
	68PRR7136DBM	4579	71	36	28.5	48.6	247	58
	68PRL8430DBM	4914	84	30	28.5	65.25	232	59
	68PRR8430DBM	4914	84	30	28.5	65.25	232	59
	68PRL8436DBM	4656	84	36	28.5	62.5	274	68
	68PRR8436DBM	4656	84	36	28.5	62.5	274	68
	68PRL9630DBM	4962	96	30	28.5	70.75	261	74
	68PRR9630DBM	4962	96	30	28.5	70.75	261	74
	68PRL9636DBM	5338	96	36	28.5	68	310	77
	68PRR9636DBM"	5338	96	36	28.5	68	310	77

ORDERING NOTES: Please see page 7 for wire management cut-out option and for hinged modesty panel option. For reverse grain direction on returns use list price and note **Reverse Grain** on p.o.

DIMENSION KEY

W - width
D - depth
H - height

*Indicates model illustrated by line drawing.

CODE DESCRIPTION

4 - full height pedestal
DB - Half Drum Base
DBM - Half Drum Base & Full Modesty Panel

STANDARD FINISHES

For a complete list of standard wood finishes please see page 4. Standard Laminate work-surfaces are available at a 10% upcharge.

GROMMETS

One grommet in standard position is optional at no charge. Additional grommets are available at an upcharge of **\$152 List**.

MILLENNIUM RETURN S

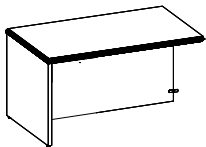
Description	Model	Cherry	W	D	H	KW	Shipping Weight	Cubic Feet
		Maple Walnut						
	Open Return, Desk Height	1914	23.75	20.25	28.5	22	46	13
		1914	23.75	20.25	28.5	22	46	13
		1953	23.75	24.25	28.5	22	55	15
		1953	23.75	24.25	28.5	22	55	15
		2017	30	20.25	28.5	28.13	58	15
		2017	30	20.25	28.5	28.13	58	15
		2053	30	24.25	28.5	28.13	70	17
		2053	30	24.25	28.5	28.13	70	17
		2122	36	20.25	28.5	34.13	69	17
		2122	36	20.25	28.5	34.13	69	17
		2157	36	24.25	28.5	34.13	83	20
		2157	36	24.25	28.5	34.13	83	20
		2184	36	30.25	28.5	34.13	104	22
		2184	36	30.25	28.5	34.13	104	22
		2219	42	20.25	28.5	40.13	81	20
		2219	42	20.25	28.5	40.13	81	20
		2274	42	24.25	28.5	40.13	97	22
		2274	42	24.25	28.5	40.13	97	22
		2302	42	30.25	28.5	40.13	122	24
		2302	42	30.25	28.5	40.13	122	24
		2326	48	20.25	28.5	46.13	93	22
		2326	48	20.25	28.5	46.13	93	22
		2383	48	24.25	28.5	46.13	112	24
		2383	48	24.25	28.5	46.13	112	24
		2390	48	30.25	28.5	46.13	140	26
		2390	48	30.25	28.5	46.13	140	26
		2420	54	20.25	28.5	52.13	105	24
		2420	54	20.25	28.5	52.13	105	24
		2457	54	24.25	28.5	52.13	126	26
		2457	54	24.25	28.5	52.13	126	26
		2459	54	30.25	28.5	52.13	158	30
		2459	54	30.25	28.5	52.13	158	30
		2473	60	20.25	28.5	58.38	115	26
		2473	60	20.25	28.5	58.38	115	26
		2526	60	24.25	28.5	58.38	138	30
		2526	60	24.25	28.5	58.38	138	30
		2559	60	30.25	28.5	58.38	173	33
		2559	60	30.25	28.5	58.38	173	33
		2576	65.75	20.25	28.5	63.88	126	30
		2576	65.75	20.25	28.5	63.88	126	30
	2631	65.75	24.25	28.5	63.88	152	33	
	2631	65.75	24.25	28.5	63.88	152	33	
	2657	65.75	30.25	28.5	63.88	191	36	
	2657	65.75	30.25	28.5	63.88	191	36	
	2686	71	20.25	28.5	69.13	136	33	
	2686	71	20.25	28.5	69.13	136	33	
	2726	71	24.25	28.5	69.13	163	36	
	2726	71	24.25	28.5	69.13	163	36	
	2745	71	30.25	28.5	69.13	204	38	
	2745	71	30.25	28.5	69.13	204	38	

ORDERING NOTES: Please see page 7 for wire management cut-out option and for hinged modesty panel option. For Universal Return Shells replace RH with RHU. Grommets are not available on Universal Return shells.

ORDERING PROCEDURE

- To order, please specify the following:
- 1) Krug product model number
 - 2) Wood species and finish, see page 4
 - 3) Wood edge detail, see page 3
 - 4) Pull style, see page 3
 - 5) Grommet location if applicable

*Indicates model illustrated by line drawing.

CODE DESCRIPTION

- L - left handed pedestal position
R - right handed pedestal position

STANDARD FINISHES

For a complete list of standard wood finishes please see page 4. Standard Laminate work-surfaces are available at a 10% upcharge.

GROMMETS

One grommet in standard position is optional at no charge. Additional grommets are available at an upcharge of **\$152 List**.

MILLENNIUM RETURNS

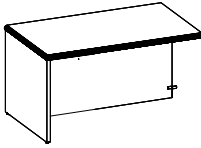
Description	Model	Cherry Maple Walnut	W	D	H	KW	Shipping	
							Weight	Cubic Feet
Open Return, Desk Height -continued 	68RH8420L	2776	84	20.25	28.5	82.13	163	36
	68RH8420R	2776	84	20.25	28.5	82.13	163	36
	68RH8424L	2805	84	24.25	28.5	82.13	196	38
	68RH8424R	2805	84	24.25	28.5	82.13	196	38
	68RH8430L	2837	84	30.25	28.5	82.13	245	45
	68RH8430R	2837	84	30.25	28.5	82.13	245	45
	68RH9024L	2844	90	24.25	28.5	88.13	210	45
	68RH9024R	2844	90	24.25	28.5	88.13	210	45
	68RH9030L	2893	90	30.25	28.5	88.13	247	49
	68RH9030R	2893	90	30.25	28.5	88.13	247	49
	68RH9624L	2947	96	24.25	28.5	93.88	221	49
	68RH9624R	2947	96	24.25	28.5	93.88	221	49
	68RH9630L	2999	96	30.25	28.5	93.88	249	52
	68RH9630R	2999	96	30.25	28.5	93.88	249	52
	68RH10220L	3095	102	20.25	28.5	100.25	195	49
	68RH10220R	3095	102	20.25	28.5	100.25	195	49

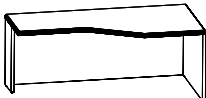
Corner Return Shell 	Model		W	D	H	KW	Shipping	Cubic
	68CR7124L*	3211	71	24.25	28.5	190	55	
	68CR7124R	3211	71	24.25	28.5	190	55	
	68CR8424L	3263	84	24.25	28.5	210	59	
	68CR8424R	3263	84	24.25	28.5	210	59	

ORDERING NOTES: Corner Returns are designated left or right by the location of it's connection to a primary work surface. For a curved corner version of this products, please add 5% to above list price and add an extra C to the model number prefix i.e. 68CCC7124L

Half Gable 	Model		W	D	H	KW	Shipping	Cubic
	68HG2710	443	10	27	27	11	1	
	68HG2716	507	16	27	27	16	1	

ORDERING NOTES: This unit should be ordered to center-support open spans greater than 60". Use 68HG2710 with 20" & 24" deep cases and 68HG2716 with 30" deep cases.

DIMENSION KEY

W - width
D - depth
H - height

*Indicates model illustrated by line drawing.

CODE DESCRIPTION

L - left hand runoff
R - right hand runoff

STANDARD FINISHES

For a complete list of standard wood finishes please see page 4. Standard Laminate work-surfaces are available at a 10% upcharge.

GROMMETS

One grommet in standard position is optional at no charge. Additional grommets are available at an upcharge of **\$152 List**.

MILLENNIUM LINKING TOPS

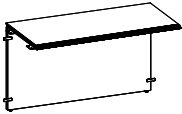
Description	Model	Cherry Maple Walnut	W	D	H	Shipping Weight	Cubic Feet
	68LU3024H	1697	29.5	24.25	28.5	57	6
	68LU3620H	1776	35.5	20.25	28.5	54	6
	68LU3624H	1834	35.5	24.25	28.5	68	7
	68LU4220H	1857	41.5	20.25	28.5	66	7
	68LU4224H	1920	41.5	24.25	28.5	82	8
	68LU4820H	1959	47.5	20.25	28.5	78	8
	68LU4824H	1993	47.5	24.25	28.5	97	9
	68LU5420H	2019	53.5	20.25	28.5	90	9
	68LU5424H	2045	53.5	24.25	28.5	111	10
	68LU6020H	2063	59.5	20.25	28.5	100	10
	68LU6024H	2096	59.5	24.25	28.5	123	11
	68LU6624H	2229	65.5	24.25	28.5	137	12
	68LU7124H	2378	70.5	24.25	28.5	148	13

ORDERING NOTES: Please see page 7 for wire management cut-out option and for hinged modesty panel option. For reverse grain direction on returns use list price and note **Reverse Grain** on p.o.

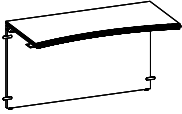
	68LUC3624H	2158	35.5	24.25	28.5	68	7
	68LUC4224H	2197	41.5	24.25	28.5	82	8
	68LUC4824H	2321	47.5	24.25	28.5	97	9

ORDERING NOTES: Please see page 7 for wire management cut-out option and for hinged modesty panel option. For reverse grain direction on returns use list price and note **Reverse Grain** on p.o.

	68LT3620H	883	35.5	20.25	28.5	34	6
	68LT3624H	888	35.5	24.25	28.5	48	6
	68LT4220H	915	41.5	20.25	28.5	46	7
	68LT4224H	943	41.5	24.25	28.5	62	8
	68LT4820H	968	47.5	20.25	28.5	58	8
	68LT4824H	984	47.5	24.25	28.5	77	9
	68LT5420H	997	53.5	20.25	28.5	70	9
	68LT5424H	1006	53.5	24.25	28.5	91	10
	68LT6020H	1018	59.5	20.25	28.5	80	10
	68LT6024H	1053	59.5	24.25	28.5	93	11
	68LT6620H	1066	65.5	20.25	28.5	82	11
	68LT6624H	1084	65.5	24.25	28.5	107	12
	68LT7124H	1107	70.5	24.25	28.5	118	13

ORDERING NOTES: For reverse grain direction on returns use list price and note **Reverse Grain** on p.o.

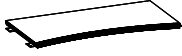
	68LTC3624H	1019	35.5	24.25	28.5	48	6
	68LTC4224H	1073	41.5	24.25	28.5	62	8
	68LTC4824H	1136	47.5	24.25	28.5	77	9

ORDERING NOTES: Linking unit is 21.25" deep at the center of the curve. For reverse grain direction on returns use list price and note **Reverse Grain** on p.o.

ORDERING PROCEDURE

To order, please specify the following:
 1) Krug product model number
 2) Wood species and finish, see page 4
 3) Wood edge detail, see page 3
 4) Pull style, see page 3
 5) Grommet location if applicable

CODE DESCRIPTION

H - desk height

STANDARD FINISHES

For a complete list of standard wood finishes please see page 4. Standard Laminate work-surfaces are available at a 10% upcharge.

MILLENNIUM CORNER UNITS

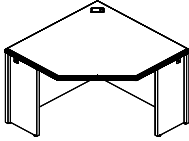
Description	Model	Cherry Maple Walnut	W	D	H	KW	Shipping Weight	Cubic Feet
	68CU363620	3476	36.25	36.25	28.5	22.5	132	26
	68CU363624	3476	36.25	36.25	28.5	17	132	26
	68CU424224*	3818	42.25	42.25	28.5	25.5	164	35
	68CU4242L24R30	3876	42.25	42.25	28.5	21.5	164	35
	68CU4242L30R24	3876	42.25	42.25	28.5	21.5	164	35

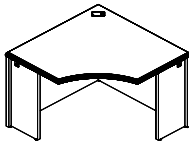
	68CUC363620	3642	36.25	36.25	28.5	22.5	132	26
	68CUC363624	3642	36.25	36.25	28.5	17	132	26
	68CUC424224*	4011	42.25	42.25	28.5	25.5	164	35
	68CUC4242L24R30	4114	42.25	42.25	28.5	21.5	132	35
	68CUC4242L30R24	4114	42.25	42.25	28.5	21.5	132	35

ORDERING NOTES: Includes a standard grommet in the "C" position. When ordering a keyboard for use with a corner unit, please specify a 68KBAC2110 with an extended mechanism.

DIMENSION KEY

W - width
D - depth
H - height

*Indicates model illustrated by line drawing.

CODE DESCRIPTION

L - left hand dimension
R - right hand dimension

STANDARD FINISHES

For a complete list of standard wood finishes please see page 4. Standard Laminate work-surfaces are available at a 10% upcharge.

GROMMETS

One grommet in standard position is optional at no charge. Additional grommets are available at an upcharge of **\$152 List**.

MILLENNIUM CREDENZAS

Description	Model	Cherry Maple Walnut	W	D	H	KW	Shipping Weight	Cubic Feet
Single Pedestal Credenza with Full Height Pedestals	68C60204LDR0	4841	60	20.25	28.5	42	154	24
	68C60204LFR0	4841	60	20.25	28.5	42	154	24
	68C60204LDR0	4841	60	20.25	28.5	42	154	24
	68C60204LORF	4841	60	20.25	28.5	42	154	24
	68C60244LDR0	4877	60	24.25	28.5	42	178	29
	68C60244LFR0	4877	60	24.25	28.5	42	178	29
	68C60244LDR0	4877	60	24.25	28.5	42	178	29
	68C60244LORF	4877	60	24.25	28.5	42	178	29
	68C66204LDR0	4911	65.75	20.25	28.5	48	165	27
	68C66204LFR0	4911	65.75	20.25	28.5	48	165	27
	68C66204LDR0	4911	65.75	20.25	28.5	48	165	27
	68C66204LORF	4911	65.75	20.25	28.5	48	165	27
	68C66244LDR0	4923	65.75	24.25	28.5	48	192	32
	68C66244LFR0	4923	65.75	24.25	28.5	48	192	32
	68C66244LDR0	4923	65.75	24.25	28.5	48	192	32
	68C66244LORF	4923	65.75	24.25	28.5	48	192	32
	68C71204LDR0*	4949	71	20.25	28.5	53.25	175	29
	68C71204LFR0	4949	71	20.25	28.5	53.25	175	29
	68C71204LDR0	4949	71	20.25	28.5	53.25	175	29
	68C71204LORF	4949	71	20.25	28.5	53.25	175	29
	68C71244LDR0	4998	71	24.25	28.5	53.25	204	34
	68C71244LFR0	4998	71	24.25	28.5	53.25	204	34
	68C71244LDR0	4998	71	24.25	28.5	53.25	204	34
	68C71244LORF	4998	71	24.25	28.5	53.25	204	34
	68C78204LDR0	5040	78	20.25	28.5	60.5	193	26
	68C78204LFR0	5040	78	20.25	28.5	60.5	193	26
	68C78204LDR0	5040	78	20.25	28.5	60.5	193	26
	68C78204LORF	5040	78	20.25	28.5	60.5	193	26
	68C78244LDR0	5083	78	24.25	28.5	60.5	224	32
	68C78244LFR0	5083	78	24.25	28.5	60.5	224	32
	68C78244LDR0	5083	78	24.25	28.5	60.5	224	32
	68C78244LORF	5083	78	24.25	28.5	60.5	224	32
68C84204LDR0	5131	83.75	20.25	28.5	66.25	191	34	
68C84204LFR0	5131	83.75	20.25	28.5	66.25	191	34	
68C84204LDR0	5131	83.75	20.25	28.5	66.25	191	34	
68C84204LORF	5131	83.75	20.25	28.5	66.25	191	34	
68C84244LDR0	5157	83.75	24.25	28.5	66.25	222	38	
68C84244LFR0	5157	83.75	24.25	28.5	66.25	222	38	
68C84244LDR0	5157	83.75	24.25	28.5	66.25	222	38	
68C84244LORF	5157	83.75	24.25	28.5	66.25	222	38	

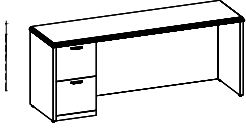

ORDERING NOTES: Please see page 7 for wire management cut-out and/or hinged modesty panel option.

ORDERING PROCEDURE

To order, please specify the following:

- 1) Krug product model number
- 2) Wood species and finish, see page 4
- 3) Wood edge detail, see page 3
- 4) Pull style, see page 3
- 5) Grommet location if applicable

*Indicates model illustrated by line drawing.

CODE DESCRIPTION

- 4 - full height pedestal
- L - left handed pedestal position
- R - right handed pedestal position
- D - 2 file drawers
- F - 2 box, 1 file drawer
- 0 - no pedestal

STANDARD FINISHES

For a complete list of standard wood finishes please see page 4. Standard Laminate work-surfaces are available at a 10% upcharge.

GROMMETS

One grommet in standard position is optional at no charge. Additional grommets are available at an upcharge of **\$152 List**.

MILLENNIUM CREDENZAS

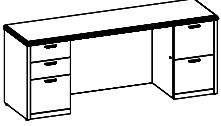
Description	Model	Cherry Maple Walnut	W	D	H	KW	Shipping	Cubic
							Weight	Feet
Double Pedestal Credenza with Full Height Pedestals 	68C60204LDRD	5229	60	20.25	28.5	27.25	186	24
	68C60204LDRF	5229	60	20.25	28.5	27.25	186	24
	68C60204LFRD	5229	60	20.25	28.5	27.25	186	24
	68C60204LFRF	5229	60	20.25	28.5	27.25	186	24
	68C60244LDRD	5243	60	24.25	28.5	27.25	210	29
	68C60244LDRF	5243	60	24.25	28.5	27.25	210	29
	68C60244LFRD	5243	60	24.25	28.5	27.25	210	29
	68C60244LFRF	5243	60	24.25	28.5	27.25	210	29
	68C66204LDRD	5284	65.75	20.25	28.5	33.25	197	27
	68C66204LDRF	5284	65.75	20.25	28.5	33.25	197	27
	68C66204LFRD	5284	65.75	20.25	28.5	33.25	197	27
	68C66204LFRF	5284	65.75	20.25	28.5	33.25	197	27
	68C66244LDRD	5289	65.75	24.25	28.5	33.25	210	32
	68C66244LDRF	5289	65.75	24.25	28.5	33.25	210	32
	68C66244LFRD	5289	65.75	24.25	28.5	33.25	210	32
	68C66244LFRF	5289	65.75	24.25	28.5	33.25	210	32
	68C71204LDRD	5316	71	20.25	28.5	38.5	207	29
	68C71204LDRF	5316	71	20.25	28.5	38.5	207	29
	68C71204LFRD*	5316	71	20.25	28.5	38.5	207	29
	68C71204LFRF	5316	71	20.25	28.5	38.5	207	29
	68C71244LDRD	5373	71	24.25	28.5	38.5	236	34
	68C71244LDRF	5373	71	24.25	28.5	38.5	236	34
	68C71244LFRD	5373	71	24.25	28.5	38.5	236	34
	68C71244LFRF	5373	71	24.25	28.5	38.5	236	34
	68C78204LDRD	5391	78	20.25	28.5	42.5	205	26
	68C78204LDRF	5391	78	20.25	28.5	42.5	205	26
	68C78204LFRD	5391	78	20.25	28.5	42.5	205	26
	68C78204LFRF	5391	78	20.25	28.5	42.5	205	26
	68C78244LDRD	5471	78	24.25	28.5	42.5	253	32
	68C78244LDRF	5471	78	24.25	28.5	42.5	253	32
	68C78244LFRD	5471	78	24.25	28.5	42.5	253	32
	68C78244LFRF	5471	78	24.25	28.5	42.5	253	32
	68C84204LDRD	5429	83.75	20.25	28.5	51.75	223	34
	68C84204LDRF	5429	83.75	20.25	28.5	51.75	223	34
	68C84204LFRD	5429	83.75	20.25	28.5	51.75	223	34
	68C84204LFRF	5429	83.75	20.25	28.5	51.75	223	34
	68C84244LFRD	5562	83.75	24.25	28.5	51.75	254	38
	68C84244LDRF	5562	83.75	24.25	28.5	51.75	254	38
	68C84244LDRD	5562	83.75	24.25	28.5	51.75	254	38
	68C84244LFRF	5562	83.75	24.25	28.5	51.75	254	38

ORDERING NOTES: The pencil drawer can not be used in 20" deep knee hole credenzas and/or shells. Please see page 7 for wire management cut-out option and for hinged modesty panel option.

DIMENSION KEY

W - width
D - depth
H - height

*Indicates model illustrated by line drawing.

CODE DESCRIPTION

4 - full height pedestal
L - left handed pedestal position
R - right handed pedestal position
D - 2 file drawer
F - 2 box, 1 file drawer

STANDARD FINISHES

For a complete list of standard wood finishes please see page 4. Standard Laminate work-surfaces are available at a 10% upcharge.

GROMMETS

One grommet in standard position is optional at no charge. Additional grommets are available at an upcharge of **\$152 List**.

MILLENNIUM CREDENZAS

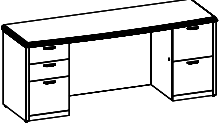
Description	Model	Cherry		W	D	H	KW	Shipping Weight	Cubic Feet
		Maple	Walnut						
	68CX71204LDRD	5688		71	20.5	28.5	38.5	217	29
	68CX71204LDRF	5688		71	20.5	28.5	38.5	217	29
	68CX71204LFRD	5688		71	20.5	28.5	38.5	217	29
	68CX71204LFRF	5688		71	20.5	28.5	38.5	217	29
	68CX71244LDRD	5812		71	24.5	28.5	38.5	246	24
	68CX71244LDRF	5812		71	24.5	28.5	38.5	246	24
	68CX71244LFRD	5812		71	24.5	28.5	38.5	246	24
	68CX71244LFRF	5812		71	24.5	28.5	38.5	246	24
	68CX78204LDRD	5840		78	20.5	28.5	42.5	224	26
	68CX78204LDRF	5840		78	20.5	28.5	42.5	224	26
	68CX78204LFRD*	5840		78	20.5	28.5	42.5	224	26
	68CX78204LFRF	5840		78	20.5	28.5	42.5	224	26
	68CX78244LDRD	5849		78	24.5	28.5	42.5	257	38
	68CX78244LDRF	5849		78	24.5	28.5	42.5	257	38
	68CX78244LFRD	5849		78	24.5	28.5	42.5	257	38
	68CX78244LFRF	5849		78	24.5	28.5	42.5	257	38
	68CX84204LDRD	5940		83.75	20.5	28.5	51.75	233	34
	68CX84204LDRF	5940		83.75	20.5	28.5	51.75	233	34
	68CX84204LFRD	5940		83.75	20.5	28.5	51.75	233	34
	68CX84204LFRF	5940		83.75	20.5	28.5	51.75	233	34
	68CX84244LDRD	5947		83.75	24.5	28.5	51.75	264	38
	68CX84244LDRF	5947		83.75	24.5	28.5	51.75	264	38
	68CX84244LFRD	5947		83.75	24.5	28.5	51.75	264	38
	68CX84244LFRF	5947		83.75	24.5	28.5	51.75	264	38

ORDERING NOTES: The pencil drawer can not be used in 20" deep knee hole credenzas and/or shells. Please see page 7 for wire management cut-out option and for hinged modesty panel option.

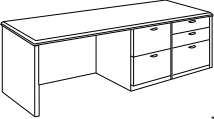
Credenza, Ganged Pedestals	Model	Cherry		W	D	H	KW	Shipping Weight	Cubic Feet
		Maple	Walnut						
	68C66204LDDR0	5771		65.75	20.25	28.5	33.25	197	27
	68C66204LDFR0	5771		65.75	20.25	28.5	33.25	197	27
	68C66204LFDR0	5771		65.75	20.25	28.5	33.25	197	27
	68C66204LFFR0**	5771		65.75	20.25	28.5	33.25	197	27
	68C66204LORDD	5771		65.75	20.25	28.5	33.25	197	27
	68C66204LORDF	5771		65.75	20.25	28.5	33.25	197	27
	68C66204LORFD*	5771		65.75	20.25	28.5	33.25	197	27
	68C66204LORFF	5771		65.75	20.25	28.5	33.25	197	27
	68C66244LDDR0	5807		65.75	24.5	28.5	33.25	224	32
	68C66244LDFR0	5807		65.75	24.5	28.5	33.25	224	32
	68C66244LFDR0	5807		65.75	24.5	28.5	33.25	224	32
	68C66244LFFR0	5807		65.75	24.5	28.5	33.25	224	32
	68C66244LORDD	5807		65.75	24.5	28.5	33.25	224	32
	68C66244LORDF	5807		65.75	24.5	28.5	33.25	224	32
	68C66244LORFD	5807		65.75	24.5	28.5	33.25	224	32
	68C66244LORFF	5807		65.75	24.5	28.5	33.25	224	32
68C71204LDDR0	5835		71	20.25	28.5	38.5	207	29	
68C71204LDFR0	5835		71	20.25	28.5	38.5	207	29	
68C71204LFDR0	5835		71	20.25	28.5	38.5	207	29	
68C71204LFFR0	5835		71	20.25	28.5	38.5	207	29	
68C71204LORD	5835		71	20.25	28.5	38.5	207	29	

ORDERING NOTES: "C" position grommets are not available on 60-71" Ganged Pedestal Credenzas. Ganged pedestals are specified in the product code beginning with the pedestal closest to the end panel.

ORDERING PROCEDURE

- To order, please specify the following:
- 1) Krug product model number
 - 2) Wood species and finish, see page 4
 - 3) Wood edge detail, see page 3
 - 4) Pull style, see page 3
 - 5) Grommet location if applicable

*Indicates model illustrated by line drawing.

CODE DESCRIPTION

- 4 - full height pedestal
- D - 2 file drawers
- F - 2 box, 1 file drawer
- L - left handed pedestal position
- R - right handed pedestal position
- 0 - no pedestal

STANDARD FINISHES

For a complete list of standard wood finishes please see page 4. Standard Laminate work-surfaces are available at a 10% upcharge.

GROMMETS

One grommet in standard position is optional at no charge. Additional grommets are available at an upcharge of **\$152 List**.

MILLENNIUM CREDENZAS

Description	Model	Cherry Maple Walnut	W	D	H	KW	Shipping Weight	Cubic Feet
Credenza, Ganged Pedestals -continued	68C71204LORDF	5835	71	20.25	28.5	38.5	207	29
	68C71204LORFD*	5835	71	24.5	28.5	38.5	207	29
	68C71204LORFF	5835	71	24.5	28.5	38.5	207	29
	68C71244LDDR0	5869	71	24.5	28.5	38.5	236	34
	68C71244LDFR0	5869	71	24.5	28.5	38.5	236	34
	68C71244LFDR0	5869	71	24.5	28.5	38.5	236	34
	68C71244LFFR0	5869	71	24.5	28.5	38.5	236	34
	68C71244LORDD	5869	71	24.5	28.5	38.5	236	34
	68C71244LORDF	5869	71	24.5	28.5	38.5	236	34
	68C71244LORFD	5869	71	20.25	28.5	38.5	236	34
	68C71244LORFF	5869	71	20.25	28.5	38.5	236	34
	68C78204LDDR0	5873	78	20.5	28.5	42.5	217	26
	68C78204LDFR0	5873	78	20.5	28.5	42.5	217	26
	68C78204LFDR0	5873	78	20.5	28.5	42.5	217	26
	68C78204LFFR0	5873	78	20.5	28.5	42.5	217	26
	68C78204LORDD	5873	78	20.5	28.5	42.5	217	26
	68C78204LORDF	5873	78	20.5	28.5	42.5	217	26
	68C78204LORFD	5873	78	20.5	28.5	42.5	217	26
	68C78204LORFF	5873	78	20.5	28.5	42.5	217	26
	68C78244LDDR0	5881	78	24.5	28.5	42.5	253	32
	68C78244LDFR0	5881	78	24.5	28.5	42.5	253	32
	68C78244LFDR0	5881	78	24.5	28.5	42.5	253	32
	68C78244LFFR0	5881	78	24.5	28.5	42.5	253	32
	68C78244LORDD	5881	78	24.5	28.5	42.5	253	32
	68C78244LORDF	5881	78	24.5	28.5	42.5	253	32
	68C78244LORFD	5881	78	24.5	28.5	42.5	253	32
	68C78244LORFF	5881	78	24.5	28.5	42.5	253	32
	68C84204LDDR0	5947	83.75	20.5	28.5	51.5	223	34
	68C84204LDFR0	5947	83.75	20.5	28.5	51.5	223	34
	68C84204LFDR0	5947	83.75	20.5	28.5	51.5	223	34
	68C84204LFFR0	5947	83.75	20.5	28.5	51.5	223	34
	68C84204LORDD	5947	83.75	20.5	28.5	51.5	223	34
	68C84204LORDF	5947	83.75	20.5	28.5	51.5	223	34
	68C84204LORFD	5947	83.75	20.5	28.5	51.5	223	34
	68C84204LORFF	5947	83.75	20.5	28.5	51.5	223	34
	68C84244LDDR0	5978	83.75	24.5	28.5	51.5	223	34
	68C84244LDFR0	5978	83.75	24.5	28.5	51.5	223	34
	68C84244LFDR0	5978	83.75	24.5	28.5	51.5	223	34
	68C84244LFFR0	5978	83.75	24.5	28.5	51.5	223	34
	68C84244LORDD	5978	83.75	24.5	28.5	51.5	223	34
68C84244LORDF	5978	83.75	24.5	28.5	51.5	223	34	
68C84244LORFD	5978	83.75	24.5	28.5	51.5	223	34	
68C84244LORFF	5978	83.75	24.5	28.5	51.5	223	34	

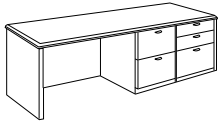

ORDERING NOTES: "C" position grommets are not available on 60-71" Ganged Pedestal Credenzas. Ganged pedestals are specified in the product code beginning with the pedestal closest to the end panel.

DIMENSION KEY

W - width
D - depth
H - height

*Indicates model illustrated by line drawing.

CODE DESCRIPTION

0 - no pedestal
4 - full height pedestal
L - left handed pedestal position
R - right handed pedestal position
D - 2 file drawer
F - 2 box, 1 file drawer

STANDARD FINISHES

For a complete list of standard wood finishes please see page 4. Standard Laminate work-surfaces are available at a 10% upcharge.

GROMMETS

One grommet in standard position is optional at no charge. Additional grommets are available at an upcharge of **\$152 List**.

MILLENNIUM CREDENZAS

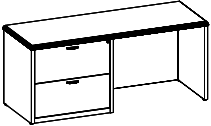
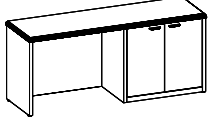
Description	Model	Cherry Maple Walnut	W	D	H	KW	Shipping Weight	Cubic Feet
Credenza, Lateral File or Bookcase Pedestals	68C6020LBR0	4392	60	20.5	28.5	28	174	24
	68C6020LFR0	4866	60	20.5	28.5	28	205	24
	68C6020LORB	4392	60	20.5	28.5	28	172	24
	68C6020LORF	4866	60	20.5	28.5	28	205	24
	68C6024LBR0	4416	60	24.5	28.5	28	198	29
	68C6024LFR0	4891	60	24.5	28.5	28	229	29
	68C6024LORB	4416	60	24.5	28.5	28	198	29
	68C6024LORF	4891	60	24.5	28.5	28	229	29
	68C6620LBR0	4507	65.75	20.5	28.5	33.75	185	28
	68C6620LFR0	4990	65.75	20.5	28.5	33.75	216	28
	68C6620LORB	4507	65.75	20.5	28.5	33.75	185	28
	68C6620LORF	4990	65.75	20.5	28.5	33.75	216	28
	68C6624LBR0	4596	65.75	24.5	28.5	33.75	212	32
	68C6624LFR0	5093	65.75	24.5	28.5	33.75	243	32
	68C6624LORB	4596	65.75	24.5	28.5	33.75	212	32
	68C6624LORF	5093	65.75	24.5	28.5	33.75	243	32
	68C7120LBR0	4672	71	20.5	28.5	33.5	195	31
	68C7120LFR0	5218	71	20.5	28.5	33.5	226	31
	68C7120LORB	4672	71	20.5	28.5	33.5	195	31
	68C7120LORF	5218	71	20.5	28.5	33.5	226	31
	68C7124LBR0	4795	71	24.5	28.5	33.5	224	34
	68C7124LFR0	5302	71	24.5	28.5	33.5	257	34
	68C7124LORB	4795	71	24.5	28.5	33.5	224	34
	68C7124LORF	5302	71	24.5	28.5	33.5	257	34
	68C7820LBR0	4784	78	20.5	28.5	41.5	196	26
	68C7820LFR0	5314	78	20.5	28.5	41.5	227	26
	68C7820LORB	4784	78	20.5	28.5	41.5	196	26
	68C7820LORF	5314	78	20.5	28.5	41.5	227	26
	68C7824LBR0	4853	78	24.5	28.5	41.5	221	32
	68C7824LFR0	5427	78	24.5	28.5	41.5	252	32
	68C7824LORB	4853	78	24.5	28.5	41.5	221	32
	68C7824LORF	5427	78	24.5	28.5	41.5	252	32
	68C8420LBR0	4933	83.75	20.5	28.5	39.5	211	34
	68C8420LFR0	5452	83.75	20.5	28.5	39.5	242	34
	68C8420LORB	4933	83.75	20.5	28.5	39.5	211	34
	68C8420LORF	5452	83.75	20.5	28.5	39.5	242	34
	68C8424LBR0	5035	83.75	24.5	28.5	39.5	242	40
	68C8424LFR0	5562	83.75	24.5	28.5	39.5	273	40
	68C8424LORB	5035	83.75	24.5	28.5	39.5	242	40
	68C8424LORF	5562	83.75	24.5	28.5	39.5	273	40

ORDERING NOTES: "C" position grommets are not available on 60-71" Lateral File/ Bookcase Pedestal Credenzas.

ORDERING PROCEDURE

To order, please specify the following:

- 1) Krug product model number
- 2) Wood species and finish, see page 4
- 3) Wood edge detail, see page 3
- 4) Pull style, see page 3
- 5) Grommet location if applicable

*Indicates model illustrated by line drawing.

CODE DESCRIPTION

- 4 - full height pedestal
- B - bookcase
- F - lateral file drawers
- L - left handed pedestal position
- R - right handed pedestal position
- 0 - no pedestal

STANDARD FINISHES

For a complete list of standard wood finishes please see page 4. Standard Laminate work-surfaces are available at a 10% upcharge.

GROMMETS

One grommet in standard position is optional at no charge. Additional grommets are available at an upcharge of **\$152 List**.

MILLENNIUM CREDENZAS

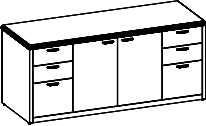
Description	Model	Cherry Maple Walnut	W	D	H	KW	Shipping Weight	Cubic Feet
	68C66244DBCD	6144	65.75	24.5	28.5	295	31	
	68C66244DBCF	6144	65.75	24.5	28.5	295	31	
	68C66244FBCD	6144	65.75	24.5	28.5	295	31	
	68C66244FBCF*	6144	65.75	24.5	28.5	295	31	
	68C71204DBCD	6347	71	20.5	28.5	295	30	
	68C71204DBCF	6347	71	20.5	28.5	295	30	
	68C71204FBCD	6347	71	20.5	28.5	295	30	
	68C71204FBCF	6347	71	20.5	28.5	295	30	
	68C71244DBCD	6508	71	24.5	28.5	305	34	
	68C71244DBCF	6508	71	24.5	28.5	305	34	
	68C71244FBCD	6508	71	24.5	28.5	305	34	
	68C71244FBCF	6508	71	24.5	28.5	305	34	
	68C78204DBCD	6516	78	20.5	28.5	305	30	
	68C78204DBCF	6516	78	20.5	28.5	305	30	
	68C78204FBCD	6516	78	20.5	28.5	305	30	
	68C78204FBCF	6516	78	20.5	28.5	305	30	
	68C78244DBCD	6730	78	24.5	28.5	315	34	
	68C78244DBCF	6730	78	24.5	28.5	315	34	
	68C78244FBCD	6730	78	24.5	28.5	315	34	
	68C78244FBCF	6730	78	24.5	28.5	315	34	
	68C84204DBCD	6690	83.75	20.5	28.5	315	36	
	68C84204DBCF	6690	83.75	20.5	28.5	315	36	
	68C84204FBCD	6690	83.75	20.5	28.5	315	36	
	68C84204FBCF	6690	83.75	20.5	28.5	315	36	
	68C84244DBCD	6882	83.75	24.5	28.5	325	40	
	68C84244DBCF	6882	83.75	24.5	28.5	325	40	
	68C84244FBCD	6882	83.75	24.5	28.5	325	40	
	68C84244FBCF	6882	83.75	24.5	28.5	325	40	

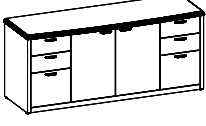
	Bow Top Full Face Credenza	68CX66204DBCD	6543	65.75	20.5	28.5	264	27
	68CX66204FBCF*	6543	65.75	20.5	28.5	264	27	
	68CX66204FBCD	6543	65.75	20.5	28.5	264	27	
	68CX66204DBCF	6543	65.75	20.5	28.5	264	27	
	68CX66244DBCD	6663	65.75	24.5	28.5	291	30	
	68CX66244FBCF	6663	65.75	24.5	28.5	291	30	
	68CX66244FBCD	6663	65.75	24.5	28.5	291	30	
	68CX66244DBCF	6663	65.75	24.5	28.5	291	30	
	68CX71204DBCD	6875	71	20.5	28.5	271	32	
	68CX71204FBCF	6875	71	20.5	28.5	271	32	
	68CX71204FBCD	6875	71	20.5	28.5	271	32	
	68CX71204DBCF	6875	71	20.5	28.5	271	32	
	68CX71244DBCD	7042	71	24.5	28.5	303	34	
	68CX71244FBCF	7042	71	24.5	28.5	303	34	
	68CX71244FBCD	7042	71	24.5	28.5	303	34	
	68CX71244DBCF	7042	71	24.5	28.5	303	34	
	68CX78204DBCD	7148	78	20.5	28.5	278	37	
	68CX78204FBCF	7148	78	20.5	28.5	278	37	
	68CX78204FBCD	7148	78	20.5	28.5	278	37	
	68CX78204DBCF	7148	78	20.5	28.5	278	37	
68CX78244DBCD	7478	78	24.5	28.5	315	38		
68CX78244FBCF	7478	78	24.5	28.5	315	38		
68CX78244FBCD	7478	78	24.5	28.5	315	38		
68CX78244DBCF	7478	78	24.5	28.5	315	38		

DIMENSION KEY

W - width
D - depth
H - height

*Indicates model illustrated by line drawing.

CODE DESCRIPTION

4 - full height pedestal
D - 2 file drawer
BC - bookcase
F - 2 box, 1 file drawer

STANDARD FINISHES

For a complete list of standard wood finishes please see page 4. Standard Laminate work-surfaces are available at a 10% upcharge.

MILLENNIUM CREDENZAS

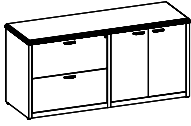
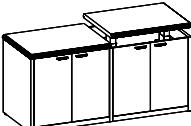
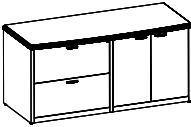
Description	Model	Cherry	W	D	H	Shipping Weight	Cubic Feet
		Maple Walnut					
	68C6020LBRB	5272	60	20.5	28.5	226	24
	68C6020LBRF	6167	60	20.5	28.5	257	24
	68C6020LFRB*	6185	60	20.5	28.5	257	24
	68C6020LFRF	6796	60	20.5	28.5	288	24
	68C6024LBRB	5273	60	24.5	28.5	250	29
	68C6024LBRF	6229	60	24.5	28.5	281	29
	68C6024LFRB	6229	60	24.5	28.5	281	29
	68C6024LFRF	6822	60	24.5	28.5	312	29
	68C7120LBRB	5616	71	20.5	28.5	247	31
	68C7120LBRF	6599	71	20.5	28.5	278	31
	68C7120LFRB	6599	71	20.5	28.5	278	31
	68C7120LFRF	7233	71	20.5	28.5	309	31
	68C7124LBRB	5696	71	24.5	28.5	271	34
	68C7124LBRF	6720	71	24.5	28.5	307	34
	68C7124LFRB	6720	71	24.5	28.5	307	34
	68C7124LFRF	7324	71	24.5	28.5	338	34
	68C8420LBRB	5810	83.75	20.5	28.5	263	34
	68C8420LBRF	6884	83.75	20.5	28.5	294	34
	68C8420LFRB	6884	83.75	20.5	28.5	294	34
	68C8420LFRF	7452	83.75	20.5	28.5	325	34
	68C8424LBRB	5889	83.75	24.5	28.5	294	40
	68C8424LBRF	7036	83.75	24.5	28.5	325	40
	68C8424LFRB	7036	83.75	24.5	28.5	325	40
68C8424LFRF	7536	83.75	24.5	28.5	356	40	
	68C6024LBRHAES*	6875	59.75	24	29.5	176	28
	68C6024LHAESRB	6875	59.75	24	29.5	192	28
	68C6024LFRHAES	7152	59.75	24	29.5	192	28
	68C6024LHAESRF	7152	59.75	24	29.5	248	28
	68C7224LBRHAES	7566	71.75	24	29.5	192	33
	68C7224LHAESRB	7566	71.75	24	29.5	210	33
	68C7224LFRHAES	7725	71.75	24	29.5	210	33
	68C7224LHAESRF	7725	71.75	24	29.5	230	33
ORDERING NOTES: Height range of electric lift is 29.5" to 46.5".							
	68CX6020LBRB	6060	60	20.5	28.5	241	24
	68CX6020LBRF	7135	60	20.5	28.5	272	24
	68CX6020LFRB*	7135	60	20.5	28.5	272	24
	68CX6020LFRF	7824	60	20.5	28.5	303	24
	68CX6024LBRB	6126	60	24.5	28.5	265	29
	68CX6024LBRF	7282	60	24.5	28.5	296	29
	68CX6024LFRB	7282	60	24.5	28.5	296	29
	68CX6024LFRF	7918	60	24.5	28.5	327	29
	68CX7120LBRB	6270	71	20.5	28.5	262	31
	68CX7120LBRF	7418	71	20.5	28.5	293	31
	68CX7120LFRB	7418	71	20.5	28.5	293	31
	68CX7120LFRF	8074	71	20.5	28.5	324	31
	68CX7124LBRB	6391	71	24.5	28.5	291	34
	68CX7124LBRF	7577	71	24.5	28.5	322	34
	68CX7124LFRB	7577	71	24.5	28.5	322	34
68CX7124LFRF	8123	71	24.5	28.5	353	34	

ORDERING PROCEDURE

- To order, please specify the following:
- 1) Krug product model number
 - 2) Wood species and finish, see page 4
 - 3) Wood edge detail, see page 3
 - 4) Pull style, see page 3
 - 5) Grommet location if applicable

*Indicates model illustrated by line drawing.

CODE DESCRIPTION

- L - left handed pedestal position
- R - right handed pedestal position
- B - bookcase
- F- 2 lateral file drawers

STANDARD FINISHES

For a complete list of standard wood finishes please see page 4. Standard Laminate work-surfaces are available at a 10% upcharge.

MILLENNIUM CREDENZAS

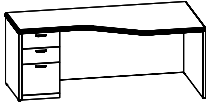
Description	Model	Cherry Maple Walnut	Dimensions			Shipping Weight	Cubic Feet
			W	D	H		
Corner Credenza with Single Full Height Pedestal 	68CC6624L4D	4209	65.75	36.25	28.5	230	45
	68CC6624L4F	4209	65.75	36.25	28.5	230	45
	68CC6624R4D	4209	65.75	36.25	28.5	230	45
	68CC6624R4F	4209	65.75	36.25	28.5	230	45
	68CC7124L4D	4308	71	36.25	28.5	240	50
	68CC7124L4F*	4308	71	36.25	28.5	240	50
	68CC7124R4D	4308	71	36.25	28.5	240	50
	68CC7124R4F	4308	71	36.25	28.5	240	50
	68CC7824L4D	4365	78	36.25	28.5	250	55
	68CC7824L4F	4365	78	36.25	28.5	250	55
	68CC7824R4D	4365	78	36.25	28.5	250	55
	68CC7824R4F	4365	78	36.25	28.5	250	55
	68CC8424L4D	4418	82.75	36.25	28.5	260	59
	68CC8424L4F	4418	82.75	36.25	28.5	260	59
	68CC8424R4D	4418	82.75	36.25	28.5	260	59
	68CC8424R4F	4418	82.75	36.25	28.5	260	59

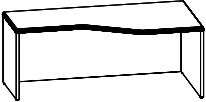
Description	Model	Cherry Maple Walnut	Dimensions			Shipping Weight	Cubic Feet
			W	D	H		
Corner Credenza Shell 	68CC6624L	3222	65.75	36.25	28.5	180	45
	68CC6624R	3222	65.75	36.25	28.5	180	45
	68CC7124L	3263	71	36.25	28.5	190	50
	68CC7124R	3263	71	36.25	28.5	190	50
	68CC7824L*	3304	78	36.25	28.5	200	55
	68CC7824R	3304	78	36.25	28.5	200	55
	68CC8424L	3339	82.75	36.25	28.5	210	59
	68CC8424R	3339	82.75	36.25	28.5	210	59

ORDERING NOTES: For a curved corner version of this credenza, please add 5% list to above list prices and add an extra C to the model number prefix. Example: 68CCC7124L4D**

Description	Model	Cherry Maple Walnut	Dimensions			Shipping Weight	Cubic Feet
			W	D	H		
Half Gable 	68HG2710*	443	10	27	27	11	1
	68HG2716	507	16	27	27	16	1

ORDERING NOTES: This unit should be ordered to center-support open spans greater than 60". Use 68HG2710 with 20" & 24" deep cases and 68HG2716 with 30" deep cases.

DIMENSION KEY

W - width
D - depth
H - height

*Indicates model illustrated by line drawing.

CODE DESCRIPTION

4 - full height pedestal
L - left handed pedestal position
R - right handed pedestal position
D - 2 file drawer
F - 2 box, 1 file drawer

STANDARD FINISHES

For a complete list of standard wood finishes please see page 4. Standard Laminate work-surfaces are available at a 10% upcharge.

GROMMETS

One grommet in standard position is optional at no charge. Additional grommets are available at an upcharge of **\$152 List**.

MILLENNIUM OVERHEADS

Description	Model	Cherry Maple Walnut	W	D	H	KW	Shipping Weight	Cubic Feet
	68OF4219	2205	42	18	19.25	151	10	
	68OF4819	2283	48	18	19.25	162	12	
	68OF6019*	2672	58.5	18	19.25	173	15	
	68OF6619	2810	64.25	18	19.25	184	16	
	68OF7119	2962	70.5	18	19.25	195	17	

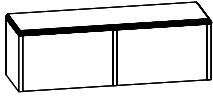

Single Height Overhead with Hinged Doors	68OH361517	2073	36	15	16.75	2	127	9
	68OH421517	2205	42	15	16.75	2	136	10
	68OH481517	2286	48	15	16.75	3	145	12
	68OH601517*	2663	58.5	15	16.75	4	154	15
	68OH661517	2810	64.25	15	16.75	4	163	16
	68OH711517	2916	70.5	15	16.75	4	172	17

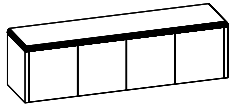

Overhead, Open	68OO361517	1704	36	15	16.75	2	117	9
	68OO421517	1798	42	15	16.75	2	126	10
	68OO481517	1867	48	15	16.75	3	135	12
	68OO601517*	2210	58.5	15	16.75	4	124	15
	68OO661517	2339	64.25	15	16.75	4	143	16
	68OO711517	2485	70.5	15	16.75	4	152	17

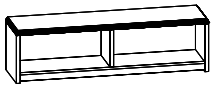

ORDERING NOTES: Please see page 7 for double height options and paper management options. All overheads include factory installed tasklights and mounting hardware. Locks are available on wood door overheads at **\$152 list** per set of (2) doors.

Description	Model	GRADES									W	H	COM	WT
		1	2	3	4	5	6	7	8	9				
Tackboards for Overheads with Flipper Doors	68TBOF36	337	374	411	470	613	751	886	1031	1210	38	24	1.5	10
	68TBOF42	374	507	533	664	795	916	1053	1212	1429	44	24	1.5	12
	68TBOF48	416	516	541	677	815	937	1080	1240	1492	50	24	1.75	13
	68TBOF60	471	632	664	823	989	1172	1357	1543	1833	61	24	2	15
	68TBOF66	516	702	691	917	1102	1307	1487	1699	2024	67	24	2	16
	68TBOF71	568	871	908	1203	1480	1495	1717	1960	2285	74	24	2.25	18
Tackboards for Overheads with Hinged Doors	68TBOH36	337	374	411	470	613	751	886	1031	1210	38	24	1.5	10
	68TBOH42	374	507	533	664	795	916	1053	1212	1429	44	24	1.5	12
	68TBOH48	416	516	541	677	815	937	1080	1240	1492	50	24	1.75	13
	68TBOH60	471	632	664	823	989	1172	1357	1543	1833	61	24	2	15
	68TBOH66	516	702	691	917	1102	1307	1487	1699	2024	67	24	2	16
	68TBOH71	568	871	908	1203	1480	1495	1717	1960	2285	74	24	2.25	18



ORDERING NOTES: Please contact Customer Service for information on yardage required when ordering two or more tackboards. Please note either tackboard code 68TBOF or 68TBOH can be used for an open overheads.

ORDERING PROCEDURE

- To order, please specify the following:
- 1) Krug product model number
 - 2) Wood species and finish, see page 4
 - 3) Wood edge detail, see page 3
 - 4) Pull style, see page 3
 - 5) Grommet location if applicable

*Indicates model illustrated by line drawing.

STANDARD FINISHES

For a complete list of standard wood finishes please see page 4.

MILLENNIUM HUTCHES

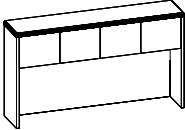
Description	Model	Cherry Maple Walnut	W	D	H	TH	Shipping Weight	Cubic Feet	
	Hutches, Hinged Doors	68HT3615	2577	35.25	15	39.75	23	147	15
		68HT4215	2838	41	15	39.75	23	156	18
		68HT4815	3345	47	15	39.75	23	165	20
		68HT5415	3578	53	15	39.75	23	174	22
		68HT6015*	3924	58.75	15	39.75	23	183	25
		68HT6615	4292	64.75	15	39.75	23	192	27
		68HT7115	5036	70	15	39.75	23	201	30
		68HT7815	5339	77	15	39.75	23	210	32
		68HT8415	5637	83	15	39.75	23	215	35
		68HT9018-2	7259	89	18	39.75	23	274	44
		68HT9618-2	8181	95	18	39.75	23	293	47
		68HT10218-2	8698	101	18	39.75	23	311	50
		68HT11018-2	9322	109	18	39.75	23	336	54

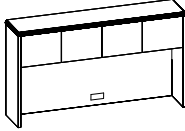
	Hutches, Hinged Doors & Power/Data/Voice Grommet	68HT3615W	2790	35.25	15	39.75	23	147	15
		68HT4215W	3040	41	15	39.75	23	156	18
		68HT4815W	3554	47	15	39.75	23	165	20
		68HT5415W	3763	53	15	39.75	23	174	22
		68HT6015W*	4129	58.75	15	39.75	23	183	25
		68HT6615W	4490	64.75	15	39.75	23	192	27
		68HT7115W	5242	70	15	39.75	23	201	30
		68HT7815W	5519	77	15	39.75	23	210	32
		68HT8415W	5844	83	15	39.75	23	215	35
		68HT9018-2W	7511	89	18	39.75	23	274	44
		68HT9618-2W	8421	95	18	39.75	23	293	47
		68HT10218-2W	8889	101	18	39.75	23	311	50
		68HT11018-2W	9589	109	18	39.75	23	336	54

ORDERING NOTES: Hinged door hutches include factory installed tasklights and tackboard. "TH" column above represents the clearance height for the tackboard. Hutches over 84" in length will be made in two pieces. Hutches are inset 3/4" on each side when sitting on the worksurface. Locks are available on wood door hutches at **\$152 list** per (2) doors. Please specify at time of order.

	Hutch, Open	68HTO3615	2437	35.25	15	39.75	23	137	15
		68HTO4215	2764	41	15	39.75	23	146	18
		68HTO4815	3087	47	15	39.75	23	155	20
		68HTO5415	3239	53	15	39.75	23	164	22
		68HTO6015	3479	58.75	15	39.75	23	173	25
		68HTO6615*	3847	64.75	15	39.75	23	192	28
		68HTO7115	4251	70	15	39.75	23	181	30
		68HTO7815	4435	77	15	39.75	23	190	32
		68HTO8415	4615	83	15	39.75	23	199	35
		68HTO9018-2	5980	89	18	39.75	23	254	44
		68HTO9618-2	6762	95	18	39.75	23	273	47
		68HTO10218-2	7386	101	18	39.75	23	291	50

DIMENSION KEY

W - width
D - depth
H - height
TH - tackboard height clearance



CODE DESCRIPTION

W - includes power/data/voice grommet in tackboard
-2 - Hutches over 84" in length will be made in two pieces.

STANDARD FINISHES

For a complete list of standard wood finishes please see page 4.

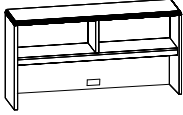
MILLENNIUM HUTCHES

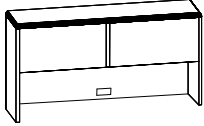
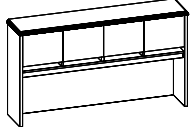
Description	Model	Cherry	W	D	H	HT	Shipping	Cubic
		Maple Walnut						
	Hutch, Open & Power/ Data/Voice Grommet	2654	35.25	18	39.75	23	137	15
	68HTO4215W	2959	41	15	39.75	23	146	18
	68HTO4815W	3273	47	15	39.75	23	155	20
	68HTO5415W	3446	53	15	39.75	23	164	22
	68HTO6015W	3683	58.75	15	39.75	23	173	25
	68HTO6615W	4047	64.75	15	39.75	23	192	28
	68HTO7115W	4478	70	15	39.75	23	181	30
	68HTO7815W	4622	77	15	39.75	23	190	32
	68HTO8415W	4799	83	15	39.75	23	199	35
	68HTO9018-2W	6246	89	18	39.75	23	254	44
	68HTO9618-2W	7022	95	18	39.75	23	254	47
	68HTO10218-2W	7655	101	18	39.75	23	291	50
		Hutch, Flipper Doors	2555	35.25	18	39.75	22	158
68HTF3618		2863	41	18	39.75	22	167	18
68HTF4218		3299	47	18	39.75	22	176	20
68HTF4818		3617	53	18	39.75	22	185	23
68HTF5418		4237	58.75	18	39.75	22	194	25
68HTF6018		4555	64.75	18	39.75	22	203	27
68HTF6618		5272	70	18	39.75	22	212	30
68HTF7118		5644	77	18	39.75	22	221	33
68HTF7818		6090	83	18	39.75	22	230	35
68HTF8418		7754	89	18	39.75	22	239	44
	Hutch, Flipper Doors & Power/Data/Voice Grommet	2751	35.25	18	39.75	22	158	15
	68HTF3618W	3088	41	18	39.75	22	167	18
	68HTF4218W	3490	47	18	39.75	22	176	20
	68HTF4818W	3804	53	18	39.75	22	185	23
	68HTF5418W	4456	58.75	18	39.75	22	194	25
	68HTF6018W	4777	64.75	18	39.75	22	203	27
	68HTF6618W	5471	70	18	39.75	22	212	30
	68HTF7118W	5814	77	18	39.75	22	221	33
	68HTF7818W	6258	83	18	39.75	22	230	35
	68HTF8418W	7949	89	18	39.75	22	239	44
	Hutch, Paper Management	5053	58.75	15	39.75	19.75	204	25
	68HTPM6015	5196	64.75	15	39.75	19.75	214	27
	68HTPM6615	5380	70	15	39.75	19.75	232	30
	68HTPM7115	5771	77	15	39.75	19.75	241	33
	68HTPM7815	6184	83	15	39.75	19.75	250	35
	68HTPM8415	10222	95	18	39.75	19.75	300	35
	68HTPM9618-2	10872	101	18	39.75	19.75	320	35
	68HTPM10218-2	11647	109	18	39.75	19.75	340	35

ORDERING NOTES: All hutches include factory installed tasklights and tackboard. "TH" column above represents the clearance height for the tackboard. Hutches over 84" in length will be made in two pieces. Hutches are inset 3/4" on each side when sitting on the worksurface.

ORDERING PROCEDURE

To order, please specify the following:
 1) Krug product model number
 2) Wood species and finish, see page 4
 3) Wood edge detail, see page 3
 4) Pull style, see page 3
 5) Grommet location if applicable

CODE DESCRIPTION

G - wood framed clear glass doors
 OF- flipper door
 OH- hinged door
 OO- open, no doors
 W - includes power/data/voice grommet in tackboard
 PM- paper manager
 PS- paper shelf

STANDARD FINISHES

For a complete list of standard wood finishes please see page 4.

MILLENNIUM HUTCHES

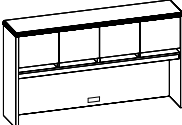
Description	Model	Cherry Maple Walnut	W	D	H	HT	Shipping	
							Weight	Cubic Feet
Hutch, Paper Management with Power/Data/Voice Grommet 	68HTPM6015W	5219	58.75	15	39.75	19.75	204	25
	68HTPM6615W	5411	64.75	15	39.75	19.75	214	27
	68HTPM7115W	5563	70	15	39.75	19.75	232	30
	68HTPM7815W	5982	77	15	39.75	19.75	241	33
	68HTPM8415W	6370	83	15	39.75	19.75	250	35
	68HTPM9618-2W	10410	95	18	39.75	19.75	300	35
	68HTPM10218-2W	11082	101	18	39.75	19.75	320	35
	68HTPM11018-2W	11857	109	18	39.75	19.75	340	35

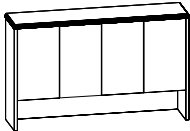
Bookcase Hutch, Hinged Doors 	68HTBC3615	2763	35.25	15	39.75	11.5	167	15
	68HTBC4215	3126	41	15	39.75	11.5	176	18
	68HTBC4815	3491	47	15	39.75	11.5	185	22
	68HTBC5415	3662	53	15	39.75	11.5	194	25
	68HTBC6015	3859	58.75	15	39.75	11.5	203	25
	68HTBC6615	4343	64.75	15	39.75	11.5	212	27
	68HTBC7115	4795	70	15	39.75	11.5	221	30
	68HTBC7815	5319	77	15	39.75	11.5	230	34
68HTBC8415	5885	83	15	39.75	11.5	248	37	

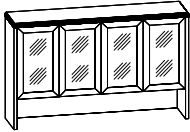
Bookcase Hutch, Hinged Glass Doors 	68HTBC3615G	2899	35.25	15	39.75	11.5	117	15
	68HTBC4215G	3277	41	15	39.75	11.5	176	18
	68HTBC4815G	3668	47	15	39.75	11.5	185	22
	68HTBC5415G	3881	53	15	39.75	11.5	194	25
	68HTBC6015G	4093	58.75	15	39.75	11.5	203	25
	68HTBC6615G*	4567	64.75	15	39.75	11.5	212	27
	68HTBC7115G	5047	70	15	39.75	11.5	221	30
	68HTBC7815G	5604	77	15	39.75	11.5	230	34
68HTBC8415G	6181	83	15	39.75	11.5	248	37	

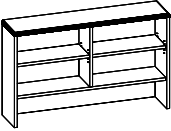
Bookcase Hutch, Open 	68HTBCO3615	2304	35.25	15	39.75	11.5	157	15
	68HTBCO4215	2650	41	15	39.75	11.5	166	18
	68HTBCO4815	2989	47	15	39.75	11.5	175	20
	68HTBCO5415	3052	53	15	39.75	11.5	184	23
	68HTBCO6015	3117	58.75	15	39.75	11.5	183	25
	68HTBCO6615*	3568	64.75	15	39.75	11.5	192	27
	68HTBCO7115	4020	70	15	39.75	11.5	201	30
	68HTBCO7815	4477	77	15	39.75	11.5	210	33
68HTBCO8415	4981	73	15	39.75	11.5	219	35	

ORDERING NOTES: Bookcase hutches include a finished back panel. Bookcase hutches cannot accept tackboards or tasklights. Hutches over 84" in length will be made in two pieces. Hutches are inset 3/4" on each side when sitting on the worksurface.

DIMENSION KEY

W - width
D - depth
H - height
TH - tackboard height clearance

CODE DESCRIPTION

G - wood framed clear glass doors
W - includes power/data/voice grommet in tackboard
-2 - Hutches over 84" in length will be made in two pieces.

STANDARD FINISHES

For a complete list of standard wood finishes please see page 4.

MILLENNIUM HUTCHES

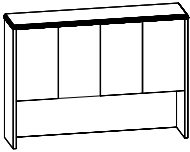
Description	Model	Cherry		W	D	H	KW	Shipping Weight	Cubic Feet
		Maple	Walnut						
	68HT601555	4771		58.75	15	55.5	23	260	25
	68HT661555*	5300		64.75	15	55.5	23	273	27
	68HT711555	6067		70	15	55.5	23	281	30
	68HT781555	6531		77	15	55.5	23	290	32
	68HT841555	6989		83	15	55.5	23	299	35

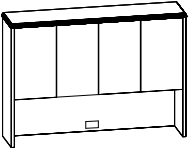
	68HT601555W	4957		58.75	15	55.5	23	260	25
	68HT661555W	5483		64.75	15	55.5	23	273	27
	68HT711555W	6295		70	15	55.5	23	281	30
	68HT781555W	6760		77	15	55.5	23	290	32
	68HT841555W	7193		83	15	55.5	23	299	35

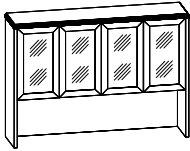
	68HT601555G	5056		58.75	15	55.5	23	176	25
	68HT661555G	5617		64.75	15	55.5	23	188	27
	68HT711555G	6427		70	15	55.5	23	199	30
	68HT781555G	6915		77	15	55.5	23	212	32
	68HT841555G	7408		83	15	55.5	23	232	35

ORDERING NOTES: Hinged door hutches include factory installed tasklights and tackboard. Hutches over 84" in length will be made in two pieces. Hutches are inset 3/4" on each side when sitting on the worksurface. Locks are available on wood door hutches at \$152 list per (2) doors. Please specify at time of order.

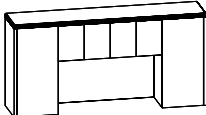
	68HTPD8418	6240		83	18	39.75	23	290	41
	68HTPD9018-2	8130		89	18	39.75	23	305	44
	68HTPD9618-2	8704		95	18	39.75	23	320	47
	68HTPD11018-2	9957		109	18	39.75	23	350	51

ORDERING NOTES: Pier door hutches include factory installed tasklights and a tackboard. "TH" column above represents the clearance height for the tackboard. Hutches over 84" in length will be made in two pieces. Hutches are inset 3/4" on each side when sitting on the worksurface.

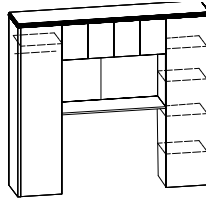
	68WU9618LWRB*	10626		95.75	24.25	68		665	60
	68WU9618LBRW	10626		95.75	24.25	68		665	60
	68WU10818LWRB	11334		108	24.25	68		705	70
	68WU10818LBRW	11334		108	24.25	68		705	70

ORDERING PROCEDURE

To order, please specify the following:

- 1) Krug product model number
- 2) Wood species and finish, see page 4
- 3) Wood edge detail, see page 3
- 4) Pull style, see page 3
- 5) Grommet location if applicable

*Indicates model illustrated by line drawing.

CODE DESCRIPTION

G - framed clear glass doors
 W - includes power/data/voice grommet in tackboard
 -2 - Hutches over 84" in length will be made in two pieces
 L/RW - left or right wardrobe
 L/RB - left or right bookcase storage

STANDARD FINISHES

For a complete list of standard wood finishes please see page 4.

MILLENNIUM HUTCHES

Description	GRADES								COM
	2	3	4	5	6	7	8	9	
36" hutch tackboard	164	352	513	686	848	1011	1173	1428	1.5
42" hutch tackboard	164	352	513	686	848	1011	1173	1428	1.5
48" hutch tackboard	164	352	513	686	848	1011	1173	1428	1.75
54" hutch tackboard	164	352	513	686	848	1011	1173	1428	1.75
60" hutch tackboard	164	352	513	686	848	1011	1173	1428	2
66" hutch tackboard	185	397	582	778	961	1146	1331	1654	2.25
71" hutch tackboard	223	471	693	929	1151	1373	1593	1920	2
78" hutch tackboard	265	555	821	1088	1356	1617	1880	2584	2
84" hutch tackboard	309	642	954	1262	1569	1875	2184	2584	2.5
90" hutch tackboard	348	722	1068	1415	1761	2107	2451	2846	2.75
96" hutch tackboard	382	793	1177	1556	1935	2322	2694	3129	3
102" hutch tackboard	420	871	1297	1714	2130	2549	2965	3399	3
110" hutch tackboard	458	960	1177	1884	2343	2802	3260	3732	3.25
84" pier door hutch tackboard	164	352	513	686	848	1011	1173	1428	2
90" pier door hutch tackboard	164	352	513	686	848	1011	1173	1428	2.25
96" pier door hutch tackboard	164	352	513	686	837	1011	1173	1428	2.5
110" pier door hutch tackboard	259	556	816	1083	1340	1603	1603	2191	2.75
96" wall unit tackboard	164	352	513	686	848	1011	1011	1428	2.5
108" wall unit tackboard"	259	556	816	1083	1340	1603	1603	2191	2.5

On single piece hutches, the yardage requirement for two tackboards is the same as for one tackboard. Please keep this in mind when ordering more than one tackboard. For example, if the number of tackboards required is 7 and the COM requirement for 1 tackboard is 1.5 yards, the calculation for COM yardage is as follows: 4.5 yards are required for 6 tackboards + 1.5 yards for the 7th tackboard for a total of 6 yards. In the case of an even number of tackboards, divide the number of tackboards required by 2 and multiply that number by COM requirement on the chart. The fabric must be at least 54" wide in order to qualify for this procedure. If the fabric is less than 54" wide, the COM yardage listed on the chart is the amount required for each tackboard.

Quantity of Tackboards Required (example: 60")	COM Yardage Calculation Chart for Tackboards	
	Number of Yards Required per Tackboard (example: 60")	Number of Yards Required in Total (example: 60")
one	2 yards	2
two	2 yards	2
three	2 yards	4
four	2 yards	4
five	2 yards	6
six	2 yards	6
seven	2 yards	8
eight	2 yards	8

DIMENSION KEY

W - width
D - depth
H - height

MILLENNIUM HUTCH ACCESSORIES

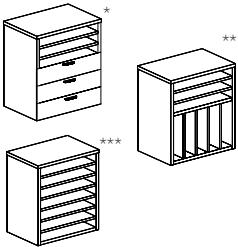
Description	Model	Cherry Maple Walnut	W	D	H	Shipping Weight	Cubic Feet
	Paper Manager	1695	17	12.5	19.75	50	3
	68PM18132001*	1373	17	12.5	19.75	50	3
	68PM18122002**	1373	17	12.5	19.75	50	3
	68PM18122003***	1373	17	12.5	19.75	50	3

List

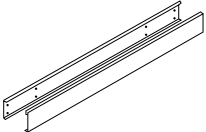
	Tackboard Organizer Rail	100	31	-	2.5	-	-
	68AOB36HT	100	37	-	2.5	-	-
	68AOB42HT	100	43	-	2.5	-	-
	68AOB48HT	100	49	-	2.5	-	-
	68AOB54HT	100	55	-	2.5	-	-
	68AOB60HT	100	61	-	2.5	-	-
	68AOB66HT	100	66	-	2.5	-	-
	68AOB71HT	100	73	-	2.5	-	-
	68AOB78HT	100	79	-	2.5	-	-
	68AOB84HT	100	85	-	2.5	-	-
	68AOB90HT	100	91	-	2.5	-	-
	68AOB96HT	100	97	-	2.5	-	-
68AOB102HT	100	105	-	2.5	-	-	
68AOB110HT	100						

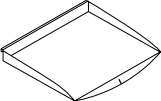
	Paper Tray	68APT	100	12	10.75	2	1.75	0.5
---	------------	-------	-----	----	-------	---	------	-----

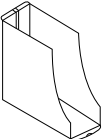
	Binder Bin	68ABB	140	10	4	10	3	0.5
--	------------	-------	-----	----	---	----	---	-----

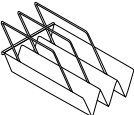
	File Organizer	68AFO	114	6	9.75	2.5	1.75	0.5
--	----------------	-------	-----	---	------	-----	------	-----

ORDERING NOTES: This accessory can not be specified in combination with Paper Management Hutches due to space requirements.

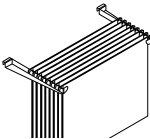
	Hanging File Bars	68AFB	114	1.75	7.5	0.75	0.5	0.25
--	-------------------	-------	-----	------	-----	------	-----	------

ORDERING PROCEDURE

- To order, please specify the following:
- 1) Krug product model number
 - 2) Wood species and finish, see page 4
 - 3) Wood edge detail, see page 3
 - 4) Pull style, see page 3
 - 5) Grommet location if applicable

*Indicates model illustrated by line drawing.

ACCESSORIES

Accessories feature a brushed aluminum finish.

TACKBOARD ORGANIZER RAIL

Please specify clearly on the purchase order which products are to receive Organizer Rail and Accessory options.

MILLENNIUM BOOKCASES

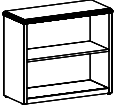
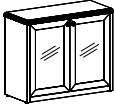
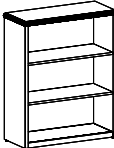
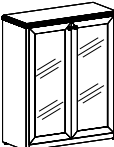
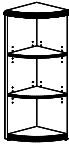
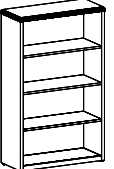
Description	Model	Cherry Maple Walnut	Dimensions			Shipping Weight	Cubic Feet
			W	D	H		
 2 Hi Open Bookcase	68BC301529	2034	30	15	29.25	60	9
	68BC361529	2086	35.25	15	29.25	70	11
	68BC481529	2295	48	15	29.25	90	14
	68BC601529	2504	60	15	29.25	110	17
	68BC711529	2744	71	15	29.25	130	20
 2 Hi Bookcase with Glass Doors	68BC301529-11G	2164	30	15	29.25	70	9
	68BC361529-11G	2214	35.25	15	29.25	80	11
 3 Hi Bookcase	68BC301543	2312	30	15	42.5	80	13
	68BC361543	2356	35.25	15	42.5	90	15
	68BC481543	2596	48	15	42.5	110	17
	68BC601543	2851	60	15	42.5	130	21
	68BC711543	3135	71	15	42.5	150	25
 3 Hi Bookcase with Glass Doors	68BC301543-11G	2443	30	15	43	100	13
	68BC361543-11G	2497	35.25	15	43	115	15
 3-Hi Curved Corner Bookcase	68BCCE151543-17R	2720	15	15	43	55	7.5
	68BCCE151543-17L	2720	15	15	43	55	7.5
 4-Hi Open Bookcase	68BC301556	2595	30	15	56	100	13
	68BC361556	2650	35.25	15	56	120	15

DIMENSION KEY

W - width
D - depth
H - height

CODE DESCRIPTION

L - left hand position
R - right hand position
G - framed clear glass doors

STANDARD FINISHES

For a complete list of standard wood finishes please see page 4.

SHELVES

Shelves are adjustable in 1.25" increments.

PULLS

Glass door bookcases feature the Luna knob.

MILLENNIUM BOOKCASES

Description	Model	Cherry Maple Walnut		W	D	H	Shipping Weight	Cubic Feet
4-Hi Bookcase with Glass Doors	68BC301556-11G	2740		30	15	56	125	13
	68BC361556-11G	2807		35.25	15	56	148	15

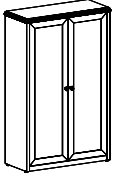

5-Hi Open Bookcase	68BC301569	2819		30	15	69	150	21
	68BC361569	2874		35.25	15	69	180	24

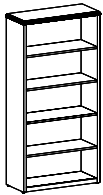

5-Hi Bookcase with 3 Open & 2 Closed Shelves	68BC301569-13	2959		30	15	69	160	21
	68BC361569-13	3016		35.25	15	69	190	24

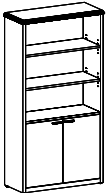

5-Hi Bookcase with 3 Library & 2 Closed Shelves	68BC301569-43	3457		30	15	69	175	21
	68BC361569-43	3473		35.25	15	69	205	24

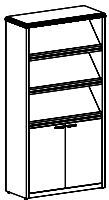

6-Hi Open Bookcase	68BC301584	2954		30	15	84	180	26
	68BC361584	3013		35.25	15	84	215	30

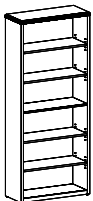

ORDERING PROCEDURE

To order, please specify the following:

- 1) Krug product model number
- 2) Wood species and finish, see page 4
- 3) Wood edge detail, see page 3
- 4) Pull style, see page 3
- 5) Grommet location if applicable

CODE DESCRIPTION

G - framed clear glass doors

STANDARD FINISHES

For a complete list of standard wood finishes please see page 4.



PULLS/LOCKS

Wood door bookcases have pulls, glass door bookcases feature the Luna knob.

SHELVES

Shelves are adjustable in 1.25" increments.

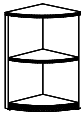
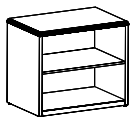
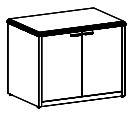
MILLENNIUM STORAGE

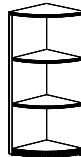
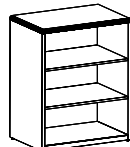
Description	Model	Cherry Maple Walnut	W	D	H	Shipping Weight	Cubic Feet
	68STCE20202917L	2366	20.25	20.25	28.25	56	9
	68STCE20202917R	2366	20.25	20.25	28.25	56	9
	68STCE24242917L	2483	24.25	24.25	28.25	65	12.5
	68STCE24242917R	2483	24.25	24.25	28.25	65	12.5
	68ST30202917	1959	30	20.25	41.75	164	18
	68ST30242917	1997	30	24.25	41.75	183	22
	68ST36202917	2042	36.2	20.25	41.75	196	21
	68ST36242917	2083	36.25	24.25	41.75	218	25
	68ST30202911	2785	30	20.25	28.5	94	13
	68ST30242911	2830	30	24.25	28.5	120	15
	68ST36202911	2877	36.25	20.25	28.5	116	15
	68ST36242911	2929	36.25	24.25	28.5	146	18
	68ST30202901	3642	30	20.25	28.5	129	13
	68ST30242901	3691	30	24.25	28.5	155	15
	68ST36202901	3780	36.25	20.25	28.5	151	15
	68ST36242901	3831	36.25	24.25	28.5	181	18
	68ST42202901	3896	42	20.25	28.5	174	17
	68ST42242901	3952	42	24.25	28.5	205	21
	68STCE20204217L	2694	20.25	20.25	40.5	64	13
	68STCE20204217R	2694					
	68STCE24244217L	2812	24.25	24.25	40.5	75	17.5
	68STCE24244217R	2812					
	68ST30204217	2800	30	20.25	41.75	114	18
	68ST30244217	2833	30	24.25	41.75	133	22
	68ST36204217	2896	36.25	20.25	41.75	146	21
	68ST36244217	2944	36.25	24.25	41.75	168	25

DIMENSION KEY

W - width
D - depth
H - height

*Indicates model illustrated by line drawing.

CODE DESCRIPTION

L - left handed position
R - right handed position

STANDARD FINISHES

For a complete list of standard wood finishes please see page 4.

SHELVES

Shelves are adjustable in 1.25" increments.

MILLENNIUM STORAGE

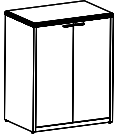
Description	Model	Cherry Maple Walnut			W	D	H	Shipping Weight	Cubic Feet
	68ST30204211	3122	30	20.25	41.75	134	15		
	68ST30244211	3192	30	24.25	41.75	153	22		
	68ST36204211	3279	36.25	20.25	41.75	166	21		
	68ST36244211	3290	36.25	24.25	41.75	188	25		

	68ST30204201	4512	30	20.25	41.75	164	18
	68ST30244201	4628	30	24.25	41.75	183	22
	68ST36204201	4759	36.25	20.25	41.75	196	21
	68ST36244201	4860	36.25	24.25	41.75	218	25

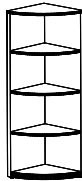
	68STCE20205417L	3070	20.25	20.25	54	117	17
	68STCE20205417R	3070	20.25	20.25	54	117	17
	68STCE24245417L	3209	24.25	24.25	54	126	23.5
	68STCE24245417R	3209	24.25	24.25	54	126	23.5

	68ST30205417	3314	30	20.25	54	175	23
	68ST30245417	3403	30	24.25	54	195	28
	68ST36205417	3481	36.25	20.25	54	195	26
	68ST36245417	3560	36.25	24.25	54	205	33

ORDERING NOTES:

Center shelf is fixed, upper and lower shelves are adjustable in increments of approximately 1-1/4".

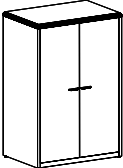
	68ST30205411	3682	30	20.25	54	185	23
	68ST30245411	3770	30	24.25	54	205	28
	68ST36205411	3849	36.25	20.25	54	205	26
	68ST36245411	3940	36.25	24.25	54	235	33

ORDERING NOTES:

Center shelf is fixed, upper and lower shelves are adjustable in increments of approximately 1-1/4".

ORDERING PROCEDURE

- To order, please specify the following:
- 1) Krug product model number
 - 2) Wood species and finish, see page 4
 - 3) Wood edge detail, see page 3
 - 4) Pull style, see page 3
 - 5) Grommet location if applicable

CODE DESCRIPTION

- L - left handed position
- R - right handed position

STANDARD FINISHES

For a complete list of standard wood finishes please see page 4.

LOCKS

Locks are available on all wood bookcase doors at \$152 list.

SHELVES

Shelves are adjustable in 1.25" increments.

MILLENNIUM STORAGE

Description	Model	Cherry Maple Walnut	Dimensions			Shipping Weight	Cubic Feet
			W	D	H		
4-Hi 2 Lateral Files & 2 Closed Shelves	68ST30205404	4352	30	20.25	54	210	23
	68ST30245404	4461	30	24.25	54	235	28
	68ST36205404	4608	36.25	20.25	54	235	26
	68ST36245404	4693	36.25	24.25	54	260	33

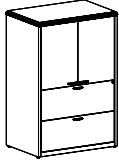

4-Hi Lateral Files	68ST30205401	5189	30	20.25	54	220	23
	68ST30245401	5315	30	24.25	54	245	28
	68ST36205401	5525	36.25	20.25	54	245	26
	68ST36245401	5640	36.25	24.25	54	270	33



5-Hi Curved Corner Storage	68STCE20206817L	3509	20.25	20.25	68.25	130	21
	68STCE20206817R	3509	20.25	20.25	68.25	130	21
	68STCE24246817L	3663	24.25	24.25	68.25	138	29
	68STCE24246817R	3663	24.25	24.25	68.25	138	29

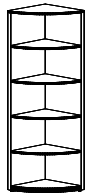

5-Hi Single Width Closed Shelves	68ST18246811L*	3636	18	24.25	68.25	186	21
	68ST18246811R	3635	18	24.25	68.25	186	21

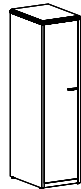

ORDERING NOTES:

Second lowest shelf is fixed, upper and lower shelves are adjustable in increments of approximately 1-1/4".

5 Open Shelves	68ST30206817	4331	30	20.25	68.25	200	29
	68ST30246817	4415	30	24.25	68.25	210	35
	68ST36206817	4443	36.25	20.25	68.25	210	34
	68ST36246817	4544	36.25	24.25	68.25	220	40

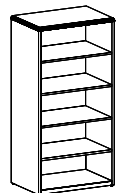

ORDERING NOTES:

Second lowest shelf is fixed, upper and lower shelves are adjustable in increments of approximately 1-1/4".

DIMENSION KEY

W - width
D - depth
H - height

*Indicates model illustrated by line drawing.

CODE DESCRIPTION

L - hinged left
R - hinged right

STANDARD FINISHES

For a complete list of standard wood finishes please see page 4.

LOCKS

Locks are available on all wood bookcase doors at \$152 list.

SHELVES

Shelves are adjustable in 1.25" increments.

MILLENNIUM STORAGE

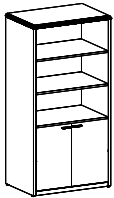
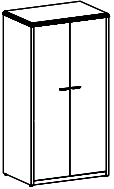
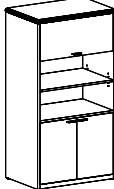
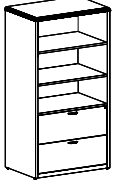
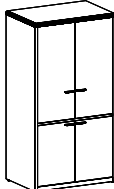
Description	Model	Cherry Maple Walnut				Shipping Weight	Cubic Feet
			W	D	H		
5-Hi 2 Closed, 3 Open Shelves 	68ST30206813	4634	30	20.25	68.25	210	29
	68ST30246813	4712	30	24.25	68.25	220	35
	68ST36206813	4795	36.25	20.25	68.25	220	34
	68ST36246813	4869	36.25	24.25	68.25	230	40
5 Closed Shelves 	68ST30206811	5091	30	20.25	68.25	220	29
	68ST30246811	5155	30	24.25	68.25	230	35
	68ST36206811	5231	36.25	20.25	68.25	230	34
	68ST36246811	5299	36.25	24.25	68.25	240	40
5-Hi 2 Closed Shelves, 2 Open & 1 Flip Up Door 	68ST30206812	5398	30	20.25	68.25	215	29
	68ST30246812	5437	30	24.25	68.25	225	35
	68ST36206812	5483	36.25	20.25	68.25	225	34
	68ST36246812	5556	36.25	24.25	68.25	235	40
5-Hi 2 Lateral Files & 3 Open Shelves 	68ST30206803	5524	30	20.25	68.25	190	29
	68ST30246803	5593	30	24.25	68.25	200	35
	68ST36206803	5661	36.25	20.25	68.25	200	34
	68ST36246803	5733	36.25	24.25	68.25	210	40
5-Hi 2 Closed Shelves & 3 Closed Shelves - Pocket Doors 	68ST30206828	5590	30	20.25	68.25	230	29
	68ST30246828	5748	30	24.25	68.25	280	35
	68ST36206828	5870	36.25	20.25	68.25	280	34
	68ST36246828	6012	36.25	24.25	68.25	340	40

ORDERING PROCEDURE

To order, please specify the following:

- 1) Krug product model number
- 2) Wood species and finish, see page 4
- 3) Wood edge detail, see page 3
- 4) Pull style, see page 3
- 5) Grommet location if applicable

STANDARD FINISHES

For a complete list of standard wood finishes please see page 4.

LOCKS

Locks are available on all wood bookcase doors at \$152 list.

SHELVES

Shelves are adjustable in 1.25" increments.

MILLENNIUM STORAGE

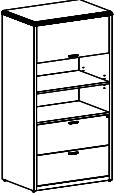
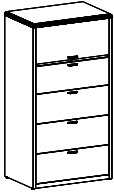
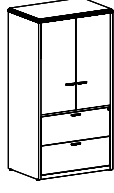
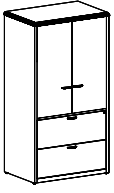
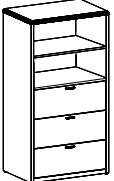
Description	Model	Cherry Maple Walnut		W	D	H	Shipping Weight	Cubic Feet
 5-Hi 2 Lateral Files, 2 Open Shelves & 1 Flip-Up Door	68ST30206802	5809		30	20.25	68	210	29
	68ST30246802	5844		30	24.25	68	220	35
	68ST36206802	5972		36.25	20.25	68	220	34
	68ST36246802	6045		36.25	24.25	68	230	40
 5-Hi 4 Lateral Files & 1 Flip-Up Storage	68ST30206801	6074		30	20.25	68	250	29
	68ST30246801	6478		30	24.25	68	300	35
	68ST36206801	6877		36.25	20.25	68	300	34
	68ST36246801	6962		36.25	24.25	68	360	40
 5-Hi 2 Lateral Files & 3 Closed Shelves	68ST30206804	6185		30	20.25	68.25	213	29
	68ST30246804	6246		30	24.25	68.25	255	35
	68ST36206804	6322		36.25	20.25	68.25	255	34
	68ST36246804	6394		36.25	24.25	68.25	306	40
 5-Hi 2 Lateral Files & 3 Closed Shelves -Pocket Doors	68ST30206827	6703		30	20.25	68.25	241	29
	68ST30246827	6835		30	24.25	68.25	291	35
	68ST36206827	6978		36.25	20.25	68.25	291	34
	68ST36246827	7114		36.25	24.25	68.25	350	40
 5-Hi 3 Lateral Files & 2 Open Shelves	68ST30206806	6720		30	20.25	68.25	188	29
	68ST30246806	6807		30	24.25	68.25	225	35
	68ST36206806	6881		36.25	20.25	68.25	225	34
	68ST36246806	6939		36.25	24.25	68.25	270	40

DIMENSION KEY

W - width
D - depth
H - height

STANDARD FINISHES

For a complete list of standard wood finishes please see page 4.

LOCKS

Locks are available on all wood bookcase doors at \$152 list.

SHELVES

Shelves are adjustable in 1.25" increments.

MILLENNIUM STORAGE

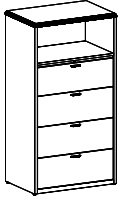
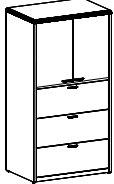
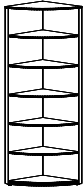
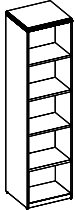
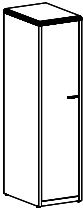
Description	Model	Cherry	W	D	H	Shipping	Cubic
		Maple Walnut					
 5-Hi 4 Lateral Files & 1 Open Shelf	68ST30206805	6793	30	20.25	68.25	240	29
	68ST30246805	6831	30	24.25	68.25	290	35
	68ST36206805	6945	36.25	20.25	68.25	290	34
	68ST36246805	7042	36.25	24.25	68.25	350	40
 5-Hi 3 Lateral Files & 2 Closed Shelves	68ST30206808	7041	30	20.25	68.25	220	29
	68ST30246808	7182	30	24.25	68.25	230	35
	68ST36206808	7331	36.25	20.25	68.25	230	34
	68ST36246808	7474	36.25	24.25	68.25	240	40
 6-Hi Curved Corner Storage	68STCE20208417L	3948	20.25	20.25	82.25	150	25.5
	68STCE20208417R	3948	20.25	20.25	82.25	150	25.5
	68STCE24248417L	4130	24.25	24.25	82.25	159	35
	68STCE24248417R	4130	24.25	24.25	82.25	159	35
 6 Open Shelves	68ST18208417	3516	18	20.25	84	168	22
	68ST18248417	4029	18	24.25	84	188	26
 6 Closed Shelves	68ST18208411L*	4065	18	20.25	84	185	22
	68ST18208411R	4065	18	20.25	84	185	22
	68ST18248411L	4179	18	20.25	84	195	26
	68ST18248411R	4179	18	20.25	84	195	26

ORDERING NOTES:

Second lowest shelf is fixed, upper and lower shelves are adjustable in increments of approximately 1-1/4".

ORDERING PROCEDURE

- To order, please specify the following:
- 1) Krug product model number
 - 2) Wood species and finish, see page 4
 - 3) Wood edge detail, see page 3
 - 4) Pull style, see page 3
 - 5) Grommet location if applicable

*Indicates model illustrated by line drawing.

CODE DESCRIPTION

- L - hinged left
- R - hinged right

STANDARD FINISHES

For a complete list of standard wood finishes please see page 4.

LOCKS

Locks are available on all wood bookcase doors at \$152 list.

SHELVES

Shelves are adjustable in 1.25" increments.

MILLENNIUM STORAGE

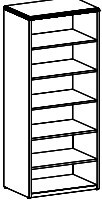
Description	Model	Cherry Maple Walnut				Shipping Weight	Cubic Feet
			W	D	H		
6 Hi Open Shelves 	68ST30208417	5810	30.5	20.25	84	173	34
	68ST30248417	5889	30.5	24.25	84	208	40
	68ST36208417	5850	36	20.25	84	208	40
	68ST36248417	5962	36	24.25	84	250	47

ORDERING NOTES:

Second lowest shelf is fixed, upper and lower shelves are adjustable in increments of approximately 1-1/4".

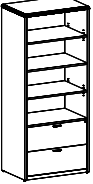
6-Hi 2 Lateral Files & 4 Open Shelves 	68ST30208403	6322	30.5	20.25	84	240	34
	68ST30248403	6412	30.5	24.25	84	250	40
	68ST36208403	6385	36	20.25	84	250	40
	68ST36248403	6480	36	24.25	84	270	47

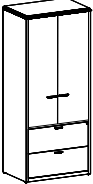
6-Hi 2 Lateral Files & 4 Closed Shelves 	68ST30208404	6563	30.5	20.25	84	250	34
	68ST30248404	6648	30.5	24.25	84	260	40
	68ST36208404	6620	36	20.25	84	260	40
	68ST36248404	6725	36	24.25	84	280	47

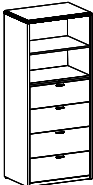
6-Hi 4 Lateral Files & 2 Open Shelves 	68ST30208405	6854	30.5	20.25	84	257	34
	68ST30248405	6940	30.5	24.25	84	308	40
	68ST36208405	6895	36	20.25	84	308	40
	68ST36248405	7021	36	24.25	84	370	47

DIMENSION KEY

W - width
D - depth
H - height

STANDARD FINISHES

For a complete list of standard wood finishes please see page 4.

LOCKS

Locks are available on all wood bookcase doors at \$152 list.

SHELVES

Shelves are adjustable in 1.25" increments.

MILLENNIUM WARDROBES

Description	Model	Cherry Maple Walnut				Shipping Weight	Cubic Feet
			W	D	H		
Single Width Wardrobe	68WR18246802L*	3134	18	24.25	68.25	150	21
	68WR18246802R	3134	18	24.25	68.25	150	21

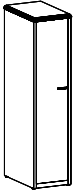

Full Width Wardrobe	68WR30246802	4420	30.5	24.25	68.25	217	35
	68WR36246802	4652	36	24.25	68.25	265	40

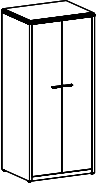

Wardrobe & Closed Shelves	68WR30246801	4796	30.5	24.25	68.25	237	35
	68WR36246801	4988	36	24.25	68.25	285	40

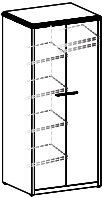

ORDERING PROCEDURE

To order, please specify the following:

- 1) Krug product model number
- 2) Wood species and finish, see page 4
- 3) Wood edge detail, see page 3
- 4) Pull style, see page 3
- 5) Grommet location if applicable

*Indicates model illustrated by line drawing.

CODE DESCRIPTION

L - hinged left
R - hinged right

STANDARD FINISHES

For a complete list of standard wood finishes please see page 4.

LOCKS

Locks are available on all wood bookcase doors at \$152 list. 24", 30" & 36" wardrobes require 2 locks.

SHELVES

Shelves are adjustable in 1.25" increments.

MILLENNIUM MODULAR TOPS

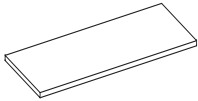
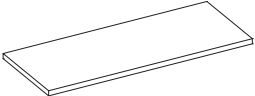
Description	Model	Cherry Maple Walnut	W	D	H	Shipping Weight	Cubic Feet
Modular Tops 	68TP6020	1088	59.75	20	"-"	41.5	4
	68TP6620	1381	65.75	20	"-"	44.5	4.5
	68TP7120	1579	71.75	20	"-"	47.5	4.75
	68TP7820	1724	77.75	20	"-"	59	5.25
	68TP8420	1811	83.75	20	"-"	63	6
	68TP9620	2084	95.75	20	"-"	69	5
	68TP3624	916	35.75	24	"-"	31.5	2.25
	68TP4224	962	41.75	24	"-"	35.5	2.25
	68TP4824	1012	47.75	24	"-"	39.5	3.75
	68TP5424	1061	53.75	24	"-"	43.5	3.5
	68TP6024	1163	59.75	24	"-"	47.5	4.75
	68TP6624	1429	65.75	24	"-"	51.5	5.25
	68TP7124	1632	71.75	24	"-"	55.5	5.5
	68TP7824	1777	77.75	24	"-"	68	6
	68TP8424	1861	83.75	24	"-"	72	7
	68TP9024	1641	89.75	24	"-"	76	5
	68TP9624	2139	95.75	24	"-"	79	5
	68TP3630	1032	35.75	30	"-"	37.5	2.75
	68TP4230	1081	41.75	30	"-"	42.5	2.75
	68TP4830	1135	47.75	30	"-"	47.5	2.5
	68TP5430	1201	53.75	30	"-"	52.5	4.25
	68TP6030	1378	59.75	30	"-"	57.5	3.25
	68TP6630	1480	65.75	30	"-"	62.5	3.5
	68TP7130	1676	71.75	30	"-"	67.5	3.75
	68TP7830	1832	77.75	30	"-"	80	4.25
	68TP8430	1914	83.75	30	"-"	85	4
	68TP9030	2056	89.75	30	"-"	90	5.75
	68TP9630	2205	95.75	30	"-"	95	5.75
	68TP3636	1240	35.75	36	"-"	43.5	3.25
	68TP4236	1295	41.75	36	"-"	49.5	3.25
	68TP4836	1360	47.75	36	"-"	55.5	3
	68TP5436	1441	53.75	36	"-"	61.5	3.25
	68TP6036	1524	59.75	36	"-"	67.5	3.75
	68TP6636	1673	65.75	36	"-"	72.5	4
	68TP7136	1827	71.75	36	"-"	78.5	4.25
68TP7836	2196	77.75	36	"-"	93	5	
68TP8436	2301	83.75	36	"-"	99	6.5	
68TP9036	2463	89.75	36	"-"	105	6.75	
68TP9636	2641	95.75	36	"-"	111	6.75	
Modular Return Tops 	68TPR4220L	843	41.75	20	-	31.5	2.25
	68TPR4220R	843	41.75	20	-	31.5	2.25
	68TPR4820L	871	47.75	20	-	34.5	2.5
	68TPR4820R	871	47.75	20	-	34.5	2.5

DIMENSION KEY

W - width
D - depth
H - height

CODE DESCRIPTION

L - left handed
R - right handed

STANDARD FINISHES

For a complete list of standard wood finishes please see page 4. Standard Laminate work-surfaces are available at a 10% upcharge.

MILLENNIUM MODULAR TOPS

Description	Model	Cherry Maple Walnut	W	D	H	Shipping Weight	Cubic Feet
Modular Return Tops	68TPR3624L	916	35.75	24	-	31.5	2.25
-continued	68TPR3624R	916	35.75	24	-	31.5	2.25
	68TPR4224L	962	41.75	24	-	35.5	2.75
	68TPR4224R	962	41.75	24	-	35.5	2.75
	68TPR4824L	915	47.75	24	-	39.5	3
	68TPR4824R	915	47.75	24	-	39.5	3
	68TPR5424L	1128	53.75	24	-	47.5	2.5
	68TPR5424R	1128	53.75	24	-	47.5	2.5
	68TPR6024R	1163	59.75	24	-	52.5	4.25
	68TPR6024L	1163	59.75	24	-	52.5	4.25
	68TPR6624L	1369	65.75	24	-	47.5	4.75
	68TPR6624R	1369	65.75	24	-	47.5	4.75
	68TPR7124L	1560	71.75	24	-	44.5	4.5
	68TPR7124R	1560	71.75	24	-	44.5	4.5
	68TPR7824L	1573	77.75	24	-	44.5	4.5
	68TPR7824R	1573	77.75	24	-	44.5	4.5
	68TPR8424L	1875	83.75	24	-	72	4
	68TPR8424R	1875	83.75	24	-	72	4
	68TPR3630L	1032	35.75	30	-	37.5	2.75
	68TPR3630R	1032	35.75	30	-	37.5	2.75
	68TPR4230L	1081	41.75	30	-	42.5	3.25
	68TPR4230R	1081	41.75	30	-	42.5	3.25
	68TPR4830L	1135	47.75	30	-	47.5	3.25
	68TPR4830R	1135	47.75	30	-	47.5	3.25
	68TPR5430L	1201	53.75	30	-	55.5	3
	68TPR5430R	1201	53.75	30	-	55.5	3
	68TPR6030L	1288	59.75	30	-	61.5	3.25
	68TPR6030R	1288	59.75	30	-	61.5	3.25
	68TPR6630L	1480	65.75	30	-	57.5	3.25
	68TPR6630R	1480	65.75	30	-	57.5	3.25
	68TPR7130L	1676	71.75	30	-	51.5	5.25
	68TPR7130R	1676	71.75	30	-	51.5	5.25
	68TPR7830L	1691	77.75	30	-	51.5	5.25
	68TPR7830R	1691	77.75	30	-	51.5	5.25
	68TPR8430L	1914	83.75	30	-	85	4.75
	68TPR8430R	1914	83.75	30	-	85	4.75
	68TPR3636L	1240	35.75	36	-	43.5	3.25
	68TPR3636R	1240	35.75	36	-	43.5	3.25
	68TPR4236L	1295	41.75	36	-	49.5	3.75
	68TPR4236R	1295	41.75	36	-	49.5	3.75
	68TPR4836R	1360	47.75	36	-	55.5	3.75
	68TPR4836L	1360	47.75	36	-	55.5	3.75
	68TPR5436L	1441	53.75	36	-	43.5	3.5
	68TPR5436R	1441	53.75	36	-	43.5	3.5
	68TPR6036L	1524	59.75	36	-	41.5	4
	68TPR6036R	1524	59.75	36	-	41.5	4
	68TPR6636L	1357	65.75	36	-	67.5	3.75
	68TPR6636R	1357	65.75	36	-	67.5	3.75
	68TPR7136L	1827	71.75	36	-	62.5	3.5
	68TPR7136R	1827	71.75	36	-	62.5	3.5
	68TPR7836L	1860	77.75	36	-	62.5	3.5
	68TPR7836R	1860	77.75	36	-	62.5	3.5
	68TPR8436L	2301	83.75	36	-	99	5.5
	68TPR8436R	2301	83.75	36	-	99	5.5

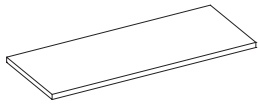

ORDERING PROCEDURE

- To order, please specify the following:
- 1) Krug product model number
 - 2) Wood species and finish, see page 4
 - 3) Wood edge detail, see page 3
 - 4) Pull style, see page 3
 - 5) Grommet location if applicable

CODE DESCRIPTION

- L - left handed
R - right handed

STANDARD FINISHES

For a complete list of standard wood finishes please see page 4. Standard Laminate work-surfaces are available at a 10% upcharge.

MILLENNIUM MODULAR PEDESTALS

Description	Model	Cherry	W	D	H	Shipping Weight	Cubic Feet
		Maple Walnut					
CPU Pedestal	68MPCPU22L	1158	15.75	22	26.75	75	6
	68MPCPU22R*	1158	15.75	22	26.75	75	6

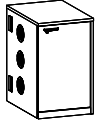

Bookcase Pedestal	68PS4BC15L*	1588	15.75	18.75	26.75	70	6
	68PS4BC15R	1592	15.75	18.75	26.75	70	6

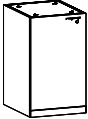

ORDERING NOTES: Modular pedestals have unfinished tops and backs, for finished back option add **\$173 list**. Locks on bookcase pedestal doors are available at **\$152 list**. Please specify at time of order.

Shallow Pedestal	68PS4D	1946	15.75	18.75	26.75	74	6
	68PS4F*	2085	15.75	18.75	26.75	76	6

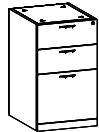

ORDERING NOTES: Modular pedestals have unfinished tops and backs, for finished back option add **\$173 list**. Locks on bookcase pedestal doors are available at **\$152 list**. Please specify at time of order.

Deep Pedestal	68PD4D*	2096	15.75	28.75	26.75	108	9
	68PD4F	2234	15.75	28.75	26.75	110	9

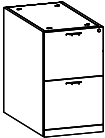

ORDERING NOTES: Modular pedestals have unfinished tops and backs, for finished back option add **\$173 list**. Please specify at time of order.

Bookcase Pedestal- Shallow	68PS4BC30	2654	30	18.75	27	114	11
	68PS4BC36	2804	35.5	18.75	27	135	13
	68PS4BC42	2954	41.5	18.75	27	158	15

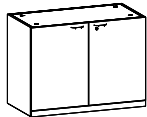

ORDERING NOTES: Modular pedestals have unfinished tops and backs, for finished back option add **\$255 list**. Locks on bookcase pedestal doors are available at **\$152 list**. Please specify at time of order.

Lateral File Pedestal - Shallow	68PS4LF30	2654	30	18.75	27	114	11
	68PS4LF36	2804	35.5	18.75	27	135	13
	68PS4LF42	2954	41.5	18.75	27	158	15

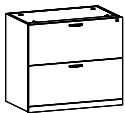

ORDERING NOTES: Modular pedestals have unfinished tops and backs, for finished back option add **\$255 list**. Please specify at time of order.

DIMENSION KEY

W - width
D - depth
H - height

*Indicates model illustrated by line drawing.

CODE DESCRIPTION

4 - full height pedestal
L - hinged left
R - hinged right
D - 2 file drawer
F - 2 box, 1 file drawer
LF- lateral file
BC - bookcase

STANDARD FINISHES

For a complete list of standard wood finishes please see page 4.

MILLENNIUM MODULAR - PEDESTALS

Description	Model	Cherry Maple Walnut	W	D	H	Shipping Weight	Cubic Feet
36" File/Lateral File Pedestal	68PLF36192901	3078	35.5	18.75	27	117	13



ORDERING NOTES: Modular pedestals have unfinished tops and backs, for finished back option add **\$255 list**. Please specify at time of order. Only lower lateral file drawer locks.

36" Combination Pedestal	68PLF36192902*	3142	35.5	18.75	27	117	13
	68PLF36192904	3142	35.5	18.75	27	117	13



ORDERING NOTES: Modular pedestals have unfinished tops and backs, for finished back option add **\$255 list**. Please specify at time of order. Only lower lateral file drawer locks.

Ganged Pedestal	68PS4DD	3754	31.5	18.75	26.75	148	12
	68PS4DF	3929	31.5	18.75	26.75	152	12
	68PS4FD*	3919	31.5	18.75	26.75	150	12
	68PS4FF	4045	31.5	18.75	26.75	152	12



ORDERING NOTES: Modular pedestals have unfinished tops and backs, for finished back option add **\$255 list**. Please specify at time of order.

Open Shell, Accepts Deep Pedestals	68S3630	2412	36.25	30.25	28.5	33.5	110	21
	68S4230	2533	42	30.25	28.5	39.25	129	25
	68S4830	2629	48	30.25	28.5	44.75	147	29
	68S6030	2734	63.5	30.25	28.5	56.75	182	36
	68S6630	2838	65.75	30.25	28.5	62.75	200	39
	68S6636	2970	65.75	36.25	28.5	62.75	240	46
	68S7130	3127	71	30.25	28.5	68	215	42
	68S7136	3277	71	36.25	28.5	68	255	50
	68S8430	3441	82.75	30.25	28.5	81	342	50
	68S8436	3669	84	36.25	28.5	81	285	59
	68S9030	3829	90	30.25	28.5	87	255	53
	68S9630	4061	93.5	30.25	28.5	92.75	272	56
	68S10230	4291	102	30.25	28.5	99.25	276	60

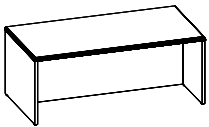

ORDERING NOTES: The pencil drawer can not be used in the 20" deep knee hole credenzas and/or shells. Please see page 7 for wire management cut-out option. Please see page 6 for hinged modesty panel option.

Half Gable	68HG2716	507	16	27	27	16	1
------------	----------	-----	----	----	----	----	---

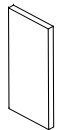

ORDERING NOTES: This unit should be ordered to center-support open spans greater than 60".

ORDERING PROCEDURE

- To order, please specify the following:
- 1) Krug product model number
 - 2) Wood species and finish, see page 4
 - 3) Wood edge detail, see page 3
 - 4) Pull style, see page 3
 - 5) Grommet location if applicable

*Indicates model illustrated by line drawing.

CODE DESCRIPTION

- 4 - full height pedestal
- D - 2 file drawers
- F - 2 box, 1 file drawer

STANDARD FINISHES

For a complete list of standard wood finishes please see page 4. Standard Laminate work-surfaces are available at a 10% upcharge.

GROMMETS

One grommet in standard position is optional at no charge. Additional grommets are available at an upcharge of **\$152 List**.

MILLENNIUM MOBILE

Description	Model	Cherry	W	D	H	Shipping	Cubic
		Maple Walnut					
	68MPD4D	2241	15.75	28.75	26.75	108	9
	68MPD4F*	2383	15.75	28.75	26.75	110	9
	68MPS4D	2076	15.75	18.75	26.75	74	6
	68MPS4F	2215*	15.75	18.75	26.75	76	6

ORDERING NOTES:

Mobile pedestals have finished tops and backs. Please see page 7 for upholstered seat option.

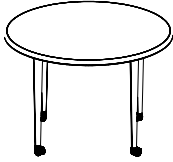
Description	Model	Cherry Maple Walnut	W	D	H	Shipping	Cubic
	68MTH36D	1609	36.25	36.25	28.5	69	6
	68MTH42D	1618	42.25	42.25	28.5	75	8

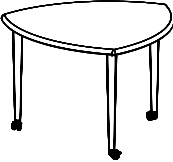
Description	Model	Cherry Maple Walnut	W	D	H	Shipping	Cubic
	68MDTH32	1704	31.25	32	28.5	50	5
	68MDTH36	1720	35	35.75	28.5	57	6
	68MDTH42	1731	41	41.75	28.5	71	8

Description	Model	Cherry Maple Walnut	W	D	H	Shipping	Cubic
	68MATH3030	1594	30.25	30.25	28.5	60	4.5
	68MATH3636	1609	36.25	36.25	28.5	75	6
	68MATH4242	1618	42.25	42.25	28.5	90	8

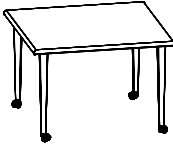
Description	Model	Cherry Maple Walnut	W	D	H	Shipping	Cubic
	68MTH3030	1594	30.25	30.25	28.5	65	4.5
	68MTH3636	1609	36.25	36.25	28.5	80	6
	68MTH4242	1618	42.25	42.25	28.5	97	8

DIMENSION KEY

W - width
D - depth
H - height

*Indicates model illustrated by line drawing.

STANDARD FINISHES

For a complete list of standard wood finishes please see page 4. Standard Laminate work-surfaces are available at a 10% upcharge.

MILLENNIUM MOBILE

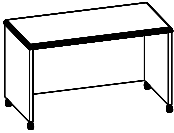
Description	Model	Cherry Maple Walnut	W	D	H	Shipping Weight	Cubic Feet
	68THC3020	2385	30	20.25	28.5	61	12
	68THC3024	2406	30	24.25	28.5	73	15
	68THC3620	2417	36.25	20.25	28.5	73	15
	68THC3624	2440	36.25	24.25	28.5	88	18
	68THC4220	2461	42	20.25	28.5	86	18
	68THC4224	2453	42	24.25	28.5	103	21
	68THC4820	2480	48	20.25	28.5	98	21
	68THC4824	2502	48	24.25	28.5	118	23

ORDERING NOTES: Optional paper slot in "C" position at \$172 list upcharge.

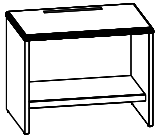
Description	Model	Cherry Maple Walnut	W	D	H	Shipping Weight	Cubic Feet
	68PT3024	2613	30.25	24.25	28.5	76	15
	68PT3624	2697	36.25	24.25	28.5	103	18
	68PT3630	2780	36.25	30.25	28.5	103	22

ORDERING NOTES: Optional paper slot in "C" position at \$172 list upcharge. Casters optional for \$172 list upcharge.

ORDERING PROCEDURE

- To order, please specify the following:
- 1) Krug product model number
 - 2) Wood species and finish, see page 4
 - 3) Wood edge detail, see page 3
 - 4) Pull style, see page 3
 - 5) Grommet location if applicable

STANDARD FINISHES

For a complete list of standard wood finishes please see page 4. Standard Laminate work-surfaces are available at a 10% upcharge.

MILLENNIUM RECEPTION

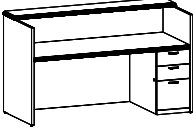
Description	Model	Cherry Maple Walnut	W	D	H	KW	Shipping Weight	Cubic Feet
Reception Desk, Full Height Pedestals 	68GD60304LFRF	7175	60	30	28.5	27.5	270	44
	68GD60304LORF	6017	60	30	28.5	42.5	270	44
	68GD60304LFR0	6017	60	30	28.5	42.5	270	44
	68GD66304LFRF	7335	65.75	30	28.5	33.25	290	48
	68GD66304LORF	6224	65.75	30	28.5	48.25	290	48
	68GD66304LFR0	6200	65.75	30	28.5	48.25	290	48
	68GD72304LFRF	7448	72.75	30	28.5	40	310	51
	68GD72304LORF*	6271	72.25	30	28.5	54.75	310	51
	68GD72304LFR0	6271	72.75	30	28.5	54.75	310	51
	68GD84304LFRF	7586	84	30	28.5	51.5	330	61
	68GD84304LORF	6360	84	30	28.5	66.5	330	61
	68GD84304LFR0	6360	84	30	28.5	66.5	330	61
	68GD96304LFRF	7818	95.75	30	28.5	63.25	350	69
	68GD96304LORF	6730	95.75	30	28.5	78.25	350	69
	68GD96304LFR0	6730	95.75	30	28.5	78.25	350	69

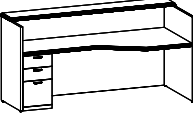
Description	Model	Cherry Maple Walnut	W	D	H	KW	Shipping Weight	Cubic Feet
Reception Corner Desk with Full Height Pedestals 	68GCD7124L4F	6184	72.5	36.25	28.5	54.75	280	54
	68GCD7124L4D	6184	72.5	36.25	28.5	54.75	280	54
	68GCD7124R4F	6184	72.5	36.25	28.5	54.75	280	54
	68GCD7124R4D	6184	72.5	36.25	28.5	54.75	280	54
	68GCD8424L4F*	6364	84	36.25	28.5	66.5	310	64
	68GCD8424L4D	6364	84	36.25	28.5	66.5	310	64
	68GCD8424R4F	6364	84	36.25	28.5	66.5	310	64
	68GCD8424R4D	6364	84	36.25	28.5	66.5	310	64
	68GCD9624L4F	6757	95.75	36.25	28.5	78.25	330	73
	68GCD9624L4D	6757	95.75	36.25	28.5	78.25	330	73
	68GCD9624R4F	6757	95.75	36.25	28.5	78.25	330	73
	68GCD9624R4D	6757	95.75	36.25	28.5	78.25	330	73

ORDERING NOTES: Optional reveals are available at an upcharge of **\$290 list** per running foot of surface area.

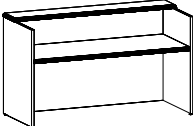
Description	Model	Cherry Maple Walnut	W	D	H	KW	Shipping Weight	Cubic Feet
Reception Desk Shell 	68GDS6630	4022	65.25	30	28.5	63	235	45
	68GDS7130	4114	70.5	30	28.5	69.75	250	48
	68GDS8430	4230	83.5	30	28.5	81.25	275	58
	68GDS9630	4350	95.5	30	28.5	93	295	66

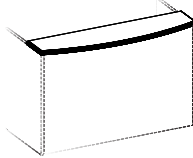
Description	Model	Cherry Maple Walnut
Bow Shaped Transaction Top Option 	BT60	212
	BT66	217
	BT72	220
	BT84	247
	BT96*	282

DIMENSION KEY

W - width
D - depth
H - height

*Indicates model illustrated by line drawing.

CODE DESCRIPTION

0 - no pedestal
4 - full height pedestal
L - left handed pedestal position
R - right handed pedestal position
D - 2 file drawer
F - 2 box, 1 file drawer

STANDARD FINISHES

For a complete list of standard wood finishes please see page 4. Standard Laminate work-surfaces are available at a 10% upcharge.

MILLENNIUM RECEPTION

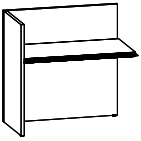
Description	Model	Cherry		W	D	H	KW	Shipping Weight	Cubic Feet	
		Maple	Walnut							
 Reception Return, Desk Height with Full Height Pedestals	68GRH3624L4D	3668		36.25	24.25	28.5	20	154	25	
	68GRH3624L4F	3668		36.25	24.25	28.5	20	154	25	
	68GRH3624R4D	3668		36.25	24.25	28.5	20	154	25	
	68GRH3624R4F	3668		36.25	24.25	28.5	20	154	25	
	68GRH4224L4D	3885		42.5	24.25	28.5	26.5	176	29	
	68GRH4224L4F*	3885		42.5	24.25	28.5	26.5	176	29	
	68GRH4224R4D	3885		42.5	24.25	28.5	26.5	176	29	
	68GRH4224R4F	3885		42.5	24.25	28.5	26.5	176	29	
	68GRH4824L4D	3996		48.5	24.25	28.5	32.25	202	33	
	68GRH4824L4F	3996		48.5	24.25	28.5	32.25	202	33	
	68GRH4824R4D	3996		48.5	24.25	28.5	32.25	202	33	
	68GRH4824R4F	3996		48.5	24.25	28.5	32.25	202	33	
	68GRH5424L4D	4084		54.25	24.25	28.5	38	224	37	
	68GRH5424L4F	4084		54.25	24.25	28.5	38	224	37	
	68GRH5424R4D	4084		54.25	24.25	28.5	38	224	37	
	68GRH5424R4F	4084		54.25	24.25	28.5	38	224	37	
	68GRH6024L4D	4167		60	24.25	28.5	44	245	41	
	68GRH6024L4F	4167		60	24.25	28.5	44	245	41	
	68GRH6024R4D	4167		60	24.25	28.5	44	245	41	
	68GRH6024R4F	4167		60	24.25	28.5	44	245	41	
	68GRH6624L4D	4261		66.25	24.25	28.5	54	269	46	
	68GRH6624L4F	4261		66.25	24.25	28.5	54	269	46	
	68GRH6624R4D	4261		66.25	24.25	28.5	54	269	46	
	68GRH6624R4F	4261		66.25	24.25	28.5	54	269	46	
	68GRH7124L4D	4397		72	24.25	28.5	59	292	50	
	68GRH7124L4F	4397		72	24.25	28.5	59	292	50	
	68GRH7124R4D	4397		72	24.25	28.5	59	292	50	
	68GRH7124R4F	4397		72	24.25	28.5	59	292	50	
	 Open Reception Return, Desk Height	68GRH3620L	2028		36.25	20.25	28.5	35	102	21
		68GRH3620R	2028		36.25	20.25	28.5	35	102	21
68GRH3624L		2059		36.25	24.25	28.5	35	122	25	
68GRH3624R		2059		36.25	24.25	28.5	35	122	25	
68GRH4220L*		2091		42.5	20.25	28.5	41	120	25	
68GRH4220R		2091		42.5	20.25	28.5	41	120	25	
68GRH4224L		2121		42.5	24.25	28.5	41	144	29	
68GRH4224R		2121		42.5	24.25	28.5	41	144	29	
68GRH4820L		2145		48.5	20.25	28.5	47	142	28	
68GRH4820R		2145		48.5	20.25	28.5	47	142	28	
68GRH4824L		2173		48.5	24.25	28.5	47	170	33	
68GRH4824R		2173		48.5	24.25	28.5	47	170	33	
68GRH5420L		2212		54.25	20.25	28.5	53	160	32	
68GRH5420R		2212		54.25	20.25	28.5	53	160	32	
68GRH5424L		2241		54.25	24.25	28.5	53	192	37	
68GRH5424R		2241		54.25	24.25	28.5	53	192	37	
68GRH6020L		2266		60	20.25	28.5	58.75	178	41	
68GRH6020R		2266		60	20.25	28.5	58.75	178	41	
68GRH6024L		2268		60	24.25	28.5	58.75	213	41	
68GRH6024R		2268		60	24.25	28.5	58.75	213	41	
68GRH6620L		2304		66.25	20.25	28.5	65	198	39	
68GRH6620R	2304		66.25	20.25	28.5	65	198	39		
68GRH6624L	2359		66.25	24.25	28.5	65	237	46		
68GRH6624R	2359		66.25	24.25	28.5	65	237	46		
68GRH7120L	2387		72	20.25	28.5	70.75	217	42		
68GRH7120R	2387		72	20.25	28.5	70.75	217	42		
68GRH7124L	2430		72	24.25	28.5	70.75	260	50		
68GRH7124R	2430		72	24.25	28.5	70.75	260	50		

ORDERING PROCEDURE

To order, please specify the following:

- 1) Krug product model number
- 2) Wood species and finish, see page 4
- 3) Wood edge detail, see page 3
- 4) Pull style, see page 3
- 5) Grommet location if applicable

*Indicates model illustrated by line drawing.

CODE DESCRIPTION

- 4 - full height pedestal
- D - 2 file drawers
- F - 2 box, 1 file drawer
- L - left handed pedestal position
- R - right handed pedestal position

STANDARD FINISHES

For a complete list of standard wood finishes please see page 4. Standard Laminate work-surfaces are available at a 10% upcharge.

MILLENNIUM RECEPTION

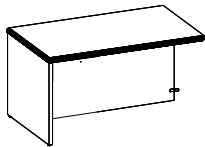
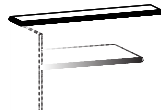
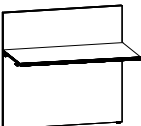
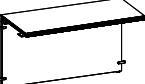
Description	Model	Cherry Maple Walnut	W	D	H	KW	Shipping Weight	Cubic Feet
 Open Return, Desk Height for Reception Unit	"68RHD2024L	2018	20	24.25	28.5	18.75	50	11
	68RHD2024R	2018	20	24.25	28.5	18.75	50	11
	68RHD2424L	2064	24	24.25	28.5	22.75	55	13
	68RHD2424R	2064	24	24.25	28.5	22.75	55	13
	68RHD3024L	2113	30	24.25	28.5	28.5	60	15
	68RHD3024R	2113	30	24.25	28.5	28.5	60	15
	68RHD3624L	2176	36	24.25	28.5	34.5	67	18
	68RHD3624R	2176	36	24.25	28.5	34.5	67	18
	68RHD4224L*	2205	42	24.25	28.5	40.5	75	21
	68RHD4224R	2205	42	24.25	28.5	40.5	75	21
	68RHD4824L	2256	48	24.25	28.5	46.5	82	23
	68RHD4824R	2256	48	24.25	28.5	46.5	82	23
	68RHD5424L	2302	54	24.25	28.5	52.5	90	26
	68RHD5424R	2302	54	24.25	28.5	52.5	90	26
	68RHD6024L	2366	60	24.25	28.5	58.5	97	29
	68RHD6024R	2366	60	24.25	28.5	58.5	97	29
	68RHD6624L	2421	65.75	24.25	28.5	64.5	105	32
	68RHD6624R	2421	65.75	24.25	28.5	64.5	105	32
	68RHD7124L	2486	71	24.25	28.5	69.5	113	34
	68RHD7124R	2486	71	24.25	28.5	69.5	113	34
68RHD8424L	2577	84	24.25	28.5	82.75	120	40	
68RHD8424R	2577	84	24.25	28.5	82.75	120	40	
 Reception Return Transaction Top	68GRT60	1103	60.5	12	"-"	25	1	
	68GRT66	1163	66.5	12	"-"	35	1	
	68GRT71	1228	72.5	12	"-"	45	2	
	68GRT78	1305	78.5	12	"-"	48	2.5	
	68GRT84	1380	84.5	12	"-"	53	3	
	68GRT90	1440	90	12	"-"	56	3	
 Reception Linking Unit, Desk Height	68GLU3624H	2010	35.25	24.25	28.5		90	24
	68GLU4224H	2105	41.5	24.25	28.5		100	28
	68GLU4824H	2215	47.5	24.25	28.5		110	32
	68GLU6024H	2508	59.5	24.25	28.5		130	41
	68GLU6624H	2586	65.25	24.25	28.5		140	45
	68GLU7124H	2686	70.5	24.25	28.5		150	49
 Linking Unit, Desk Height	68LUD3024HL	1828	29.75	24.25	28.5		57	6
	68LUD3024HR	1828	29.75	24.25	28.5		57	6
	68LUD3624HL	1861	35.75	24.25	28.5		68	7
	68LUD3624HR	1861	35.75	24.25	28.5		68	7
	68LUD4224HL	2004	41.75	24.25	28.5		82	8
	68LUD4224HR	2004	41.75	24.25	28.5		82	8
	68LUD4824HL	2051	47.75	24.25	28.5		97	9
	68LUD4824HR	2051	47.75	24.25	28.5		97	9
	68LUD5424HL	2122	54.5	24.25	28.5		111	10
	68LUD5424HR	2122	54.5	24.25	28.5		111	10
	68LUD6024HL	2148	59.75	24.25	28.5		123	11
	68LUD6024HR	2148	59.75	24.25	28.5		123	11
	68LUD6624HL	2185	65.5	24.25	28.5		137	12
	68LUD6624HR	2185	65.5	24.25	28.5		137	12
68LUD7124HL	2219	70.75	24.25	28.5		148	13	
68LUD7124HR	2219	70.75	24.25	28.5		148	13	

ORDERING NOTE: Reception Return Transaction Top is designed to be used with a 42" return.area.

DIMENSION KEY

W - width
D - depth
H - height

*Indicates model illustrated by line drawing.



CODE DESCRIPTION

L - left handed pedestal position
R - right handed pedestal position

STANDARD FINISHES

For a complete list of standard wood finishes please see page 4. Standard Laminate work-surfaces are available at a 10% upcharge.

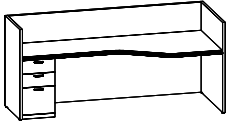
MILLENNIUM DESKS

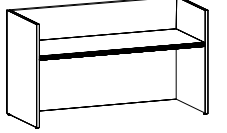
Description	Model	Cherry Maple Walnut	W	D	H	KW	Shipping		
							Weight	Cubic Feet	
	Reception Corner	68GCC7124L4F	5443	71.75	36.25	28.5	54.75	270	54
	Credenza with Full Height Pedestal	68GCC7124R4F	5443	71.75	36.25	28.5	54.75	270	54
	68GCC7124L4D	5443	71.75	36.25	28.5	54.75	270	54	
	68GCC7124R4D	5443	71.75	36.25	28.5	54.75	270	54	
	68GCC8424L4F	6039	83.5	36.25	28.5	66.5	290	54	
	68GCC8424R4F	6039	83.5	36.25	28.5	66.5	290	54	
	68GCC8424L4D	6039	83.5	36.25	28.5	66.5	290	54	
	68GCC8424R4D	6039	83.5	36.25	28.5	66.5	290	54	
	68GCC9024L4F*	6183	89.5	36.25	28.5	72.5	300	64	
	68GCC9024R4F	6183	89.5	36.25	28.5	72.5	300	64	
	68GCC9024L4D	6183	89.5	36.25	28.5	72.5	300	64	
	68GCC9024R4D	6183	89.5	36.25	28.5	72.5	300	64	
	68GCC9624L4F	6985	95.25	36.25	28.5	78.25	310	69	
	68GCC9624R4F	6985	95.25	36.25	28.5	78.25	310	69	
	68GCC9624L4D	6985	95.25	36.25	28.5	78.25	310	69	
	68GCC9624R4D	6985	95.25	36.25	28.5	78.25	310	69	
	Reception Open Corner Credenza	68GCC6624L	4005	65.25	36.25	28.5	63	250	69
	68GCC6624R	4005	65.25	36.25	28.5	63	250	69	
	68GCC7124L	4084	71.75	36.25	28.5	69.75	260	73	
	68GCC7124R	4084	71.75	36.25	28.5	69.75	260	73	
	68GCC8424L*	4131	83.5	36.25	28.5	81.25	270	73	
	68GCC8424R	4131	83.5	36.25	28.5	81.25	270	73	
	68GCC9624L	4378	85.25	36.25	28.5	93	290	73	
	68GCC9624R	4378	85.25	36.25	28.5	93	290	73	
	Reception Credenza Shell	68GCS6624	3489	65.25	24.25	28.5	63	235	45
	68GCS7124	3587	71.75	24.25	28.5	69.75	255	47	
	68GCS8424*	3631	83.5	24.25	28.5	81.25	275	58	
	68GCS9624	3773	95.25	24.25	28.5	93	295	66	

ORDERING NOTE: Optional reveals are available at an upcharge of \$290 list per running foot of surface area.

ORDERING PROCEDURE

- To order, please specify the following:
- 1) Krug product model number
 - 2) Wood species and finish, see page 4
 - 3) Wood edge detail, see page 3
 - 4) Pull style, see page 3
 - 5) Grommet location if applicable

*Indicates model illustrated by line drawing.

CODE DESCRIPTION

- 4 - full height pedestal
- D - 2 file drawers
- F - 2 box, 1 file drawer
- L - left handed pedestal position
- R - right handed pedestal position

STANDARD FINISHES

For a complete list of standard wood finishes please see page 4. Standard Laminate work-surfaces are available at a 10% upcharge.

MILLENNIUM POWERPORTS

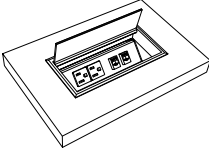
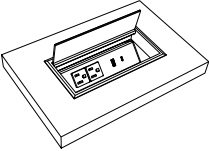
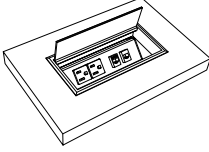
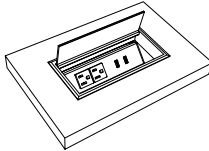
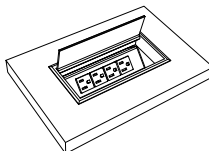
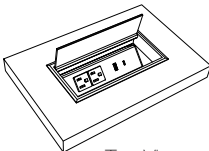
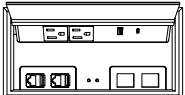
Description	Model	Price	W	D	H	Shipping Weight	Cubic Feet
PowerPort 1 - 2 RJ45s (Category 5/6)	PORT1	278	8	4	-	-	-
	Port Includes: 2 accessible power outlets & 1 side utility outlet powered by a 10' plug-in cord; 2 RJ45 (category 5/6) each with hard wired 10' data cords; 2 velcro wire managers and metal PowerPort shroud. PortPort lid is Silver Metallic. NOTE: RJ45 jacks with hard wired data cords included here must be within 10' of building utilities source to be functional.						
PowerPort 2 - USB-A & USB-C	PORT2	280	8	4	-	-	-
	Port Includes: 2 accessible power outlets & 1 side utility outlet; 1 USB-A & 1 USB-C charging ports all powered by a 10' plug-in cord; 2 velcro wire managers and metal PowerPort shroud. PortPort lid is Silver Metallic.						
PowerPort 3 - RJ11 & RJ45	PORT3	270	8	4	-	-	-
	Port Includes: 2 accessible power outlets & 1 side utility outlet; 1 RJ11 & 1 RJ45 (Category 5/6); 2 Velcro wire managers & PowerPort Shroud; 1 x 10 Foot Data Cords (T568A) & 1 x 14 Foot RJ11 (Telecomm); powered by a 10' plug-in cord. PortPort lid is Silver Metallic. NOTE: RJ45 & RJ11 jacks with hard wired data cords included here must be within 10' of building utilities source to be functional.						
PowerPort 4 - 2 USB-A	PORT4	287	8	4	-	-	-
	Port Includes: 2 accessible power outlets & 1 side utility outlet; 2- USB-A charging ports all powered by a 10' plug-in cord; 2 velcro wire managers and metal PortPort shroud. PortPort lid is Silver Metallic.						
PowerPort 5 - 4 Receptacles	PORT5	280	8	4	-	-	-
	Port Includes: 4 accessible power outlets & 1 side utility outlet powered by a 10' plug-in cord; 2 velcro wire managers and metal power port shroud. PortPort lid is Silver Metallic.						
PowerPort 6 - USB-A, USB-C & RJ45	PORT6	406	8	4	-	-	-
 	Port Includes: 2 accessible power outlets & 1 side utility outlet 1 USB-A, 1 USB-C charging ports all powered by a 10' plug-in power cord. Includes 2 velcro wire managers and metal PortPort shroud with 2 data plate knock outs, 1 #M02 plate insert & 2 #S01W RJ45 female input, punch down terminal output snap in jacks. 2nd data plate knock out is blank for future use. PortPort lid is Silver Metallic.						

MILLENNIUM POWERPORTS

Description	Model	Price	W	D	H	Shipping Weight	Cubic Feet
Port - no Powerbar	Port0	137	8	4	-	-	-

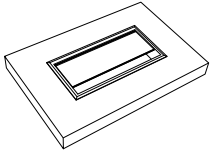

Port Includes: Port lid & Shroud only.

ORDERING NOTE: Velcro wire managers not included, see below for pricing. Port lid is Silver Metallic.

PowerPort Shroud with 2 Data Plate Knock-outs	SHROUD2KO	Must be requested - no upcharge	-	-	-	-	-
---	-----------	------------------------------------	---	---	---	---	---

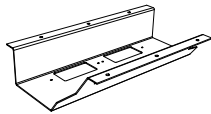

Angled PowerPort Shroud Includes: shroud with 2 data plate knock-outs in the bottom.

SNAP IN PORTS	Reference Code	Description	List Price
---------------	----------------	-------------	------------

ADAPTOR PLATES

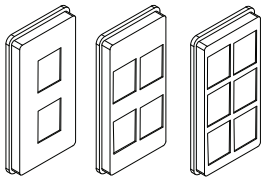

M02	Adaptor Plate (2) - accepts two snap in data ports	38
M04	Adaptor Plate (4) - accepts four snap in data ports	38
M06	Adaptor Plate (6) - accepts six snap in data ports	38

ORDERING NOTES: Blank covers are required when port is not in use,



RJ-45 - Category 6 data connection. This connector is also downwards compatible with Category 5 cabling. Connector is a female input with a #110 punch-down terminal block output (back side of Console interface) for on-site hard wire connection. 47

S01W	RJ45-CAT6 (White)
S01B	RJ45-CAT6 (Blue)
S01R	RJ45-CAT6 (Red)

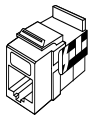

RJ11 - Telephone type connection. Connector is a female input with a #110 punch-down terminal block output (back side of Console interface) for on-site hard wire connection. 32

S02W	RJ11 (White)
S02B	RJ11-B (Black)
S02G	RJ11-G (Green)
S02R	RJ11-R (Red)
S02Y	RJ11-Y (Yellow)

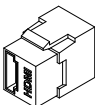



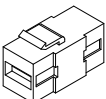

S04 **HDMI** - High Definition Multimedia Interface connection. Connector carries both HD audio and video data. Connector is a female-to-female pass through. 173

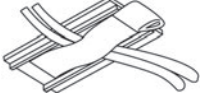

S08 **USB-A** - Full size USB "A" style connection. Connector is a female-to-female pass through. 61

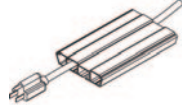
MILLENNIUM WIRE MANAGEMENT & ACCESSORIES

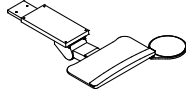
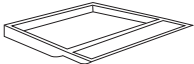
Description	Model	Price	W	D	H	Shipping Weight	Cubic Feet
	Round Grommet - Silver Metallic	152	-	-	-	-	-
	Round Grommet - Black	152	-	-	-	-	-
	One 60mm Grommet in a standard position is available at no charge per table.						
Velcro Wire Manager (qty 1)	WM-4	26	2	4.5	0.5	-	-
	2 velcro wire managers are included with Ports 1-5.						
Wire Management Trough	WM-72	182	72	3	1	-	-
	Wire Management Trough is standard in a 72" length & can be cut to specific length; double-sided tape installation.						
4-Channel Wire Management	CM-72	231	72	3	1	-	-
	4-Channel Wire Management is standard in a 72" length & can be cut to specific length; double-sided tape installation.						
Silver Metallic Trough	68CT36	59	30	2	"-"	0.25	"-"
	68CT42	74	36	2	"-"	0.25	"-"
	68CT48	91	36	2	"-"	0.25	"-"
	68CT54	105	48	2	"-"	0.5	"-"
	68CT60	121	48	2	"-"	0.5	"-"
	68CT66	137	52	2	"-"	0.5	"-"
	68CT72	152	60	2	"-"	0.75	"-"
	68CT84	168	60	2	"-"	0.75	"-"
							
Cable Manager for Height Adjustable WorkSurface	68HACM	89	4	3	21.5	5	.25
							
Articulating Keyboard with Palm Rest & Mouse Tray	68KBMT1912	694	27	-	7	20	2
							
Wood Pencil Drawer	68PD2116	611	21.25	21.25	1	2	1
	ORDERING NOTE: Wood pencil drawer is available in Oak, Cherry, Maple or Walnut, please clearly mark P.O. with species and finish selection.						

MILLENNIUM GROMMETS & POWERPORTS

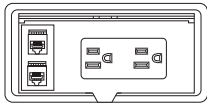

POWER / DATA / VOICE MODULE (SUPPLIED WITH WIRED HUTCHES)

Black, rectangular with flip down cover. Includes two power outlets, one voice port, and one data port. Two Simplex outlets 15 Amp, 10 ft. cord and one 6-pin and one 8-pin connector. Access to power and data is made simple by using a hutch with a power data module built right into the tack-board. The module is fully installed at the factory but can be removed to connect data links on site. It features a flip door that retracts into the case of the unit when open. See page 251 in the grommets section for complete power specifications

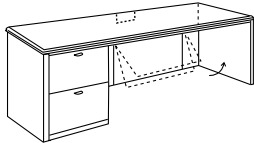

WIRE MANAGEMENT CUT-OUT AND HINGED MODESTY PANELS

Returns, link units and credenzas with fixed modesty panels can be specified with an 8" x 1 1/2" wire management cut-out. All hinged modesty panels feature a cut-out as a standard. The discreet cut-out allows for clean and easy access to power, data and communication sources.

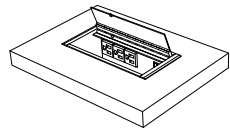

POWERPORT

A PowerPort is a unique worksurface mounted module that can be specified to a location that best serves the user's needs. It includes a UL approved electrical, voice and data power bar, containing two 115 - volt electrical simplex outlets which are accessible from the work surface, plus a utility outlet at the end for daisy chaining purposes. See pages xx for available data versions.

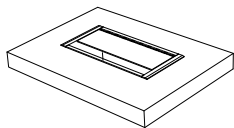

PORT

A service module having no power bar will serve as a large grommet. A hinged lid easily enables the passage of several cables and devices

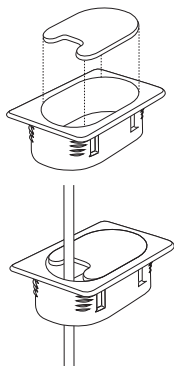

GROMMETS

All cases may be specified with one grommet in a standard position at no upcharge. A \$152 list upcharge will apply to additional grommets in standard positions and for grommets requested in non-standard positions. The grommet position must be indicated for each case on the purchase order. Standard grommet is available Black or Grey, rectangular, 4 1/8" x 2 11/16". Please specify grommet color when ordering. Grommets can also be field installed with power drill 2 1/4 hole saw and rasp or saber saw. Template for drilling is available. Please keep in mind the location of grommets when specifying paper managers for use with work surfaces. For example, a paper manager on the left hand side may be used with a "C", "BR" or "AR" grommet.

STANDARD GROMMET POSITIONS

Desks, Credenzas, Link Units & Returns
30" Deep Desks:

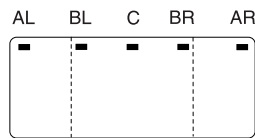

36" Deep Desks:

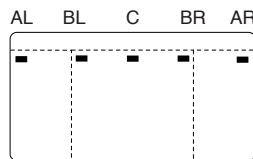

Position Code: Position Code:

AL – left corner AL – left corner

BL – left end beside pedestal gable BL – left end beside pedestal gable

C – center C – center

BR – right end beside pedestal gable BR – right end beside pedestal gable

AR – right corner AR – right corner

NOTE Please do not specify grommets in the "C" position for 60-71" ganged pedestal returns and credenzas. In these cases, the "C" position is over the top of a pedestal.

"BL" and "BR" are only available on tops 42" or longer.

CURVILINEAR TOPS

Position Code:

C – center

This key applies to all B, P, Q, and K shaped tops.

The support panel is notched out to accommodate wire management.

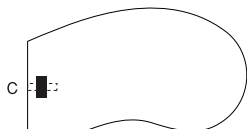

MILLENNIUM DESKS, OVERHEADS, HUTCHES & HEIGHT ADJUSTABLE

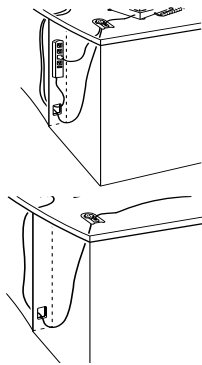

DESKS WIRE MANAGEMENT CAVITY

Millennium desks can also be specified with a hidden wire management cavity. This finished cavity is accessed from the front of the desk by a hinged door and is completely concealed in the closed position. The wire management cavity includes a four receptacle power bar mounted on the inside pedestal gable. This feature allows the use of several powered items on the desk surface and greatly reduces the number of cables routed to the primary power source. The hinged cavity also effectively conceals all excess cables from view.

PEDESTAL ACCESS WIRING GROMMET

All Millennium desks allow for wire management behind the pedestal drawers. Pedestal gables feature a standard cable management opening allowing access to the rear of the pedestal cavity. By specifying a wiring grommet in a standard AL or AR position (see grommet locations on page 72, cable can be conveniently threaded behind the pedestal drawers and through the wire management access grommet. Combined with our standard wire management cover, all cables are neatly tucked out of view.

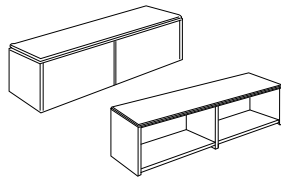

OVERHEADS

Overheads include tasklights that are factory installed and require no field adjustment. Tasklights are mounted beneath the cabinet and hidden from view. Cords run down the right hand side of the tasklight to the work-surface where they can be routed behind the worksurface top. The use of a wall mounted tackboard conceals the cord from view. Tackboards must be ordered separately and can be specified in any fabric grade (1-9. Wall mounted tackboards for overheads are supplied with all necessary hardware for installation. Locks are optional on overheads and can be specified at time of order for an upcharge of **\$152 list** per set of (2) doors.

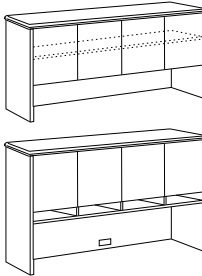

HUTCHES

Hutches include tasklights that are factory installed and require no field adjustment. Tasklights are mounted beneath the cabinet and hidden from view. Glass doors on hutches are wood framed clear glass. A tackboard in Krug Momentum Panel grade 1 fabric is included with every hutch. Upcharges for higher graded fabrics are listed on page 47. Tackboard fabric selections should be supplied with the order information, fabric options are listed on page 4 of this price guide. Tackboards for hutches are installed at the factory and require no additional set up on site. Hutches over 84" in length are made in two pieces and require special installation. Hutches are available with a finished inside back panel at standard list price, but must be clearly specified on order. This option is available on hutches up to 84" in length only. This option does not include a tackboard. Locks are optional on overheads and can be specified at time of order for an upcharge of \$152 list per set of (2) doors. Hutch and overhead installation instructions are included with every case, basic installation instructions can be found in this guide on page 253. All required mounting hardware is included with all hutches.

HEIGHT ADJUSTABLE WORKSURFACE WITH BASE ENCLOSURE

Single Stage Mechanism With Base Enclosure

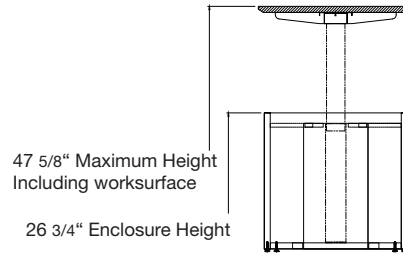
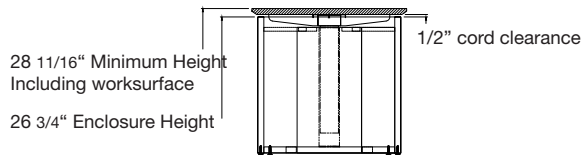

The Single Stage mechanism with Base Enclosure has an adjustable height range of 28 3/8 - 47 1/4 inches. When the worksurface is at the lowest stage - desk height, the space between underside of the worksurface and the top of the Base Enclosure is 1 1/2 inches.

Dual Stage Mechanism With Base Enclosure

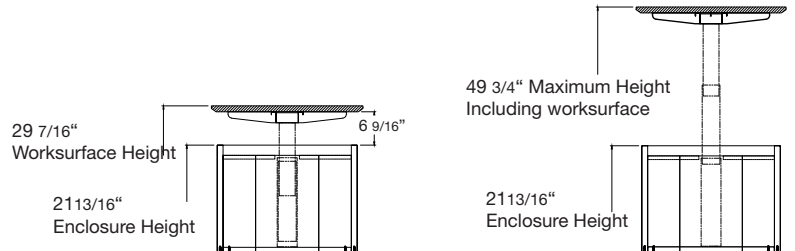
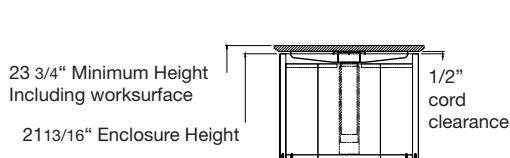

The Dual Stage mechanism with Base Enclosure has an adjustable height range of 23 3/4 - 49 3/4 inches. When the worksurface is at the standard desk height setting of 28 7/16", the space between underside of the worksurface and the top of the Base Enclosure is 6 inches. This allows for the full range of height adjustments. Custom Base Enclosures for the Dual Stage are available decreasing the gap below the worksurface to 1/2 inch. Caution: this eliminates the ability to use the lower stage settings. Custom Base Enclosures to further lower the minimum worksurface height are also available, removing the inside enclosure floor completely and allowing a minimum desk height of 22 7/16". Contact customer service for a quote.

MILLENNIUM FILING INSTRUCTIONS & INSTALLATION



FILING INSTRUCTIONS

All file drawers will accept both letter and legal size filing. All units are equipped with file bars to accommodate either direction. File bars are shipped taped to the inside of the drawer for safety.

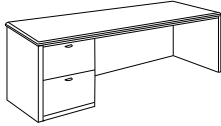

DESK PEDESTAL FILE DRAWERS

Filing Capacity:

25.5" of letter filing from front to back, or

12" of legal filing side to side

Pedestal drawer depths allow only one row of side to side files

Legal files can be positioned in the side to side direction only.

Weight capacity of pedestal file drawers is 130 lbs

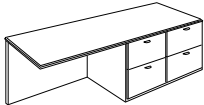

CREENZA AND RETURN PEDESTAL FILE DRAWERS

Filing Capacity:

15" of letter filing from front to back, or

12" of legal filing side to side

Pedestal drawer depths can be positioned in the side to side direction only.

Weight capacity of pedestal file drawers is 100 lbs

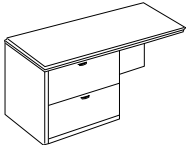

CREENZA, RETURN OR STORAGE LATERAL FILE DRAWERS

Filing Capacity for 30" wide drawers:

30" of letter filing front to back, or

25" of legal filing side to side, or

15" of legal filing front to back

When filing front to back, 30" lateral file drawer widths allow two rows of letter filing, but only one row of legal file width

Filing Capacity for 36" wide drawers:

30" of letter filing front to back, or

36" of legal filing side to side, or

30" of legal filing front to back

Weight capacity of lateral file drawers is 150 lbs



CONNECTING WORKSURFACES

It is important that the product is in its final position and the primary worksurface is leveled before connecting other joining pieces. Detailed installation instructions are included with each unit, or available from Krug Customer Service. Units are connected with mending plates under worksurfaces, and linking brackets on modesty and end panels. Locate connections and attach the mending plates under the worksurface. Level pieces if necessary by adjusting the glides to achieve flush and firm joints before completing installation of all hardware.

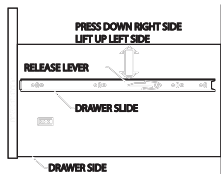
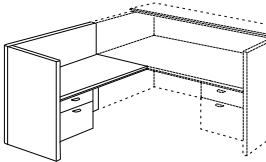

DRAWER REMOVAL

To remove pedestal drawers, open to the extended position, press down on the right side nylon release lever and pull the drawers up on the left side lever at the same time. Continue pulling the drawers out of the case.

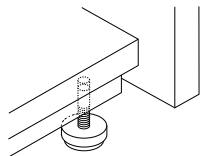

GLIDE ADJUSTMENT

Raise one corner of the unit at a time and adjust the glide to the desired height by turning the glide in the hole. Make sure unit is level after adjusting the glides. Please note that the maximum adjustment range of the glides is 1 1/2". When moving units after glides have been inserted, dial the glides to the lowest position to prevent damage to the case.

BOOKCASE OR HUTCH DOOR ADJUSTMENT

Hinges on all hutch and bookcase doors are designed to be adjusted for depth, horizontal and vertical adjustment by means of screws into the hinge mounting plates. To remove a door, squeeze the release clip and pull out the door, disconnecting the hinges.

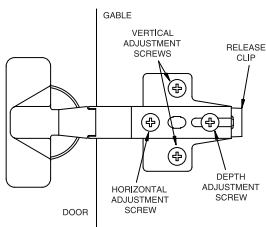

OVERHEAD INSTALLATION

The wall mount overhead storage units must be installed on wall studs. The first step for installation is to locate the studs in the wall where the overhead is to be mounted. Measure the stud center line location and use this measurement to mark the hole locations on the mounting rail and the overhead back. Drill clearance holes at the hole locations. Hole requirements will depend on the fasteners chosen by the installer. 2 1/2" x #10 wood screws are adequate if going into wood studs. If studs cannot be accessed, then appropriate drywall plugs or butterfly bolts should be used. We recommend 2 fasteners per stud. Fasten the mounting rail to the wall ensuring that it is level. Hang the overhead on the mounting rail and then fasten it to the wall. This prevents accidental removal and also allows for some leveling adjustment.

Terms and Conditions

Net 30 days on approved credit. A late payment charge of 1% per month will be applied on overdue invoices. This charge will be pro-rated to the number of days past 30 days that the invoice is overdue. All applicable sales taxes are extra. Distribution of this price list does not in itself constitute an offer to sell. Orders can be received only from authorized Krug dealers. Acceptance of any order and terms of sale may be established at the discretion of Krug. Deposits are required on orders received from new accounts as well as on large or special orders. Krug reserves the right to discontinue designs, or to change designs, construction, prices, or materials without notice.

Contact Information

Phone: 1.888.578.KRUG (5784) | Fax: 1.519.748.5177

Purchase Order Fax: 1.888.236.4783

Purchase Order E-mail: orders@krug.ca

Web: www.krug.ca E-mail: solutions@krug.ca

Customer Service Hours

Please note customer service hours are:

8:30 am to 5:00 pm est

Customer Satisfaction

It is the primary goal of Krug and our staff to ensure the complete satisfaction of our customers with our products and performance. If a problem arises with a Krug product after the expiration of the limited warranty period, Krug will exercise its best efforts to achieve the satisfaction of the customer in a manner that is fair to all concerned.

Order Acknowledgments

Each order will be acknowledged via e-mail or fax. This acknowledgment is the final agreement between Krug and the customer, superseding all previous communications regarding the purchase order. Where there is a discrepancy on a purchase order between a product code and a description, Krug will make every effort to resolve the discrepancy, but will be ruled by the product code ordered. Please check all acknowledgments for accuracy, and advise Krug of any discrepancies with a purchase order.

Order Cancellation

Krug reserves the right to not accept or allow cancellation of orders. All products are manufactured on a custom-made, make-to-order basis, and the purchasing, engineering and production of orders begins shortly after order placement - and the customer purchase order is a contract that authorizes Krug to manufacture the products. Acceptance of order cancellation (or partial cancellation) is solely at the discretion of Krug, and is dependent on the extent to which engineering, purchasing and manufacturing has been initiated by the time cancellation is requested. No order cancellations (partial or otherwise) are allowable more than 4 weeks from date of order placement (as order production is unable to be terminated by that point), and full payment of the acknowledged order value is required for any orders cancelled after 4 weeks. Cancellations may be allowable in less than 4 weeks after order placement, depending on the extent to which manufacturing has been initiated. An acceptance of order cancellation requires that the purchaser agrees to make payment for all costs incurred to the point of acceptance of cancellation. Cancellation charges include all costs for purchase of dedicated material and components, engineering costs for non-standard products, and all costs for manufacturing completed to that point, as well as a \$367 net charge for processing of the original order and for processing of cancellation invoicing.

Pricing

Krug endeavors to ensure that all prices in this price list reflect accurately our current prices. However, errors do occur and will be rectified through notices to the field. Krug reserves the right to acknowledge pricing that may be different from the price list.

Warranty

Krug warrants the construction and the finish of all our products to be free from defects in materials and workmanship for a period of 10 years from the date of purchase. This warranty is applicable to products in use by their original purchaser. This warranty does not apply to components not manufactured by Krug including textiles, which are subject to the specific warranties of those manufacturers,

if any. Textiles (fabric, leather, vinyl, or any other covering material) suppliers do not guarantee their products for durability and color fastness, and nor does Krug. Casters, mechanical and electrical components have a warranty of five years from the date of purchase. The Krug warranty does not apply to COM-specified materials, damage caused by a carrier other than Krug, or variation in wood finishes due to natural wood color variation. Krug cannot be held responsible for variations in fabric dye lots from order to order. All fabric is carefully inspected when it is received, but a degree of variation in color should be expected. Repairs or replacement of any defect covered under this warranty by Krug will be made, at our option and method, at no charge to the original purchaser during the warranty period. Krug's judgement is final and binding with respect to the nature or cause of defects or damage, and the necessity or manner of repair or replacement.

This warranty does not apply to defects or damage resulting from:

- normal wear and tear occurring with the use of the product
- negligence, misuse, excessive use, alteration, improper cleaning or repair
- substitution or use of incorrect or unauthorized components or material
- handling or installation that is incorrect, or that causes damage or defect
- damage incurred by a freight carrier other than Krug
- wearing of finishes and fabrics, and normal variations in materials (including dye lot variations)
- properties of natural materials, including wood and leather
- exposure to environments with uncontrolled temperature and humidity (products must be transported, stored and used in climate-controlled conditions)

Note, specific warranties for components and materials not manufactured by Krug:

Height Adjustable Mechanism Warranty

Krug warrants to the original consumer purchaser its Height Adjustable Mechanism that it will be free from defects in material and workmanship. This limited warranty covers material and manufacturing defects, which cause a non-conformance in the function of a table base and is limited to the following products and warranty term determined from their dates of purchase:

- a) Electronic components such as control boxes, hand switches and motors – two (2) years
- b) Mechanical components such as crank drives, spindles – five (5) years
- c) Structural components such as J-channels, feet and top supports – ten (10) years.

The start of the warranty period is the documented date of your purchase of the product. The warranty herein is made to and for the benefit of the original consumer purchaser of the product and is non-transferable. If you discover a defect in material or workmanship during the warranty period, and Krug agrees that the defect exists, Krug will, at its option, repair or replace the Product at no charge to you, provided it is returned during the warranty period. In the unlikely event that your product should require repair or replacement during the warranty period, please contact Krug to obtain warranty service. The warranty period on replacement products is the remainder of the warranty on the original product or 30 days, whichever is longer.

Testing

All Krug Conference products meet or exceed the testing requirements of ANSI/BIFMA X5.5-2014 or X5.9-2012.



Dimensions

Dimensions are in inches and approximate, and subject to change without notice. Contact Customer Service if dimensions are critical.

Installation Support

For assistance please contact Technical Support at 1-888-578-5784 x216 or e-mail installationhelp@krug.ca and you will be directed to the appropriate installation support person.

GENERAL INFORMATION

Storage Charges

Krug reserves the right to assess a nominal storage charge if a customer does not accept shipment of an order within a week of the ship date.

Export Packaging

Krug is pleased to provide the option for export packaging on all our products, to provide additional protection from damage. For shipments overseas, a quote for export packaging can be provided, based on the products to be ordered and the delivery destination - please contact Customer Service or Bids & Specification Support for more information and a quotation. KRUG is not responsible for shipment damage occurring on overseas shipments

Export Packaging is **STRONGLY RECOMMENDED** for:

(A) all shipments outside of the lower 48 states and Canada

(B) all shipments that will be held in storage for an extended period prior to installation. Important: Please note that Krug will not be responsible for damage claims on product shipped or stored in the above conditions where export packaging has not been utilized.

Please contact Customer Service for specifications or any other assistance regarding export packaging.

Freight Terms and Conditions

1. All product is shipped FOB the Krug factory. Freight is either pre-paid to the destination or not pre-paid, depending on established customer specific freight terms.

2. Docks at the selected delivery location must be equipped to handle a 53' trailer. If a dock is inadequate for delivery by Krug, Krug will re-deliver to another local location and any additional costs will be charged to the customer.

3. For all deliveries, it is understood that Krug or its agent is making a dock delivery only (equipped to handle a 53' trailer), and any further work of truck unloading, delivery beyond the dock, installation, and removal of packaging is not authorized or paid for by Krug.

4. Drop shipments to the installation site, and timed deliveries, are available on larger shipments (full truckloads or slightly less) at no additional charge. Drop shipments or timed deliveries for smaller shipments may not be available, or if available will require a surcharge. Deliveries on an after hours basis, or on weekends, or any other special requirements, may be subject to a surcharge. Location and contact information, and the requested time of delivery, is required at least one week prior to the acknowledged shipment date. If this information is not provided one week in advance, or if the location or time of the drop shipment is changed less than one week in advance, a surcharge may be applied, and/or the drop shipment may not be scheduled. For deliveries requested Monday to Thursday after 5:00 pm, please apply a surcharge of \$262/shipment. For deliveries requested Monday to Friday before 7:00 am, please apply a surcharge of \$262/shipment. For deliveries requested Friday (after 3:00 pm) or weekends, please apply a surcharge of \$525/shipment. (local times).

5. For all deliveries - whether to the Customer location or drop shipment - any circumstances that result in the delay of our carrier (including unsuitable receiving facilities, or facilities not open or available), service charges will be applied at the rate of \$125/hour. Where re-delivery is necessary because of these circumstances, the full cost of re-delivery will be charged. If Less Than Truck Load is delivering, one hour is allocated to unload. Any additional time required to unload after the first hour is \$125/hour. If a Truck Load is delivering the order, three hours is allocated to unload. Any additional time required to unload is \$125/hour. Direct deliveries to site for large orders are possible, (must exceed \$60,000 net), and accommodate 48 - 53' trailers. Krug is responsible for delivery to the approved delivery address. If an address change is required, this must be authorized by Krug 5 business days prior to ship date. Any additional delivery costs incurred after this time will be charged to the customer

Damaged Shipments

All Krug product is well engineered, carefully inspected, and expertly loaded onto our trucks at our Distribution Center. If you receive any damaged freight, we ask that you do not refuse the shipment. Krug is not responsible for damage to goods that occurs in transit or storage. It is the purchaser and/or receiver's responsibility to examine the goods upon receipt and to notify Krug of any damages, overages or shortages. Any discrepancies should be noted on the Bill of Lading. The delivering carrier will not accept responsibility for shortages or damages if signed "clear". Notification of concealed damage claims must be made to Krug Distribution within 5 days of delivery, along with digital pictures if available. All product and packaging must be available for inspection. Krug liability ceases after

5 business days and Krug will not be responsible for concealed damages if shipments are left unopened. Krug is not responsible for the condition of product that is stored or installed in an environment where temperature and humidity are not controlled.

Field Product Report Authorization

Krug's written authorization, in the form of an FPR number, must be obtained prior to incurring charges of any kind if Krug is expected to pay these charges. This includes authorization for returns, field repairs and replacements, post field repairs, installation and delivery charges. Krug reserves the right to have its representative inspect product related to any request for such authorizations, prior to that authorization being provided. Deductions from invoices paid for any charges to Krug, without prior written authorization in the form of an FPR, will not be accepted. Digital photographs may be required to complete the FPR process.

Care and Maintenance

Wood Finishes - Although Krug's extensive finishing process ensures a durable finish on all our products, there are several steps that can be taken to protect and prolong the life and beauty of the finish. Protect the top by placing felt pads on the bottom of any accessories and mechanical equipment. Rubber and oil will permanently mark surfaces. Use a desk pad to prevent possible damage and imprinting caused by writing instruments and sharp objects. Dust only with a clean, dry cloth, going with the grain. Clean any marks with a damp cloth, using a small quantity of mild soap or detergent. Do not use any wax-based polish, spray or silicone. Eventually, a film will build up and discolor the top. Do not place your furniture in a position of permanent exposure to direct sunlight.

Plastic Laminates - Clean plastic laminates with mild soap and warm water. Do not use steel wool, hot water, or any abrasive cleaning product.

Custom Capabilities

Over 15% of our orders involve some type of custom work, and we invite our customers to make use of our extensive capabilities. These include:

- 1) Dimensional customization of standard size products
 - 2) Custom wood finishes
 - 3) For larger orders, completely custom-designed products, as well as non-standard wood species can be specified.
- Custom orders may require additional production lead times. Contact Customer Service for more information.

Krug Panel Fabric Program

Tackboards can be upholstered in COM material supplied by the customer, and in a selection of stocked tackboard fabrics supplied by Momentum. The Momentum Panel fabrics are available on Krug Express. They are 100% polyester. For additional information and color selections, please refer to our Panel Fabrics card and Krug's website. www.krug.ca The Momentum panel fabrics pass ASTM-E84-87 Fire Codes. If memo samples are required please call Momentum at 1-800-366-6839.

KrugExpress Program Details

KrugExpress orders are ready to ship by the date acknowledged. Delivery and shipping schedules may result in actual shipping of orders at a later date. Statutory holidays and scheduled factory vacations may add to acknowledged lead times of *KrugExpress* orders. Unless otherwise specified on the order, the customer's standard method of shipping Krug products will be utilized. Available factory capacity for *KrugExpress* is filled by orders received on a "first come, first serve" basis. If the normal *KrugExpress* lead time is not available for your order because available capacity has been filled, you will be immediately advised of the earliest available ready-to-ship date. Please consult your Customer Service representative in advance if you wish to confirm the specific lead time availability for a *KrugExpress* order. Orders must be received by midnight of a given day for that day to be considered the official day the order is received. Order lead times are acknowledged from the date the order is received, but not including the date the order is received.

KrugExpress orders must be "clean" when received in order to be considered officially received on a given day, and lead times will be acknowledged from the date orders are determined to be "clean". Changes to *KrugExpress* orders are not allowed under any circumstances. Orders for product on *KrugExpress* must clearly state: "*KrugExpress*".

CUSTOM PRICING METHODS

CUSTOM PRICING METHODS

Custom widths: Apply the price that is one standard size larger than the desired case size (but same depth).

Example: The required custom dimension is 74" x 30". The first standard size above this is 78" x 30", so in this case you would apply the price of the 78" x 30" unit.

Custom depths: Apply the price of the same unit one size deeper (but same width).

Example: The required custom dimension is 72" x 26". The first standard size above this is 72" x 30", so in this case you would apply the price of the 72" x 30" unit.

Custom width & depth: Apply the price of the same unit both one size wider and one size deeper.

Example: The required custom dimension is 74" x 26". The first standard size above this is 84" x 30", so in this case you would apply the price of the 84" x 30" unit.

Custom height of desk height cases: Add 18% (31-32" hi)

Grommets in non-standard positions, add: \$152 list

To remove hutch or overhead doors, deduct: 4% list

Convert 5-hi hutch to 6-hi hutch, add: 20%

Bookcases with optional pull out printer shelf at standard shelf height, add: \$238 List

Bookcase with optional vent in back (includes 2 vents and 1 grommet), add: \$302 list

Cases where tops are flush left/right or both, add \$120 list

2 lateral files and 3 or 4 closed shelves - convert to half open, half closed shelves, add: 15%

2 lateral files and 3 or 4 closed shelves - convert to half open, half wardrobe, add: 15%

To remove storage doors for open shelves, deduct: 4%

EXCEPTIONS TO THE PRICING METHODS ABOVE

Sizes larger than the largest shown Price List.

Non-standard extension on drawer slides.

Non-standard drawer depths in standard depth pedestals.

Glass door - any style.

Glass - face mounted modesty panels.

Perforated modesty panels.

Cases with curvilinear tops where the radius becomes non-standard.

A/V cabinets.

Any case with flipper doors

PLEASE NOTE: Cases with non-standard features do not apply to the rules above.

Contact Krug Customer Service if you require assistance.

KRUGEXPRESS CASEGOODS

CASEGOODS PROGRAM DETAILS*

*(In addition to previous page)

Orders for casegood products on the KrugExpress program may be subject to quantity maximums. Please contact Krug Customer Service for more information. Quantity maximums are dependent upon available capacity, in order to insure that we ship all orders on time. Only actual casegood pieces and conference tables tops and bases are considered "units". Items such as tasklights, tackboards, keyboard trays and drawers, electrical and wire management components, etc., are not considered under the quantity restrictions.

For example, a typical office configuration that includes a desk, linking unit, credenza and hutch/overhead, equals a total of four units for the purposes of the quantity maximum. Only Krug In-stock panel fabric is available on the KrugExpress program. Only standard wood finishes are available for KrugExpress orders. Grommets can be specified in standard positions only. KrugExpress also includes all Krug seating and occasional tables as well as Krug conference products to complement this casegoods offering. Please note PALETTE finishes are not available on KrugExpress.

TACKBOARD, C.O.M. & GRADED-IN UPHOLSTERY PROGRAMS

KRUG PANEL FABRIC PROGRAM

Tackboards can be upholstered in COM material supplied by the customer, and in a selection of stocked tackboard fabrics supplied by Momentum. The in-stock Momentum fabrics are priced at Grade 1 and are available on Krug Express. They are 100% polyester. For additional information and color selections, please refer to our Panel Fabrics card and Krug's website. www.krug.ca If memo samples are required please call Momentum at 1-800-366-6839. The Momentum panel fabrics pass ASTM-E84-87 Fire Codes.

CUSTOMER'S OWN MATERIAL - C.O.M.

Customer's Own Material (COM)

COM must be received three weeks prior to the acknowledged ship date. Orders with COM not received by the required deadline will be delayed.

A description of the fabric, including supplier name, fabric name and color number must be included with the purchase order. When the COM fabric is received at Krug, it must be clearly identified with the fabric name and color, and tagged with name of the Krug customer and purchase order number. Krug will inspect all COM fabric when received to determine if it will be suitable for upholstery. Where Krug feels that the fabric or leather specified will compromise the quality or integrity of our products, customers will be contacted to direct these concerns. Further, Krug reserves the right to refuse to accept and use any COM fabrics or leathers that will compromise our products in any way that is unacceptable to Krug. Krug cannot assume responsibility for the durability or tailoring quality of customer's own material. Yardage specified in this price guide is approximate. In the case of multiple product orders, multiply the number of items by the COM yardage specified to determine fabric required, unless otherwise indicated. Additional yardage may be needed if the material is less than 54" wide, or patterned or striped and requires matching. As fabric is applied horizontally, non-directional fabrics are recommended. COM fabrics are applied as they come off the roll unless otherwise specified. All striped fabrics will be applied vertically unless otherwise stated by the customer and after approval by Krug. It is the customer's responsibility to advise Krug if the upholstery is to be applied otherwise, and to advise Krug of any special upholstery instructions. Special instructions should be sent to Krug Customer Service, including a sample (or photocopy) of the fabric. Krug is not responsible for instructions sent with the fabric rolls, or for the method of upholstery if no instructions have been provided. COM fabrics for tackboards may be specified in either Maharam or

Momentum panel fabrics. Krug is not responsible for determining if a fabric is not ideal for tackboard application.

Please contact Maharam at 1-800-645-3943 or Momentum at

COM Shipping Procedures

For tackboard COM fabrics, please send fabrics to:

Krug Inc.

111 Ahrens Street

Kitchener, Ontario

Canada N2H 4C2

Attention: RECEIVER

All packages must be clearly marked "For Customs Clearance by Willson International Custom Brokers". According to the North American Free Trade Agreement (NAFTA), goods shipped between the United States and Canada can qualify for exemption from all duties, or for a reduction in duties, if the goods can be proven to originate in either the United States, Canada or Mexico. Canada Customs requires that a NAFTA Certificate of Origin and a Commercial Invoice be completed and sent with the fabric shipment. The Commercial Invoice must clearly state the description of the fabric, the selling price, the make-up or content, and the purchaser. The absence of these two documents will delay the shipments at the U.S./Canada border, thereby potentially delaying the customer order. If the total value of the shipment is less than \$1200 U.S., Customs will accept a Low Value Statement of Origin in place of the NAFTA Certificate of Origin. The Low Value Statement must be signed by a representative of the exporting company. This statement may either be included on the commercial invoice or attached to the invoice. Krug is happy to answer any questions or concerns about COM shipping procedures and the required documents. Please contact our Customs Specialist at 1.888.578.5784.

GRADED-IN UPHOLSTERY PROGRAMS

Krug has partnered with several textile brands to grade in their offerings, designed to provide a wide range of upholstery selections for our seating products.

Upholstery pricing and availability is subject to change without notice. We grade this upholstery according to the pricing of the fabric suppliers - when their pricing changes, the Krug grade may change. When placing an order, a Krug customer must specify the complete upholstery number, along with the appropriate Krug model number and finish. Krug will supply the complete product at the prices listed. Orders specifying graded-in upholstery cannot be cancelled once the upholstery has been ordered.

Upholstery Grades

To determine the price of a product for graded-in upholstery, use the reference lists located on Krug's website under - Resources, to view the upholstery. Krug is not responsible for the discontinuation of this upholstery. Please contact Customer Service for information on upholstery not listed.

When two upholstery selections are specified for use on seating, the higher grade upholstery price will apply to the order.

High Performance upholstery; Polyurethane, Vinyl or Crypton, is

particularly suitable for healthcare and other intensive-use environments.

Upholstery Samples

If you require additional samples or memos for presentation, please contact fabric supplier directly.

Flammability Standards

- Tunnel Test Surface Ratings Class A rating
- Class 1 UFAC
- Passes State of California Technical Bulletin CAL 117-2013

Please contact fabric supplier directly for further flammability information pertaining to specific upholstery.

Special Conditions

Acknowledgements will give the estimated delivery date of the finished product. Some upholstery is imported, and availability may affect estimated delivery time. For large projects, please contact fabric supplier directly for availability of yardage.



All products are air emissions certified and are available as FSC® certified

krug

solutions@krug.ca | www.krug.ca | 1.888.578.KRUG