

MILLENNIUM CONFERENCE

Price and Specification Guide

GSA

GS-03F-084DA



Effective January 1, 2023

krug

Advancing Design Through Innovation

TERMS & CONDITIONS | INFORMATION FOR ORDERING ACTIVITIES

General Services Administration Federal Supply Schedule

FSC Groups 7110, 7125
Subcategory: Furniture
CONTRACT NUMBER: GS-03F-084DA
CONTRACT PERIOD: April 1, 2016 through March 31, 2026
CONTRACTOR/ ADMINISTRATOR: Mira Jaksic-Husic
Krug Inc.
421 Manitou Drive
Kitchener, Ontario, Canada
Tel: 1-800-265-2796
Fax: 1-800-265-2798

1. List of Special Item Numbers on Contract

33721P Packaged Office Furniture w Ancillary Installation Services
33721 Office Furniture w Ancillary Installation Services
339113H Healthcare Furniture w Ancillary Installation Services
OLM Order Level Materials

2. SPECIAL ITEM NUMBER	MAXIMUM ORDER
33721P	\$5,000,000
33721	\$250,000
339113H	\$500,000
OLM	\$250,000

3. SPECIAL ITEM NUMBER	MINIMUM ORDER
33721P	\$100.00
33721	\$100.00
339113H	\$100.00
OLM	NA

4. Geographic Coverage

48 contiguous States and Washington, DC

5. Point of Production

Krug Inc.
421 Manitou Drive
Kitchener, Ontario, CANADA
N2C 15L

6. Discount from List Prices

33721P Package Office Furniture Krug Product Discounts As Below
GSA Teaming Partner Products at their
Approved GSA Discount Terms. Krug
Installation Charge 12.75% of Net Order
(Max.). No Charge for Project Mgt Services.

33721 Office Furniture	
Executive Office Furniture	56.6%
Executive Conference Furniture	56.6%
Tables and Accessories	56.6%
Fully Upholstered Lounge Furniture	56.6%
Multiple Seating	56.6%
Multi-Purpose Seating	56.6%
Stacking Chairs	56.6%
Installation Ancillary to these products	12.75% Charge of Net Order (Max.)

339113H Healthcare Furniture	
Hospital Patient Room Furniture	56.6%
Hospital Geriatric Chairs & Lounge Seating	56.6%
Patient Service Systems	56.6%
Installation Ancillary to these products	12.75% Charge of Net Order (Max.)

7. Quantity Discounts (off Net pricing)

Multiple Seating, Multipurpose Seating, Stacking
Chairs

25,001 – 50,000	1%
50,001 – 100,000	2%
100,001 – 150,000	3%
150,001 – 250,000	4%

Lounge Seating, Tables & Accessories

25,000 – 50,000	1%
50,001 – 75,000	2%
75,001 – 100,000	3%
100,001 – 180,000	4%
180,001 – 200,000	5%
200,001 – 250,000	6%

Hosp/Geriatric Chairs and Lounge, Patient Room
Furniture, Patient Service Systems

\$100,000 - \$200,000	1%
\$200,000.01 - \$300,000	1.5%
\$300,000.01 - \$400,000	2%
\$400,000.01 - \$500,000	2.5%

Quantity Discounts for Executive Office and
Executive Conference are no longer applicable
based on the MAS Consolidation revisions to
Maximum Order Limits.

8. Prompt Payment Terms

Net 30 Days

9. Visa and MasterCard are accepted above and

below the micro-purchase threshold.
NOTE: No additional discount will be offered on
orders placed using credit cards.

10. Foreign Items

All items manufactured in Canada.

11a. Time of Delivery

60-90 Days ARO for all items.

11b. Expedited Delivery

Please contract Krug GSA Customer Service for
information on Expedited Delivery/Krug Express
Program. 1-800-265-2796

11c. Overnight & 2 day Delivery

N/A

11d. Urgent Requirements

Please contact Krug for urgent requirements.

12. F.O.B. Point

Destination

13. Payment Address

Same as above

TERMS & CONDITIONS | INFORMATION FOR ORDERING ACTIVITIES

14. Warranty

For commercial products, Krug warrants the construction and the finish of all our products to be free from defects in materials and workmanship for a period of 10 years from the date of purchase. For Krug Healthcare products (as outlined in the US Healthcare price and specification Guide dated March 1, 2019), Krug warrants the construction and finish of all Healthcare products to be free from defects in materials and workmanship for the lifetime of their use. This warranty is applicable to products in use by their original purchaser. This warranty does not apply to components not manufactured by Krug including textiles, which are subject to the specific warranties of those manufacturers, if any. Textiles (fabric, leather, vinyl, or any other covering material) suppliers do not guarantee their products for durability and color fastness, and nor does Krug.

Casters, mechanical and electrical components have a warranty of five years from the date of purchase. The Krug warranty does not apply to COM-specified materials, damage caused by a carrier other than Krug, or variation in wood finishes due to natural wood color variation. Krug cannot be held responsible for variations in fabric dye lots from order to order. All fabric is carefully inspected when it is received, but a degree of variation in color should be expected. Repairs or replacement of any defect covered under this warranty by Krug will be made, at our option and method, at no charge to the original purchaser during the warranty period. Krug's judgement is final and binding with respect to the nature or cause of defects or damage, and the necessity or manner of repair or replacement.

This warranty does not apply to defects or damage resulting from:

- normal wear and tear occurring with the use of the product
- negligence, misuse, excessive use, alteration, improper cleaning or repair
- substitution or use of incorrect or unauthorized components or material
- handling or installation that is incorrect, or that causes damage or defect
- damage incurred by a freight carrier other than Krug
- wearing of finishes and fabrics, and normal variations in materials (including dye lot variations)
- properties of natural materials, including wood and leather
- exposure to environments with uncontrolled temperature and humidity (products must be transported, stored and used in climate controlled conditions)

Note, specific warranties for components and materials not manufactured by Krug: Height Adjustable Mechanism Warranty Krug warrants to the original consumer purchaser its Height Adjustable Mechanism that it will be free from defects in material and workmanship. This limited warranty covers material and manufacturing defects, which cause a non-conformance in the function of a table base and is limited to the following products and warranty term determined from their dates of purchase: a) Electronic components such as control boxes, hand switches and motors – two (2) years b) Mechanical components such as crank drives, spindles – five (5) years c) Structural components such as J-channels, feet and top supports – ten (10) years. The start of the warranty period is the documented date of your purchase of the product. The warranty herein is made to and for the benefit of the original consumer purchaser of the product and is non-transferable. If you discover a defect in material or workmanship during the warranty period, and Krug agrees that the defect exists, Krug will, at its option, repair or replace the Product at no charge to you, provided it is returned during the warranty period. In the unlikely event that your product should require repair or replacement during the warranty period, please contact Krug to obtain warranty service. The warranty period on replacement products is the remainder of the warranty on the original product or 30 days, whichever is longer.

Jordan Sleepers Heavy-Duty Mechanism, made with heavy gauge steel and minimal moving parts - is backed by a 5-year warranty on the mechanism itself, in addition to the lifetime warranty on the rest of the product. If it does become damaged or degraded, the mechanism can be field-replaced. Juno and Trevisa Overbed Tables have a 2-year warranty.

15. Export Packing Charges

Quoted upon request

16. Terms and Conditions of Government Commercial Credit Card

ACCEPTANCE: KRUG will accept the government commercial credit card but will not Offer any additional discount for orders placed using the credit card

17. Term and Conditions of Rental Maintenance and Repair.

N/A

18. Term and Conditions of Installation

N/A

19. Term and Conditions of Repair

N/A

20a. Term and Conditions for any other services

N/A

20. Service and Distribution points

Call contractor

21. Participating Dealers

Call contractor

22. Preventative Maintenance

N/A

23. Environmental Attributes

Krug maintains a program to reduce the impact on the environment of our products and operations.

24. Data Universal Number System (DUNS) number

251476669

25. Notification regarding registration in SAM.

Krug Inc.'s registration in SAM is current, accurate and valid.

26 Cage Code: 37310

MILLENNIUM | TABLE OF CONTENTS

i TERMS & CONDITIONS

MILLENNIUM | CONFERENCE TABLES

- 2 Environmental Summary
- 3 Features & Options
- 4 Special Pricing Guidelines
- 5 Tops
- 7 Bases
- 8 Base Requirements Chart
- 9 Power Box

CONNEXUS™ TABLETOP CONNECTIVITY SOLUTION

- 10 Connexus™
- 12 Preconfigured Standard Modules
- 14 Preconfigured Large Modules
- 15 Custom Connexus™
- 17 Port Options
- 21 Connexus™ Location Charts

MILLENNIUM | MEDIA

- 26 Media

GENERAL INFORMATION

- 27 Terms & Conditions
- 27 Warranty
- 28 Krug Express Program
- 29 Wood Finishes & Laminates

LEED CI CREDITS



MATERIAL CONTENT:

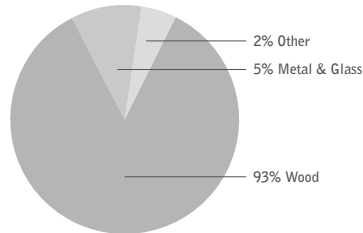

PRE-CONSUMER RECYCLED CONTENT - 74%

POST-CONSUMER RECYCLED CONTENT - 2.5%

		CONTRIBUTES To
Credit 2.1 - 2.2	Construction Waste Management	1-2 point(s)
Credit 3.3	Resource Reuse	1 point
Credit 4.1	Recycled Content	1 point
Credit 4.2	Recycled Content	1 point
Credit 4.5	Low Emitting Materials, (MUST BE REQUESTED) Composite Wood & Laminate Adhesives	1 point
Credit 5.1	Regional Materials*	1 point
Credit 6	Rapidly Renewable Materials (MUST BE REQUESTED)	1 point
Credit 7	Certified Wood (MUST BE REQUESTED)	1 point

*This credit is only applicable if in total 20% of the combined value of the procurement of construction materials and in the furniture are manufactured within a radius of 500 miles. This credit will apply if the installation of the finished product occurs within 500 miles of Kitchener, Ontario.

level® CERTIFICATION



BIFMA's e3 Furniture Sustainability Standard is a voluntary, multi-attribute standard that measures the degree of sustainability of furniture. This standard evaluates product and company environmental attributes and compliance systems in a wide range of elements which include Materials, Energy & Atmosphere, Human & Ecosystem Health and Social Responsibility. Millennium products have earned level®, BIFMA's sustainability certification program for furniture, certification through third-party verification against the e3 standard. All Millennium products can be supplied with level® certification. In order to accomplish this, the product must also be ordered with the air-emissions-certification option. Contact customer service for information and upcharges.

AIR-EMISSIONS

All Millennium products can be supplied with air-emissions-certified materials. Contact customer service for information and upcharges.



The mark of responsible forestry

FSC®

In 2005, Krug received Forest Stewardship Council® (FSC®) Chain-of-Custody certification for our manufacturing facilities. The FSC® Chain-of-Custody tracks certified wood from seedling to final sale. It signifies that the growth, harvesting and production of goods are entirely achieved through responsible forestry, which guarantees a healthy supply of forest resources for generations to come. Millennium and other Krug products can be specified with one of two types of FSC® Certification: (a) FSC®-certified (which includes FSC®-certified lumber, veneer and substrate material) (b) FSC®-mix certified (which includes substrate material only, and is a lower cost option certification) Contact customer service for further information, pricing and lead times.



In addition, architects, designers, and building professionals can specify FSC®-certified products in order to achieve a point from the US Green Building Council's Leadership in Energy and Environmental Design (LEED) Rating System.

MILLENNIUM | FEATURES & OPTIONS

EDGE PROFILES

Millennium conference product is available in Oak, Maple, Walnut and Cherry with a 32° sheen and seven distinctive edge details. Millennium conference product edge profiles match those of Millennium casegoods. Please specify an edge profile for all Millennium conference tops, and bases where indicated.



Seville
- contrasting crisp and rounded sculpted edge



Madrid
- ribbon fluted edge



Zamora
- bull nose edge



Valen
- transitional beveled edge



Barcelona
- half round edge



Williamsburg
- traditional edge



Torrens
- softened square edge

DRAWER PULLS



Oyster



Luna



Eclipse



Crescent



Williamsburg

Pulls are available in Satin Nickel, Matte Black, Polished Chrome, Black Chrome, and Brushed Brass. Pull color must be mentioned clearly on the purchase order. Pulls are located on all drawer fronts, storage wood doors, and bookcase wood doors. Glass door bookcases feature the Luna knob in the same finish as pulls on the order. Glass door hutches and wood door hutches do not have pulls. If a pull style and finish is not provided, the Eclipse pull in Black Chrome will be applied to the product. A Williamsburg pull in polished brass finish is standard on all products specified with the Williamsburg edge detail.

BASES

All bases are shipped separately and require assembly to selected top. Refer to the base requirements chart on page 8 to select the appropriate bases and sizes for conference tops. Round drums and rectangular conference bases require an edge profile to be specified, please select from the drawings shown in the previous section. Metal bases are available in a choice of chrome or black powder coat epoxy.

FINISH

A five step catalyzed varnish finish that when dry has a sheen value of 32°, is applied to all cases.

CUSTOM CONFERENCE TABLES

Krug has extensive capabilities for customization of conference tables, including special sizes, finishes, veneers, and special features such as ganging or mobility options. Please contact Customer Service with specific requirements and a drawing for more information.

SEATING CAPABILITIES

To establish seating capabilities, an outside chair dimension of 24" has been used for this price list, plus an allowance of 5" between chairs, for a total of 29". This is an approximation only. When using another chair, particularly seating with a 5 prong caster base, be sure to adjust the approximate seating capacity accordingly. Since not all manufacturers use this same formula, when a seating capacity is in question, please contact Krug Customer Service to review the specific seating that is being used with Krug Conference product.

BIRDSEYE MAPLE

Birdseye Maple veneer is available on 6800 Millennium conference tops at an upcharge of **\$70 list** per square foot. Birdseye Maple is recommended in a clear finish only. This option could extend regular lead times.

LAMINATE WORKSURFACES

Laminate worksurfaces are available at an upcharge of 10% (a higher upcharge may apply to specially priced plastic laminates). Where there are wood profile edges on worksurface tops, they will remain as wood profiles on laminate tops. Krug will order and procure laminates. Purchase orders with a plastic laminate option must include Laminate Name.

Krug reserves the right to decline a laminate that may not be suitable for the application. Krug assumes no responsibility for the durability, consistent coloration or any other performance characteristic of a customer specified laminate. Laminates may extend the normal lead-time, check with Customer Service for current scheduling information. Please see page 29 for laminate information.

MILLENNIUM | SPECIAL PRICING GUIDELINES AND PRICING METHODS

CONFERENCE

Custom sizing and additional customization is available on Krug Conference product. For more information or to obtain quotations, please contact Krug Customer Service.

Other Customization Pricing Methods for Conference

One side square add **\$217**

OTHER PRICING METHODS

6800 & 9800 - any case where tops are

Flush left/right or both add: **\$110**

9800 storage units-flush **\$181**

6800 glass tops on buffets add: **\$2153** for 60", 72", & 84" cases

Grommets in non-standard positions **\$139 list.**

Microphone cut outs per table for up to 7 microphone cut outs **\$344 list**

EXCEPTIONS TO THE PRICING METHODS ABOVE

Sizes larger than largest shown in Price List.

Non-standard extension on drawer slides.

Non-standard drawer depths in standard depth pedestals.

Glass door – any style.

Curvilinear tops with non-standard radius.

A/V cabinets.

Any case with flipper doors.

Lecterns.

Conference tables with non-standard bases, power boxes or positions.

6200 conference tables – non-standard sizes.

Please contact Krug Customer Service at 1.888.578.KRUG if you require assistance.

PLEASE NOTE: Cases with non-standard features do not apply to the rules above.

Contact Krug Customer Service if you require assistance.

MILLENNIUM | TOPS

Description	Model	Cherry Maple Walnut	Approx. Seating	Sections	Shipping Weight	Cubes
Millennium Square and Rectangular Tops 	6801-36-36	1837	4	1	52	3
	6801-42-42	2056	4	1	58	4
	6801-48-36	2108	4	1	65	3
	6801-48-42	2253	4	1	72	4
	6801-48-48	2319	4	1	84	4
	6801-60-30	2437	6	1	68	4
	6801-60-36	2490	6	1	78	4
	6801-60-60	3567	6	1	132	6
	6801-72-36	2714	6	1	100	5
	6801-84-42	3489	8	2	140	7
	6801-96-42	3821	8	2	180	8
	6801-96-48	4154	8	2	200	9
	6801-120-48	5017	10	3	240	11
	6801-120-54	5446	10	3	265	12
	6801-144-54	6242	12	3	310	14
	6801-168-54	7498	12	4	355	16
	6801-192-54	8183	12	4	400	18
	6801-216-60	9366	14	5	490	23
	6801-240-60	10409	16	5	560	25
	6801-264-60	11442	16	6	630	28
6801-288-60	12494	18	6	700	30	

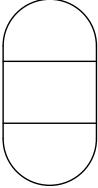
Millennium Racetrack Tops 	6802-72-36	3382	6	1	100	5
	6802-84-42	3612	8	2	140	7
	6802-96-42	3840	8	2	160	8
	6802-96-48	4147	8	2	185	9
	6802-120-48	5315	10	3	225	11
	6802-120-54	5697	10	3	255	14
	6802-144-54	6367	12	3	300	16
	6802-168-54	7656	12	4	345	16
	6802-192-54	8348	12	4	390	18
	6802-216-60	9862	14	5	480	23
	6802-240-60	10951	16	5	550	25
	6802-264-60	12048	16	6	620	28
	6802-288-60	12899	18	6	690	30

All Millennium Conference products are available on the Krug Express Program with a size limitation of up to and including 168" tables only.

ORDERING PROCEDURE

To order, please specify the following:

- 1) Krug product model number
- 2) Wood species and finish
- 3) Wood edge detail - S, V, T, M, B, Z or W
see page 3

STANDARD FINISHES

For a complete list of standard finishes please see page 29.

BASE REQUIREMENTS

See Page 8 for the base requirements chart.

MILLENNIUM | TOPS

Description	Model	Cherry Maple Walnut	Approx. Seating	Sections	Shipping Weight	Cubes
Millennium Boat Shaped Tops 	6804-96-48-42	4357	8	2	185	8
	6804-120-48-42	5983	10	2	255	10
	6804-144-48-42	6688	12	2	300	12
	6804-168-48-42	8039	12	3	345	12
	6804-192-54-48	8766	12	4	390	18
	6804-216-54-48	10352	14	5	480	23
	6804-240-54-48	11497	16	5	550	25
	6804-264-60-48	12653	16	6	620	28
	6804-288-60-48	13547	18	6	690	30

Millennium Arc Ended Tops 	6806-72-36	3382	6	1	100	5
	6806-84-42	3612	8	2	140	7
	6806-96-42	3840	8	2	160	8
	6806-96-48	4147	8	2	185	9
	6806-120-48	5315	10	3	225	11
	6806-120-54	5697	10	3	255	14
	6806-144-54	6367	12	3	300	16
	6806-168-54	7656	12	4	345	16
	6806-192-54	8348	12	4	390	18
	6806-216-60	9862	14	5	480	23
	6806-240-60	10951	16	5	550	25
	6806-264-60	12048	16	6	620	28
6806-288-60	12899	18	6	690	30	

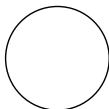
Millennium Round Tops 	6805-36 dia.	1833	3	1	48	3
	6805-42 dia.	2150	4	1	54	4
	6805-48 dia.	2339	5	1	74	4
	6805-54 dia.	3100	6	1	100	6
	6805-60 dia.	3864	7	1	134	6

All Millennium Conference products are available on the Krug Express Program with a size limitation of up to and including 168" tables only.

ORDERING PROCEDURE

To order, please specify the following:

- 1) Krug product model number
- 2) Wood species and finish
- 3) Wood edge detail - S, V, T, M, B, Z or W
see page 3

See Page 28 for *KrugExpress* program.

STANDARD FINISHES

For a complete list of standard finishes please see page 29.

WIRE ACCESS DOORS

Please specify wire access doors on bases when ordering tops in conjunction with wiring grommets.

MILLENNIUM | BASES

Description	Model	Cherry Maple Walnut			L	W	H	Shipping Weight	Cubes
Round Wood Drum	6810-18D-29	1034	18 Dia.	-	29	97	7		
Millennium Edge Detail	6810-24D-29	1054	24 Dia.	-	29	115	14		
	6810-30D-29	1375	30 Dia.	-	29	135	20		

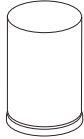

Please select a Millennium edge detail for this item.
 Please add **WMD** to the end of the model number for wire management.
 Wire management cavity for this base is:
 6810-18D-29 – 18” diameter by 16” in height
 6810-24D-29 – 24” diameter by 16” in height
 6810-30D-29 – 30” diameter by 16” in height

Half Round Wood Drum	6809-18-9-29	832	18 Dia.	9	29	68	4
Millennium Edge Detail	6809-24-12-29	991	24 Dia.	12	29	89	8
	6809-30-15-29	1094	30 Dia.	15	29	110	12

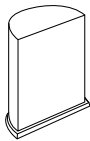

Please select a Millennium edge detail for this item.
 Please add **WMD** to the end of the model number for wire management.
 Wire management cavity for this base is:
 6809-18-9-29 – 1/2 of 18” diameter by 13 1/4” in height
 6809-24-12-29 – 1/2 of 24” diameter by 17 1/4” in height
 6809-30-15-29 – 1/2 of 30” diameter by 17 1/4” in height

Elliptical Wood Panel	6816-24-6-29	1083	24	6	29	25	4
	6816-30-6-29	1162	30	6	29	35	6

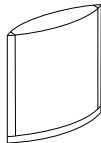

Wire management cavity for this base is:
 6816-24-6-29 – 24” elliptical shape width by 25” in height
 6816-30-6-29 – 30” elliptical shape width by 25” in height

Wood Panel	6815-28-6-29	937	28	6	29	30	4
	6815-34-6-29	1005	34	6	29	50	6

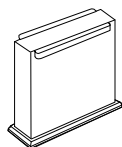

Wire management cavity for this base is:
 6815-28-6-29 – 28” x 6” rectangular by 25” in height
 6815-34-6-29 – 34” x 6” rectangular by 25” in height

DIMENSION KEY

L – length
 W – width
 H – height

Model numbers represent nominal dimensions only. Contact Customer Service if dimensions are critical.

STANDARD FINISHES

For a complete list of standard finishes please see page 29.

BASE REQUIREMENTS

See page 8 for the base requirements chart.

POWER BOXES

See page 9 for information on conferencing power boxes.

MILLENNIUM | BASE REQUIREMENTS CHART

Half Round Drum Base
6809

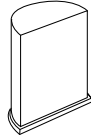

Round Drum Base
6810

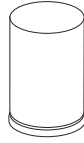

Elliptical Wood Panel
6816

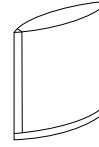

Wood Panel
6815

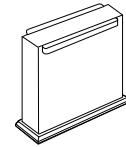







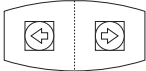

Top Size	Quantity	Size	Quantity	Size	Quantity	Size	Quantity	Size
36 diameter			1	18				
36 - 36			1	18				
42 diameter			1	18				
42 - 42			1	18				
48 - 36			1	18				
48 - 42			1	18				
48 diameter			1	18				
48 - 48			1	18				
54 diameter			1	24				
54 - 54			1	24				
60 - 30	2	18	2	18				
60 - 36	2	18	2	18	2	24	2	28
60 diameter			1	30				
60 - 60				1	30			
72 - 36	2	18	2	18	2	24	2	28
84 - 42	2	18	2	18	2	24	2	28
96 - 42	2	18	2	18	2	24	2	28
96 - 48	2	18	2	18	2	24	2	28
96-48-42	2	18	2	18	2	24	2	28
120 - 48	2**	18	2	18	3	24	3	28
120-48-42			2	18	3	24	3	28
120 - 54	2*	24	2	24	3	30	3	34
144 - 54	2*	24	2	24	3	30	3	34
144-48-42	2**	18	3	18	3	24	3	28
168 - 54	2*	24	3	24	4	30	4	34
168-48-42			3	18	3	24	3	28
192 - 54	2*	24	3	24	4	30	4	34
192-54-48			2	18	2	24	2	28
			1	24	2	30	2	34
216-54-48			2	18	2	24	2	28
			1	24	3	30	3	34
216 - 60			3	30	5	30	5	34
240-54-48			2	18	2	24	2	28
			2	24	3	30	3	34
240 - 60			4	30	5	30	5	34
264 - 60			4	30	6	30	6	34
264-60-48			2	18	2	24	2	28
			2	30	4	30	4	34
288 - 60			4	30	6	30	6	34
288-60-48			2	18	2	24	2	28
			2	30	4	30	4	34

*Add an additional 24" diameter drum base for center-support.
 **Add an additional 18" diameter drum base for center-support.

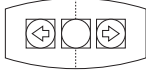
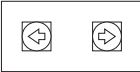
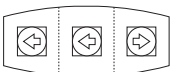
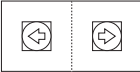
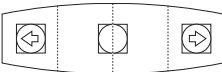
MILLENNIUM POWER BOX UPCHARGES

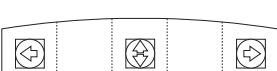
This chart applies to Millennium & Stratford square/rectangular, racetrack, arc ended and round tops:

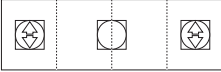
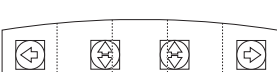
This chart applies to Millennium & Stratford boat shaped tops: racetrack, arc ended and round tops:

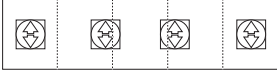
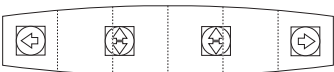
Single / Multi Section Tops	Standard Top Sizes	\$ Upcharge per table	Single / Multi Section Tops	Standard Top Sizes	\$ Upcharge per table
 68PB	36 diameter 36-36 42 diameter 42-42 48-36 48-42 48 diameter 48-48	873		96-48-42 144-48-42	1746
	54 diameter 54-54 60 diameter 60-60	1746		144-48-42	1746
	60-30 60-36 72-36	1746		120-48-42	2616
	84-42 96-42 96-48	1746		168-48-42 192-54-48	1746
	120-48	1746		216 - 54 - 48	3665
	120 - 54 *144 - 54	3665			
	*168 - 54 *192 - 54	3665		240 - 54 - 48	5582
	216 - 60	5582			
	240 - 60 288 - 60	7498		264-60-48 288-60-48	5582

* Stratford Conference tops only, feature single power box configuration.

Note: When specified with power boxes, standard tops sizes must be ordered in configurations shown above. Upcharges shown are list prices.

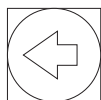

Indicate 18" round and square drum bases with one power box facing ends of top.



Indicate 24" and 30" round and square bases with twin power box facing sides of top.

CONNEXUS™

Connexus™ is Krug's proprietary tabletop connectivity solution. When opened, it presents power and data outlets on a convenient angle to the user and provides storage for wiring.

The faceplate of Connexus™ is available in either Glass or Aluminum and sits flush with the tabletop. It is designed to allow wiring to pass through the surface cover in both the open and closed positions. The faceplate opens to a 100° angle from the table top.

Connexus™ utilizes UL standard receptacle outlets. Connexus™ offers 11 pre-configured units with a wide selection of power, data and presentation system outlets, or alternatively can be purchased with just electrical ports with blank data ports. Connexus™ also can be designed and built specifically to meet your connectivity needs by using the snap-in or plate mounted port options.

All corded units can be modified to allow the units to be hard wired by an electrician and data ports can be reconfigured easily when desired. To facilitate this process, the Enclosure Box of each Connexus™ module is easily removable.

*All duplex outlets are contained within a metal box that is attached to the Partition Plate. If additional outlets need to be added in the future, these boxes need to be ordered from Krug to expand the enclosure. All modifications must be done by a qualified electrician.

The label drawing shown below illustrates the way a Connexus™ module is shipped to the user. The Partition Plate is mounted on-site to the underside of the top with the Enclosure Box over top to conceal the module. Please note, enclosure boxes are not required when modules are enclosed in a base. Enclosure boxes are not supplied with Connexus™ modules; they must be ordered separately when required.

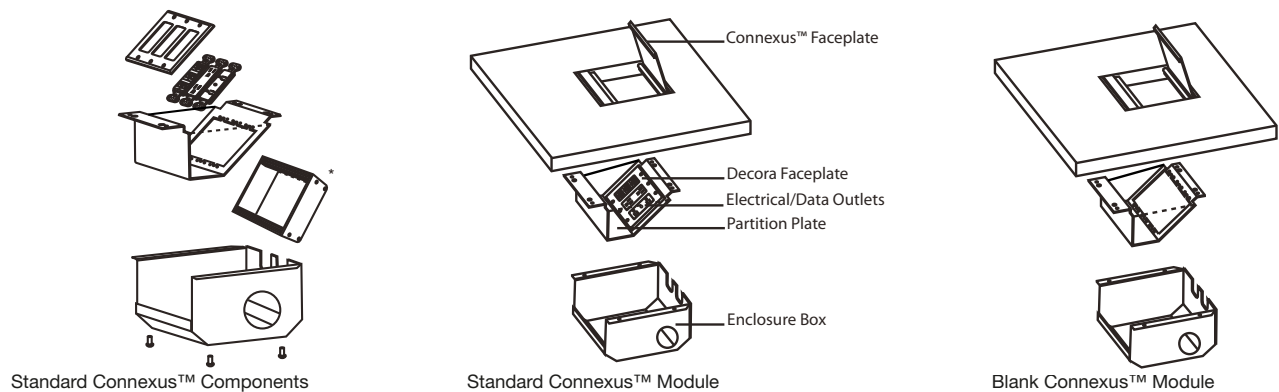

CONNEXUS™ SIZES

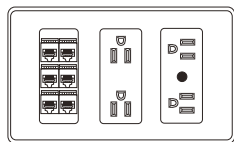

Standard - 3 Gang

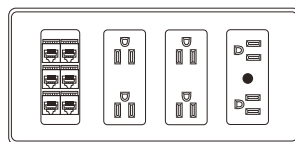

Large - 4 Gang

Connexus™ modules may be specified in Standard or Large sizes.

Standard modules are available in 7 standard configurations or custom configurations. Connexus™ modules in Standard configurations are 6 1/8" x 7 3/8". Depth on Standard module is 4.5".

Large modules are available in 4 standard configurations or custom configurations. Connexus™ modules in Large configurations are 8 1/4" x 7 3/8". Depth on Large module is 4.5".

CONNEXUS™

Connexus™ modules are wired independently of each other to maximize the amount of electrical devices serviced. All Connexus™ modules may sustain individual loads of 15 amps or 12 amps of continuous load. Each Connexus™ module will require a single isolated circuit to maximize its service capabilities. An optional utility a/c power outlet is available on the back surface of the outlet box.

Connexus™ components are UL and CSA US approved and manufactured in accordance to the National Electrical Code. Hardwiring Connexus™ modules on-site must be performed by a licensed electrician. Connexus™ units can be ordered with an optional utility outlet, which is located on the bottom side of the Connexus™ unit and underneath the work surface. Other Connexus™ products could employ these utility outlets as a source of power. In this scenario, it is solely the responsibility of the end user to assure that proper circuit protection is in place that never exceeds the 15 Ampere Circuit Breaker Rating.

ELECTRICAL CORD LENGTHS

Connexus™ modules come with pre-determined electrical cord lengths that are suited to the size and configuration of each table (16' & 25'). Each will plug into a standard floor monument power source. However, in situations where a table length exceeds our maximum cord length, a second power entry is necessary to avoid daisy-chaining of electrical power. To determine when a second power entry is required follow these steps:

1. Select your Connexus™ locations.
2. Select your Floor Monument Location(s) if they do not already exist in the room.
3. If the number of Connexus™ modules exceed three consecutive positions left or right of the power entry, then an additional power entry will be required.

Note: Connexus™ modules in pairs count as one position.

HARDWIRING ON SITE

For hardwiring on-site by electricians, please use the following schematic:

- ① Power Supply Cord
- ② Strain Relief
- ③ Fork Terminals
- ④ Duplex Receptacles
- ⑤ Outlets with Circuit Breaker Assembly
- ⑥ Handy Box

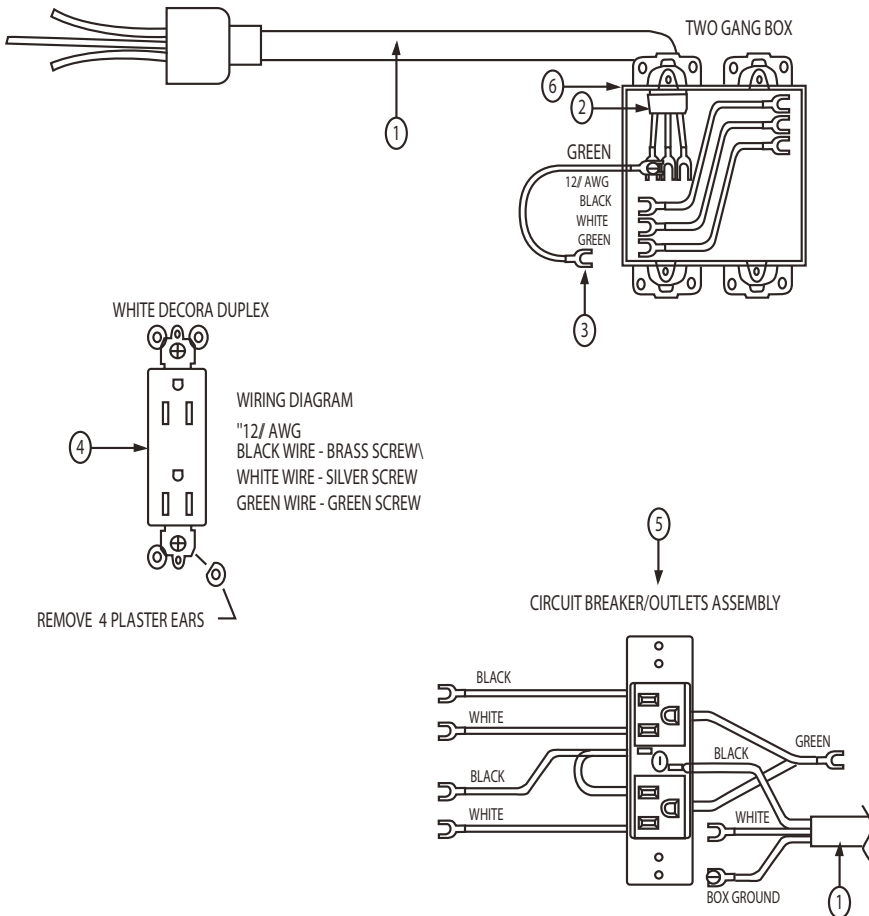

CONNEXUS™ | PRECONFIGURED STANDARD MODULES

Standard - 3 GANG

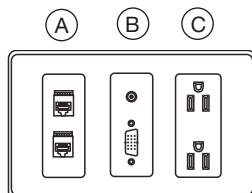
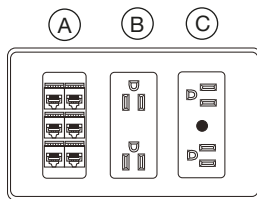
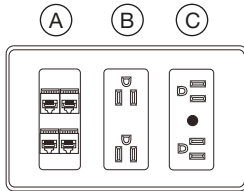
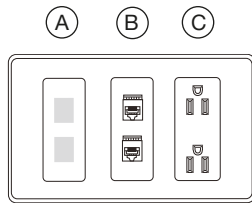
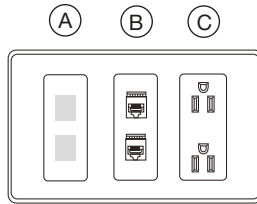

Port Options	Model #	List Price	
		Aluminum	Glass
BASIC DATA	62 CON BD	902	997
(A) (2) Blanks (for future use)			
(B) (2) RJ45 port (Category 6)			
(C) (2) AC power ports			
BASIC VOICE DATA	62 CON BV	874	970
(A) (2) Blanks (for future use)			
(B) (1) RJ11 port			
(B) (1) RJ45 port (Category 6)			
(C) (2) AC power ports			
EXPANDED DATA	62 CON ED	1109	1204
(A) (4) RJ45 port (Category 6)			
(B) (2) AC power ports			
(C) (2) AC power ports / with 15 amp circuit breaker			
EXPANDED VOICE/DATA	62 CON	1136	1231
(A) (2) RJ11 port			
(A) (4) RJ45 port (Category 6)			
(B) (2) AC power ports			
(C) (2) AC power ports / with 15 amp circuit breaker			
BASIC MULTIMEDIA	62 CON BM	1027	1122
(A) (1) RJ11 port			
(A) (1) RJ45 port (Category 6)			
(B) (1) 3.5 mm Mini			
(B) (1) VGA Type 15 pin HD			
(C) (2) AC power ports			

ORDERING NOTE: Enclosure box is only required only when the Connexus™ is not positioned over a base. If an enclosure box is required, please clearly state this requirement on your purchase order and add the **\$275** per Connexus™.

CONNEXUS™ | PRECONFIGURED STANDARD MODULES

Standard - 3 GANG

Port Options	Model #	List Price	
		Aluminum	Glass

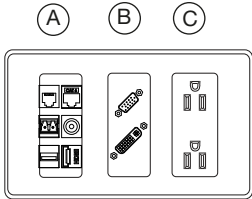

DATA & MULTIMEDIA	62 CON DM	1306	1394
<p>(A)</p> <ul style="list-style-type: none"> (1) RJ11 (1) RJ45 (1) Fiber Optic LC Duplex (1) 3.5mm Stereo Mini (1) USB "A" (1) HDMI <p>(B)</p> <ul style="list-style-type: none"> (1) DVI-I (1) VGA <p>(C)</p> <ul style="list-style-type: none"> (2) AC power ports 			

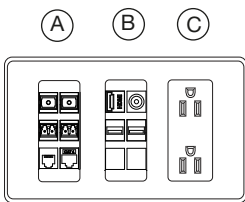

BASIC FIBRE OPTIC & MULTIMEDIA	62 CON BF	1254	1341
<p>(A)</p> <ul style="list-style-type: none"> (2) Fibre Optic SC Simplex (2) Fiber Optic LC Duplex (1) RJ11 (1) RJ45 <p>(B)</p> <ul style="list-style-type: none"> (1) HDMI (1) 3.5mm Stereo Mini (2) USB "A" (2) Blanks <p>(C)</p> <ul style="list-style-type: none"> (2) AC power ports 			

ORDERING NOTE: Enclosure box is only required only when the Connexus™ is not positioned over a base. If an enclosure box is required, please clearly state this requirement on your purchase order and add the **\$255** per Connexus™.

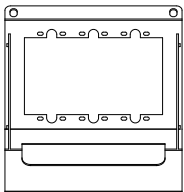

STANDARD BLANK MODULE	62 CON X1	103
Blank Modules does not include the Connexus™ lid.		

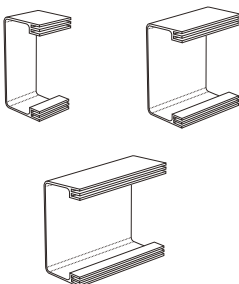

DUPLEX OUTLET ENCLOSURE	62 CON OUTBOX-1	40
To be used when adding duplex outlets to existing Connexus™ Modules.	62 CON OUTBOX-2	53
	62 CON OUTBOX-3	66

CONNEXUS™ | PRECONFIGURED LARGE MODULES

Large - 4 GANG

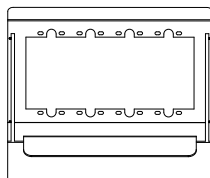
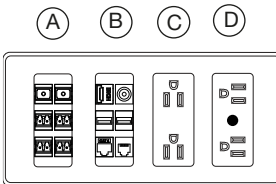
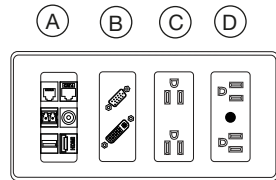
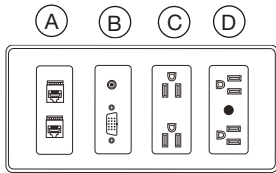
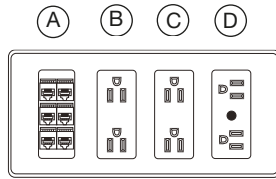

Port Options	Model #	List Price	
		Aluminum	Glass
<p>NETWORK AND POWER CENTRE</p> <ul style="list-style-type: none"> (A) (6) RJ-45 ports (B) (2) AC power ports (C) (2) AC power ports (D) (2) AC power ports/with 15 amp circuit breaker 	62 CON NP	1381	1463
<p>BASIC MULTIMEDIA WITH 2X POWER</p> <ul style="list-style-type: none"> (A) (1) RJ11 port (1) RJ45 port (B) (1) 3.5 mm Mini with 2x Power (1) VGA type 15 pin HD (C) (2) AC power ports (D) (2) AC power ports/with 15 amp circuit breaker 	62 CON B2	1264	1346
<p>DATA & MULTIMEDIA WITH 2X POWER</p> <ul style="list-style-type: none"> (A) (1) RJ11 port (1) RJ45 port (1) 1 Fiber Optic LC Duplex (1) 1 3.5mm Stereo Mini (1) 1 USB "A" (1) 1 HDMI (B) (1) DVI-I (1) VGA (C) (2) AC power ports (D) (2) AC power ports/with 15 amp circuit breaker 	62 CON DM2	1654	1736
<p>EXPANDED FIBRE OPTIC AND MULTIMEDIA</p> <ul style="list-style-type: none"> (A) (2) Fibre Optic SC Simplex (4) Fiber Optic LC Duplex (B) (1) HDMI, (1) Stereo 3.5 Mini (2) USB "A", (1) RJ45 (1) RJ11 (C) (2) AC power port (D) (2) AC power ports/with 15 amp circuit breaker 	62 CON EF	1721	1804
<p>LARGE BLANK MODULE</p> <p>Blank Modules does not include the Connexus™ lid.</p> <p>ORDERING NOTE: Enclosure box is only required when the Connexus™ is not positioned over a base. If an enclosure box is required, please clearly state this requirement on your purchase order and add the \$275 per Connexus™.</p>	62 CON X2		125

CONNEXUS™ | CUSTOM CONNEXUS™

Planning a custom Connexus™ unit is easy when following these 6 simple steps.

STEP ONE: Select the quantity of AC power ports or AC power ports with USB Charging (select configurations only) that are required.

Power modules must always be positioned starting from the right side of the unit. For example, 3 gang Connexus™ can have a power module located in position C with data ports in position A and B, or power can be located in position B and C with data port in position A, or position A,B and C can have all power ports or all data ports. Please note, 4 gang Connexus™ are not available with power ports located in position A.

On select configurations shown below, USB charging outlets are available. These charging outlets allow a user to charge most personal electronic devices without the need for any special power adapter or a computer - simply plug in your device with any compatible USB cable. This component has 2 USB charging slots that supply 5V DC at 700mA. Comes with a charging indicator light, as well as a standard 120 volt simplex receptacle on the bottom portion of the component.

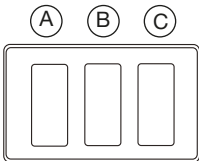
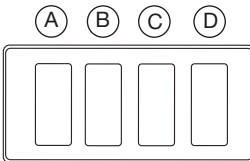
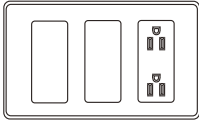
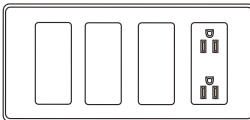
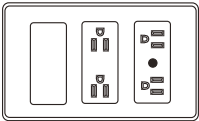
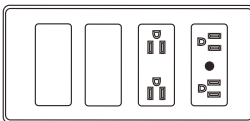
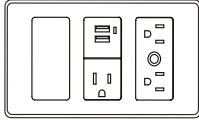
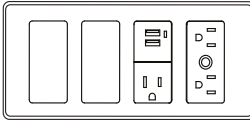
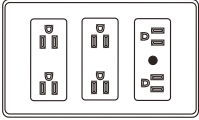
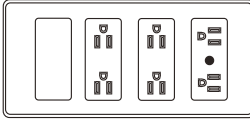
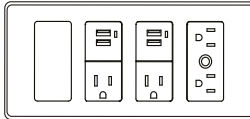
Standard Connexus™	List Price	Large Connexus™	List Price
 <p>3 Gang: Data ports only E300 - Standard Data Ports</p>	71	 <p>4 Gang: Data Ports only E400 - Large Data Ports</p>	145
 <p>3 Gang: AC Power Port E31S - Standard Outlet E31U - Standard & Utility Outlets</p>	481 514	 <p>4 Gang: AC Power Port E41S - Large Outlet E41U - Large & Utility Outlets</p>	541 575
 <p>3 Gang: AC Power Port / AC Power Port with 15 amp circuit breaker E32S - Standard Outlet E32U - Standard & Utility Outlet</p>	630 664	 <p>4 Gang: AC Power Port / AC Power Port with 15 amp circuit breaker E42S - Large Outlet E42U - Large & Utility Outlets</p>	706 738
 <p>3 Gang: AC Power Port Simplex with USB Charging/AC Power Port with 15 amp circuit breaker E32SC - Standard Outlet E32UC - Standard & Utility Outlet</p>	835 869	 <p>4 Gang: AC Power Port Simplex with USB Charging/AC Power Port with 15 amp circuit breaker E42SC - Standard Outlet E42UC - Standard & Utility Outlet</p>	910 943
 <p>3 Gang: (2) AC Power Port / AC Power Port with 15 amp circuit breaker E33S - Standard Outlet E33U - Standard & Utility Outlet</p>	766 800	 <p>4 Gang: (2) AC Power Port / AC Power Port with 15 amp circuit breaker E43S - Large Outlet E43U - Large & Utility Outlets</p>	754 788
		 <p>4 Gang: (2) AC Power Port Simplex with USB Charging/AC Power Port with 15 amp circuit breaker E43SC - Standard Outlet E43UC - Standard & Utility Outlet</p>	959 991

STEP TWO : There are two cord end options available; Plug In and Conduit. The standard Plug In option will connect with any standard floor monument power source. The Conduit option is Liguatite® (a steel inner conduit with a PVC overlay) by Anamet, meant for specific hard wiring applications. Units can come in cord lengths of 16' or 25'. Not Applicable if no power is selected.

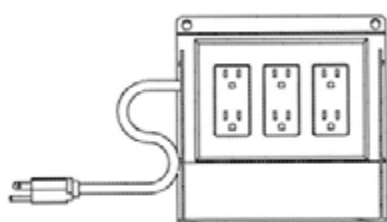

EP
Electrical Plug In
No Upcharge

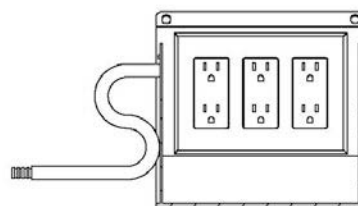

EC
Electrical Conduit
Add upcharge
16' 125
25' 208

CONNEXUS™ | CUSTOM CONNEXUS™

STEP THREE: There are two data options available; Plate mounted ports or Snap-in ports. Snap-in ports are available in configurations of two, four or six. Choose the faceplate below that meets your data requirements. If an odd number of Snap-in ports are required, a blank port needs to be selected when the opening is not in use.

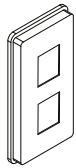

M02
Mounting Plate (2)
accepts two snap in data ports
Add \$36 list

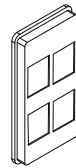

M04
Mounting Plate (4)
accepts four snap in data ports
Add \$36 list

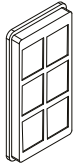

M06
Mounting Plate (6)
accepts six snap in data ports
Add \$36 list

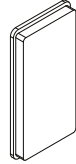

M00
Mounting Plates
Add \$36 list

STEP FOUR: Choose the Plate mounted port or Snap-in ports options for non-powered positions. As an aid, use the chart below to help design and build your Connexus™ to meet the rooms needs. Use the check boxes and list the components on the lines below.

Standard Connexus™

(A)	(B)	(C)
<input type="checkbox"/> POWER	<input type="checkbox"/> POWER/POWER & USB CHARGING	<input type="checkbox"/> POWER
OR	OR	OR
<input type="checkbox"/> PLATE MOUNTED PORT	<input type="checkbox"/> PLATE MOUNTED PORT	<input type="checkbox"/> PLATE MOUNTED PORT
OR	OR	OR
<input type="checkbox"/> SNAP-IN PORTS	<input type="checkbox"/> SNAP-IN PORTS	<input type="checkbox"/> SNAP-IN PORTS
_____	_____	_____
_____	_____	_____
_____	_____	_____

Large Connexus™

(A)	(B)	(C)	(D)
<input type="checkbox"/> POWER	<input type="checkbox"/> POWER/POWER & USB CHARGING	<input type="checkbox"/> POWER/POWER & USB CHARGING	<input type="checkbox"/> POWER
OR	OR	OR	OR
<input type="checkbox"/> PLATE MOUNTED PORT	<input type="checkbox"/> PLATE MOUNTED PORT	<input type="checkbox"/> PLATE MOUNTED PORT	<input type="checkbox"/> PLATE MOUNTED PORT
OR	OR	OR	OR
<input type="checkbox"/> SNAP-IN PORTS	<input type="checkbox"/> SNAP-IN PORTS	<input type="checkbox"/> SNAP-IN PORTS	<input type="checkbox"/> SNAP-IN PORTS
_____	_____	_____	_____
_____	_____	_____	_____
_____	_____	_____	_____

STEP FIVE: Select the Connexus™ Cover (Aluminum or Glass)

Standard Connexus™

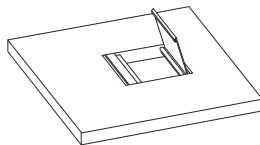

3 GANG

3CCA	Aluminum	\$344 list
3CFG	Glass	\$425 list
3C00	No Lid	

Large Connexus™

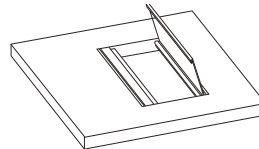

4 GANG

4CCA	Aluminum	\$356 list
4CFG	Glass	\$439 list
4C00	No Lid	

STEP SIX: Enclosure box is only required only when the Connexus™ is not positioned over a base. If an enclosure box is required, please clearly state this requirement on your order and add the **\$275** per Connexus™.

STEP SEVEN: Calculate the total list price for the custom Connexus™ by adding the following prices:

- Connexus™ Box with required AC Power Ports
- Faceplate (Snap-in Ports Only)
- Snap-In Ports or Plate Mounted Data Ports
- Enclosure Box (if required)
- Connexus™ Lid (Aluminum or Glass)



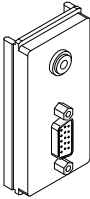
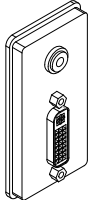
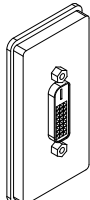
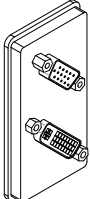
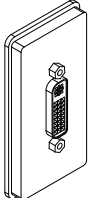
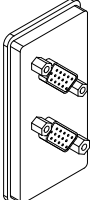
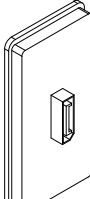

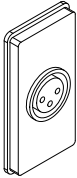
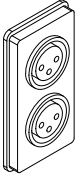
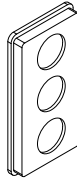
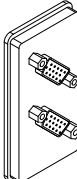
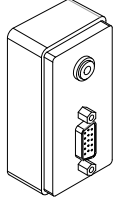
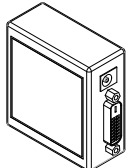

CONNEXUS™ | PORT OPTIONS

PLATE MOUNTED PORTS	Reference Code	Description	List Price
	P01	VGA & 3.5 STEREO MINI - Use for VGA (DB15) connections and for 3.5mm stereo connections. Connector is a female input with screw terminal output (back side of Console interface).	131
	P02	DVI-I DUAL (DIGITAL/ANALOG) & 3.5 STEREO MINI - Use for DVI Integrated - Digital and Analog connections and for 3.5mm stereo connection. The DVI connector is a Dual Link. DVI-I connector is a female-to-female pass through and the 3.5 Mini is a female input with screw terminal output (back side of Console interface).	193
	P03	DVI-D DUAL (DIGITAL) - Use for DVI-D Digital only connection. The connector is a Dual Link. Connector is a female-to-female pass through.	125
	P04	DVI-I DUAL (DIGITAL/ANALOG) & VGA - Use for DVI Integrated - Digital and Analog and for VGA (DB15) connections. The DVI connector is a Dual Link. Both connectors are female-to-female pass through.	247
	P05	DVI-I DUAL (DIGITAL/ANALOG) - Use for DVI Integrated - Digital and Analog connections. DVI connector is a Dual Link. Connector is a female-to-female pass through.	158
	P06	VGA-2 - Use for two VGA (DB15) connections. Both connectors are female-to-female pass through.	153
	P07	DISPLAYPORT - Use for DisplayPort connection. This connector is primarily used to connect a video source to a display device and also carries audio signals, Connector is a female input to a 3' corded output (back side of Console interface) with a male Display Port termination.	153

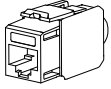

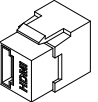
CONNEXUS™ | PORT OPTIONS

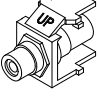
PLATE MOUNTED PORTS	Reference Code	Description	List Price
	P08	MICROPHONE XLR STANDARD - Use for standard size XLR microphone connection. Connector is a female input with a 3 pin screw terminal output (back side of Console interface).	208
	P09	MICROPHONE STANDARD XLR -2 - Use for two standard size XLR microphone connections. Each connector is a female input with a 3 pin screw terminal output (back side of Console interface).	303
	P10	3 HOLE CABLE PASS THROUGH - Use for running loose cables from the under side of the table up into the Console interface cavity. Often used with running wires for PolyCom™ devices.	50
	P11	VGA-to-BNCx2 - Use for two VGA (DB15) connections that are input female pass through and are terminated on the output (back side of Console interface) with 5 BNC female pigtail connections, for each VGA connector.	493
	P12	INPUT VGA & 3.5 Stereo (POWERED) - VGA + Audio Line Driver designed for VGA (DB15) connections and for 3.5mm stereo connections. This unit provides a method of transmitting signals to a remote display and audio receiver or amplifier. VGA connector is a female input and comes with cabling for either VGA output, or 5 BNC output and the 3.5 Mini is a female input with screw terminal output (back side of Console interface). A 9 volt DC 500mA power supply is required to power this unit.	1204
PORT ACCESSORIES	Reference Code	Description	List Price
	DVIR	DVI-REPEATER - Is a cable equalizer that automatically compensates for long DVI cable runs. This unit extends the usable cable distance up to 130ft depending on the quality of the cable and the resolution of the video signal. Additionally, it is capable of extending dual link signals allowing for much greater resolutions and refresh rates. This unit comes with a power supply and is generally mounted underneath a table.	950

CONNEXUS™ | PORT OPTIONS

SNAP IN PORTS	Reference Code	Description	List Price
	S01W S01B S01R	RJ-45 - Category 6 data connection. This connector is also downwards compatible with Category 5 cabling. Connector is a female input with a #110 punch-down terminal block output (back side of Console interface) for on-site hard wire connection. RJ45-CAT6 (White) RJ45-CAT6 (Blue) RJ45-CAT6 (Red)	43
	S02W S02B S02G S02R S02Y	RJ11 - Telephone type connection. Connector is a female input with a #110 punch-down terminal block output (back side of Console interface) for on-site hard wire connection. RJ11 (White) RJ11-B (Black) RJ11-G (Green) RJ11-R (Red) RJ11-Y (Yellow)	30
	S03	3.5 STEREO MINI - 3.5mm stereo connection. Connector is a female input with screw terminal output (back side of Console interface).	84
	S04	HDMI - High Definition Multimedia Interface connection. Connector carries both HD audio and video data. Connector is a female-to-female pass through.	158
	S05	RCA-LEFT - RCA left audio channel connection. Color coded with black. Connector is a female-to-female pass through.	36
	S06	RCA-RIGHT -RCA right audio channel connection. Color coded with red. Connector is a female-to-female pass through.	36
	S07	RCA- VIDEO - RCA video channel connection. Color coded with yellow. Connector is a female-to-female pass through.	36
	S08	USB-A - Full size USB "A" style connection. Connector is a female-to-female pass through.	57

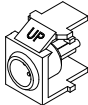
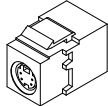
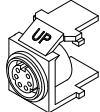
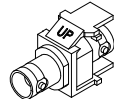
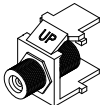
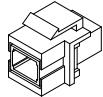
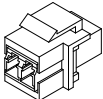
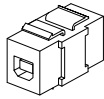
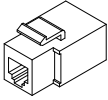
CONNEXUS™ | PORT OPTIONS

SNAP IN PORTS	Reference Code	Description	List Price
	S09	3 PIN MINI XLR - 3 Pin Mini XLR microphone connection. Connector is a female input to a 6' corded output (back side of Console interface) with a 3 Pin Mini XLR male termination.	671
	S10	S-VIDEO - S-Video connection. Connector is a female-to-female pass through.	62
	S11	PS/2 (6 PIN MINI DIN) - PS/2 (mouse, keyboard, other input devices) connections. Connector is a female-to-female pass through.	78
	S12	BNC - BNC style data connection for use with co-axial cable. Connector is a female-to-female pass through.	43
	S13	F-TYPE - F-Type (DSL, Cable) connections, generally for high speed Internet or video applications. Connector is a female-to-female threaded pass through.	36
	S14	FIBER OPTIC SC - Fibre Optic SC Simplex connection. Connector is a female-to-female pass through. Please note that two of these connectors are required to complete the data transmissions to and from the source and destination units.	43
	S15	FIBER OPTIC LC - Fibre Optic LC Duplex connection. Connector is a female-to-female pass through. One connector only is required to complete the data transmissions to and from source and destination units.	84
	S16	USB-B - USB "B" type connection. Connector is a female "B" input to a female "A" output (back side of Console interface). This connector is reversible.	125
	S17	RJ12 (White) - RJ12 style PolyCom™ connection. Connector is a female input with a 6' corded output (back side) of Console interface) with a male RJ12 termination.	268
	S00	BLANK COVER - Blank covers are required when port is not in use.	16
		NOTE: Up to 6 snap-in data ports can be ordered for open data positions. Snap-in adaptors can accept 2, 4 or 6 snap-in data ports. Please order a blank port when an odd number of snap-in ports are specified.	

MILLENNIUM | CONNEXUS™ LOCATIONS CHARTS

TOP STYLES

BASE STYLES

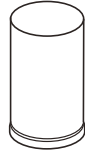
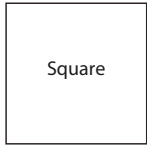

Round Drum Base

The Connexus™ Locations diagrams below show the available Connexus™ locations for only the top and base configurations shown above. Please note that the maximum allowable Connexus™ modules per top are shown, and tops may be specified with fewer modules. Each Connexus™ module has a code to represent its location on the table surface. To specify a Connexus™ module in a particular location, please use the code listed above it.

Note: One Connexus™ module is available where two modules are shown. Please refer to location code above the drawing for single center location in which case the Connexus™ unit will face West if on the left end of the top, and East if on the right end of the top. For large Connexus™ units please replace “3” in location code with “4”.

ACN3

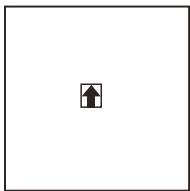

Represents 42” and 48” top locations

ACN3

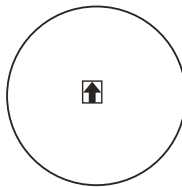

Represents 42”, 48” and 54” top locations

ACN3

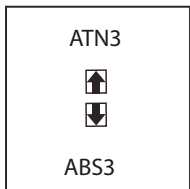

Represents 60” top locations

ACN3

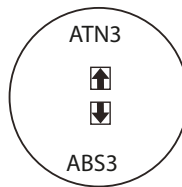

Represents 60” top locations

18” Drum bases will accommodate single standard Connexus™ units only.
 24” Drum bases will accommodate single standard or large Connexus™ units only.
 30” Drum bases will accommodate single or double standard or large Connexus™ units.



REPRESENTS MODULES THAT WHEN OPENED FACE THE ENDS OF THE TABLE



REPRESENTS MODULES THAT WHEN OPENED FACE THE SIDES OF THE TABLE

MILLENNIUM | CONNEXUS™ LOCATIONS CHARTS

TOP STYLES

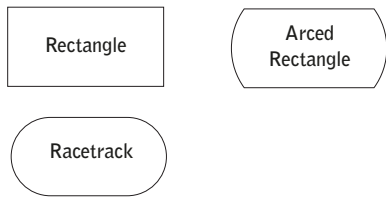

BASE STYLES

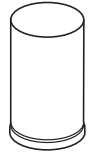

Round Drum Base

The Connexus™ Locations diagrams below show the available Connexus™ locations for only the top and base configurations shown above. Please note that the maximum allowable Connexus™ modules per top are shown, and tops may be specified with fewer modules. Each Connexus™ module has a code to represent its location on the table surface. To specify a Connexus™ module in a particular location, please use the code listed above it.

Note: One Connexus™ module is available where two modules are shown. Please refer to location code above the drawing for single center location in which case the Connexus™ unit will face West if on the left end of the top, and East if on the right end of the top. For large Connexus™ units please replace “3” in location code with “4”.

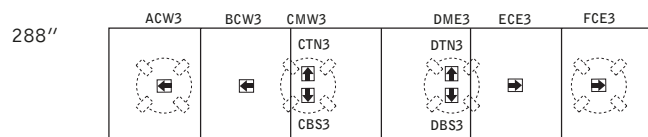
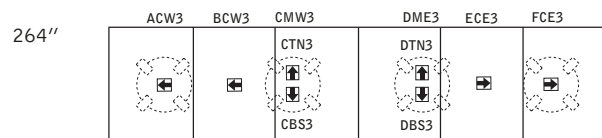
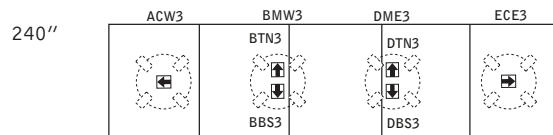
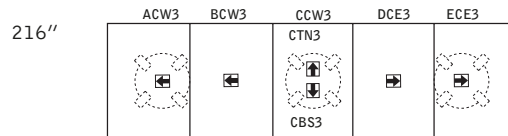
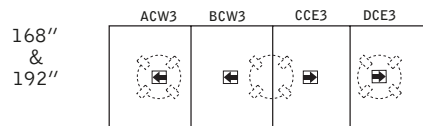
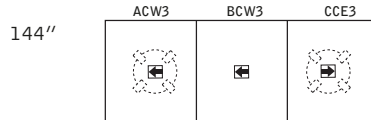
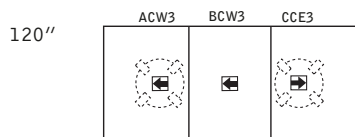
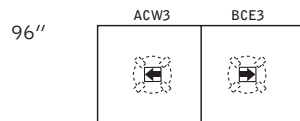
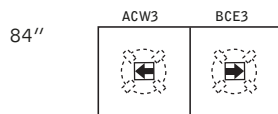
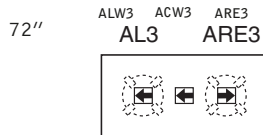
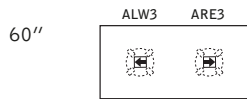

18" Drum bases will accommodate single standard Connexus™ units only.
 24" Drum bases will accommodate single standard or large Connexus™ units only.
 30" Drum bases will accommodate single or double standard or large Connexus™ units.

REPRESENTS MODULES THAT WHEN OPENED FACE THE ENDS OF THE TABLE

REPRESENTS MODULES THAT WHEN OPENED FACE THE SIDES OF THE TABLE

MILLENNIUM | CONNEXUS™ LOCATIONS CHARTS

TOP STYLES

BASE STYLES

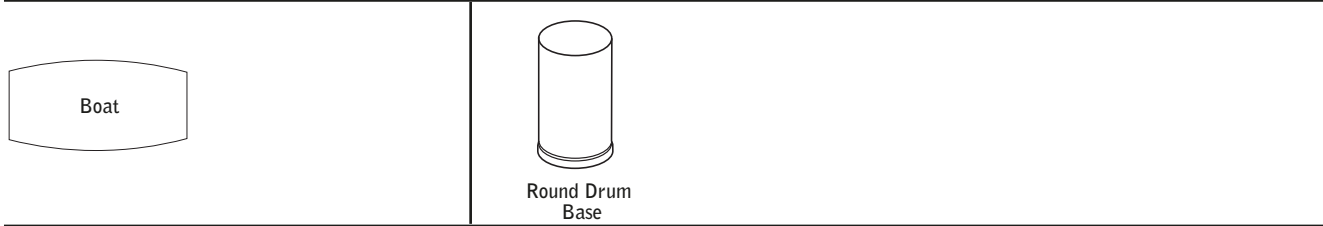



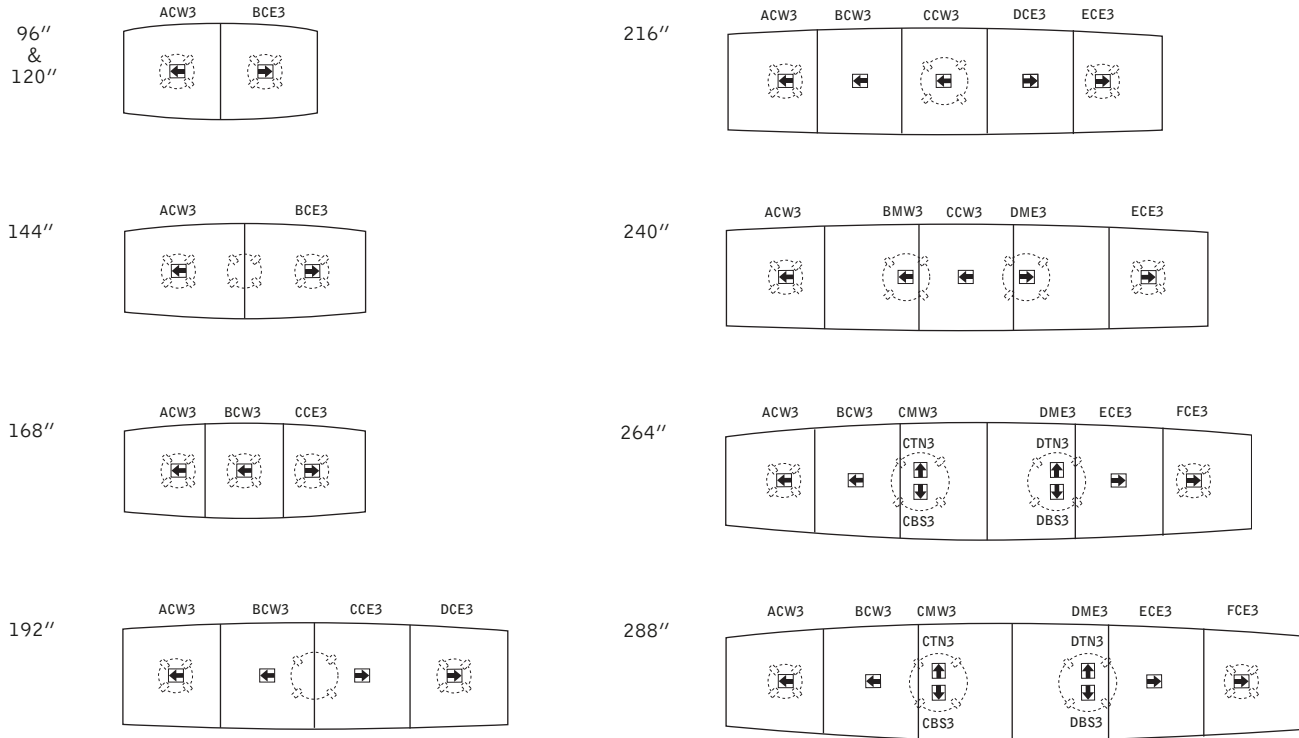

The Connexus™ Locations diagrams below show the available Connexus™ locations for only the top and base configurations shown above. Please note that the maximum allowable Connexus™ modules per top are shown, and tops may be specified with fewer modules. Each Connexus™ module has a code to represent its location on the table surface. To specify a Connexus™ module in a particular location, please use the code listed above it.

Note: One Connexus™ module is available where two modules are shown. Please refer to location code above the drawing for single center location in which case the Connexus™ unit will face West if on the left end of the top, and East if on the right end of the top. For large Connexus™ units please replace “3” in location code with “4”.



18" Drum bases will accommodate single standard Connexus™ units only.
 24" Drum bases will accommodate single standard or large Connexus™ units only.
 30" Drum bases will accommodate single or double standard or large Connexus™ units.

  REPRESENTS MODULES THAT WHEN OPENED FACE THE ENDS OF THE TABLE

  REPRESENTS MODULES THAT WHEN OPENED FACE THE SIDES OF THE TABLE

MILLENNIUM | CONNEXUS™ LOCATIONS CHARTS

TOP STYLES

BASE STYLES

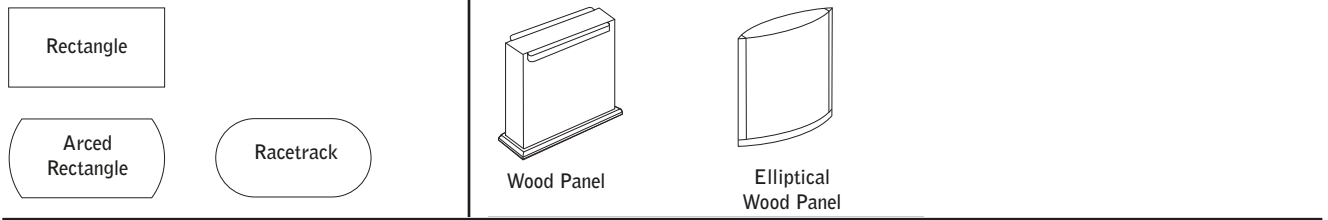

The Connexus™ Locations diagrams below show the available Connexus™ locations for only the top and base configurations shown above. Please note that the maximum allowable Connexus™ modules per top are shown, and tops may be specified with fewer modules. Each Connexus™ module has a code to represent its location on the table surface. To specify a Connexus™ module in a particular location, please use the code listed above it.

Note: One Connexus™ module is available where two modules are shown. Please refer to location code above the drawing for single center location in which case the Connexus™ unit will face West if on the left end of the top, and East if on the right end of the top. For large Connexus™ units please replace “3” in location code with “4”.

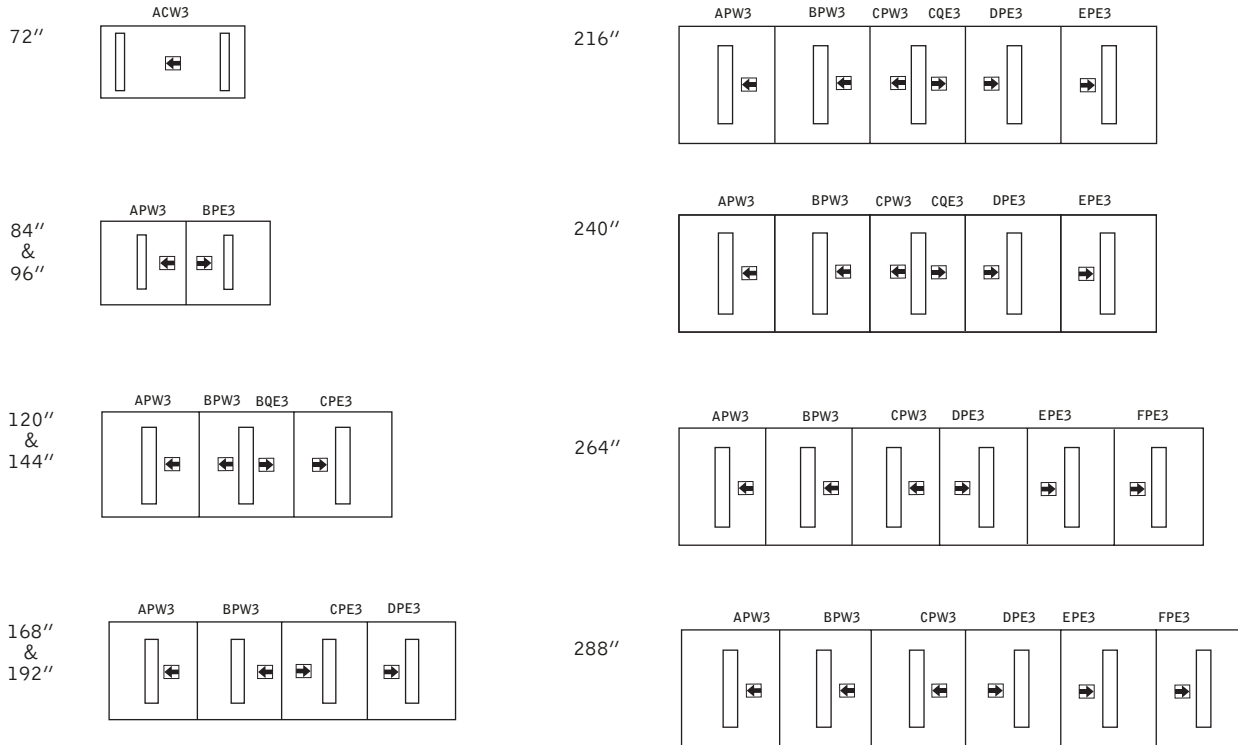

REPRESENTS MODULES THAT WHEN OPENED FACE THE ENDS OF THE TABLE

REPRESENTS MODULES THAT WHEN OPENED FACE THE SIDES OF THE TABLE

MILLENNIUM | CONNEXUS™ LOCATIONS CHARTS

TOP STYLES

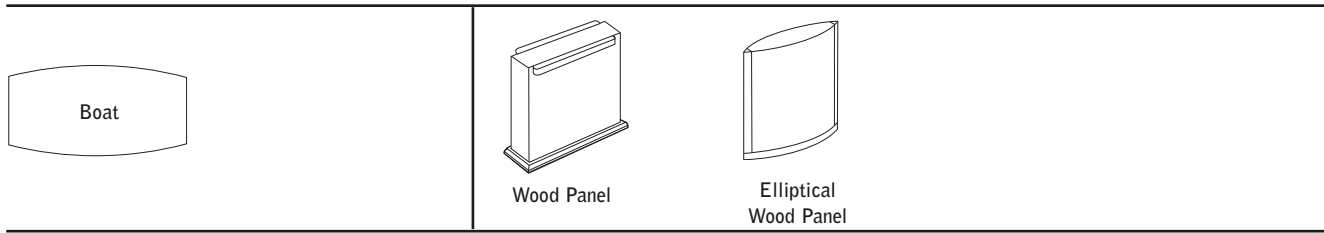

BASE STYLES



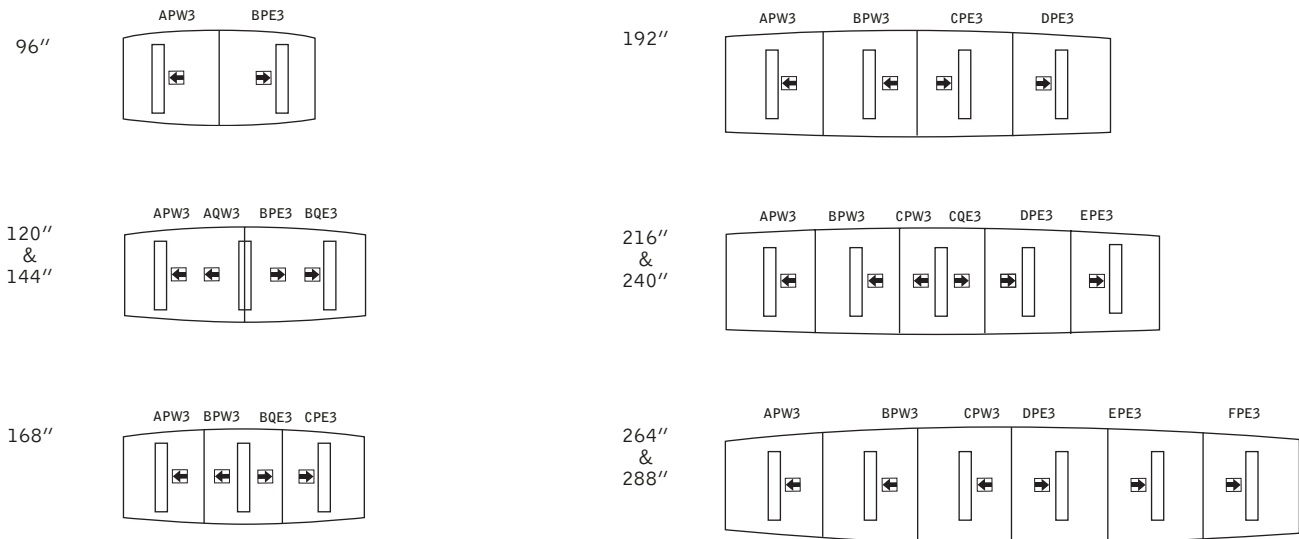

The Connexus™ Locations diagrams below show the available Connexus™ locations for only the top and base configurations shown above. Please note that the maximum allowable Connexus™ modules per top are shown, and tops may be specified with fewer modules. Each Connexus™ module has a code to represent its location on the table surface. To specify a Connexus™ module in a particular location, please use the code listed above it.

Note: One Connexus™ module is available where two modules are shown. Please refer to location code above the drawing for single center location in which case the Connexus™ unit will face West if on the left end of the top, and East if on the right end of the top. For large Connexus™ units please replace “3” in location code with “4”.



  REPRESENTS MODULES THAT WHEN OPENED FACE THE ENDS OF THE TABLE

  REPRESENTS MODULES THAT WHEN OPENED FACE THE SIDES OF THE TABLE

MILLENNIUM | MEDIA

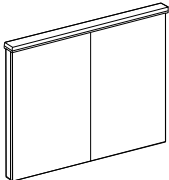
Description	Model	Cherry Maple Walnut	L	w	H	Shipping Weight	Cubes
	68VB-3632	2898	36.25	5.25	32	89	4
	68VB-4832	3159	48	5.25	32	105	6
	68VB-4848	3321	48	5.25	48	143	9

Includes an upholstered tackboard or optional cork surface. Please specify a tackboard fabric when ordering. Visual boards also include a flip chart and four dry erase markers. An optional pull down screen is also available at **\$253 list**.

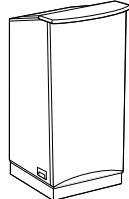
	Full Height Lectern	68LN-272348	4138	27.25	23	48.5	194	21
---	---------------------	-------------	------	-------	----	------	-----	----

Includes one open shelf and one closed shelf, an electrical plug-in and four casters. An adjustable reading light is also available at an upcharge of **\$238 list**. Please select hardware pull and finish.

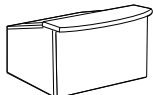
	Table Top Lectern	68LN-272320	1541	27.2	22.8	19.6	30	7
---	-------------------	-------------	------	------	------	------	----	---

	Buffet	68BU-712036	5279	71	20.25	36	380	55
---	--------	-------------	------	----	-------	----	-----	----

Includes one cutlery tray in drawer and an adjustable shelf in each of the three storage compartments. Please select hardware pull and finish.

	Audio Visual Mobile Cabinet	68TV-362461	5544	36	24.25	61	210	44
---	-----------------------------	-------------	------	----	-------	----	-----	----

Cabinet has pocket doors on top and hinged doors on bottom. Includes a pull-out swivel T.V. shelf, a VCR shelf, grommets for wire management and air vents in back panel.

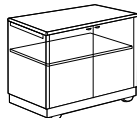
	Mobile Cart	68PS-362436	3282	36.25	24.25	36	145	20
---	-------------	-------------	------	-------	-------	----	-----	----

Interior shelf is adjustable. Cart comes with a 2" grommet in back center located 8 1/2" below the top.

ORDERING PROCEDURE

To order, please specify the following:

- 1) Krug product model number
- 2) Wood species and finish
- 3) Wood edge detail - S, V, T, M, B, Z or W
see page 3
- 4) Pull style and finish, see page 3

STANDARD FINISHES

For a complete list of standard finishes please see page 29.

BASE REQUIREMENTS

See page 8 for the base requirements chart.

GENERAL INFORMATION

Terms and Conditions

Net 30 days on approved credit. A late payment charge of 1% per month will be applied on overdue invoices. This charge will be pro-rated to the number of days past 30 days that the invoice is overdue. All applicable sales taxes are extra. Distribution of this price list does not in itself constitute an offer to sell. Orders can be received only from authorized Krug dealers. Acceptance of any order and terms of sale may be established at the discretion of Krug. Deposits are required on orders received from new accounts as well as on large or special orders. Krug reserves the right to discontinue designs, or to change designs, construction, prices, or materials without notice.

Contact Information

Phone: 1.888.578.KRUG (5784) | Fax: 1.519.748.5177

Purchase Order Fax: 1.888.236.4783

Purchase Order E-mail: orders@krug.ca

Web: www.krug.ca E-mail: solutions@krug.ca

Customer Service Hours

Please note customer service hours are:

8:30 am to 5:00 pm est

Customer Satisfaction

It is the primary goal of Krug and our staff to ensure the complete satisfaction of our customers with our products and performance. If a problem arises with a Krug product after the expiration of the limited warranty period, Krug will exercise its best efforts to achieve the satisfaction of the customer in a manner that is fair to all concerned.

Order Acknowledgments

Each order will be acknowledged via e-mail or fax. This acknowledgment is the final agreement between Krug and the customer, superseding all previous communications regarding the purchase order. Where there is a discrepancy on a purchase order between a product code and a description, Krug will make every effort to resolve the discrepancy, but will be ruled by the product code ordered. Please check all acknowledgments for accuracy, and advise Krug of any discrepancies with a purchase order.

Order Cancellation

Krug reserves the right to not accept or allow cancellation of orders. All products are manufactured on a custom-made, make-to-order basis, and the purchasing, engineering and production of orders begins shortly after order placement - and the customer purchase order is a contract that authorizes Krug to manufacture the products. Acceptance of order cancellation (or partial cancellation) is solely at the discretion of Krug, and is dependent on the extent to which engineering, purchasing and manufacturing has been initiated by the time cancellation is requested. No order cancellations (partial or otherwise) are allowable more than 4 weeks from date of order placement (as order production is unable to be terminated by that point), and full payment of the acknowledged order value is required for any orders cancelled after 4 weeks. Cancellations may be allowable in less than 4 weeks after order placement, depending on the extent to which manufacturing has been initiated. An acceptance of order cancellation requires that the purchaser agrees to make payment for all costs incurred to the point of acceptance of cancellation. Cancellation charges include all costs for purchase of dedicated material and components, engineering costs for non-standard products, and all costs for manufacturing completed to that point, as well as a \$350 net charge for processing of the original order and for processing of cancellation invoicing.

Pricing

Krug endeavors to ensure that all prices in this price list reflect accurately our current prices. However, errors do occur and will be rectified through notices to the field. Krug reserves the right to acknowledge pricing that may be different from the price list.

Storage Charges

Krug reserves the right to assess a nominal storage charge if a customer does not accept shipment of an order within a week of the ship date.

Warranty

Krug warrants the construction and the finish of all our products to be free from defects in materials and workmanship for a period of 10 years from the date of purchase. This warranty is applicable to products in use by their original purchaser. This warranty does not apply to components not manufactured by Krug including textiles, which are subject to the specific warranties of those manufacturers, if any. Textiles (fabric, leather, vinyl, or any other covering material) suppliers do not guarantee their products for durability and color fastness, and nor does Krug. Casters, mechanical and electrical components have a warranty of five years from the date of purchase. The Krug warranty does not apply to COM-specified materials, damage caused by a carrier other than Krug, or variation in wood finishes due to natural wood color variation. Krug cannot be held responsible for variations in fabric dye lots from order to order. All fabric is carefully inspected when it is received, but a degree of variation in color should be expected. Repairs or replacement of any defect covered under this warranty by Krug will be made, at our option and method, at no charge to the original purchaser during the warranty period. Krug's judgement is final and binding with respect to the nature or cause of defects or damage, and the necessity or manner of repair or replacement.

This warranty does not apply to defects or damage resulting from:

- normal wear and tear occurring with the use of the product
- negligence, misuse, excessive use, alteration, improper cleaning or repair
- substitution or use of incorrect or unauthorized components or material
- handling or installation that is incorrect, or that causes damage or defect
- damage incurred by a freight carrier other than Krug
- wearing of finishes and fabrics, and normal variations in materials (including dye lot variations)
- properties of natural materials, including wood and leather
- exposure to environments with uncontrolled temperature and humidity (products must be transported, stored and used in climate-controlled conditions)

Export Packaging

Krug is pleased to provide the option for export packaging on all our products, to provide additional protection from damage. For shipments overseas, a quote for export packaging can be provided, based on the products to be ordered and the delivery destination - please contact Customer Service or Bids & Specification Support for more information and a quotation. KRUG is not responsible for shipment damage occurring on overseas shipments

Export Packaging is STRONGLY RECOMMENDED for:

- (A) all shipments outside of the lower 48 states and Canada.
- (B) all shipments that will be held in storage for an extended period prior to installation.

Important: Please note that Krug will not be responsible for damage claims on product shipped or stored in the above conditions but where export packaging has not been utilized.

Dimensions

Dimensions are in inches and approximate, and subject to change without notice. Contact Customer Service if dimensions are critical.

Installation Support

For assistance please contact Technical Support at 1-888-578-5784 x216 or e-mail installationhelp@krug.ca and you will be directed to the appropriate installation support person.

Custom Capabilities

Over 15% of our orders involve some type of custom work, and we invite our customers to make use of our extensive capabilities. These include:

- 1) Dimensional customization of standard size products
- 2) Custom wood finishes
- 3) For larger orders, completely custom-designed products, as well as non-standard wood species can be specified.

Custom orders may require additional production lead times. Contact Customer Service for more information.

Freight Terms and Conditions

1. All product is shipped FOB the Krug factory. Freight is either pre-paid to the destination or not pre-paid, depending on established customer specific freight terms.
2. Docks at the selected delivery location must be equipped to handle a 53' trailer. If a dock is inadequate for delivery by Krug, Krug will re-deliver to another local location and any additional costs will be charged to the customer.
3. For all deliveries, it is understood that Krug or its agent is making a dock delivery only (equipped to handle a 53' trailer), and any further work of truck unloading, delivery beyond the dock, installation, and removal of packaging is not authorized or paid for by Krug.
4. Drop shipments to the installation site, and timed deliveries, are available on larger shipments (full truckloads or slightly less) at no additional charge. Drop shipments or timed deliveries for smaller shipments may not be available, or if available will require a surcharge. Deliveries on an after hours basis, or on weekends, or any other special requirements, may be subject to a surcharge. Location and contact information, and the requested time of delivery, is required at least one week prior to the acknowledged shipment date. If this information is not provided one week in advance, or if the location or time of the drop shipment is changed less than one week in advance, a surcharge may be applied, and/or the drop shipment may not be scheduled. For deliveries requested Monday to Thursday after 5:00 pm, please apply a surcharge of \$250/shipment. For deliveries requested Monday to Friday before 7:00 am, please apply a surcharge of \$250/shipment. For deliveries requested Friday (after 3:00 pm) or weekends, please apply a surcharge of \$500/shipment. (local times).
5. For all deliveries - whether to the Customer location or drop shipment - any circumstances that result in the delay of our carrier (including unsuitable receiving facilities, or facilities not open or available), service charges will be applied at the rate of \$75/hour. Where re-delivery is necessary because of these circumstances, the full cost of re-delivery will be charged. If Less Than Truck Load is delivering, one hour is allocated to unload. Any additional time required to unload after the first hour is \$75/hour. If a Truck Load is delivering the order, three hours is allocated to unload. Any additional time required to unload is \$75/hour. Direct deliveries to site for large orders are possible, (must exceed \$60,000 net), and accommodate 48 - 53' trailers. Krug is responsible for delivery to the approved delivery address. If an address change is required, this must be authorized by Krug 5 business days prior to ship date. Any additional delivery costs incurred after this time will be charged to the customer.

Product Strength and Durability Testing

All Krug Conference products meet or exceed the testing requirements of ANSI/BIFMA X5.5-2014 or X5.9-2012.



Damaged Shipments

All Krug product is well engineered, carefully inspected, and expertly loaded onto our trucks at our Distribution Center. If you receive any damaged freight, we ask that you do not refuse the shipment. Krug is not responsible for damage to goods that occurs in transit or storage. It is the purchaser and/or receiver's responsibility to examine the goods upon receipt and to notify Krug of any damages, overages or shortages. Any discrepancies should be noted on the Bill of Lading. The delivering carrier will not accept responsibility for shortages or damages if signed "clear". Notification of concealed damage claims must be made to Krug Distribution within 5 days of delivery, along with digital pictures if available. All product and packaging must be available for inspection. Krug liability ceases after 5 business days and Krug will not be responsible for concealed damages if shipments are left unopened. Krug is not responsible for the condition of product that is stored or installed in an environment where temperature and humidity are not controlled.

Field Product Report Authorization

Krug's written authorization, in the form of an FPR number, must be obtained prior to incurring charges of any kind if Krug is expected to pay these charges. This includes authorization for returns, field repairs and replacements, post field repairs, installation and delivery charges. Krug reserves the right to have its representative inspect product related to any request for such authorizations, prior to that authorization being provided. Deductions from invoices paid for any charges to Krug, without prior written authorization in the form of an FPR, will not be accepted. Digital photographs may be required to complete the FPR process.

Care and Maintenance

Wood Finishes - Although Krug's extensive finishing process ensures a durable finish on all our products, there are several steps that can be taken to protect and prolong the life and beauty of the finish. Protect the top by placing felt pads on the bottom of any accessories and mechanical equipment. Rubber and oil will permanently mark surfaces. Use a desk pad to prevent possible damage and imprinting caused by writing instruments and sharp objects. Dust only with a clean, dry cloth, going with the grain. Clean any marks with a damp cloth, using a small quantity of mild soap or detergent. Do not use any wax-based polish, spray or silicone. Eventually, a film will build up and discolor the top. Do not place your furniture in a position of permanent exposure to direct sunlight.

Plastic Laminates - Clean plastic laminates with mild soap and warm water. Do not use steel wool, hot water, or any abrasive cleaning product.

Krug Panel Fabric Program

Tackboards can be upholstered in COM material supplied by the customer, and in a selection of stocked tackboard fabrics supplied by Momentum. The Momentum Panel fabrics are available on Krug Express. They are 100% polyester. For additional information and color selections, please refer to our Panel Fabrics card and Krug's website. www.krug.ca PRODUCTS / FABRICS / PANEL
The Momentum panel fabrics pass ASTM-E84-87 Fire Codes.
If memo samples are required please call Momentum at 1-800-366-6839.



PROGRAM DETAILS

KrugExpress orders are ready to ship by the date acknowledged. Delivery and shipping schedules may result in actual shipping of orders at a later date. Statutory holidays and scheduled factory vacations may add to acknowledged lead times of *KrugExpress* orders. Unless otherwise specified on the order, the customer's standard method of shipping Krug products will be utilized.

Available factory capacity for *KrugExpress* is filled by orders received on a "first come, first serve" basis. If the normal *KrugExpress* lead time is not available for your order because available capacity has been filled, you will be immediately advised of the earliest available ready-to-ship date. Please consult your Customer Service representative in advance if you wish to confirm the specific lead time availability for a *KrugExpress* order.

Orders must be received by midnight of a given day for that day to be considered the official day the order is received. Order lead times are acknowledged from the date the order is received, but not including the date the order is received.

KrugExpress orders must be "clean" when received in order to be considered officially received on a given day, and lead times will be acknowledged from the date orders are determined to be "clean".

Changes to *KrugExpress* orders are not allowed under any circumstances. Orders for product on *KrugExpress* must clearly state: "*KrugExpress*".

MILLENNIUM | WOOD FINISHES & LAMINATES

WOOD FINISHES

Standard wood finishes are:

SPECIES	FINISH
MAPLE	Clear Maple
	Honey Maple
	Wheat Maple
WALNUT	Natural Walnut
	Regular Walnut
	Dark Walnut
	Cordovan Walnut
CHERRY	Appalachian Cherry
	Imperial Cherry
	Medium Cherry
	Natural Cherry
	Standard Cherry
	American Cherry
	Sable Cherry
Light Cherry	
PALETTE FINISHES	Black
	White
	Sand
	Soft Green
	Steel Blue
	Slate

NATURAL CHARACTERISTICS OF WOOD

Wood is a natural product with inherent color variations that will never be fully mitigated by the finishing process. Please anticipate variation in colors within a single unit, from piece to piece, and from Krug wood finish samples. If a very close match is required, a sample must be provided with the order and an upcharge will apply. Exact color matches are not possible.

CUSTOM WOOD FINISHES

Add 10% list to your order for special finishes, minimum upcharge is \$500 list per finish per order. (For example, on all orders up to \$5000 list, an upcharge of \$500 will apply, on orders \$5000 and up add 10% list to your order.)

For orders with special finishes, a sample that is a minimum 3" by 3" must be received with the order. Special finishes may add additional lead time to production schedules.

Since wood is a natural product, some variations in grain, color and stain acceptance will occur. In our finishing processes, we try to minimize variations, but some variation between samples and finished goods should be anticipated.

Birdseye Maple

Bookmatched Birdseye Maple veneer is available on Millennium at an upcharge of **\$70 list** per square foot. Specify clearly on order. Birdseye Maple is recommended in a clear finish only. Birdseye Maple only applies to tops.

Dual Finishes

Add 10% list per item if specifying dual finish.

WOOD FINISHES TO MATCH STANDARD LAMINATES

Copper on Cherry
 Shiraz Cherry
 Park Avenue Walnut
 Chocolate on Walnut
 Nutmeg on Walnut
 Dark Walnut
 Hardrock Maple

LAMINATES

Krug's in-stock Laminates are available in 16 different laminate selections. Please note that 4 of the colors (Gingerbread, Portobello, Ash and Willow) have textured finishes and may not be appropriate for use in patient areas due to infection control concerns. Minimum order quantities and extended lead times may apply for exotic laminate colors, please check with customer service. Polymer Edge will be selected to match the worksurface. Krug's previous laminate in-stock program will be phased out as in-stock supply depletes. Please contact customer service for availability.

IN-STOCK LAMINATES

Wood Grain Laminates	High Pressure Laminate Supplier	Textured Wood Grain Laminates	High Pressure Laminate Supplier
Champagne	Tafisa T492CR	Gingerbread	Tafisa T556UR
Hardrock Maple	Formica 86992-58	Portobello	Tafisa T557UR
Dune	Tafisa T491CR	Ash	Tafisa T535AT
Copper	Tafisa T521CR	Willow	Tafisa T543AT
Shiraz Cherry	Tafisa T472CR	Solid Laminates	
Park Avenue Walnut	Wilsonart 7984-38	Designer White	Wilsonart D354-60
Chocolate	Tafisa T498CR	Platinum	Tafisa T202CR
Nutmeg	Tafisa T477CR	Earth	Tafisa T767CR
Dark Walnut	Tafisa T469CR	Charcoal	Tafisa T228CR



All products are air emissions certified and are available as FSC® certified

krug

solutions@krug.ca | www.krug.ca | 1.888.578.KRUG