

MILLENNIUM
Price and Specification Guide
USA



Effective, January 1, 2025

krug

Advancing Design Through Innovation

MILLENNIUM | TABLE OF CONTENTS

245	Environmental Summary
246	Finishes
247	Custom Sizing & Pricing Methods
248	General Product Specification
249	Edge Detail Profile
249	Drawer Pulls & Locks
250	Grommets, PowerPorts & Wire Mgmt
251	Laminate Worksurfaces Desks Overheads Hutches
252	Filing Instructions & Installation
253	Height Adjustable Worksurface with Base Enclosure
254	Sample Configuration
255	Product Enhancements
257	Desks
267	Height Adjustable Worksurfaces
275	Returns
280	Linking & Corner Units
282	Credenzas
290	Overheads
291	Hutches
297	Shells
300	Mobile Tables
301	Accessories
303	PowerPorts
306	Bookcases
309	Storage
314	Wardrobes
315	Modular Tops
317	Pedestals
319	Reception

MILLENNIUM CASEGOODS | ENVIRONMENTAL SUMMARY

LEED CERTIFICATION



MATERIAL CONTENT:

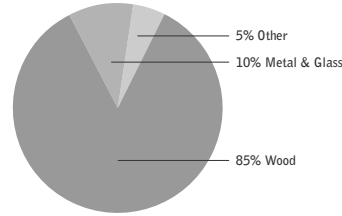

PRE-CONSUMER RECYCLED CONTENT - 81%

POST-CONSUMER RECYCLED CONTENT - 3%

		CONTRIBUTES TO
Credit 2.1 - 2.2	Construction Waste Management	1-2 point(s)
Credit 3.3	Resource Reuse	1 point
Credit 4.1	Recycled Content	1 point
Credit 4.2	Recycled Content	1 point
Credit 4.5	Low Emitting Materials, (MUST BE REQUESTED) Composite Wood & Laminate Adhesives	1 point
Credit 5.1	Regional Materials*	1 point
Credit 6	Rapidly Renewable Materials (MUST BE REQUESTED)	1 point
Credit 7	Certified Wood (MUST BE REQUESTED)	1 point

*This credit is only applicable if in total 20% of the combined value of the procurement of construction materials and in the furniture are manufactured within a radius of 500 miles. This credit will apply if the installation of the finished product occurs within 500 miles of Kitchener, Ontario.

level® CERTIFICATION



BIFMA's e3 Furniture Sustainability Standard is a voluntary, multi-attribute standard that measures the degree of sustainability of furniture. This standard evaluates product and company environmental attributes and compliance systems in a wide range of elements which include Materials, Energy & Atmosphere, Human & Ecosystem Health and Social Responsibility. Millennium products have earned level®, BIFMA's sustainability certification program for furniture, certification through third-party verification against the e3 standard. All Millennium products can be supplied with level® certification. In order to accomplish this, the product must also be ordered with the air-emissions-certification option. Contact customer service for information and upcharges.

AIR-EMISSIONS

All Millennium products can be supplied with air-emissions-certified materials. Contact customer service for information and upcharges.



the mark of responsible forest

FSC®

FSC® In 2005, Krug received Forest Stewardship Council® (FSC®) Chain-of-Custody certification for our manufacturing facilities. The FSC® Chain-of-Custody tracks certified wood from seedling to final sale. It verifies that the material for our FSC® certified products only come from well-managed, FSC®-certified forests and other controlled sources. FSC® is dedicated to the promotion of responsible forest management worldwide helping to take care of forests for future generations. Millennium and other Krug products can be specified with FSC® Certification. Contact customer service for further information, pricing and lead times.



In addition, architects, designers, and building professionals can specify FSC®-certified products in order to achieve a point from the US Green Building Council's Leadership in Energy and Environmental Design (LEED) Rating System.

WOOD FINISHES

Standard wood finishes are:

SPECIES FINISH

Cherry	Light Cherry Natural Cherry American Cherry Medium Cherry Standard Cherry Imperial Cherry Appalachian Cherry Sable Cherry
Maple	Clear Maple Honey Maple Wheat Maple
Walnut	Natural Walnut Regular Walnut Mahogany on Walnut Dark Walnut Cordovan Walnut

WOOD FINISHES TO MATCH STANDARD

LAMINATES

Copper on Cherry
Shiraz Cherry
Park Avenue Walnut
Chocolate on Walnut
Nutmeg on Walnut
Dark Walnut
Hardrock Maple

NATURAL CHARACTERISTICS OF WOOD

Wood is a natural product with inherent color variations that will never be fully mitigated by the finishing process. Please anticipate variation in colors within a single unit, from piece to piece, and from Krug wood finish samples. If a very close match is required, a sample must be provided with the order and an upcharge will apply. Exact color matches are not possible.

CUSTOM WOOD FINISHES

Add 10% list to your order for special finishes, minimum upcharge is \$600 list per finish per order. (For example, on all orders up to \$6000 list, an upcharge of \$600 will apply, on orders \$6000 and up add 10% list to your order.)

For orders with special finishes, a sample that is a minimum 3" by 3" must be received with the order. Special finishes may add additional lead time to production schedules. Since wood is a natural product, some variations in grain, color, and stain acceptance will occur. In our finishing processes, we try to minimize variations, but some variation between samples and finished goods should be anticipated

BIRDSEYE MAPLE

Bookmatched Birdseye Maple veneer is available on Millennium at an upcharge of **\$76 list per square foot**. Specify clearly on order. Birdseye Maple is recommended in clear finish only. Birdseye Maple only applies to tops.

DUAL FINISH

Add 10% net per item if specifying dual finish

VENEER

Millennium veneer is flat cut

MILLENNIUM | CUSTOM SIZING & PRICING METHODS

CUSTOM SIZING

Now you can customize the sizing of most components and obtain prices immediately using a few simple guidelines. Customized products may require an extended lead time if they have not been previously engineered. Please see following page for instructions.

Products that can be custom sized:

Desks, Table Desks, Curvilinear Desks (excluding curvilinear shaped units with a non-standard radius)

Linking Units

Returns, Curvilinear Returns (excluding curvilinear shaped units with a non-standard radius), Kneehole Credenzas, Full Face Credenzas Shells

Modular Tops

Modesty Panels (excluding perforated modesty panels)

Hutches, Wall Units, Wood Door Overheads, Wood Door Work Walls

Bookcases, Wood Door Storage Units

Gallery Desks, Gallery Kneehole Credenzas, Gallery Linking Units, Gallery Returns

Paper Managers 6800, 6900, & 9800 (excluding those with drawers)

PRICING METHOD

Custom widths: Apply the price of the same unit in the price list that is one standard size larger than the desired case size (but same depth). For example: The required custom dimension is 74" x 24". The first standard size above this is 78" x 24", so in this case, you would apply the price of the 78" x 24" unit.

Custom depths: Apply the price for the same unit one size deeper (but same width). For example: The required custom dimension is 72" x 26". The first standard size above this is 72" x 30", so in this case, you would apply the price of the 72" x 30" unit.

Custom width & depths: Apply the price for the same unit both one size wider and one size deeper.

For example: The required custom dimension is 74" x 26". The first standard size above this is 84" x 30", so in this case, you would apply the price of the 84" x 30" unit.

Custom height of desk height cases: Add 18%. (31-32" HI)

OTHER PRICING METHODS

cases where tops are flush left/right or both, add	\$120 list
Grommets in non-standard positions, add:	\$152 list
To remove hutch or overhead doors, deduct:	4% list
convert 5-hi hutch to 6-hi hutch, add:	20% list
Bookcases with optional pull out printer shelf at standard shelf height, add:	\$238 list
Bookcases with optional vent in back (includes 2 vents and 1 grommet), add:	\$302 list
2 lateral file and 3 or 4 closed shelves - convert to half open, half closed shelves, add	15% list
2 lateral file and 3 or 4 closed shelves - convert to half open, half wa drobe, add:	15% list
To remove storage doors for open shelves, deduct:	4% list
glass transition tops, add:	\$1095 list (30" & under)
- glass transition tops are affixed via brushe	\$1266 list (Over 30" up to 60")
metal stanchions, and finished with brushed metal caps	\$1423 list (over 60" up to 84")
	\$1584 list (over 84" up to 96")
glass tops on buffets, add:	\$2374 list (for 60, 72, & 84" cases)
Angire, add:	20% list on Maple pricing

EXCEPTIONS TO THE PRICING METHODS ABOVE

Sizes larger than the largest shown Price List.

Non-standard extension on drawer slides.

Non-standard drawer depths in standard depth pedestals.

Glass door - any style.

Glass - face mounted modesty panels.

Perforated modesty panels.

Cases with curvilinear tops where the radius becomes non-standard.

A/V cabinets.

Any case with flipper doors

Please contact Specials Coordinator or Krug Customer Service at 1.888.578.KRUG if you require assistance.

PLEASE NOTE: Cases with non-standard features do not apply to the rules above.

Contact Krug Customer Service if you require assistance.

MILLENNIUM | GENERAL PRODUCT SPECIFICATIONS

WORKSURFACES

Tops are made of 1 1/2" - 45 lbs. per cubic foot density particle board core with face and back veneer. All edges have 1 1/2" wide 3/4" thick Walnut, Cherry or Maple headers.

GABLES

Gables are 1 1/8" thick - 45 lbs. per cubic foot density particle board core, 3 ply. Edges are banded with veneer.

VENEER

External face veneers are #1 grade flat sliced Black Walnut, Cherry or Maple book-matched and of uniform color and grain pattern.

SOLIDS

All solids used shall be American Black Walnut, Cherry or Maple kiln-dried by the manufacturer to a 6% moisture content.

FINISH

All finished surfaces are well sanded before applying finishing materials. The procedure begins by applying a base color via an N.G.R. stain. A wash coat follows to further enhance the color. A filter coat is applied to fill open pores and wipe clean. A sealer coat is applied and scuff-sanded to prepare for the top coat (finish). The final procedure is to apply catalyzed varnish that when dry has a sheen value of 32°.

LOCKS

Locks are standard on all pedestals and storage unit lateral file drawers
Locks are optional on door fronts and must be specified at time of order.
For Master Key, note clearly on p.o. and **add \$40 list.**

DRAWERS

Desk box drawers have fully progressive full extension slides and are load rated at 100 lbs. per drawer.
Desk files drawers have a load bearing capacity of 130 lbs. and box drawers have a load bearing capacity of 100 lbs.
Other pedestal file drawers have fully progressive, full extension slides and are load rated at 100 lbs. per drawer.
All drawer interiors are clear finished Birch on particle board constructed with dowels.
All file drawers are equipped for letter and legal filing
All box/box/file pedestals in desks only are supplied with one matching pencil tray.

GLIDES

Adjustable glides are installed at factory and allow for 3/4" adjustment.

HINGES

Doors have a European style hinges with a 95° opening.

PULLS

Pulls are available in Satin Nickel, Matte Black, Polished Chrome, Black Chrome and Brushed Brass.
Please specify on your order.

TESTING INFORMATION

Millennium meets or exceeds the testing requirements of ANSI/BIFMA X5.5-2014 and/or X5.9 - 2012.



MILLENNIUM | EDGE DETAIL PROFILES, DRAWER PULLS & LOCKS

An edge detail profile must be selected for every Millennium product.
Millennium product is available in the following profile options



Seville - contrasting crisp and rounded sculpted edge



Valen - transitional beveled edge



Torrens - softened square edge



Madrid - ribbon fluted edge



Barcelona - half round edge



Zamora - bull nose edge



Williamsburg - traditional edge

PROFILE LOCATIONS

Desk, Credenzas and Shells: profile is located on all side

Curvilinear Shaped Tops: profile is located on all four side

Bookcase and Storage Units: profile is located on all four side

Hutches: profile is located on all three sides

Link Units, Curvilinear Returns and Returns: when units are connected to create a larger worksurface area, some profile options have coved edges to create a smooth transition from one surface to another.

The following profiles have coved edges on connecting ends of return and linking units: Seville, Valen, Barcelona, Williamsburg, Zamora All other profile options will appear on all sides of the case, meeting each other face to face at worksurface connection points

DRAWER PULLS

Luna, Eclipse and Crescent Pulls are available in Satin Nickel, Matte Black, Polished Chrome, Black Chrome, and Brushed Brass. Pull color and style must be stated clearly on the purchase order. Pulls are located on all drawer fronts, storage wood doors, and bookcase wood doors. Glass door bookcases feature the Luna knob in the same finish as pulls on the order. Glass door hutches and wood door hutches do not have pulls.



Luna



Eclipse



Crescent



Oyster pulls are available in Matte Black, Polished Chrome, and Brushed Brass.



WILLIAMSBURG

A Williamsburg pull in Polished Brass is standard on all products specified with the Williamsburg edge detail.

LOCKS

Locks are provided as a standard features on all pedestals, including those in desks, credenzas and lateral file storage units. Lock plugs on desks are located in the kneespace on the pedestal side panel. Locks are not available on all glass doors. Locks are available on bookcase doors at an upcharge of **\$152 list** per set of (2 doors, please specify at time of order. If a hutch or overhead has an uneven amount of doors the single lock required is also **\$152**. Lock plugs for bookcase doors are generally located on the top inside corner of the door front. Lock plugs for hutch and overhead doors are generally located on the lower inside corners. Suites can be keyed alike at no upcharge, please specify on your purchase order

MILLENNIUM | GROMMETS & POWERPORTS

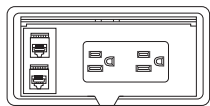

POWER / DATA / VOICE MODULE (SUPPLIED WITH WIRED HUTCHES)

Black, rectangular with flip down cove . Includes two power outlets, one voice port, and one data port.

POWER DETAILS:
two Simplex outlets
15 Amp, 10 ft. cord

COMMUNICATION DETAILS:
one 6-pin and one 8-pin connector

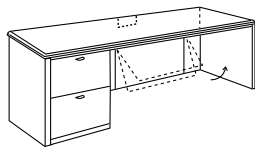

WIRE MANAGEMENT CUT-OUT AND HINGED MODESTY PANELS

Returns, link units and credenzas with fixed modesty panels can be specified with an 8" x 1 1/2" wire management cut-out. All hinged modesty panels feature a cut-out as a standard. The discreet cut-out allows for clean and easy access to power, data and communication sources.

GROMMETS

All cases may be specified with one grommet in a standard position at no upcharge. A **\$152 list upcharge** will apply to additional grommets in standard positions and for grommets requested in non-standard positions a **\$152 list upcharge** will apply.

The grommet position must be indicated for each case on the purchase order.

Standard Grommet

Black or Grey, rectangular, 4 1/8" x 2 11/16". Please note grommet color on purchase order.

Please specify grommet color when ordering, Grommets can also be field installed with power drill 2 1/4 hole saw and rasp or saber saw. Template for drilling is available.

Please keep in mind the location of grommets when specifying paper managers for use with worksurfaces. For example, a paper manager on the left hand side may be used with a "C", "BR" or "AR" grommet.

POWERPORT

A PowerPort is a unique worksurface mounted module that can be specified to a location that best serves the user's needs. It includes a UL approved electrical, voice and data power bar, containing two 115 - volt electrical simplex outlets which are accessible from the work surface, plus a utility outlet at the end for daisy chaining purposes. 3 data versions are available.

PORT

A service module having no power bar will serve as a large grommet. A hinged lid easily enables the passage of several cables and devices

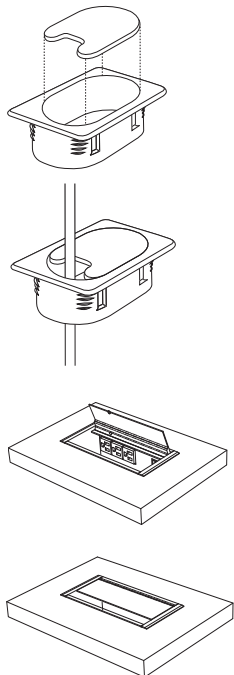

STANDARD GROMMET POSITIONS

Desks, Credenzas, Link Units & Returns

30" Deep Desks:

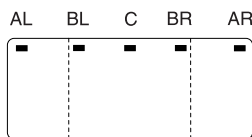

Position Code:

- AL – left corner
- BL – left end beside pedestal gable
- C – center
- BR – right end beside pedestal gable
- AR – right corner

36" Deep Desks:

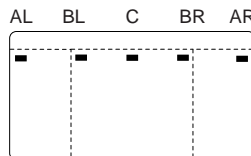

Position Code:

- AL – left corner
- BL – left end beside pedestal gable
- C – center
- BR – right end beside pedestal gable
- AR – right corner

NOTE

Please do not specify grommets in the "C" position for 60-71" ganged pedestal returns and credenzas. In these cases, the "C" position is over the top of a pedestal.

"BL" and "BR" are only available on tops 42" or longer.

CURVILINEAR TOPS

Position Code:

C – center

This key applies to all B, P, Q, and K shaped tops.

The support panel is notched out to accommodate wire management.

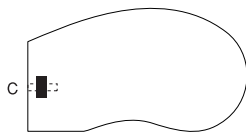

MILLENNIUM | LAMINATE, DESKS, OVERHEADS & HUTCHES

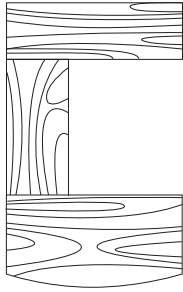

LAMINATE WORKSURFACES

Laminate worksurfaces are available at an upcharge of 10% (a higher upcharge may apply to specially priced plastic laminates). Where there are wood profile edges on worksurface tops, they will remain as wood profile on laminate tops. Krug will order and procure laminates. Purchase orders with a plastic laminate option must include Laminate name.

When specifying laminate worksurfaces, the grain direction is such that the grain pattern runs the length of each surface, as shown in the diagram on the left.

Please contact Krug Customer Service for questions pertaining to laminate grain direction.

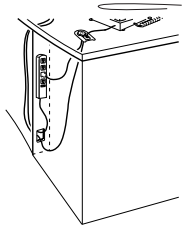

DESKS WIRE MANAGEMENT CAVITY

Millennium desks can also be specified with a hidden wire management cavity. This finished cavity is accessed from the front of the desk by a hinged door and is completely concealed in the closed position. The wire management cavity includes a four receptacle power bar mounted on the inside pedestal gable. This feature allows the use of several powered items on the desk surface and greatly reduces the number of cables routed to the primary power source. The hinged cavity also effectively conceals all excess cables from view.

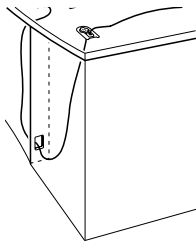

PEDESTAL ACCESS WIRING GROMMET

All Millennium desks allow for wire management behind the pedestal drawers. Pedestal gables feature a standard cable management opening allowing access to the rear of the pedestal cavity. By specifying a wiring grommet in a standard AL or AR position (see grommet locations on page 251, cable can be conveniently threaded behind the pedestal drawers and through the wire management access grommet.

Combined with our standard wire management cover, all cables are neatly tucked out of view.

BIRDSEYE MAPLE

Birdseye Maple Veneer is available on 6800 Millennium worksurfaces at an upcharge of **\$76 list per square foot**. Birdseye Maple is recommended in a clear finish only. This option could extend regular lead times.

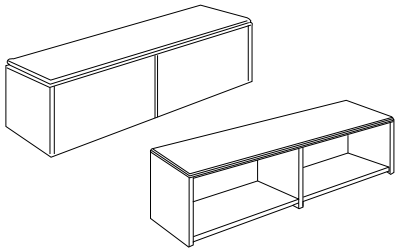

OVERHEADS

Overheads include tasklights that are factory installed and require no field adjustment. Tasklights are mounted beneath the cabinet and hidden from view. Cords run down the right hand side of the tasklight to the worksurface where they can be routed behind the worksurface top. The use of a wall mounted tackboard conceals the cord from view. Tackboards must be ordered separately and can be specified in any fabric grade (1-9. Wall mounted tackboards for overheads are supplied with all necessary hardware for installation. Locks are optional on overheads and can be specified at time of order for an upcharge of **\$152 list per set** of (2) doors.

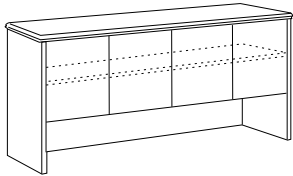

HUTCHES

Hutches include tasklights that are factory installed and require no field adjustment. Tasklights are mounted beneath the cabinet and hidden from view. Glass doors on hutches are wood framed clear glass. A tackboard in Krug Momentum Panel grade 1 fabric is included with every hutch. Upcharges for higher graded fabrics are listed on page 297. Tackboard fabric selections should be supplied with the order information, fabric options are listed on page 4 of this price guide. Tackboards for hutches are installed at the factory and require no additional set up on site.

Hutches over 84" in length are made in two pieces and require special installation.

Hutches are available with a finished inside back panel at standard list price, but must be clearly specified on order. This option is available on hutches up to 84" in length only. This option does not include a tackboard. Locks are optional on overheads and can be specified at time of order for an upcharge of **\$152 list per set** of (2) doors.

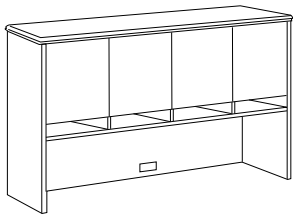

HUTCH POWER DATA OPTION

Access to power and data is made simple by using a hutch with a power data module built right into the tackboard. The module is fully installed at the factory but can be removed to connect data links on site. It features a flip door that retracts into the case of the unit when open. See page 251 in the grommets section for complete power specifications

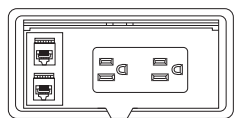

INSTALLATION

Hutch and overhead installation instructions are included with every case, basic installation instructions can be found in this guide on page 253. All required mounting hardware is included with all hutches.

MILLENNIUM | FILING INSTRUCTIONS & INSTALLATION

FILING INSTRUCTIONS

All file drawers will accept both letter and legal size filling. All units are equipped with file bars to accommodate either direction. File bars are shipped taped to the inside of the drawer for safety.



DESK PEDESTAL FILE DRAWERS

Filing Capacity:

25.5" of letter filing from front to back, or
12" of legal filing side to side

Pedestal drawer depths allow only one row of side to side files

Legal files can be positioned in the side to side direction only.

Weight capacity of pedestal file drawers is 130 lbs

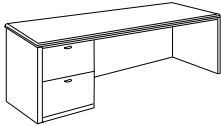

CREDENZA AND RETURN PEDESTAL FILE DRAWERS

Filing Capacity:

15" of letter filing from front to back, or
12" of legal filing side to side

Pedestal drawer depths can be positioned in the side to side direction only.

Weight capacity of pedestal file drawers is 100 lbs

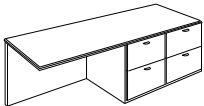

CREDENZA, RETURN OR STORAGE LATERAL FILE DRAWERS

Filing Capacity for 30" wide drawers:

30" of letter filing front to back, or
25" of legal filing side to side, or
15" of legal filing front to back

When filing front to back, 30" lateral file drawer widths allow two rows of letter filing, but only one row of legal file width

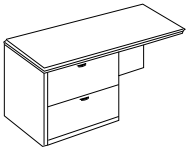

Filing Capacity for 36" wide drawers:

30" of letter filing front to back, or
36" of legal filing side to side, or
30" of legal filing front to back

Weight capacity of lateral file drawers is 150 lbs

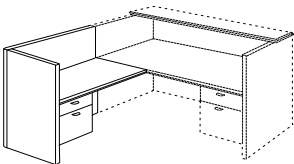

CONNECTING WORKSURFACES

It is important that the product is in its final position and the primary worksurface is leveled before connecting other joining pieces.

Detailed installation instructions are included with each unit, or available from Krug Customer Service.

Units are connected with mending plates under worksurfaces, and linking brackets on modesty and end panels. Locate connections and attach the mending plates under the worksurface. Level pieces if necessary by adjusting the glides to achieve flush and firm joints before completing installation of all hardware.

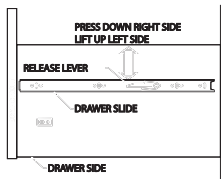

DRAWER REMOVAL

To remove pedestal drawers, open to the extended position, press down on the right side nylon release lever and pull the drawers up on the left side lever at the same time. Continue pulling the drawers out of the case.

GLIDE ADJUSTMENT

Raise one corner of the unit at a time and adjust the glide to the desired height by turning the glide in the hole. Make sure unit is level after adjusting the glides. Please note that the maximum adjustment range of the glides is 1 1/2". When moving units after glides have been inserted, dial the glides to the lowest position to prevent damage to the case.

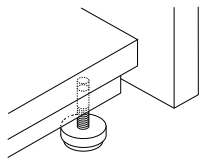

BOOKCASE OR HUTCH DOOR ADJUSTMENT

Hinges on all hutch and bookcase doors are designed to be adjusted for depth, horizontal and vertical adjustment by means of screws into the hinge mounting plates.

To remove a door, squeeze the release clip and pull out the door, disconnecting the hinges.

OVERHEAD INSTALLATION

The wall mount overhead storage units must be installed on wall studs. The first step for installation is to locate the studs in the wall where the overhead is to be mounted. Measure the stud center line location and use this measurement to mark the hole locations on the mounting rail and the overhead back. Drill clearance holes at the hole locations. Hole requirements will depend on the fasteners chosen by the installer. 2 1/2" x #10 wood screws are adequate if going into wood studs. If studs cannot be accessed, then appropriate drywall plugs or butterfly bolts should be used. We recommend 2 fasteners per stud.

Fasten the mounting rail to the wall ensuring that it is level. Hang the overhead on the mounting rail and then fasten it to the wall. This prevents accidental removal and also allows for some leveling adjustment.

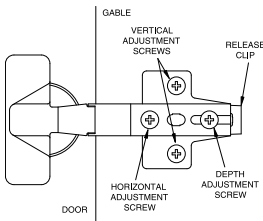

MILLENNIUM | HEIGHT ADJUSTABLE WORKSURFACE WITH BASE ENCLOSURE

Single Stage Mechanism With Base Enclosure

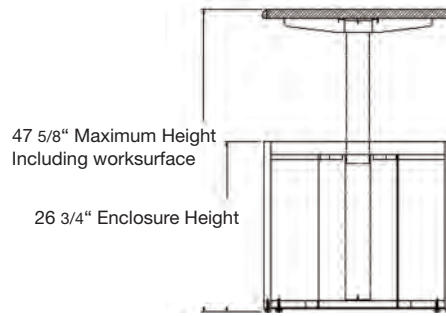
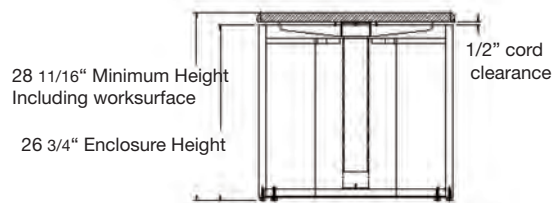

The Single Stage mechanism with Base Enclosure has an adjustable height range of 28 11/16 - 47 5/8 inches. When the work surface is at the lowest stage - desk height, the space between underside of the work surface and the top of the Base Enclosure is 1/2 inch.

Dual Stage Mechanism With Base Enclosure

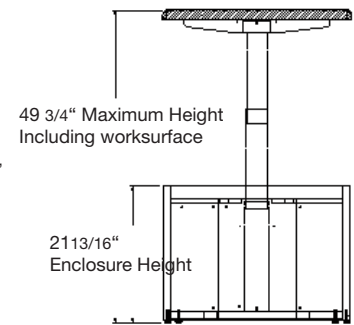
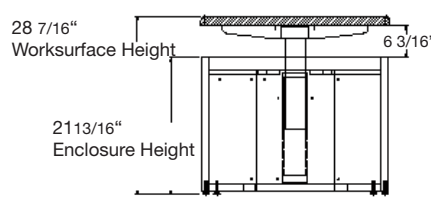
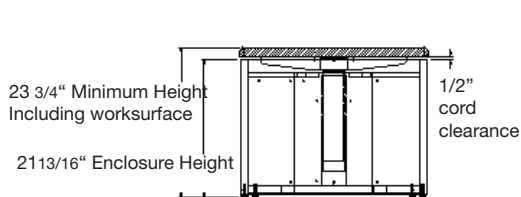

The Dual Stage mechanism with Base Enclosure has an adjustable height range of 23 3/4 - 49 3/4 inches. When the work surface is at the standard desk height setting of 28 7/16", the space between underside of the work surface and the top of the Base Enclosure is 6 inches. This allows for the full range of height adjustments.

Custom Base Enclosures for the Dual Stage are available decreasing the gap below the work surface to 1/2 inch.

Caution: this eliminates the ability to use the lower stage settings.

Custom Base Enclosures to further lower the minimum work surface height are also available, removing the inside enclosure floor completely and allowing a minimum desk height of 22 7/16". Contact customer service for a quote.

MILLENNIUM | SAMPLE CONFIGURATIONS

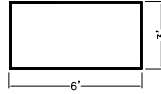
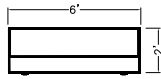
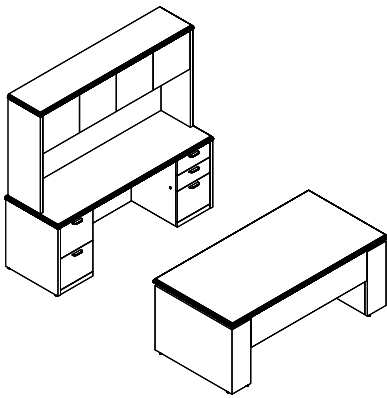

	Model	Cherry Maple Walnut
Height Adj. Desk	68HA7136ETSGV21	6945
Hutch	68HT7115	5036
Credenza	68CY71244LDRF	5912
TOTAL		17,893

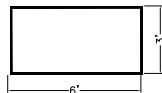
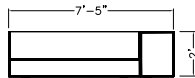
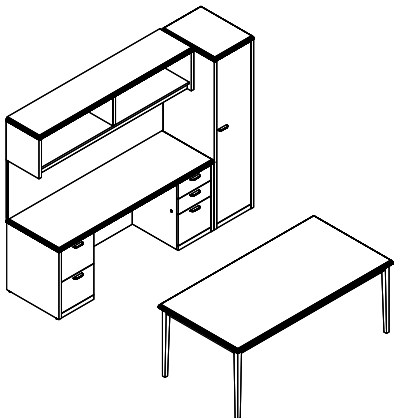

	Model	Cherry Maple Walnut
Desk	68TDE7136	4822
Overhead	68OO711517	2485
Tackboard	68TBOH71	568
Credenza	68CY71244LDRF	5912
Flush Right	option	120
Storage	68ST18246811R	3635
TOTAL		17,542

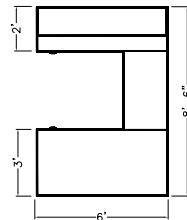
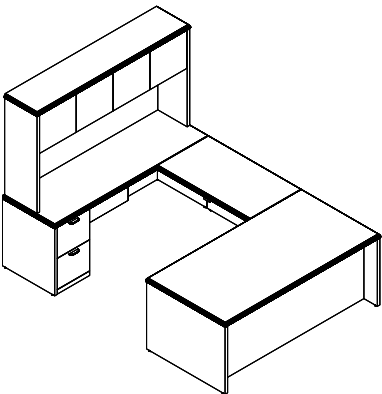

	Model	Cherry Maple Walnut
Desk	68D71364LORF	5087
Link Unit	68LU4224H	1920
Hutch	68HT7115	5036
Credenza	68CY71244LDR0	5498
TOTAL		17,541

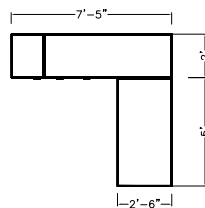
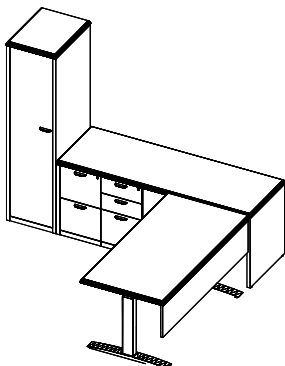

	Model	Cherry Maple Walnut
Height Adj. Desk	68HA6030ETSV21	4377
Credenza	68C71204LDFR0	5835
Flush Left	option	120
Storage	68ST18246811L	3636
TOTAL		13,968

MILLENNIUM PRODUCT ENHANCEMENTS

Please follow the instructions below to enhance Millennium with optional product features.

INSTRUCTIONS

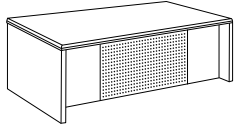

DESK WITH PERFORATED METAL MODESTY PANEL
 Not available on 3/4 Height Pedestal Desks
 Available on Desks 66" and up
 Add 'P' to model number prefix
 Example: 68-DP-6030-LDRD
10% list upcharge

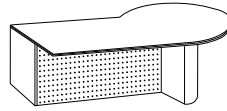

CURVILINEAR RETURNS WITH PERFORATED METAL MODESTY PANEL
 Only available on 71" & 84" units and only available in conjunction with Half Drum Base
 Add 'P' to model number prefix
 Example: 68PPRL-7130-DB
20% list upcharge

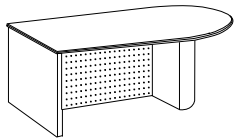

CURVILINEAR DESKS WITH PERFORATED METAL MODESTY PANEL
 Only available on 71" & 84" units and only available in conjunction with Half Drum Base
 Add 'P' to model number prefix
 Example: 68BDP-7130-DB
20% list upcharge

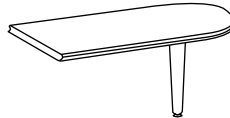

CURVILINEAR RETURNS WITH TAPERED BRUSHED ALUMINUM POST LEG
 Only available on Returns without Modesty Panels
 Add 'T' to model number suffix
 Example: 68BR-6630-T
No upcharge

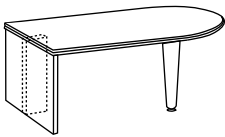

CURVILINEAR DESKS WITH TAPERED BRUSHED ALUMINUM POST LEG
 Only available on Desks without Modesty Panels
 Add 'T' to model number suffi
 Example: 68BD-6630-T
No upcharge

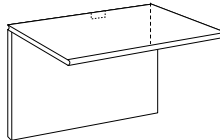

LINK UNIT WITH WIRE MANAGEMENT CUT-OUT ON MODESTY PANEL
 Available in standard center position
 Note clearly on purchase order
\$194 list upcharge

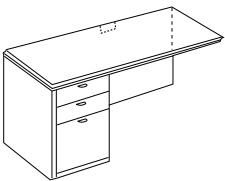

RETURNS WITH WIRE MANAGEMENT CUT-OUT ON MODESTY PANEL
 Not available on Desk Depth Returns
 Available in standard center position on modesty panel
 Note clearly on purchase order
\$194 list upcharge

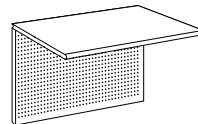

LINK UNITS WITH PERFORATED METAL MODESTY PANEL
 Add 'P' to model number prefix
 Example: 68-LUP-3024-H
40% list upcharge

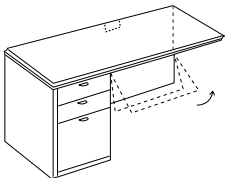

RETURNS WITH HINGED WOOD MODESTY PANEL OPTION
 Add 'Y' to model number prefix
 Example: 68RHY-4220-L4D
10% list upcharge

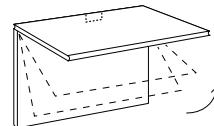

LINK UNITS WITH HINGED WOOD MODESTY PANEL
 Add 'Y' to model number prefix
 Example: 68-LUY-3024-H
10% list upcharge

ORDERING PROCEDURE

To order, please specify the following:

- 1) Krug product model number
- 2) Wood species and finish
- 3) Wood edge detail - S, V, T, M, B, Z or W, see page 250

*Indicates model illustrated by line drawing.

CODE DESCRIPTION

- P — perforated metal modesty panel
- T — tapered brushed aluminum panel
- Y — hinged wood modesty panel

The metal finish on perforated metal modesty panels, tapered brushed aluminum post legs, tackboard organizer rail, and accessories all match the Millennium satin nickel pull finish.

STANDARD FINISHES

For a complete list of standard wood finishes please see page 247

PERFORATED METAL MODESTY PANEL

Perforated metal modesty panels are 16 gage thick steel panels with a brushed metal finish

MILLENNIUM | PRODUCT ENHANCEMENTS

Please follow the instructions below to enhance Millennium with optional product features.

INSTRUCTIONS

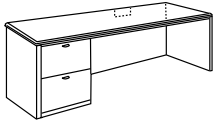

CREDENZAS WITH CUT-OUT GROMMET OPTION ON MODESTY PANEL
Note clearly on purchase order
\$194 list upcharge

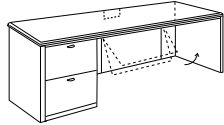

CREDENZAS WITH HINGED WOOD MODESTY PANEL
Not available on Ganged Pedestal, or Lateral File/Bookcase Credenzas
Add 'Y' to model number prefix
Example: 68CY-6020-4-LDRO
10% list upcharge

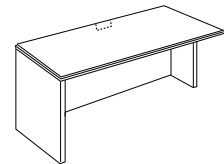

OPEN RETURNS WITH WIRE MANAGEMENT CUT-OUT ON MODESTY PANEL
Available in standard center position
Note clearly on purchase order
\$194 list upcharge

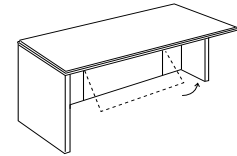

OPEN RETURNS WITH HINGED WOOD MODESTY PANEL
Add 'Y' to model number prefix
Example: 68RHY-4224
10% list upcharge

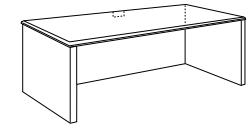

SHELLS WITH WIRE MANAGEMENT CUT-OUT ON MODESTY PANEL
Wire Management Cut-Out: 7 7/28" x 4 9/16"
Available in standard center position and also available on Corner Credenza Shell Model
Note clearly on purchase order
\$194 list upcharge

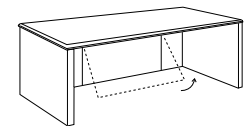

SHELLS WITH HINGED WOOD MODESTY PANEL
Width of hinged modesty panel allows for installation of 16" pedestals
Also available on Corner Credenza Shell Model
Add 'Y' to model number prefix
Example: 68SY-3020
10% list upcharge

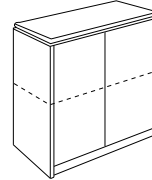

DOUBLE HEIGHT OVERHEADS
Only available on 36", 42" and 48" hinged door and open models Add '33' to model number suffix
Example: 680H-3633
25% list upcharge

DOUBLE HEIGHT PAPER MANAGEMENT OVERHEADS
Only available on 36", 42" and 48" hinged door and open models Add 'PM' to model number suffix
Example: 680HPM-3629
35% list upcharge

PAPER MANAGEMENT OVERHEADS
Not available on Flipper Door Models Add 'PM' to model number prefix
Example: 680HPM-36
10% list upcharge



MOBILE PEDESTAL WITH UPHOLSTERED SEAT
Reference model #: 68MPSU-4F
Available in a shallow version only

FABRIC GRADES

MODEL	1	2	3	4	5	6	7	8	9
Cherry/Maple/Walnut	2618	2664	2713	2757	2805	2850	2898	3036	3172

MODEL	W	D	H	SHIP WT.	CU.FT.	COM
MPSU-4F	16	18.5	25.25	76	6	1

DIMENSION KEY

W - width
D - depth
H - height

CODE DESCRIPTION





P — perforated metal modesty panel
Y — hinged wood modesty panel
X — hinged glass doors
29 — double height overheads
PM — paper manager
The metal finish on perforated metal modesty panels, tapered brushed aluminum post legs, tackboard organizer rail, and accessories match the Millennium satin nickel pull finish

STANDARD FINISHES

For a complete list of standard wood finishes please see page 247.

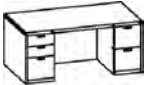
HINGED WOOD MODESTY PANEL Hinged wood modesty panels come standard with a center positioned wire management cut-out.

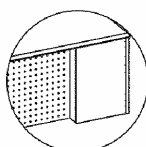
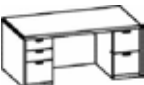
MILLENNIUM | DESKS

Description	Model	Cherry Walnut Maple	W	D	H	KW	Shipping	
							Weight	Cubic Feet
Double Pedestal Desk with Full Height Pedestals   	68D60304LDRD	6267	60	30.25	28.5	27.5	296	36
	68D60304LDRF	6267	60	30.25	28.5	27.5	296	36
	68D60304LFRD	6267	60	30.25	28.5	27.5	296	36
	68D60304LFRF	6267	60	30.25	28.5	27.5	296	36
	68D66304LDRD	6289	65.75	30.25	28.5	33.25	314	39
	68D66304LDRF	6289	65.75	30.25	28.5	33.25	314	39
	68D66304LFRD*	6289	65.75	30.25	28.5	33.25	314	39
	68D66304LFRF	6289	65.75	30.25	28.5	33.25	314	39
	68D66364LDRD	6322	65.75	36.25	28.5	33.25	354	46
	68D66364LDRF	6322	65.75	36.25	28.5	33.25	354	46
	68D66364LFRD	6322	65.75	36.25	28.5	33.25	354	46
	68D66364LFRF	6322	65.75	36.25	28.5	33.25	354	46
	68D71304LDRD	6330	71	30.25	28.5	38.25	329	42
	68D71304LDRF	6330	71	30.25	28.5	38.25	329	42
	68D71304LFRD	6330	71	30.25	28.5	38.25	329	42
	68D71304LFRF	6330	71	30.25	28.5	38.25	329	42
	68D71364LDRD	6432	71	36.25	28.5	38.35	372	50
	68D71364LDRF	6432	71	36.25	28.5	38.35	372	50
	68D71364LFRD	6432	71	36.25	28.5	38.35	372	50
	68D71364LFRF	6432	71	36.25	28.5	38.35	372	50
68D78304LDRD	6442	78	30.25	28.5	45.5	350	46	
68D78304LDRF	6442	78	30.25	28.5	45.5	350	46	
68D78304LFRD	6442	78	30.25	28.5	45.5	350	46	
68D78304LFRF	6442	78	30.25	28.5	45.5	350	46	
68D78364LDRD	6514	78	36.25	28.5	45.5	397	36	
68D78364LDRF	6514	78	36.25	28.5	45.5	397	36	
68D78364LFRD	6514	78	36.25	28.5	45.5	397	36	
68D78364LFRF	6514	78	36.25	28.5	45.5	397	36	
68D84364LDRD	6543	84	36.25	28.5	51.5	399	39	
68D84364LDRF	6543	84	36.25	28.5	51.5	399	39	
68D84364LFRD	6543	84	36.25	28.5	51.5	399	39	
68D84364LFRF	6543	84	36.25	28.5	51.5	399	39	
Double Pedestal Desk with Full Height Pedestals & Breakfront Modesty Panel  	68DBF66364LDRD	7007	65.75	36.25	28.5	33.25	354	46
	68DBF66364LDRF	7007	65.75	36.25	28.5	33.25	354	46
	68DBF66364LFRD*	7007	65.75	36.25	28.5	33.25	354	46
	68DBF66364LFRF	7007	65.75	36.25	28.5	33.25	354	46
	68DBF71364LDRD	7104	71	36.25	28.5	38.25	372	50
	68DBF71364LDRF	7104	71	36.25	28.5	38.25	372	50
	68DBF71364LFRD	7104	71	36.25	28.5	38.25	372	50
	68DBF71364LFRF	7104	71	36.25	28.5	38.25	372	50
	68DBF78364LDRD	7212	78	36.25	28.5	45.5	397	36
	68DBF78364LDRF	7212	78	36.25	28.5	45.5	397	36
	68DBF78364LFRD	7212	78	36.25	28.5	45.5	397	36
	68DBF78364LFRF	7212	78	36.25	28.5	45.5	397	36
	68DBF84364LDRD	7210	84	36.25	28.5	51.5	399	39
	68DBF84364LDRF	7210	84	36.25	28.5	51.5	399	39
68DBF84364LFRD	7210	84	36.25	28.5	51.5	399	39	
68DBF84364LFRF	7210	84	36.25	28.5	51.5	399	39	

ORDERING NOTES:

30" deep desks have flush modesty panels, 36" deep desks have recessed modesty panels. Please see page 256 for perforated metal modesty panel option. Laminate worksurfaces are available at a 10% upcharge.

ORDERING PROCEDURE

To order, please specify the following:

- 1) Krug product model number
- 2) Wood species and finish, see page 247
- 3) Wood edge detail- I,H, L or P, see page 250
- 4) Pull style, see page 250
- 5) Grommet location if applicable

*Indicates model illustrated by line drawing.

CODE DESCRIPTION

- 4 - full height pedestal
- L - left handed pedestal position
- R - right handed pedestal position
- D - 2 file drawer
- F - 2 box, 1 file drawer
- BF- break front modesty panel

STANDARD FINISHES

For a complete list of standard wood finishes please see page 247.

GROMMETS

One wiring grommet in standard position is optional at no charge. See page 251 for more power management information.

MILLENNIUM | DESKS

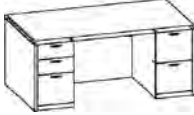
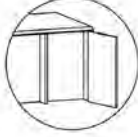
Description	Model	Cherry			W	D	H	KW	Shipping Weight	Cubic Feet
		Walnut	Maple							
Double Pedestal Desk with Full Height Pedestals & Breakfront	68DBF66364LDWRD	8447			65.75	36.25	28.5	33.25	354	46
	68DBF66364LDRDW	8447			65.75	36.25	28.5	33.25	354	46
Modesty Panel with Wire Management Cavity	68DBF66364LFRD*	8447			65.75	36.25	28.5	33.25	354	46
	68DBF66364LFRDW	8447			65.75	36.25	28.5	33.25	354	46
	68DBF66364LDRWF	8447			65.75	36.25	28.5	33.25	354	46
	68DBF66364LDRFW	8447			65.75	36.25	28.5	33.25	354	46
	68DBF66364LFRWF	8447			65.75	36.25	28.5	33.25	354	46
	68DBF66364LFRFW	8447			65.75	36.25	28.5	33.25	354	46
	68DBF71364LDWRD	8572			71	36.25	28.5	38.25	372	50
	68DBF71364LDRDW	8572			71	36.25	28.5	38.25	372	50
	68DBF71364LDWRF	8572			71	36.25	28.5	38.25	372	50
	68DBF71364LDRFW	8572			71	36.25	28.5	38.25	372	50
	68DBF71364LFRD*	8572			71	36.25	28.5	38.25	372	50
	68DBF71364LFRDW	8572			71	36.25	28.5	38.25	372	50
	68DBF71364LFRWF	8572			71	36.25	28.5	38.25	372	50
	68DBF71364LFRFW	8572			71	36.25	28.5	38.25	372	50
	68DBF78364LDWRD	8654			78	36.25	28.5	45.5	397	36
	68DBF78364LDRDW	8654			78	36.25	28.5	45.5	397	36
	68DBF78364LDWRF	8654			78	36.25	28.5	45.5	397	36
	68DBF78364LDRFW	8654			78	36.25	28.5	45.5	397	36
	68DBF78364LFRD*	8654			78	36.25	28.5	45.5	397	36
	68DBF78364LFRDW	8654			78	36.25	28.5	45.5	397	36
	68DBF78364LFRWF	8654			78	36.25	28.5	45.5	397	36
	68DBF78364LFRFW	8654			78	36.25	28.5	45.5	397	36
	68DBF84364LDWRD	8687			84	36.25	28.5	51.5	399	39
	68DBF84364LDRDW	8687			84	36.25	28.5	51.5	399	39
	68DBF84364LDWRF	8687			84	36.25	28.5	51.5	399	39
	68DBF84364LDRFW	8687			84	36.25	28.5	51.5	399	39
	68DBF84364LFRD*	8687			84	36.25	28.5	51.5	399	39
	68DBF84364LFRDW	8687			84	36.25	28.5	51.5	399	39
	68DBF84364LFRWF	8687			84	36.25	28.5	51.5	399	39
	68DBF84364LFRFW	8687			84	36.25	28.5	51.5	399	39

DIMENSION KEY

W - width
D - depth
H - height

CODE DESCRIPTION

4 - full height pedestal
L - left handed pedestal position
R - right handed pedestal position
D - 2 file drawer
F - 2 box, 1 file drawer
BF- break front modesty panel
W - Wire Management Cavity

STANDARD FINISHES

For a complete list of standard wood finishes please see page 247.

GLASS DOORS

All storage glass doors come standard with a vertical Massa pull. Other pull options are not available on glass doors.

MILLENNIUM | DESKS

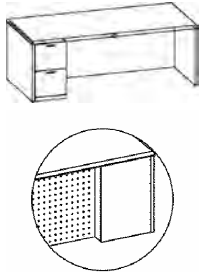
Description	Model	Cherry Walnut Maple	W	D	H	KW	Shipping Weight	Cubic Feet
Single Pedestal Desk with Full Height Pedestal	68D60304LDR0	4919	60	30.25	28.5	27.5	239	36
	68D60304LFR0	4919	60	30.25	28.5	27.5	239	36
	68D60304LORD	4919	60	30.25	28.5	27.5	239	36
	68D60304LORF	4919	60	30.25	28.5	27.5	239	36
	68D66304LDR0	4959	65.75	30.25	28.5	33.25	257	39
	68D66304LFR0	4959	65.75	30.25	28.5	33.25	257	39
	68D66304LORD	4959	65.75	30.25	28.5	33.25	257	39
	68D66304LORF	4959	65.75	30.25	28.5	33.25	257	39
	68D66364LDR0	5003	65.75	36.25	28.5	33.25	297	46
	68D66364LFR0*	5003	65.75	36.25	28.5	33.25	297	46
	68D66364LORD	5003	65.75	36.25	28.5	33.25	297	46
	68D66364LORF	5003	65.75	36.25	28.5	33.25	297	46
	68D71304LDR0	5010	71	30.25	28.5	38.25	272	42
	68D71304LFR0	5010	71	30.25	28.5	38.25	272	42
	68D71304LORD	5010	71	30.25	28.5	38.25	272	42
	68D71304LORF	5010	71	30.25	28.5	38.25	272	42
	68D71364LDR0	5087	71	36.25	28.5	38.35	315	50
	68D71364LFR0	5087	71	36.25	28.5	38.35	315	50
	68D71364LORD	5087	71	36.25	28.5	38.35	315	50
	68D71364LORF	5087	71	36.25	28.5	38.35	315	50
	68D78304LDR0	5147	78	30.25	28.5	45.5	293	46
	68D78304LFR0	5147	78	30.25	28.5	45.5	293	46
68D78304LORD	5147	78	30.25	28.5	45.5	293	46	
68D78304LORF	5147	78	30.25	28.5	45.5	293	46	
68D78364LDR0	5178	78	36.25	28.5	45.5	340	36	
68D78364LORF	5178	78	36.25	28.5	45.5	340	36	
68D78364LDR0	5178	78	36.25	28.5	45.5	340	36	
68D78364LFR0	5178	78	36.25	28.5	45.5	340	36	
68D84364LDR0	5238	84	36.25	28.5	51.5	342	39	
68D84364LFR0	5238	84	36.25	28.5	51.5	342	39	
68D84364LORD	5238	84	36.25	28.5	51.5	342	39	
68D84364LORF	5238	84	36.25	28.5	51.5	342	39	

ORDERING NOTES:

30" deep desks have flush modesty panels, 36" deep desks have recessed modesty panels. Please see page 256 for perforated metal modesty panel option. Laminate worksurfaces are available at a 10% upcharge.

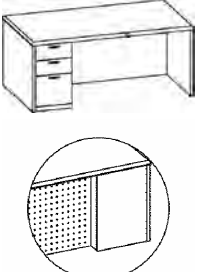
Single Pedestal Desk with Full Height Pedestal & Breakfront Modesty Panel 	68DBF66364LDR0	5667	65.75	36.25	28.5	33.25	297	46
	68DBF66364LFR0*	5667	65.75	36.25	28.5	33.25	297	46
	68DBF66364LORD	5667	65.75	36.25	28.5	33.25	297	46
	68DBF66364LORF	5667	65.75	36.25	28.5	33.25	297	46
	68DBF71364LDR0	5780	71	36.25	28.5	38.25	315	50
	68DBF71364LFR0	5780	71	36.25	28.5	38.25	315	50
	68DBF71364LORD	5780	71	36.25	28.5	38.25	315	50
	68DBF71364LORF	5780	71	36.25	28.5	38.25	315	50
	68DBF78364LDR0	5854	78	36.25	28.5	45.5	340	36
	68DBF78364LFR0	5854	78	36.25	28.5	45.5	340	36
	68DBF78364LORD	5854	78	36.25	28.5	45.5	340	36
	68DBF78364LORF	5854	78	36.25	28.5	45.5	340	36
	68DBF84364LDR0	5931	84	36.25	28.5	51.5	342	39
	68DBF84364LFR0	5931	84	36.25	28.5	51.5	342	39
	68DBF84364LORD	5931	84	36.25	28.5	51.5	342	39
	68DBF84364LORF	5931	84	36.25	28.5	51.5	342	39

ORDERING PROCEDURE

To order, please specify the following:

- 1) Krug product model number
- 2) Wood species and finish, see page 247
- 3) Wood edge detail- I, H, L or P, see page 250
- 4) Pull style, see page 250
- 5) Grommet location if applicable

*Indicates model illustrated by line drawing.

CODE DESCRIPTION

- 4 - full height pedestal
- L - left handed pedestal position
- R - right handed pedestal position
- 0 - no pedestal
- D - 2 file drawer
- F - 2 box, 1 file drawer
- BF- break front modesty panel

STANDARD FINISHES

For a complete list of standard wood finishes please see page 247.

GROMMETS

One wiring grommet in standard position is optional at no charge. See page 251 for more power management information.

MILLENNIUM | DESKS

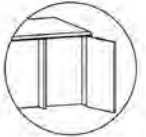
Description	Model	Cherry	W	D	H	KW	Shipping Weight	Cubic Feet
		Walnut Maple						
Single Pedestal Desk with Full Height Pedestal	68DBF66364LDWR0	7166	65.75	36.25	28.5	33.25	307	46
	68DBF66364LFWR0*	7166	65.75	36.25	28.5	33.25	307	46
Breakfront Modesty Panel with Wire Management Cavity	68DBF66364LORDW	7166	65.75	36.25	28.5	33.25	307	46
	68DBF66364LORFW	7166	65.75	36.25	28.5	33.25	307	46
Panel with Wire Management Cavity	68DBF66364LDR0W	7166	65.75	36.25	28.5	33.25	307	46
	68DBF66364LFR0W	7166	65.75	36.25	28.5	33.25	307	46
	68DBF66364L0WRD	7166	65.75	36.25	28.5	33.25	307	46
	68DBF66364L0WRF	7166	65.75	36.25	28.5	33.25	307	46
	68DBF71364LDWR0	7234	71	36.25	28.5	38.25	325	50
	68DBF71364LFWR0	7234	71	36.25	28.5	38.25	325	50
	68DBF71364LORDW	7234	71	36.25	28.5	38.25	325	50
	68DBF71364LORFW	7234	71	36.25	28.5	38.25	325	50
	68DBF71364LDR0W	7234	71	36.25	28.5	38.25	325	50
	68DBF71364LFR0W	7234	71	36.25	28.5	38.25	325	50
	68DBF71364L0WRD	7234	71	36.25	28.5	38.25	325	50
	68DBF71364L0WRF	7234	71	36.25	28.5	38.25	325	50
	68DBF78364LDWR0	7343	78	36.25	28.5	45.5	350	36
	68DBF78364LFWR0	7343	78	36.25	28.5	45.5	350	36
	68DBF78364LORDW	7343	78	36.25	28.5	45.5	350	36
	68DBF78364LORFW	7343	78	36.25	28.5	45.5	350	36
	68DBF78364LDR0W	7343	78	36.25	28.5	45.5	350	36
	68DBF78364LFR0W	7343	78	36.25	28.5	45.5	350	36
	68DBF78364L0WRD	7343	78	36.25	28.5	45.5	350	36
	68DBF78364L0WRF	7343	78	36.25	28.5	45.5	350	36
	68DBF84364LDWR0	7390	78	36.25	28.5	51.5	352	39
	68DBF84364LFWR0	7390	78	36.25	28.5	51.5	352	39
	68DBF84364LORDW	7390	78	36.25	28.5	51.5	352	39
	68DBF84364LORFW	7390	78	36.25	28.5	51.5	352	39
	68DBF84364LDR0W	7390	78	36.25	28.5	51.5	352	39
	68DBF84364LFR0W	7390	78	36.25	28.5	51.5	352	39
	68DBF84364L0WRD	7390	78	36.25	28.5	51.5	352	39
	68DBF84364L0WRF	7390	78	36.25	28.5	51.5	352	39

ORDERING NOTES:

30" deep desks have flush modesty panels, 36" deep desks have recessed modesty panels. Please see page 256 for perforated metal modesty panel option. Laminate worksurfaces are available at a 10% upcharge.

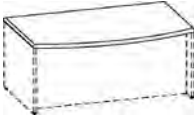
Bow Top Option	Model	Price	W	D	H	KW	Shipping Weight	Cubic Feet
	BT68D6030	606	-	-	-	-	-	-
	BT68D6630	634	-	-	-	-	-	-
	BT68D6636	666	-	-	-	-	-	-
	BT68D7130	693	-	-	-	-	-	-
	BT68D7136*	714	-	-	-	-	-	-
	BT68D7830	731	-	-	-	-	-	-
	BT68D7836	740	-	-	-	-	-	-
	BT68D8436	752	-	-	-	-	-	-

ORDERING NOTES:

Add BT before any standard desk model number and apply upcharge. Add 15lbs to standard desk weight for bow top option.

DIMENSION KEY

W - width
D - depth
H - height

CODE DESCRIPTION

4 - full height pedestal
L - left handed pedestal position
R - right handed pedestal position
0 - no pedestal
D - 2 file drawer
F - 2 box, 1 file drawer
BF - break front modesty panel
W - Wire Management Cavity

STANDARD FINISHES

For a complete list of standard wood finishes please see page 247.

MILLENNIUM | TABLE DESKS & CURVILINEAR DESKS

Description	Model	Cherry		W	D	H	KW	Shipping Weight	Cubic Feet
		Walnut	Maple						
	68TD6030	3224		60	30.25	28.5	57	280	38
	68TB6630	3263		65.75	30.25	28.5	63.25	290	41
	68TD7130	3327		71	30.25	28.5	68.25	300	45
	68TD7136*	3333		71	36.25	28.5	68.25	310	54
	68TD8436	3366		84	36.25	28.5	81.25	320	63

ORDERING NOTES:

This item includes a 68PD2116 pencil drawer.

	Table Desk Executive Style	68TDE6630	4715	65.75	36.25	29.5		180	41
		68TDE7136*	4822	71	36.25	29.5		238	54
		68TDE8436	4905	84	36.25	29.5		265	63

ORDERING NOTES:

This item includes a 68PD2116 pencil drawer. Table desk has a clearance height of 25.25". Does not fit a pedestal underneath.

	Bullet Desk with Wood Post Leg	68BD6030	3339	60	30.25	28.5	41.5	156	36	
		68BD6630	3403	65.75	30.25	28.5	47.5	174	39	
		68BD6636*	3431		65.75	36.25	28.5	44.5	214	46
		68BD7130	3470		71	30.25	28.5	52.5	159	42
		68BD7136	3539		71	36.25	28.5	49.5	232	50



ORDERING NOTES:

Please see page 256 for brushed aluminum tapered post leg option.

	Bullet Desk with 3/4 Modesty Panel & Wood Post Leg	68BD60303LGM	3666	60	30.25	28.5	14.75	189	36	
		68BD66303LGM	3706	65.75	30.25	28.5	14.75	159	39	
		68BD66364LGM	3736		65.75	36.25	28.5	17.75	229	46
		68BD71303LGM	3761		71	30.25	28.5	14.75	204	42
		68BD71363LGM*	3784		71	36.25	28.5	17.75	247	50
		68BD84303LGM	3804		84	30.25	28.5	14.75	331	49
	68BD84363LGM	3847		84	36.25	28.5	17.75	274	59	

ORDERING PROCEDURE

To order, please specify the following:

- 1) Krug product model number
- 2) Wood species and finish, see page 247
- 3) Wood edge detail- I,H, L or P, see page 250
- 4) Pull style, see page 250
- 5) Grommet location if applicable

*Indicates model illustrated by line drawing.

CODE DESCRIPTION

LGM - wood leg and modesty panel

STANDARD FINISHES

For a complete list of standard wood finishes please see page 247

GROMMETS

One wiring grommet in standard position is optional at no charge. Additional wiring grommets are available at an **upcharge of \$152.**

MILLENNIUM | CURVILINEAR DESKS

Description	Model	Cherry Walnut Maple	W	D	H	KW	Shipping	
							Weight	Cubic Feet
 Bullet Desk with Full Height Modesty Panel & Wood Post Leg	68BD60304LGM	3783	60	30.25	28.5	14.75	176	36
	68BD66304LGM	3820	65.75	30.25	28.5	14.75	194	39
	68BD66364LGM	3818	65.75	36.25	28.5	14.75	234	46
	68BD71304LGM	3859	71	30.25	28.5	14.75	209	42
	68BD71364LGM*	3890	71	36.25	28.5	17.75	252	50
	68BD84304LGM	3929	84	30.25	28.5	14.75	232	49
	68BD84364LGM	3965	84	36.25	28.5	17.75	279	59

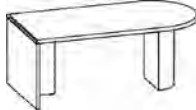
 Bullet Desk with Half Drum Base	68BD6630DB	3736	65.75	30.25	28.5	37.25	194	39
	68BD6636DB	3761	65.75	36.25	28.5	34.25	234	46
	68DB7130DB	3795	71	30.25	28.5	42.5	209	42
	68BD7136DB*	3859	71	36.25	28.5	39.5	252	50
	68BD8430DB	3924	84	30.25	28.5	55.5	232	49
	68BD8436DB	4065	84	36.25	28.5	52.5	279	59
	68BD9636DB	4200	96	36.25	28.5	64.25	320	67

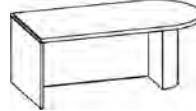
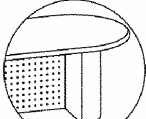

ORDERING NOTES:

All curvilinear post legs are 6" in diameter. Laminate worksurfaces are available at a 10% upcharge.

  Bullet Desk with Half Drum Base & Full Height Modesty Panel	68BD6630DBML	4196	65.75	30.25	28.5	23.25	209	39
	68BD6630DBMR	4196	65.75	30.25	28.5	23.25	209	39
	68BD6636DBML	4221	65.75	36.25	28.5	26.25	249	46
	68BD6636DBMR	4221	65.75	36.25	28.5	26.25	249	46
	68BD7130DBML	4256	71	30.25	28.5	23.25	224	42
	68BD7130DBMR	4256	71	30.25	28.5	23.25	224	42
	68BD7136DBML	4290	71	36.25	28.5	26.25	267	50
	68BD7136DBMR*	4290	71	36.25	28.5	26.25	267	50
	68BD8430DBML	4322	84	30.25	28.5	23.25	247	49
	68BD8430DBMR	4322	84	30.25	28.5	23.25	247	49
	68BD8436DBML	4426	84	36.25	28.5	26.25	294	59
	68BD8436DBMR	4426	84	36.25	28.5	26.25	294	59
	68BD9636DBML	4562	96	36.25	28.5	26.25	335	67
	68BD9636DBMR	4562	96	36.25	28.5	26.25	335	67

ORDERING NOTES:

Please see page 256 for perforated metal modesty panel option.

  Curved Corner Bullet Desk with Wood Post Leg	68CCB7130L	4576	71	36.25	28.5	51.25	232	45
	68CCB7130R	4576	71	36.25	28.5	51.25	232	45
	68CCB7830L	4670	78	36.25	28.5	58.25	257	50
	68CCB7830R*	4670	78	36.25	28.5	58.25	257	50
	68CCB8430L	4758	84	36.25	28.5	64.25	268	55
	68CCB8430R	4758	84	36.25	28.5	64.25	268	55

ORDERING NOTES:

Please see page 256 for brushed aluminum tapered post leg option.

DIMENSION KEY

W - width
D - depth
H - height

CODE DESCRIPTION

4 - full height modesty panel
L - half drum base in left-hand position
R - right drum base in right-hand position
DB - half drum base
LGM - wood base and modesty panel
DBM - half drum base and modesty panel

STANDARD FINISHES

For a complete list of standard wood finishes please see page 247.

RETURN OPTIONS

Curved corner bullet desks, "Q" desks, and "K" desks, accept 24" deep run-off units, returns and linking units.

MILLENNIUM | DESKS

Description	Model	Cherry		W	D	H	KW	Shipping Weight	Cubic Feet
		Walnut	Maple						
	68CCB7130LDB	4891		71	36.25	28.5	51.25	232	45
	68CCB7130RDB	4891		71	36.25	28.5	51.25	232	45
	68CCB7830LDB	4980		78	36.25	28.5	58.25	257	50
	68CCB7830RDB*	4980		78	36.25	28.5	58.25	257	50
	68CCB8430LDB	5077		84	36.25	28.5	64.25	268	55
	68CCB8430RDB	5077		84	36.25	28.5	64.25	268	55

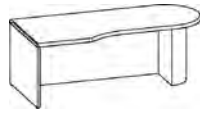
	68CCB7130LDBM	5174		71	36.25	28.5	51.25	232	45
	68CCB7130RDBM	5174		71	36.25	28.5	51.25	232	45
	68CCB7830LDBM	5263		78	36.25	28.5	58.25	257	50
	68CCB7830RDBM*	5263		78	36.25	28.5	58.25	257	50
	68CCB8430LDBM	5368		84	36.25	28.5	64.25	268	55
	68CCB8430RDBM	5368		84	36.25	28.5	64.25	268	55

ORDERING NOTES:

Please see page 256 for perforated metal modesty panel option.

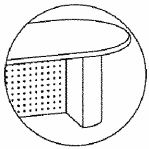

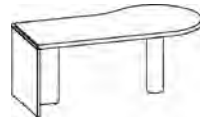
	68PDL7130	4362		71	30	28.5	50	189	50
	68PDR7130*	4362		71	30	28.5	50	189	50
	68PDL7136	4426		71	36	28.5	47.25	232	58
	68PDR7136	4426		71	36	28.5	47.25	232	58



ORDERING NOTES:

Please see page 256 for brushed aluminum tapered post leg option.

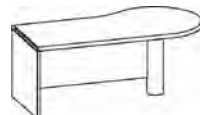
	68PDL71303LGM	4635		71	30	28.5		204	50
	68PDR71303LGM*	4635		71	30	28.5		204	50
	68PDL71363LGM	4752		71	36	28.5		247	58
	68PDR71363LGM	4752		71	36	28.5		247	58
	68PDL84303LGM	4863		84	30	28.5		227	59
	68PDR84303LGM	4863		84	30	28.5		227	59
	68PDL84363LGM	4904		84	36	28.5		274	68
	68PDR84363LGM	4904		84	36	28.5		274	68

ORDERING PROCEDURE

To order, please specify the following:

- 1) Krug product model number
- 2) Wood species and finish, see page 247
- 3) Wood edge detail- I,H, L or P, see page 250
- 4) Pull style, see page 250
- 5) Grommet location if applicable

*Indicates model illustrated by line drawing.

CODE DESCRIPTION

- 4 - full height modesty panel
- L - half drum base in left-hand position
- R - right drum base in right-hand position
- DB - half drum base
- LGM - wood base and modesty panel
- DBM - half drum base and modesty panel

STANDARD FINISHES

For a complete list of standard wood finishes please see page 247.

GROMMETS

One wiring grommet in standard position is optional at no charge. Additional wiring grommets are available at an **upcharge of \$152.**

MILLENNIUM | DESKS

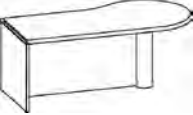
Description	Model	Cherry		W	D	H	KW	Shipping Weight	Cubic Feet
		Walnut	Maple						
 'P' Desk with Full Height Modesty Panel & Wood Post Leg	68PDL71304LGM	4740		71	30	28.5		209	50
	68PDR71304LGM*	4740		71	30	28.5		209	50
	68PDL71364LGM	4826		71	36	28.5		252	58
	68PDR71364LGM	4826		71	36	28.5		252	58
	68PDL84304LGM	4990		84	30	28.5		232	59
	68PDR84304LGM	4990		84	30	28.5		232	59
	68PDL84364LGM	5027		84	36	28.5		279	68
	68PDR84364LGM	5027		84	36	28.5		279	68
	68PDL96364LGM	5203		96	30	28.5		320	77
	68PDR96364LGM	5203		96	30	28.5		320	77

 'P' Desk with Half Drum Base	68PDL8430DB	4977		84	36	28.5		232	59
	68PDR8430DB*	4977		84	30	28.5		247	59
	68PDL8436DB	5010		84	30	28.5		279	68
	68PDR8436DB	5010		84	36	28.5		294	68
	68PDL9636DB	5382		96	36	28.5		320	77
	68PDR9636DB	5382		96	36	28.5		335	77

 'P' Desk with Half Drum Base & Full Height Modesty Panel	68PDL8430DBM	5105		84	36	28.5		247	59
	68PDR8430DBM*	5105		84	30	28.5		247	59
	68PDL8436DBM	5436		84	36	28.5		294	68
	68PDR8436DBM	5436		84	36	28.5		294	68
	68PDL9636DBM	5846		96	36	28.5		335	77
	68PDR9636DBM	5846		96	36	28.5		335	77

ORDERING NOTES:
Please see page 256 for perforated metal modesty panel option.

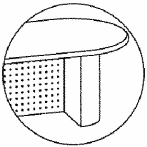

 'Q' Desk with Wood Post Leg	68QDL7130	4362		71	30	28.5	49.5	189	50
	68QDR7130*	4362		71	30	28.5	49.5	189	50
	68QDL8436	4643		84	36	28.5	59.75	232	68
	68QDR8436	4643		84	36	28.5	59.75	232	68

ORDERING NOTES:
Please see page 256 for brushed aluminum tapered post leg option.



DIMENSION KEY
W - width
D - depth
H - height

CODE DESCRIPTION
4 - full height modesty panel
DB - half drum base
LGM - wood base and modesty panel
DBM - half drum base and modesty panel

STANDARD FINISHES
For a complete list of standard wood finishes please see page 247.

RETURN OPTIONS
Curved corner bullet desks, "Q" desks, and "K" desks, accept 24" deep run-off units, returns and linking units.

MILLENNIUM | CURVILINEAR DESKS

Description	Model	Cherry		W	D	H	KW	Shipping Weight	Cubic Feet
		Walnut	Maple						
'Q' Desk with 3/4 Modesty Panel & Wood Post Leg	68QDL71303LGM	4752		71	30	28.5		204	50
	68QDR71303LGM*	4752		71	30	28.5		204	50
	68QDL84363LGM	4904		84	36	28.5		274	68
	68QDR84363LGM	4904		84	36	28.5		274	68

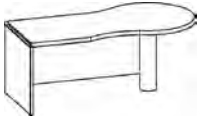

ORDERING NOTES:

All curvilinear posts are 6" in diameter. Laminate worksurfaces are available at a 10% upcharge.

'Q' Desk with Full Height Modesty Panel & Wood Post Leg	68QDL71304LGM	4826		71	30	28.5		269	50
	68QDR71304LGM*	4826		71	30	28.5		269	50
	68QDL84364LGM	5027		84	36	28.5		279	68
	68QDR84364LGM	5027		84	36	28.5		279	68

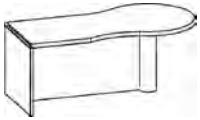

ORDERING NOTES:

All curvilinear posts are 6" in diameter. Laminate worksurfaces are available at a 10% upcharge.

'Q' Desk with Half Drum Base	68QDL8436DB	5010		84	36	28.5	49.5	279	68
	68QDR8436DB*	5010		84	36	28.5	49.5	279	68
	68QDL9636DB	5389		96	36	28.5	59.75	320	68
	68QDR9636DB	5389		96	36	28.5	59.75	320	68

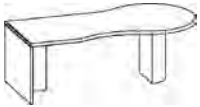

ORDERING NOTES:

Laminate worksurfaces are available at a 10% upcharge.

'Q' Desk with Half Drum Base & Full Height Modesty Panel	68QDL8436DBM	5436		84	36	28.5	46.5	294	68
	68QDR8436DBM*	5436		84	36	28.5	46.5	294	68
	68QDL9636DBM	5846		96	36	28.5	68	335	68
	68QDR9636DBM	5846		96	36	28.5	68	335	68

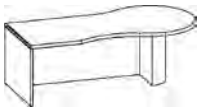

ORDERING NOTES:

Please see page 256 for perforated metal modesty panel option.



'K' Desk with Wood Post Leg	68KDL7130	4362		71	30	28.5	49.5	189	50
	68KDR7130*	4362		71	30	28.5	49.5	189	50
	68KDL8436	4643		84	36	28.5	59.75	232	68
	68KDR8436	4643		84	36	28.5	59.75	232	68

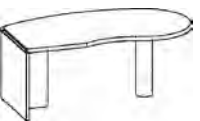

ORDERING NOTES:

Please see page 256 for brushed aluminum tapered post leg option.

ORDERING PROCEDURE

To order, please specify the following:

- 1) Krug product model number
- 2) Wood species and finish, see page 247
- 3) Wood edge detail- I,H, L or P, see page 250
- 4) Pull style, see page 250
- 5) Grommet location if applicable

*Indicates model illustrated by line drawing.

CODE DESCRIPTION

- 3 - 3/4 height modesty panel
- 4 - full height modesty panel
- D - 2 file drawers, 1 file draw
- F - 2 box, 1 file drawer
- DB - half drum base
- LGM - wood base and modesty panel
- DBM - half drum base and modesty panel

STANDARD FINISHES

For a complete list of standard wood finishes please see page 247.

GROMMETS

One wiring grommet in standard position is optional at no charge. Additional wiring grommets are available at an **upcharge of \$152**. See page 251 for more power management information.

MILLENNIUM | CURVILINEAR DESKS

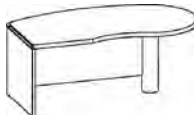
Description	Model	Cherry		W	D	H	KW	Shipping Weight	Cubic Feet
		Walnut	Maple						
 'K' Desk with 3/4 Modesty Panel & Wood Post Leg	68KDL71303LGM	4734		71	30	28.5	49.5	204	50
	68KDR71303LGM*	4734		71	30	28.5	49.5	204	50
	68KDL84363LGM	4904		84	36	28.5	59.75	274	68
	68KDR84363LGM	4904		84	36	28.5	59.75	274	68

 'K' Desk with Full Height Modesty Panel & Wood Post Leg	68KDL71304LGM	4838		71	30	28.5	49.5	209	50
	68KDR71304LGM*	4838		71	30	28.5	49.5	209	50
	68KDL84364LGM	5027		84	36	28.5	59.75	274	68
	68KDR84364LGM	5027		84	36	28.5	59.75	224	68

ORDERING NOTES:

Please see page 256 for perforated metal modesty panel option. Laminate worksurfaces are available at a 10% upcharge. Overhang on the 'K' desk is 23" from the modesty panel.

 'K' Desk with Half Drum Base	68KDL8436DB	5010		84	36	28.5	61.75	279	68
	68KDR8436DB*	5010		84	36	28.5	61.75	279	68
	68KDL9636DB	5389		96	36	28.5	68	320	68
	68KDR9636DB	5389		96	36	28.5	68	320	68

ORDERING NOTES:

Laminate worksurfaces are available at a 10% upcharge. Overhang on the 'K' desk is 23" from the modesty panel.

 'K' Desk with Half Drum Base & Full Height Modesty Panel	68KDL8436DBM	5427		84	36	28.5	61.75	294	68
	68KDR8436DBM*	5427		84	36	28.5	61.75	294	68
	68KDL9636DBM	5846		96	36	28.5	68	335	68
	68KDR9636DBM	5846		96	36	28.5	68	335	68

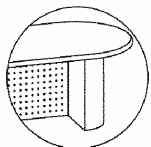

ORDERING NOTES:

Please see page 256 for perforated metal modesty panel option. Laminate worksurfaces are available at a 10% upcharge. Overhang on the 'K' desk is 23" from the modesty panel.

DIMENSION KEY

W - width
D - depth
H - height

CODE DESCRIPTION

3 - 3/4 height modesty panel
4 - full height modesty panel
DB - half drum base
LGM - wood base and modesty panel
DBM - half drum base and modesty panel

STANDARD FINISHES

For a complete list of standard wood finishes please see page 247.

RETURN OPTIONS

Curved corner bullet desks, "Q" desks, and "K" desks, except 24" deep run-off units, returns and linking units.

MILLENNIUM | HEIGHT ADJUSTABLE DESK WORKSURFACES

Description	Model	Cherry	W	D	H	KW	Shipping Weight	Cubic Feet
		Walnut Maple						
Electronic Height Adjustable Worksurface	68HA3024ETS	3074	29.75	24	-	17	108.5	11.5
	68HA3624ETS	3103	35.75	24	-	23	109	14
	68HA4224ETS	3188	41.75	24	-	29	109	16.5
	68HA4824ETS	3271	47.75	24	-	35	109.5	19
	68HA5424ETS	3330	53.5	24	-	41	110	21.5
	68HA6024ETS	3408	59.75	24	-	47	111	24
	68HA6624ETS	3746	2719	24	-	53	114	26.5
	68HA7124ETS	3941	71.75	24	-	59	119.5	29
	68HA7824ETS	3962	77.75	24	-	65	122.5	31.5
	68HA8424ETS	4268	83.75	24	-	71	127	34
	68HA3030ETS	3972	29.75	30	-	17	121.5	36.75
	68HA3630ETS	3383	35.75	30	-	23	122	14.25
	68HA4230ETS	3448	41.75	30	-	29	122	17.5
	68HA4830ETS	3528	47.75	30	-	35	122.5	20.5
	68HA5430ETS	3627	53.5	30	-	41	123	23.5
	68HA6030ETS	3688	59.75	30	-	47	124	26.5
	68HA6630ETS	3896	65.75	30	-	53	131	29.75
	68HA7130ETS*	4095	71.75	30	-	59	132.5	32.75
	68HA7830ETS	4114	77.75	30	-	65	142.5	35.75
	68HA8430ETS	4347	83.75	30	-	71	143.5	38.75
	68HA3036ETS	4040	29.75	36	-	17	121.5	42
	68HA3636ETS	3454	35.75	36	-	23	122	45.5
	68HA4236ETS	3684	41.75	36	-	29	122	17.25
	68HA4836ETS	3754	47.75	36	-	35	122.5	20.75
	68HA5436ETS	3841	53.5	36	-	41	123	24.5
	68HA6036ETS	3924	59.75	36	-	47	124	28.25
	68HA6636ETS	4227	65.75	36	-	53	134	32
	68HA7136ETS	4245	71.75	36	-	59	151.5	35.5
	68HA7836ETS	4286	77.75	36	-	65	158.5	39.25
	68HA8436ETS	4732	83.75	36	-	71	159.5	43

ORDERING NOTES:

To order a height adjustable work surface with a top overhang of 16" at one end add O16 to the end of the model number. eg. 68HA6024ETSO16. Please note that this option is not available on height adjustable work surfaces that are 42" or less in length. This option is not available on dual stage electronic height adjustable worksurfaces. To order a dual stage height adjustable base **add \$674 to the list price** and replace ETS with ETD. eg. 68HA6030ETD.

Lifts come standard with an up/down button. Standard colors are Silver Metallic & Black, please contact customer service for other available colors. A 4 position programmable display is available, please see page 303 for price and model number. Standard base is a T-base. A C base can be specified at the same price. To order a C-base on worksurfaces, up to 30" deep only, replace "T" with "C" e.g. 68HA8430ECS

Single stage height adjustable range: 26" - 45.5"

Dual stage height adjustable range: 21" - 47"

Power cord is 10 feet long.

ORDERING PROCEDURE

To order, please specify the following:

- 1) Krug product model number
- 2) Wood species and finish, see page 26
- 3) Wood edge detail- I, H, L or P, see page 264
- 4) Pull style, see page 265
- 5) Grommet location if applicable

*Indicates model illustrated by line drawing.

CODE DESCRIPTION

HA - height adjustable
 E - electric
 T - T- base
 C - C- base
 S - single stage
 D - dual stage
 RH - return top with cross grain
 V21- half height floating wood modesty panel
 V26- half height floating laminate modesty panel

STANDARD FINISHES

For a complete list of standard wood finishes please see page 247.

STORAGE SHELVES

Storage units feature shelves that are adjustable in increments of approximately 1 1/4".

MILLENNIUM | HEIGHT ADJUSTABLE DESK WORKSURFACES

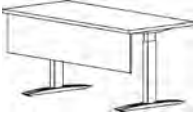
Description	Model	Cherry	W	D	H	KW	Shipping Weight	Cubic Feet	
		Walnut Maple							
	Electronic Height	68HA3024ETSV21	3399	29.75	24	-	17	114.5	11.5
	Adjustable Work	68HA3624ETSV21	3493	35.75	24	-	23	117	14
	Surface with Wood	68HA4224ETSV21	3643	41.75	24	-	29	118	16.5
	Modesty Panel	68HA4824ETSV21	3792	47.75	24	-	35	119.5	19
		68HA5424ETSV21	3917	53.5	24	-	41	122	21.5
		68HA6024ETSV21	4093	59.75	24	-	47	124	24
		68HA6624ETSV21	4437	65.75	24	-	53	128	26.5
		68HA7124ETSV21	4648	71.75	24	-	59	134.5	29
		68HA7824ETSV21	4681	77.75	24	-	65	139.5	31.5
		68HA8424ETSV21	5000	83.75	24	-	71	145	34
		68HA3030ETSV21	4295	29.75	30	-	17	127.5	36.75
		68HA3630ETSV21	3772	35.75	30	-	23	130	14.25
		68HA4230ETSV21	3902	41.75	30	-	29	131	17.5
		68HA4830ETSV21	4045	47.75	30	-	35	132.5	20.5
		68HA5430ETSV21	4184	53.5	30	-	41	135	23.5
		68HA6030ETSV21	4377	59.75	30	-	47	137	26.5
		68HA6630ETSV21	4587	65.75	30	-	53	145	29.75
		68HA7130ETSV21*	4799	71.75	30	-	59	147.5	32.75
		68HA7830ETSV21	4114	77.75	30	-	65	159.5	35.75
		68HA8430ETSV21	5064	83.75	30	-	71	161.5	38.75
		68HA3036ETSV21	4772	29.75	36	-	17	127.5	42
		68HA3636ETSV21	3780	35.75	36	-	23	130	45.5
		68HA4236ETSV21	4072	41.75	36	-	29	131	17.25
		68HA4836ETSV21	4222	47.75	36	-	35	132.5	20.75
		68HA5436ETSV21	4361	53.5	36	-	41	135	24.5
		68HA6036ETSV21	4611	59.75	36	-	47	137	28.25
		68HA6636ETSV21	4918	65.75	36	-	53	148	32
		68HA7136ETSV21	4951	71.75	36	-	59	166.5	35.5
	68HA7836ETSV21	5013	77.75	36	-	65	175.5	39.25	
	68HA8436ETSV21	5517	83.75	36	-	71	177.5	43	

ORDERING NOTES:

To order a height adjustable work surface with a top overhang of 16" at one end insert O16 into the model number after ETS. e.g. 68HA6024ETSO16V21. Please note that this option is not available on height adjustable work surfaces that are 42" or less in length. This option is not available on dual stage electronic height adjustable work surfaces.

To order a dual stage height adjustable base **add \$674 to the list price** and replace ETS with ETD. eg. 68HA6030ETDV21.

Lifts come standard with an up/down button. Standard colors are Silver Metallic & Black, please contact customer service for other available colors. A 4 position programmable display is available, please see page 303 for price and model number. Standard base is a T-base. A C base can be specified at the same price. To order a C-base on work surfaces, up to 30" deep only, replace "T" with "C" e.g. 68HA6630ECSV21

Modesty panels are available in low pressure laminate, please replace V21 with V26 for this option. Modesty panels are also available in palette, please replace V21 with V22 for this option.

Single stage height adjustable range: 26" - 45.5"

Dual stage height adjustable range: 21" - 47"

Power cord is 10 feet long.

DIMENSION KEY

W - width
D - depth
H - height

CODE DESCRIPTION

HA - height adjustable
E - electric
T - T- base
C - C- base
S - single stage
D - dual stage
RH - return top with cross grain
V21- half height floating wood modesty panel
V26- half height floating laminate modesty panel

STANDARD FINISHES

For a complete list of standard wood finishes please see page 247.

GLASS DOORS

All storage glass doors come standard with a vertical Massa pull. Other pull options are not available on glass doors.

MILLENNIUM | HEIGHT ADJUSTABLE DESK WORKSURFACES

Description	Model	Cherry			W	D	H	KW	Shipping Weight	Cubic Feet
		Walnut	Maple							
Electronic Height Adjustable Work Surface with Base Enclosure	68HA4224ETSG	5103			41.75	24	-	24	154	16.5
	68HA4824ETSG	5185			47.75	24	-	30	154.5	19
	68HA5424ETSG	5243			53.5	24	-	36	155	21.5
	68HA6024ETSG	5319			59.75	24	-	42	156	24
	68HA6624ETSG	5660			65.75	24	-	48	159	26.5
	68HA7124ETSG	5856			71.75	24	-	54	164.5	29
	68HA7824ETSG	5874			77.75	24	-	60	167.5	31.5
	68HA8424ETSG	6182			83.75	24	-	66	172	34
	68HA4230ETSG	5586			41.75	30	-	24	177	17.5
	68HA4830ETSG	5664			47.75	30	-	30	177.5	20.5
	68HA5430ETSG	5739			53.5	30	-	36	178	23.5
	68HA6030ETSG	5828			59.75	30	-	42	179	26.5
	68HA6630ETSG	6035			65.75	30	-	42	186	29.75
	68HA7130ETSG*	6233			71.75	30	-	54	187.5	32.75
	68HA7830ETSG	6254			77.75	30	-	60	197.5	35.75
	68HA8430ETSG	6484			83.75	30	-	66	198.5	38.75
	68HA4236ETSG	6044			41.75	36	-	24	187	17.25
	68HA4836ETSG	6113			47.75	36	-	30	187.5	20.75
	68HA5436ETSG	6199			53.5	36	-	36	188	24.5
	68HA6036ETSG	6285			59.75	36	-	42	189	28.25
	68HA6636ETSG	6585			65.75	36	-	48	199	32
	68HA7136ETSG	6605			71.75	36	-	54	216.5	35.5
	68HA7836ETSG	6644			77.75	36	-	60	223.5	39.25
	68HA8436ETSG	7091			83.75	36	-	66	224.5	43



ORDERING NOTES:

To order a height adjustable work surface with a top overhang of 16" at one end insert O16 into the model number after ETS. eg. 68HA6024ETSO16G. Please note that this option is not available on height adjustable work surfaces that have base enclosures and are 54" or less in length. This option is not available on dual stage electronic height adjustable worksurfaces.

To order a dual stage height adjustable base **add \$674 to the list price** and replace ESTA with ETD. eg. 68HA6030ETDG.

Lifts come standard with an up/down button. Standard colors are Silver Metallic & Black, please contact customer service for other available colors. A 4 position programmable display is available, please see page 303 for price and model number.

Single stage height adjustable range: 26" - 45.5"

Dual stage height adjustable range: 21" - 47"

Power cord is 10 feet long.

ORDERING PROCEDURE

To order, please specify the following:

- 1) Krug product model number
- 2) Wood species and finish, see page 26
- 3) Wood edge detail- I, H, L or P, see page 264
- 4) Pull style, see page 265
- 5) Grommet location if applicable

*Indicates model illustrated by line drawing.

CODE DESCRIPTION

HA - height adjustable
 E - electric
 T - T- base
 C - C- base
 S - single stage
 D - dual stage
 RH - return top with cross grain
 V21- half height floating wood modesty panel
 V26- half height floating laminate modest panel

STANDARD FINISHES

For a complete list of standard wood finishes please see page 238.

MILLENNIUM | HEIGHT ADJUSTABLE DESK WORKSURFACES

Description	Model	Cherry		W	D	H	KW	Shipping Weight	Cubic Feet
		Walnut	Maple						
Electronic Height Adjustable Work Surface with Base Enclosure and Floating Modesty Panel	68HA4224ETSGV21	5384		41.75	24	-	24	163	16.5
	68HA4824ETSGV21	5479		47.75	24	-	30	164.5	19
	68HA5424ETSGV21	5553		53.5	24	-	36	167	21.5
	68HA6024ETSGV21	5644		59.75	24	-	42	169	24
	68HA6624ETSGV21	6002		65.75	24	-	48	173	26.5
	68HA7124ETSGV21	6213		71.75	24	-	54	179.5	29
	68HA7824ETSGV21	6253		77.75	24	-	60	184.5	31.5
	68HA8424ETSGV21	6578		83.75	24	-	66	190	34
	68HA4230ETSGV21	5867		41.75	30	-	24	186	17.5
	68HA4830ETSGV21	5961		47.75	30	-	30	187.5	20.5
	68HA5430ETSGV21	6048		53.5	30	-	36	190	23.5
	68HA6030ETSGV21	6155		59.75	30	-	42	192	26.5
	68HA6630ETSGV21	6377		65.75	30	-	48	200	29.75
	68HA7130ETSGV21*	6594		71.75	30	-	54	202.5	32.75
	68HA7830ETSGV21	6630		77.75	30	-	60	214.5	35.75
	68HA8430ETSGV21	6862		83.75	30	-	66	216.5	38.75
	68HA4236ETSGV21	6323		41.75	36	-	24	196	17.25
	68HA4836ETSGV21	6394		47.75	36	-	30	197.5	20.75
	68HA5436ETSGV21	6495		53.5	36	-	36	200	24.5
	68HA6036ETSGV21	6595		59.75	36	-	42	202	28.25
	68HA6636ETSGV21	6912		65.75	36	-	48	213	32
	68HA7136ETSGV21	6945		71.75	36	-	54	231.5	35.5
	68HA7836ETSGV21	7020		77.75	36	-	60	240.5	39.25
	68HA8436ETSGV21	7294		83.75	36	-	66	242.5	43



ORDERING NOTES:

To order a height adjustable work surface with a top overhang of 16" at one end insert O16 into the model number after ETS. eg. 68HA6024ETSO16GV21. Please note that this option is not available on height adjustable work surfaces that have base enclosures and are 54" or less in length. This option is not available on dual stage electronic height adjustable worksurfaces.

To order a dual stage height adjustable base **add \$674 to the list price** and replace ETS with ETD. eg. 68HA6030ETDGV21. Lifts come standard with an up/down button. Standard colors are Silver Metallic & Black, please contact customer service for other available colors. A 4 position programmable display is available, please see page 303 for price and model number.

Modesty panels are available in low pressure laminate, please replace V21 with V26 for this option. Modesty panels are also available in palette, please replace V21 with V22 for this option.

Single stage height adjustable range: 26" - 45.5"

Dual stage height adjustable range: 21" - 47"

Power cord is 10 feet long.

DIMENSION KEY

W - width
D - depth
H - height

CODE DESCRIPTION

HA - height adjustable
E - electric
T - T- base
C - C- base
S - single stage
D - dual stage
RH - return top with cross grain
V21- half height floating wood modesty panel
V26- half height floating laminate modest panel

STANDARD FINISHES

For a complete list of standard wood finishes please see page 238.

MILLENNIUM | HEIGHT ADJUSTABLE RETURN WORKSURFACES

Description	Model	Cherry Walnut Maple	W	D	H	KW	Shipping Weight	Cubic Feet	
	Electronic Height Adjustable Return Worksurface	68HA4824RHETS	3271	47.75	24	-	35	109.5	19
		68HA5424RHETS	3330	53.5	24	-	41	110	21.5
		68HA6024RHETS	3408	59.75	24	-	47	111	24
		68HA6624RHETS	3746	2719	24	-	53	114	26.5
		68HA7124RHETS	3941	71.75	24	-	59	119.5	29
		68HA7824RHETS	3962	77.75	24	-	65	122.5	31.5
		68HA8424RHETS	4268	83.75	24	-	71	127	34
		68HA4830RHETS	3528	47.75	30	-	35	122.5	20.5
		68HA5430RHETS	3627	53.5	30	-	41	123	23.5
		68HA6030RHETS	3688	59.75	30	-	47	124	26.5
	68HA6630RHETS	3896	65.75	30	-	53	131	29.75	
	68HA7130RHETS*	4095	71.75	30	-	59	132.5	32.75	
	68HA7830RHETS	4114	77.75	30	-	65	142.5	35.75	
	68HA8430RHETS	4347	83.75	30	-	71	143.5	38.75	
	68HA4836RHETS	3754	47.75	36	-	35	122.5	20.75	
	68HA5436RHETS	3841	53.5	36	-	41	123	24.5	
	68HA6036RHETS	3924	59.75	36	-	47	124	28.25	
	68HA6636RHETS	4227	65.75	36	-	53	134	32	
	68HA7136RHETS	4245	71.75	36	-	59	151.5	35.5	
	68HA7836RHETS	4286	77.75	36	-	65	158.5	39.25	
	68HA8436RHETS	4732	83.75	36	-	71	159.5	43	

ORDERING NOTES:

To order a height adjustable work surface with a top overhang of 16" at one end add O16 to the end of the model number. eg. 68HA6024ETSO16. Please note that this option is not available on height adjustable work surfaces that are 42" or less in length. This option is not available on dual stage electronic height adjustable worksurfaces. To order a dual stage height adjustable base **add \$674 to the list price** and replace ETS with ETD. eg. 68HA6030ETD.

Lifts come standard with an up/down button. Standard colors are Silver Metallic & Black, please contact customer service for other available colors. A 4 position programmable display is available, please see page 303 for price and model number. . Standard base is a T-base. A C base can be specified at the same price. To order a C-base on worksurfaces, up to 30" deep only, replace "T" with "C" e.g. 68HA8430ECS

Single stage height adjustable range: 26" - 45.5"

Dual stage height adjustable range: 21" - 47"

Power cord is 10 feet long.

ORDERING PROCEDURE

To order, please specify the following:

- 1) Krug product model number
- 2) Wood species and finish, see page 247
- 3) Wood edge detail- I, H, L or P, see page 250
- 4) Pull style, see page 250
- 5) Grommet location if applicable

*Indicates model illustrated by line drawing.

CODE DESCRIPTION

HA - height adjustable
 RH - return (cross grain)
 E - electric
 T - T- base
 C - C- base
 S - single stage
 D - dual stage

STANDARD FINISHES

For a complete list of standard wood finishes please see page 247.

STORAGE SHELVES

Storage units feature shelves that are adjustable in increments of approximately 1 1/4".

MILLENNIUM | HEIGHT ADJUSTABLE RETURN WORKSURFACES

Description	Model	Cherry	W	D	H	KW	Shipping Weight	Cubic Feet
		Walnut Maple						
	68HA4824RHETSV21	3792	47.75	24	-	35	119.5	19
	68HA5424RHETSV21	3917	53.5	24	-	41	122	21.5
	68HA6024RHETSV21	4093	59.75	24	-	47	124	24
	68HA6624RHETSV21	4437	65.75	24	-	53	128	26.5
	68HA7124RHETSV21	4648	71.75	24	-	59	134.5	29
	68HA7824RHETSV21	4681	77.75	24	-	65	139.5	31.5
	68HA8424RHETSV21	5000	83.75	24	-	71	145	34
	68HA4830RHETSV21	4045	47.75	30	-	35	132.5	20.5
	68HA5430RHETSV21	4184	53.5	30	-	41	135	23.5
	68HA6030RHETSV21	4377	59.75	30	-	47	137	26.5
	68HA6630RHETSV21	4587	65.75	30	-	53	145	29.75
	68HA7130RHETSV21*	4799	71.75	30	-	59	147.5	32.75
	68HA7830RHETSV21	4114	77.75	30	-	65	159.5	35.75
	68HA8430RHETSV21	5064	83.75	30	-	71	161.5	38.75
	68HA4836RHETSV21	4222	47.75	36	-	35	132.5	20.75
	68HA5436RHETSV21	4361	53.5	36	-	41	135	24.5
	68HA6036RHETSV21	4611	59.75	36	-	47	137	28.25
	68HA6636RHETSV21	4918	65.75	36	-	53	148	32
68HA7136RHETSV21	4951	71.75	36	-	59	166.5	35.5	
68HA7836RHETSV21	5013	77.75	36	-	65	175.5	39.25	
68HA8436RHETSV21	5517	83.75	36	-	71	177.5	43	

ORDERING NOTES:

To order a height adjustable work surface with a top overhang of 16" at one end insert O16 into the model number after ETS. eg. 68HA6024ETSO16V21. Please note that this option is not available on height adjustable work surfaces that are 42" or less in length. This option is not available on dual stage electronic height adjustable work surfaces.

To order a dual stage height adjustable base **add \$674 to the list price** and replace ETS with ETD. eg. 68HA6030ETDV21. .

Lifts come standard with an up/down button. Standard colors are Silver Metallic & Black, please contact customer service for other available colors. A 4 position programmable display is available, please see page 303 for price and model number. Standard base is a T-base. A C base can be specified at the same price. To order a C-base on work surfaces, up to 30" deep only, replace "T" with "C" e.g. 68HA6630ECSV21

Modesty panels are available in low pressure laminate, please replace V21 with V26 for this option. e.g. 68HA6030ETSV26.

Please see page 373 for Low-Pressure Laminate options.

Single stage height adjustable range: 26" - 45.5"

Dual stage height adjustable range: 21" - 47"

Power cord is 10 feet long.

DIMENSION KEY

W - width
D - depth
H - height

CODE DESCRIPTION

HA - height adjustable
RH - return (cross grain)
E - electric
T - T- base
C - C- base
S - single stage
D - dual stage
V21 - 1/2 height floating wood modesty panel

STANDARD FINISHES

For a complete list of standard wood finishes please see page 247.

GLASS DOORS

All storage glass doors come standard with a vertical Massa pull. Other pull options are not available on glass doors.

MILLENNIUM | HEIGHT ADJUSTABLE RETURN WORKSURFACES

Description	Model	Cherry		W	D	H	KW	Shipping Weight	Cubic Feet
		Walnut	Maple						
 Electronic Height Adjustable Return Worksurface with Base Enclosure	68HA4824RHETSG	5185		47.75	24	-	30	154.5	19
	68HA5424RHETSG	5243		53.5	24	-	36	155	21.5
	68HA6024RHETSG	5319		59.75	24	-	42	156	24
	68HA6624RHETSG	5660		65.75	24	-	48	159	26.5
	68HA7124RHETSG	5856		71.75	24	-	54	164.5	29
	68HA7824RHETSG	5874		77.75	24	-	60	167.5	31.5
	68HA8424RHETSG	6182		83.75	24	-	66	172	34
	68HA4830RHETSG	5664		47.75	30	-	30	177.5	20.5
	68HA5430RHETSG	5739		53.5	30	-	36	178	23.5
	68HA6030RHETSG	5828		59.75	30	-	42	179	26.5
68HA6630RHETSG	6035		65.75	30	-	42	186	29.75	
68HA7130RHETSG*	6233		71.75	30	-	54	187.5	32.75	
68HA7830RHETSG	6254		77.75	30	-	60	197.5	35.75	
68HA8430RHETSG	6484		83.75	30	-	66	198.5	38.75	
68HA4836RHETSG	6113		47.75	36	-	30	187.5	20.75	
68HA5436RHETSG	6199		53.5	36	-	36	188	24.5	
68HA6036RHETSG	6285		59.75	36	-	42	189	28.25	
68HA6636RHETSG	6585		65.75	36	-	48	199	32	
68HA7136RHETSG	6605		71.75	36	-	54	216.5	35.5	
68HA7836RHETSG	6644		77.75	36	-	60	223.5	39.25	
68HA8436RHETSG	7091		83.75	36	-	66	224.5	43	

ORDERING NOTES:

To order a height adjustable work surface with a top overhang of 16" at one end insert O16 into the model number after ETS. e.g. 68HA6024ETSO16G. Please note that this option is not available on height adjustable work surfaces that have base enclosures and are 54" or less in length. This option is not available on dual stage electronic height adjustable worksurfaces.

To order a dual stage height adjustable base **add \$674 to the list price** and replace ESTA with ETD. eg. 68HA6030ETDG. .

Lifts come standard with an up/down button. Standard colors are Silver Metallic & Black, please contact customer service for other available colors. A 4 position programmable display is available, please see page 303 for price and model number.

Single stage height adjustable range: 26" - 45.5"

Dual stage height adjustable range: 21" - 47"

Power cord is 10 feet long.

ORDERING PROCEDURE

To order, please specify the following:

- 1) Krug product model number
- 2) Wood species and finish, see page 247
- 3) Wood edge detail- I,H, L or P, see page 250
- 4) Pull style, see page 250
- 5) Grommet location if applicable

*Indicates model illustrated by line drawing.

CODE DESCRIPTION

HA - height adjustable
 RH - return (cross grain)
 E - electric
 T - T- base
 C - C- base
 S - single stage
 D - dual stage

STANDARD FINISHES

For a complete list of standard wood finishes please see page 247.

MILLENNIUM | HEIGHT ADJUSTABLE RETURN WORKSURFACES

Description	Model	Cherry		W	D	H	KW	Shipping Weight	Cubic Feet
		Walnut	Maple						
Electronic Height Adjustable Return Worksurface with Base Enclosure and Floating Modesty Panel	68HA4824RHETSGV21	5479	5479	47.75	24	-	30	164.5	19
	68HA5424RHETSGV21	5553	5553	53.5	24	-	36	167	21.5
	68HA6024RHETSGV21	5644	5644	59.75	24	-	42	169	24
	68HA6624RHETSGV21	6002	6002	65.75	24	-	48	173	26.5
	68HA7124RHETSGV21	6213	6213	71.75	24	-	54	179.5	29
	68HA7824RHETSGV21	6253	6253	77.75	24	-	60	184.5	31.5
	68HA8424RHETSGV21	6578	6578	83.75	24	-	66	190	34
	68HA4830RHETSGV21	5961	5961	47.75	30	-	30	187.5	20.5
	68HA5430RHETSGV21	6048	6048	53.5	30	-	36	190	23.5
	68HA6030RHETSGV21	6155	6155	59.75	30	-	42	192	26.5
68HA6630RHETSGV21	6377	6377	65.75	30	-	48	200	29.75	
68HA7130RHETSGV21*	6594	6594	71.75	30	-	54	202.5	32.75	
68HA7830RHETSGV21	6630	6630	77.75	30	-	60	214.5	35.75	
68HA8430RHETSGV21	6862	6862	83.75	30	-	66	216.5	38.75	
68HA4836RHETSGV21	6394	6394	47.75	36	-	30	197.5	20.75	
68HA5436RHETSGV21	6495	6495	53.5	36	-	36	200	24.5	
68HA6036RHETSGV21	6595	6595	59.75	36	-	42	202	28.25	
68HA6636RHETSGV21	6912	6912	65.75	36	-	48	213	32	
68HA7136RHETSGV21	6945	6945	71.75	36	-	54	231.5	35.5	
68HA7836RHETSGV21	7020	7020	77.75	36	-	60	240.5	39.25	
68HA8436RHETSGV21	7294	7294	83.75	36	-	66	242.5	43	



ORDERING NOTES:

To order a height adjustable work surface with a top overhang of 16" at one end insert O16 into the model number after ETS. eg. 68HA6024ETSO16GV21. Please note that this option is not available on height adjustable work surfaces that have base enclosures and are 54" or less in length. This option is not available on dual stage electronic height adjustable worksurfaces.

To order a dual stage height adjustable base **add \$674 to the list price** and replace ETS with ETD. eg. 68HA6030ETDGV21. Lifts come standard with an up/down button. Standard colors are Silver Metallic & Black, please contact customer service for other available colors. A 4 position programmable display is available, please see page 303 for price and model number.

Modesty panels are available in low pressure laminate, please replace V21 with V26 for this option. e.g. 68HA6030ETSGV26.

Please see page 373 for Low-Pressure Laminate options.

Modesty panels are also available in palette, please replace V21 with V22 for this option. e.g. 68HA6030ETSGV22..

Single stage height adjustable range: 26" - 45.5"

Dual stage height adjustable range: 21" - 47"

Power cord is 10 feet long.

DIMENSION KEY

W - width
D - depth
H - height

CODE DESCRIPTION

HA - height adjustable
RH - return (cross grain)
E - electric
T - T- base
C - C- base
S - single stage
D - dual stage
V21 - 1/2 height floating wood modesty panel

STANDARD FINISHES

For a complete list of standard wood finishes please see page 247.

MILLENNIUM | RETURNS

Description	Model	Cherry Walnut Maple	W	D	H	KW	Shipping Weight	Cubic Feet
Return, Desk Height with Full Height Pedestal	68RH3620L4D	3698	36	20.25	28.5	19.5	101	15
	68RH3620L4F	3698	36	20.25	28.5	19.5	101	15
	68RH3620R4D	3698	36	20.25	28.5	19.5	101	15
	68RH3620R4F	3698	36	20.25	28.5	19.5	101	15
	68RH3624L4D	3732	36	24.25	28.5	19.5	115	18
	68RH3624L4F	3732	36	24.25	28.5	19.5	115	18
	68RH3624R4D	3732	36	24.25	28.5	19.5	115	18
	68RH3624R4F	3732	36	24.25	28.5	19.5	115	18
	68RH3630L4D	3762	36	30.25	28.5	19.5	136	21
	68RH3630L4F	3762	36	30.25	28.5	19.5	136	21
	68RH3630R4D	3762	36	30.25	28.5	19.5	136	21
	68RH3630R4F	3762	36	30.25	28.5	19.5	136	21
	68RH4220L4D	3761	42	20.25	28.5	25.5	113	17
	68RH4220L4F	3761	42	20.25	28.5	25.5	113	17
	68RH4220R4D	3761	42	20.25	28.5	25.5	113	17
	68RH4220R4F	3761	42	20.25	28.5	25.5	113	17
	68RH4224L4D	3819	42	24.25	28.5	25.5	129	20
	68RH4224L4F*	3819	42	24.25	28.5	25.5	129	20
	68RH4224R4D	3819	42	24.25	28.5	25.5	129	20
	68RH4224R4F	3819	42	24.25	28.5	25.5	129	20
	68RH4230L4D	3840	42	30.25	28.5	25.5	154	25
	68RH4230L4F	3840	42	30.25	28.5	25.5	154	25
	68RH4230R4D	3840	42	30.25	28.5	25.5	154	25
	68RH4230R4F	3840	42	30.25	28.5	25.5	154	25
	68RH4820L4D	3866	48	20.25	28.5	31.5	125	20
	68RH4820L4F	3866	48	20.25	28.5	31.5	125	20
	68RH4820R4D	3866	48	20.25	28.5	31.5	125	20
	68RH4820R4F	3866	48	20.25	28.5	31.5	125	20
	68RH4824L4D	3867	48	24.25	28.5	31.5	144	23
	68RH4824L4F	3867	48	24.25	28.5	31.5	144	23
	68RH4824R4D	3867	48	24.25	28.5	31.5	144	23
	68RH4824R4F	3867	48	24.25	28.5	31.5	144	23
	68RH4830L4D	3888	48	30.25	28.5	31.5	172	29
	68RH4830L4F	3888	48	30.25	28.5	31.5	172	29
	68RH4830R4D	3888	48	30.25	28.5	31.5	172	29
	68RH4830R4F	3888	48	30.25	28.5	31.5	172	29
	68RH5420L4D	3898	54	20.25	28.5	37.5	137	22
	68RH5420L4F	3898	54	20.25	28.5	37.5	137	22
	68RH5420R4D	3898	54	20.25	28.5	37.5	137	22
	68RH5420R4F	3898	54	20.25	28.5	37.5	137	22
	68RH5424L4D	3931	54	24.25	28.5	37.5	158	15
	68RH5424L4F	3931	54	24.25	28.5	37.5	158	15
	68RH5424R4D	3931	54	24.25	28.5	37.5	158	15
	68RH5424R4F	3931	54	24.25	28.5	37.5	158	15
	68RH5430L4D	3985	54	30.25	28.5	37.5	190	18
	68RH5430L4F	3985	54	30.25	28.5	37.5	190	18
	68RH5430R4D	3985	54	30.25	28.5	37.5	190	18
	68RH5430R4F	3985	54	30.25	28.5	37.5	190	18

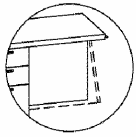

ORDERING NOTES:

Please see page 256 for wire management cut-out option and for hinged modesty panel option. Laminate worksurfaces are available at a 10% upcharge. For reverse grain direction on returns use list price and note Reverse Grain on p.o.

ORDERING PROCEDURE

To order, please specify the following:

- 1) Krug product model number
- 2) Wood species and finish, see page 247
- 3) Wood edge detail- I,H, L or P, see page 250
- 4) Pull style, see page 250
- 5) Grommet location if applicable

*Indicates model illustrated by line drawing.

CODE DESCRIPTION

- 4 - full height pedestal
- L - left handed pedestal position
- R - right handed pedestal position
- D - 2 file drawer
- F - 2 box, 1 file drawer

STANDARD FINISHES

For a complete list of standard wood finishes please see page 247.

GROMMETS

One wiring grommet in standard position is optional at no charge. Additional wiring grommets are available at **an upcharge of \$152.**

MILLENNIUM | RETURNS

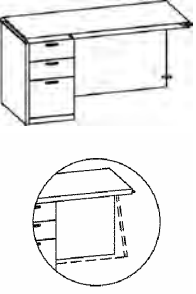
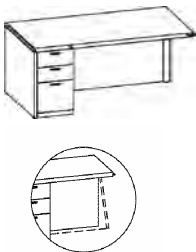
Description	Model	Cherry		W	D	H	KW	Shipping Weight	Cubic Feet
		Walnut	Maple						
Return, Desk Height with Full Height Pedestal 	68RH6020L4D	4044		60	20.25	28.5	43.5	147	17
	68RH6020L4F	4044		60	20.25	28.5	43.5	147	17
	68RH6020R4D	4044		60	20.25	28.5	43.5	147	17
	68RH6020R4F	4044		60	20.25	28.5	43.5	147	17
	68RH6024L4D	4107		60	24.25	28.5	43.5	170	20
	68RH6024L4F	4107		60	24.25	28.5	43.5	170	20
	68RH6024R4D	4107		60	24.25	28.5	43.5	170	20
	68RH6024R4F	4107		60	24.25	28.5	43.5	170	20
	68RH6030L4D	4217		60	30.25	28.5	43.5	205	20
	68RH6030L4F*	4217		60	30.25	28.5	43.5	205	20
	68RH6030R4D	4217		60	30.25	28.5	43.5	205	20
	68RH6030R4F	4217		60	30.25	28.5	43.5	205	20
	68RH6620L4D	4306		65.75	20.25	28.5	49.25	159	23
	68RH6620L4F	4306		65.75	20.25	28.5	49.25	159	23
	68RH6620R4D	4306		65.75	20.25	28.5	49.25	159	23
	68RH6620R4F	4306		65.75	20.25	28.5	49.25	159	23
	68RH6624L4D	4365		65.75	24.25	28.5	49.25	184	22
	68RH6624L4F	4365		65.75	24.25	28.5	49.25	184	22
	68RH6624R4D	4365		65.75	24.25	28.5	49.25	184	22
	68RH6624R4F	4365		65.75	24.25	28.5	49.25	184	22
	68RH6630L4D	4416		65.75	30.25	28.5	49.25	223	26
	68RH6630L4F	4416		65.75	30.25	28.5	49.25	223	26
	68RH6630R4D	4416		65.75	30.25	28.5	49.25	223	26
	68RH6630R4F	4416		65.75	30.25	28.5	49.25	223	26
	68RH7124L4D	4498		71	24.25	28.5	54.5	227	34
	68RH7124L4F	4498		71	24.25	28.5	54.5	227	34
	68RH7124R4D	4498		71	24.25	28.5	54.5	227	34
	68RH7124R4F	4498		71	24.25	28.5	54.5	227	34
	68RH7130L4D	4534		71	30.25	28.5	54.5	268	42
	68RH7130L4F	4534		71	30.25	28.5	54.5	268	42
68RH7130R4D	4534		71	30.25	28.5	54.5	268	42	
68RH7130R4F	4534		71	30.25	28.5	54.5	268	42	
68RH8424L4D	4611		83.75	24.25	28.5	67.5	227	34	
68RH8424L4F	4611		83.75	24.25	28.5	67.5	227	34	
68RH8424R4D	4611		83.75	24.25	28.5	67.5	227	34	
68RH8424R4F	4611		83.75	24.25	28.5	67.5	227	34	
68RH8430L4D	4655		83.75	30.25	28.5	67.5	260	50	
68RH8430L4F	4655		83.75	30.25	28.5	67.5	260	50	
68RH8430R4D	4655		83.75	30.25	28.5	67.5	260	50	
68RH8430R4F	4655		83.75	30.25	28.5	67.5	260	50	
Return, Desk Height & Depth with Full Height Pedestal 	68RD6636L4D	4678		65.75	36.25	28.5	48.75	255	42
	68RD6636L4F*	4678		65.75	36.25	28.5	48.75	255	42
	68RD6636R4D	4678		65.75	36.25	28.5	48.75	255	42
	68RD6636R4F	4678		65.75	36.25	28.5	48.75	255	42
	68RD7136L4D	4778		71	36.25	28.5	54.5	252	50
	68RD7136L4F	4778		71	36.25	28.5	54.5	252	50
	68RD7136R4D	4778		71	36.25	28.5	54.5	252	50
	68RD7136R4F	4778		71	36.25	28.5	54.5	252	50
	68RD8436L4D	4970		83.75	36.25	28.5	67.5	270	60
	68RD8436L4F	4970		83.75	36.25	28.5	67.5	270	60
	68RD8436R4D	4970		83.75	36.25	28.5	67.5	270	60
	68RD8436R4F	4970		83.75	36.25	28.5	67.5	270	60

ORDERING NOTES: For reverse grain direction on returns use list price and note Reverse Grain on p.o.

DIMENSION KEY

W - width
D - depth
H - height

CODE DESCRIPTION

4 - full height pedestal
L - left handed pedestal position
R - right handed pedestal position
D - 2 file drawer
F - 2 box, 1 file drawer



STANDARD FINISHES

For a complete list of standard wood finishes please see page 247.

OPEN/DESK RETURNS

Open returns can be found in the shell section on page 298. Desk depth returns have a recessed modesty panel.

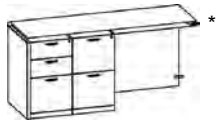
MILLENNIUM | RETURNS

Description	Model	Cherry		W	D	H	KW	Shipping Weight	Cubic Feet
		Walnut	Maple						
Return, Full Height	68RH6020L4DD**	5187		60	20.25	28.5	28.5	179	25
Ganged Pedestals	68RH6020L4DF*	5187		60	20.25	28.5	28.5	179	25
	68RH6020L4FD	5187		60	20.25	28.5	28.5	179	25
	68RH6020L4FF	5187		60	20.25	28.5	28.5	179	25
	68RH6020R4DD	5187		60	20.25	28.5	28.5	179	25
	68RH6020R4DF	5187		60	20.25	28.5	28.5	179	25
	68RH6020R4FD	5187		60	20.25	28.5	28.5	179	25
	68RH6020R4FF	5187		60	20.25	28.5	28.5	179	25
	68RH6024L4DD	5219		60	24.25	28.5	28.5	202	29
	68RH6024L4DF	5219		60	24.25	28.5	28.5	202	29
	68RH6024L4FD	5219		60	24.25	28.5	28.5	202	29
	68RH6024L4FF	5219		60	24.25	28.5	28.5	202	29
	68RH6024R4DD	5219		60	24.25	28.5	28.5	202	29
	68RH6024R4DF	5219		60	24.25	28.5	28.5	202	29
	68RH6024R4FD	5219		60	24.25	28.5	28.5	202	29
	68RH6024R4FF	5219		60	24.25	28.5	28.5	202	29
	68RH6030L4DD	5240		60	30.25	28.5	28.5	237	36
	68RH6030L4DF	5240		60	30.25	28.5	28.5	237	36
	68RH6030L4FD	5240		60	30.25	28.5	28.5	237	36
	68RH6030L4FF	5240		60	30.25	28.5	28.5	237	36
	68RH6030R4DD	5240		60	30.25	28.5	28.5	237	36
	68RH6030R4DF	5240		60	30.25	28.5	28.5	237	36
	68RH6030R4FD	5240		60	30.25	28.5	28.5	237	36
	68RH6030R4FF	5240		60	30.25	28.5	28.5	237	36
	68RH6620L4DD	5260		65.75	20.25	28.5	34.25	191	27
	68RH6620L4DF	5260		65.75	20.25	28.5	34.25	191	27
	68RH6620L4FD*	5260		65.75	20.25	28.5	34.25	191	27
	68RH6620L4FF	5260		65.75	20.25	28.5	34.25	191	27
	68RH6620R4DD	5260		65.75	20.25	28.5	34.25	191	27
	68RH6620R4DF	5260		65.75	20.25	28.5	34.25	191	27
	68RH6620R4FD	5260		65.75	20.25	28.5	34.25	191	27
	68RH6620R4FF	5260		65.75	20.25	28.5	34.25	191	27
	68RH6624L4DD	5300		65.75	24.25	28.5	34.25	216	32
	68RH6624L4DF	5300		65.75	24.25	28.5	34.25	216	32
	68RH6624L4FD	5300		65.75	24.25	28.5	34.25	216	32
	68RH6624L4FF	5300		65.75	24.25	28.5	34.25	216	32
	68RH6624R4DD	5300		65.75	24.25	28.5	34.25	216	32
	68RH6624R4DF	5300		65.75	24.25	28.5	34.25	216	32
	68RH6624R4FD	5300		65.75	24.25	28.5	34.25	216	32
	68RH6624R4FF	5300		65.75	24.25	28.5	34.25	216	32
	68RH6630L4DD	5319		65.75	30.25	28.5	34.25	255	39
	68RH6630L4DF	5319		65.75	30.25	28.5	34.25	255	39
	68RH6630L4FD	5319		65.75	30.25	28.5	34.25	255	39
	68RH6630L4FF	5319		65.75	30.25	28.5	34.25	255	39
	68RH6630R4DD	5319		65.75	30.25	28.5	34.25	255	39
	68RH6630R4DF	5319		65.75	30.25	28.5	34.25	255	39
	68RH6630R4FD	5319		65.75	30.25	28.5	34.25	255	39
	68RH6630R4FF	5319		65.75	30.25	28.5	34.25	255	39
	68RH7124L4DD	5365		71	24.25	28.5	39.5	227	34
	68RH7124L4DF	5365		71	24.25	28.5	39.5	227	34

ORDERING NOTES:

Please see page 256 for wire management cut-out option and for hinged modesty panel option. Laminate work-surfaces are available at a 10% upcharge.

ORDERING PROCEDURE

To order, please specify the following:

- 1) Krug product model number
- 2) Wood species and finish, see page 247
- 3) Wood edge detail- I,H, L or P, see page 250
- 4) Pull style, see page 250
- 5) Grommet location if applicable

*Indicates model illustrated by line drawing.

CODE DESCRIPTION

- 4 - full height pedestal
- L - left handed pedestal position
- R - right handed pedestal position
- D - 2 file drawer
- F - 2 box, 1 file drawer



STANDARD FINISHES

For a complete list of standard wood finishes please see page 247.

GROMMETS

One wiring grommet in standard position is optional at no charge. Additional wiring grommets are available at an **upcharge of \$152.**

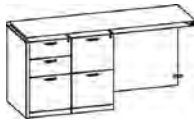
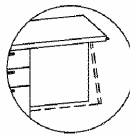
MILLENNIUM | RETURNS

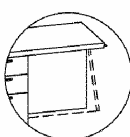
Description	Model	Cherry Walnut Maple			W	D	H	KW	Shipping Weight	Cubic Feet
Return, Full Height Ganged Pedestals Continued	68RH7124L4FD	5365			71	24.25	28.5	39.5	227	34
	68RH7124L4FF	5365			71	24.25	28.5	39.5	227	34
 	68RH7124R4DD	5365			71	24.25	28.5	39.5	227	34
	68RH7124R4DF	5365			71	24.25	28.5	39.5	227	34
	68RH7124R4FD	5365			71	24.25	28.5	39.5	227	34
	68RH7124R4FF	5365			71	24.25	28.5	39.5	227	34
	68RH7130L4DD	5430			71	30.25	28.5	39.5	268	42
	68RH7130L4DF	5430			71	30.25	28.5	39.5	268	42
	68RH7130L4FD	5430			71	30.25	28.5	39.5	268	42
	68RH7130L4FF	5430			71	30.25	28.5	39.5	268	42
	68RH7130R4DD	5430			71	30.25	28.5	39.5	268	42
	68RH7130R4DF	5430			71	30.25	28.5	39.5	268	42
	68RH7130R4FD*	5430			71	30.25	28.5	39.5	268	42
	68RH7130R4FF	5430			71	30.25	28.5	39.5	268	42
	68RH8424L4DD	5525			83.75	24.25	28.5	52.5	260	40
	68RH8424L4DF	5525			83.75	24.25	28.5	52.5	260	40
	68RH8424L4FD	5525			83.75	24.25	28.5	52.5	260	40
	68RH8424L4FF	5525			83.75	24.25	28.5	52.5	260	40
	68RH8424R4DD	5525			83.75	24.25	28.5	52.5	260	40
	68RH8424R4DF	5525			83.75	24.25	28.5	52.5	260	40
	68RH8424R4FD	5525			83.75	24.25	28.5	52.5	260	40
	68RH8424R4FF	5525			83.75	24.25	28.5	52.5	260	40
	68RH8430L4DD	5574			83.75	30.25	28.5	52.5	309	50
	68RH8430L4DF	5574			83.75	30.25	28.5	52.5	309	50
	68RH8430L4FD	5574			83.75	30.25	28.5	52.5	309	50
	68RH8430L4FF	5574			83.75	30.25	28.5	52.5	309	50
	68RH8430R4DD	5574			83.75	30.25	28.5	52.5	309	50
	68RH8430R4DF	5574			83.75	30.25	28.5	52.5	309	50
	68RH8430R4FD	5574			83.75	30.25	28.5	52.5	309	50
	68RH8430R4FF	5574			83.75	30.25	28.5	52.5	309	50
Return, Lateral File Pedestal	68RH6024LLF*	4966			60	24.25	28.5	24	218	29
	68RH6024RLF	4966			60	24.25	28.5	24	218	29
	68RH7124LLF	5010			71	24.25	28.5	35	243	34
	68RH7124RLF	5010			71	24.25	28.5	35	243	34
	68RH8424LLF	5075			84	24.25	28.5	48	279	36
	68RH8424RLF	5075			84	24.25	28.5	48	279	36
	 									

ORDERING NOTES:

Please see page 256 for wire management cut-out option and for hinged modesty panel option. Laminate work-surfaces are available at a 10% upcharge. For reverse grain direction on returns use list price and note Reverse Grain on p.o.

DIMENSION KEY

W - width
D - depth
H - height

CODE DESCRIPTION

4 - full height pedestal
L - left handed pedestal position
R - right handed pedestal position
D - 2 file drawer
F - 2 box, 1 file drawer

STANDARD FINISHES

For a complete list of standard wood finishes please see page 247.

OPEN/DESK RETURNS

Open returns can be found in the shell section on page 298. Desk depth returns have a recessed modesty panel.

MILLENNIUM | RETURNS

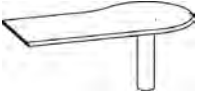

Description	Model	Cherry		W	D	H	KW	Shipping Weight	Cubic Feet
		Walnut	Maple						
 Bullet Return with Post Leg	68BR6030*	2114		60	30.25	28.5		131	4
	68BR6630	2155		65.75	30.25	28.5		149	4
	68BR6636	2168		65.75	36.25	28.5		189	5
	68BR7130	2217		71	30.25	28.5		164	4
	68BR7136	2291		71	36.25	28.5		207	4

 P' Return with Post Leg	68PRL7130	3030		71	30	28.5	48.6	184	50
	68PRR7130*	3030		71	30	28.5	48.6	184	50
	68PRL7136	3175		71	36	28.5	48.6	227	58
	68PRR7136	3175		71	36	28.5	48.6	227	58
	68PRL8430	3472		84	30	28.5	65.25	207	59
	68PRR8430	3472		84	30	28.5	65.25	207	59
	68PRL8436	3587		84	36	28.5	62.5	254	68
68PRR8436	3587		84	36	28.5	62.5	254	68	

ORDERING NOTES:

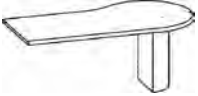
Please see page 256 for brushed aluminum tapered post leg option.

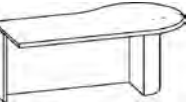
 P' Return with Half Drum Base	68PRL7130DB	3389		71	30	28.5	48.6	184	50
	68PRR7130DB*	3389		71	30	28.5	48.6	184	50
	68PRL7136DB	3538		71	36	28.5	48.6	227	58
	68PRR7136DB	3538		71	36	28.5	48.6	227	58
	68PRL8430DB	3839		84	30	28.5	65.25	207	59
	68PRR8430DB	3839		84	30	28.5	65.25	207	59
	68PRL8436DB	3950		84	36	28.5	62.5	254	68
	68PRR8436DB	3950		84	36	28.5	62.5	254	68
	68PRL9630DB	4119		96	30	28.5	70.75	241	74
	68PRR9630DB	4119		96	30	28.5	70.75	241	74
	68PRL9636DB	4469		96	36	28.5	68	295	77
	68PRR9636DB	4469		96	36	28.5	68	295	77

  'P' Return with Half Drum Base & Full Modesty Panel	68PRL7130DBM	4545		71	30	28.5	48.6	204	50
	68PRR7130DBM*	4545		71	30	28.5	48.6	204	50
	68PRL7136DBM	4579		71	36	28.5	48.6	247	58
	68PRR7136DBM	4579		71	36	28.5	48.6	247	58
	68PRL8430DBM	4914		84	30	28.5	65.25	232	59
	68PRR8430DBM	4914		84	30	28.5	65.25	232	59
	68PRL8436DBM	4656		84	36	28.5	62.5	274	68
	68PRR8436DBM	4656		84	36	28.5	62.5	274	68
	68PRL9630DBM	4962		96	30	28.5	70.75	261	74
	68PRR9630DBM	4962		96	30	28.5	70.75	261	74
	68PRL9636DBM	5338		96	36	28.5	68	310	77
	68PRR9636DBM	5338		96	36	28.5	68	310	77

ORDERING NOTES:

Please see page 256 for perforated metal modesty panel option. For reverse grain direction on returns use list price and note Reverse Grain on p.o.

ORDERING PROCEDURE

To order, please specify the following:

- 1) Krug product model number
- 2) Wood species and finish, see page 247
- 3) Wood edge detail- I,H, L or P, see page 250
- 4) Pull style, see page 250
- 5) Grommet location if applicable

*Indicates model illustrated by line drawing.

CODE DESCRIPTION

4 - full height pedestal
 DB - Half Drum Base
 DBM - Half Drum Base & Full Modesty Panel

STANDARD FINISHES

For a complete list of standard wood finishes please see page 247.

GROMMETS

One wiring grommet in standard position is optional at no charge. Additional wiring grommets are available at an **upcharge of \$152.**

MILLENNIUM | LINKING TOPS

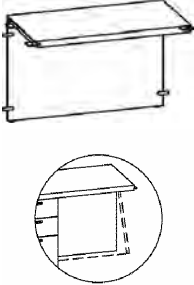
Description	Model	Cherry Walnut Maple	W	D	H	KW	Shipping Weight	Cubic Feet
	68LU3024H	1697	29.5	24.25	28.5		57	6
	68LU3620H	1776	35.5	20.25	28.5		54	6
	68LU3624H	1834	35.5	24.25	28.5		68	7
	68LU4220H	1857	41.5	20.25	28.5		66	7
	68LU4224H	1920	41.5	24.25	28.5		82	8
	68LU4820H*	1959	47.5	20.25	28.5		78	8
	68LU4824H	1993	47.5	24.25	28.5		97	9
	68LU5420H	2019	53.5	20.25	28.5		90	9
	68LU5424H	2045	53.5	24.25	28.5		111	10
	68LU6020H	2063	59.5	20.25	28.5		100	10
	68LU6024H	2096	59.5	24.25	28.5		123	11
	68LU6624H	2229	65.5	24.25	28.5		137	12
	68LU7124H	2378	70.5	24.25	28.5		148	13

ORDERING NOTES:

Please see page 256 for wire management cut-out option. Please see page 256 for hinged modesty panel option and perforated metal modesty panel option.

	68LUC3624H	2158	35.5	24.25	28.5		68	7
	68LUC4224H	2197	41.5	24.25	28.5		82	8
	68LUC4824H*	2321	47.5	24.25	28.5		97	9

ORDERING NOTES:

Please see page 256 for wire management cut-out option. Please see page 256 for hinged modesty panel option and for perforated metal modesty panel option. Linking unit is 21.25" deep at the center of the curve.

	68LT3620H	883	35.5	20.25	28.5		34	6
	68LT3624H	888	35.5	24.25	28.5		48	6
	68LT4220H	915	41.5	20.25	28.5		46	7
	68LT4224H	943	41.5	24.25	28.5		62	8
	68LT4820H*	968	47.5	20.25	28.5		58	8
	68LT4824H	984	47.5	24.25	28.5		77	9
	68LT5420H	997	53.5	20.25	28.5		70	9
	68LT5424H	1006	53.5	24.25	28.5		91	10
	68LT6020H	1018	59.5	20.25	28.5		80	10
	68LT6024H	1053	59.5	24.25	28.5		93	11
	68LT6620H	1066	65.5	20.25	28.5		82	11
	68LT6624H	1084	65.5	24.25	28.5		107	12
	68LT7124H	1107	70.5	24.25	28.5		118	13

ORDERING NOTES: For reverse grain direction on returns use list price and note Reverse Grain on p.o.

	68LTC3624H	1019	35.5	24.25	28.5		48	6
	68LTC4224H	1073	41.5	24.25	28.5		62	8
	68LTC4824H*	1136	47.5	24.25	28.5		77	9

ORDERING NOTES: Linking unit is 21.25" deep at the center of the curve. For reverse grain direction on returns use list price and note Reverse Grain on p.o.

DIMENSION KEY

W - width
D - depth
H - height

CODE DESCRIPTION

H - desk height

STANDARD FINISHES

For a complete list of standard wood finishes please see page 256.

GABLE SUPPORT

A half gable support is required on any open spans greater than 60" that don't have a modesty panel.

MILLENNIUM | CORNER UNITS

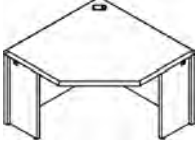
Description	Model	Cherry		W	D	H	KW	Shipping Weight	Cubic Feet
		Walnut	Maple						
	68CU363620	3476		36.25	36.25	28.5	22.5	132	26
	68CU363624	3476		36.25	36.25	28.5	17	132	26
	68CU424224*	3818		42.25	42.25	28.5	25.5	164	35
	68CU4242L24R30	3876		42.25	42.25	28.5	21.5	164	35
	68CU4242L30R24	3876		42.25	42.25	28.5	21.5	164	35

ORDERING NOTES: Includes a standard grommet in the "C" position. Laminate worksurfaces are available at a 10% upcharge. When ordering a keyboard for use with a corner unit, please specify a 68KBAC2110 with an extended mechanism.

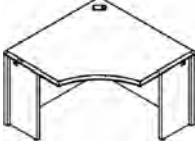
Description	Model	Cherry		W	D	H	KW	Shipping Weight	Cubic Feet
		Walnut	Maple						
	68CUC363620	3642		36.25	36.25	28.5	22.5	132	26
	68CUC363624	3642		36.25	36.25	28.5	17	132	26
	68CUC424224*	4011		42.25	42.25	28.5	25.5	164	35
	68CUC4242L24R30	4114		42.25	42.25	28.5	21.5	132	35
	68CUC4242L30R24	4114		42.25	42.25	28.5	21.5	132	35

ORDERING NOTES: Includes a standard grommet in the "C" position. Laminate worksurfaces are available at a 10% upcharge. When ordering a keyboard for use with a corner unit, please specify a 68KBAC2110 with an extended mechanism.

ORDERING PROCEDURE

To order, please specify the following:

- 1) Krug product model number
- 2) Wood species and finish, see page 247
- 3) Wood edge detail- I,H, L or P, see page 250
- 4) Pull style, see page 250
- 5) Grommet location if applicable

*Indicates model illustrated by line drawing.

STANDARD FINISHES

For a complete list of standard wood finishes please see page 247.

GROMMETS

One wiring grommet in standard position is optional at no charge. Additional wiring grommets are available at an **upcharge of \$152.**

MILLENNIUM | CREDENZAS

Description	Model	Cherry		W	D	H	KW	Shipping	
		Walnut	Maple					Weight	Cubic Feet
Single Pedestal Credenza	68C60204LDRO	4841		60	20.25	28.5	42	154	24
	68C60204LFR0	4841		60	20.25	28.5	42	154	24
with Full Height Pedestals	68C60204LORD	4841		60	20.25	28.5	42	154	24
	68C60204LORF	4841		60	20.25	28.5	42	154	24
	68C60244LDRO	4877		60	24.25	28.5	42	178	29
	68C60244LFR0	4877		60	24.25	28.5	42	178	29
	68C60244LORD	4877		60	24.25	28.5	42	178	29
	68C60244LORF	4877		60	24.25	28.5	42	178	29
	68C66204LDRO	4911		65.75	20.25	28.5	48	165	27
	68C66204LFR0	4911		65.75	20.25	28.5	48	165	27
	68C66204LORD	4911		65.75	20.25	28.5	48	165	27
	68C66204LORF	4911		65.75	20.25	28.5	48	165	27
	68C66244LDRO	4923		65.75	24.25	28.5	48	192	32
	68C66244LFR0	4923		65.75	24.25	28.5	48	192	32
	68C66244LORD	4923		65.75	24.25	28.5	48	192	32
	68C66244LORF	4923		65.75	24.25	28.5	48	192	32
	68C71204LDRO*	4949		71	20.25	28.5	53.25	175	29
	68C71204LFR0	4949		71	20.25	28.5	53.25	175	29
	68C71204LORD	4949		71	20.25	28.5	53.25	175	29
	68C71204LORF	4949		71	20.25	28.5	53.25	175	29
	68C71244LDRO	4998		71	24.25	28.5	53.25	204	34
	68C71244LFR0	4998		71	24.25	28.5	53.25	204	34
	68C71244LORD	4998		71	24.25	28.5	53.25	204	34
	68C71244LORF	4998		71	24.25	28.5	53.25	204	34
	68C78204LDRO	5040		78	20.25	28.5	60.5	193	26
	68C78204LFR0	5040		78	20.25	28.5	60.5	193	26
	68C78204LORD	5040		78	20.25	28.5	60.5	193	26
	68C78204LORF	5040		78	20.25	28.5	60.5	193	26
	68C78244LDRO	5083		78	24.25	28.5	60.5	224	32
	68C78244LFR0	5083		78	24.25	28.5	60.5	224	32
	68C78244LORD	5083		78	24.25	28.5	60.5	224	32
	68C78244LORF	5083		78	24.25	28.5	60.5	224	32
	68C84204LDRO	5131		83.75	20.25	28.5	66.25	191	34
	68C84204LFR0	5131		83.75	20.25	28.5	66.25	191	34
	68C84204LORD	5131		83.75	20.25	28.5	66.25	191	34
	68C84204LORF	5131		83.75	20.25	28.5	66.25	191	34
	68C84244LDRO	5157		83.75	24.25	28.5	66.25	222	38
	68C84244LFR0	5157		83.75	24.25	28.5	66.25	222	38
	68C84244LORD	5157		83.75	24.25	28.5	66.25	222	38
	68C84244LORF	5157		83.75	24.25	28.5	66.25	222	38

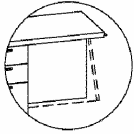
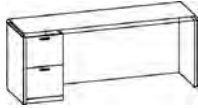

ORDERING NOTES:

Please see page 256 for wire management cut-out and/or hinged modesty panel option.

DIMENSION KEY

W - width
D - depth
H - height

CODE DESCRIPTION

0 - no pedestal
4 - full height pedestal
L - left handed pedestal position
R - right handed pedestal position
D - 2 file drawer
F - 2 box, 1 file drawer

STANDARD FINISHES

For a complete list of standard wood finishes please see page 247.

OPEN/DESK RETURNS

Open returns can be found in the shell section on page 298. Desk depth returns have a recessed modesty panel.

MILLENNIUM | CREDENZAS

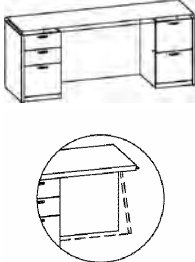
Description	Model	Cherry Walnut Maple	W	D	H	KW	Shipping Weight	Cubic Feet
Double Pedestal Credenza with Full Height Pedestals	68C60204LDRD	5229	60	20.25	28.5	27.25	186	24
	68C60204LDRF	5229	60	20.25	28.5	27.25	186	24
	68C60204LFRD	5229	60	20.25	28.5	27.25	186	24
	68C60204LFRF	5229	60	20.25	28.5	27.25	186	24
	68C60244LDRD	5243	60	24.25	28.5	27.25	210	29
	68C60244LDRF	5243	60	24.25	28.5	27.25	210	29
	68C60244LFRD	5243	60	24.25	28.5	27.25	210	29
	68C60244LFRF	5243	60	24.25	28.5	27.25	210	29
	68C66204LDRD	5284	65.75	20.25	28.5	33.25	197	27
	68C66204LDRF	5284	65.75	20.25	28.5	33.25	197	27
	68C66204LFRD	5284	65.75	20.25	28.5	33.25	197	27
	68C66204LFRF	5284	65.75	20.25	28.5	33.25	197	27
	68C66244LDRD	5289	65.75	24.25	28.5	33.25	210	32
	68C66244LDRF	5289	65.75	24.25	28.5	33.25	210	32
	68C66244LFRD	5289	65.75	24.25	28.5	33.25	210	32
	68C66244LFRF	5289	65.75	24.25	28.5	33.25	210	32
	68C71204LDRD	5316	71	20.25	28.5	38.5	207	29
	68C71204LDRF	5316	71	20.25	28.5	38.5	207	29
	68C71204LFRD*	5316	71	20.25	28.5	38.5	207	29
	68C71204LFRF	5316	71	20.25	28.5	38.5	207	29
	68C71244LDRD	5373	71	24.25	28.5	38.5	236	34
	68C71244LDRF	5373	71	24.25	28.5	38.5	236	34
	68C71244LFRD	5373	71	24.25	28.5	38.5	236	34
	68C71244LFRF	5373	71	24.25	28.5	38.5	236	34
	68C78204LDRD	5391	78	20.25	28.5	42.5	205	26
	68C78204LDRF	5391	78	20.25	28.5	42.5	205	26
	68C78204LFRD	5391	78	20.25	28.5	42.5	205	26
	68C78204LFRF	5391	78	20.25	28.5	42.5	205	26
	68C78244LDRD	5471	78	24.25	28.5	42.5	253	32
	68C78244LDRF	5471	78	24.25	28.5	42.5	253	32
68C78244LFRD	5471	78	24.25	28.5	42.5	253	32	
68C78244LFRF	5471	78	24.25	28.5	42.5	253	32	
68C84204LDRD	5429	83.75	20.25	28.5	51.75	223	34	
68C84204LDRF	5429	83.75	20.25	28.5	51.75	223	34	
68C84204LFRD	5429	83.75	20.25	28.5	51.75	223	34	
68C84204LFRF	5429	83.75	20.25	28.5	51.75	223	34	
68C84244LFRD	5562	83.75	24.25	28.5	51.75	254	38	
68C84244LDRF	5562	83.75	24.25	28.5	51.75	254	38	
68C84244LDRD	5562	83.75	24.25	28.5	51.75	254	38	
68C84244LFRF	5562	83.75	24.25	28.5	51.75	254	38	

ORDERING NOTES:

The pencil drawer can not be used in 20" deep knee hole credenzas and/or shells. Please see page 256 for wire management cut-out option and for hinged modesty panel option.

ORDERING PROCEDURE

To order, please specify the following:

- 1) Krug product model number
- 2) Wood species and finish, see page 247
- 3) Wood edge detail- I,H, L or P, see page 250
- 4) Pull style, see page 250
- 5) Grommet location if applicable

*Indicates model illustrated by line drawing.

CODE DESCRIPTION

- 4 - full height pedestal
- L - left handed pedestal position
- R - right handed pedestal position
- D - 2 file drawer
- F - 2 box, 1 file drawer

STANDARD FINISHES

For a complete list of standard wood finishes please see page 247.

GROMMETS

One wiring grommet in standard position is optional at no charge. Additional wiring grommets are available at an **upcharge of \$152.**

MILLENNIUM | CREDENZAS

Description	Model	Cherry	W	D	H	KW	Shipping Weight	Cubic Feet
		Walnut Maple						
Bow Top, Double Pedestal Credenza with Full Height Pedestals	68CX71204LDRD	5688	71	20.5	28.5	38.5	217	29
	68CX71204LDRF	5688	71	20.5	28.5	38.5	217	29
	68CX71204LFRD	5688	71	20.5	28.5	38.5	217	29
	68CX71204LFRF	5688	71	20.5	28.5	38.5	217	29
	68CX71244LDRD	5812	71	24.5	28.5	38.5	246	24
	68CX71244LDRF	5812	71	24.5	28.5	38.5	246	24
	68CX71244LFRD	5812	71	24.5	28.5	38.5	246	24
	68CX71244LFRF	5812	71	24.5	28.5	38.5	246	24
	68CX78204LDRD	5840	78	20.5	28.5	42.5	224	26
	68CX78204LDRF	5840	78	20.5	28.5	42.5	224	26
	68CX78204LFRD*	5840	78	20.5	28.5	42.5	224	26
	68CX78204LFRF	5840	78	20.5	28.5	42.5	224	26
	68CX78244LDRD	5849	78	24.5	28.5	42.5	257	38
	68CX78244LDRF	5849	78	24.5	28.5	42.5	257	38
	68CX78244LFRD	5849	78	24.5	28.5	42.5	257	38
	68CX78244LFRF	5849	78	24.5	28.5	42.5	257	38
	68CX84204LDRD	5940	83.75	20.5	28.5	51.75	233	34
	68CX84204LDRF	5940	83.75	20.5	28.5	51.75	233	34
	68CX84204LFRD	5940	83.75	20.5	28.5	51.75	233	34
	68CX84204LFRF	5940	83.75	20.5	28.5	51.75	233	34
	68CX84244LDRD	5947	83.75	24.5	28.5	51.75	264	38
	68CX84244LDRF	5947	83.75	24.5	28.5	51.75	264	38
	68CX84244LFRD	5947	83.75	24.5	28.5	51.75	264	38
	68CX84244LFRF	5947	83.75	24.5	28.5	51.75	264	38

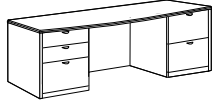

ORDERING NOTES:

The pencil drawer can not be used in 20" deep knee hole credenzas and/or shells. Please see page 256 for wire management cut-out option and for hinged modesty panel option.

Credenza, Ganged Pedestals	68C66204LDDR0	5771	65.75	20.25	28.5	33.25	197	27
	68C66204LDFR0	5771	65.75	20.25	28.5	33.25	197	27
	68C66204LFDR0	5771	65.75	20.25	28.5	33.25	197	27
	68C66204LFFR0**	5771	65.75	20.25	28.5	33.25	197	27
	68C66204LORDD	5771	65.75	20.25	28.5	33.25	197	27
	68C66204LORDF	5771	65.75	20.25	28.5	33.25	197	27
	68C66204LORFD*	5771	65.75	20.25	28.5	33.25	197	27
	68C66204LORFF	5771	65.75	20.25	28.5	33.25	197	27
	68C66244LDDR0	5807	65.75	24.5	28.5	33.25	224	32
	68C66244LDFR0	5807	65.75	24.5	28.5	33.25	224	32
	68C66244LFDR0	5807	65.75	24.5	28.5	33.25	224	32
	68C66244LFFR0	5807	65.75	24.5	28.5	33.25	224	32
	68C66244LORDD	5807	65.75	24.5	28.5	33.25	224	32
	68C66244LORDF	5807	65.75	24.5	28.5	33.25	224	32
	68C66244LORFD	5807	65.75	24.5	28.5	33.25	224	32
	68C66244LORFF	5807	65.75	24.5	28.5	33.25	224	32
	68C71204LDDR0	5835	71	20.25	28.5	38.5	207	29
	68C71204LDFR0	5835	71	20.25	28.5	38.5	207	29
	68C71204LFDR0	5835	71	20.25	28.5	38.5	207	29
	68C71204LFFR0	5835	71	20.25	28.5	38.5	207	29
	68C71204LORDD	5835	71	20.25	28.5	38.5	207	29

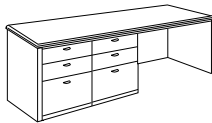
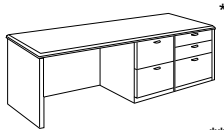

ORDERING NOTES:

"C" position grommets are not available on 60-71" Ganged Pedestal Credenzas. Ganged pedestals are specified in the product code beginning with the pedestal closest to the end panel.

DIMENSION KEY

W - width
D - depth
H - height

CODE DESCRIPTION

0 - no pedestal
4 - full height pedestal
L - left handed pedestal position
R - right handed pedestal position
D - 2 file drawer
F - 2 box, 1 file drawer

STANDARD FINISHES

For a complete list of standard wood finishes please see page 247.

GABLE SUPPORT

A half gable support is required on any open spans greater than 60" that don't have a modesty panel.

MILLENNIUM | CREDENZAS

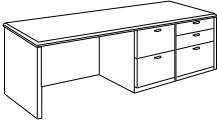
Description	Model	Cherry Walnut Maple	W	D	H	KW	Shipping Weight	Cubic Feet
Credenza, Ganged Pedestals	68C71204LORDF	5835	71	20.25	28.5	38.5	207	29
	68C71204LORFD*	5835	71	24.5	28.5	38.5	207	29
	68C71204LORFF	5835	71	24.5	28.5	38.5	207	29
	68C71244LDDRO	5869	71	24.5	28.5	38.5	236	34
	68C71244LDFRO	5869	71	24.5	28.5	38.5	236	34
	68C71244LFDR0	5869	71	24.5	28.5	38.5	236	34
	68C71244LFFR0	5869	71	24.5	28.5	38.5	236	34
	68C71244LORDD	5869	71	24.5	28.5	38.5	236	34
	68C71244LORDF	5869	71	24.5	28.5	38.5	236	34
	68C71244LORFD	5869	71	20.25	28.5	38.5	236	34
	68C71244LORFF	5869	71	20.25	28.5	38.5	236	34
	68C78204LDDRO	5873	78	20.5	28.5	42.5	217	26
	68C78204LDFRO	5873	78	20.5	28.5	42.5	217	26
	68C78204LFDR0	5873	78	20.5	28.5	42.5	217	26
	68C78204LFFR0	5873	78	20.5	28.5	42.5	217	26
	68C78204LORDD	5873	78	20.5	28.5	42.5	217	26
	68C78204LORDF	5873	78	20.5	28.5	42.5	217	26
	68C78204LORFD	5873	78	20.5	28.5	42.5	217	26
	68C78204LORFF	5873	78	20.5	28.5	42.5	217	26
	68C78244LDDRO	5881	78	24.5	28.5	42.5	253	32
	68C78244LDFRO	5881	78	24.5	28.5	42.5	253	32
	68C78244LFDR0	5881	78	24.5	28.5	42.5	253	32
	68C78244LFFR0	5881	78	24.5	28.5	42.5	253	32
	68C78244LORDD	5881	78	24.5	28.5	42.5	253	32
	68C78244LORDF	5881	78	24.5	28.5	42.5	253	32
	68C78244LORFD	5881	78	24.5	28.5	42.5	253	32
	68C78244LORFF	5881	78	24.5	28.5	42.5	253	32
	68C84204LDDRO	5947	83.75	20.5	28.5	51.5	223	34
	68C84204LDFRO	5947	83.75	20.5	28.5	51.5	223	34
	68C84204LFDR0	5947	83.75	20.5	28.5	51.5	223	34
	68C84204LFFR0	5947	83.75	20.5	28.5	51.5	223	34
	68C84204LORDD	5947	83.75	20.5	28.5	51.5	223	34
	68C84204LORDF	5947	83.75	20.5	28.5	51.5	223	34
	68C84204LORFD	5947	83.75	20.5	28.5	51.5	223	34
	68C84204LORFF	5947	83.75	20.5	28.5	51.5	223	34
	68C84244LDDRO	5978	83.75	24.5	28.5	51.5	223	34
68C84244LDFRO	5978	83.75	24.5	28.5	51.5	223	34	
68C84244LFDR0	5978	83.75	24.5	28.5	51.5	223	34	
68C84244LFFR0	5978	83.75	24.5	28.5	51.5	223	34	
68C84244LORDD	5978	83.75	24.5	28.5	51.5	223	34	
68C84244LORDF	5978	83.75	24.5	28.5	51.5	223	34	
68C84244LORFD	5978	83.75	24.5	28.5	51.5	223	34	
68C84244LORFF	5978	83.75	24.5	28.5	51.5	223	34	

ORDERING NOTES:

"C" position grommets are not available on 60-71" Ganged Pedestal Credenzas. Ganged pedestals are specified in the product code beginning with the pedestal closest to the end panel.

ORDERING PROCEDURE

To order, please specify the following:

- 1) Krug product model number
- 2) Wood species and finish, see page 247
- 3) Wood edge detail- I,H, L or P, see page 250
- 4) Pull style, see page 250
- 5) Grommet location if applicable

*Indicates model illustrated by line drawing.

CODE DESCRIPTION

- 0 - no pedestal
- 4 - full height pedestal
- L - left handed pedestal position
- R - right handed pedestal position
- D - 2 file drawer
- F - 2 box, 1 file drawer

STANDARD FINISHES

For a complete list of standard wood finishes please see page 247.

GROMMETS

One wiring grommet in standard position is optional at no charge. Additional wiring grommets are available at an **upcharge of \$152.**

MILLENNIUM | CREDENZAS

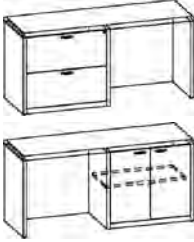
Description	Model	Cherry		W	D	H	KW	Shipping Weight	Cubic Feet
		Walnut	Maple						
Credenza, Lateral File or Bookcase Pedestals 	68C6020LBR0	4392		60	20.5	28.5	28	174	24
	68C6020LFR0	4866		60	20.5	28.5	28	205	24
	68C6020LORB	4392		60	20.5	28.5	28	172	24
	68C6020LORF	4866		60	20.5	28.5	28	205	24
	68C6024LBR0	4416		60	24.5	28.5	28	198	29
	68C6024LFR0	4891		60	24.5	28.5	28	229	29
	68C6024LORB	4416		60	24.5	28.5	28	198	29
	68C6024LORF	4891		60	24.5	28.5	28	229	29
	68C6620LBR0	4507		65.75	20.5	28.5	33.75	185	28
	68C6620LFR0	4990		65.75	20.5	28.5	33.75	216	28
	68C6620LORB	4507		65.75	20.5	28.5	33.75	185	28
	68C6620LORF	4990		65.75	20.5	28.5	33.75	216	28
	68C6624LBR0	4596		65.75	24.5	28.5	33.75	212	32
	68C6624LFR0	5093		65.75	24.5	28.5	33.75	243	32
	68C6624LORB	4596		65.75	24.5	28.5	33.75	212	32
	68C6624LORF	5093		65.75	24.5	28.5	33.75	243	32
	68C7120LBR0	4672		71	20.5	28.5	33.5	195	31
	68C7120LFR0	5218		71	20.5	28.5	33.5	226	31
	68C7120LORB	4672		71	20.5	28.5	33.5	195	31
	68C7120LORF	5218		71	20.5	28.5	33.5	226	31
	68C7124LBR0	4795		71	24.5	28.5	33.5	224	34
	68C7124LFR0	5302		71	24.5	28.5	33.5	257	34
	68C7124LORB	4795		71	24.5	28.5	33.5	224	34
	68C7124LORF	5302		71	24.5	28.5	33.5	257	34
	68C7820LBR0	4784		78	20.5	28.5	41.5	196	26
	68C7820LFR0	5314		78	20.5	28.5	41.5	227	26
	68C7820LORB	4784		78	20.5	28.5	41.5	196	26
	68C7820LORF	5314		78	20.5	28.5	41.5	227	26
	68C7824LBR0	4853		78	24.5	28.5	41.5	221	32
	68C7824LFR0	5427		78	24.5	28.5	41.5	252	32
	68C7824LORB	4853		78	24.5	28.5	41.5	221	32
	68C7824LORF	5427		78	24.5	28.5	41.5	252	32
	68C8420LBR0	4933		83.75	20.5	28.5	39.5	211	34
	68C8420LFR0	5452		83.75	20.5	28.5	39.5	242	34
	68C8420LORB	4933		83.75	20.5	28.5	39.5	211	34
	68C8420LORF	5452		83.75	20.5	28.5	39.5	242	34
	68C8424LBR0	5035		83.75	24.5	28.5	39.5	242	40
	68C8424LFR0	5562		83.75	24.5	28.5	39.5	273	40
	68C8424LORB	5035		83.75	24.5	28.5	39.5	242	40
	68C8424LORF	5562		83.75	24.5	28.5	39.5	273	40

ORDERING NOTES:

"C" position grommets are not available on 60-71" Lateral File/ Bookcase Pedestal Credenzas.

DIMENSION KEY

W - width
D - depth
H - height

CODE DESCRIPTION

0 - no pedestal
H - desk height
4 - full height pedestal
L - left handed pedestal position
R - right handed pedestal position
D - 2 file drawer
BC - bookcase
F - 2 box, 1 file drawer: when preceded in the model number by -4.
F - 2 lateral file drawers: when it directly follows the size classified.

STANDARD FINISHES

For a complete list of standard wood finishes please see page 247.

GABLE SUPPORT

A half gable support is required on any open spans greater than 60" that don't have a modesty panel.

MILLENNIUM | CREDENZAS

Description	Model	Cherry		W	D	H	Shipping Weight	Cubic Feet
		Walnut	Maple					
	68C66244DBCD	6144	6144	65.75	24.5	28.5	295	31
	68C66244DBCF	6144	6144	65.75	24.5	28.5	295	31
	68C66244FBCD	6144	6144	65.75	24.5	28.5	295	31
	68C66244FBCF*	6144	6144	65.75	24.5	28.5	295	31
	68C71204DBCD	6347	6347	71	20.5	28.5	295	30
	68C71204DBCF	6347	6347	71	20.5	28.5	295	30
	68C71204FBCD	6347	6347	71	20.5	28.5	295	30
	68C71204FBCF	6347	6347	71	20.5	28.5	295	30
	68C71244DBCD	6508	6508	71	24.5	28.5	305	34
	68C71244DBCF	6508	6508	71	24.5	28.5	305	34
	68C71244FBCD	6508	6508	71	24.5	28.5	305	34
	68C71244FBCF	6508	6508	71	24.5	28.5	305	34
	68C78204DBCD	6516	6516	78	20.5	28.5	305	30
	68C78204DBCF	6516	6516	78	20.5	28.5	305	30
	68C78204FBCD	6516	6516	78	20.5	28.5	305	30
	68C78204FBCF	6516	6516	78	20.5	28.5	305	30
	68C78244DBCD	6730	6730	78	24.5	28.5	315	34
	68C78244DBCF	6730	6730	78	24.5	28.5	315	34
	68C78244FBCD	6730	6730	78	24.5	28.5	315	34
	68C78244FBCF	6730	6730	78	24.5	28.5	315	34
	68C84204DBCD	6690	6690	83.75	20.5	28.5	315	36
	68C84204DBCF	6690	6690	83.75	20.5	28.5	315	36
	68C84204FBCD	6690	6690	83.75	20.5	28.5	315	36
	68C84204FBCF	6690	6690	83.75	20.5	28.5	315	36
	68C84244DBCD	6882	6882	83.75	24.5	28.5	325	40
	68C84244DBCF	6882	6882	83.75	24.5	28.5	325	40
68C84244FBCD	6882	6882	83.75	24.5	28.5	325	40	
68C84244FBCF	6882	6882	83.75	24.5	28.5	325	40	

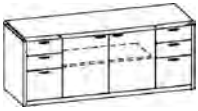
	68CX66204DBCD	6543	6543	65.75	20.5	28.5	264	27
	68CX66204FBCF*	6543	6543	65.75	20.5	28.5	264	27
	68CX66204FBCD	6543	6543	65.75	20.5	28.5	264	27
	68CX66204DBCF	6543	6543	65.75	20.5	28.5	264	27
	68CX66244DBCD	6663	6663	65.75	24.5	28.5	291	30
	68CX66244FBCF	6663	6663	65.75	24.5	28.5	291	30
	68CX66244FBCD	6663	6663	65.75	24.5	28.5	291	30
	68CX66244DBCF	6663	6663	65.75	24.5	28.5	291	30
	68CX71204DBCD	6875	6875	71	20.5	28.5	271	32
	68CX71204FBCF	6875	6875	71	20.5	28.5	271	32
	68CX71204DBCF	6875	6875	71	20.5	28.5	271	32
	68CX71204DBCF	6875	6875	71	20.5	28.5	271	32
	68CX71244DBCD	7042	7042	71	24.5	28.5	303	34
	68CX71244FBCF	7042	7042	71	24.5	28.5	303	34
	68CX71244FBCD	7042	7042	71	24.5	28.5	303	34
	68CX71244DBCF	7042	7042	71	24.5	28.5	303	34
	68CX78204DBCD	7148	7148	78	20.5	28.5	278	37
	68CX78204FBCF	7148	7148	78	20.5	28.5	278	37
	68CX78204FBCD	7148	7148	78	20.5	28.5	278	37
	68CX78204DBCF	7148	7148	78	20.5	28.5	278	37
	68CX78244DBCD	7478	7478	78	24.5	28.5	315	38
	68CX78244FBCF	7478	7478	78	24.5	28.5	315	38
	68CX78244FBCD	7478	7478	78	24.5	28.5	315	38
	68CX78244DBCF	7478	7478	78	24.5	28.5	315	38

ORDERING PROCEDURE

To order, please specify the following:

- 1) Krug product model number
- 2) Wood species and finish, see page 247
- 3) Wood edge detail- I,H, L or P, see page 250
- 4) Pull style, see page 250
- 5) Grommet location if applicable

*Indicates model illustrated by line drawing.

CODE DESCRIPTION

0 - no pedestal
 4 - full height pedestal
 L - left handed pedestal position
 R - right handed pedestal position
 D - 2 file drawer
 BC - bookcase
 F - 2 box, 1 file drawer

STANDARD FINISHES

For a complete list of standard wood finishes please see page 247.

GROMMETS

One wiring grommet in standard position is optional at no charge. Additional wiring grommets are available at an **upcharge of \$152.**

MILLENNIUM | CREDENZAS

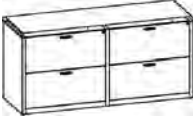
Description	Model	Cherry Walnut Maple	W	D	H	KW	Shipping Weight	Cubic Feet
	68C6020LBRB	5272	60	20.5	28.5		226	24
	68C6020LBRF	6167	60	20.5	28.5		257	24
	68C6020LFRB	6185	60	20.5	28.5		257	24
	68C6020LFRF	6796	60	20.5	28.5		288	24
	68C6024LBRB	5273	60	24.5	28.5		250	29
	68C6024LBRF	6229	60	24.5	28.5		281	29
	68C6024LFRB	6229	60	24.5	28.5		281	29
	68C6024LFRF	6822	60	24.5	28.5		312	29
	68C7120LBRB	5616	71	20.5	28.5		247	31
	68C7120LBRF	6599	71	20.5	28.5		278	31
	68C7120LFRB	6599	71	20.5	28.5		278	31
	68C7120LFRF	7233	71	20.5	28.5		309	31
	68C7124LBRB	5696	71	24.5	28.5		271	34
	68C7124LBRF	6720	71	24.5	28.5		307	34
	68C7124LFRB	6720	71	24.5	28.5		307	34
	68C7124LFRF	7324	71	24.5	28.5		338	34
	68C8420LBRB	5810	83.75	20.5	28.5		263	34
	68C8420LBRF	6884	83.75	20.5	28.5		294	34
	68C8420LFRB	6884	83.75	20.5	28.5		294	34
	68C8420LFRF	7452	83.75	20.5	28.5		325	34
68C8424LBRB	5889	83.75	24.5	28.5		294	40	
68C8424LBRF	7036	83.75	24.5	28.5		325	40	
68C8424LFRB	7036	83.75	24.5	28.5		325	40	
68C8424LFRF	7536	83.75	24.5	28.5		356	40	

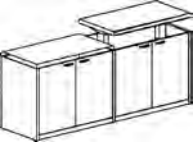
	68C6024LBRHAES*	6875	59.75	24	29.5		176	28
	68C6024LHAESRB	6875	59.75	24	29.5		192	28
	68C6024LFRHAES	7152	59.75	24	29.5		192	28
	68C6024LHAESRF	7152	59.75	24	29.5		248	28
	68C7224LBRHAES	7566	71.75	24	29.5		192	33
	68C7224LHAESRB	7566	71.75	24	29.5		210	33
	68C7224LFRHAES	7725	71.75	24	29.5		210	33
	68C7224LHAESRF	7725	71.75	24	29.5		230	33

	68CX6020LBRB	6060	60	20.5	28.5		241	24
	68CX6020LBRF	7135	60	20.5	28.5		272	24
	68CX6020LFRB	7135	60	20.5	28.5		272	24
	68CX6020LFRF	7824	60	20.5	28.5		303	24
	68CX6024LBRB	6126	60	24.5	28.5		265	29
	68CX6024LBRF	7282	60	24.5	28.5		296	29
	68CX6024LFRB	7282	60	24.5	28.5		296	29
	68CX6024LFRF	7918	60	24.5	28.5		327	29
	68CX7120LBRB	6270	71	20.5	28.5		262	31
	68CX7120LBRF	7418	71	20.5	28.5		293	31
	68CX7120LFRB	7418	71	20.5	28.5		293	31
	68CX7120LFRF	8074	71	20.5	28.5		324	31
	68CX7124LBRB	6391	71	24.5	28.5		291	34
	68CX7124LBRF	7577	71	24.5	28.5		322	34
	68CX7124LFRB	7577	71	24.5	28.5		322	34
	68CX7124LFRF	8123	71	24.5	28.5		353	34

ORDERING NOTES: Height range of electric lift is 29.5" to 46.5".

DIMENSION KEY

W - width
D - depth
H - height

CODE DESCRIPTION

4 - full height pedestal
L - left handed pedestal position
R - right handed pedestal position
B - bookcase
F - 2 lateral file drawers

STANDARD FINISHES

For a complete list of standard wood finishes please see page 247.

MILLENNIUM | CREDENZAS

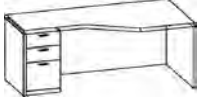
Description	Model	Cherry			Shipping Weight	Cubic Feet	
		Walnut	Maple				
		W	D	H			
	68CC6624L4D	4209	65.75	36.25	28.5	230	45
	68CC6624L4F	4209	65.75	36.25	28.5	230	45
	68CC6624R4D	4209	65.75	36.25	28.5	230	45
	68CC6624R4F	4209	65.75	36.25	28.5	230	45
	68CC7124L4D	4308	71	36.25	28.5	240	50
	68CC7124L4F	4308	71	36.25	28.5	240	50
	68CC7124R4D	4308	71	36.25	28.5	240	50
	68CC7124R4F	4308	71	36.25	28.5	240	50
	68CC7824L4D	4365	78	36.25	28.5	250	55
	68CC7824L4F	4365	78	36.25	28.5	250	55
	68CC7824R4D	4365	78	36.25	28.5	250	55
	68CC7824R4F	4365	78	36.25	28.5	250	55
	68CC8424L4D	4418	82.75	36.25	28.5	260	59
	68CC8424L4F	4418	82.75	36.25	28.5	260	59
	68CC8424R4D	4418	82.75	36.25	28.5	260	59
	68CC8424R4F	4418	82.75	36.25	28.5	260	59

ORDERING NOTES:

For a curved corner version of this credenza, please add 5% list to above list prices and add an extra C to the model number prefix. Example: 68CCC7124L4D**

ORDERING PROCEDURE

To order, please specify the following:

- 1) Krug product model number
- 2) Wood species and finish, see page 247
- 3) Wood edge detail- I, H, L or P, see page 250
- 4) Pull style, see page 250
- 5) Grommet location if applicable

*Indicates model illustrated by line drawing.

CODE DESCRIPTION

- 4 - full height pedestal
- L - left handed pedestal position
- R - right handed pedestal position
- D - 2 file drawer
- F - 2 box, 1 file drawer

STANDARD FINISHES

For a complete list of standard wood finishes please see page 247.



GROMMETS

One wiring grommet in standard position is optional at no charge. Additional wiring grommets are available at an **upcharge of \$152.**

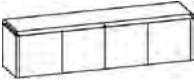
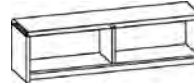
MILLENNIUM | OVERHEADS

Description	Model	Cherry Walnut Maple	W	D	H	Doors	Shipping Weight	Cubic Feet
Overhead with Flipper Doors 	68OF3619*	2072	36	18	19.25		140	9
	68OF4219	2205	42	18	19.25		151	10
	68OF4819	2283	48	18	19.25		162	12
	68OF6019**	2672	58.5	18	19.25		173	15
	68OF6619	2810	64.25	18	19.25		184	16
	68OF7119	2962	70.5	18	19.25		195	17
	Single Height Overhead with Hinged Doors 	68OH361517*	2073	36	15	16.75	2	127
68OH421517	2205	42	15	16.75	2	136	10	
68OH481517	2286	48	15	16.75	3	145	12	
68OH601517**	2663	58.5	15	16.75	4	154	15	
68OH661517	2810	64.25	15	16.75	4	163	16	
68OH711517	2916	70.5	15	16.75	4	172	17	
Overhead, Open 	68OO361517*	1704	36	15	16.75	2	117	9
	68OO421517	1798	42	15	16.75	2	126	10
	68OO481517	1867	48	15	16.75	3	135	12
	68OO601517**	2210	58.5	15	16.75	4	124	15
	68OO661517	2339	64.25	15	16.75	4	143	16
	68OO711517	2485	70.5	15	16.75	4	152	17

ORDERING NOTES: Please see page 257 for double height option and paper management option. All overheads include factory installed tasklights and mounting hardware. Locks are available on wood door overheads at **\$152 list per set** of (2) doors. Please specify at time of order.

Tackboards for Overheads with Flipper Doors		1	2	3	4	5	6	7	8	9	W	H	COM	WT
	68TBOF36	337	374	411	470	613	751	886	1031	1210	38	24	1.5	10
	68TBOF42	374	507	533	664	795	916	1053	1212	1429	44	24	1.5	12
	68TBOF48	416	516	541	677	815	937	1080	1240	1492	50	24	1.75	13
	68TBOF60	471	632	664	823	989	1172	1357	1543	1833	61	24	2	15
	68TBOF66	516	702	691	917	1102	1307	1487	1699	2024	67	24	2	16
	68TBOF71	568	871	908	1203	1480	1495	1717	1960	2285	74	24	2.25	18
Tackboards for Overheads with Hinged Doors		1	2	3	4	5	6	7	8	9	W	H	COM	WT
	68TBOH36	337	374	411	470	613	751	886	1031	1210	38	24	1.5	10
	68TBOH42	374	507	533	664	795	916	1053	1212	1429	44	24	1.5	12
	68TBOH48	416	516	541	677	815	937	1080	1240	1492	50	24	1.75	13
	68TBOH60	471	632	664	823	989	1172	1357	1543	1833	61	24	2	15
	68TBOH66	516	702	691	917	1102	1307	1487	1699	2024	67	24	2	16
	68TBOH71	568	871	908	1203	1480	1495	1717	1960	2285	74	24	2.25	18

ORDERING NOTES:

Please contact Customer Service for information on yardage required when ordering two or more tackboards. Please note either tackboard code 68TBOF or 68TBOH can be used for an open overheads.

DIMENSION KEY

W - width
D - depth
H - height

STANDARD FINISHES

For a complete list of standard wood finishes please see page 247.

MILLENNIUM | HUTCHES

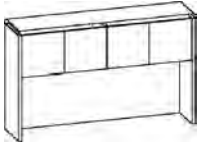
Description	Model	Cherry		W	D	H	TH	Shipping Weight	Cubic Feet
		Walnut	Maple						
	68HT3615	2577		35.25	15	39.75	23	147	15
	68HT4215	2838		41	15	39.75	23	156	18
	68HT4815	3345		47	15	39.75	23	165	20
	68HT5415	3578		53	15	39.75	23	174	22
	68HT6015*	3924		58.75	15	39.75	23	183	25
	68HT6615	4292		64.75	15	39.75	23	192	27
	68HT7115	5036		70	15	39.75	23	201	30
	68HT7815	5339		77	15	39.75	23	210	32
	68HT8415	5637		83	15	39.75	23	215	35
	68HT9018-2	7259		89	18	39.75	23	274	44
	68HT9618-2	8181		95	18	39.75	23	293	47
	68HT10218-2	8698		101	18	39.75	23	311	50
	68HT11018-2	9322		109	18	39.75	23	336	54

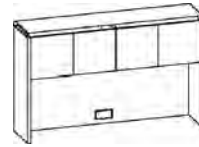
	68HT3615W	2790		35.25	15	39.75	23	147	15
	68HT4215W	3040		41	15	39.75	23	156	18
	68HT4815W	3554		47	15	39.75	23	165	20
	68HT5415W	3763		53	15	39.75	23	174	22
	68HT6015W*	4129		58.75	15	39.75	23	183	25
	68HT6615W	4490		64.75	15	39.75	23	192	27
	68HT7115W	5242		70	15	39.75	23	201	30
	68HT7815W	5519		77	15	39.75	23	210	32
	68HT8415W	5844		83	15	39.75	23	215	35
	68HT9018-2W	7511		89	18	39.75	23	274	44
	68HT9618-2W	8421		95	18	39.75	23	293	47
	68HT10218-2W	8889		101	18	39.75	23	311	50
	68HT11018-2W	9589		109	18	39.75	23	336	54

ORDERING NOTES:

Hinged door hutches include factory installed tasklights and tackboard. "TH" column above represents the clearance height for the tackboard. Hutches over 84" in length will be made in two pieces. Hutches are inset 3/4" on each side when sitting on the worksurface. Locks are available on wood door hutches at **\$152 list per (2) doors**. Please specify at time of order.

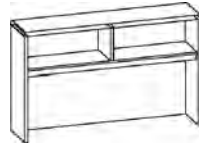
	68HTO3615	2437		35.25	15	39.75	23	137	15
	68HTO4215	2764		41	15	39.75	23	146	18
	68HTO4815	3087		47	15	39.75	23	155	20
	68HTO5415	3239		53	15	39.75	23	164	22
	68HTO6015	3479		58.75	15	39.75	23	173	25
	68HTO6615*	3847		64.75	15	39.75	23	192	28
	68HTO7115	4251		70	15	39.75	23	181	30
	68HTO7815	4435		77	15	39.75	23	190	32
	68HTO8415	4615		83	15	39.75	23	199	35
	68HTO9018-2	5980		89	18	39.75	23	254	44
	68HTO9618-2	6762		95	18	39.75	23	273	47
	68HTO10218-2	7386		101	18	39.75	23	291	50

ORDERING PROCEDURE

To order, please specify the following:

- 1) Krug product model number
- 2) Wood species and finish, see page 247
- 3) Wood edge detail- I, H, L or P, see page 250
- 4) Pull style, see page 250
- 5) Grommet location if applicable

*Indicates model illustrated by line drawing.

CODE DESCRIPTION

W - includes power/data/voice grommet in tackboard
 -2 - Hutches over 84" in length will be made in two pieces.

STANDARD FINISHES

For a complete list of standard wood finishes please see page 247.

INSIDE FINISHED BACKS

Optional inside finished backs are available up to a maximum of 84" hutches at the standard list price. This option does not include the tackboard.

MILLENNIUM | HUTCHES

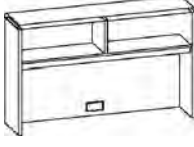
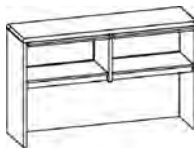
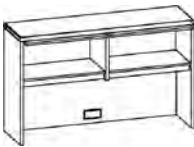
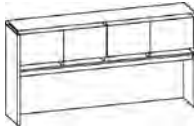
Description	Model	Cherry		W	D	H	TH	Shipping Weight	Cubic Feet
		Walnut	Maple						
 Hutch, Open & Power/ Data/Voice Grommet	68HTO3615W	2654		35.25	18	39.75	23	137	15
	68HTO4215W	2959		41	15	39.75	23	146	18
	68HTO4815W	3273		47	15	39.75	23	155	20
	68HTO5415W	3446		53	15	39.75	23	164	22
	68HTO6015W	3683		58.75	15	39.75	23	173	25
	68HTO6615W*	4047		64.75	15	39.75	23	192	28
	68HTO7115W	4478		70	15	39.75	23	181	30
	68HTO7815W	4622		77	15	39.75	23	190	32
	68HTO8415W	4799		83	15	39.75	23	199	35
	68HTO9018-2W	6246		89	18	39.75	23	254	44
	68HTO9618-2W	7022		95	18	39.75	23	254	47
	68HTO10218-2W	7655		101	18	39.75	23	291	50
	 Hutch, Flipper Doors	68HTF3618	2555		35.25	18	39.75	22	158
68HTF4218		2863		41	18	39.75	22	167	18
68HTF4818		3299		47	18	39.75	22	176	20
68HTF5418		3617		53	18	39.75	22	185	23
68HTF6018		4237		58.75	18	39.75	22	194	25
68HTF6618*		4555		64.75	18	39.75	22	203	27
68HTF7118		5272		70	18	39.75	22	212	30
68HTF7818		5644		77	18	39.75	22	221	33
68HTF8418		6090		83	18	39.75	22	230	35
68HTF9018		7754		89	18	39.75	22	239	44
 Hutch, Flipper Doors & Power/Data/Voice Grommet		68HTF3618W	2751		35.25	18	39.75	22	158
	68HTF4218W	3088		41	18	39.75	22	167	18
	68HTF4818W	3490		47	18	39.75	22	176	20
	68HTF5418W	3804		53	18	39.75	22	185	23
	68HTF6018W	4456		58.75	18	39.75	22	194	25
	68HTF6618W*	4777		64.75	18	39.75	22	203	27
	68HTF7118W	5471		70	18	39.75	22	212	30
	68HTF7818W	5814		77	18	39.75	22	221	33
	68HTF8418W	6258		83	18	39.75	22	230	35
	68HTF9018W	7949		89	18	39.75	22	239	44
 Hutch, Paper Management	68HTPM6015	5053		58.75	15	39.75	19.75	204	25
	68HTPM6615	5196		64.75	15	39.75	19.75	214	27
	68HTPM7115	5380		70	15	39.75	19.75	232	30
	68HTPM7815*	5771		77	15	39.75	19.75	241	33
	68HTPM8415	6184		83	15	39.75	19.75	250	35
	68HTPM9618-2	10222		95	18	39.75	19.75	300	35
	68HTPM10218-2	10872		101	18	39.75	19.75	320	35
	68HTPM11018-2	11647		109	18	39.75	19.75	340	35

ORDERING NOTES:

All hutches include factory installed tasklights and tackboard. "TH" column above represents the clearance height for the tackboard. Hutches over 84" in length will be made in two pieces. Hutches are inset 3/4" on each side when sitting on the worksurface.

DIMENSION KEY

W - width
D - depth
H - height

CODE DESCRIPTION

G - wood framed clear glass doors
OF- flipper door
OH- hinged door
OO- open, no doors
W - includes power/data/voice grommet in tackboard
PM- paper manager
PS- paper shelf

STANDARD FINISHES

For a complete list of standard wood finishes please see page 247.

TACKBOARD FABRIC OPTIONS

See page 297 for tackboard fabric options and grading information.

MILLENNIUM | HUTCHES

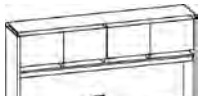
Description	Model	Cherry		W	D	H	TH	Shipping Weight	Cubic Feet
		Walnut	Maple						
 Hutch, Paper Management with Power/Data/Voice Grommet	68HTPM6015W	5219		58.75	15	39.75	19.75	204	25
	68HTPM6615W	5411		64.75	15	39.75	19.75	214	27
	68HTPM7115W	5563		70	15	39.75	19.75	232	30
	68HTPM7815W*	5982		77	15	39.75	19.75	241	33
	68HTPM8415W	6370		83	15	39.75	19.75	250	35
	68HTPM9618-2W	10410		95	18	39.75	19.75	300	35
	68HTPM10218-2W	11082		101	18	39.75	19.75	320	35
	68HTPM11018-2W	11857		109	18	39.75	19.75	340	35

ORDERING NOTES:

Hutches include factory installed tasklights and tackboard. "TH" column above represents the clearance height for the tackboard.

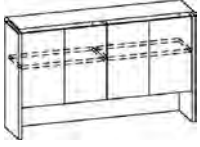
 Bookcase Hutch, Hinged Doors	68HTBC3615**	2763		35.25	15	39.75	11.5	167	15
	68HTBC4215	3126		41	15	39.75	11.5	176	18
	68HTBC4815	3491		47	15	39.75	11.5	185	22
	68HTBC5415	3662		53	15	39.75	11.5	194	25
	68HTBC6015	3859		58.75	15	39.75	11.5	203	25
	68HTBC6615*	4343		64.75	15	39.75	11.5	212	27
	68HTBC7115	4795		70	15	39.75	11.5	221	30
	68HTBC7815	5319		77	15	39.75	11.5	230	34
	68HTBC8415	5885		83	15	39.75	11.5	248	37

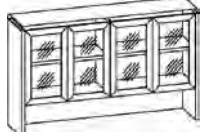
 Bookcase Hutch, Hinged Glass Doors	68HTBC3615G**	2899		35.25	15	39.75	11.5	117	15
	68HTBC4215G	3277		41	15	39.75	11.5	176	18
	68HTBC4815G	3668		47	15	39.75	11.5	185	22
	68HTBC5415G	3881		53	15	39.75	11.5	194	25
	68HTBC6015G	4093		58.75	15	39.75	11.5	203	25
	68HTBC6615G*	4567		64.75	15	39.75	11.5	212	27
	68HTBC7115G	5047		70	15	39.75	11.5	221	30
	68HTBC7815G	5604		77	15	39.75	11.5	230	34
	68HTBC8415G	6181		83	15	39.75	11.5	248	37

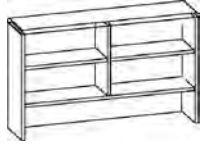
 Bookcase Hutch, Open	68HTBCO3615**	2304		35.25	15	39.75	11.5	157	15
	68HTBCO4215	2650		41	15	39.75	11.5	166	18
	68HTBCO4815	2989		47	15	39.75	11.5	175	20
	68HTBCO5415	3052		53	15	39.75	11.5	184	23
	68HTBCO6015	3117		58.75	15	39.75	11.5	183	25
	68HTBCO6615*	3568		64.75	15	39.75	11.5	192	27
	68HTBCO7115	4020		70	15	39.75	11.5	201	30
	68HTBCO7815	4477		77	15	39.75	11.5	210	33
	68HTBCO8415	4981		73	15	39.75	11.5	219	35

ORDERING NOTES:

Bookcase hutches include a finished back panel. Bookcase hutches cannot accept tackboards or tasklights. Hutches over 84" in length will be made in two pieces. Hutches are inset 3/4" on each side when sitting on the worksurface.

ORDERING PROCEDURE

To order, please specify the following:

- 1) Krug product model number
- 2) Wood species and finish, see page 247
- 3) Wood edge detail- I, H, L or P, see page 250
- 4) Pull style, see page 250
- 5) Grommet location if applicable

*Indicates model illustrated by line drawing.

CODE DESCRIPTION

G - wood framed clear glass doors
 W - includes power/data/voice grommet in tackboard
 -2 - Hutches over 84" in length will be made in two pieces.

STANDARD FINISHES

For a complete list of standard wood finishes please see page 247.

INSIDE FINISHED BACKS

Optional inside finished backs are available up to a maximum of 84" hutches at the standard list price. This option does not include the tackboard.

MILLENNIUM | HUTCHES

Description	Model	Cherry	W	D	H	TH	Shipping Weight	Cubic Feet
		Walnut Maple						
 6-Hi Hutch, Hinged Doors	68HT601555	4771	58.75	15	55.5	23	260	25
	68HT661555*	5300	64.75	15	55.5	23	273	27
	68HT711555	6067	70	15	55.5	23	281	30
	68HT781555	6531	77	15	55.5	23	290	32
	68HT841555	6989	83	15	55.5	23	299	35

 6-Hi Hutch, Hinged Doors & Power/Data/Voice Grommet	68HT601555W	4957	58.75	15	55.5	23	260	25
	68HT661555W*	5483	64.75	15	55.5	23	273	27
	68HT711555W	6295	70	15	55.5	23	281	30
	68HT781555W	6760	77	15	55.5	23	290	32
	68HT841555W	7193	83	15	55.5	23	299	35

 6-Hi Hutch, Hinged Glass Doors	68HT601555G	5056	58.75	15	55.5	23	176	25
	68HT661555G*	5617	64.75	15	55.5	23	188	27
	68HT711555G	6427	70	15	55.5	23	199	30
	68HT781555G	6915	77	15	55.5	23	212	32
	68HT841555G	7408	83	15	55.5	23	232	35

ORDERING NOTES:

Hinged door hutches include factory installed tasklights and tackboard. Hutches over 84" in length will be made in two pieces. Hutches are inset 3/4" on each side when sitting on the worksurface. Locks are available on wood door hutches at **\$152 list per (2) doors**. Please specify at time of order.

 Hutch with Pier	68HTPD8418	6240	83	18	39.75	23	290	41
	68HTPD9018-2*	8130	89	18	39.75	23	305	44
	68HTPD9618-2	8704	95	18	39.75	23	320	47
	68HTPD11018-2	9957	109	18	39.75	23	350	51

ORDERING NOTES:

Pier door hutches include factory installed tasklights and a tackboard. "TH" column above represents the clearance height for the tackboard. Hutches over 84" in length will be made in two pieces. Hutches are inset 3/4" on each side when sitting on the worksurface.

DIMENSION KEY

W - width
D - depth
H - height

CODE DESCRIPTION

G - wood framed clear glass doors
W - includes power/data/voice grommet in tackboard
-2 - Hutches over 84" in length will be made in two pieces

STANDARD FINISHES

For a complete list of standard wood finishes please see page 247.

TACKBOARD FABRIC OPTIONS

See page 297 for hutch fabric grade upcharges.

MILLENNIUM | HUTCHES

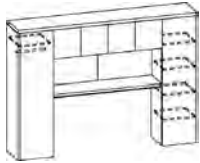
Description	Model	Cherry Walnut Maple			W	D	H	Shipping Weight	Cubic Feet
	68WU9618LWRB*	10626	95.75	24.25	68	665	60		
	68WU9618LBRW	10626	95.75	24.25	68	665	60		
	68WU10818LWRB	11334	108	24.25	68	705	70		
	68WU10818LBRW	11334	108	24.25	68	705	70		

Paper Manager	68PM18132001	1695	17	12.5	19.75	50	3
							

Paper Manager	68PM18122002	1373	17	12	19.75	50	3
							

Paper Manager	68PM18122003	1373	17	12	19.75	50	3
							

ORDERING PROCEDURE

To order, please specify the following:

- 1) Krug product model number
- 2) Wood species and finish, see page 247
- 3) Wood edge detail- I,H, L or P, see page 250
- 4) Pull style, see page 250
- 5) Grommet location if applicable

*Indicates model illustrated by line drawing.

CODE DESCRIPTION

W - includes power/data/voice grommet in tackboard
 L/RW - left or right wardrobe
 L/RB - left or right bookcase storage

STANDARD FINISHES

For a complete list of standard wood finishes please see page 247.

MILLENNIUM | HUTCH TACKBOARDS

Tackboard upcharges for hutches and wall units. Use this chart to find the upcharge for tackboard fabrics graded 2–9 and add it to the cost of the hutch or wall unit.

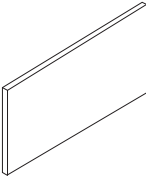
		FABRIC GRADES								
		2	3	4	5	6	7	8	9	com
	36" hutch tackboard	164	352	513	686	848	1011	1173	1428	1.5
	42" hutch tackboard	164	352	513	686	848	1011	1173	1428	1.5
	48" hutch tackboard	164	352	513	686	848	1011	1173	1428	1.75
	54" hutch tackboard	164	352	513	686	848	1011	1173	1428	1.75
	60" hutch tackboard	164	352	513	686	848	1011	1173	1428	2
	66" hutch tackboard	185	397	582	778	961	1146	1331	1654	2.25
	71" hutch tackboard	223	471	693	929	1151	1373	1593	1920	2
	78" hutch tackboard	265	555	821	1088	1356	1617	1880	2584	2
	84" hutch tackboard	309	642	954	1262	1569	1875	2184	2584	2.5
	90" hutch tackboard	348	722	1068	1415	1761	2107	2451	2846	2.75
	96" hutch tackboard	382	793	1177	1556	1935	2322	2694	3129	3
	102" hutch tackboard	420	871	1297	1714	2130	2549	2965	3399	3
	110" hutch tackboard	458	960	1177	1884	2343	2802	3260	3732	3.25
	84" pier door hutch tackboard	164	352	513	686	848	1011	1173	1428	2
90" pier door hutch tackboard	164	352	513	686	848	1011	1173	1428	2.25	
96" pier door hutch tackboard	164	352	513	686	837	1011	1173	1428	2.5	
110" pier door hutch tackboard	259	556	816	1083	1340	1603	1603	2191	2.75	
96" wall unit tackboard	164	352	513	686	848	1011	1011	1428	2.5	
108" wall unit tackboard	259	556	816	1083	1340	1603	1603	2191	2.5	

On single piece hutches, the yardage requirement for two tackboards is the same as for one tackboard. Please keep this in mind when ordering more than one tackboard. For example, if the number of tackboards required is 7 and the COM requirement for 1 tackboard is 1.5 yards, the calculation for COM yardage is as follows: 4.5 yards are required for 6 tackboards + 1.5 yards for the 7th tackboard for a total of 6 yards. In the case of an even number of tackboards, divide the number of tackboards required by 2 and multiply that number by COM requirement on the chart. The fabric must be at least 54" wide in order to qualify for this procedure. If the fabric is less than 54" wide, the COM yardage listed on the chart is the amount required for each tackboard.

Quantity of Tackboards Required (example: 60")	Number of Yards Required per Tackboard (example: 60")	Number of Yards Required in Total (example: 60")
one	2 yards	2
two	2 yards	2
three	2 yards	4
four	2 yards	4
fiv	2 yards	6
six	2 yards	6
seven	2 yards	8
eight	2 yards	8

DIMENSION KEY

W - width
D - depth
H - height

STANDARD FINISHES

For a complete list of standard wood finishes please see page 247.

MILLENNIUM | SHELLS

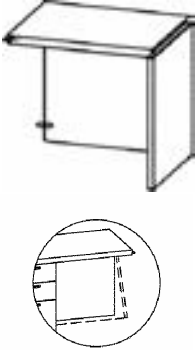
Description	Model	Cherry		W	D	H	KW	Shipping Weight	Cubic Feet
		Walnut	Maple						
Open Return, Desk Height	68RH2420L	1914		23.75	20.25	28.5	22	46	13
	68RH2420R	1914		23.75	20.25	28.5	22	46	13
	68RH2424L	1953		23.75	24.25	28.5	22	55	15
	68RH2424R	1953		23.75	24.25	28.5	22	55	15
	68RH3020L	2017		30	20.25	28.5	28.13	58	15
	68RH3020R	2017		30	20.25	28.5	28.13	58	15
	68RH3024L*	2053		30	24.25	28.5	28.13	70	17
	68RH3024R	2053		30	24.25	28.5	28.13	70	17
	68RH3620L	2122		36	20.25	28.5	34.13	69	17
	68RH3620R	2122		36	20.25	28.5	34.13	69	17
	68RH3624L	2157		36	24.25	28.5	34.13	83	20
	68RH3624R	2157		36	24.25	28.5	34.13	83	20
	68RH3630L	2184		36	30.25	28.5	34.13	104	22
	68RH3630R	2184		36	30.25	28.5	34.13	104	22
	68RH4220L	2219		42	20.25	28.5	40.13	81	20
	68RH4220R	2219		42	20.25	28.5	40.13	81	20
	68RH4224L	2274		42	24.25	28.5	40.13	97	22
	68RH4224R	2274		42	24.25	28.5	40.13	97	22
	68RH4230L	2302		42	30.25	28.5	40.13	122	24
	68RH4230R	2302		42	30.25	28.5	40.13	122	24
	68RH4820L	2326		48	20.25	28.5	46.13	93	22
	68RH4820R	2326		48	20.25	28.5	46.13	93	22
	68RH4824L	2383		48	24.25	28.5	46.13	112	24
	68RH4824R	2383		48	24.25	28.5	46.13	112	24
	68RH4830L	2390		48	30.25	28.5	46.13	140	26
	68RH4830R	2390		48	30.25	28.5	46.13	140	26
	68RH5420L	2420		54	20.25	28.5	52.13	105	24
	68RH5420R	2420		54	20.25	28.5	52.13	105	24
	68RH5424L	2457		54	24.25	28.5	52.13	126	26
	68RH5424R	2457		54	24.25	28.5	52.13	126	26
	68RH5430L	2459		54	30.25	28.5	52.13	158	30
	68RH5430R	2459		54	30.25	28.5	52.13	158	30
	68RH6020L	2473		60	20.25	28.5	58.38	115	26
	68RH6020R	2473		60	20.25	28.5	58.38	115	26
68RH6024L	2526		60	24.25	28.5	58.38	138	30	
68RH6024R	2526		60	24.25	28.5	58.38	138	30	
68RH6030L	2559		60	30.25	28.5	58.38	173	33	
68RH6030R	2559		60	30.25	28.5	58.38	173	33	
68RH6620L	2576		65.75	20.25	28.5	63.88	126	30	
68RH6620R	2576		65.75	20.25	28.5	63.88	126	30	
68RH6624L	2631		65.75	24.25	28.5	63.88	152	33	
68RH6624R	2631		65.75	24.25	28.5	63.88	152	33	
68RH6630L	2657		65.75	30.25	28.5	63.88	191	36	
68RH6630R	2657		65.75	30.25	28.5	63.88	191	36	
68RH7120L	2686		71	20.25	28.5	69.13	136	33	
68RH7120R	2686		71	20.25	28.5	69.13	136	33	
68RH7124L	2726		71	24.25	28.5	69.13	163	36	
68RH7124R	2726		71	24.25	28.5	69.13	163	36	
68RH7130L	2745		71	30.25	28.5	69.13	204	38	
68RH7130R	2745		71	30.25	28.5	69.13	204	38	

ORDERING NOTES:

Please see page 256 for wire management cut-out option. Please see page 256 for hinged modesty panel option. For Universal Return Shells replace RH with RHU. Grommets are not available on Universal Return shells.

ORDERING PROCEDURE

To order, please specify the following:

- 1) Krug product model number
- 2) Wood species and finish, see page 247
- 3) Wood edge detail- I, H, L or P, see page 250
- 4) Pull style, see page 250
- 5) Grommet location if applicable

*Indicates model illustrated by line drawing.

CODE DESCRIPTION

L - left hand runoff
R - right hand runoff

STANDARD FINISHES

For a complete list of standard wood finishes please see page 247.



MODESTY PANELS

Open returns are available with 9", 1/2" or 3/4" modesty panels at no upcharge. Please specify at time of order.

PEDESTALS

Pedestals for use with open shells can be found on page 316.

MILLENNIUM | SHELLS

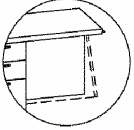
Description	Model	Cherry Walnut Maple	W	D	H	KW	Shipping Weight	Cubic Feet		
	Open Return, Desk Height continued	68RH8420L	2776	84	20.25	28.5	82.13	163	36	
		68RH8420R	2776	84	20.25	28.5	82.13	163	36	
		68RH8424L	2805	84	24.25	28.5	82.13	196	38	
		68RH8424R	2805	84	24.25	28.5	82.13	196	38	
		68RH8430L	2837	84	30.25	28.5	82.13	245	45	
		68RH8430R	2837	84	30.25	28.5	82.13	245	45	
		68RH9024L	2844	90	24.25	28.5	88.13	210	45	
		68RH9024R	2844	90	24.25	28.5	88.13	210	45	
		68RH9030L	2893	90	30.25	28.5	88.13	247	49	
		68RH9030R	2893	90	30.25	28.5	88.13	247	49	
		68RH9624L	2947	96	24.25	28.5	93.88	221	49	
		68RH9624R	2947	96	24.25	28.5	93.88	221	49	
		68RH9630L	2999	96	30.25	28.5	93.88	249	52	
		68RH9630R	2999	96	30.25	28.5	93.88	249	52	
		68RH10220L	3095	102	20.25	28.5	100.25	195	49	
		68RH10220R	3095	102	20.25	28.5	100.25	195	49	
	 	Open Shell, Accepts Shallow Pedestals	68S3020	2220	30	20.25	28.5	27	61	13
			68S3024	2252	30	24.25	28.5	27	73	15
		68S3620	2278	36.25	20.25	28.5	33.25	73	15	
		68S3624	2297	36.25	24.25	28.5	33.25	88	18	
		68S4220	2313	42	20.25	28.5	39	86	17	
		68S4224	2343	42	24.25	28.5	39	103	21	
		68S4820	2366	48	20.25	28.5	45	98	20	
		68S4824	2394	48	24.25	28.5	45	118	23	
		68S5020	2412	50	20.25	28.5	47	102	22	
		68S5024	2440	50	24.25	28.5	47	122	24	
		68S5420	2463	54	20.25	28.5	51	110	22	
		68S5424	2479	54	24.25	28.5	51	132	26	
		68S6020	2552	60	20.25	28.5	56.75	122	24	
		68S6024	2614	60	24.25	28.5	56.75	146	29	
		68S6320	2646	63.5	20.25	28.5	60.5	128	25	
		68S6324	2684	63.5	24.25	28.5	60.5	153	30	
		68S6620	2723	65.75	20.25	28.5	62.75	122	27	
		68S6624	2816	65.75	24.25	28.5	62.75	146	32	
		68S7120	2946	71	20.25	28.5	68	131	29	
		68S7124*	3042	71	24.25	28.5	68	157	34	
		68S7420	3113	74.25	20.25	28.5	71.25	134	30	
		68S7424	3231	74.25	24.25	28.5	71.25	161	35	
		68S7820	3308	78	20.25	28.5	75	141	32	
		68S7824	3382	78	24.25	28.5	75	189	37	
		68S8420	3405	82.75	20.25	28.5	81	159	34	
		68S8424	3456	82.75	24.25	28.5	81	190	40	
		68S9020	3607	90	20.25	28.5	87	170	36	
		68S9024	3647	90	24.25	28.5	87	204	43	
		68S9320	3683	93.5	20.25	28.5	90.75	176	39	
		68S9324	3715	93.5	24.25	28.5	90.75	212	45	
		68S9620	3752	95.75	20.25	28.5	93	181	43	
		68S9624	3814	95.75	24.25	28.5	93	217	49	
		68S10220	3890	102	20.25	28.5	99.25	184	51	
		68S10224	3949	102	24.25	28.5	99.25	221	55	
		68S11020	4009	109.75	20.25	28.5	106.75	199	54	
		68S11024	4119	109.75	24.25	28.5	106.75	239	60	

ORDERING NOTES:

The pencil drawer can not be used in the 20" deep knee hole credenzas and/or shells. Please see page 256 for wire management cut-out option. Please see page 256 for hinged modesty panel option.

DIMENSION KEY

W - width
D - depth
H - height

CODE DESCRIPTION

L - left hand runoff
R - right hand runoff

STANDARD FINISHES

For a complete list of standard wood finishes please see page 247.

PEDESTALS

Pedestals for use with open shells can be found on page 316.

HALF GABLE

Half gable at connecting end of open return is standard at sizes greater than 54" in length.

MILLENNIUM | SHELLS

Description	Model	Cherry		W	D	H	KW	Shipping Weight	Cubic Feet
		Walnut	Maple						
Half Gable	68HG2710*	443		10	27	27		11	1
	68HG2716	507		16	27	27		16	1



ORDERING NOTES:

This unit should be ordered to center-support open spans greater than 60". Use 68HG2710 with 20" & 24" deep cases and 68HG2716 with 30" deep cases.

Open Shell, Accepts Deep Pedestals	Model			W	D	H	KW	Shipping Weight	Cubic Feet
		Cherry	Walnut						
	68S3630	2412		36.25	30.25	28.5	33.5	110	21
	68S4230	2533		42	30.25	28.5	39.25	129	25
	68S4830	2629		48	30.25	28.5	44.75	147	29
	68S6030	2734		63.5	30.25	28.5	56.75	182	36
	68S6630	2838		65.75	30.25	28.5	62.75	200	39
	68S6636	2970		65.75	36.25	28.5	62.75	240	46
	68S7130	3127		71	30.25	28.5	68	215	42
	68S7136*	3277		71	36.25	28.5	68	255	50
	68S8430	3441		82.75	30.25	28.5	81	342	50
	68S8436	3669		84	36.25	28.5	81	285	59
	68S9030	3829		90	30.25	28.5	87	255	53
	68S9630	4061		93.5	30.25	28.5	92.75	272	56
	68S10230	4291		102	30.25	28.5	99.25	276	60

ORDERING NOTES:

The pencil drawer can not be used in the 20" deep knee hole credenzas and/or shells. Please see page 256 for wire management cut-out option. Please see page 256 for hinged modesty panel option.

Corner Credenza Shell	Model			W	D	H	KW	Shipping Weight	Cubic Feet
		Cherry	Walnut						
	68CC6624L	3222		65.75	36.25	28.5		180	45
	68CC6624R	3222		65.75	36.25	28.5		180	45
	68CC7124L	3263		71	36.25	28.5		190	50
	68CC7124R	3263		71	36.25	28.5		190	50
	68CC7824L	3304		78	36.25	28.5		200	55
	68CC7824R*	3304		78	36.25	28.5		200	55
	68CC8424L	3339		82.75	36.25	28.5		210	59
	68CC8424R	3339		82.75	36.25	28.5		210	59

Corner Return Shell	Model			W	D	H	KW	Shipping Weight	Cubic Feet
		Cherry	Walnut						
	68CR7124L*	3211		71	24.25	28.5		190	55
	68CR7124R	3211		71	24.25	28.5		190	55
	68CR8424L	3263		84	24.25	28.5		210	59
	68CR8424R	3263		84	24.25	28.5		210	59

ORDERING NOTES:

Corner Returns are designated left or right by the location of it's connection to a primary work surface. For a curved corner version of this products, please add 5% to above list price and add an extra C to the model number prefix i.e. 68CCC7124L

ORDERING PROCEDURE

To order, please specify the following:

- 1) Krug product model number
- 2) Wood species and finish, see page 247
- 3) Wood edge detail- I,H, L or P, see page 250
- 4) Pull style, see page 250
- 5) Grommet location if applicable

*Indicates model illustrated by line drawing.

CODE DESCRIPTION

- L - left hand runoff
- R - right hand runoff

STANDARD FINISHES

For a complete list of standard wood finishes please see page 247.

PEDESTALS

Pedestals for use with open shells can be found on pages 316.

MILLENNIUM | MOBILE TABLES

Description	Model	Cherry		W	D	H	Shipping Weight	Cubic Feet
		Walnut	Maple					
 Machine Stand, Desk Height with Casters	68THC3020	2385		30	20.25	28.5	61	12
	68THC3024	2406		30	24.25	28.5	73	15
	68THC3620	2417		36.25	20.25	28.5	73	15
	68THC3624	2440		36.25	24.25	28.5	88	18
	68THC4220	2461		42	20.25	28.5	86	18
	68THC4224	2453		42	24.25	28.5	103	21
	68THC4820	2480		48	20.25	28.5	98	21
	68THC4824*	2502		48	24.25	28.5	118	23

ORDERING NOTES:

Optional paper slot in "C" position at **\$172 list upcharge.**

 Printer Stand	68PT3024	2613		30.25	24.25	28.5	76	15
	68PT3624*	2697		36.25	24.25	28.5	103	18
	68PT3630	2780		36.25	30.25	28.5	103	22

ORDERING NOTES:

Optional paper slot in "C" position at **\$172 list upcharge.**

 Round Mobile Table	68MTH36D	1609		36.25	36.25	28.5	69	6
	68MTH42D*	1618		42.25	42.25	28.5	75	8

ORDERING NOTES:

Casters optional for **\$172 list upcharge.**

 Delta Mobile Table	68MDTH32	1704		31.25	32	28.5	50	5
	68MDTH36	1720		35	35.75	28.5	57	6
	68MDTH42*	1731		41	41.75	28.5	71	8

 Arc Square Mobile Table	68MATH3030	1594		30.25	30.25	28.5	60	4.5
	68MATH3636	1609		36.25	36.25	28.5	75	6
	68MATH4242*	1618		42.25	42.25	28.5	90	8

 Square Mobile Table	68MTH3030	1594		30.25	30.25	28.5	65	4.5
	68MTH3636	1609		36.25	36.25	28.5	80	6
	68MTH4242*	1618		42.25	42.25	28.5	97	8

DIMENSION KEY

W - width
D - depth
H - height

STANDARD FINISHES

For a complete list of standard wood finishes please see page 247.

HALF GABLE

Half gable at connecting end of open return is standard at sizes greater than 54" in length.

MILLENNIUM | ACCESSORIES

Description	Model	Price	W	D	H	Shipping Weight	Cubic Feet
 Tackboard Organizer Rail	68AOB36HT	100	31	-	2.5	-	-
	68AOB42HT	100	37	-	2.5	-	-
	68AOB48HT	100	43	-	2.5	-	-
	68AOB54HT	100	49	-	2.5	-	-
	68AOB60HT	100	55	-	2.5	-	-
	68AOB66HT	100	61	-	2.5	-	-
	68AOB71HT	100	66	-	2.5	-	-
	68AOB78HT	100	73	-	2.5	-	-
	68AOB84HT	100	79	-	2.5	-	-
	68AOB90HT	100	85	-	2.5	-	-
	68AOB96HT	100	91	-	2.5	-	-
	68AOB102HT	100	97	-	2.5	-	-
68AOB110HT	100	105	-	2.5	-	-	

Paper Tray	68APT	100	12	10.75	2	1.75	0.5
------------	-------	-----	----	-------	---	------	-----



Binder Bin	68ABB	140	10	4	10	3	0.5
------------	-------	-----	----	---	----	---	-----

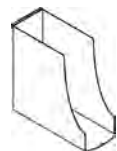

File Organizer	68AFO	114	6	9.75	2.5	1.75	0.5
----------------	-------	-----	---	------	-----	------	-----

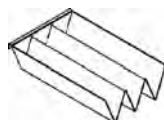

ORDERING NOTES:

This accessory can not be specified in combination with Paper Management Hutches due to space requirements.

Hanging File Bars	68AFB	114	1.75	7.5	0.75	0.5	0.25
-------------------	-------	-----	------	-----	------	-----	------



ORDERING PROCEDURE

To order, please specify the following:

- 1) Krug product model number
- 2) Wood species and finish, see page 247
- 3) Wood edge detail- I,H, L or P, see page 250
- 4) Pull style, see page 250
- 5) Grommet location if applicable

*Indicates model illustrated by line drawing.

CODE DESCRIPTION

APT - paper tray
 ABB - binder bin
 AFO - file organizer
 AFB - file bar
 The metal finish on perforated metal modesty panels, tapered brushed aluminum post legs, metal accent option on hutches, tack-board organizer rail, accessories and hinge caps on frameless glass doors match the Millennium satin nickel pull finish.

STANDARD FINISHES

For a complete list of standard wood finishes please see page 247.



ACCESSORIES

Accessories feature a brushed aluminum finish.

TACKBOARD ORGANIZER RAIL

Please specify clearly on purchase order which products are to receive Organizer Rail and Accessory options.

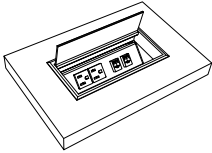
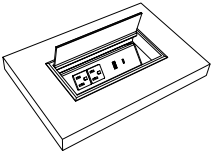
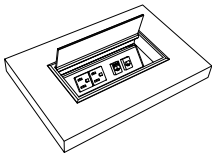
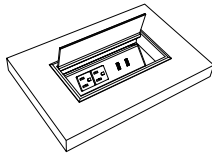
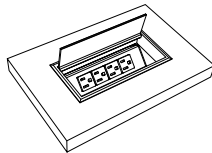
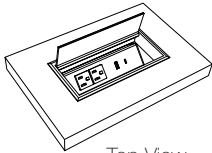
POWERPORTS

Description	Model	Price	W	D	H	Shipping Weight	Cubic Feet
PowerPort 1 - 2 RJ45s (Category 5/6)	PORT1	278	8	4	-	-	-
	<p>Port Includes: 2 accessible power outlets & 1 side utility outlet powered by a 10' plug-in cord; 2 RJ45 (category 5/6) each with hard wired 10' data cords; 2 velcro wire managers and metal PowerPort shroud. PortPort lid is Silver Metallic.</p> <p>NOTE: RJ45 jacks with hard wired data cords included here must be within 10' of building utilities source to be functional.</p>						
PowerPort 2 - USB-A & USB-C	PORT2	280	8	4	-	-	-
	<p>Port Includes: 2 accessible power outlets & 1 side utility outlet; 1 USB-A & 1 USB-C charging ports all powered by a 10' plug-in cord; 2 velcro wire managers and metal PowerPort shroud. PortPort lid is Silver Metallic.</p>						
PowerPort 3 - RJ11 & RJ45	PORT3	269	8	4	-	-	-
	<p>Port Includes: 2 accessible power outlets & 1 side utility outlet; 1 RJ11 & 1 RJ45 (Category 5/6); 2 Velcro wire managers & PowerPort Shroud; 1 x 10 Foot Data Cords (T568A) & 1 x 14 Foot RJ11 (Telecomm); powered by a 10' plug-in cord. PortPort lid is Silver Metallic.</p> <p>NOTE: RJ45 & RJ11 jacks with hard wired data cords included here must be within 10' of building utilities source to be functional.</p>						
PowerPort 4 - 2 USB-A	PORT4	286	8	4	-	-	-
	<p>Port Includes: 2 accessible power outlets & 1 side utility outlet; 2- USB-A charging ports all powered by a 10' plug-in cord; 2 velcro wire managers and metal PortPort shroud. PortPort lid is Silver Metallic.</p>						
PowerPort 5 - 4 Receptacles	PORT5	280	8	4	-	-	-
	<p>Port Includes: 4 accessible power outlets & 1 side utility outlet powered by a 10' plug-in cord; 2 velcro wire managers and metal power port shroud. PortPort lid is Silver Metallic.</p>						
PowerPort 6 - USB-A, USB-C & RJ45	PORT6	406	8	4	-	-	-
 	<p>Port Includes: 2 accessible power outlets & 1 side utility outlet 1 USB-A, 1 USB-C charging ports all powered by a 10' plug-in power cord. Includes 2 velcro wire managers and metal PortPort shroud with 2 data plate knock outs, 1 #M02 plate insert & 2 #S01W RJ45 female input, punch down terminal output snap in jacks. 2nd data plate knock out is blank for future use. PortPort lid is Silver Metallic.</p>						

GENERAL INFORMATION

Terms and Conditions

Net 30 days on approved credit. A late payment charge of 1% per month will be applied on overdue invoices. This charge will be pro-rated to the number of days past 30 days that the invoice is overdue. All applicable sales taxes are extra. Distribution of this price list does not in itself constitute an offer to sell. Orders can be received only from authorized Krug dealers. Acceptance of any order and terms of sale may be established at the discretion of Krug. Deposits are required on orders received from new accounts as well as on large or special orders. Krug reserves the right to discontinue designs, or to change designs, construction, prices, or materials without notice.

Contact Information

Phone: 1.888.578.KRUG (5784) | Fax: 1.519.748.5177
Purchase Order Fax: 1.888.236.4783
Purchase Order E-mail: orders@krug.ca
Web: www.krug.ca E-mail: solutions@krug.ca

Customer Service Hours

Please note customer service hours are:
8:30 am to 5:00 pm est

Customer Satisfaction

It is the primary goal of Krug and our staff to ensure the complete satisfaction of our customers with our products and performance. If a problem arises with a Krug product after the expiration of the limited warranty period, Krug will exercise its best efforts to achieve the satisfaction of the customer in a manner that is fair to all concerned.

Order Acknowledgments

Each order will be acknowledged via e-mail or fax. This acknowledgment is the final agreement between Krug and the customer, superseding all previous communications regarding the purchase order. Where there is a discrepancy on a purchase order between a product code and a description, Krug will make every effort to resolve the discrepancy, but will be ruled by the product code ordered. Please check all acknowledgments for accuracy, and advise Krug of any discrepancies with a purchase order.

Order Cancellation

Krug reserves the right to not accept or allow cancellation of orders. All products are manufactured on a custom-made, make-to-order basis, and the purchasing, engineering and production of orders begins shortly after order placement - and the customer purchase order is a contract that authorizes Krug to manufacture the products. Acceptance of order cancellation (or partial cancellation) is solely at the discretion of Krug, and is dependent on the extent to which engineering, purchasing and manufacturing has been initiated by the time cancellation is requested. No order cancellations (partial or otherwise) are allowable more than 4 weeks from date of order placement (as order production is unable to be terminated by that point), and full payment of the acknowledged order value is required for any orders cancelled after 4 weeks. Cancellations may be allowable in less than 4 weeks after order placement, depending on the extent to which manufacturing has been initiated. An acceptance of order cancellation requires that the purchaser agrees to make payment for all costs incurred to the point of acceptance of cancellation. Cancellation charges include all costs for purchase of dedicated material and components, engineering costs for non-standard products, and all costs for manufacturing completed to that point, as well as a \$350 net charge for processing of the original order and for processing of cancellation invoicing.

Pricing

Krug endeavors to ensure that all prices in this price list reflect accurately our current prices. However, errors do occur and will be rectified through notices to the field. Krug reserves the right to acknowledge pricing that may be different from the price list.

Warranty

Krug warrants the construction and the finish of all our products to be free from defects in materials and workmanship for a period of 10 years from the date of purchase. This warranty is applicable to products in use by their original purchaser. This warranty does not apply to components not manufactured by Krug including textiles, which are subject to the specific warranties of those manufacturers,

if any. Textiles (fabric, leather, vinyl, or any other covering material) suppliers do not guarantee their products for durability and color fastness, and nor does Krug. Casters, mechanical and electrical components have a warranty of five years from the date of purchase. The Krug warranty does not apply to COM-specified materials, damage caused by a carrier other than Krug, or variation in wood finishes due to natural wood color variation. Krug cannot be held responsible for variations in fabric dye lots from order to order. All fabric is carefully inspected when it is received, but a degree of variation in color should be expected. Repairs or replacement of any defect covered under this warranty by Krug will be made, at our option and method, at no charge to the original purchaser during the warranty period. Krug's judgement is final and binding with respect to the nature or cause of defects or damage, and the necessity or manner of repair or replacement.

This warranty does not apply to defects or damage resulting from:

- normal wear and tear occurring with the use of the product
- negligence, misuse, excessive use, alteration, improper cleaning or repair
- substitution or use of incorrect or unauthorized components or material
- handling or installation that is incorrect, or that causes damage or defect
- damage incurred by a freight carrier other than Krug
- wearing of finishes and fabrics, and normal variations in material (including dye lot variations)
- properties of natural materials, including wood and leather
- exposure to environments with uncontrolled temperature and humidity (products must be transported, stored and used in climate-controlled conditions)

Note, specific warranties for components and materials not manufactured by Krug:

Height Adjustable Mechanism Warranty

Krug warrants to the original consumer purchaser its Height Adjustable Mechanism that it will be free from defects in material and workmanship. This limited warranty covers material and manufacturing defects, which cause a non-conformance in the function of a table base and is limited to the following products and warranty term determined from their dates of purchase:

- a) Electronic components such as control boxes, hand switches and motors – two (2) years
- b) Mechanical components such as crank drives, spindles – five (5) years
- c) Structural components such as J-channels, feet and top supports – ten (10) years

The start of the warranty period is the documented date of your purchase of the product. The warranty herein is made to and for the benefit of the original consumer purchaser of the product and is non-transferable. If you discover a defect in material or workmanship during the warranty period, and Krug agrees that the defect exists, Krug will, at its option, repair or replace the Product at no charge to you, provided it is returned during the warranty period. In the unlikely event that your product should require repair or replacement during the warranty period, please contact Krug to obtain warranty service. The warranty period on replacement products is the remainder of the warranty on the original product or 30 days, whichever is longer.

Testing

All Krug Conference products meet or exceed the testing requirements of ANSI/BIFMA X5.5-2014 or X5.9-2012.



Dimensions

Dimensions are in inches and approximate, and subject to change without notice. Contact Customer Service if dimensions are critical.

Installation Support

For assistance please contact Technical Support at 1-888-578-5784 x216 or e-mail installationhelp@krug.ca and you will be directed to the appropriate installation support person.

Storage Charges

Krug reserves the right to assess a nominal storage charge if a customer does not accept shipment of an order within a week of the ship date.

Export Packaging

Krug is pleased to provide the option for export packaging on all our products, to provide additional protection from damage. For shipments overseas, a quote for export packaging can be provided, based on the products to be ordered and the delivery destination - please contact Customer Service or Bids & Specification Support for more information and a quotation. KRUG is not responsible for shipment damage occurring on overseas shipments

Export Packaging is **STRONGLY RECOMMENDED** for:

- (A) all shipments outside of the lower 48 states and Canada
 - (B) all shipments that will be held in storage for an extended period prior to installation. Important: Please note that Krug will not be responsible for damage claims on product shipped or stored in the above conditions where export packaging has not been utilized.
- Please contact Customer Service for specifications or any other assistance regarding export packaging.

Freight Terms and Conditions

1. All product is shipped FOB the Krug factory. Freight is either pre-paid to the destination or not pre-paid, depending on established customer specific freight terms.
2. Docks at the selected delivery location must be equipped to handle a 53' trailer. If a dock is inadequate for delivery by Krug, Krug will re-deliver to another local location and any additional costs will be charged to the customer.
3. For all deliveries, it is understood that Krug or its agent is making a dock delivery only (equipped to handle a 53' trailer), and any further work of truck unloading, delivery beyond the dock, installation, and removal of packaging is not authorized or paid for by Krug.
4. Drop shipments to the installation site, and timed deliveries, are available on larger shipments (full truckloads or slightly less) at no additional charge. Drop shipments or timed deliveries for smaller shipments may not be available, or if available will require a surcharge. Deliveries on an after hours basis, or on weekends, or any other special requirements, may be subject to a surcharge. Location and contact information, and the requested time of delivery, is required at least one week prior to the acknowledged shipment date. If this information is not provided one week in advance, or if the location or time of the drop shipment is changed less than one week in advance, a surcharge may be applied, and/or the drop shipment may not be scheduled.
5. For all deliveries - whether to the Customer location or drop shipment - any circumstances that result in the delay of our carrier (including unsuitable receiving facilities, or facilities not open or available), service charges will be applied at the rate of \$75/hour. Where re-delivery is necessary because of these circumstances, the full cost of re-delivery will be charged. If Less Than Truck Load is delivering, one hour is allocated to unload. Any additional time required to unload after the first hour is \$75/hour. If a Truck Load is delivering the order, three hours is allocated to unload. Any additional time required to unload is \$75/hour. Direct deliveries to site for net orders are possible, must exceed \$60,000 net, and accommodate 48-53' trailers. Krug is responsible for delivery to the approved delivery address. If an address change is required, this must be authorized by Krug 5 business days prior to ship date. Any additional delivery costs incurred after this time will be charged to the customer. Additional costs for partial shipment of orders are the responsibility of the customer, and will be added to invoices. This includes any part shipment costs due to delays from textile suppliers. Additional costs for partial order shipments will normally not be assessed if there is a delay caused by Krug.

Damaged Shipments

All Krug product is well engineered, carefully inspected, and expertly loaded onto our trucks at our Distribution Center. If you receive any damaged freight, we ask that you do not refuse the shipment. Krug is not responsible for damage to goods that occurs in transit or storage. It is the purchaser and/or receiver's responsibility to examine the goods upon receipt and to notify Krug of any damages, overages or shortages. Any discrepancies should be noted on the Bill of Lading. The delivering carrier will not accept responsibility for shortages or damages if signed "clear". Notification of concealed damage claims must be made to Krug Distribution within 5 days of delivery, along with digital pictures if available. All product and

packaging must be available for inspection. Krug liability ceases after 5 business days and Krug will not be responsible for concealed damages if shipments are left unopened. Krug is not responsible for the condition of product that is stored or installed in an environment where temperature and humidity are not controlled.

Field Product Report Authorization

Krug's written authorization, in the form of an FPR number, must be obtained prior to incurring charges of any kind if Krug is expected to pay these charges. This includes authorization for returns, field repairs and replacements, post field repairs, installation and delivery charges. Krug reserves the right to have its representative inspect product related to any request for such authorizations, prior to that authorization being provided. Deductions from invoices paid for any charges to Krug, without prior written authorization in the form of an FPR, will not be accepted. Digital photographs may be required to complete the FPR process.

Care and Maintenance

Wood Finishes - Although Krug's extensive finishing process ensures a durable finish on all our products, there are several steps that can be taken to protect and prolong the life and beauty of the finish. Protect the top by placing felt pads on the bottom of any accessories and mechanical equipment. Rubber and oil will permanently mark surfaces. Use a desk pad to prevent possible damage and imprinting caused by writing instruments and sharp objects. Dust only with a clean, dry cloth, going with the grain. Clean any marks with a damp cloth, using a small quantity of mild soap or detergent. Do not use any wax-based polish, spray or silicone. Eventually, a film will build up and discolor the top. Do not place your furniture in a position of permanent exposure to direct sunlight.

Plastic Laminates - Clean plastic laminates with mild soap and warm water. Do not use steel wool, hot water, or any abrasive cleaning product.

Custom Capabilities

Over 15% of our orders involve some type of custom work, and we invite our customers to make use of our extensive capabilities. These include:

- 1) Dimensional customization of standard size products
 - 2) Custom wood finishes
 - 3) For larger orders, completely custom-designed products, as well as non-standard wood species can be specified.
- Custom orders may require additional production lead times. Contact Customer Service for more information.

Krug Panel Fabric Program

Tackboards can be upholstered in COM material supplied by the customer, and in a selection of stocked tackboard fabrics supplied by Momentum. The Momentum Panel fabrics are available on Krug Express. They are 100% polyester. For additional information and color selections, please refer to our Panel Fabrics card and Krug's website. www.krug.ca The Momentum panel fabrics pass ASTM-E84-87 Fire Codes. If memo samples are required please call Momentum at 1-800-366-6839.

Program Details

KrugExpress orders are ready to ship by the date acknowledged. Delivery and shipping schedules may result in actual shipping of orders at a later date. Statutory holidays and scheduled factory vacations may add to acknowledged lead times of *KrugExpress* orders. Unless otherwise specified on the order, the customer's standard method of shipping Krug products will be utilized. Available factory capacity for *KrugExpress* is filled by orders received on a "first come, first serve" basis. If the normal *KrugExpress* lead time is not available for your order because available capacity has been filled, you will be immediately advised of the earliest available ready-to-ship date. Please consult your Customer Service representative in advance if you wish to confirm the specific lead time availability for a *KrugExpress* order. Orders must be received by midnight of a given day for that day to be considered the official day the order is received. Order lead times are acknowledged from the date the order is received, but not including the date the order is received. *KrugExpress* orders must be "clean" when received in order to be considered officially received on a given day, and lead times will be acknowledged from the date orders are determined to be "clean". Changes to *KrugExpress* orders are not allowed under any circumstances. Orders for product on *KrugExpress* must clearly state: "*KrugExpress*".



Krug Textiles - Leather Program

Grade 8

Black	K13.1000	Graphite	K13.4000
Stone	K13.3000	Espresso	K13.8000
Sand	K13.5000	White	K13.9000

Please contact Customer Service for specific information on leathers, available colors and lead times.

Krug Textiles - Faux Leather Program

Grade 2

White	Taupe	Bisque	Wine	Sprig	Lagoon
Cream	Mocha	Chocolate	Garnet	Chinchilla	Pacific Blue
Parchment	Tan	Black	Rust	Steel	Navy
Sandstone	Chestnut	Earth	Citron	Grey	Plum
Vanilla		Brick			

GRADED-IN UPHOLSTERY PROGRAMS

Krug has partnered with several textile brands to grade in their offerings, designed to provide a wide range of upholstery selections for our seating products.

Upholstery pricing and availability is subject to change without notice. We grade this upholstery according to the pricing of the fabric suppliers - when their pricing changes, the Krug grade may change. When placing an order, a Krug customer must specify the complete upholstery number, along with the appropriate Krug model number and finish. Krug will supply the complete product at the prices listed. Orders specifying graded-in upholstery cannot be cancelled once the upholstery has been ordered.

Upholstery Grades

To determine the price of a product for graded-in upholstery, use the reference lists located on Krug’s website under - Products - Textiles, to view the upholstery grade (1-9). Krug is not responsible for the discontinuation of this upholstery. Please contact Customer Service for information on upholstery not listed.

When two upholstery selections are specified for use on seating, the higher grade upholstery price will apply to the order.

High Performance upholstery; Polyurethane, Vinyl or Crypton, is particularly suitable for healthcare and other intensive-use environments.

Upholstery Samples

If you require additional samples or memos for presentation, please contact fabric supplier directly.

Flammability Standards

- Tunnel Test Surface Ratings Class A rating
- Class 1 UFAC
- Passes State of California Technical Bulletin CAL 117-2013

Please contact fabric supplier directly for further flammability information pertaining to specific upholstery.

Special Conditions

Acknowledgements will give the estimated delivery date of the finished product. Some upholstery is imported, and availability may affect estimated delivery time. For large projects, please contact fabric supplier directly for availability of yardage.

TACKBOARD FABRICS

KRUG PANEL FABRIC PROGRAM

Tackboards can be upholstered in COM material supplied by the customer, and in a selection of stocked tackboard fabrics supplied by Momentum. The in-stock Momentum fabrics are priced at Grade 1 and are available on Krug Express. They are 100% polyester. For additional information and color selections, please refer to our Panel Fabrics card and Krug’s website. www.krug.ca If memo samples are required please call Momentum at 1-800-366-6839. The Momentum panel fabrics pass ASTM-E84-87 Fire Codes.

PROGRAM DETAILS

KrugExpress orders are ready to ship by the date acknowledged. Delivery and shipping schedules may result in actual shipping of orders at a later date. Statutory holidays and scheduled factory vacations may add to acknowledged lead times of KrugExpress orders. Unless otherwise specified on the order, the customer’s standard method of shipping Krug products will be utilized. Available factory capacity for KrugExpress is filled by orders received on a “first come, first serve” basis. If the normal KrugExpress lead time is not available for your order because available capacity has been filled, you will be immediately advised of the earliest available ready-to-ship date. Please consult your Customer Service representative in advance if you wish to confirm the specific lead time availability for a KrugExpress order. Orders must be received by midnight of a given day for that day to be considered the official day the order is received. Order lead times are acknowledged from the date the order is received, but not including the date the order is received. KrugExpress orders must be “clean” when received in order to be considered officially received on a given day, and lead times will be acknowledged from the date orders are determined to be “clean”. Changes to KrugExpress orders are not allowed under any

KRUGEXPRESS

circumstances. Orders for product on KrugExpress must clearly state: “KrugExpress”. *Some conditions apply. Please note PALETTE finishes are not available on KrugExpress.

CASEGOODS PROGRAM

Orders for casegood products on the KrugExpress program may be subject to quantity maximums. Please contact Krug Customer Service for more information. Quantity maximums are dependent upon available capacity, in order to insure that we ship all orders on time. Only actual casegood pieces and conference tables tops and bases are considered “units”. Items such as tasklights, tackboards, keyboard trays and drawers, electrical and wire management components, etc., are not considered under the quantity restrictions. For example, a typical office configuration that includes a desk, linking unit, credenza and hutch/overhead, equals a total of four units for the purposes of the quantity maximum. Only Krug In-stock panel fabric is available on the KrugExpress program. Only standard wood finishes are available for KrugExpress orders. Grommets can be specified in standard positions only. KrugExpress also includes all Krug seating and occasional tables as well as Krug conference products to complement this casegoods offering.

CUSTOMER'S OWN MATERIAL - C.O.M.

Customer's Own Material (COM)

COM must be received three weeks prior to the acknowledged ship date. Orders with COM not received by the required deadline will be delayed.

A description of the fabric, including supplier name, fabric name and color number must be included with the purchase order. When the COM fabric is received at Krug, it must be clearly identified with the fabric name and color, and tagged with name of the Krug customer and purchase order number. Krug will inspect all COM fabric when received to determine if it will be suitable for upholstery. Where Krug feels that the fabric or leather specified will compromise the quality or integrity of our products, customers will be contacted to direct these concerns. Further, Krug reserves the right to refuse to accept and use any COM fabrics or leathers that will compromise our products in any way that is unacceptable to Krug. Krug cannot assume responsibility for the durability or tailoring quality of customer's own material.

Yardage specified in this price guide is approximate. In the case of multiple product orders, multiply the number of items by the COM yardage specified to determine fabric required, unless otherwise indicated. Additional yardage may be needed if the material is less than 54" wide, or patterned or striped and requires matching. As fabric is applied horizontally, non-directional fabrics are recommended. COM fabrics are applied as they come off the roll unless otherwise specified. All striped fabrics will be applied vertically unless otherwise stated by the customer and after approval by Krug. It is the customer's responsibility to advise Krug if the upholstery is to be applied otherwise, and to advise Krug of any special upholstery instructions. Special instructions should be sent to Krug Customer Service, including a sample (or photocopy) of the fabric. Krug is not responsible for instructions sent with the fabric rolls, or for the method of upholstery if no instructions have been provided. COM fabrics for tackboards may be specified in either Maharam or Momentum panel fabrics. Krug is not responsible for determining if a fabric is not ideal for tackboard application.

Please contact Maharam at 1-800-645-3943 or Momentum at

COM Shipping Procedures

For tackboard COM fabrics, please send fabrics to:

Krug Inc.

111 Ahrens Street

Kitchener, Ontario

Canada N2H 4C2

Attention: RECEIVER

All packages must be clearly marked "For Customs Clearance by Willson International Custom Brokers". According to the North American Free Trade Agreement (NAFTA), goods shipped between the United States and Canada can qualify for exemption from all duties, or for a reduction in duties, if the goods can be proven to originate in either the United States, Canada or Mexico.

Canada Customs requires that a NAFTA Certificate of Origin and Commercial Invoice be completed and sent with the fabric shipment. The Commercial Invoice must clearly state the description of the fabric, the selling price, the make-up or content, and the purchaser. The absence of these two documents will delay the shipments at the U.S./Canada border, thereby potentially delaying the customer order. If the total value of the shipment is less than \$1200 U.S., Customs will accept a Low Value Statement of Origin in place of the NAFTA Certificate of Origin. The Low Value Statement must be signed by a representative of the exporting company. This statement may either be included on the commercial invoice or attached to the invoice.

Krug is happy to answer any questions or concerns about COM shipping procedures and the required documents. Please contact our Customs Specialist at 1.888.578.5784.

LAMINATES

LAMINATES

Krug's in-stock Laminates are available in 17 different laminate selections. Please note that 4 of the colors (Gingerbread, Portobello, Ash and Willow) have textured finishes and may not be appropriate for use in patient areas due to infection control concerns. Minimum order quantities and extended lead times may apply for exotic laminate colors, please check with customer service. Polymer Edge will be selected to match the worksurface. Krug's previous laminate in-stock program will be phased out as in-stock supply depletes. Please contact customer service for availability.

IN-STOCK LAMINATES

Wood Grain Laminates	High Pressure Laminate Supplier	Textured Wood Grain Laminates	High Pressure Laminate Supplier
Champagne	Tafisa T492CR	Gingerbread	Tafisa T556UR
Hardrock Maple	Formica 86992-58	Portobello	Tafisa T557UR
Dune	Tafisa T491CR	Ash	Tafisa T535AT
Copper	Tafisa T521CR	Willow	Tafisa T543AT
Shiraz Cherry	Tafisa T472CR		
Park Avenue Walnut	Wilsonart 7984-38	Solid Laminates	
Chocolate	Tafisa T498CR	Designer White	Wilsonart D354-60
Nutmeg	Tafisa T477CR	Platinum	Tafisa T202CR
Dark Walnut	Tafisa T469CR	Earth	Tafisa T767CR
		Charcoal	Tafisa T228CR

PHASE OUT LAMINATES

Almond - Black- Shadows - Edgewood Sycamore - Gunstock Walnut
Non-Stocked Laminates

For specific lead time and application questions, please contact Krug Customer Service for your requirement. Upcharges will be applicable for non-stocked laminates, depending on their cost. Non-stock laminates may require a minimum order quantity, please contact customer service. Stocked polymer edges only can be specified for use with non-stocked laminates or tops will be self-edged.



The mark of responsible forestry

All products are air emissions certified and are available as FSC® certified

krug