

NUVO
Price and Specification Guide
CANADA



krug

Advancing Design Through Innovation

NUVO | TABLE OF CONTENTS

NUVO

- 2 Nuvo Environmental Summary
- 3 Features & Options
- 5 Power Management
- 7 Sample Configurations
- 8 Rectangular Wood Tops
- 9 Arc End Wood Conference Tops
- 10 Racetrack Wood Conference Tops
- 11 Boat Shaped & Visio Wood Conference Tops
- 12 Oval, Arced Square & Round Wood Conference Tops
- 13 Console Planning For Wood Tops
- 14 Console Size & Location For Wood Tops
- 24 Console Size & Location For Laminate Tops
- 34 Consoles for Wood & Laminate Tops
- 35 Back-Painted Glass Rectangular Conference Tops
- 36 Back-Painted Glass Arc End Conference Tops
- 37 Back-Painted Glass Boat Shaped & Visio Conference Tops
- 38 Back-Painted Glass Oval, Arced Square & Round Conference Tops
- 39 Console Planning for Back-Painted Glass Tops
- 40 Console Size & Location For Back-Painted Glass Tops
- 47 Consoles for Back-Painted Glass Tops & Console Power/Data Modules
- 48 Standard Console Power/Data Media Modules
- 52 Console Power Modules for Custom Configurations
- 53 Console Data/Media Options
- 58 Bases
- 59 Base Requirements Chart

MEDIA AND STORAGE

- 67 LEED Credit Summary, Substantiality & Environmental
- 68 Features & Options
- 71 Credenzas
- 75 Buffets
- 81 Hospitality Carts
- 82 Lecterns & Media

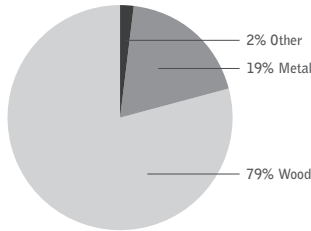
GENERAL INFORMATION

- 83 Terms & Conditions
- 83 Warranty
- 84 KrugExpress
- 85 Wood Finish & Laminates

LEED CERTIFICATION



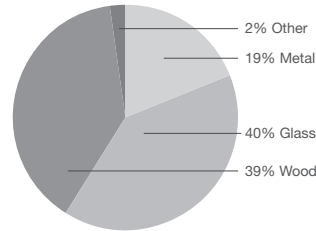
MATERIAL CONTENT:



PRE-CONSUMER RECYCLED CONTENT - 82%
POST-CONSUMER RECYCLED CONTENT - 2.5%



MATERIAL CONTENT:



PRE-CONSUMER RECYCLED CONTENT - 72%
POST-CONSUMER RECYCLED CONTENT - 2.5%

		CONTRIBUTES TO
Credit 2.1 - 2.2	Construction Waste Management	1-2 point(s)
Credit 4.1	Recycled Content	1 point
Credit 4.2	Recycled Content	1 point
Credit 4.5	Low Emitting Materials, (MUST BE REQUESTED)	
	Composite Wood & Laminate Adhesives	1 point
Credit 5.1	Regional Materials*	1 point
Credit 6	Rapidly Renewable Materials (MUST BE REQUESTED)	1 point
Credit 7	Certified Wood (MUST BE REQUESTED)	1 point

*This credit is only applicable if in total 20% of the combined value of the procurement of construction materials and in the furniture are manufactured within a radius of 500 miles. This credit will apply if the installation of the finished product occurs within 500 miles of Kitchener, Ontario.



level® CERTIFICATION

BIFMA's e3 Furniture Sustainability Standard is a voluntary, multi-attribute standard that measures the degree of sustainability of furniture. This standard evaluates product and company environmental attributes and compliance systems in a wide range of elements which include Materials, Energy & Atmosphere, Human & Ecosystem Health and Social Responsibility. Nuvo products have earned level®, BIFMA's sustainability certification program for furniture, certification through third-party verification against the e3 standard. All Nuvo products can be supplied with level® certification. In order to accomplish this, the product must also be ordered with the air-emissions-certification option. Contact customer service for information and upcharges.



the mark of responsible forest®

AIR-EMISSIONS

All Nuvo products can be supplied with air-emissions-certified materials. Contact customer service for information and upcharges.

FSC®

FSC® In 2005, Krug received Forest Stewardship Council® (FSC®) Chain-of-Custody certification for our manufacturing facilities. The FSC® Chain-of-Custody tracks certified wood from seedling to final sale. It verifies that the material for our FSC® certified products only come from well-managed, FSC®-certified forests and other controlled sources. FSC® is dedicated to the promotion of responsible forest management worldwide helping to take care of forests for future generations. Nuvo and other Krug products can be specified with FSC® Certification. Contact customer service for further information, pricing and lead times..

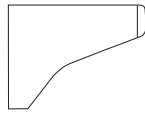


In addition, architects, designers, and building professionals can specify FSC®-certified products in order to achieve a point from the US. Green Building Council's Leadership in Energy and Environmental Design (LEED) Rating System.

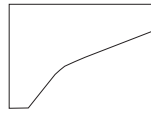
NUVO | FEATURES & OPTIONS

TOPS

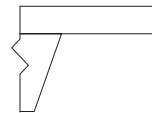
Nuvo Conference products offers 8 table top shapes in 6 veneer species in addition to 13 wood grain, 4 solid laminate selections. Veneered tops are 1 1/2" thick veneered fiberboard MDF core and backer material, with a 1/8" wood edge. Laminate tops are 1 1/2" thick with fiberboard MDF core and backer material, with a PVC edge. Conference tops are available with these profiles.



Edge profile for wood tops
Knife Edge



Edge profile for laminate tops



Edge profile for glass tops

BASES

All bases are shipped separately and require assembly to support beams and/or tops.

All wood bases, with the exception of panel bases, offer large interior cavities for cable routing and allow for total concealment of wiring when floor monuments are located underneath. Bases are equipped with removable panels which make access to the interior quick and easy.

Refer to the base requirements chart on page 60 to select the appropriate bases and sizes for conference tables.

Formed Metal Bases are available in Matte Chrome finish.

Base plates are available in a choice of Wood, Palette, Laminate or Gloss Aluminum finish.

CONSOLES

Consoles are available in 14", 27", 36", 42" and 50" lengths, and can be located within a top section or across a seam. Consoles located within a table section will be factory installed. Consoles located across the seam are ordered by a separate model number and will be shipped as a separate item for field installation. The console access cover allows wiring to pass through to the console module from all sides. The console access cover can be operated from either side of the table for easy access to the console module and opens to a 95° angle from the top of the table. Console access covers are available in Gloss Aluminum with Polished Chrome end bezels.

CONSOLE POWER/DATA/MEDIA MODULES

Console power/data/media modules are available in 18 preconfigured options or can be customized by adding plate-mounted or snap-in data ports to any of the 4 standard power modules. The number of console modules per console is dependent on the console size; 1 unit in 14" lengths, 2 units in 27" and 36" lengths, and 3 units in 42" and 50" lengths. Console power modules are available in three cord lengths (6', 16' and 25'). A utility outlet is available in some console module models for connecting power within a table. Up to 10 duplex receptacles can be connected to one electrical circuit. Faceplates, duplex receptacles and data components are white.

SUPPORT BEAMS

Aluminum support beams provide strength and support to the conference tops. Support beams are field installed onto the bases allowing for top-on-last installation for all base styles except the formed metal base. Powder coated steel trough pans located between the support beams accommodate under-surface cable management and runs cables to interior base cavities to access floor monuments.

SEATING CAPACITY

To establish seating capacity, an outside chair dimension of 24" has been used for this price guide, plus an allowance of 5" between chairs, for a total of 29". This is an approximation only. When using another chair, particularly seating with a 5 prong caster base, be sure to adjust the approximate seating capacity accordingly. Since not all manufacturers use the same formula, when seating capacity is in question, please contact Krug Customer Service to review the specific seating that is being used with Nuvo Conference Tables.

VENEER

Veneers available are Rift White Oak, Quarter Cut Maple, Cherry, Walnut.

FINISH

A five step catalyzed varnish finish that when dry has a sheen value of 32°, is applied to all tables, bases and cases. A lower sheen topcoat, 20°, can also be specified, at standard pricing. All purchase orders must clearly note "lower sheen finish" in order to receive this optional selection. All finished surfaces are well sanded before applying finishing materials. The procedure begins by applying a base color via an NGR stain. A wash coat follows to further enhance the color. Next is the glazing process, which provides the 3rd color step and fills the pores of the wood. A sealer coat is then applied, twice to the horizontal worksurfaces to enhance the finish. The product is then scuff sanded to prepare for the top coat. The top coat is a catalyzed varnish that when dry has a sheen value of 32°. Krug's catalyzed varnish has been tested to be one of the industry's most durable and long lasting. Custom finishes are available at an upcharge of 10% list per unit.

GLASS SURFACES

Nuvo conference tops are available in white back-painted 10mm tempered glass. Please contact customer service for additional color selections available at no upcharge. Color options also on website.

SOLID SURFACES

Solid Surface tops are available on conference tops. The solid surface standard top option is white, with additional colors available upon request. Solid surfaces are composed of minerals, acrylic resins that are non-porous and stain, scratch and dent resistant. Color is throughout the material, so surface scratches are not as visible. Please contact customer service with specifications for a quote.

GLIDES

Wood bases feature adjustable glides 1 1/2" long and allow for a range of adjustment of 3/4". Metal bases have 1/2" glides.

MICROPHONE CUT OUTS

Microphone cut outs are available for **\$361 list** per table for up to 7 microphone cutouts. For Back-Painted Glass tops add an additional **\$120 list** per cut-out.

HOW TO SPECIFY NUVO

- 1) Specify table top shape, size, model number and top material. For wood and laminate tops see page 9, for Back-Painted Glass see page 36.
- 2) Select base shape, size and model number using Base Requirements chart on page 60.
- 3) Specify console location (end sections, middle sections or across the seam) and size option. For wood top see page 15, for Back-Painted Glass see page 40.
- 4) Cross seam console model number, where applicable. For wood top see page 15 for Back-Painted Glass see page 41.
Please note: Across seam consoles are field installed and have a separate model number.
- 5) Specify Console Power module options. Preconfigured Console Modules, see page 49. Custom Console Modules, see page 53.
- 6) Add plate-mounted data or snap-in data options to custom module, see port options on page 49.

Purchase orders must include:

- Wood Species and Finish
- Base Plates - Gloss Aluminum, Palette, Laminate or Wood

LAMINATE WORKSURFACES

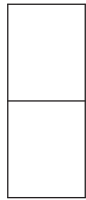
Laminate is available on all Nuvo Conference Tops; refer to Krug's standard laminate program on page 347. Krug will order and procure laminates. Purchase orders with a plastic laminate option must include Laminate Name.

Krug reserves the right to decline a laminate that may not be suitable for the application. Krug assumes no responsibility for durability or consistent color. The number of sections on 48" wide Laminate tops, on some table sizes, are different than the same size wood top. This is due to the size of laminates available. See table sections column on pages 25. Please note the grain direction of wood grain laminates will run lengthwise on 1 piece tops and crosswise on multiple piece tables. The grain direction of wood grain laminate will run horizontal on the backs of credenzas and buffets.

CUSTOM SIZING

Custom sizing and additional customization is available on Nuvo Conference Tables. Tops may be ordered with a reduced number of sections at an upcharge. For more information or to obtain quotations, please contact Customer Service.

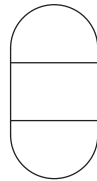
STANDARD TABLE SHAPES



Rectangular
Model Number: 5161
Glass Top 5161GP



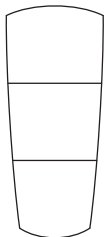
Arc End
Model Number: 5166
Glass Top 5166GP



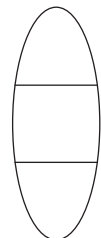
Racetrack
Model Number: 5102
Glass Top 5102GP



Boat Shaped-Arc Ends
Model Number: 5164
Glass Top 5164GP



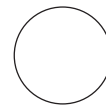
Visio-Arc Ends
Model Number: 5168
Glass Top 5168GP



Oval
Model Number: 5159
Glass Top 5159GP



Arced Square
Model Number: 5166
Glass Top 5166GP



Round
Model Number: 5105
Glass Top 5105GP

SQUARE CORNER TOPS

Nuvo conference tables may be specified with Square Corners in all shapes with rounded corners. To order these additional configurations, please replace the standard model number with the number listed: Rectangular = 5101, Arc End = 5106, Boat Shape-Straight End = 5104, Boat Shape-Arc End = 5154, Visio-Straight End = 5108, Visio-Arc End = 5158, Arc Square = 5156. Pricing for tops with square corners is the same as standard tops.

TESTING

All products have been tested in accordance with ANSI/BIFMA X5.5-2014 or X5.9-2012.



NUVO | POWER MANAGEMENT

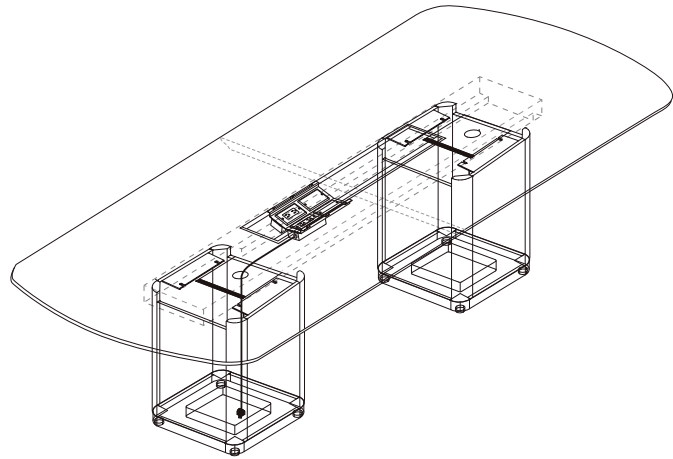
All Nuvo Conference tables feature cable management capabilities for routing cables between the floor monuments and the consoles that provide voice/power/data/media connections.

Support beams connect the bases and provide additional support for the conference top. Support beams enable top-on-last assembly of the tables - this shortens the installation time, requires fewer installers, and helps to prevent damage to table tops. Data cables can be connected to the power/data modules and dropped into the base and connected to the source prior to the installation of the top. After the top is installed, the power modules are bolted into the threaded inserts in the top. Cable troughs located between the support beams offer generous space for cable management and are supplied with grommets to allow for cables to pass through to the base interior cavities.

Bases feature sizable cutouts at the bottom, providing access to floor monuments. With the exception of Panel and Formed Metal Bases, bases allow for total concealment of wiring when floor monuments are located underneath. Access doors are provided on the inward-facing vertical side of the bases, providing quick access to cabling in the interior. Formed Metal bases are available with an external cable management system and cables are run to the floor using a Metal Cable Manager or Spine Cable Manager.

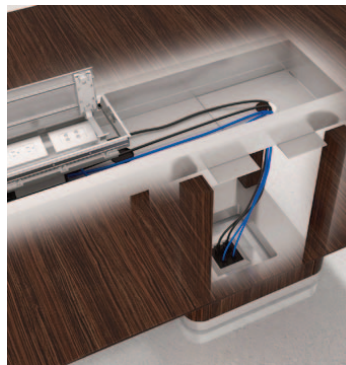
The Console modules are housed within the support beam and provide power and communications connectivity. Console modules utilize UL standard receptacle outlets. Console modules are available in 18 pre-configured configurations, or can be custom-configured in unique configurations - or alternatively can be specified with blank ports, so customers can purchase and insert their own outlets. Console modules also can be designed and built specifically to meet your connectivity needs by using the Snap-in or Plate mounted port options. Console modules are available with three electrical cord lengths (6', 16', and 25'). Console modules with a utility outlet will allow units to be linked together to a maximum of 10 duplex receptacles per circuit. The number of console modules is dependent on the console size; 1 unit in 14" lengths, 2 units in 27" and 36" lengths, and 3 units in 42" and 50" lengths.

Consoles are available in 14", 27", 36", 42" and 50" lengths, and can be located within a top section, or can span top section seams. The console access cover allows wiring to pass through to the console module from all sides. Console access covers are operated from either side of the table for easy access to the console module and open to a 95° angle from the top of the table. Console access covers are available in a Gloss Aluminum finish with polished chrome end bezel. There are some limitations in glass, please see page 41.

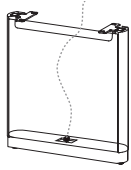


SUPPORT BEAMS & CABLE TROUGH

CONSOLE MODULE



Panel Base



Base Size	Base Floor Monument Cut Out Dimension
Note: Panel bases will not completely conceal floor monuments.	
Panel bases have 2 cable access panels	

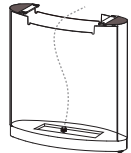
21" x 3"	4" X 1.5"
25" x 3"	4" X 1.5"
31" x 3"	4" X 1.5"

Formed Metal Base



NOTE: Formed Metal bases do not feature an interior cavity. Formed Metal bases have external cable management systems allowing cables to run to the floor monument. See page 60 for model numbers and cable management options. Overall table height is 29.5"

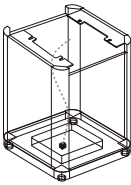
Oval Base



Oval bases have 2 cable access panels 16" x 16"

21" x 8"	12" X 5"
25" x 10"	12" X 6.5"
31" x 12"	12" X 9.5"

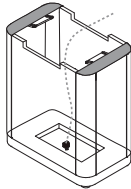
Square Base



Square bases have 1 cable access panel

16"x16"	6.25" X 6.25"
20" x 20"	9.5" X 9.5"
24" x 24"	14.5" X 14.5"
30" x 30"	20.5" X 20.5"

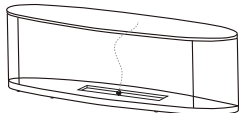
Rectangular Base



Rectangular bases have 1 cable access panel

21" x 12"	15" X 6"
25" x 12"	19" X 6"
31" x 12"	25" X 6"

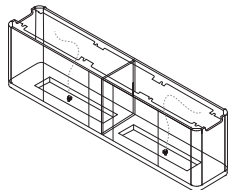
Oval Island Base



Oval Island bases have 2 cable access panels

18" x 47"	10" X 20"
18" x 71"	(2) 6 X 11 (1) 6 X 15
24" x 71"	13 X 33
24" x 95"	(2) 13 X 12 (1) 13 X 26
24" x 107"	(2) 13 X 17 (1) 13 X 33

Rectangular Island Base

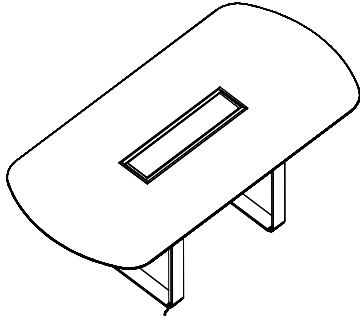


Rectangular Island bases have 1, 2 or 3 cable access panels depending on base size

18" x 27"	9" X 9"
18" x 39"	9" X 22"
18" x 63"	9" X 29"
18" x 99"	(2) 9" X 33"
18" x 123"	(2) 9" X 43"
18" x 171"	(4) 8" X 34"
24" x 63"	11" X 29"
24" x 99"	(2) 11" X 33"
24" x 123"	(2) 11" X 43"
24" x 171"	(4) 11" X 34"
24" x 219"	(3) 11" X 40"

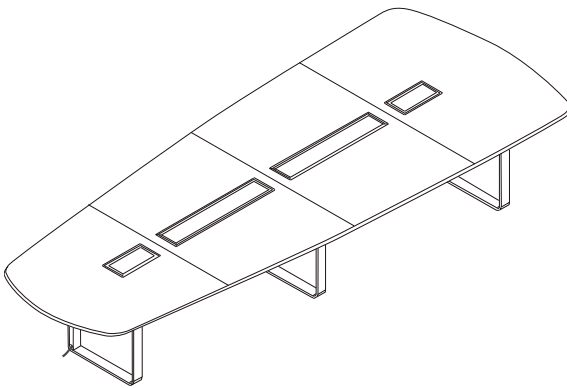
NUVO | SAMPLE CONFIGURATIONS

SAMPLE CONFIGURATIONS - EXAMPLE ONE



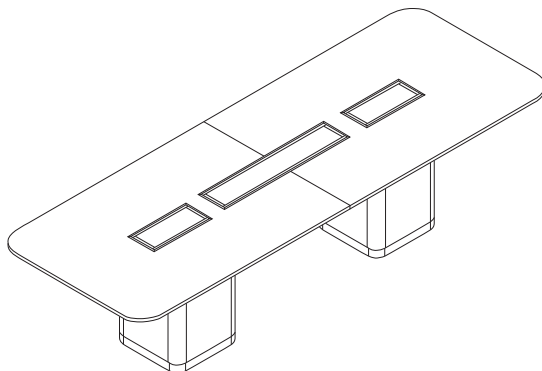
Description	Model Number	Laminate, Oak	
		Maple, Cherry	Walnut
(1) Arc End Top 72x36	51667236	3095	3404
(1) Formed Metal Base w/ Metal Cable Manager	514124328CMI	1356	1356
(1) Formed Metal Base	514124328	1173	1173
(1) Console Access Port within top section	AM27	295	295
(1) Console Power Module for Custom Configurations Console Data/Media Options	51PMA06	483	483
Position 3 -(1) - DVI-D Dual (Digital)	P03	137	137
Position 4 -(1) - Adaptor Plate	M04	38	38
-(2) - RJ45-CAT6 White	S01W	47	47
-(1) - RJ11-Telephone White	S02W	47	47
-(1) - HDMI	S04	32	32
		173	173
TOTAL LIST		\$6,876	\$7,185

SAMPLE CONFIGURATIONS - EXAMPLE TWO




Description	Model Number	Laminate, Oak	
		Maple, Cherry	Walnut
(1) Visio Top 168x66/42	51681686642	13909	15297
(1) Formed Metal Base w/ Metal Cable Manager	514124328CM1	1356	1356
(1) Formed Metal Base	514136328	1311	1311
(1) Formed Metal Base	514148328	1446	1446
(4) Console Access Ports within top section	AI14	265	265
	BM36	333	333
	CM36	333	333
	DI14	265	265
(3) Basic Data with 2 Duplex Receptacles & Utility Outlet	51PDCD01-06	559	559
		559	559
		559	559
(1) Basic Data with 2 Duplex Receptacles	51PDAD01-06	508	508
TOTAL LIST		\$21,403	\$22,791

SAMPLE CONFIGURATIONS - EXAMPLE THREE



Description	Model Number	Laminate, Oak	
		Maple, Cherry	Walnut
(1) Rectangular Top 120x48	516112048	5946	6541
(2) 20" Square Bases	5143202025	1236	1358
		1236	1358
(2) Console Access Port within top section	AM14	265	265
	BM14	265	265
(1) Console Access Port across a seam	51CONSOLE-X27 (ABX27)	295	295
(2) Basic Data with 2 Duplex Receptacles & Utility Outlet	51PDCD01-06	559	559
		559	559
(1) Basic Data with 2 Duplex Receptacles	51PDAD01-06	508	508
TOTAL LIST		\$10,869	\$11,708

NUVO | RECTANGULAR CONFERENCE TOPS

Description	Model	Laminate		L	W	Table Sections	Approximate Seating	Shipping Weight	Cubic Feet
		Oak, Maple, Cherry	Walnut						
Rectangular- Rounded Corners	51616036	2787	3066	60	36	1	4	95	5
	51616042	2936	3231	60	42	1	4	110	6
	51616048	3088	3396	60	48	1	4	125	6
	51617236	2983	3279	72	36	1	6	113	6
	51617242	3133	3445	72	42	1	6	131	7
	51617248	3283	3609	72	48	1	6	148	8
	51617836	3238	3561	78	36	1	6	122	6
	51617842	3418	3760	78	42	1	6	142	7
	51617848	3599	3958	78	48	1	6	161	8
	51618436	3462	3811	84	36	1	6	131	7
	51618442	3688	4059	84	42	1	6	152	8
	51618448	3915	4308	84	48	1	6	172	9
	51619636	3613	3975	96	36	1	8	150	8
	51619642	4215	4637	96	42	2	8	175	9
	51619648	4817	5299	96	48	2	8	198	10
	516110842	4366	4802	108	42	2 (3)	8	195	10
	516110848	5043	5547	108	48	2 (3)	8	222	11
	516110854	5796	6375	108	54	3	8	250	13
	516112042	5269	5796	120	42	2 (3)	8	216	11
	516112048*	5946	6541	120	48	2 (3)	10	247	12
	516112054	6624	7287	120	54	3	10	278	14
	516112060	7375	8116	120	60	3	10	307	15
	516114448	6773	7452	144	48	2 (3)	10	297	15
	516114454	7603	8364	144	54	3	12	333	17
	516114460	8506	9357	144	60	3	12	369	18
	516115654	8280	9109	156	54	3 (4)	12	362	18
	516115660	9334	10266	156	60	3 (4)	12	401	20
516116848	8957	9853	168	48	3 (4)	12	347	17	
516116854	10086	11095	168	54	4	12	390	19	
516116860	11366	12502	168	60	4	12	431	21	
516119248	10463	11510	192	48	3 (4)	14	397	20	
516119254	11741	12915	192	54	4	14	445	22	
516119260	13172	14488	192	60	4	14	492	24	
516121654	12946	14240	216	54	5	16	501	24	
516121660	14526	15978	216	60	5	16	554	27	
516124060	16408	18048	240	60	5	18	617	30	
516126460	18592	20447	264	60	6	20	680	33	
516128860	20997	23096	288	60	6	22	740	36	

NOTE: Support Beams are included in top price. An additional line item for the support beam will be included on the order acknowledgment at no charge.

RECTANGULAR - SQUARE CORNER TOPS:

Rectangular tops with square corners are available. Replace the model prefix with **5101**. e.g. **516114448** becomes **510114448** Pricing is the same as standard tops.

LAMINATE TABLE SECTIONS:

The number in brackets under table sections, refers to the number of sections when ordering laminate tops, if different than the number of sections for the same size wood top. Please note the grain direction of wood grain laminates will run lengthwise on 1 piece tops and crosswise on multiple piece table tops.

ORDERING PROCEDURES

- To order, please specify the following:
- 1) Table top shape, size, model number and wood species
 - 2) Base model number
 - 3) Console location and size option
 - 4) Cross seam console model number, where applicable
 - 5) Console power module and data options

DIMENSION KEY

L - length
 W - Width
 Dimensions are in inches and approximate.
 Contact Customer Service if dimensions are critical.

STANDARD FINISHES

For a complete list of standard wood finishes, please see page 347

BASE REQUIREMENTS

See page 60 for base requirements

CONSOLE SIZE & LOCATIONS

For information on Console locations and size options, see page 15 for wood and page 25 for laminate.

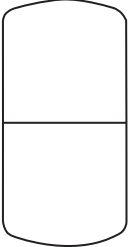
CONSOLE POWER/DATA MODULE OPTIONS

See page 49 for Console Module Options

TABLE SECTION SIZE

Section sizes can be calculated by dividing the table length by the # of sections

NUVO | ARC END CONFERENCE TOPS

Description	Model	Laminate		L	W	Table Sections	Approximate Seating	Shipping Weight	Cubic Feet
		Oak, Maple, Cherry	Walnut						
Arc End Table - Rounded Corners	51666036	2760	3037	60	36	1	4	89	5
	51666042	2941	3235	60	42	1	4	103	5
	51666048	3119	3433	60	48	1	4	117	6
	51667236	2948	3242	72	36	1	6	107	5
	51667242	3127	3438	72	42	1	6	123	6
	51667248	3305	3637	72	48	1	6	140	7
	51667836	3190	3510	78	36	1	6	116	6
	51667842	3398	3738	78	42	1	6	134	7
	51667848	3607	3969	78	48	1	6	153	8
	51668436	3407	3747	84	36	1	6	125	7
	51668442	3659	4021	84	42	1	6	144	8
	51668448	3908	4298	84	48	1	6	164	9
	51669636	3550	3904	96	36	1	8	144	7
	51669642	4159	4574	96	42	2	8	167	9
	51669648*	4768	5245	96	48	2	8	190	10
	516610842	4300	4732	108	42	2 (3)	8	188	10
	516610848	4983	5482	108	48	2 (3)	8	214	11
	516610854	5735	6309	108	54	3	8	240	12
	516612042	5162	5679	120	42	2 (3)	10 (8)	211	11
	516612048	5844	6428	120	48	2 (3)	10	239	12
	516612054	6524	7176	120	54	3	10	268	14
	516612060	7278	8005	120	60	3	10	297	15
	516614448	6631	7294	144	48	2 (3)	10	289	15
	516614454	7457	8201	144	54	3	12	324	16
	516614460	8351	9187	144	60	3	12	359	18
	516615654	8101	8912	156	54	3 (4)	12 (10)	353	18
	516615660	9140	10055	156	60	3 (4)	12	390	20
516616848	8710	9582	168	48	3 (4)	12	338	17	
516616854	9821	10804	168	54	4	12	380	19	
516616860	11075	12183	168	60	4	12	421	21	
516619248	10144	11158	192	48	3 (4)	14	388	20	
516619254	11398	12538	192	54	4	14	435	22	
516619260	12795	14077	192	60	4	14	482	24	
516621654	12545	13799	216	54	5	16	491	25	
516621660	14085	15494	216	60	5	16	544	27	
516624060	15878	17466	240	60	5	20 (18)	606	30	
516626460	17957	19752	264	60	6	20	668	33	
516628860	20250	22275	288	60	6	22	729	36	

NOTE: Support Beams are included in top price. An additional line item for the support beam will be included on the order acknowledgment at no charge.

ARC END TABLE - SQUARE CORNERS:

Arc End tops are available with square corners. Replace the model number prefix with **5106**. e.g. **516612042** becomes **510612042**. Pricing is the same as standard tops.

LAMINATE TABLE SECTIONS:

The number in brackets under table sections, refers to the number of sections when ordering laminate tops, if different than the number of sections for the same size wood top. Please note the grain direction of wood grain laminates will run lengthwise on 1 piece tops and crosswise on multiple piece table tops.

SEATING CAPACITY:

The number in brackets is the seating capacity when formed metal legs are used if different than the seating capacity when other bases are used.

ORDERING PROCEDURES

- To order, please specify the following:
- 1) Table top shape, size, model number and wood species
 - 2) Base model number
 - 3) Console location and size option
 - 4) Cross seam console model number, where applicable
 - 5) Console power module and data options

DIMENSION KEY

L - Length
W - Width
Dimensions are in inches and approximate.
Contact Customer Service if dimensions are critical.

STANDARD FINISHES

For a complete list of standard wood finishes, please see page 347

BASE REQUIREMENTS

See page 60 for base requirements

CONSOLE SIZE & LOCATIONS

For information on Console locations and size options, see page 15 for wood and page 25 for laminate.

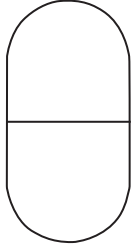
CONSOLE POWER/DATA MODULE OPTIONS

See page 49 for Console Module Options

TABLE SECTION SIZE

Section sizes can be calculated by dividing the table length by the # of sections

NUVO | RACETRACK CONFERENCE TOPS

Description	Model	Laminate		L	W	Table Sections	Approximate Seating	Shipping Weight	Cubic Feet
		Oak, Maple, Cherry	Walnut						
	51026036	2797	3078	60	36	1	4	83	5
	51026042	2941	3235	60	42	1	4	94	5
	51026048	3097	3408	60	48	1	4	104	6
	51027236	2984	3281	72	36	1	6	101	6
	51027242	3140	3455	72	42	1	6	115	6
	51027248	3285	3612	72	48	1	6	127	7
	51027836	3241	3564	78	36	1	6	110	6
	51027842	3428	3770	78	42	1	6	126	7
	51027848	3601	3959	78	48	1	6	140	8
	51028436	3470	3817	84	36	1	6	119	7
	51028442	3700	4069	84	42	1	6	136	7
	51028448	3916	4306	84	48	1	6	152	9
	51029636	3613	3975	96	36	1	8	138	7
	51029642	4216	4637	96	42	2	8	159	9
	51029648	4819	5299	96	48	2	8	178	10
	510210842	4374	4812	108	42	2 (3)	8	180	10
	510210848*	5047	5553	108	48	2 (3)	8	202	11
	510210854	5808	6389	108	54	3	10 (8)	226	12
	510212042	5276	5803	120	42	2 (3)	8	202	11
	510212048	5950	6544	120	48	2 (3)	10	227	12
	510212054	6625	7287	120	54	3	10	251	14
	510212060	7386	8122	120	60	3	10 (8)	275	15
	510214448	6783	7461	144	48	2 (3)	12 (10)	277	15
	510214454	7614	8373	144	54	3	12 (10)	307	16
	510214460	8516	9368	144	60	3	12 (10)	337	16
	510215654	8286	9108	156	54	3 (4)	14 (12)	336	18
	510215660	9334	10266	156	60	3 (4)	14 (12)	369	20
	510216848	8962	9857	168	48	3 (4)	12	326	17
	510216854	10093	11102	168	54	4	14 (12)	364	19
	510216860	11371	12507	168	60	4	14 (12)	399	21
510219248	10466	11514	192	48	3 (4)	14	376	20	
510219254	11743	12916	192	54	4	16 (14)	418	22	
510219260	13175	14492	192	60	4	16 (14)	460	24	
510221654	12947	14242	216	54	5	18 (16)	475	25	
510221660	14538	15992	216	60	5	18 (16)	522	27	
510224060	16416	18056	240	60	5	18 (16)	584	30	
510226460	18594	20451	264	60	6	20 (18)	647	33	
510228860	21002	23102	288	60	6	22 (20)	707	36	

NOTE: Support Beams are included in top price. An additional line item for the support beam will be included on the order acknowledgment at no charge.

LAMINATE TABLE SECTIONS:

The number in brackets under table sections, refers to the number of sections when ordering laminate tops, if different than the number of sections for the same size wood top. Please note the grain direction of wood grain laminates will run lengthwise on 1 piece tops and crosswise on multiple piece table tops.

SEATING CAPACITY:

The number in brackets is the seating capacity when formed metal legs are used if different than the seating capacity when other bases are used.

ORDERING PROCEDURES

To order, please specify the following:

- 1) Table top shape, size, model number and wood species
- 2) Base model number
- 3) Console location and size option
- 4) Cross seam console model number, where applicable
- 5) Console power module and data options

DIMENSION KEY

L - length

W - Width

Dimensions are in inches and approximate.

Contact Customer Service if dimensions are critical.

STANDARD FINISHES

For a complete list of standard wood finishes, please see page 347

BASE REQUIREMENTS

See page 60 for base requirements

CONSOLE SIZE & LOCATIONS

For information on Console locations and size options, see page 15 for wood and page 25 for laminate.

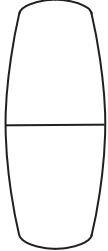
CONSOLE POWER/DATA MODULE OPTIONS

See page 49 for Console Module Options

TABLE SECTION SIZE

Section sizes can be calculated by dividing the table length by the # of sections

NUVO | BOAT SHAPED & VISIO CONFERENCE TOPS

Description	Model	Laminate		L	W	Table Sections	Approximate Seating	Shipping Weight	Cubic Feet
		Oak, Maple, Cherry	Walnut						
	5164964842	5210	5729	96	48/42	2	8	181	10
	5164965442*	6109	6718	96	54/42	2	8	204	11
	51641204842	6430	7071	120	48/42	2 (3)	8	229	12
	51641205442	7164	7882	120	54/42	3	10 (8)	257	14
	51641444842	7316	8046	144	48/42	2 (3)	10	276	15
	51641445442	8220	9041	144	54/42	3	12	311	15
	51641685442	10900	11987	168	54/42	4	12	366	19
	51641925442	12691	13960	192	54/42	4	14	419	22
	51642166048	15702	17270	216	60/48	5	16	526	27
	51642406048	17733	19505	240	60/48	5	18 (16)	585	30
	51642646048	20081	22089	264	60/48	6	20	646	33
	51642886048	22684	24953	288	60/48	6	22	704	36

NOTE: Support Beams are included in top price. An additional line item for the support beam will be included on the order acknowledgment at no charge.

BOAT SHAPE - ARC END, SQUARE CORNERS:

Boat Shape tops are available with Arc ends and Square corners. For Arc End, Square Corner tops replace model suffix with **5154**. e.g. **51641204842** becomes **51541204842**. Pricing is the same as standard tops.

BOAT SHAPE - STRAIGHT END, SQUARE CORNERS:

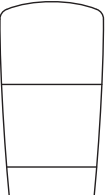
Boat Shape tops are available with Straight ends and square corners. For Straight End, Square Corner tops replace model suffix with **5104**. e.g. **51641204842** becomes **51041204842**. Pricing is the same as standard tops.

LAMINATE TABLE SECTIONS:

The number in brackets under table sections, refers to the number of sections when ordering laminate tops, if different than the number of sections for the same size wood top. Please note the grain direction of wood grain laminates will run lengthwise on 1 piece tops and crosswise on multiple piece table tops.

SEATING CAPACITY:

The number in brackets is the seating capacity when formed metal legs are used if different than the seating capacity when other bases are used.

Description	Model	Oak, Maple, Cherry	Walnut	L	W	Table Sections	Approximate Seating	Shipping Weight	Cubic Feet
	51681446042*	13083	14389	144	60/42	3	10	323	18
	51681686642	13909	15297	168	66/42	4	13	407	23
	51681926942	14994	16494	192	69/42	4	15	482	27
	51682167342	16333	17966	216	73/42	5	17	567	32
	51682407642	17508	19259	240	76/42	5	19	651	38

NOTE: Support Beams are included in top price. An additional line item for the support beam will be included on the order acknowledgment at no charge.

VISIO - ARC END, SQUARE CORNERS:

Visio Shape Tops with Arc Ends are available with square corners. For Arc End-Square corners, replace the model suffix with **5158**. e.g. **51681446042** becomes **51581446042**. Pricing is the same as standard tops.

VISIO - STRAIGHT END, SQUARE CORNERS:

Visio Shape Tops with Straight Ends are available with square corners. For Arc Straight End-Square corners, replace the model suffix with **5108**. e.g. **51681446042** becomes **51081446042**. Pricing is the same as standard tops.

ORDERING PROCEDURES

To order, please specify the following:

- 1) Table top shape, size, model number and wood species
- 2) Base model number
- 3) Console location and size option
- 4) Cross seam console model number, where applicable
- 5) Console power module and data options

DIMENSION KEY

L - Length

W - Width

Dimensions are in inches and approximate.

Contact Customer Service if dimensions are critical.

STANDARD FINISHES

For a complete list of standard wood finishes, please see page 347

BASE REQUIREMENTS

See page 60 for base requirements

CONSOLE SIZE & LOCATIONS

For information on Console locations and size options, see page 15 for wood and page 25 for laminate.

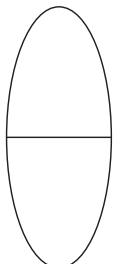
CONSOLE POWER/DATA MODULE OPTIONS

See page 49 for Console Module Options

TABLE SECTION SIZE

Section sizes can be calculated by dividing the table length by the # of sections

NUVO | OVAL, ARCED SQUARE & ROUND CONFERENCE TOPS

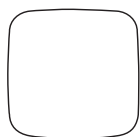
Description	Model	Laminate		L	W	Table Sections	Approximate Seating	Shipping Weight	Cubic Feet
		Oak, Maple, Cherry	Walnut						
	51598448	4503	4951	84	48	1	6	136	9
	51599648	5751	6325	96	48	2	8	157	10
	51599654	6232	6857	96	54	2	8	176	11
	515912048*	6850	7534	120	48	2 (3)	8	196	12
	515912060	7422	8163	120	60	3	10	243	15
	515914454	8537	9388	144	54	3	10	264	16
	515914460	8957	9853	144	60	3	12	292	18
	515916860	10206	11228	168	60	4	12	341	21

NOTE: Support Beams are included in top price. An additional line item for the support beam will be included on the order acknowledgment at no charge.

LAMINATE TABLE SECTIONS:

The number in brackets under table sections, refers to the number of sections when ordering laminate tops, if different than the number of sections for the same size wood top.

Arced Square Top

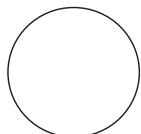


51663636	2033	2237	36	36	1	4	59	3
51664242	2243	2466	42	42	1	4	79	4
51664848	2530	2781	48	48	1	4	101	5
51665454	2860	3146	54	54	1	4	127	7
51666060	3706	4072	60	60	1	4	155	8

ARC SQUARE TOP - SQUARE CORNERS:

Arc Square tops are available with square corners. For Square Corner tops replace model suffix with **5156**. e.g. **51664242** becomes **51564242**. Pricing is the same as standard tops.

Round Top



510536	1988	2188	36 Dia.		1	3	47	3
510542	2197	2418	42 Dia.		1	3	63	4
510548	2470	2716	48 Dia.		1	4	80	5
510554	3192	3512	54 Dia.		1	5	100	7
510560	3718	4090	60 Dia.		1	5	123	8

ORDERING PROCEDURES

To order, please specify the following:

- 1) Table top shape, size, model number and wood species
- 2) Base model number
- 3) Console location and size option
- 4) Cross seam console model number, where applicable
- 5) Console power module and data options

DIMENSION KEY

- L - Length
 - W - Width
 - D - Depth
 - H - Height
- Dimensions are in inches and approximate.
Contact Customer Service if dimensions are critical.

STANDARD FINISHES

For a complete list of standard wood finishes, please see page 347

BASE REQUIREMENTS

See page 60 for base requirements

CONSOLE SIZE & LOCATIONS

For information on Console locations and size options, see page 15 for wood and page 25 for laminate.

CONSOLE POWER/DATA MODULE OPTIONS

See page 49 for Console Module Options

TABLE SECTION SIZE

Section sizes can be calculated by dividing the table length by the # of sections

NUVO | CONSOLE PLANNING FOR WOOD TOPS

CONSOLE ORDERING CODE (WITHIN THE TABLE SECTION - 4 CHARACTER CODE)

1st character specifies top sections from left to right on table: A, B, C, D, E, F

2nd character specifies console location within top section: M, I, L, R

M- Middle of top on one piece table

M- Middle of top section on multi section table

I - Inset 3" from seam on end sections

L- Left side of a one piece top

R- Right side of a one piece top

3rd and 4th characters specify console size: 14, 27, 36, 42, 50

Examples:

Table Size: 96" x 36"

AM42

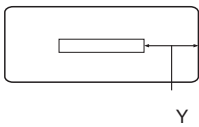


Table Size: 168" x 48"

AM14

BM50

CM14

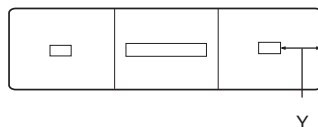


Table Size: 96 "x 36"

AL14

AR14

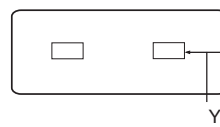
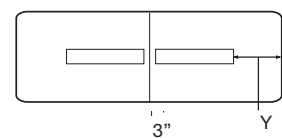


Table Size: 144" x 48"

AI42

BI42



Y= Dimension from end of table to end of console
18" or greater, cannot be less than 18"

CONSOLE ORDERING CODE (ACROSS SEAM - 5 CHARACTER CODE)

1st and 2nd character specifies section from left to right on table: AB, BC, CD, DE, EF

3rd character specifies console location across the seam: X

4th and 5th characters specify console size: 14, 27, 36, 42, 50

Examples:

Table Size: 288" x 60"

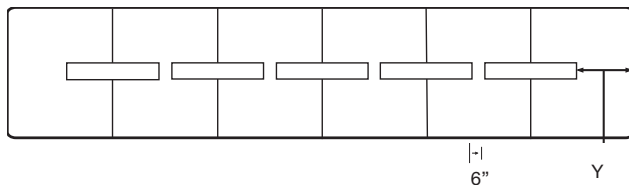
ABX42

BCX42

CDX42

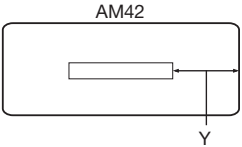
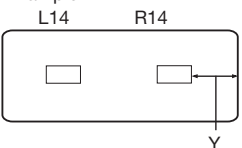
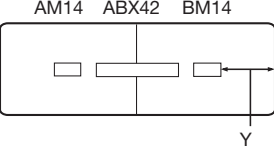
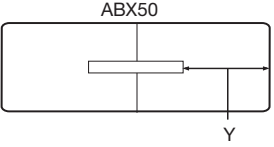
DEX42

EFX42



Y= Dimension from end of table to end of console

NUVO | CONSOLE SIZE & LOCATION - RECTANGULAR, ARC END, RACETRACK

Wood Top Console Options	Top Length	Console Options Top End Section	Console Options Within Top Center Section	Console Options Across Seam	Y	
WIDTHS 36" - 48"	60	M14			23	
60" - 84" X 36", 42", 48"	72	M14			29	
96" X 36"		M27			22.5	
Example	78	M14			32	
		M27			25.5	
		M36			21	
		M42			18	
	84	M14			35	
		M27			28.5	
		M36			24	
		M42			21	
	96	M14			41	
		M27			34.5	
		M36			30	
		M42			27	
		M50			23	
78" - 84" X 36", 42", 48"	78	L14 / R14			18	
96" X 36"	84	L14 / R14			18	
Example	96	L14 / R14			18	
						
96" - 144" X 42", 48"	96	M14			18	
Example	108	M14		X27	20	
		M14		X27	23	
		144	M14		X27 X36 X42	29
			M27		X27	22.5
96" - 144" X 42", 48"	96			X27	34.5	
Example				X36	30	
				X42	27	
				X50	23	
	108			X27	40.5	
				X36	36	
				X42	33	
				X50	29	
	120			X36	42	
				X42	39	
				X50	35	
	144			X50	47	

CODE KEY

M - Console location, middle of top section
 I - Console location, Inset 3" from seam on end sections
 X - Console location, across a seam of two top sections
 L - Console location, left side of a one piece top
 R - Console location, right side of a one piece top
 Y - Dimension from end of table to end of Console

Caution: Y greater than 30" makes access to Console Power/Data difficult from the end of the table

CONSOLE SIZE & LOCATIONS

See page 15 for information on console locations and size options for wood tops, and page 25 for laminate tops locations and sizes

CONSOLE MODULE OPTIONS

See page 49 for power / data options

ORDERING NOTES

Tops may be specified with fewer consoles and configurations other than shown. Consoles can be different sizes within the same top. Dimension from end of cut-out to table end cannot be less than 18".

NUVO | CONSOLE SIZE & LOCATION - RECTANGULAR, ARC END, RACETRACK

Wood Top Console Options	Top Length	Console Options Top End Section	Console Options Within Top Center Section	Console Options Across Seam	Y
WIDTHS 36" - 48"	96	I27			18
96" - 144" X 42", 48"	108	I27			24
Example	120	I27			30
AI42 BI42		I36			21
	144	I27			42
		I36			33
		I42			27
		I50			19
168" - 192" X 48"	168	M14	M14 M27 M36 M42 M50		21
		I27	M14 M27 M36 M42 M50		26
Example	192	M14	M14 M27 M36 M42 M50		25
AM14 BM50 CM14		I27	M14 M27 M36 M42 M50		34
		I36	M14 M27 M36 M42 M50		25
					34
					25
168" - 192" X 48"	168			X14	49
				X27	42.5
Example				X36	38
ABX50 BCX50				X42	35
	192			X50	31
					46
					43
					39
168" - 192" X 48"	168	M14	M14 M27 M36 M42		21
		I27	M14 M27 M36 M42		26
Example	192	M14	M14 M27 M36 M42 M50		25
AI27 BM42 CI27		I27	M14 M27 M36 M42 M50		34
WIDTHS 54" OR GREATER	108	I14	M14 M27		19
108" - 156" X 54", 60"	120	I14	M14 M27		23
Example	144	M14	M14 M27 M36 M42		18
AM14 BM42 CM14		I14	M14 M27 M36 M42		31
		I27	M14 M27 M36 M42		18
	156	M14	M14 M27 M36 M42		19
		I14	M14 M27 M36 M42		35
		I27	M14 M27 M36 M42		22

CODE KEY

M - Console location, middle of top section
 I - Console location, Inset 3" from seam on end sections
 X - Console location, across a seam of two top sections
 L - Console location, left side of a one piece top
 R - Console location, right side of a one piece top
 Y - Dimension from end of table to end of Console

Caution: Y greater than 30" makes access to Console Power/Data difficult from the end of the table

CONSOLE SIZE & LOCATIONS

See page 15 for information on console locations and size options for wood tops, and page 25 for laminate tops locations and sizes

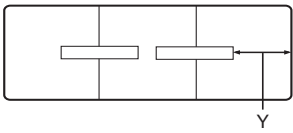
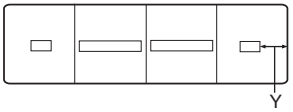
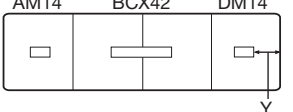
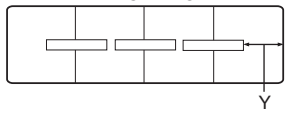
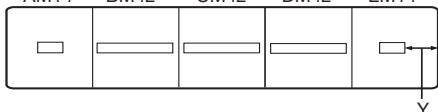
CONSOLE MODULE OPTIONS

See page 49 for power / data options

ORDERING NOTES

Tops may be specified with fewer consoles and configurations other than shown. Consoles can be different sizes within the same top. Dimension from end of cut-out to table end cannot be less than 18".

NUVO | CONSOLE SIZE & LOCATION - RECTANGULAR, ARC END, RACETRACK

Wood Top Console Options	Top Length	Console Options Top End Section	Console Options Within Top Center Section	Console Options Across Seam	Y
WIDTHS 54" OR GREATER	108			X27	22.5
108" - 156" X 54", 60"	120			X27	26.5
Example	144			X36 X42	30 27
	156			X36 X42	34 31
168"-192" X 54", 60"	168	I14	M14 M27 M36		25
Example	192	M14 I14 I27	M14 M27 M36 M42 M14 M27 M36 M42 M14 M27 M36 M42		18 31 18
	168" - 192" X 54", 60"	I14		X27 X36 X42	25
Example	192	M14 I14 I27		X36 X42 X36 X42 X36 X42	18 31 18
	168" - 192" x 54", 60"			X27 X36	28.5 24
Example	192			X27 X36 X42	34.5 30 27
	216"- 240" X 54", 60"	I14	M14 M27 M36		26
Example	240	M14 14 I27	M14 M27 M36 M42 M14 M27 M36 M42 M14 M27 M36 M42		18 31 18
					

CODE KEY

M - Console location, middle of top section
 I - Console location, Inset 3" from seam on end sections
 X - Console location, across a seam of two top sections
 L - Console location, left side of a one piece top
 R - Console location, right side of a one piece top
 Y- Dimension from end of table to end of Console

Caution: Y greater than 30" makes access to Console Power/Data difficult from the end of the table

CONSOLE SIZE & LOCATIONS

See page 15 for information on console locations and size options for wood tops, and page 25 for laminate tops locations and sizes

CONSOLE MODULE OPTIONS

See page 49 for power / data options

ORDERING NOTES

Tops may be specified with fewer consoles and configurations other than shown. Consoles can be different sizes within the same top. Dimension from end of cut-out to table end cannot be less than 18".

NUVO | CONSOLE SIZE & LOCATION - RECTANGULAR, ARC END, RACETRACK

Wood Top Console Options	Top Length	Console Options Top End Section	Console Options Within Top Center Section	Console Options Across Seam	Y
WIDTHS 54" OR GREATER	216			X27 X36	29.5 25
216" - 240" X 54", 60"					
Example	240			X27 X36 X42	34.5 30 27
ABX42 BCX42 CDX42 DEX42					
216" - 240" X 54", 60"	216		M14 M27 M36	X27	29.5
Example			M14 M27 M36	X36	25
ABX42 CM42 DEX42			M14 M27 M36	X42	22
	240		M14 M27 M36 M42	X27	34.5
			M14 M27 M36 M42	X36	30
			M14 M27 M36 M42	X42	27
			M14 M27 M36 M42	X50	23
264" - 288" X 60"	264	M14			18
Example		I14	M14 M27 M36		27
AM14 BM42 CM42 DM42 EM42 FM14	288	M14	M14 M27 M36 M42		18
		I14	M14 M27 M36 M42		31
		I27	M14 M27 M36 M42		18
264" - 288" X 60"	264	M14			18
Example		I14		X36 X42 X50	27
AM14 BCX42 DEX42 FM14	288	M14		X36 X42 X50	18
		I14		X36 X42 X50	31
		I27		X36 X42 X50	18
264" - 288" X 60"	264			X27	30.5
Example				X36	26
ABX42 BCX42 CDX42 DEX42 EFX42	288			X27	34.5
				X36	30
				X42	27
264" - 288" X 60"	264			X27	30.5
Example				X36	26
ABX42 CDX42 EFX42	288			X27	34.5
				X36	30
				X42	27
				X50	23

CODE KEY

M - Console location, middle of top section
 I - Console location, Inset 3" from seam on end sections
 X - Console location, across a seam of two top sections
 L - Console location, left side of a one piece top
 R - Console location, right side of a one piece top
 Y- Dimension from end of table to end of Console

Caution: Y greater than 30" makes access to Console Power/Data difficult from the end of the table

CONSOLE SIZE & LOCATIONS

See page 15 for information on console locations and size options for wood tops, and page 25 for laminate tops locations and sizes

CONSOLE MODULE OPTIONS

See page 49 for power / data options

ORDERING NOTES

Tops may be specified with fewer consoles and configurations other than shown. Consoles can be different sizes within the same top. Dimension from end of cut-out to table end cannot be less than 18".

NUVO | CONSOLE SIZE & LOCATION - BOAT SHAPED

Wood Top Console Options	Top Length	Console Options Top End Section	Console Options Within Top Center Section	Console Options Across Seam	Y
96" - 144" X 48"/42" 96" X 54"/42"	96	M14			18
Example	120	M14		X27	23
AM14 ABX42 BM14	144	M14 M27		X27 X36 X42	29 22.5
96" - 144" X 48"/42" 96" X 54"/42"	96			X27 X36 X42 X50	34.5 30 27 23
Example	120			X36 X42 X50	42 39 35
ABX50	144			X50	47
96" - 144" X 48"/42" 96" X 54"/42"	96	I27			18
Example	120	I27 I36			30 21
A142 BI42	144	I27 I36 I42 I50			42 33 27 19
120" - 144" x 54"/42"	120	I14	M14 M27		23
Example	144	M14 I14 I27	M14 M27 M36 M42 M14 M27 M36 M42 M14 M27 M36 M42		18 31 18
AM14 BM42 CM14					
120" - 144" x 54"/42"	120			X27 X36 X42	26.5 30 27
Example	144				
ABX42 BCX42					
168" - 192" X 54"/42"	168	I14	M14 M27 M36		25
Example	192	M14 I14 I27	M14 M27 M36 M42 M14 M27 M36 M42 M14 M27 M36 M42		18 31 18
AM14 BM42 CM42 DM14					

CODE KEY

M - Console location, middle of top section
 I - Console location, Inset 3" from seam on end sections
 X - Console location, across a seam of two top sections
 L - Console location, left side of a one piece top
 R - Console location, right side of a one piece top
 Y - Dimension from end of table to end of Console

Caution: Y greater than 30" makes access to Console Power/Data difficult from the end of the table

CONSOLE SIZE & LOCATIONS

See page 15 for information on console locations and size options for wood tops, and page 25 for laminate tops locations and sizes

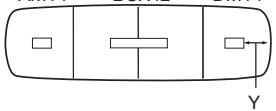
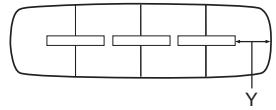
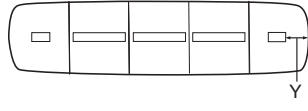
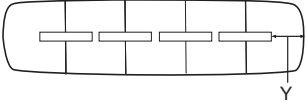
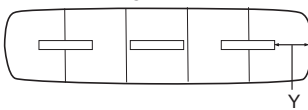
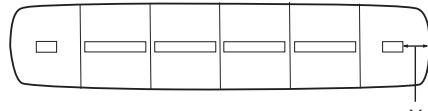
CONSOLE MODULE OPTIONS

See page 49 for power / data options

ORDERING NOTES

Tops may be specified with fewer consoles and configurations other than shown. Consoles can be different sizes within the same top. Dimension from end of cut-out to table end cannot be less than 18".

NUVO | CONSOLE SIZE & LOCATION - BOAT SHAPED

Wood Top Console Options	Top Length	Console Options Top End Section	Console Options Within Top Center Section	Console Options Across Seam	Y
168" - 192" X 54"/42"	168	I14		X27 X36 X42	25
Example	192	M14 I14 I27		X36 X42 X36 X42 X36 X42	18 31 18
					
168" - 192" X 54"/42"	168			X27 X36	28.5 24
Example	192			X27 X36 X42	34.5 30 27
					
216" - 240" X 60"/48"	216	I14	M14 M27 M36		26
Example	240	M14 I14 I27	M14 M27 M36 M42 M14 M27 M36 M42 M14 M27 M36 M42		18 31 18
					
216" - 240" X 60"/48"	216			X27 X36	29.5 24
Example	240			X27 X36 X42	34.5 30 27
					
216" - 240" X 60"/48"	216		M14 M27 M36 M14 M27 M36 M14 M27 M36	X27 X36 X42	29.5 25 22
Example	240		M14 M27 M36 M42 M14 M27 M36 M42 M14 M27 M36 M42 M14 M27 M36 M42	X27 X36 X42 X50	34.5 30 27 23
					
264" - 288" X 60"/48"	264	M14 I14	M14 M36		18 27
Example	288	M14 I14 I27	M14 M36 M42 M14 M36 M42 M14 M36 M42		18 31 18
					

CODE KEY

M - Console location, middle of top section
 I - Console location, Inset 3" from seam on end sections
 X - Console location, across a seam of two top sections
 L - Console location, left side of a one piece top
 R - Console location, right side of a one piece top
 Y - Dimension from end of table to end of Console

Caution: Y greater than 30" makes access to Console Power/Data difficult from the end of the table

CONSOLE SIZE & LOCATIONS

See page 15 for information on console locations and size options for wood tops, and page 25 for laminate tops locations and sizes

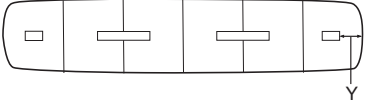
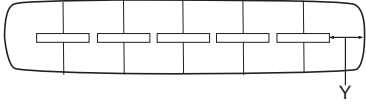
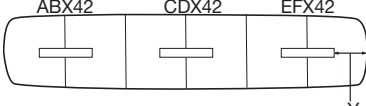
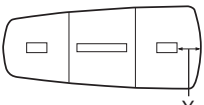
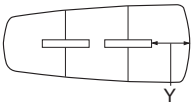
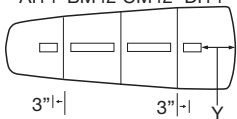
CONSOLE MODULE OPTIONS

See page 49 for power / data options

ORDERING NOTES

Tops may be specified with fewer consoles and configurations other than shown. Consoles can be different sizes within the same top. Dimension from end of cut-out to table end cannot be less than 18".

NUVO | CONSOLE SIZE & LOCATION - BOAT SHAPED & VISIO

Wood Top Console Options	Top Length	Console Options Top End Section	Console Options Within Top Center Section	Console Options Across Seam	Y
264" - 288" X 60"/48"	264	M14 I14		X36 X42 X50	18 27
Example					
AM14 BCX42 DEX42 FM14	288	M14 I14 I27		X36 X42 X50 X36 X42 X50 X36 X42 X50	18 31 18
					
264" - 288" X 60"/48"	264			X27 X36	30.5 26
Example	288			X27 X36 X42	34.5 30 27
					
264" - 288" X 60"/48"	264			X27 X36 X42	30.5 26 23
Example	288			X27 X36 X42 X50	34.5 30 27 23
					
120" - 144" X 60"/42"	120	I14	M14 M27		23
Example					
AM14 BM42 CM14	144	M14 I27	M14 M27 M36 M42 M14 M27 M36 M42		18 18
					
120" - 144" X 60/42	120			X27	26.5
Example					
ABX42 BCX42	144			X36 X42	30 27
					
168" X 66/42" 192" X 69/42"	168	I14	M14 M27 M36		25
Example					
AI14 BM42 CM42 DI14	192	M14 I27	M14 M27 M36 M42 M14 M27 M36 M42		18 18
					

CODE KEY

M - Console location, middle of top section
 I - Console location, Inset 3" from seam on end sections
 X - Console location, across a seam of two top sections
 L - Console location, left side of a one piece top
 R - Console location, right side of a one piece top
 Y - Dimension from end of table to end of Console

Caution: Y greater than 30" makes access to Console Power/Data difficult from the end of the table

CONSOLE SIZE & LOCATIONS

See page 15 for information on console locations and size options for wood tops, and page 25 for laminate tops locations and sizes

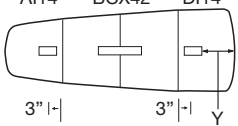
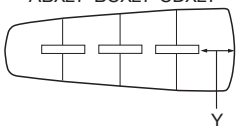
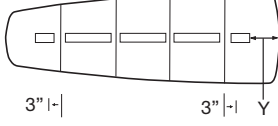
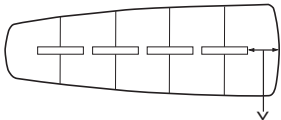
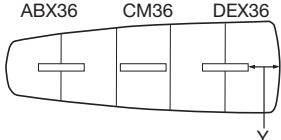
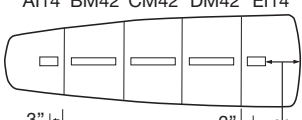
CONSOLE MODULE OPTIONS

See page 49 for power / data options

ORDERING NOTES

Tops may be specified with fewer consoles and configurations other than shown. Consoles can be different sizes within the same top. Dimension from end of cut-out to table end cannot be less than 18".

NUVO | CONSOLE SIZE & LOCATION - VISIO

Wood Top Console Options	Top Length	Console Options Top End Section	Console Options Within Top Center Section	Console Options Across Seam	Y
168" X 66/42"	168	I14		X27 X36 X42 X50	25
192" X 69/42" AI14 BCX42 DI14	192	M14 I27		X27 X36 X42 X50 X27 X36 X42 X50	18 18
					
168" X 66/42" 192" X 69/42"	168			X27	28.5
Example ABX27 BCX27 CDX27	192			X27	28.5
					
216" X 73"/42"	216	I14	M14 M27 M36		26
Example AI14 BM36 CM36 DM36 EI14					
					
216" X 73"/42"	216			X27 X36	25.5 25
ABX36 BCX36 CDX36 DEX36					
					
216" X 73"/42"	216		M14 M27 M36 M14 M27 M36 M14 M27 M36	X27 X36 X42	30 25 22
Example ABX36 CM36 DEX36					
					
240" X 76"/42"	240	M14 I14 I27	M14 M27 M36 M42 M14 M27 M36 M42 M14 M27 M36 M42		18 31 18
Example AI14 BM42 CM42 DM42 EI14					
					

CODE KEY

- M - Console location, middle of top section
- I - Console location, Inset 3" from seam on end sections
- X - Console location, across a seam of two top sections
- L - Console location, left side of a one piece top
- R - Console location, right side of a one piece top
- Y - Dimension from end of table to end of Console

Caution: Y greater than 30" makes access to Console Power/Data difficult from the end of the table

CONSOLE SIZE & LOCATIONS

See page 15 for information on console locations and size options for wood tops, and page 25 for laminate tops locations and sizes

CONSOLE MODULE OPTIONS

See page 49 for power / data options

ORDERING NOTES

Tops may be specified with fewer consoles and configurations other than shown. Consoles can be different sizes within the same top. Dimension from end of cut-out to table end cannot be less than 18".

NUVO | CONSOLE SIZE & LOCATION - VISIO & OVAL

Wood Top Console Options	Top Length	Console Options Top End Section	Console Options Within Top Center Section	Console Options Across Seam	Y
240" X 76"/42" Example ABX42 BCX42 CDX42 DEX42	240			X27 X36 X42	34.5 30 27
84" x 48" Example AM42	84	M14 M27 M36 M42			35 28.5 24 21
84" x 48" Example AL14 AR14	84	L14/R14			18
96" - 120" X 48" 96" X 54" AM14 ABX27 BM14	96 120	M14 M14		X27	18 23
96" - 120" X 48" 96" X 54" Example ABX42	96 120			X27 X36 X42 X50 X36 X42 X50	34.5 30 27 23 42 39 35
96" - 120" X 48" 96" X 54" AI36 BI36	96 120	I27 I36			18 30 21

CODE KEY

M - Console location, middle of top section
 I - Console location, Inset 3" from seam on end sections
 X - Console location, across a seam of two top sections
 L - Console location, left side of a one piece top
 R - Console location, right side of a one piece top
 Y - Dimension from end of table to end of Console

Caution: Y greater than 30" makes access to Console Power/Data difficult from the end of the table

CONSOLE SIZE & LOCATIONS

See page 15 for information on console locations and size options for wood tops, and page 25 for laminate tops locations and sizes

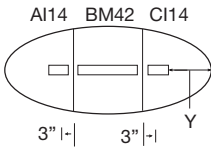
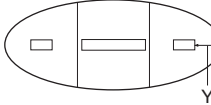
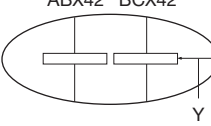
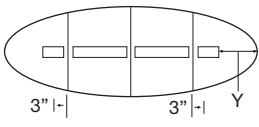
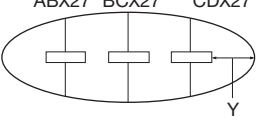
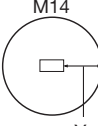
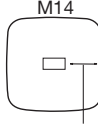
CONSOLE MODULE OPTIONS

See page 49 for power / data options

ORDERING NOTES

Tops may be specified with fewer consoles and configurations other than shown. Consoles can be different sizes within the same top. Dimension from end of cut-out to table end cannot be less than 18".

NUVO | CONSOLE SIZE & LOCATION - OVAL, ROUND, ARCED SQUARE

Wood Top Console Options	Top Length	Console Options Top End Section	Console Options Within Top Center Section	Console Options Across Seam	Y
144" X 54"	144	M14 I14 I27	M14 M27 M36 M42 M14 M27 M36 M42 M14 M27 M36 M42		18 31 18
Example AI14 BM42 CI14 					
120" - 144" X 60"	120	I14	M14 M27		23
Example AM14 BM42 CM14 	144	M14 I14 I27	M14 M27 M36 M42 M14 M27 M36 M42 M14 M27 M36 M42		18 31 18
120" - 144" X 60" 144" X 54"	120			X27	26.5
Example ABX42 BCX42 	144			X36 X42	30 27
168" X 60"	168	I14	M14 M27 M36		25
Example AI14 BM36 CM36 DI14 					
168" X 60"	168			X27 X36	28.5 24
Example ABX27 BCX27 CDX27 					
36" - 60"	36	M14			11
Examples M14 	42	M14			14
M14 	48	M14			17
	54	M14			20
	60	M14			23

CODE KEY

M - Console location, middle of top section
 I - Console location, Inset 3" from seam on end sections
 X - Console location, across a seam of two top sections
 L - Console location, left side of a one piece top
 R - Console location, right side of a one piece top
 Y - Dimension from end of table to end of Console

Caution: Y greater than 30" makes access to Console Power/Data difficult from the end of the table

CONSOLE SIZE & LOCATIONS

See page 15 for information on console locations and size options for wood tops, and page 25 for laminate tops locations and sizes

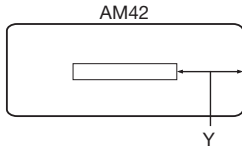
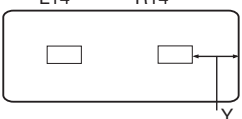
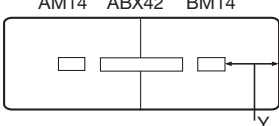
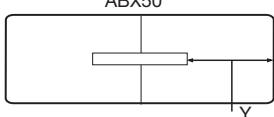
CONSOLE MODULE OPTIONS

See page 49 for power / data options

ORDERING NOTES

Tops may be specified with fewer consoles and configurations other than shown. Consoles can be different sizes within the same top. Dimension from end of cut-out to table end cannot be less than 18".

NUVO | CONSOLE SIZE & LOCATION - RECTANGULAR, ARC END, RACETRACK

Laminate Top Console Options	Top Length	Console Options Top End Section	Console Options Within Top Center Section	Console Options Across Seam	Y	
WIDTHS 36" - 48"	60	M14			23	
60" - 84" X 36", 42", 48"	72	M14			29	
96" X 36"		M27			22.5	
Example	78	M14			32	
		M27			25.5	
		M36			21	
		M42			18	
	84	M14			35	
		M27			28.5	
		M36			24	
		M42			21	
	96	M14			41	
		M27			34.5	
		M36			30	
		M42			27	
		M50			23	
<hr/>						
78" - 84" X 36", 42", 48"	78	L14 / R14			18	
96" X 36"						
Example	84	L14 / R14			18	
		L14 / R14			18	
	96	L14 / R14			18	
<hr/>						
96" X 42", 48"						
Example	96	M14			18	
						
		AM14				
		ABX42				
		BM14				
<hr/>						
96" X 42", 48"						
Example						
						
		ABX50				
			X27		34.5	
			X36		30	
		X42		27		
		X50		23		

CODE KEY

M - Console location, middle of top section
 I - Console location, Inset 3" from seam on end sections
 X - Console location, across a seam of two top sections
 L - Console location, left side of a one piece top
 R - Console location, right side of a one piece top
 Y - Dimension from end of table to end of Console

Caution: Y greater than 30" makes access to Console Power/Data difficult from the end of the table

CONSOLE SIZE & LOCATIONS

See page 15 for information on console locations and size options for wood tops, and page 25 for laminate tops locations and sizes

CONSOLE MODULE OPTIONS

See page 49 for power / data options

ORDERING NOTES

Tops may be specified with fewer consoles and configurations other than shown. Consoles can be different sizes within the same top. Dimension from end of cut-out to table end cannot be less than 18".

NUVO | CONSOLE SIZE & LOCATION - RECTANGULAR, ARC END, RACETRACK

Laminate Top Console Options	Top Length	Console Options Top End Section	Console Options Within Top Center Section	Console Options Across Seam	Y
WIDTHS 42" - 60"	96	I27			18
96" X 42", 48"					
Example					
108"-144" X 42", 48", 54", 60"	108	I14	M14 M27	19	
Example	120	M14 I14	M14 M27 M14 M27		23
	144	M14 I14 I27	M14 M27 M36 M42 M14 M27 M36 M42 M14 M27 M36 M42		18 31 18
108"-144" X 42", 48", 54", 60"	108			X27	22.5
Example	120			X27	26.5
	144			X36 X42	30 27
156"-192" X 48", 54", 60"	156	I14	M14 M27		22
Example	168	I14	M14 M27 M36		25
	192	M14 I14 I27	M14 M27 M36 M42 M14 M27 M36 M42 M14 M27 M36 M42		18 31 18

CODE KEY

M - Console location, middle of top section
 I - Console location, Inset 3" from seam on end sections
 X - Console location, across a seam of two top sections
 L - Console location, left side of a one piece top
 R - Console location, right side of a one piece top
 Y - Dimension from end of table to end of Console

Caution: Y greater than 30" makes access to Console Power/Data difficult from the end of the table

CONSOLE SIZE & LOCATIONS

See page 15 for information on console locations and size options for wood tops, and page 25 for laminate tops locations and sizes

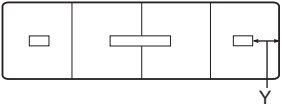
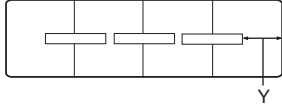
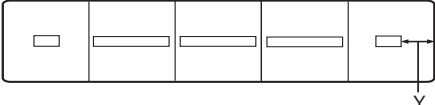
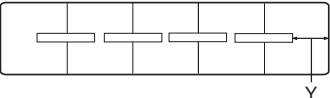
CONSOLE MODULE OPTIONS

See page 49 for power / data options

ORDERING NOTES

Tops may be specified with fewer consoles and configurations other than shown. Consoles can be different sizes within the same top. Dimension from end of cut-out to table end cannot be less than 18".

NUVO | CONSOLE SIZE & LOCATION - RECTANGULAR, ARC END, RACETRACK

Laminate Top Console Options	Top Length	Console Options Top End Section	Console Options Within Top Center Section	Console Options Across Seam	Y
WIDTHS 54" OR GREATER					
156" - 192" X 48" 54", 60"	156	I14		X27 X36 X42	22
Example	168	I14		X27 X36	25
AM14 BCX42 DM14	192	M14 I14 I27		X36 X42 X36 X42 X36 X42	18 31 18
					
<hr/>					
156" - 192" x 48" 54", 60"	156			X27 X36	25.5 21
Example	168			X27 X36	28.5 24
ABX42 BCX42 CDX42	192			X27 X36 X42	34.5 30 27
					
<hr/>					
216" - 240" X 54", 60"	216	I14	M14 M27 M36		26
	240	M14 14 I27	M14 M27 M36 M42 M14 M27 M36 M42 M14 M27 M36 M42		18 31 18
Example					
AM14 BM42 CM42 DM42 EM14					
					
<hr/>					
216" - 240" X 54", 60"	216			X27 X36	29.5 25
Example	240			X27 X36 X42	34.5 30 27
ABX42 BCX42 CDX42 DEX42					
					

CODE KEY

M - Console location, middle of top section
 I - Console location, Inset 3" from seam on end sections
 X - Console location, across a seam of two top sections
 L - Console location, left side of a one piece top
 R - Console location, right side of a one piece top
 Y- Dimension from end of table to end of Console

Caution: Y greater than 30" makes access to Console Power/Data difficult from the end of the table

CONSOLE SIZE & LOCATIONS

See page 15 for information on console locations and size options for wood tops, and page 25 for laminate tops locations and sizes

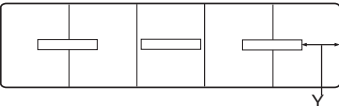
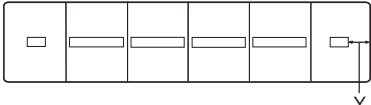
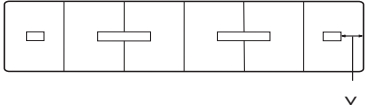
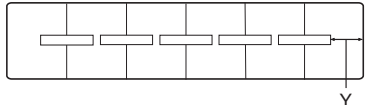
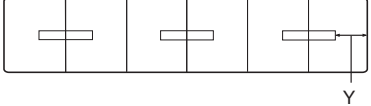
CONSOLE MODULE OPTIONS

See page 49 for power / data options

ORDERING NOTES

Tops may be specified with fewer consoles and configurations other than shown. Consoles can be different sizes within the same top. Dimension from end of cut-out to table end cannot be less than 18".

NUVO | CONSOLE SIZE & LOCATION - RECTANGULAR, ARC END, RACETRACK

Laminate Top Console Options	Top Length	Console Options Top End Section	Console Options Within Top Center Section	Console Options Across Seam	Y
WIDTHS 54" OR GREATER	216		M14 M27 M36	X27	29.5
216" - 240" X 54", 60"			M14 M27 M36	X36	25
Example			M14 M27 M36	X42	22
ABX42 CM42 DEX42	240		M14 M27 M36 M42	X27	34.5
			M14 M27 M36 M42	X36	30
			M14 M27 M36 M42	X42	27
			M14 M27 M36 M42	X50	23
264" - 288" X 60"	264	M14			18
Example		I14	M14 M27 M36		27
AM14 BM42 CM42 DM42 EM42 FM14	288	M14	M14 M27 M36 M42		18
		I14	M14 M27 M36 M42		31
		I27	M14 M27 M36 M42		18
264" - 288" X 60"	264	M14			18
Example		I14		X36 X42 X50	27
AM14 BCX42 DEX42 FM14	288	M14		X36 X42 X50	18
		I14		X36 X42 X50	31
		I27		X36 X42 X50	18
264" - 288" X 60"	264			X27	30.5
Example				X36	26
ABX42 BCX42 CDX42 DEX42 EFX42	288			X27	34.5
				X36	30
				X42	27
264" - 288" X 60"	264			X27	30.5
Example				X36	26
ABX42 CDX42 EFX42	288			X42	23
				X27	34.5
				X36	30
				X42	27
				X50	23

CODE KEY

M - Console location, middle of top section
 I - Console location, Inset 3" from seam on end sections
 X - Console location, across a seam of two top sections
 L - Console location, left side of a one piece top
 R - Console location, right side of a one piece top
 Y - Dimension from end of table to end of Console

Caution: Y greater than 30" makes access to Console Power/Data difficult from the end of the table

CONSOLE SIZE & LOCATIONS

See page 15 for information on console locations and size options for wood tops, and page 29 for laminate tops locations and sizes

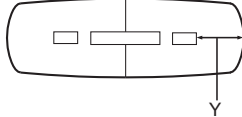
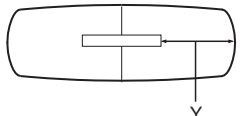
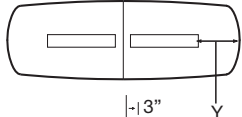
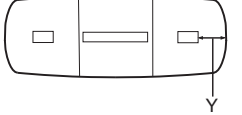
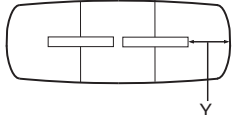
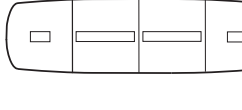
CONSOLE MODULE OPTIONS

See page 49 for power / data options

ORDERING NOTES

Tops may be specified with fewer consoles and configurations other than shown. Consoles can be different sizes within the same top. Dimension from end of cut-out to table end cannot be less than 18".

NUVO | CONSOLE SIZE & LOCATION - BOAT SHAPED

Laminate Top Console Options	Top Length	Console Options Top End Section	Console Options Within Top Center Section	Console Options Across Seam	Y
96" - 144" X 48"/42" 96" X 54"/42"	96	M14			18
Example AM14 ABX42 BM14					
					
96" - 144" X 48"/42" 96" X 54"/42"	96			X27 X36 X42 X50	34.5 30 27 23
Example ABX50					
					
96" - 144" X 48"/42" 96" X 54"/42"	96	I27			18
Example AI42 BI42					
					
120" - 144" x 54"/42"	120	I14	M14 M27		23
Example AM14 BM42 CM14	144	M14 I14 I27	M14 M27 M36 M42 M14 M27 M36 M42 M14 M27 M36 M42		18 31 18
					
120" - 144" x 54"/42"	120			X27 X36 X42	26.5 30 27
Example ABX42 BCX42	144				
					
168" - 192" X 54"/42"	168	I14	M14 M27 M36		25
Example AM14 BM42 CM42 DM14	192	M14 I14 I27	M14 M27 M36 M42 M14 M27 M36 M42 M14 M27 M36 M42		18 31 18
					

CODE KEY

M - Console location, middle of top section
 I - Console location, Inset 3" from seam on end sections
 X - Console location, across a seam of two top sections
 L - Console location, left side of a one piece top
 R - Console location, right side of a one piece top
 Y- Dimension from end of table to end of Console

Caution: Y greater than 30" makes access to Console Power/Data difficult from the end of the table

CONSOLE SIZE & LOCATIONS

See page 15 for information on console locations and size options for wood tops, and page 25 for laminate tops locations and sizes

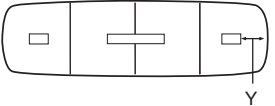
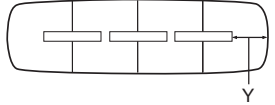
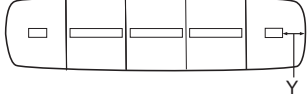
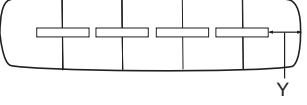
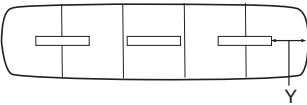
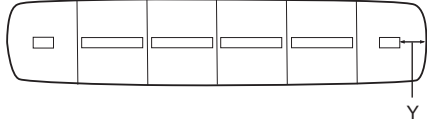
CONSOLE MODULE OPTIONS

See page 49 for power / data options

ORDERING NOTES

Tops may be specified with fewer consoles and configurations other than shown. Consoles can be different sizes within the same top. Dimension from end of cut-out to table end cannot be less than 18".

NUVO | CONSOLE SIZE & LOCATION - BOAT SHAPED

Laminate Top Console Options	Top Length	Console Options Top End Section		Console Options Within Top Center Section		Console Options Across Seam		Y	
168" - 192" X 54"/42"	168	I14				X27	X36	X42	25
Example	192	M14				X36	X42		18
AM14 BCX42 DM14		I14				X36	X42		31
		I27				X36	X42		18
168" - 192" X 54"/42"	168					X27			28.5
Example	192					X36			24
ABX42 BCX42 CDX42						X27			34.5
						X36			30
						X42			27
216" - 240" X 60"/48"	216	I14	M14	M27	M36				26
Example	240	M14	M14	M27	M36	M42			18
AM14 BM42 CM42 DM42 EM14		I14	M14	M27	M36	M42			31
		I27	M14	M27	M36	M42			18
216" - 240" X 60"/48"	216					X27			29.5
Example	240					X36			24
ABX42 BCX42 CDX42 DEX42						X27			34.5
						X36			30
						X42			27
216" - 240" X 60"/48"	216		M14	M27	M36	X27			29.5
Example	240		M14	M27	M36	X36			25
ABX42 CM42 DEX42			M14	M27	M36	X42			22
			M14	M27	M36	M42	X27		34.5
			M14	M27	M36	M42	X36		30
			M14	M27	M36	M42	X42		27
			M14	M27	M36	M42	X50		23
264" - 288" X 60"/48"	264	M14							18
Example	288	I14	M14	M36					27
AM14 BM42 CM42 DM42 EM42 FM14		M14	M14	M36	M42				18
		I14	M14	M36	M42				31
		I27	M14	M36	M42				18

CODE KEY

- M - Console location, middle of top section
- I - Console location, Inset 3" from seam on end sections
- X - Console location, across a seam of two top sections
- L - Console location, left side of a one piece top
- R - Console location, right side of a one piece top
- Y - Dimension from end of table to end of Console

Caution: Y greater than 30" makes access to Console Power/Data difficult from the end of the table

CONSOLE SIZE & LOCATIONS

See page 15 for information on console locations and size options for wood tops, and page 25 for laminate tops locations and sizes

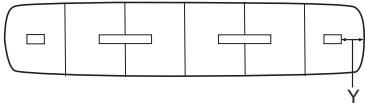
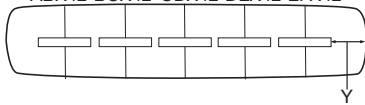
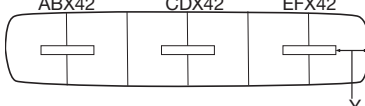
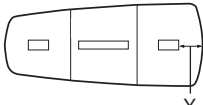
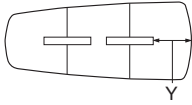
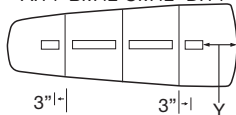
CONSOLE MODULE OPTIONS

See page 49 for power / data options

ORDERING NOTES

Tops may be specified with fewer consoles and configurations other than shown. Consoles can be different sizes within the same top. Dimension from end of cut-out to table end cannot be less than 18".

NUVO | CONSOLE SIZE & LOCATION - BOAT SHAPED & VISIO

Laminate Top Console Options	Top Length	Console Options Top End Section	Console Options Within Top Center Section	Console Options Across Seam	Y
264" - 288" X 60"/48"	264	M14 I14		X36 X42 X50	18 27
Example					
AM14 BCX42 DEX42 FM14	288	M14 I14 I27		X36 X42 X50 X36 X42 X50	18 31 18
					
264" - 288" X 60"/48"	264			X27 X36	30.5 26
Example	288			X27 X36 X42	34.5 30 27
ABX42 BCX42 CDX42 DEX42 EFX42					
					
264" - 288" X 60"/48"	264			X27 X36 X42	30.5 26 23
Example	288			X27 X36 X42 X50	34.5 30 27 23
ABX42 CDX42 EFX42					
					
120" - 144" X 60"/42"	120	I14	M14 M27		23
Example	144	M14 I27	M14 M27 M36 M42 M14 M27 M36 M42		18 18
AM14 BM42 CM14					
					
120" - 144" X 60/42	120			X27	26.5
Example	144			X36 X42	30 27
ABX42 BCX42					
					
168" X 66/42" 192" X 69/42"	168	I14	M14 M27 M36		25
Example	192	M14 I27	M14 M27 M36 M42 M14 M27 M36 M42		18 18
AI14 BM42 CM42 DI14					
					

CODE KEY

M - Console location, middle of top section
 I - Console location, Inset 3" from seam on end sections
 X - Console location, across a seam of two top sections
 L - Console location, left side of a one piece top
 R - Console location, right side of a one piece top
 Y - Dimension from end of table to end of Console

Caution: Y greater than 30" makes access to Console Power/Data difficult from the end of the table

CONSOLE SIZE & LOCATIONS

See page 15 for information on console locations and size options for wood tops, and page 25 for laminate tops locations and sizes

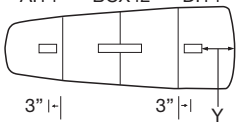
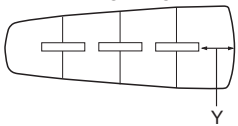
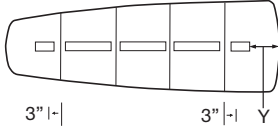
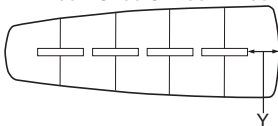
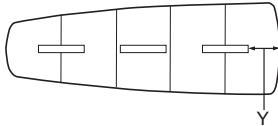
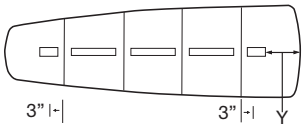
CONSOLE MODULE OPTIONS

See page 49 for power / data options

ORDERING NOTES

Tops may be specified with fewer consoles and configurations other than shown. Consoles can be different sizes within the same top. Dimension from end of cut-out to table end cannot be less than 18".

NUVO | CONSOLE SIZE & LOCATION - VISIO

Laminate Top Console Options	Top Length	Console Options Top End Section	Console Options Within Top Center Section	Console Options Across Seam	Y
168" X 66/42"	168	I14		X27 X36 X42 X50	25
192" X 69/42"	192	M14 I27		X27 X36 X42 X50	18 18
					
168" X 66/42" 192" X 69/42"	168			X27	28.5
Example ABX27 BCX27 CDX27	192			X27	28.5
					
216" X 73"/42"	216	I14	M14 M27 M36		26
Example AI14 BM36 CM36 DM36 EI14					
					
216" X 73"/42"	216			X27 X36	25.5 25
					
216" X 73"/42"	216		M14 M27 M36	X27 X36	30 25
Example ABX36 CM36 DEX36			M14 M27 M36	X42	22
					
240" X 76"/42"	240	M14 I14 I27	M14 M27 M36 M42 M14 M27 M36 M42 M14 M27 M36 M42		18 31 18
Example AI14 BM42 CM42 DM42 EI14					
					

CODE KEY

- M - Console location, middle of top section
- I - Console location, Inset 3" from seam on end sections
- X - Console location, across a seam of two top sections
- L - Console location, left side of a one piece top
- R - Console location, right side of a one piece top
- Y - Dimension from end of table to end of Console

Caution: Y greater than 30" makes access to Console Power/Data difficult from the end of the table

CONSOLE SIZE & LOCATIONS

See page 15 for information on console locations and size options for wood tops, and page 25 for laminate tops locations and sizes

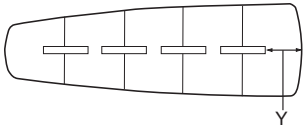
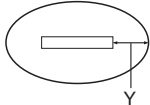
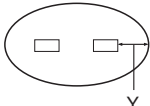
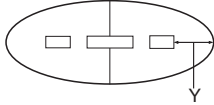
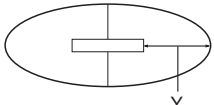
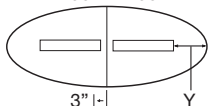
CONSOLE MODULE OPTIONS

See page 49 for power / data options

ORDERING NOTES

Tops may be specified with fewer consoles and configurations other than shown. Consoles can be different sizes within the same top. Dimension from end of cut-out to table end cannot be less than 18".

NUVO | CONSOLE SIZE & LOCATION - VISIO & OVAL

Laminate Top Console Options	Top Length	Console Options Top End Section	Console Options Within Top Center Section	Console Options Across Seam	Y
240" X 76"/42" Example ABX42 BCX42 CDX42 DEX42	240			X27 X36 X42	34.5 30 27
					
84" x 48" Example AM42	84	M14 M27 M36 M42			35 28.5 24 21
					
84" x 48" Example AL14 AR14	84	L14/R14			18
					
96" - 120" X 48" 96" X 54" AM14 ABX27 BM14	96 120	M14 M14		X27	18 23
					
96" - 120" X 48" 96" X 54" Example ABX42	96 120			X27 X36 X42 X50 X36 X42 X50	34.5 30 27 23 42 39 35
					
96" - 120" X 48" 96" X 54" AI36 BI36	96 120	I27 I36			18 30 21
					

CODE KEY

M - Console location, middle of top section
 I - Console location, Inset 3" from seam on end sections
 X - Console location, across a seam of two top sections
 L - Console location, left side of a one piece top
 R - Console location, right side of a one piece top
 Y- Dimension from end of table to end of Console

Caution: Y greater than 30" makes access to Console Power/Data difficult from the end of the table

CONSOLE SIZE & LOCATIONS

See page 15 for information on console locations and size options for wood tops, and page 25 for laminate tops locations and sizes

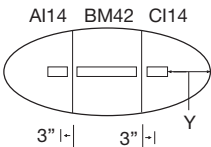
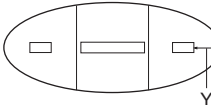
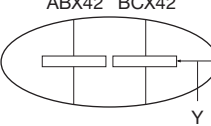
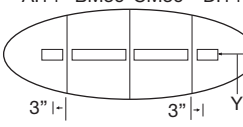
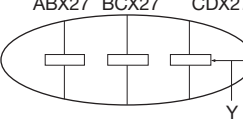
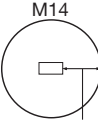
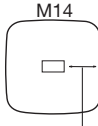
CONSOLE MODULE OPTIONS

See page 49 for power / data options

ORDERING NOTES

Tops may be specified with fewer consoles and configurations other than shown. Consoles can be different sizes within the same top. Dimension from end of cut-out to table end cannot be less than 18".

NUVO | CONSOLE SIZE & LOCATION - OVAL, ROUND, ARCED SQUARE

Laminate Top Console Options	Top Length	Console Options Top End Section	Console Options Within Top Center Section	Console Options Across Seam	Y
144" X 54"	144	M14 I14 I27	M14 M27 M36 M42 M14 M27 M36 M42 M14 M27 M36 M42		18 31 18
Example AI14 BM42 CI14					
					
120" - 144" X 60"	120	I14	M14 M27		23
Example	144	M14 I14 I27	M14 M27 M36 M42 M14 M27 M36 M42 M14 M27 M36 M42		18 31 18
Example AM14 BM42 CM14					
					
120" - 144" X 60" 144" X 54"	120			X27	26.5
Example	144			X36 X42	30 27
Example ABX42 BCX42					
					
168" X 60"	168	I14	M14 M27 M36		25
Example					
Example AI14 BM36 CM36 DI14					
					
168" X 60"	168			X27 X36	28.5 24
Example					
Example ABX27 BCX27 CDX27					
					
36" - 60"	36	M14			11
Examples	42	M14			14
	48	M14			17
	54	M14			20
	60	M14			23

CODE KEY

M - Console location, middle of top section
 I - Console location, Inset 3" from seam on end sections
 X - Console location, across a seam of two top sections
 L - Console location, left side of a one piece top
 R - Console location, right side of a one piece top
 Y - Dimension from end of table to end of Console

Caution: Y greater than 30" makes access to Console Power/Data difficult from the end of the table

CONSOLE SIZE & LOCATIONS

See page 15 for information on console locations and size options for wood tops, and page 25 for laminate tops locations and sizes

CONSOLE MODULE OPTIONS

See page 49 for power / data options


ORDERING NOTES

Tops may be specified with fewer consoles and configurations other than shown. Consoles can be different sizes within the same top. Dimension from end of cut-out to table end cannot be less than 18".

NUVO | CONSOLES FOR WOOD & LAMINATE TOPS

CONSOLE - WITHIN A TOP SECTION


Consoles located within a top section are factory installed. The model numbers are determined by the location within each section and the size. For example, when ordering a rectangular top 96" x 54" a console M14 can be specified in both the A and/or B section of the table. When ordering, simply add AM14 and BM14 to your purchase order and add the list price for each console to your order.

Description	Model	Console size	Price	Weights	Cubes
	M14, I14, L14,R14	14	265	3	.25
	M27, I27	27	295	4	.25
	M36, I36	36	333	5	.25
	M42, I42	42	363	5.5	0.5
	M50, I50	50	402	6	0.5

Consoles are available in 5 standard lengths.

CONSOLE - ACROSS SEAMS

Consoles located across the seam are field installed and have separate model numbers that need to be included on your purchase order along with the desired console position. For example, when ordering a rectangular top 120" x 54" with a console across the seam, purchase orders need to specify the model number for the console (51CONSOLEX27) and the location ABX27.

Description	Model	Console size	Price	Weights	Cubes
	51CONSOLE-X14	14	265	3	0.25
	51CONSOLE-X27	27	295	4	0.25
	51CONSOLE-X36	36	333	5	0.25
	51CONSOLE-X42	42	363	5.5	0.5
	51CONSOLE-X50	50	402	6	0.5

Consoles are available in 5 standard lengths.

Note: 50" Consoles have 3 lid supports, while all other sized have 2.

CONSOLE POWER/DATA MODULES

Console modules provide an extensive range of power, data and audio-visual solutions for today's conferencing environments. Console modules are available in 18 preconfigured data and power options, or alternatively console modules with just electrical ports can be selected allowing units to be designed and built specifically to meet your connectivity needs by using the Snap-in or Plate mounted port options.

Consoles are available with 3 power options in both preconfigured & custom console modules.

Power Module A (PMA) consists of 2 duplex receptacles with 3 cord lengths 6', 16' & 25'.

Power Module B (PMB) consists of 1 duplex receptacle with 3 cord lengths 6', 16' & 25'.

Power Module C (PMC) consists of 2 duplex receptacles with a utility outlet & circuit breaker with 2 cord lengths 6' & 16'.

The utility outlet in Module C allows another power module within the table to be plugged into it resulting in 1 cord going to the power source for both modules, as well as circuit protection for both modules. This also means shorter cord lengths can be specified resulting in a more cost effective power solution. Krug recommends the use of Module C's on the Console at the end of the table or location in the table nearest the power source.

Examples:

120" table with 2 consoles & the power source at right end.

Use a PMC06 in the 1st console from the right & the cord goes to power source.

Use a PMA06 in the 2nd console from the right & the cord goes to the utility outlet of the first console module.

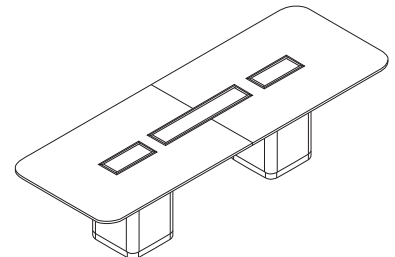
168" table with 4 consoles & power source at right hand end.

Use a PMC06 in the 1st console from the right & the cord goes to power source.

Use a PMC06 in the 2nd console from the right & the cord goes to power source.

Use a PMA06 in the 3rd console from the right & the cord goes to utility the outlet in the 1st console module.

Use a PMA06 in the 4th console from the right & the cord goes to utility the outlet in the 2nd console module.



CODE KEY

M - Console location, middle of top section

I - Console location, Inset 3" from seam on end sections

X - Console location, across a seam of two top sections

L - Console location, left side of a one piece top

R - Console location, right side of a one piece top

Y - Dimension from end of table to end of Console

Caution: Y greater than 30" makes access to Console Power/Data difficult from the end of the table

CONSOLE SIZE & LOCATIONS

See page 15 for information on console locations and size options for wood tops, and page 25 for laminate tops locations and sizes


CONSOLE MODULE OPTIONS

See page 49 for power / data options

ORDERING NOTES

Tops may be specified with fewer consoles and configurations other than shown. Consoles can be different sizes within the same top. Dimension from end of cut-out to table end cannot be less than 18".

NUVO | BACK-PAINTED GLASS RECTANGULAR CONFERENCE TOPS

Description	Model	Glass	L	W	Table Sections	Approximate Seating	Shipping Weight	Cubic Feet
Rectangular- Rounded Corners	5161GP6036	5667	60	36	1	4	190	42
	5161GP6042	6612	60	42	1	4	220	49
	5161GP6048	7556	60	48	1	4	250	53
	5161GP7236	6802	72	36	1	6	226	50
	5161GP7242	7935	72	42	1	6	262	58
	5161GP7248	9067	72	48	1	6	296	66
	5161GP7836	7369	78	36	1	6	244	55
	5161GP7842	8596	78	42	1	6	284	63
	5161GP7848	9817	78	48	1	6	322	72
	5161GP8436	7935	84	36	1	6	262	59
	5161GP8442	9258	84	42	1	6	304	68
	5161GP8448	10571	84	48	1	6	346	77
	5161GP9636	9067	96	36	1	8	300	67
	5161GP9642	10578	96	42	2	8	350	39
	5161GP9648	12018	96	48	2	8	396	45
5161GP10842	11949	108	42	2	8	390	44	
5161GP10848	13641	108	48	2	8	444	50	
5161GP12042	14119	120	42	2	8	432	49	
5161GP12048*	16086	120	48	2	10	494	56	
5161GP12054	18154	120	54	3	10	556	40	
5161GP12060	20170	120	60	3	10	614	47	
5161GP14448	19365	144	48	2	10	594	66	
5161GP14454	21785	144	54	3	12	666	50	
5161GP14460	24203	144	60	3	12	738	56	
5161GP15654	23599	156	54	3	12	724	54	
5161GP15660	26221	156	60	3	12	802	60	
5161GP16848	22590	168	48	3	12	694	52	
5161GP16854	25414	168	54	4	12	780	44	
5161GP16860	28238	168	60	4	12	862	49	
5161GP19248	25818	192	48	3	14	794	59	
5161GP19254	29046	192	54	4	14	890	50	
5161GP19260	32272	192	60	4	14	984	56	

NOTE: Support Beams are included in top price. An additional line item for the support beam will be included on the order acknowledgment at no charge.

RECTANGULAR - SQUARE CORNER TOPS:

Rectangular tops with square corners are available. Replace the model prefix with **5101GP**. e.g. **5161GP14448** becomes **5101GP14448**. Pricing is the same as standard tops.

ORDERING PROCEDURES

To order, please specify the following:

- 1) Table top shape, size, model number, glass color
- 2) Base model number
- 3) Console location and size option
- 4) Cross seam console model number, where applicable
- 5) Console power module and data options

DIMENSION KEY

L - length

W - Width

Dimensions are in inches and approximate.

Contact Customer Service if dimensions are critical.

BASE REQUIREMENTS

See page 60 for base requirements

CONSOLE SIZE & LOCATIONS

See page 41 for information on Console locations and size options


CONSOLE POWER/DATA MODULE OPTIONS

See page 49 for Console Module Options

TABLE SECTION SIZE

Section sizes can be calculated by dividing the table length by the # of sections

NUVO | BACK-PAINTED GLASS ARC END CONFERENCE TOPS

Description	Model	Glass	L	W	Table Sections	Approximate Seating	Shipping Weight	Cubic Feet
Arc End Table - Rounded Corners	5166GP6036	5758	60	36	1	4	178	42
	5166GP6042	6717	60	42	1	4	206	49
	5166GP6048	7679	60	48	1	4	234	53
	5166GP7236	6911	72	36	1	6	214	50
	5166GP7242	8061	72	42	1	6	246	58
	5166GP7248	9213	72	48	1	6	280	66
	5166GP7836	8061	78	36	1	6	232	55
	5166GP7842	8709	78	42	1	6	268	63
	5166GP7848	10096	78	48	1	6	306	72
	5166GP8436	8149	84	36	1	6	250	59
	5166GP8442	9516	84	42	1	6	288	68
	5166GP8448	10874	84	48	1	6	328	77
	5166GP9636	9322	96	36	1	8	288	67
	5166GP9642	10874	96	42	2	8	334	39
	5166GP9648*	12428	96	48	2	8	380	45
	5166GP10842	12233	108	42	2	8	376	44
	5166GP10848	13982	108	48	2	8	428	50
	5166GP12042	15231	120	42	2	10 (8)	422	49
5166GP12048	16096	120	48	2	10	478	56	
5166GP12054	18154	120	54	3	10	536	40	
5166GP12060	20170	120	60	3	10	594	47	
5166GP14448	19365	144	48	2	10	578	66	
5166GP14454	21785	144	54	3	12	648	50	
5166GP14460	24203	144	60	3	12	718	56	
5166GP15654	23599	156	54	3	12 (10)	706	54	
5166GP15660	26221	156	60	3	12	780	60	
5166GP16848	22590	168	48	3	12	676	52	
5166GP16854	25414	168	54	4	12	760	44	
5166GP16860	28238	168	60	4	12	842	49	
5166GP19248	25818	192	48	3	14	776	59	
5166GP19254	29046	192	54	4	14	870	50	
5166GP19260	32272	192	60	4	14	964	56	

NOTE: Support Beams are included in top price. An additional line item for the support beam will be included on the order acknowledgment at no charge.

ARC END TABLE - SQUARE CORNERS:

Arc End tops are available with square corners. Replace the model number prefix with **5106GP**. e.g. **5166GP12042** becomes **5106GP12042**. Pricing is the same as standard tops.

SEATING CAPACITY:

The number in brackets is the seating capacity when formed metal legs are used if different than the seating capacity when other bases are used.

ORDERING PROCEDURES

To order, please specify the following:

- 1) Table top shape, size, model number, glass color
- 2) Base model number
- 3) Console location and size option
- 4) Cross seam console model number, where applicable
- 5) Console power module and data options

DIMENSION KEY

L - Length

W - Width

Dimensions are in inches and approximate.

Contact Customer Service if dimensions are critical.

BASE REQUIREMENTS

See page 60 for base requirements

CONSOLE SIZE & LOCATIONS

See page 45 for information on Console locations and size options

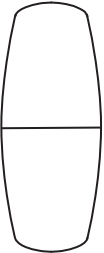
CONSOLE POWER/DATA MODULE OPTIONS

See page 49 for Console Module Options

TABLE SECTION SIZE

Section sizes can be calculated by dividing the table length by the # of sections

NUVO | BACK-PAINTED GLASS BOAT SHAPED & VISIO CONFERENCE TOPS

Description	Model	Glass	L	W	Table Sections	Approximate Seating	Shipping Weight	Cubic Feet
Boat-Shaped - Arc End Rounded Corners 	5164GP964842	12675	96	48/42	2	8	362	45
	5164GP965442*	14262	96	54/42	2	8	408	50
	5164GP1204842	16417	120	48/42	2	8	458	56
	5164GP1205442	18517	120	54/42	3	10 (8)	514	40
	5164GP1444842	19752	144	48/42	2	10	552	66
	5164GP1445442	22219	144	54/42	3	12	622	50
	5164GP1685442	25923	168	54/42	4	12	732	44
	5164GP1925442	29625	192	54/42	4	14	838	50

NOTE: Support Beams are included in top price. An additional line item for the support beam will be included on the order acknowledgment at no charge.

BOAT SHAPE - ARC END, SQUARE CORNERS:

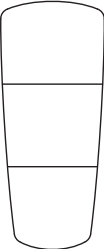
Boat Shape tops are available with Arc ends and Square corners. For Arc End, Square Corner tops replace model suffix with **5154GP**. e.g. **5164GP1204842** becomes **5154GP1204842**. Pricing is the same as standard tops.

BOAT SHAPE - STRAIGHT END, SQUARE CORNERS:

Boat Shape tops are available with Straight ends and square corners. For Straight End, Square Corner tops replace model suffix with **5104GP**. e.g. **5164GP1204842** becomes **5104GP1204842**. Pricing is the same as standard tops.

SEATING CAPACITY:

The number in brackets is the seating capacity when formed metal legs are used if different than the seating capacity when other bases are used.

Visio - Arc End Rounded Corners 	5168GP1206042	20314	120	60/42	3	8	536	47
	5168GP1446042*	22002	144	60/42	3	10	646	56
	5168GP1686642	31295	168	66/42	4	13	814	62
	5168GP1926942	37391	192	69/42	4	15	964	73

NOTE: Support Beams are included in top price. An additional line item for the support beam will be included on the order acknowledgment at no charge.

VISIO - ARC END, SQUARE CORNERS:

Visio Shape Tops with Arc Ends are available with square corners. For Arc End-Square corners, replace the model suffix with **5158GP**. e.g. **5168GP1446042** becomes **5158GP1446042**. Pricing is the same as standard tops.

VISIO - STRAIGHT END, SQUARE CORNERS:

Visio Shape Tops with Straight Ends are available with square corners. For Arc Straight End-Square corners, replace the model suffix with **5108GP**. e.g. **5168GP1446042** becomes **5108GP1446042**. Pricing is the same as standard tops.

ORDERING PROCEDURES

To order, please specify the following:

- 1) Table top shape, size, model number, glass color
- 2) Base model number
- 3) Console location and size option
- 4) Cross seam console model number, where applicable
- 5) Console power module and data options

DIMENSION KEY

L - Length

W - Width

Dimensions are in inches and approximate.

Contact Customer Service if dimensions are critical.

BASE REQUIREMENTS

See page 60 for base requirements

CONSOLE SIZE & LOCATIONS

See page 41 for information on Console locations and size options

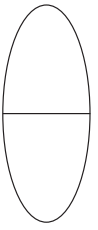
CONSOLE POWER/DATA MODULE OPTIONS

See page 49 for Console Module Options

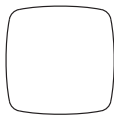
TABLE SECTION SIZE

Section sizes can be calculated by dividing the table length by the # of sections

NUVO | BACK-PAINTED GLASS OVAL, ARCED SQUARE & ROUND CONFERENCE TOPS

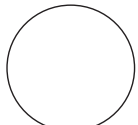
Description	Model	Glass	L	W	Table Sections	Approximate Seating	Shipping Weight	Cubic Feet	
	Oval Top	5159GP8448	11118	84	48	1	6	272	77
		5159GP9648	11967	96	48	2	8	314	45
		5159GP9654	14679	96	54	2	8	352	50
		5159GP12048*	16258	120	48	2	8	392	56
		5159GP12060	20314	120	60	3	10	486	40
		5159GP14454	21947	144	54	3	10	528	50
		5159GP14460	22002	144	60	3	12	584	56
		5159GP16860	28448	168	60	4	12	682	49

NOTE: Support Beams are included in top price. An additional line item for the support beam will be included on the order acknowledgment at no charge.

	Arced Square Top	5166GP3636	3456	36	36	1	4	118	31
		5166GP4242	4705	42	42	1	4	158	41
		5166GP4848	6141	48	48	1	4	202	52
		5166GP5454	7865	54	54	1	4	254	64

ARC SQUARE TOP - SQUARE CORNERS

Arc Square tops are available with square corners. For Square Corner tops replace model suffix with **5156GP**. e.g. **5166GP4242** becomes **5156GP4242**. Pricing is the same as standard tops.

	Round Top	5105GP36	3523	36 Dia.		1	3	94	31
		5105GP42	4795	42 Dia.		1	3	126	41
		5105GP48	6266	48 Dia.		1	4	160	52
		5105GP54	8024	54 Dia.		1	5	200	64

ORDERING PROCEDURES

To order, please specify the following:

- 1) Table top shape, size, model number, glass color
- 2) Base model number
- 3) Console location and size option
- 4) Cross seam console model number, where applicable
- 5) Console power module and data options

DIMENSION KEY

L - Length

W - Width

Dimensions are in inches and approximate.

Contact Customer Service if dimensions are critical.

BASE REQUIREMENTS

See page 60 for base requirements

CONSOLE SIZE & LOCATIONS

See page 41 for information on Console locations and size options

CONSOLE POWER/DATA MODULE OPTIONS

See page 49 for Console Module Options

TABLE SECTION SIZE

Section sizes can be calculated by dividing the table length by the # of sections

NUVO | CONSOLE PLANNING FOR BACK-PAINTED GLASS TOPS

CONSOLE ORDERING CODE (WITHIN THE TABLE SECTION - 4 CHARACTER CODE)

1st character specifies top sections from left to right on table: A, B, C, D

2nd character specifies console location within top section: M, L, R

M- Middle of top on one piece table

M- Middle of top section on multi section table

L- Left side of a one piece top

R- Right side of a one piece top

3rd and 4th characters specify console size: 14, 27, 36,

Examples:

Table Size: 96" x 36"

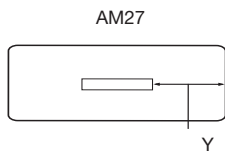


Table Size: 168" x 48"

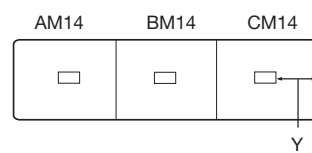


Table Size: 96 "x 36"

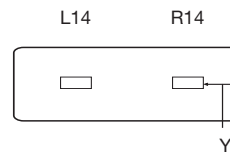
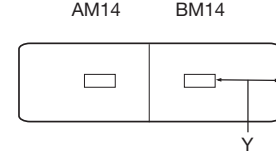


Table Size: 144" x 48"



Y= Dimension from end of table to end of console

CONSOLE ORDERING CODE (ACROSS SEAM - 5 CHARACTER CODE)

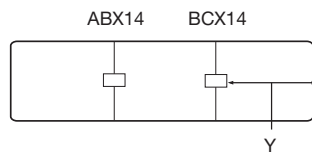
1st and 2nd character specifies section from left to right on table: AB, BC, CD

3rd character specifies console location across the seam: X

4th and 5th characters specify console size: 14, 27, 36,

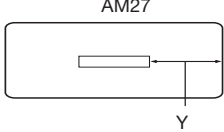
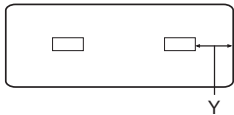
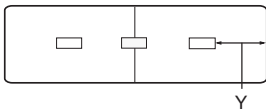
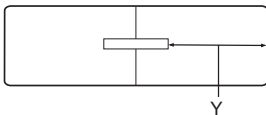
Example:

Table Size 168" - 192" X 48"



Y= Dimension from end of table to end of console

NUVO | CONSOLE SIZE & LOCATION - RECTANGULAR, ARC END, RACETRACK

Back-Painted Glass Console Options	Top Length	Console Options Top End Section	Console Options Within Top Center Section	Console Options Across Seam	Y
WIDTHS 48" OR LESS	60	M14			23
60" - 84" X 36", 42", 48"	72	M14			29
96" X 36"	78	M14 M27			32 25.5
Example	84	M14 M27			35 28.5
	96	M14 M27			41 34.5
84" X 36", 42", 48"	84	L14 / R14			18
96" X 36"	96	L14 / R14			18
Example					
					
96" - 144" X 42", 48"	96	*M14			18
Example	108	M14			20
AM14 ABX14 BM14	120	M14		X14	23
	144	M14		X14	29
*The "M" position of these consoles is not exactly in the center of the section.					
96" - 144" X 42", 48"	96			X14 X27	41 34.5
Example	108			X14 X27 X36	47 40.5 36
ABX36	120			X14 X27 X36	53 46.5 42
	144			X14 X27 X36	65 58.5 54

CODE KEY:

M - Console location, middle of top section
 X - Console location, across a seam of two top sections
 L - Console location, left side of a one piece top
 R - Console location, right side of a one piece top
 Y - Dimension from end of table to end of Console

Caution: Y greater than 30" makes access to Console Power/Data difficult from the end of the table

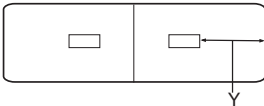
CONSOLE POWER/DATA MODULE OPTIONS

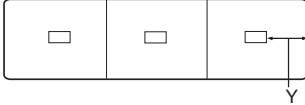
See page 49 for Console Module Options

ORDERING NOTES

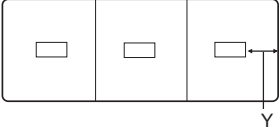
Tops may be specified with fewer consoles and configurations other than shown. Consoles can be different sizes within the same top. Dimension from end of cut-out to table end cannot be less than 18".

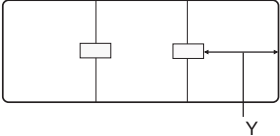
NUVO | CONSOLE SIZE & LOCATION - RECTANGULAR, ARC END, RACETRACK & BOAT SHAPED

Back-Painted Glass Console Options	Top Length	Console Options Top End Section	Console Options Within Top Center Section	Console Options Across Seam	Y
96" - 144" X 42", 48"	96	*M14			18
Example	108	M14			20
AM14 BM14	120	M14			23
	144	M14			29
*The "M" position of these consoles is not exactly in the center of the section.					

168" - 192" X 48"	168	M14	M14		21
Example	192	M14	M14		25
AM14 BM14 CM14					

168" - 192" X 48"	168			X14	49
Example	192			X14	57
ABX14 BCX14					

GLASS TOP WIDTHS 54" OR GREATER	Top Length	Console Options Top End Section	Console Options Within Top Center Section	Console Options Across Seam	Y
120" - 156" X 54", 60"	120	*M14	M14		18
Example	144	*M14	M14		18
AM14 BM14 CM14	156	M14	M14		19
*The "M" position of these consoles is not exactly in the center of the section.					
					

120" - 156" X 54", 60"	120			X14	33
Example	144			X14	41
ABX14 BCX14	156			X14	45
					

CODE KEY
M - Console location, middle of top section
X - Console location, across a seam of two top sections
L - Console location, left side of a one piece top
R - Console location, right side of a one piece top
Y- Dimension from end of table to end of Console
Caution: Y greater than 30" makes access to Console Power/Data difficult from the end of the table

CONSOLE POWER/DATA MODULE OPTIONS
See page 49 for Console Module Options

ORDERING NOTES
Tops may be specified with fewer consoles and configurations other than shown. Consoles can be different sizes within the same top. Dimension from end of cut-out to table end cannot be less than 18".

NUVO | CONSOLE SIZE & LOCATION - RECTANGULAR, ARC END, RACETRACK & BOAT SHAPED

Back-Painted Glass Console Options	Top Length	Console Options Top End Section	Console Options Within Top Center Section	Console Options Across Seam	Y
168"-192" X 54", 60"	168	*M14	M14		18
Example	192	M14	M14		18
AM14 BM14 CM14 DM14					
		*The "M" position of these consoles is not exactly in the center of the section.			
168" - 192" X 54", 60"	168	*M14		X14 X27	18
Example	192	M14		X14 X27	18
AM14 BCX14 DM14					
		*The "M" position of these consoles is not exactly in the center of the section.			
96" - 144" X 48"/42" 96" X 54"/42"	96	*M14			18
Example	120	M14		X14	23
AM14 ABX14 BM14	144	M14		X14	29
		*The "M" position of these consoles is not exactly in the center of the section.			
96" - 144" X 48"/42" 96" X 54"/42"	96			X14 X27	41 34.5
Example	120			X14 X36 X27	53 42 46.5
ABX36	144			X14 X27 X36	65 58.5 54
		*The "M" position of these consoles is not exactly in the center of the section.			
96" - 144" X 48"/42" 96" X 54"/42"	96	*M14			18
Example	120	M14			23
AM14 BM14	144	M14			29
		*The "M" position of these consoles is not exactly in the center of the section.			

CODE KEY

M - Console location, middle of top section
 X - Console location, across a seam of two top sections
 L - Console location, left side of a one piece top
 R - Console location, right side of a one piece top
 Y- Dimension from end of table to end of Console

Caution: Y greater than 30" makes access to Console Power/Data difficult from the end of the table.

CONSOLE POWER/DATA MODULE OPTIONS

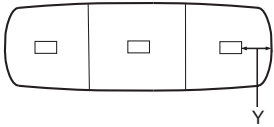
See page 49 for Console Module Options

ORDERING NOTES

Tops may be specified with fewer consoles and configurations other than shown. Consoles can be different sizes within the same top. Dimension from end of cut-out to table end cannot be less than 18".

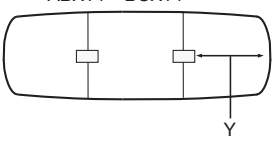
NUVO | CONSOLE SIZE & LOCATION - BOAT SHAPED

Back-Painted Glass Top Console Options	Top Length	Console Options Top End Section	Console Options Within Top Center Section	Console Options Across Seam	Y
120" - 144" x 54"/42"	120	*M14	M14		18
Example AM14 BM14 CM14	144	*M14	M14		18

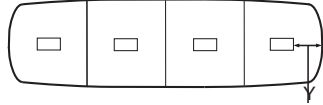


*The "M" position of these consoles is not exactly in the center of the section.

120" - 144" x 54"/42"	120			X14	33
Example ABX14 BCX14	144			X14	41

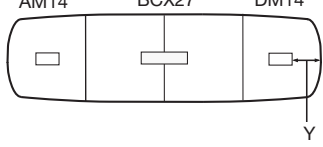


168" - 192" X 54"/42"	168	*M14	M14		18
Example AM14 BM14 CM14 DM14	192	M14	M14		18



*The "M" position of these consoles is not exactly in the center of the section.

168" - 192" X 54"/42"	168	*M14		X14 X27	18
Example AM14 BCX27 DM14	192	*M14		X14 X27	18



*The "M" position of these consoles is not exactly in the center of the section.

CODE KEY

- M - Console location, middle of top section
- X - Console location, across a seam of two top sections
- L - Console location, left side of a one piece top
- R - Console location, right side of a one piece top
- Y - Dimension from end of table to end of Console

Caution: Y greater than 30" makes access to Console Power/Data difficult from the end of the table

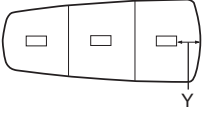
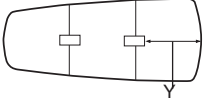
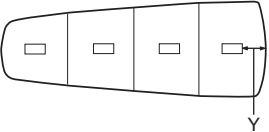
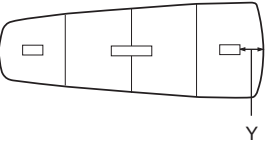
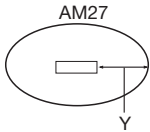
CONSOLE POWER/DATA MODULE OPTIONS

See page 49 for Console Module Options

ORDERING NOTES

Tops may be specified with fewer consoles and configurations other than shown. Consoles can be different sizes within the same top. Dimension from end of cut-out to table end cannot be less than 18".

NUVO | CONSOLE SIZE & LOCATION - VISIO & OVAL

Back-Painted Glass Top Console Options	Top Length	Console Options Top End Section	Console Options Within Top Center Section	Console Options Across Seam	Y
120" - 144" X 60"/42"	120	*M14	M14		18
Example AM14 BM14 CM14	144	M14	M14		18
					
		*The "M" position of these consoles is not exactly in the center of the section.			
120" - 144" X 60/42	120			X14	33
Example ABX14 BCX14	144			X14	41
					
168" X 66/42" 192" X 69/42"	168	*M14	M14		18
AM14 BM14 CM14 DM14	192	M14			18
					
		*The "M" position of these consoles is not exactly in the center of the section.			
168" X 66/42" 192" X 69/42"	168	*M14		X14 X27	18
AM14 BCX27 DM14	192	*M14		X14 X27	18
					
		*The "M" position of these consoles is not exactly in the center of the section.			
84" x 48"	84	M14 M27			35 28.5
Example AM27					
					

CODE KEY

M - Console location, middle of top section
 X - Console location, across a seam of two top sections
 L - Console location, left side of a one piece top
 R - Console location, right side of a one piece top
 Y - Dimension from end of table to end of Console

Caution: Y greater than 30" makes access to Console Power/Data difficult from the end of the table

CONSOLE POWER/DATA MODULE OPTIONS

See page 49 for Console Module Options

ORDERING NOTES

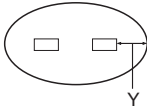
Tops may be specified with fewer consoles and configurations other than shown. Consoles can be different sizes within the same top. Dimension from end of cut-out to table end cannot be less than 18".

NUVO | CONSOLE SIZE & LOCATION - OVAL

Back-Painted Glass Top Console Options	Top Length	Console Options Top End Section	Console Options Within Top Center Section	Console Options Across Seam	Y
84" x 48"	84	L14/R14			18

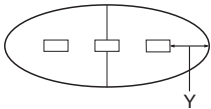
Example

AL14 AR14



96" - 120" X 48" 96" X 54"	96	*M14			18
-------------------------------	----	------	--	--	----

AM14 ABX14 BM14

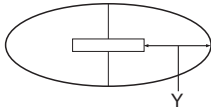


*The "M" position of these consoles is not exactly in the center of the section.

96" - 120" X 48" 96" X 54"	96			X27	34.5
-------------------------------	----	--	--	-----	------

Example

ABX36



	120			X14	41
--	-----	--	--	-----	----

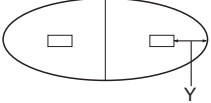
				X36	42
--	--	--	--	-----	----

				X27	46.5
--	--	--	--	-----	------

				X14	53
--	--	--	--	-----	----

96" - 120" X 48" 96" X 54"	96	*M14			18
-------------------------------	----	------	--	--	----

AM14 BM14



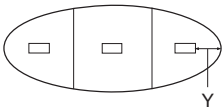
	120	M14			23
--	-----	-----	--	--	----

*The "M" position of these consoles is not exactly in the center of the section.

144" X 54"	144	*M14	M14		18
------------	-----	------	-----	--	----

Example

AM14 BM14 CM14



*The "M" position of these consoles is not exactly in the center of the section.

CODE KEY

M - Console location, middle of top section
 X - Console location, across a seam of two top sections
 L - Console location, left side of a one piece top
 R - Console location, right side of a one piece top
 Y - Dimension from end of table to end of Console

Caution: Y greater than 30" makes access to Console Power/Data difficult from the end of the table

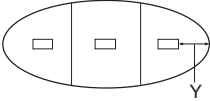
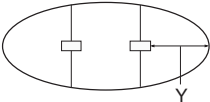
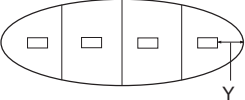
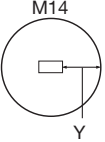
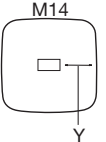
CONSOLE POWER/DATA MODULE OPTIONS

See page 49 for Console Module Options

ORDERING NOTES

Tops may be specified with fewer consoles and configurations other than shown. Consoles can be different sizes within the same top. Dimension from end of cut-out to table end cannot be less than 18".

NUVO | CONSOLE SIZE & LOCATION - OVAL, ROUND, ARCED SQUARE

Back-Painted Glass Top Console Options	Top Length	Console Options Top End Section	Console Options Within Top Center Section	Console Options Across Seam	Y
120" - 144" X 60"	120	*M14	M14		18
Example AM14 BM14 CM14	144	M14	M14		18
		*The "M" position of these consoles is not exactly in the center of the section.			
120" - 144" X 60" 144" X 54"	120			X14	33
Example ABX14 BCX14	144			X14	41
					
168" X 60"	168	M14	M14		18
Example AM14 BM14 CM14 DM14					
					
36" - 60"	36	M14			11
Examples	42	M14			14
	48	M14			17
	54	M14			20

CODE KEY

M - Console location, middle of top section
 X - Console location, across a seam of two top sections
 L - Console location, left side of a one piece top
 R - Console location, right side of a one piece top
 Y - Dimension from end of table to end of Console

Caution: Y greater than 30" makes access to Console Power/Data difficult from the end of the table

CONSOLE POWER/DATA MODULE OPTIONS

See page 49 for Console Module Options

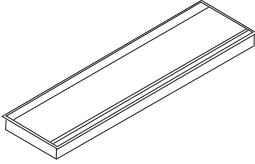
ORDERING NOTES

Tops may be specified with fewer consoles and configurations other than shown. Consoles can be different sizes within the same top. Dimension from end of cut-out to table end cannot be less than 18".

NUVO | CONSOLES FOR BACK-PAINTED GLASS TOPS

CONSOLE - WITHIN A TOP SECTION

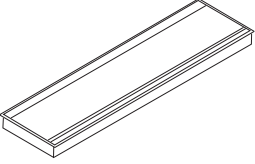
Consoles located within a top section are factory installed. The model numbers are determined by the location within each section and the size. For example, when ordering a rectangular top 96" x 54" a console M14 can be specified in both the A and/or B section of the table. When ordering, simply add AM14 and BM14 to your purchase order and add the list price for each console to your order.

Description	Model	Console Size	Price	Weights	Cubes
	M14, L14,R14	14	265	.25	
	M27	27	295	4	.25

Consoles are available in 2 standard lengths.

CONSOLE - ACROSS SEAMS

Consoles located across the seam are field installed and have separate model numbers that need to be included on your purchase order along with the desired console position. For example, when ordering a rectangular top 120" x 54" with a console across the seam, purchase orders need to specify the model number for the console (51CONSOLEX-14) and the location ABX14.

Description	Model	Console Size	Price	Weights	Cubes
	51CONSOLE-X14	14	265	3	0.25
	51CONSOLE-X27	27	295	4	0.25
	51CONSOLE-X36	36	333	5	0.25

CONSOLE POWER/DATA MODULES

Console modules provide an extensive range of power, data and audio-visual solutions for today's conferencing environments. Console modules are available in 18 preconfigured data and power options, or alternatively console modules with just electrical ports can be selected allowing units to be designed and built specifically to meet your connectivity needs by using the Snap-in or Plate mounted port options. Consoles are available with 3 power options in both preconfigured & custom console modules.

Power Module A (PMA) consists of 2 duplex receptacles with 3 cord lengths 6', 16' & 25'.

Power Module B (PMB) consists of 1 duplex receptacle with 3 cord lengths 6', 16' & 25'.

Power Module C (PMC) consists of 2 duplex receptacles with a utility outlet & circuit breaker with 2 cord lengths 6' & 16'. The utility outlet in Module C allows another power module within the table to be plugged into it resulting in 1 cord going to the power source for both modules, as well as circuit protection for both modules. This also means shorter cord lengths can be specified resulting in a more cost effective power solution. Krug recommends the use of Module C's on the Console at the end of the table or location in the table nearest the power source.

Examples:

120" table with 2 consoles & the power source at right end.

Use a PMC06 in the 1st console from the right & the cord goes to power source.

Use a PMA06 in the 2nd console from the right & the cord goes to the utility outlet of the first console module.

168" table with 4 consoles & power source at right hand end.

Use a PMC06 in the 1st console from the right & the cord goes to power source.

Use a PMC06 in the 2nd console from the right & the cord goes to power source.

Use a PMA06 in the 3rd console from the right & the cord goes to utility the outlet in the 1st console module.

Use a PMA06 in the 4th console from the right & the cord goes to utility the outlet in the 2nd console module.

CODE KEY

M - Console location, middle of top section

X - Console location, across a seam of two top sections

L - Console location, left side of a one piece top

R - Console location, right side of a one piece top

Y - Dimension from end of table to end of Console

Caution: Y greater than 30" makes access to Console Power/Data difficult from the end of the table

CONSOLE POWER/DATA MODULE OPTIONS

See page 49 for Console Module Options

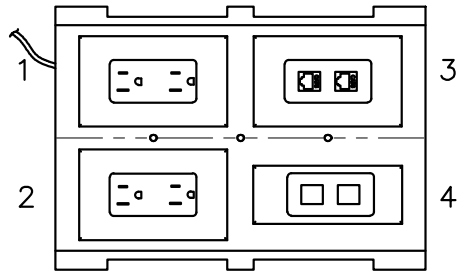
ORDERING NOTES

Tops may be specified with fewer consoles and configurations other than shown. Consoles can be different sizes within the same top. Dimension from end of cut-out to table end cannot be less than 18".

NUVO | STANDARD CONSOLE POWER/DATA/MEDIA CONFIGURATIONS

There are 3 versions of console power/data module: A, B, C. Version C has an utility outlet, this also allows another power module to be plugged into it allowing a shorter cord to be used.

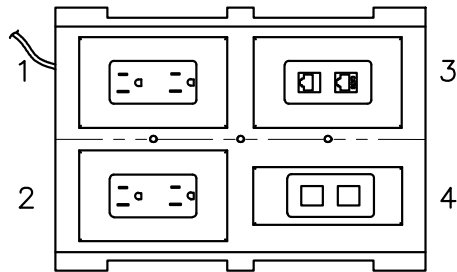
POWER MODULE A PRECONFIGURED



PORT OPTIONS	MODEL #	CORD LENGTH	LIST PRICE
--------------	---------	-------------	------------

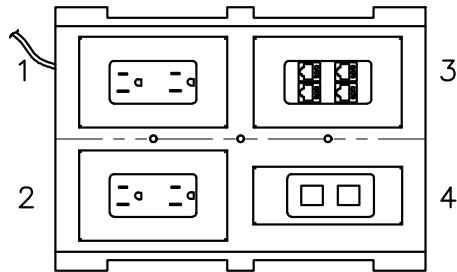
BASIC DATA

① (1) Duplex Receptacle	51PDAD01-06	6'	508
	51PDAD01-16	16'	596
② (1) Duplex Receptacle	51PDAD01-25	25'	670
③ (2) RJ45 Port (Cat 6)			
④ (2) Blank Ports (for future use)			



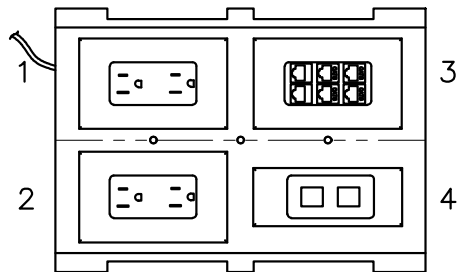
BASIC VOICE DATA

① (1) Duplex Receptacle	51PDAD02-06	6'	483
	51PDAD02-16	16'	571
② (1) Duplex Receptacle	51PDAD02-25	25'	648
③ (1) RJ45 Port (Cat 6)			
③ (1) RJ11 (Voice) Port			
④ (2) Blank Ports (for future use)			



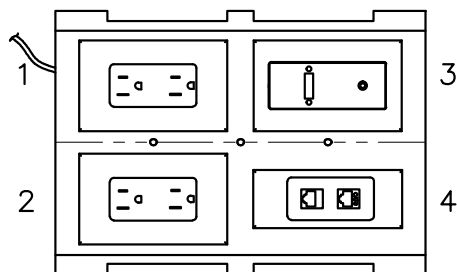
EXPANDED DATA

① (1) Duplex Receptacle	51PDAD03-06	6'	589
	51PDAD03-16	16'	678
② (1) Duplex Receptacle	51PDAD03-25	25'	753
③ (4) RJ45 Port (Cat 6)			
④ (2) Blank Ports (for future use)			



EXPANDED VOICE DATA

① (1) Duplex Receptacle	51PDAD04-06	6'	626
	51PDAD04-16	16'	716
② (1) Duplex Receptacle	51PDAD04-25	25'	791
③ (4) RJ45 Port (Cat 6)			
③ (2) RJ11 (Voice) Port			
④ (2) Blank Ports (for future use)			



BASIC MULTIMEDIA

① (1) Duplex Receptacle	51PDAD05-06	6'	633
	51PDAD05-16	16'	723
② (1) Duplex Receptacle	51PDAD05-25	25'	799
③ (1) Stereo 3.5 Mini			
③ (1) VGA Type 15 pin HD			
④ (1) RJ45 Port (Cat 6)			
④ (1) RJ11 (Voice) Port			

NUVO | STANDARD CONSOLE POWER/DATA/MEDIA CONFIGURATIONS

	PORT OPTIONS	MODEL #	CORD LENGTH	LIST PRICE
	ENHANCED MULTIMEDIA			
	① (1) Duplex Receptacle	51PDAD06-06	6'	1282
	② (1) Duplex Receptacle	51PDAD06-16	16'	1372
	③ (1) Duplex Receptacle	51PDAD06-25	25'	1446
	③ (1) DVI-I (1) VGA			
	(1) RJ11 (Voice) Port (1) RJ45 Port (Cat 6)			
	④ (1) Fibre Optic LC Duplex (1) Stereo 3.5 mm Mini (1) USB "A" (1) HDMI			

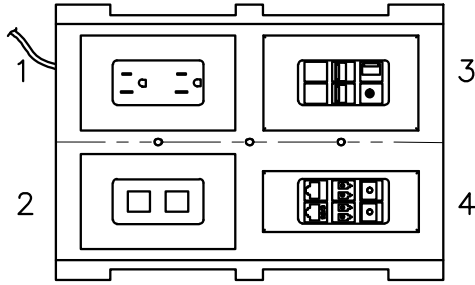
	BASIC FIBRE OPTIC AND MULTIMEDIA			
	① (1) Duplex Receptacle	51PDAD07-06	6'	1173
	② (1) Duplex Receptacle	51PDAD07-16	16'	1266
	③ (1) Duplex Receptacle	51PDAD07-25	25'	1341
	(1) HDMI (1) Stereo 3.5 mm Mini (2) USB "A" (2) Blank Ports (for future use)			
	③			
	(2) Fibre Optic SC Simplex (2) Fibre Optic LC Duplex (1) RJ45 Port (Cat 6) (1) RJ11 (Voice) Port			
	④			

POWER MODULE B PRECONFIGURED

	BASIC MULTIMEDIA			
	① (1) Duplex Receptacle	51PDBD05-06	6'	542
	② (2) Blank Ports (for future use)	51PDBD05-16	16'	633
	③ (1) Duplex Receptacle	51PDBD05-25	25'	708
	(1) Stereo 3.5 mm Mini (1) VGA Type 15 pin HD			
	③			
	④ (1) RJ45 Port (Cat 6) (1) RJ11 (Voice) Port			
	④			

	ENHANCED MULTIMEDIA			
	① (1) Duplex Receptacle	51PDBD06-06	6'	1198
	② (2) Blank Ports (for future use)	51PDBD06-16	16'	1288
	③ (1) Duplex Receptacle	51PDBD06-25	25'	1361
	(1) DVI-I (1) VGA			
	③			
	(1) RJ11 (Voice) Port (1) RJ45 Port (Cat 6) (1) Fibre Optic LC Duplex (1) Stereo 3.5 mm Mini (1) USB "A" (1) HDMI			
	④			

NUVO | STANDARD CONSOLE POWER/DATA/MEDIA CONFIGURATIONS

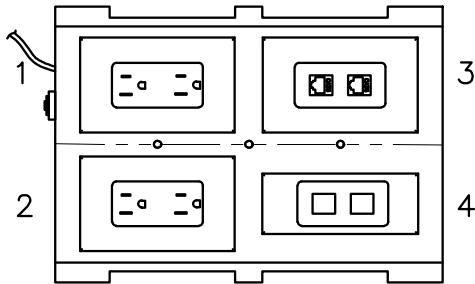


PORT OPTIONS **MODEL #** **CORD LENGTH** **LIST PRICE**

BASIC FIBRE OPTIC AND MULTIMEDIA

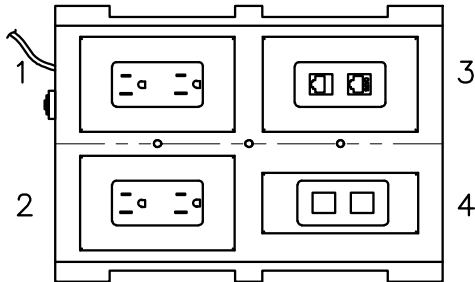
- ① (1) Duplex Receptacle 51PDBD07-06 6' 1192
- ② (2) Blank Ports (for future use) 51PDBD07-16 16' 1266
- ③ (1) HDMI
(1) Stereo 3.5 mm Mini
(2) USB "A"
(2) Blank Ports (for future use)
- ④ (2) Fibre Optic SC Simplex
(2) Fibre Optic LC Duplex
(1) RJ45 Port (Cat 6)
(1) RJ11 (Voice) Port

POWER MODULE C PRECONFIGURED



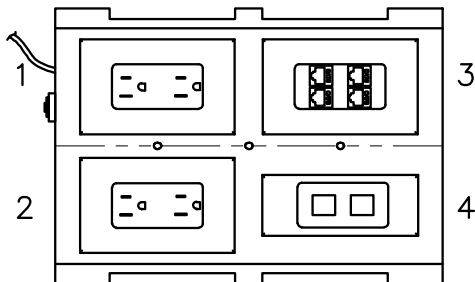
BASIC DATA WITH UTILITY OUTLET RECEPTACLE

- ① (1) Duplex Receptacle w/ 15 amp circuit breaker 51PDCC01-06 6' 559
- ② (1) Duplex Receptacle with Utility Outlet 51PDCC01-16 16' 648
- ③ (2) RJ45 Port (Cat 6)
- ④ (2) Blank Ports (for future use)



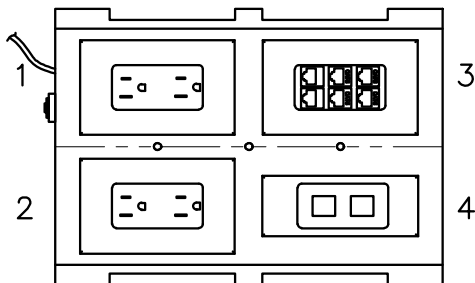
BASIC VOICE DATA WITH UTILITY OUTLET RECEPTACLE

- ① (1) Duplex Receptacle w/ 15 amp circuit breaker 51PDCC02-06 6' 542
- ② (1) Duplex Receptacle with Utility Outlet 51PDCC02-16 16' 633
- ③ (1) RJ45 Port (Cat 6)
(1) RJ11 (Voice) Port
- ④ (2) Blank Ports (for future use)



EXPANDED DATA WITH UTILITY OUTLET RECEPTACLE

- ① (1) Duplex Receptacle w/ 15 amp circuit breaker 51PDCC03-06 6' 648
- ② (1) Duplex Receptacle with Utility Outlet 51PDCC03-16 16' 739
- ③ (4) RJ45 Port (Cat 6)
- ④ (2) Blank Ports (for future use)



EXPANDED VOICE DATA WITH UTILITY OUTLET RECEPTACLE

- ① (1) Duplex Receptacle w/ 15 amp circuit breaker 51PDCC04-06 6' 678
- ② (1) Duplex Receptacle with Utility Outlet 51PDCC04-16 16' 768
- ③ (4) RJ45 Port (Cat 6)
(2) RJ11 (Voice) Port
- ④ (2) Blank Ports (for future use)

NUVO | CONSOLE POWER MODULES FOR CUSTOM CONFIGURATIONS

	PORT OPTIONS	MODEL #	CORD LENGTH	LIST PRICE
POWER MODULE A				
	① (1) Duplex Receptacle	51PMA06	6'	483
	② (1) Duplex Receptacle	51PMA16	16'	565
	③ (1) Open for data	51PMA25	25'	641
	④ (1) Open for data			
POWER MODULE B				
	① (1) Duplex Receptacle	51PMB06	6'	363
	② (1) Open for data	51PMB16	16'	446
	③ (1) Open for data	51PMB25	25'	530
	④ (1) Open for data			
POWER MODULE C WITH UTILITY OUTLET				
	① (1) Duplex Receptacle w/ 15 amp circuit breaker	51PMC06 51PMC16	6' 16'	508 582
	② (1) Duplex Receptacle with Utility Outlet			
	③ (1) Open for data			
	④ (1) Open for data			
DATA MODULE D				
	① (1) Open for data	51PMD		128
	② (1) Open for data			
	③ (1) Open for data			
	④ (1) Open for data			
<p>This open module can also be used if hard wiring power is required. Electrical boxes and receptacles can be installed in open spaces and a Decora face plate is mounted on top. All components would be provided by a qualified electrician.</p>				
POWER MODULE E WITH UTILITY OUTLET				
	① (1) Duplex Receptacle w/15 amp circuit breaker	51PME06		764
	② (1) Simplex Receptacle/ 2 USB Charging Port with Utility Outlet	51PME16		865
	③ (1) open for data			
	④ (1) open for data			
POWER MODULE A - HARD WIRED				
	① (1) Duplex Receptacle	51PMA16HW	16'	648
	② (1) Duplex Receptacle			
	③ (1) Open for data			
	④ (1) Open for data			

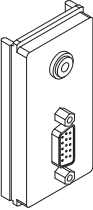
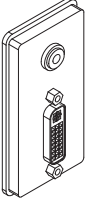
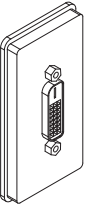
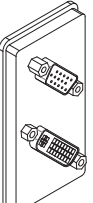
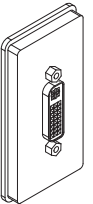
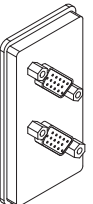
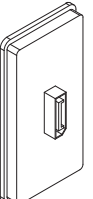
NOTE: Open positions will accept 1 Plate Mounted Data Option or up to 6 Snap-In Data Options. Please order a blank port when an odd number of snap-in ports are specified.

When specifying data within the power console module, please provide reference code and port position (1, 2, 3 or 4).


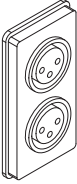
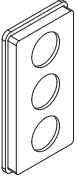
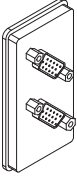
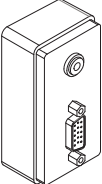

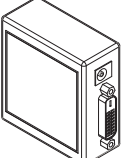
PLATE MOUNTED DATA OPTIONS
See page 54 for Plate Mounted Data Options

SNAP-IN DATA OPTIONS
See page 56 for Snap-In Data Options

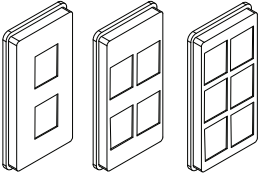

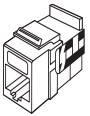

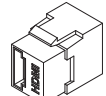



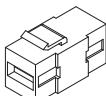
NUVO | CONSOLE DATA/MEDIA OPTIONS

PLATE MOUNTED PORTS	Reference Code	Description	List Price
	P01	VGA & 3.5 STEREO MINI - Use for VGA (DB15) connections and for 3.5mm stereo connections. VGA connectors is a female-to-female pass through and the 3.5 Mini is a female-to-female pass through.	143
	P02	DVI-I DUAL (DIGITAL/ANALOG) & 3.5 STEREO MINI - Use for DVI Integrated - Digital and Analog connections and for 3.5mm stereo connection. The DVI connector is a Dual Link. DVI-I connector is a female-to-female pass through and the 3.5 Mini is a female input with screw terminal output (back side of Console interface).	212
	P03	DVI-D DUAL (DIGITAL) - Use for DVI-D Digital only connection. The connector is a Dual Link. Connector is a female-to-female pass through.	137
	P04	DVI-I DUAL (DIGITAL/ANALOG) & VGA - Use for DVI Integrated - Digital and Analog and for VGA (DB15) connections. The DVI connector is a Dual Link. Both connectors are female-to-female pass through.	271
	P05	DVI-I DUAL (DIGITAL/ANALOG) - Use for DVI Integrated -Digital and Analog connections. DVI connector is a Dual Link. Connector is a female-to-female pass through.	173
	P06	VGA-2 - Use for two VGA (DB15) connections. Both connectors are female-to-female pass through.	168
	P07	DISPLAYPORT - Use for DisplayPort connection. This connector is primarily used to connect a video source to a display device and also carries audio signals, Connector is a female input to a 3' corded output (back side of Console interface) with a male Display Port termination.	168



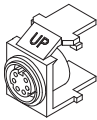
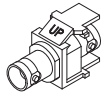

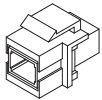
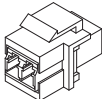
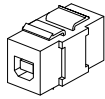
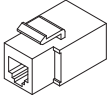

NUVO | CONSOLE DATA/MEDIA OPTIONS

PLATE MOUNTED PORTS	Reference Code	Description	List Price
	P08	MICROPHONE XLR STANDARD - Use for standard size XLR microphone connection. Connector is a female input with a 3 pin screw terminal output (back side of Console interface).	228
	P09	MICROPHONE STANDARD XLR -2 - Use for two standard size XLR microphone connections. Each connector is a female input with a 3 pin screw terminal output (back side of Console interface).	333
	P10	3 HOLE CABLE PASS THROUGH - Use for running loose cables from the under side of the table up into the Console interface cavity. Often used with running wires for PolyCom™ devices.	54
	P11	VGA-to-BNCx2 - Use for two VGA (DB15) connections that are input female pass through and are terminated on the output (back side of Console interface) with 5 BNC female pigtail connections, for each VGA connector.	542
	P12	INPUT VGA & 3.5 Stereo (POWERED) - VGA + Audio Line Driver designed for VGA (DB15) connections and for 3.5mm stereo connections. This unit provides a method of transmitting signals to a remote display and audio receiver or amplifier. VGA connector is a female input and comes with cabling for either VGA output, or 5 BNC output and the 3.5 Mini is a female input with screw terminal output (back side of Console interface). A 9 volt DC 500mA power supply is required to power this unit.	1327
	P13	BLANK DECORA ADAPTER - Use for covering a full Decora sides blank opening.	38
	DVIR	DVI-REPEATER - Is a cable equalizer that automatically compensates for long DVI cable runs. This unit extends the usable cable distance up to 130 ft depending on the quality of the cable and the resolution of the video signal. Additionally, it is capable of extending dual link signals allowing for much greater resolutions and refresh rates. This unit comes with a power supply and is generally mounted underneath a table.	1046

NUVO | CONSOLE DATA/MEDIA OPTIONS

SNAP IN PORTS	Reference Code	Description	List Price
ADAPTOR PLATES			
	M02	Adaptor Plate (2) - accepts two snap in data ports	38
	M04	Adaptor Plate (4) - accepts four snap in data ports	38
	M06	Adaptor Plate (6) - accepts six snap in data ports	38
ORDERING NOTES: Blank covers are required when port is not in use, please see page 55.			
	S01W	RJ45-CAT6 (White)	47
	S01B	RJ45-CAT6 (Blue)	
	S01R	RJ45-CAT6 (Red)	
	S02W	RJ11 (White)	32
	S02B	RJ11-B (Black)	
	S02G	RJ11-G (Green)	
	S02R	RJ11-R (Red)	
	S02Y	RJ11-Y (Yellow)	
	S03	3.5 STEREO MINI - 3.5mm stereo connection. Connector is a female input with screw terminal output (back side of Console interface).	92
	S04	HDMI - High Definition Multimedia Interface connection. Connector carries both HD audio and video data. Connector is a female-to-female pass through.	173
	S05	RCA-LEFT - RCA left audio channel connection. Color coded with black. Connector is a female-to-female pass through.	38
	S06	RCA-RIGHT - RCA right audio channel connection. Color coded with red. Connector is a female-to-female pass through.	38
	S07	RCA- VIDEO - RCA video channel connection. Color coded with yellow. Connector is a female-to-female pass through.	38
	S08	USB-A - Full size USB "A" style connection. Connector is a female-to-female pass through.	61

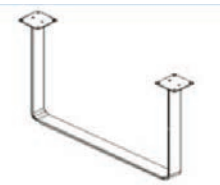
NUVO | CONSOLE DATA/MEDIA OPTIONS

SNAP IN PORTS	Reference Code	Description	List Price
	S09	3 PIN MINI XLR - 3 Pin Mini XLR microphone connection. Connector is a female input to a 6' corded output (back side of Console interface) with a 3 Pin Mini XLR male termination.	739
	S10	S-VIDEO - S-Video connection. Connector is a female-to-female pass through.	68
	S11	PS/2 (6 PIN MINI DIN) - PS/2 (mouse, keyboard, other input devices) connections. Connector is a female-to-female pass through.	85
	S12	BNC - BNC style data connection for use with co-axial cable. Connector is a female-to-female pass through.	47
	S13	F-TYPE - F-Type (DSL, Cable) connections, generally for high speed Internet or video applications. Connector is a female-to-female threaded pass through.	38
	S14	FIBER OPTIC SC - Fibre Optic SC Simplex connection. Connector is a female-to-female pass through. Please note that two of these connectors are required to complete the data transmissions to and from the source and destination units.	47
	S15	FIBER OPTIC LC - Fibre Optic LC Duplex connection. Connector is a female-to-female pass through. One connector only is required to complete the data transmissions to and from source and destination units.	92
	S16	USB-B - USB "B" type connection. Connector is a female "B" input to a female "A" output (back side of Console interface). This connector is reversible.	137
	S17	RJ12 (White) - RJ12 style PolyCom™ connection. Connector is a female input with a 6' corded output (back side) of Console interface) with a male RJ12 termination.	295
	S00	BLANK COVER - Blank covers are required when port is not in use.	16

NOTE: Up to 6 snap-in data ports can be ordered for open data positions. Snap-in adaptors can accept 2, 4 or 6 snap-in data ports. Please order a blank port when an odd number of snap-in ports are specified.

NUVO | BASES

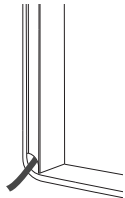
Description	Model	Price	W	D	H	Shipping Weight	Cubic Feet
-------------	-------	-------	---	---	---	-----------------	------------



Formed Metal Base	514124328	1173	24	3	28	29	2.75
	514136328	1311	36	3	28	31	3.75
	514148328	1446	47	3	28	37	4.5

ORDERING NOTE: Formed Metal bases are available in Matte Chrome. There are two cable management options available for Formed Metal bases – Metal Cable Manager or Spine Cable Manager. To order either of these options, please add the cable manager suffix to the end of the model number and add the upcharge listed below. For Example: To add the Metal Cable Manager to the Formed Metal base, please add **CM1** to the end of the base model number. e.g. 514124328 changes to 514124328**CM1** & add the upcharge from below. To add the Spine Cable Manager to the table, please add **CM2** to the end of the Formed Metal base model number. e.g. 514124328 changes to 514124328 **CM2** & add the upcharge from below.

Formed Metal Base Cable Management



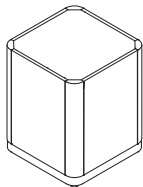
Metal Cable Manager	182
CM1	

NOTE: Metal Cable Manager attaches to the Formed Metal Base magnetically.



Spine Cable Manager	212
CM2	

Description	Model	Laminate Oak, Maple Cherry Palette	Walnut	W	D	H	Shipping Weight	Cubic Feet
Square Base for Arc Square and Round Tops	5142161628	1064	1194	16	16	28	136	7.25
	5142202028	1192	1309	20	20	28	160	12.5



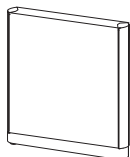
ORDERING NOTES: Bases are available in Oak, Maple, Cherry, Walnut, Palette finishes and Laminate. Base plates are available in Gloss Aluminum, Palette, Laminate or Wood, please specify requirement on order.

BASE SIZES FOR ARCED SQUARE TABLES AND FOR ROUND TABLES

Top Size Arc Square	Top Size Round Tops	Quantity	W	D	H
36-36	36 Dia.	1	16	16	28
42-42	42 Dia.	1	16	16	28
48-48	48 Dia.	1	20	20	28
54-54	54 Dia.	1	20	20	28
60-60	60 Dia.	1	20	20	28

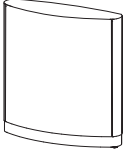
These bases include a weighted ballast to provide stability.

Panel Base

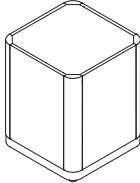


513921325	882	971	20.5	3	25	30	2
513925325	957	1054	24.5	3	25	33	2.25
513931325	1017	1119	30.5	3	25	38	2.5

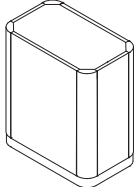
ORDERING NOTE: Base plates are available in Gloss Aluminum, Palette, Laminate or Wood, please specify requirement on order.

Description	Model	Laminate Oak, Maple, Cherry, Palette		Walnut	W	D	H	Shipping Weight	Cubic Feet
	514521825	994	1093		21	8	25	28	3.5
	5145251025	1068	1177		25	10	25	33	5.75
	5145311225	1162	1275		31	12	25	38	7.75

ORDERING NOTE: Base plates are available in Gloss Aluminum, Palette, Laminate or Wood, please specify requirement on order.

	5143161625	1173	1292		16	16	25	60	7.25
	5143202025	1236	1358		20	20	25	75	8.5
	5143242425	1282	1409		24	24	25	88	12
	5143303025	1416	1558		30	30	25	95	14

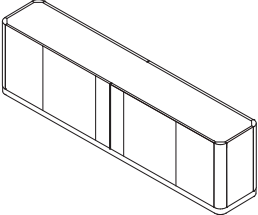
ORDERING NOTE: Base plates are available in Gloss Aluminum, Palette, Laminate or Wood, please specify requirement on order.

	5144211225	1039	1142		21.5	12	25	55	7
	5144251225	1173	1292		25	12	25	61	8
	5144311225	1311	1441		31	12	25	69	9.5

ORDERING NOTE: Base plates are available in Gloss Aluminum, Palette, Laminate or Wood, please specify requirement on order.

	5146184725	2500	2747		18	47	25	118	19
	5146187125	3208	3529		18	71	25	175	28
	5146247125	4185	4604		24	71	25	270	41
	5146249525	5345	5878		24	95	25	308	46.5
	51462410725	6308	6938		24	107	25	346	52

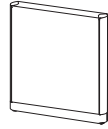
ORDERING NOTE: Base plates are available in Gloss Aluminum, Palette, Laminate or Wood, please specify requirement on order.

	5147182725	1192	1309		18	27	25	46	11.5
	5147183925	1612	1773		18	39	25	65	16
	5147186325	2168	2385		18	63	25	102	25
	5147189925	2996	3294		18	99	25	157	38
	51471812325	3706	4072		18	123	25	193	47
	51471817125	4998	5498		18	171	25	267	65
	5147246325	2576	2831		24	63	25	134	31.5
	5147249925	3088	3396		24	99	25	207	48.5
	51472412325	4366	4802		24	123	25	256	60
	51472417125	5766	6343		24	171	25	351	82.5
51472421925	6504	7154		24	219	25	451	105	

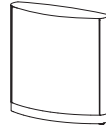
ORDERING NOTE: Base plates are available in Gloss Aluminum, Palette, Laminate or Wood, please specify requirement on order. Rectangular island bases greater than 99" are constructed in two pieces requiring assembly in the field.

NUVO | BASE REQUIREMENTS CHART

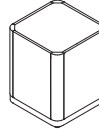
Panel Base
5139



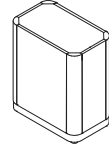
Oval Base
5145



Square Base
5143



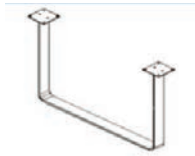
Rectangular Base
5144



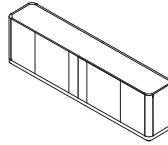
Model#	Quantity	Size	Quantity	Size	Quantity	Size	Quantity	Size
BASE REQUIREMENTS FOR RECTANGULAR (5161) & ARC END (5166) TOPS								
60-36	2	21	2	21				
60-42	2	21	2	21				
60-48	2	21	2	21				
72-36	2	21	2	21				
72-42	2	21	2	21				
72-48	2	21	2	21				
78-36	2	21	2	21			2	21
78-42	2	21	2	21			2	21
78-48	2	21	2	21			2	21
84-36	2	21	2	21			2	21
84-42	2	21	2	21			2	21
84-48	2	21	2	21			2	21
96-36	2	21	2	21	2	16	2	21
96-42	2	21	2	21	2	16	2	21
96-48	2	21	2	21	2	20	2	21
108-42	2	21	2	21	2	16	2	21
108-48	2	21	2	21	2	20	2	21
108-54	2	25	2	25	2	24	2	25
120-42	2	21	2	21	2	16	2	21
120-48	2	21	2	21	2	20	2	21
120-54	2	25	2	25	2	24	2	25
120-60	2	25	2	25	2	24	2	25
144-48	3	21	3	21	2	20	3	21
144-54	3	25	3	25	2	24	3	25
144-60	3	25	3	25	2	24	3	25
156-54	3	25	3	25	2	24	3	25
156-60	3	25	3	25	2	24	3	25
168-48	3	21	3	21	3	20	3	21
168-54	3	25	3	25	3	24	3	25
168-60	3	25	3	25	3	24	3	25
192-48	3	21	3	21	3	20	3	21
192-54	3	25	3	25	3	24	3	25
192-60	3	25	3	25	3	24	3	25
216-54	4	25	4	25	3	24	4	25
216-60	4	25	4	25	3	24	4	25
240-60	4	25	4	25	3	24	4	25
264-60	4	25	4	25	3	24	4	25
288-60	5	25	5	25	4	24	5	25

NUVO | BASE REQUIREMENTS CHART

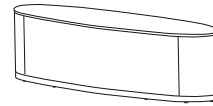
Formed Metal Base
5141



Rectangular Island Base
5147



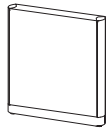
Oval Island Base
5146



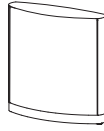
Model#	Quantity	Size	Quantity	Size	Quantity	Size
BASE REQUIREMENTS FOR RECTANGULAR (5161) & ARC END (5166) TOPS						
60-36	2	24				
60-42	2	24				
60-48	2	36	1	18x27		
72-36	2	24				
72-42	2	24				
72-48	2	36	1	18x27		
78-36	2	24				
78-42	2	24				
78-48	2	36	1	18x39		
84-36	2	24				
84-42	2	24				
84-48	2	36	1	18x39		
96-36	2	24				
96-42	2	24				
96-48	2	36	1	18x39		
108-42	2	24				
108-48	2	36	1	18x63		
108-54	2	36	1	24x63		
120-42	2	24				
120-48	2	36	1	18x63		
120-54	2	36	1	24x63		
120-60	2	48	1	24x63		
144-48	3	36	1	18x99		
144-54	3	36	1	24x99		
144-60	3	48	1	24x99		
156-54	3	36	1	24x99		
156-60	3	48	1	24x99		
168-48	3	36	1	18x123		
168-54	3	36	1	24x123		
168-60	3	48	1	24x123		
192-48	3	36	1	18x123		
192-54	3	36	1	24x123		
192-60	3	48	1	24x123		
216-54	4	36	1	24x171		
216-60	4	48	1	24x171		
240-60	4	48	1	24x171		
264-60	4	48	1	24x219		
288-60	5	48	1	24x219		

NUVO | BASE REQUIREMENTS CHART

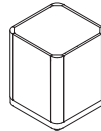
Panel Base
5139



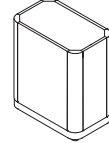
Oval Base
5145



Square Base
5143

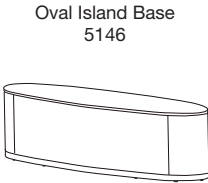
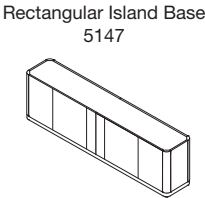


Rectangular Base
5144



Model#	Quantity	Size	Quantity	Size	Quantity	Size	Quantity	Size
BASE REQUIREMENTS FOR RACETRACK TOPS - (5102)								
60-36	2	21	2	21				
60-42	2	21	2	21				
60-48	2	21	2	21				
72-36	2	21	2	21				
72-42	2	21	2	21				
72-48	2	21	2	21				
78-36	2	21	2	21			2	21
78-42	2	21	2	21			2	21
78-48	2	21	2	21			2	21
84-36	2	21	2	21			2	21
84-42	2	21	2	21			2	21
84-48	2	21	2	21			2	21
96-36	2	21	2	21	2	16	2	21
96-42	2	21	2	21	2	16	2	21
96-48	2	21	2	21	2	20	2	21
108-42	2	21	2	21	2	16	2	21
108-48	2	21	2	21	2	20	2	21
108-54	2	21	2	21	2	20	2	21
120-42	2	21	2	21	2	16	2	21
120-48	2	21	2	21	2	20	2	21
120-54	2	21	2	21	2	20	2	21
120-60	2	25	2	25	2	24	2	25
144-48	3	21	3	21	2	20	3	21
144-54	3	21	3	21	2	20	3	21
144-60	3	25	3	25	2	24	3	25
156-54	3	21	3	21	2	20	3	21
156-60	3	25	3	25	2	24	3	25
168-48	3	21	3	21	3	20	3	21
168-54	3	21	3	21	3	20	3	21
168-60	3	25	3	25	3	24	3	25
192-48	3	21	3	21	3	20	3	21
192-54	3	21	3	21	3	20	3	21
192-60	3	25	3	25	3	24	3	25
216-54	4	21	4	21	3	20	4	21
216-60	4	25	4	25	3	24	4	25
240-60	4	25	4	25	3	24	4	25
264-60	4	25	4	25	3	24	4	25
288-60	5	25	5	25	4	24	5	25

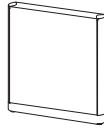
NUVO | BASE REQUIREMENTS CHART



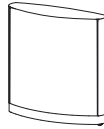
Model#	Quantity	Size	Quantity	Size	Quantity	Size
BASE REQUIREMENTS FOR RACETRACK TOPS - (5102)						
60-36	2	24				
60-42	2	24				
60-48	2	36	1	18x27		
72-36	2	24				
72-42	2	24				
72-48	2	36	1	18x27		
78-36	2	24				
78-42	2	24				
78-48	2	36	1	18x39		
84-36	2	24				
84-42	2	24				
84-48	2	36	1	18x39		
96-36	2	24				
96-42	2	24				
96-48	2	36	1	18x39		
108-42	2	24				
108-48	2	36	1	18x63		
108-54	2	36	1	18x63		
120-42	2	24				
120-48	2	36	1	18x63		
120-54	2	36	1	18x63		
120-60	2	48	1	24x63		
144-48	3	36	1	18x99		
144-54	3	36	1	18x99		
144-60	3	48	1	24x99		
156-54	3	36	1	18x99		
156-60	3	48	1	24x99		
168-48	3	36	1	18x123		
168-54	3	36	1	18x123		
168-60	3	48	1	24x123		
192-48	3	36	1	18x123		
192-54	3	36	1	18x123		
192-60	3	48	1	24x123		
216-54	4	36	1	18x171		
216-60	4	48	1	24x171		
240-60	4	48	1	24x171		
264-60	4	48	1	24x219		
288-60	5	48	1	24x219		

NUVO | BASE REQUIREMENTS CHART

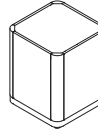
Panel Base
5139



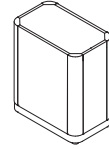
Oval Base
5145



Square Base
5143



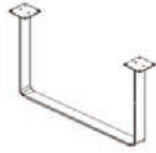
Rectangular Base
5144



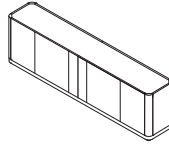
Model#	Quantity	Size	Quantity	Size	Quantity	Size	Quantity	Size
BASE REQUIREMENTS FOR BOAT-SHAPED TOPS - (5164)								
96-48-42	2	21	2	21	2	20	2	21
96-54-42	2	21	2	21	2	20	2	21
120-48-42	2	21	2	21	2	20	2	21
120-54-42	2	21	2	21	2	20	2	21
144-48-42	3	21	3	21	2	20	3	21
144-54-42	2	21	2	21	2	20	2	21
	1	25	1	25			1	25
168-54-42	2	21	2	21	2	20	2	21
	1	25	1	25	1	24	1	25
192-54-42	2	21	2	21	2	20	2	21
	1	25	1	25	1	24	1	25
216-60-48	2	21	2	21	2	20	2	21
	2	25	2	25	1	24	2	25
240-60-48	2	21	2	21	2	20	2	21
	2	25	2	25	1	24	2	25
264-60-48	2	21	2	21	2	20	2	21
	2	25	2	25	2	24	2	25
288-60-48	4	21	4	21	2	20	4	21
	1	25	1	25	2	24	1	25
BASE REQUIREMENTS FOR VISIO TOPS - (5168)								
120-60-42	2	21	2	21	2	20	2	21
144-60-42	3	21	3	21	2	20	3	21
168-66-42	2	21	2	21	2	20	2	21
	1	31	1	31	1	30	1	31
192-69-42	2	21	2	21	2	20	2	21
	1	31	1	31	1	30	1	31
216-73-42	2	21	2	21	2	20	2	21
	2	31	2	31	1	30	2	31
240-76-42	2	21	2	21	2	20	2	21
	2	31	2	31	1	30	2	31

NUVO | BASE REQUIREMENTS CHART

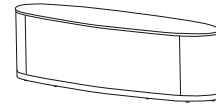
Formed Metal Base
5141



Rectangular Island Base
5147



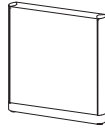
Oval Island Base
5146



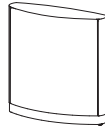
Model#	Quantity	Size	Quantity	Size	Quantity	Size
BASE REQUIREMENTS FOR BOAT-SHAPED TOPS - (5164)						
96-48-42	2	36				
96-54-42	2	36				
120-48-42	2	24				
120-54-42	2	36				
144-48-42	2	24				
	1	36				
144-54-42	3	36				
168-54-42	3	36				
192-54-42	3	36				
216-60-48	2	36				
	2	48				
240-60-48	2	36				
	2	48				
264-60-48	2	36				
	2	48				
288-60-48	4	36				
	1	48				
BASE REQUIREMENTS FOR VISIO TOPS - (5168)						
120-60-42	1	36				
	1	48				
144-60-42	1	24				
	1	36				
	1	48				
168-66-42	1	24				
	1	36				
	1	48				
192-69-42	1	24				
	1	36				
	1	48				
216-73-42	1	24				
	1	36				
	2	48				
240-76-42	1	24				
	1	36				
	2	48				

NUVO | BASE REQUIREMENTS CHART

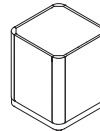
Panel Base
5139



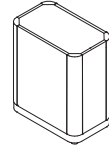
Oval Base
5145



Square Base
5143



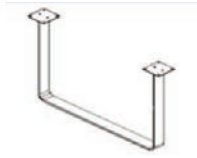
Rectangular Base
5144



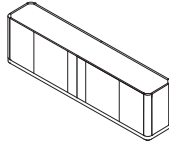
Model#	Quantity	Size	Quantity	Size	Quantity	Size	Quantity	Size
BASE REQUIREMENTS FOR OVAL TOPS - (5159)								
84-48	2	21	2	21				
96-48	2	21	2	21				
96-54	2	21	2	21				
120-48	2	21	2	21				
120-60	2	21	2	21				
144-54	3	21	3	21				
144-60	2	21	2	21				
	1	25	1	25				
168-60	2	21	2	21				
	1	25	1	25				

NUVO | BASE REQUIREMENTS CHART

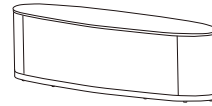
Formed Metal Base
5141



Rectangular Island Base
5147



Oval Island Base
5146



Model#	Quantity	Size	Quantity	Size	Quantity	Size
BASE REQUIREMENTS FOR OVAL TOPS - (5159)						
84-48	2	24			1	18x47
96-48	2	24			1	18x47
96-54	2	36			1	18x47
120-48	2	24			1	18x71
120-60	2	36			1	24x71
144-54	1	36			1	24x95
	2	24				
144-60	1	48			1	24x95
	2	24				
168-60	1	48			1	24x107
	2	24				

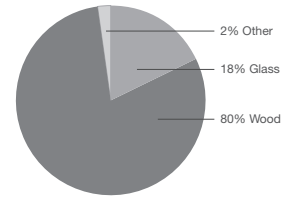
NUVO | LEED CI CREDIT SUMMARY

LEED CI - Credit Summary

NUVO CONFERENCE



MATERIAL CONTENT



PRE-CONSUMER RECYCLED CONTENT - 81%

POST-CONSUMER RECYCLE CONTENT - 3%

CONTRIBUTES TO

CREDIT 2.1 - 2.2	Construction Waste Management	1-2 point(s)
CREDIT 4.1	Recycled Content	1 point
CREDIT 4.2	Recycled Content	1 point
CREDIT 4.5	Low Emitting Materials, (MUST BE REQUESTED)	
	Composite Wood & Laminate Adhesives	1 point
CREDIT 5.1	Regional Materials*	1 point
CREDIT 6	Rapidly Renewable Materials (MUST BE REQUESTED)	1 point
CREDIT 7	Certified Wood (MUST BE REQUESTED)	1 point

* This credit is only applicable if in total 20% of the combined value of the procurement of construction materials and in the furniture are manufactured within a radius of 500 miles. This credit will apply if the installation of the finished product occurs within 500 miles of Kitchener, Ontario.

Nuvo Media & Storage products compliment Nuvo Conference with 6 veneer species selections. Veneered tops are 1 1/2" thick veneered particle board core and backer material, with a 1/8" wood edge. Laminate tops are 1 1/2" thick with particle board core and backer material, with a matching laminate edge. Glass tops are back painted tempered glass with an 1 1/8" medium density fiberboard painted sub top with bevelled edge. Tops are available with these profiles.



Edge profile for wood & laminate tops



Edge profile for glass tops

SURFACES

Buffet and Credenza tops are 1 1/2" thick 45lbs per cubic feet particle board core, 3 ply. Gables are 3/4" thick 45lbs per cubic feet particle board core, 3 ply.

VENEER

Veneers available are Rift White Oak, Quarter Cut Maple, Quarter Cut Cherry, Quarter Cut Walnut

LAMINATE

Please note the grain direction of wood grain laminate will run horizontal on the backs of credenzas and buffets. Laminate tops are 1 1/2" thick with particle board core and backer material, with a matching laminate edge.

FINISH

A five step catalyzed varnish finish that when dry has a sheen value of 32°, is applied to all tables, bases and cases. A lower sheen topcoat, 20°, can also be specified, at standard pricing. All purchase orders must clearly note "lower sheen finish" in order to receive this optional selection.

All finished surfaces are well sanded before applying finishing materials. The procedure begins by applying a base color via an NGR stain. A wash coat follows to further enhance the color. Next is the glazing process, which provides the 3rd color step and fills the pores of the wood. A sealer coat is then applied, twice to the horizontal worksurfaces to enhance the finish. The product is then scuff sanded to prepare for the top coat. The top coat is a catalyzed varnish that when dry has a sheen value of 32°. Krug's catalyzed varnish has been tested to be one of the industry's most durable and long lasting. Custom finishes are available

GLIDES

Credenzas and Buffets feature adjustable glides 1 1/2" long and allow for a range of adjustment of 3/4".

GLASS SURFACE

Nuvo Casegood tops are available in white back-painted 10mm tempered glass. Please contact customer service, for additional color selections available at no upcharge.

TESTING

All products have been tested in accordance with ANSI/BIFMA X5.5-2014 or X5.9-2012.

DRAWERS

Desk box drawers have full progressive full extension slides and are load rated at 100lbs. per drawer. All drawer interiors are veneer on plywood, and include a push to open drawer mechanism.

LATCHES

Doors open with a touch latch. There are no pulls on Nuvo Media & Storage.

HINGES

Nuvo Media & Storage utilize European style satin chrome hinges with 3-way adjustment & quick release feature. Hinge opening is 95 degrees.

CASTERS

Locking casters are standard on the Hospitality Cart and lectern.

SLIDING DOORS

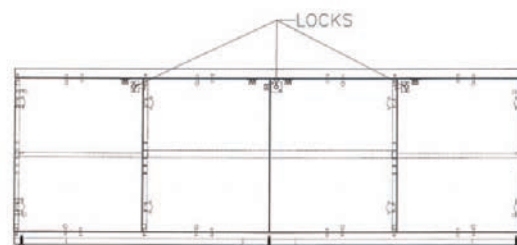
Sliding Doors include a single roller track system.

BACK-PAINTED GLASS DOORS

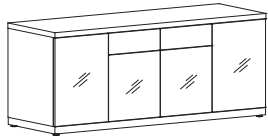
Nuvo glass doors have Back-Painted glass with a satin aluminum frame.

LOCKS

Locks are optional on hinged wood doors at an upcharge of **\$152 list** per set of 2 doors and **\$152 list** per single door. Buffets and Credenzas with 2 outside doors require 3 locks.

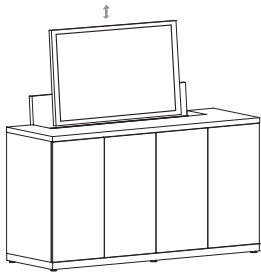
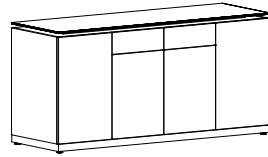


NUVO | FEATURES & OPTIONS



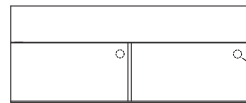
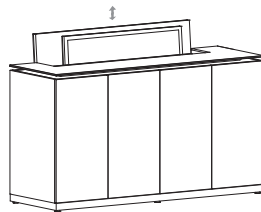
CREDENZAS AND BUFFETS

- 2 styles of cabinet tops are available: wood top and Back-Painted glass tops.
- Doors are available in Back-Painted glass & wood veneer.
- Storage sections feature one wooden shelf which is height adjustable in increments of 1 1/4".
- Buffets with wood drawers can include an optional cutlery insert.
- Buffet may be specified with optional Recycle/Waste bin.
- Buffet may be specified with optional Mini Refrigerator on 24" deep Buffets at a price of **\$2638 list**.
- Mini refrigerator features volume of 1.1 cu. ft., 2 inner door racks, automatic defrost, and lock.
- Credenzas and Buffets with glass tops are shipped with tops assembled to case.



TV CABINET WITH LIFT

- Accommodate flat screen televisions up to 130lbs with dimensions no greater than 51 1/4"W x 4 3/4"D x 30"H
- Cabinet is standard with 4 shelves 12 1/2" deep.
- Includes a remote control to raise and lower the television. Remote has a radio frequency control with 15 ft. operating distance
- 2 styles of cabinet tops are available: wood top and Back-Painted glass tops.
- Cable access in shelves and partition

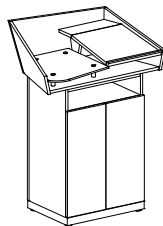


Grommet in each shelf & partition for cord pass through

GROMMET IN EACH SHELF FOR CORD PASS THROUGH

HOSPITALITY CARTS

- The cart is mounted on heavy-duty locking casters.
- A handle on each end facilitates movement of the cart. Handles are available in a satin aluminum finish.
- The cart features a stainless steel container with removable plastic garbage & recycling bins. A cutlery tray is included.
- 2 styles of cabinet tops are available: wood top and Back-Painted glass tops.
- 2 adjustable shelves behind large door



LECTERNS

- Glass shelf version has a wood upper flat shelf which provides a place for pens, pencils or a glass of water, and optional reference light at a price of **\$443 list**. It will also accommodate a user-specified microphone.
- Angled wood shelf has a bottom lip to hold papers in place. The shelf lifts to reveal an optional power and data interface point
- Back-Painted glass shelf provides more surface area for equipment such as a laptop. A presenter's open laptop is not visible to the seated audience.
- Cables from the interface point, (or user supplied cables) are routed down through grommeted holes to the bottom of the unit and are accessible via doors on the users side. Optional power bar at a price of **\$208 list**.
- Full width shelf version is available.
- Mobile versions are available.
- Glass shelf is shipped installed.

NUVO | FEATURES & OPTIONS



BASE PLATES

- Available in a choice of Wood, Laminate, or Gloss Aluminum finish.



RECYCLE/WASTE BIN

- Stainless Steel sliding bin containing 2 x 14 L plastic bins for recycling and waste. Opens with the door.
- Approximate dimensions 14.25 x 17.33 x 16.53



BACK-PAINTED GLASS TOPS

- Back-Painted glass tops are 10mm thick and available as an option.



CUTLERY TRAY

- Surface silver grained
- Impact-resistant polystyrene
- Environmentally friendly, fully recyclable
- Antistatic, easy to clean

ALTINEX BOX

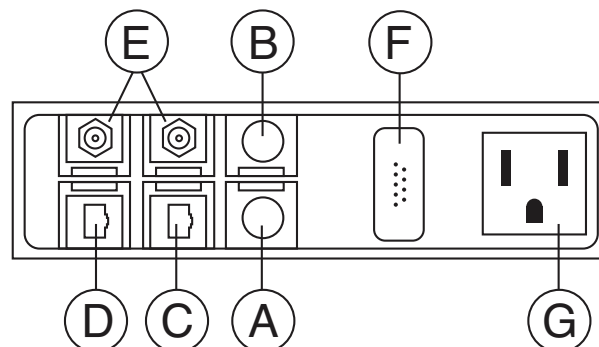
The Altinex box offers an ideal solution for the power and data requirements of a speaker using the NUVO Lectern.

Altinex features the following power/data connectors:

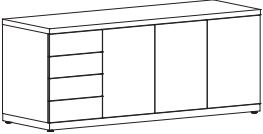
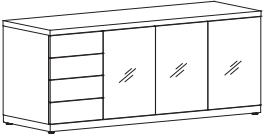
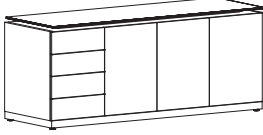
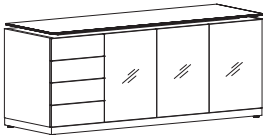
A	(1) Stereo Mini	3.5 mm Mini pass-through connector from computer sound card to amplified sound system
B	(1) BNC port	High quality pass-through connector from broadcast video or computer video to video display monitor
C	(1) RJ11 port	Connection for Telephone / Modem
D	(1) RJ45 port	Connection for Network Connector
E	(2) RCA ports	Female RCA type pass-through (Left - Black, Right - Red) cable connectors from stereo audio source to audio system
F	(1) 15 Pin HD port	VGA type 15 pin pass-through connector from computer video to display monitor
G	(1) Simplex Power port	Power Input

For more information or questions regarding the Altinex Box, please contact Krug Customer Service or Altinex Technical Support at 1-800-258-4623.

This option is available on NUVO lecterns at an upcharge of **\$1273 list**.



NUVO | CREDENZAS

Description	Model	Oak Cherry Maple Laminate			W	D	H	Weight	Cube
		Walnut							
 3 Hinged Doors, 4 Drawers	51C72202907	5955	6550	71.5	20	29.9	309	31	
	51C72242907	6237	6861	71.5	24	29.9	321	36	
	51C84202907	6846	7532	83.5	20	29.9	360	36	
	51C84242907	7173	7889	83.5	24	29.9	374	42	
 Back-Painted Glass Doors, 4 Drawers	51C72202907Z	7498	8249	71.5	20	29.9	323	31	
	51C72242907Z	7781	8559	71.5	24	29.9	383	36	
	51C84202907Z	8622	9486	83.5	20	29.9	376	36	
	51C84242907Z	8947	9841	83.5	24	29.9	446	42	
 3 Hinged Doors, 4 Drawers, Back-Painted Glass Top	51CGP72202907	8856	9739	71.5	20	29.9	349	31	
	51CGP72242907	9719	10691	71.5	24	29.9	369	36	
	51CGP84202907	10182	11199	83.5	20	29.9	406	36	
	51CGP84242907	11174	12291	83.5	24	29.9	429	42	
 Back-Painted Glass Doors, 4 Drawers, Back-Painted Glass Top	51CGP72202907Z	10399	11438	71.5	20	29.9	363	31	
	51CGP72242907Z	11262	12388	71.5	24	29.9	383	36	
	51CGP84202907Z	11958	13153	83.5	20	29.9	423	36	
	51CGP84242907Z	12951	14246	83.5	24	29.9	446	42	

ORDERING NOTES: An optional Recycle/Waste bin, located behind the right door, is available at an upcharge of **\$571 list**, add W - Waste Bin to the model number. An optional Cutlery Tray is available at an upcharge of **\$61 list**. An optional mini fridge, located behind the right door, is available on 24" deep units at an upcharge of **\$2638 list**, add F - fridge to model number.

ORDERING PROCEDURE

To order, please specify the following:

- 1) Krug product model number
- 2) Wood species and finish

CODE DESCRIPTION

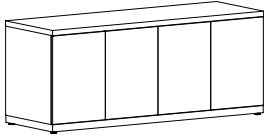
- GP - Back-Painted Glass Top
Z - Back-Painted Glass Doors

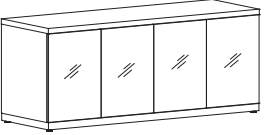
STANDARD FINISHES

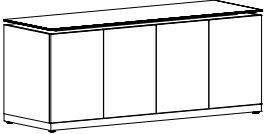
For a complete list of standard wood finishes, please see page 347

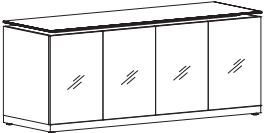
BASE PLATES

Base plates are available in Gloss Aluminum, Laminate or Wood, please specify requirement on order.

Description	Model	Oak Cherry Maple Laminate		W	D	H	Weight	Cube
		Walnut						
 4 Hinged Doors	51C72202911	4967	5464	71.5	20	29.9	265	31
	51C72242911	5248	5775	71.5	24	29.9	277	36
	51C84202911	5713	6284	83.5	20	29.9	309	36
	51C84242911	6036	6641	83.5	24	29.9	323	42

 4 Hinged Back-Painted Glass Doors	51C72202911Z	7024	7730	71.5	20	29.9	283	31
	51C72242911Z	7310	8040	71.5	24	29.9	295	36
	51C84202911Z	8079	8888	83.5	20	29.9	330	36
	51C84242911Z	8405	9245	83.5	24	29.9	344	42

 4 Hinged Doors, Back- Painted Glass Top	51CGP72202911	7866	8654	71.5	20	29.9	305	31
	51CGP72242911	8731	9604	71.5	24	29.9	325	36
	51CGP84202911	9048	9952	83.5	20	29.9	355	36
	51CGP84242911	10042	11044	83.5	24	29.9	379	42

 4 Hinged Back-Painted Glass Doors, Back-Painted Glass Top	51CGP72202911Z	9928	10918	71.5	20	29.9	323	31
	51CGP72242911Z	10790	11870	71.5	24	29.9	343	36
	51CGP84202911Z	11415	12556	83.5	20	29.9	376	36
	51CGP84242911Z	12408	13648	83.5	24	29.9	400	42

ORDERING NOTES: An optional Recycle/Waste bin is available at an upcharge of **\$571 list**, add WL - Waste Bin Left or WR - Waste Bin Right to the model number.

An optional mini fridge is available on 24" deep units, at an upcharge of **\$2638**, add FL fridge left or FR fridge right to model number.

DIMENSION KEY

W - width
D - depth
H - height

CODE DESCRIPTION

GP - Back-Painted Glass Top
Z - Back-Painted Glass Doors

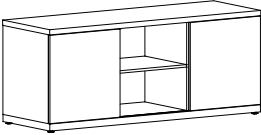
STANDARD FINISHES

For a complete list of standard wood finishes, please see page 347

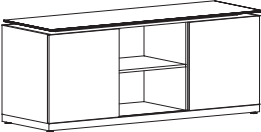
BASE PLATES

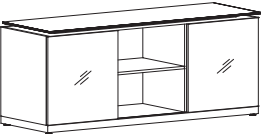
Base plates are available in Gloss Aluminum, Laminate or Wood, please specify requirement on order.

NUVO | CREDENZAS

Description	Model	Oak Cherry Maple Laminate			W	D	H	Weight	Cube
		Walnut							
	51CS72202911	5488	6036	71.5	20	29.9	246	31	
	51CS72242911	5769	6347	71.5	24	29.9	258	36	
	51CS84202911	6312	6941	83.5	20	29.9	287	36	
	51CS84242911	6634	7298	83.5	24	29.9	301	42	

	51CS72202911Z	6863	7549	71.5	20	29.9	259	31
	51CS72242911Z	7147	7862	71.5	24	29.9	271	36
	51CS84202911Z	7893	8681	83.5	20	29.9	302	36
	51CS84242911Z	8219	9040	83.5	24	29.9	316	42

	51CSGP72202911	8389	9225	71.5	20	29.9	286	31
	51CSGP72242911	9252	10177	71.5	24	29.9	306	36
	51CSGP84202911	9646	10612	83.5	20	29.9	333	36
	51CSGP84242911	10638	11704	83.5	24	29.9	356	42

	51CSGP72202911Z	9763	10741	71.5	20	29.9	299	31
	51CSGP72242911Z	10629	11691	71.5	24	29.9	319	36
	51CSGP84202911Z	11379	12518	83.5	20	29.9	348	36
	51CSGP84242911Z	12222	13445	83.5	24	29.9	372	42

ORDERING NOTES: An optional mini fridge is available on 24" deep units, at an upcharge of **\$2638**, add FL fridge left or FR fridge right to model number.

ORDERING PROCEDURE

To order, please specify the following:

- 1) Krug product model number
- 2) Wood species and finish

CODE DESCRIPTION

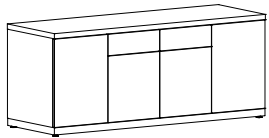
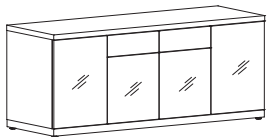
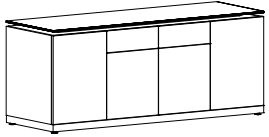
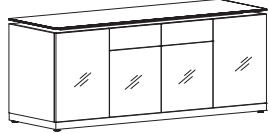
- GP - Back-Painted Glass Top
Z - Back-Painted Glass Doors

STANDARD FINISHES

For a complete list of standard wood finishes, please see page 347.

BASE PLATES

Base plates are available in Gloss Aluminum, Laminate or Wood, please specify requirement on order.

Description	Model	Oak Cherry Maple Laminate	Walnut	W	D	H	Weight	Cube	
	Door, Drawer/Door, Drawer/Door, Door	51C72202914	6044	6647	71.5	20	29.9	277	31
		51C72242914	6325	6959	71.5	24	29.9	289	36
		51C84202914	6948	7645	83.5	20	29.9	323	36
		51C84242914	7273	8002	83.5	24	29.9	337	42
	Back-Painted Glass Door, Drawer/Door, Drawer/Door, Door	51C72202914Z	7934	8727	71.5	20	29.9	295	31
		51C72242914Z	8217	9038	71.5	24	29.9	317	36
		51C84202914Z	9123	10035	83.5	20	29.9	344	36
		51C84242914Z	9447	10392	83.5	24	29.9	369	42
	Door, Drawer/Door, Drawer/Door, Door, Back-Painted Glass Top	51CGP72202914	8942	9838	71.5	20	29.9	317	31
		51CGP72242914	9808	10787	71.5	24	29.9	337	36
		51CGP84202914	10285	11313	83.5	20	29.9	369	36
		51CGP84242914	11279	12405	83.5	24	29.9	393	42
	Back-Painted Glass Door, Drawer/Door, Drawer/Door, Door, Back-Painted Glass Top	51CGP72202914Z	10834	11917	71.5	20	29.9	335	31
		51CGP72242914Z	11699	12866	71.5	24	29.9	365	36
		51CGP84202914Z	12460	13707	83.5	20	29.9	390	36
		51CGP84242914Z	13454	14798	83.5	24	29.9	425	42

ORDERING NOTES: An optional Recycle/Waste bin is available at an upcharge of **\$571 list**, add WL - Waste Bin Left or WR - Waste Bin Right to the model number. An optional Cutlery Tray is available at an upcharge of **\$61 list**. Mini fridge is not available in this configuration.

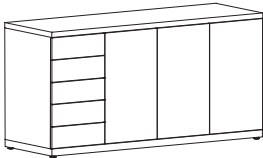
DIMENSION KEY
W - width
D - depth
H - height

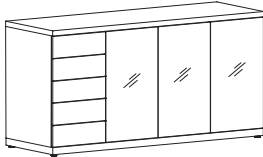
CODE DESCRIPTION
GP - Back-Painted Glass Top
Z - Back-Painted Glass Doors

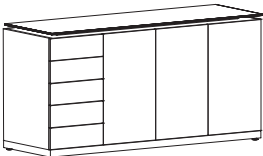
STANDARD FINISHES
For a complete list of standard wood finishes, please see page 347.

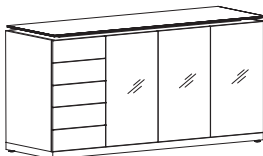
BASE PLATES
Base plates are available in Gloss Aluminum, Laminate or Wood, please specify requirement on order.

NUVO | BUFFETS

Description	Model	Oak Cherry Maple Laminate			W	D	H	Weight	Cube
		Walnut							
	51BU72203507	6367	7005	71.5	20	35	330	36	
	51BU72243507	6652	7316	71.5	24	35	343	42	
	51BU84203507	7323	8057	83.5	20	35	384	42	
	51BU84243507	7649	8413	83.5	24	35	400	49	

	51BU72203507Z	7911	8703	71.5	20	35	345	36
	51BU72243507Z	8195	9013	71.5	24	35	358	42
	51BU84203507Z	9097	10007	83.5	20	35	402	42
	51BU84243507Z	9423	10367	83.5	24	35	417	49

	51BUGP72203507	9269	10196	71.5	20	35	370	36
	51BUGP72243507	10132	11144	71.5	24	35	391	42
	51BUGP84203507	10659	11724	83.5	20	35	431	42
	51BUGP84243507	11653	12818	83.5	24	35	455	49

	51BUGP72203507Z	10812	11893	71.5	20	35	385	36
	51BUGP72243507Z	11676	12845	71.5	24	35	406	42
	51BUGP84203507Z	12433	13676	83.5	20	35	448	42
	51BUGP84243507Z	13430	14771	83.5	24	35	473	49

ORDERING NOTES: An optional Recycle/Waste bin, located behind the right door, is available at an upcharge of **\$571 list**, add W - Waste Bin to the model number. An optional Cutlery Tray is available at an upcharge of **\$61 list**. An optional mini fridge, located behind the right door, is available on 24" deep units at an upcharge of **\$2638**, add F - fridge to model number.

ORDERING PROCEDURE

To order, please specify the following:
 1) Krug product model number
 2) Wood species and finish

CODE DESCRIPTION

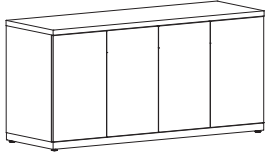
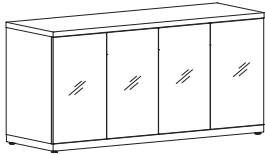
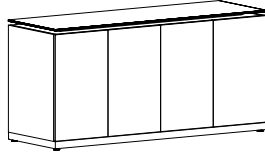
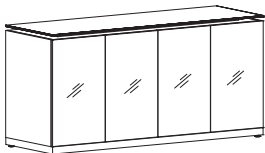
GP - Back-Painted Glass Top
 Z - Back-Painted Glass Doors

STANDARD FINISHES

For a complete list of standard wood finishes, please see page 347.

BASE PLATES

Base plates are available in Gloss Aluminum, Laminate or Wood, please specify requirement on order.

Description	Model	Oak Cherry Maple Laminate		W	D	H	Weight	Cube
		Walnut						
4 Hinged Doors 	51BU72203511	5137	5649	71.5	20	35	266	36
	51BU72243511	5419	5961	71.5	24	35	279	42
	51BU84203511	5905	6496	83.5	20	35	310	42
	51BU84243511	6230	6855	83.5	24	35	325	49
4 Hinged Back-Painted Glass Doors 	51BU72203511Z	7193	7913	71.5	20	35	286	36
	51BU72243511Z	7478	8225	71.5	24	35	299	42
	51BU84203511Z	8275	9100	83.5	20	35	333	42
	51BU84243511Z	8597	9459	83.5	24	35	348	49
4 Hinged Doors, Back- Painted Glass Top 	51BUGP72203511	8037	8839	71.5	20	35	306	36
	51BUGP72243511	8899	9790	71.5	24	35	327	42
	51BUGP84203511	9241	10167	83.5	20	35	356	42
	51BUGP84243511	10235	11259	83.5	24	35	381	49
4 Hinged Back-Painted Glass Doors, Back-Painted Glass Top 	51BUGP72203511Z	10094	11110	71.5	20	35	326	36
	51BUGP72243511Z	10959	12056	71.5	24	35	347	42
	51BUGP84203511Z	11610	12771	83.5	20	35	380	42
	51BUGP84243511Z	12604	13861	83.5	24	35	404	49

ORDERING NOTES: An optional Recycle/Waste bin, located behind the right door, is available at an upcharge of **\$571 list**, add W - Waste Bin to the model number. An optional Cutlery Tray is available at an upcharge of **\$61 list**. An optional mini fridge, located behind the right door, is available on 24" deep units at an upcharge of **\$2638**, add F - fridge to model number.

DIMENSION KEY

W - width
D - depth
H - height

CODE DESCRIPTION

GP - Back-Painted Glass Top
Z - Back-Painted Glass Doors

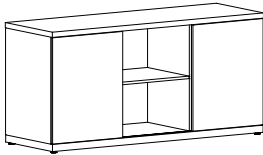
STANDARD FINISHES

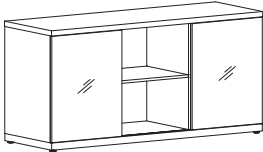
For a complete list of standard wood finishes, please see page 347.

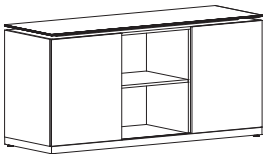
BASE PLATES

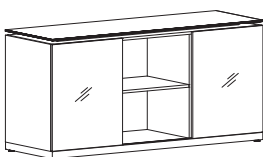
Base plates are available in Gloss Aluminum, Laminate or Wood, please specify requirement on order.

NUVO | BUFFETS

Description	Model	Oak	Cherry	Walnut	W	D	H	Weight	Cube
		Maple	Laminate						
	51BUS72203511	5657	6222	71.5	20	35	252	36	
	51BUS72243511	5939	6534	71.5	24	35	265	42	
	51BUS84203511	6505	7155	83.5	20	35	294	42	
	51BUS84243511	6831	7513	83.5	24	35	309	49	

	51BUS72203511Z	7199	7920	71.5	20	35	267	36
	51BUS72243511Z	7484	8232	71.5	24	35	280	42
	51BUS84203511Z	8280	9109	83.5	20	35	311	42
	51BUS84243511Z	8607	9467	83.5	24	35	326	49

	51BUSGP72203511	8556	9412	71.5	20	35	292	36
	51BUSGP72243511	9419	10363	71.5	24	35	313	42
	51BUSGP84203511	9840	10826	83.5	20	35	340	42
	51BUSGP84243511	10834	11917	83.5	24	35	365	49

	51BUSGP72203511Z	10101	11110	71.5	20	35	307	36
	51BUSGP72243511Z	10964	12062	71.5	24	35	328	42
	51BUSGP84203511Z	11617	12778	83.5	20	35	358	42
	51BUSGP84243511Z	12610	13873	83.5	24	35	382	49

ORDERING NOTES: An optional mini fridge is available on 24" deep units at an upcharge of **\$2638**, add FL fridge left or FR fridge right to model number.

ORDERING PROCEDURE

To order, please specify the following:
 1) Krug product model number
 2) Wood species and finish

CODE DESCRIPTION

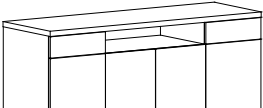
GP - Back-Painted Glass Top
 Z - Back-Painted Glass Doors

STANDARD FINISHES

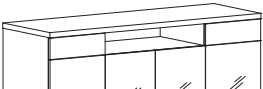
For a complete list of standard wood finishes, please see page 347.

BASE PLATES

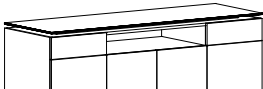
Base plates are available in Gloss Aluminum, Laminate or Wood, please specify requirement on order.

Description	Model	Oak	Cherry	Walnut	W	D	H	Weight	Cube
		Maple	Laminate						
 Drawer/Door, Open/ 2 Doors, Drawer/Door	51BU72203513	6211	6833	6833	71.5	20	35	294	36
	51BU72243513	6495	7145	7145	71.5	24	35	307	42
	51BU84203513	7145	7860	7860	83.5	20	35	342	42
	51BU84243513	7467	8215	8215	83.5	24	35	358	49

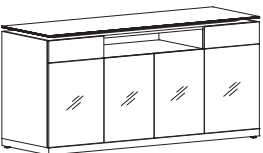
NOTE: For Media Buffet version with vents & cable access add M to model number and **\$530 list.**

 Back-Painted Glass Drawer/Door, Open/2 Doors, Drawer/Door	51BU72203513Z	8269	9096	9096	71.5	20	35	313	36
	51BU72243513Z	8553	9410	9410	71.5	24	35	326	42
	51BU84203513Z	9511	10463	10463	83.5	20	35	365	42
	51BU84243513Z	9836	10818	10818	83.5	24	35	380	49

NOTE: For Media Buffet version with vents & cable access add M to model number and **\$530 list.**

 Drawer/Door, Open/ 2 Doors, Drawer/Door, Back-Painted Glass Top	51BUGP72203513	9114	10022	10022	71.5	20	35	334	36
	51BUGP72243513	9975	10975	10975	71.5	24	35	355	42
	51BUGP84203513	10481	11527	11527	83.5	20	35	389	42
	51BUGP84243513	11472	12618	12618	83.5	24	35	413	49

NOTE: For Media Buffet version with vents & cable access add M to model number and **\$530 list.**

 Back-Painted Glass Drawer/Door, Open/2 Doors, Drawer/Door, Back-Painted Glass Top	51BUGP72203513Z	11170	12287	12287	71.5	20	35	353	36
	51BUGP72243513Z	12035	13240	13240	71.5	24	35	374	42
	51BUGP84203513Z	12846	14130	14130	83.5	20	35	411	42
	51BUGP84243513Z	13842	15222	15222	83.5	24	35	436	49

NOTE: For Media Buffet version with vents & cable access add M to model number and **\$530 list.**

ORDERING NOTES: An optional Recycle/Waste bin, located behind the right door, is available at an upcharge of **\$571 list**, add W - Waste Bin to the model number. An optional Cutlery Tray is available at an upcharge of **\$61 list**. An optional mini fridge, located behind the right door, is available on 24" deep units at an upcharge of **\$2638**, add F - fridge to model number.

DIMENSION KEY

W - width
D - depth
H - height

CODE DESCRIPTION

GP - Back-Painted Glass Top
Z - Back-Painted Glass Doors

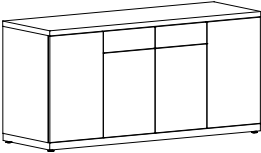
STANDARD FINISHES

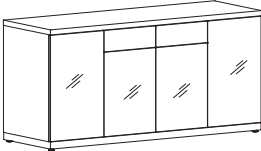
For a complete list of standard wood finishes, please see page 347.

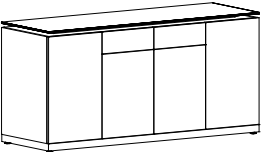
BASE PLATES

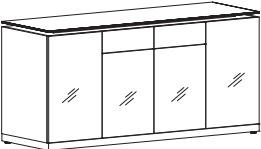
Base plates are available in Gloss Aluminum, Laminate or Wood, please specify requirement on order.

NUVO | BUFFETS

Description	Model	Oak Cherry Maple Laminate	Walnut	W	D	H	Weight	Cube
 Door, Drawer/Door, Drawer/Door, Door	51BU72203514	6211	6833	71.5	20	35	298	36
	51BU72243514	6495	7145	71.5	24	35	311	42
	51BU84203514	7145	7860	83.5	20	35	347	42
	51BU84243514	7467	8215	83.5	24	35	362	49

 Back-Painted Glass Door, Drawer/Door, Drawer/Door, Door	51BU72203514Z	8529	9383	71.5	20	35	308	36
	51BU72243514Z	8812	9693	71.5	24	35	331	42
	51BU84203514Z	9809	10790	83.5	20	35	359	42
	51BU84243514Z	10133	11145	83.5	24	35	385	49

 Door, Drawer/Door, Drawer/Door, Door, Back-Painted Glass Top	51BUGP72203514	9114	10022	71.5	20	35	338	36
	51BUGP72243514	9975	10975	71.5	24	35	359	42
	51BUGP84203514	10481	11527	83.5	20	35	394	42
	51BUGP84243514	11472	12618	83.5	24	35	418	49

 Back-Painted Glass Door, Drawer/Door, Drawer/Door, Door, Back-Painted Glass Top	51BUGP72203514Z	11281	12407	71.5	20	35	348	36
	51BUGP72243514Z	12035	13240	71.5	24	35	379	42
	51BUGP84203514Z	12971	14269	83.5	20	35	405	42
	51BUGP84243514Z	13842	15222	83.5	24	35	441	49

ORDERING NOTES: An optional Recycle/Waste bin, located behind the right door, is available at an upcharge of **\$571 list**, add W - Waste Bin to the model number. An optional Cutlery Tray is available at an upcharge of **\$61 list**. An optional mini fridge, located behind the right door, is available on 24" deep units at an upcharge of **\$2638**, add F - fridge to model number.

ORDERING PROCEDURE

To order, please specify the following:
1) Krug product model number
2) Wood species and finish

CODE DESCRIPTION

GP - Back-Painted Glass Top
Z - Back-Painted Glass Doors

STANDARD FINISHES

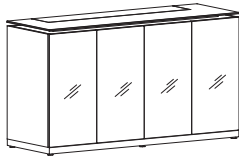
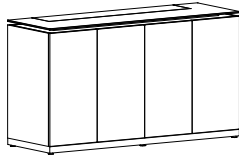
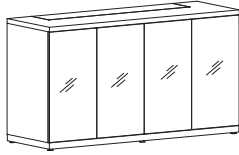
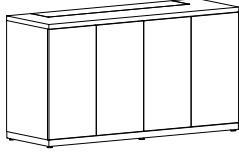
For a complete list of standard wood finishes, please see page 347.

BASE PLATES

Base plates are available in Gloss Aluminum, Laminate or Wood, please specify requirement on order.

NUVO | BUFFETS WITH TV LIFT

Description	Model	Oak	Cherry	Walnut	W	D	H	Weight	Cube
		Maple	Laminate						
4 Doors with TV Lift	51TV722439	12791		14070	71.5	24	39	345	49
	51TV842439	14711		16180	83.5	24	39	402	57
4 Back-Painted Glass Doors with TV Lift	51TV722439Z	16794		18474	71.5	24	39	368	49
	51TV842439Z	19313		21245	83.5	24	39	429	57
4 Doors with TV Lift, Back-Painted Glass Top	51TVGP722439	14334		15767	71.5	24	39	372	49
	51TVGP842439	16483		18132	83.5	24	39	433	57
4 Back-Painted Glass Doors with TV Lift, Back-Painted Glass Top	51TVGP722439Z	18339		20171	71.5	24	39	395	49
	51TVGP842439Z	21090		23198	83.5	24	39	460	57



ORDERING NOTE: Cabinet is standard with 4 shelves 12 1/2" deep.

DIMENSION KEY

W - width
D - depth
H - height

CODE DESCRIPTION

GP - Back-Painted Glass Top
Z - Back-Painted Glass Doors

STANDARD FINISHES

For a complete list of standard wood finishes, please see page 347.

BASE PLATES

Base plates are available in Gloss Aluminum, Laminate or Wood, please specify requirement on order.

NUVO | HOSPITALITY CARTS

Description	Model	Laminate			W	D	H	Weight	Cube
		Oak Cherry Maple	Walnut						
Hospitality Cart	51MSC422035	4928	5420		42	20	35	213	22



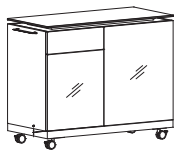
Hospitality Cart - Back-Painted Glass Doors	51MSC422035Z	6144	6760		42	20	35	227	22
---	--------------	------	------	--	----	----	----	-----	----



Hospitality Cart, Back-Painted Glass Top	51MSCGP422035	6784	7463		42	20	35	240	22
--	---------------	------	------	--	----	----	----	-----	----



Hospitality Cart - Back-Painted Glass Doors, Back-Painted Glass Top	51MSCGP422035Z	8002	8803		42	20	35	275	22
---	----------------	------	------	--	----	----	----	-----	----



ORDERING NOTES:

Hospitality Cart is standard with Cutlery Tray & Recycle/Waste bin on the left and two adjustable shelves on the right.

ORDERING PROCEDURE

To order, please specify the following:

- 1) Krug product model number
- 2) Wood species and finish

CODE DESCRIPTION

- GP - Back-Painted Glass Top
Z - Back-Painted Glass Doors

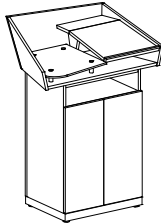
STANDARD FINISHES

For a complete list of standard wood finishes, please see page 347.

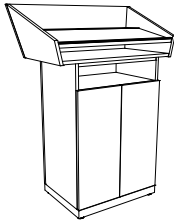
BASE PLATES

Base plates are available in Gloss Aluminum, Laminate or Wood, please specify requirement on order.

Description	Model	Oak Cherry Maple			W	D	H	Weight	Cube
		Laminate	Walnut						
Lectern with Glass Shelf & Closed Lower Storage	51LN372250-11	6827	7759		37	22	50	234	30

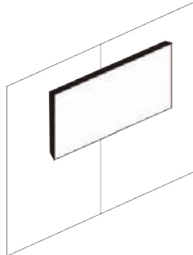


Lectern Full Width & Closed Lower Storage	51LN372250-11	5953	6544		37	22	50	230	30
---	---------------	------	------	--	----	----	----	-----	----



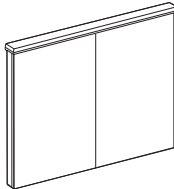
ORDERING NOTES: Lecterns feature grommets for cable management. Lecterns are available with casters, add M to the model # and an upcharge of **\$152**. All hinged doors on Lecterns feature standard locks.
 Lectern options:
 Altinex Box : **\$1273 list**.
 Power Bar : **\$208 list**
 Reference Light : **\$443 list**

Media Wall	51MW8483	3538	3892		84	4	83	115	16
------------	----------	------	------	--	----	---	----	-----	----



NOTES: Media Wall features a T.V. mounting bracket and cable channel for cords to exit at the floor. Media wall can be mounted without a credenza or buffet if no equipment other than the TV is required. Please include TV size on each purchase order, since machining required is dependent on the TV size.

Sliding Door Media Board	51VBS4848	4399	4841		48	-	48	120	16
--------------------------	-----------	------	------	--	----	---	----	-----	----



NOTE: Sliding Door Media Board includes white board, eraser and four dry erase makers. For laminate orders marker tray is Black Palette. Sliding Doors slide open and closed independently of each other.

DIMENSION KEY
 W - width
 D - depth
 H - height

CODE DESCRIPTION
 X - Full Width
 11 - Closed Shelves Below

STANDARD FINISHES
 For a complete list of standard wood finishes, please see page 347.

BASE PLATES
 Base plates are available in Gloss Aluminum, Laminate or Wood, please specify requirement on order.

GENERAL INFORMATION

Terms and Conditions

Net 30 days on approved credit. A late payment charge of 1% per month will be applied on overdue invoices. This charge will be pro-rated to the number of days past 30 days that the invoice is overdue. All applicable sales taxes are extra. Distribution of this price list does not in itself constitute an offer to sell. Orders can be received only from authorized Krug dealers. Acceptance of any order and terms of sale may be established at the discretion of Krug. Deposits are required on orders received from new accounts as well as on large or special orders. Krug reserves the right to discontinue designs, or to change designs, construction, prices, or materials without notice.

Contact Information

Phone: 1.888.578.KRUG (5784) | Fax: 1.519.748.5177

Purchase Order Fax: 1.888.236.4783

Purchase Order E-mail: orders@krug.ca

Web: www.krug.ca E-mail: solutions@krug.ca

Customer Service Hours

Please note customer service hours are:

8:30 am to 5:00 pm est

Customer Satisfaction

It is the primary goal of Krug and our staff to ensure the complete satisfaction of our customers with our products and performance. If a problem arises with a Krug product after the expiration of the limited warranty period, Krug will exercise its best efforts to achieve the satisfaction of the customer in a manner that is fair to all concerned.

Order Acknowledgments

Each order will be acknowledged via e-mail or fax. This acknowledgment is the final agreement between Krug and the customer, superseding all previous communications regarding the purchase order. Where there is a discrepancy on a purchase order between a product code and a description, Krug will make every effort to resolve the discrepancy, but will be ruled by the product code ordered. Please check all acknowledgments for accuracy, and advise Krug of any discrepancies with a purchase order.

Order Cancellation

Krug reserves the right to not accept or allow cancellation of orders. All products are manufactured on a custom-made, make-to-order basis, and the purchasing, engineering and production of orders begins shortly after order placement - and the customer purchase order is a contract that authorizes Krug to manufacture the products. Acceptance of order cancellation (or partial cancellation) is solely at the discretion of Krug, and is dependent on the extent to which engineering, purchasing and manufacturing has been initiated by the time cancellation is requested. No order cancellations (partial or otherwise) are allowable more than 4 weeks from date of order placement (as order production is unable to be terminated by that point), and full payment of the acknowledged order value is required for any orders cancelled after 4 weeks. Cancellations may be allowable in less than 4 weeks after order placement, depending on the extent to which manufacturing has been initiated. An acceptance of order cancellation requires that the purchaser agrees to make payment for all costs incurred to the point of acceptance of cancellation. Cancellation charges include all costs for purchase of dedicated material and components, engineering costs for non-standard products, and all costs for manufacturing completed to that point, as well as a \$367 net charge for processing of the original order and for processing of cancellation invoicing.

Pricing

Krug endeavors to ensure that all prices in this price list reflect accurately our current prices. However, errors do occur and will be rectified through notices to the field. Krug reserves the right to acknowledge pricing that may be different from the price list.

Storage Charges

Krug reserves the right to assess a nominal storage charge if a customer does not accept shipment of an order within a week of the ship date.

Warranty

Krug warrants the construction and the finish of all our products to be free from defects in materials and workmanship for a period of 10 years from the date of purchase. This warranty is applicable to products in use by their original purchaser. This warranty does not apply to components not manufactured by Krug including textiles, which are subject to the specific warranties of those manufacturers, if any. Textiles (fabric, leather, vinyl, or any other covering material) suppliers do not guarantee their products for durability and color fastness, and nor does Krug. Casters, mechanical and electrical components have a warranty of five years from the date of purchase. The Krug warranty does not apply to COM-specified materials, damage caused by a carrier other than Krug, or variation in wood finishes due to natural wood color variation. Krug cannot be held responsible for variations in fabric dye lots from order to order. All fabric is carefully inspected when it is received, but a degree of variation in color should be expected. Repairs or replacement of any defect covered under this warranty by Krug will be made, at our option and method, at no charge to the original purchaser during the warranty period. Krug's judgement is final and binding with respect to the nature or cause of defects or damage, and the necessity or manner of repair or replacement.

This warranty does not apply to defects or damage resulting from:

- normal wear and tear occurring with the use of the product
- negligence, misuse, excessive use, alteration, improper cleaning or repair
- substitution or use of incorrect or unauthorized components or material
- handling or installation that is incorrect, or that causes damage or defect
- damage incurred by a freight carrier other than Krug
- wearing of finishes and fabrics, and normal variations in materials (including dye lot variations)
- properties of natural materials, including wood and leather
- exposure to environments with uncontrolled temperature and humidity (products must be transported, stored and used in climate-controlled conditions)

Export Packaging

Krug is pleased to provide the option for export packaging on all our products, to provide additional protection from damage. For shipments overseas, a quote for export packaging can be provided, based on the products to be ordered and the delivery destination - please contact Customer Service or Bids & Specification Support for more information and a quotation. KRUG is not responsible for shipment damage occurring on overseas shipments

Export Packaging is STRONGLY RECOMMENDED for:

- (A) all shipments outside of the lower 48 states and Canada.
- (B) all shipments that will be held in storage for an extended period prior to installation.

Important: Please note that Krug will not be responsible for damage claims on product shipped or stored in the above conditions but where export packaging has not been utilized.

Dimensions

Dimensions are in inches and approximate, and subject to change without notice. Contact Customer Service if dimensions are critical.

Installation Support

For assistance please contact Technical Support at 1-888-578-5784 x216 or e-mail installationhelp@krug.ca and you will be directed to the appropriate installation support person.

Custom Capabilities

Over 15% of our orders involve some type of custom work, and we invite our customers to make use of our extensive capabilities. These include:

- 1) Dimensional customization of standard size products
- 2) Custom wood finishes
- 3) For larger orders, completely custom-designed products, as well as non-standard wood species can be specified.

Custom orders may require additional production lead times. Contact Customer Service for more information.

Freight Terms and Conditions

1. All product is shipped FOB the Krug factory. Freight is either pre-paid to the destination or not pre-paid, depending on established customer specific freight terms.
2. Docks at the selected delivery location must be equipped to handle a 53' trailer. If a dock is inadequate for delivery by Krug, Krug will re-deliver to another local location and any additional costs will be charged to the customer.
3. For all deliveries, it is understood that Krug or its agent is making a dock delivery only (equipped to handle a 53' trailer), and any further work of truck unloading, delivery beyond the dock, installation, and removal of packaging is not authorized or paid for by Krug.
4. Drop shipments to the installation site, and timed deliveries, are available on larger shipments (full truckloads or slightly less) at no additional charge. Drop shipments or timed deliveries for smaller shipments may not be available, or if available will require a surcharge. Deliveries on an after hours basis, or on weekends, or any other special requirements, may be subject to a surcharge. Location and contact information, and the requested time of delivery, is required at least one week prior to the acknowledged shipment date. If this information is not provided one week in advance, or if the location or time of the drop shipment is changed less than one week in advance, a surcharge may be applied, and/or the drop shipment may not be scheduled. For deliveries requested Monday to Thursday after 5:00 pm, please apply a surcharge of \$262/shipment. For deliveries requested Monday to Friday before 7:00 am, please apply a surcharge of \$262/shipment. For deliveries requested Friday (after 3:00 pm) or weekends, please apply a surcharge of \$525/shipment. (local times).
5. For all deliveries - whether to the Customer location or drop shipment - any circumstances that result in the delay of our carrier (including unsuitable receiving facilities, or facilities not open or available), service charges will be applied at the rate of \$125/hour. Where re-delivery is necessary because of these circumstances, the full cost of re-delivery will be charged. If Less Than Truck Load is delivering, one hour is allocated to unload. Any additional time required to unload after the first hour is \$125/hour. If a Truck Load is delivering the order, three hours is allocated to unload. Any additional time required to unload is \$125/hour. Direct deliveries to site for large orders are possible, (must exceed \$60,000 net), and accommodate 48 - 53' trailers. Krug is responsible for delivery to the approved delivery address. If an address change is required, this must be authorized by Krug 5 business days prior to ship date. Any additional delivery costs incurred after this time will be charged to the customer.

Product Strength and Durability Testing

All Krug Conference products meet or exceed the testing requirements of ANSI/BIFMA X5.5-2014 or X5.9-2012.



Damaged Shipments

All Krug product is well engineered, carefully inspected, and expertly loaded onto our trucks at our Distribution Center. If you receive any damaged freight, we ask that you do not refuse the shipment. Krug is not responsible for damage to goods that occurs in transit or storage. It is the purchaser and/or receiver's responsibility to examine the goods upon receipt and to notify Krug of any damages, overages or shortages. Any discrepancies should be noted on the Bill of Lading. The delivering carrier will not accept responsibility for shortages or damages if signed "clear". Notification of concealed damage claims must be made to Krug Distribution within 5 days of delivery, along with digital pictures if available. All product and packaging must be available for inspection. Krug liability ceases after 5 business days and Krug will not be responsible for concealed damages if shipments are left unopened. Krug is not responsible for the condition of product that is stored or installed in an environment where temperature and humidity are not controlled.

Field Product Report Authorization

Krug's written authorization, in the form of an FPR number, must be obtained prior to incurring charges of any kind if Krug is expected to pay these charges. This includes authorization for returns, field repairs and replacements, post field repairs, installation and delivery charges. Krug reserves the right to have its representative inspect product related to any request for such authorizations, prior to that authorization being provided. Deductions from invoices paid for any charges to Krug, without prior written authorization in the form of an FPR, will not be accepted. Digital photographs may be required to complete the FPR process.

Care and Maintenance

Wood Finishes - Although Krug's extensive finishing process ensures a durable finish on all our products, there are several steps that can be taken to protect and prolong the life and beauty of the finish. Protect the top by placing felt pads on the bottom of any accessories and mechanical equipment. Rubber and oil will permanently mark surfaces. Use a desk pad to prevent possible damage and imprinting caused by writing instruments and sharp objects. Dust only with a clean, dry cloth, going with the grain. Clean any marks with a damp cloth, using a small quantity of mild soap or detergent. Do not use any wax-based polish, spray or silicone. Eventually, a film will build up and discolor the top. Do not place your furniture in a position of permanent exposure to direct sunlight.

Plastic Laminates - Clean plastic laminates with mild soap and warm water. Do not use steel wool, hot water, or any abrasive cleaning product.

Krug Panel Fabric Program

Tackboards can be upholstered in COM material supplied by the customer, and in a selection of stocked tackboard fabrics supplied by Momentum. The Momentum Panel fabrics are available on Krug Express. They are 100% polyester. For additional information and color selections, please refer to our Panel Fabrics card and Krug's website. www.krug.ca PRODUCTS / FABRICS / PANEL. The Momentum panel fabrics pass ASTM-E84-87 Fire Codes. If memo samples are required please call Momentum at 1-800-366-6839.



PROGRAM DETAILS

KrugExpress orders are ready to ship by the date acknowledged. Delivery and shipping schedules may result in actual shipping of orders at a later date. Statutory holidays and scheduled factory vacations may add to acknowledged lead times of *KrugExpress* orders. Unless otherwise specified on the order, the customer's standard method of shipping Krug products will be utilized.

Available factory capacity for *KrugExpress* is filled by orders received on a "first come, first serve" basis. If the normal *KrugExpress* lead time is not available for your order because available capacity has been filled, you will be immediately advised of the earliest available ready-to-ship date. Please consult your Customer Service representative in advance if you wish to confirm the specific lead time availability for a *KrugExpress* order.

Orders must be received by midnight of a given day for that day to be considered the official day the order is received. Order lead times are acknowledged from the date the order is received, but not including the date the order is received.

KrugExpress orders must be "clean" when received in order to be considered officially received on a given day, and lead times will be acknowledged from the date orders are determined to be "clean".

Changes to *KrugExpress* orders are not allowed under any circumstances. Orders for product on *KrugExpress* must clearly state: "*KrugExpress*".

WOOD FINISHES AND LAMINATES

Standard Wood Finishes:

(See product pages for individual species availability)

SPECIES	FINISH
Cherry	Light Cherry
	Natural Cherry
	American Cherry
	Medium Cherry
	Standard Cherry
	Imperial Cherry
	Appalachian Cherry
Sable Cherry	
Maple	Clear Maple
	Honey Maple
	Wheat Maple
Oak	Light Oak
	SilverGrey on Oak
	Harvest Oak
	Mahogany Oak
	Medium Cherry on Oak
	Mellow Oak
	Walnut on Oak
Espresso on Oak	
Walnut	Natural Walnut
	Regular Walnut
	Mahogany on Walnut
	Dark Walnut
	Cordovan Walnut
SilverGrey on Walnut	
Anigre	Clear Anigre
	Medium Anigre
Palette	Black
	White
	Sand
	Soft Green
	Steel Blue
	Slate

NATURAL CHARACTERISTICS OF WOOD

Wood is a natural product with inherent color variations that will never be fully mitigated by the finishing process. Please anticipate variation in colors within a single unit, from piece to piece, and from Krug wood finish samples. If a very close match is required, a sample must be provided with the order and an upcharge will apply. Exact color matches are not possible.

CUSTOM WOOD FINISHES

Add 10% list to your order for special finishes, minimum upcharge is \$600 list per finish per order. (For example, on all orders up to \$6000 list, an upcharge of \$600 will apply, on orders \$6000 and up add 10% list to your order.) For orders with special finishes, a sample that is a minimum 3" by 3" must be received with the order. Special finishes may add additional lead time to production schedules. Since wood is a natural product, some variations in grain, color and stain acceptance will occur. In our finishing processes, we try to minimize variations, but some variation between samples and finished goods should be anticipated.

FINISH

Conference products feature Krug's finish, a proprietary catalyzed varnish formulation, that has repeatedly shown through independent laboratory testing to be the industry leader in durability and abrasion resistance. The Krug finish looks better longer than competitors and is uniquely suited to the demands of high traffic environments.

WOOD FINISHES TO MATCH STANDARD LAMINATES

- Willow on Rift Oak
- Dune on Rift Oak
- Portobello on Rift Oak
- Ash on Rift Oak
- Copper on Cherry
- Shiraz Cherry
- Park Avenue Walnut
- Chocolate on Walnut
- Nutmeg on Walnut
- Dark Walnut
- Hardrock Maple

LAMINATES

Krug's in-stock Laminates are available in 17 different laminate selections. Please note that 4 of the colors (Gingerbread, Portobello, Ash and Willow) have textured finishes and may not be appropriate for use in patient areas due to infection control concerns. Minimum order quantities and extended lead times may apply for exotic laminate colors, please check with customer service. Polymer Edge will be selected to match the worksurface. Krug's previous laminate in-stock program will be phased out as in-stock supply depletes. Please contact customer service for availability.

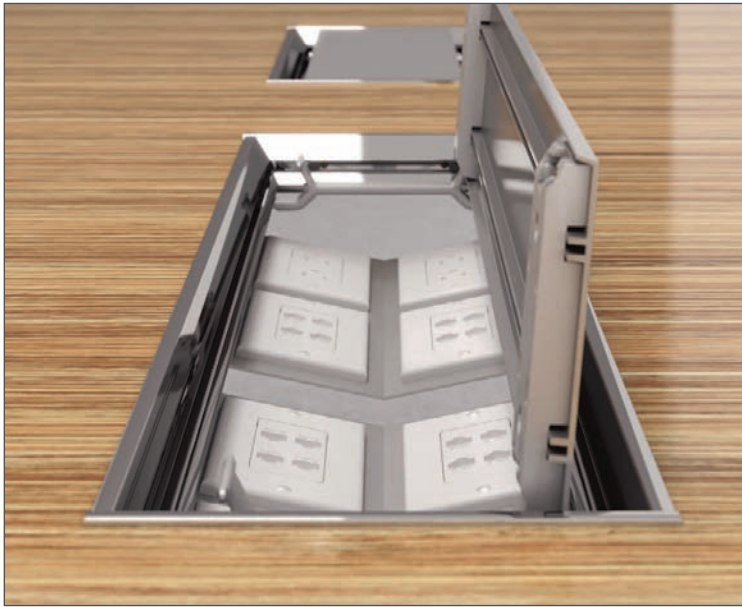
IN-STOCK LAMINATES

Wood Grain Laminates	High Pressure Laminate Supplier	Textured Wood Grain Laminates	High Pressure Laminate Supplier
Champagne	Tafisa T492CR	Gingerbread	Tafisa T556UR
Hardrock Maple	Formica 86992-58	Portobello	Tafisa T557UR
Dune	Tafisa T491CR	Ash	Tafisa T535AT
Copper	Tafisa T521CR	Willow	Tafisa T543AT
Shiraz Cherry	Tafisa T472CR	Solid Laminates	
Park Avenue Walnut	Wilsonart 7984-38	Designer White	Wilsonart D354-60
Chocolate	Tafisa T498CR	Platinum	Tafisa T202CR
Nutmeg	Tafisa T477CR	Earth	Tafisa T767CR
Dark Walnut	Tafisa T469CR	Charcoal	Tafisa T228CR

PHASE OUT LAMINATES Almond - Black- Shadows - Edgewood Sycamore - Gunstock Walnut

NON-STOCKED LAMINATES

For specific lead time and application questions, please contact Krug Customer Service for your requirement. Upcharges will be applicable for non-stocked laminates, depending on their cost. Non-stock laminates may require a minimum order quantity, please contact customer service. Stocked polymer edges only can be specified for use with non-stocked laminates or tops will be self-edged.



www.fsc.org
FSC® C021699

The mark of responsible forestry



All products are air emissions certified and are available as FSC® certified

krug

solutions@krug.ca | www.krug.ca | 1.888.578.KRUG