

**NUVO**  
Price and Specification Guide  
USA



**krug**

Advancing Design Through Innovation

# NUVO | TABLE OF CONTENTS

## **NUVO**

- 2 Nuvo Environmental Summary
- 3 Features & Options
- 5 Power Management
- 7 Sample Configurations
- 8 Rectangular Wood Tops
- 9 Arc End Wood Conference Tops
- 10 Racetrack Wood Conference Tops
- 11 Boat Shaped & Visio Wood Conference Tops
- 12 Oval, Arced Square & Round Wood Conference Tops
- 13 Console Planning For Wood Tops
- 14 Console Size & Location For Wood Tops
- 24 Console Size & Location For Laminate Tops
- 34 Consoles for Wood & Laminate Tops
- 35 Back-Painted Glass Rectangular Conference Tops
- 36 Back-Painted Glass Arc End Conference Tops
- 37 Back-Painted Glass Boat Shaped & Visio Conference Tops
- 38 Back-Painted Glass Oval, Arced Square & Round Conference Tops
- 39 Console Planning for Back-Painted Glass Tops
- 40 Console Size & Location For Back-Painted Glass Tops
- 47 Consoles for Back-Painted Glass Tops & Console Power/Data Modules
- 48 Standard Console Power/Data Media Modules
- 52 Console Power Modules for Custom Configurations
- 53 Console Data/Media Options
- 58 Bases
- 59 Base Requirements Chart

## **MEDIA AND STORAGE**

- 67 LEED Credit Summary, Substantiality & Environmental
- 68 Features & Options
- 71 Credenzas
- 75 Buffets
- 81 Hospitality Carts
- 82 Lecterns & Media

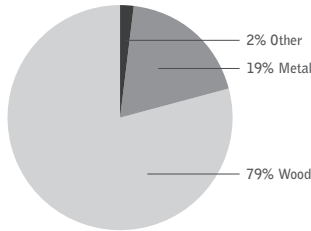
## **GENERAL INFORMATION**

- 83 Terms & Conditions
- 83 Warranty
- 84 KrugExpress
- 85 Wood Finish & Laminates

## LEED CERTIFICATION



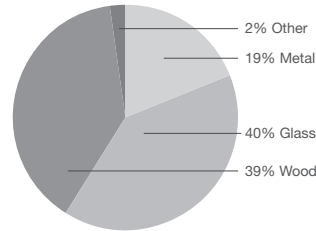
MATERIAL CONTENT:



PRE-CONSUMER RECYCLED CONTENT - 82%  
POST-CONSUMER RECYCLED CONTENT - 2.5%



MATERIAL CONTENT:



PRE-CONSUMER RECYCLED CONTENT - 72%  
POST-CONSUMER RECYCLED CONTENT - 2.5%

|                  |  | CONTRIBUTES TO |
|------------------|--|----------------|
| Credit 2.1 - 2.2 | Construction Waste Management                    | 1-2 point(s)   |
| Credit 4.1       | Recycled Content                                 | 1 point        |
| Credit 4.2       | Recycled Content                                 | 1 point        |
| Credit 4.5       | Low Emitting Materials, (MUST BE REQUESTED )     |                |
|                  | Composite Wood & Laminate Adhesives              | 1 point        |
| Credit 5.1       | Regional Materials*                              | 1 point        |
| Credit 6         | Rapidly Renewable Materials (MUST BE REQUESTED ) | 1 point        |
| Credit 7         | Certified Wood (MUST BE REQUESTED )              | 1 point        |

\*This credit is only applicable if in total 20% of the combined value of the procurement of construction materials and in the furniture are manufactured within a radius of 500 miles. This credit will apply if the installation of the finished product occurs within 500 miles of Kitchener, Ontario.



### level® CERTIFICATION

BIFMA's e3 Furniture Sustainability Standard is a voluntary, multi-attribute standard that measures the degree of sustainability of furniture. This standard evaluates product and company environmental attributes and compliance systems in a wide range of elements which include Materials, Energy & Atmosphere, Human & Ecosystem Health and Social Responsibility. Nuvo products have earned level®, BIFMA's sustainability certification program for furniture, certification through third-party verification against the e3 standard. All Nuvo products can be supplied with level® certification. In order to accomplish this, the product must also be ordered with the air-emissions-certification option. Contact customer service for information and upcharges.



the mark of responsible forest®

### AIR-EMISSIONS

All Nuvo products can be supplied with air-emissions-certified materials. Contact customer service for information and upcharges.

### FSC®

FSC® In 2005, Krug received Forest Stewardship Council® (FSC®) Chain-of-Custody certification for our manufacturing facilities. The FSC® Chain-of-Custody tracks certified wood from seedling to final sale. It verifies that the material for our FSC® certified products only come from well-managed, FSC®-certified forests and other controlled sources. FSC® is dedicated to the promotion of responsible forest management worldwide helping to take care of forests for future generations. Nuvo and other Krug products can be specified with FSC® Certification. Contact customer service for further information, pricing and lead times..

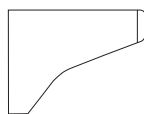


In addition, architects, designers, and building professionals can specify FSC®-certified products in order to achieve a point from the US. Green Building Council's Leadership in Energy and Environmental Design (LEED) Rating System.

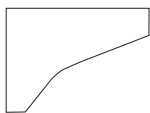
# NUVO | FEATURES & OPTIONS

## TOPS

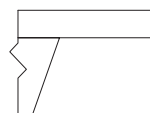
Nuvo Conference products offers 8 table top shapes in 6 veneer species in addition to 13 wood grain, 4 solid laminate selections. Veneered tops are 1 1/2" thick veneered fiberboard MDF core and backer material, with a 1/8" wood edge. Laminate tops are 1 1/2" thick with fiberboard MDF core and backer material, with a PVC edge. Conference tops are available with these profiles.



Edge profile for wood tops  
Knife Edge



Edge profile for laminate tops



Edge profile for glass tops

## BASES

All bases are shipped separately and require assembly to support beams and/or tops.

All wood bases, with the exception of panel bases, offer large interior cavities for cable routing and allow for total concealment of wiring when floor monuments are located underneath. Bases are equipped with removable panels which make access to the interior quick and easy.

Refer to the base requirements chart on page 60 to select the appropriate bases and sizes for conference tables.

Formed Metal Bases are available in Matte Chrome finish.

Base plates are available in a choice of Wood, Palette, Laminate or Gloss Aluminum finish.

## CONSOLES

Consoles are available in 14", 27", 36", 42" and 50" lengths, and can be located within a top section or across a seam. Consoles located within a table section will be factory installed. Consoles located across the seam are ordered by a separate model number and will be shipped as a separate item for field installation. The console access cover allows wiring to pass through to the console module from all sides. The console access cover can be operated from either side of the table for easy access to the console module and opens to a 95° angle from the top of the table. Console access covers are available in Gloss Aluminum with Polished Chrome end bezels.

## CONSOLE POWER/DATA/MEDIA MODULES

Console power/data/media modules are available in 18 preconfigured options or can be customized by adding plate-mounted or snap-in data ports to any of the 4 standard power modules. The number of console modules per console is dependent on the console size; 1 unit in 14" lengths, 2 units in 27" and 36" lengths, and 3 units in 42" and 50" lengths. Console power modules are available in three cord lengths (6', 16' and 25'). A utility outlet is available in some console module models for connecting power within a table. Up to 10 duplex receptacles can be connected to one electrical circuit. Faceplates, duplex receptacles and data components are white.

## SUPPORT BEAMS

Aluminum support beams provide strength and support to the conference tops. Support beams are field installed onto the bases allowing for top-on-last installation for all base styles except the formed metal base. Powder coated steel trough pans located between the support beams accommodate under-surface cable management and runs cables to interior base cavities to access floor monuments.

## SEATING CAPACITY

To establish seating capacity, an outside chair dimension of 24" has been used for this price guide, plus an allowance of 5" between chairs, for a total of 29". This is an approximation only. When using another chair, particularly seating with a 5 prong caster base, be sure to adjust the approximate seating capacity accordingly. Since not all manufacturers use the same formula, when seating capacity is in question, please contact Krug Customer Service to review the specific seating that is being used with Nuvo Conference Tables.

## VENEER

Veneers available are Rift White Oak, Quarter Cut Maple, Cherry, Walnut.

## FINISH

A five step catalyzed varnish finish that when dry has a sheen value of 32°, is applied to all tables, bases and cases. A lower sheen topcoat, 20°, can also be specified, at standard pricing. All purchase orders must clearly note "lower sheen finish" in order to receive this optional selection. All finished surfaces are well sanded before applying finishing materials. The procedure begins by applying a base color via an NGR stain. A wash coat follows to further enhance the color. Next is the glazing process, which provides the 3rd color step and fills the pores of the wood. A sealer coat is then applied, twice to the horizontal worksurfaces to enhance the finish. The product is then scuff sanded to prepare for the top coat. The top coat is a catalyzed varnish that when dry has a sheen value of 32°. Krug's catalyzed varnish has been tested to be one of the industry's most durable and long lasting. Custom finishes are available at an upcharge of 10% list per unit.

## GLASS SURFACES

Nuvo conference tops are available in white back-painted 10mm tempered glass. Please contact customer service for additional color selections available at no upcharge. Color options also on website.

## SOLID SURFACES

Solid Surface tops are available on conference tops. The solid surface standard top option is white, with additional colors available upon request. Solid surfaces are composed of minerals, acrylic resins that are non-porous and stain, scratch and dent resistant. Color is throughout the material, so surface scratches are not as visible. Please contact customer service with specifications for a quote.

## GLIDES

Wood bases feature adjustable glides 1 1/2" long and allow for a range of adjustment of 3/4". Metal bases have 1/2" glides.

## MICROPHONE CUT OUTS

Microphone cut outs are available for **\$361 list** per table for up to 7 microphone cutouts. For Back-Painted Glass tops add an additional **\$120 list** per cut-out.

## HOW TO SPECIFY NUVO

- 1) Specify table top shape, size, model number and top material. For wood and laminate tops see page 9, for Back-Painted Glass see page 36.
- 2) Select base shape, size and model number using Base Requirements chart on page 60.
- 3) Specify console location (end sections, middle sections or across the seam) and size option. For wood top see page 15, for Back-Painted Glass see page 40.
- 4) Cross seam console model number, where applicable. For wood top see page 15 for Back-Painted Glass see page 41.  
Please note: Across seam consoles are field installed and have a separate model number.
- 5) Specify Console Power module options. Preconfigured Console Modules, see page 49. Custom Console Modules, see page 53.
- 6) Add plate-mounted data or snap-in data options to custom module, see port options on page 49.

Purchase orders must include:

- Wood Species and Finish
- Base Plates - Gloss Aluminum, Palette, Laminate or Wood

## LAMINATE WORKSURFACES

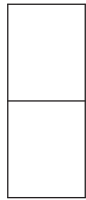
Laminate is available on all Nuvo Conference Tops; refer to Krug's standard laminate program on page 347. Krug will order and procure laminates. Purchase orders with a plastic laminate option must include Laminate Name.

Krug reserves the right to decline a laminate that may not be suitable for the application. Krug assumes no responsibility for durability or consistent color. The number of sections on 48" wide Laminate tops, on some table sizes, are different than the same size wood top. This is due to the size of laminates available. See table sections column on pages 25. Please note the grain direction of wood grain laminates will run lengthwise on 1 piece tops and crosswise on multiple piece tables. The grain direction of wood grain laminate will run horizontal on the backs of credenzas and buffets.

## CUSTOM SIZING

Custom sizing and additional customization is available on Nuvo Conference Tables. Tops may be ordered with a reduced number of sections at an upcharge. For more information or to obtain quotations, please contact Customer Service.

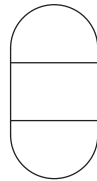
## STANDARD TABLE SHAPES



Rectangular  
Model Number: 5161  
Glass Top 5161GP



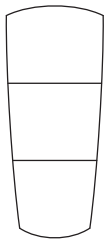
Arc End  
Model Number: 5166  
Glass Top 5166GP



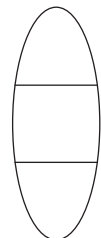
Racetrack  
Model Number: 5102  
Glass Top 5102GP



Boat Shaped-Arc Ends  
Model Number: 5164  
Glass Top 5164GP



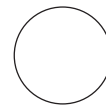
Visio-Arc Ends  
Model Number: 5168  
Glass Top 5168GP



Oval  
Model Number: 5159  
Glass Top 5159GP



Arced Square  
Model Number: 5166  
Glass Top 5166GP



Round  
Model Number: 5105  
Glass Top 5105GP

## SQUARE CORNER TOPS

Nuvo conference tables may be specified with Square Corners in all shapes with rounded corners. To order these additional configurations, please replace the standard model number with the number listed: Rectangular = 5101, Arc End = 5106, Boat Shape-Straight End = 5104, Boat Shape-Arc End = 5154, Visio-Straight End = 5108, Visio-Arc End = 5158, Arc Square = 5156. Pricing for tops with square corners is the same as standard tops.

## TESTING

All products have been tested in accordance with ANSI/BIFMA X5.5-2014 or X5.9-2012.



# NUVO | POWER MANAGEMENT

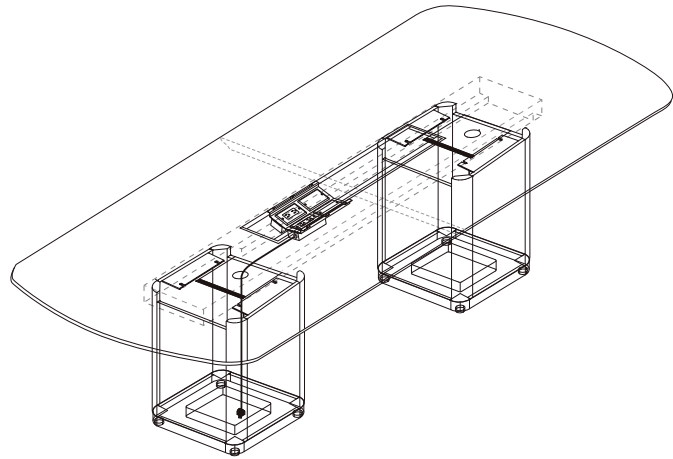
All Nuvo Conference tables feature cable management capabilities for routing cables between the floor monuments and the consoles that provide voice/power/data/media connections.

Support beams connect the bases and provide additional support for the conference top. Support beams enable top-on-last assembly of the tables - this shortens the installation time, requires fewer installers, and helps to prevent damage to table tops. Data cables can be connected to the power/data modules and dropped into the base and connected to the source prior to the installation of the top. After the top is installed, the power modules are bolted into the threaded inserts in the top. Cable troughs located between the support beams offer generous space for cable management and are supplied with grommets to allow for cables to pass through to the base interior cavities.

Bases feature sizable cutouts at the bottom, providing access to floor monuments. With the exception of Panel and Formed Metal Bases, bases allow for total concealment of wiring when floor monuments are located underneath. Access doors are provided on the inward-facing vertical side of the bases, providing quick access to cabling in the interior. Formed Metal bases are available with an external cable management system and cables are run to the floor using a Metal Cable Manager or Spine Cable Manager.

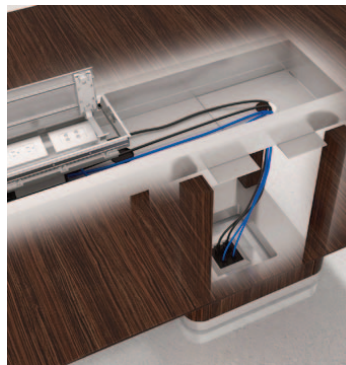
The Console modules are housed within the support beam and provide power and communications connectivity. Console modules utilize UL standard receptacle outlets. Console modules are available in 18 pre-configured configurations, or can be custom-configured in unique configurations - or alternatively can be specified with blank ports, so customers can purchase and insert their own outlets. Console modules also can be designed and built specifically to meet your connectivity needs by using the Snap-in or Plate mounted port options. Console modules are available with three electrical cord lengths (6', 16', and 25'). Console modules with a utility outlet will allow units to be linked together to a maximum of 10 duplex receptacles per circuit. The number of console modules is dependent on the console size; 1 unit in 14" lengths, 2 units in 27" and 36" lengths, and 3 units in 42" and 50" lengths.

Consoles are available in 14", 27", 36", 42" and 50" lengths, and can be located within a top section, or can span top section seams. The console access cover allows wiring to pass through to the console module from all sides. Console access covers are operated from either side of the table for easy access to the console module and open to a 95° angle from the top of the table. Console access covers are available in a Gloss Aluminum finish with polished chrome end bezel. There are some limitations in glass, please see page 41.

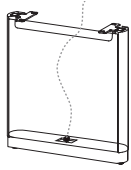


SUPPORT BEAMS & CABLE TROUGH

CONSOLE MODULE



Panel Base



| Base Size | Base Floor Monument<br>Cut Out Dimension |
|-----------|--|
|-----------|--|

Note: Panel bases will not completely conceal floor monuments.

Panel bases have 2 cable access panels

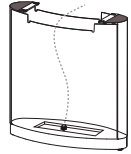
|          |           |
|----------|-----------|
| 21" x 3" | 4" X 1.5" |
| 25" x 3" | 4" X 1.5" |
| 31" x 3" | 4" X 1.5" |

Formed Metal Base



**NOTE:** Formed Metal bases do not feature an interior cavity. Formed Metal bases have external cable management systems allowing cables to run to the floor monument. See page 60 for model numbers and cable management options. Overall table height is 29.5"

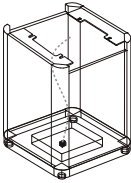
Oval Base



Oval bases have 2 cable access panels 16" x 16"

|           |            |
|-----------|------------|
| 21" x 8"  | 12" X 5"   |
| 25" x 10" | 12" X 6.5" |
| 31" x 12" | 12" X 9.5" |

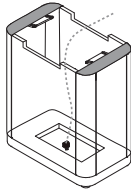
Square Base



Square bases have 1 cable access panel

|           |               |
|-----------|---------------|
| 16"x16"   | 6.25" X 6.25" |
| 20" x 20" | 9.5" X 9.5"   |
| 24" x 24" | 14.5" X 14.5" |
| 30" x 30" | 20.5" X 20.5" |

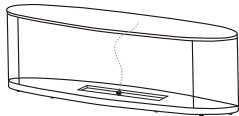
Rectangular Base



Rectangular bases have 1 cable access panel

|           |          |
|-----------|----------|
| 21" x 12" | 15" X 6" |
| 25" x 12" | 19" X 6" |
| 31" x 12" | 25" X 6" |

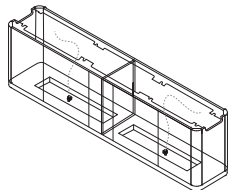
Oval Island Base



Oval Island bases have 2 cable access panels

|            |                         |
|------------|-------------------------|
| 18" x 47"  | 10" X 20"               |
| 18" x 71"  | (2) 6 X 11 (1) 6 X 15   |
| 24" x 71"  | 13 X 33                 |
| 24" x 95"  | (2) 13 X 12 (1) 13 X 26 |
| 24" x 107" | (2) 13 X 17 (1) 13 X 33 |

Rectangular Island Base

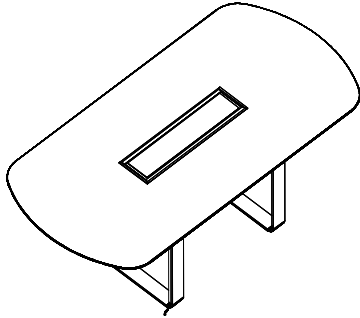


Rectangular Island bases have 1, 2 or 3 cable access panels depending on base size

|            |               |
|------------|---------------|
| 18" x 27"  | 9" X 9"       |
| 18" x 39"  | 9" X 22"      |
| 18" x 63"  | 9" X 29"      |
| 18" x 99"  | (2) 9" X 33"  |
| 18" x 123" | (2) 9" X 43"  |
| 18" x 171" | (4) 8" X 34"  |
| 24" x 63"  | 11" X 29"     |
| 24" x 99"  | (2) 11" X 33" |
| 24" x 123" | (2) 11" X 43" |
| 24" x 171" | (4) 11" X 34" |
| 24" x 219" | (3) 11" X 40" |

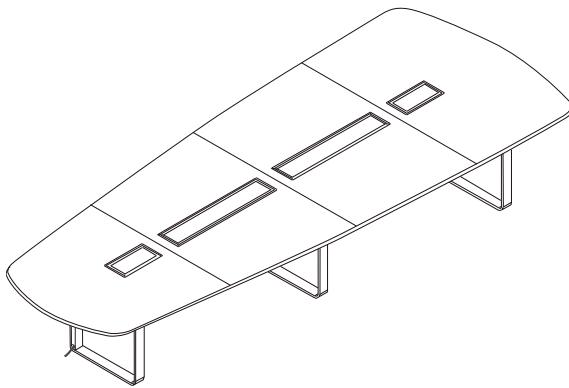
# NUVO | SAMPLE CONFIGURATIONS

## SAMPLE CONFIGURATIONS - EXAMPLE ONE



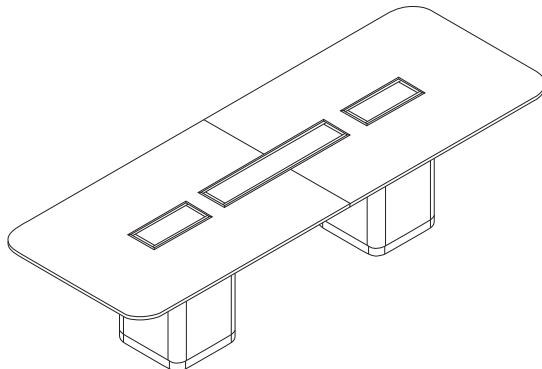
| Description   | Model Number | Laminate, Oak  |                |
|---|--------------|----------------|----------------|
|   |              | Maple, Cherry  | Walnut         |
| (1) Arc End Top 72x36   | 51667236     | 3095           | 3404           |
| (1) Formed Metal Base w/ Metal Cable Manager                                  | 514124328CMI | 1356           | 1356           |
| (1) Formed Metal Base   | 514124328    | 1173           | 1173           |
| (1) Console Access Port within top section                                    | AM27         | 295            | 295            |
| (1) Console Power Module for Custom Configurations Console Data/Media Options | 51PMA06      | 483            | 483            |
| Position 3 -(1) - DVI-D Dual (Digital)  | P03          | 137            | 137            |
| Position 4 -(1) - Adaptor Plate   | M04          | 38             | 38             |
| -(2) - RJ45-CAT6 White  | S01W         | 47             | 47             |
| -(1) - RJ11-Telephone White   | S02W         | 47             | 47             |
| -(1) - HDMI   | S04          | 32             | 32             |
|   |              | 173            | 173            |
| <b>TOTAL LIST</b>   |              | <b>\$6,876</b> | <b>\$7,185</b> |

## SAMPLE CONFIGURATIONS - EXAMPLE TWO



| Description   | Model Number | Laminate, Oak   |                 |
|---|--------------|-----------------|-----------------|
|   |              | Maple, Cherry   | Walnut          |
| (1) Visio Top 168x66/42                                   | 51681686642  | 13909           | 15297           |
| (1) Formed Metal Base w/ Metal Cable Manager              | 514124328CM1 | 1356            | 1356            |
| (1) Formed Metal Base                                     | 514136328    | 1311            | 1311            |
| (1) Formed Metal Base                                     | 514148328    | 1446            | 1446            |
| (4) Console Access Ports within top section               | AI14         | 265             | 265             |
|   | BM36         | 333             | 333             |
|   | CM36         | 333             | 333             |
|   | DI14         | 265             | 265             |
| (3) Basic Data with 2 Duplex Receptacles & Utility Outlet | 51PDCD01-06  | 559             | 559             |
|   |              | 559             | 559             |
|   |              | 559             | 559             |
| (1) Basic Data with 2 Duplex Receptacles                  | 51PDAD01-06  | 508             | 508             |
| <b>TOTAL LIST</b>   |              | <b>\$21,403</b> | <b>\$22,791</b> |


## SAMPLE CONFIGURATIONS - EXAMPLE THREE



| Description   | Model Number          | Laminate, Oak   |                 |
|---|-----------------------|-----------------|-----------------|
|   |                       | Maple, Cherry   | Walnut          |
| (1) Rectangular Top 120x48                                | 516112048             | 5946            | 6541            |
| (2) 20" Square Bases                                      | 5143202025            | 1236            | 1358            |
|   |                       | 1236            | 1358            |
| (2) Console Access Port within top section                | AM14                  | 265             | 265             |
|   | BM14                  | 265             | 265             |
| (1) Console Access Port across a seam                     | 51CONSOLE-X27 (ABX27) | 295             | 295             |
| (2) Basic Data with 2 Duplex Receptacles & Utility Outlet | 51PDCD01-06           | 559             | 559             |
|   |                       | 559             | 559             |
| (1) Basic Data with 2 Duplex Receptacles                  | 51PDAD01-06           | 508             | 508             |
| <b>TOTAL LIST</b>   |                       | <b>\$10,869</b> | <b>\$11,708</b> |



# NUVO | RECTANGULAR CONFERENCE TOPS

| Description   | Model      | Laminate           |        | L   | W     | Table Sections | Approximate Seating | Shipping Weight | Cubic Feet |
|---|------------|--------------------|--------|-----|-------|----------------|---------------------|-----------------|------------|
|   |            | Oak, Maple, Cherry | Walnut |     |       |                |                     |                 |            |
| Rectangular- Rounded Corners  | 51616036   | 2787               | 3066   | 60  | 36    | 1              | 4                   | 95              | 5          |
|   | 51616042   | 2936               | 3231   | 60  | 42    | 1              | 4                   | 110             | 6          |
|   | 51616048   | 3088               | 3396   | 60  | 48    | 1              | 4                   | 125             | 6          |
|  | 51617236   | 2983               | 3279   | 72  | 36    | 1              | 6                   | 113             | 6          |
|   | 51617242   | 3133               | 3445   | 72  | 42    | 1              | 6                   | 131             | 7          |
|   | 51617248   | 3283               | 3609   | 72  | 48    | 1              | 6                   | 148             | 8          |
|   | 51617836   | 3238               | 3561   | 78  | 36    | 1              | 6                   | 122             | 6          |
|   | 51617842   | 3418               | 3760   | 78  | 42    | 1              | 6                   | 142             | 7          |
|   | 51617848   | 3599               | 3958   | 78  | 48    | 1              | 6                   | 161             | 8          |
|   | 51618436   | 3462               | 3811   | 84  | 36    | 1              | 6                   | 131             | 7          |
|   | 51618442   | 3688               | 4059   | 84  | 42    | 1              | 6                   | 152             | 8          |
|   | 51618448   | 3915               | 4308   | 84  | 48    | 1              | 6                   | 172             | 9          |
|   | 51619636   | 3613               | 3975   | 96  | 36    | 1              | 8                   | 150             | 8          |
|   | 51619642   | 4215               | 4637   | 96  | 42    | 2              | 8                   | 175             | 9          |
|   | 51619648   | 4817               | 5299   | 96  | 48    | 2              | 8                   | 198             | 10         |
|   | 516110842  | 4366               | 4802   | 108 | 42    | 2 (3)          | 8                   | 195             | 10         |
|   | 516110848  | 5043               | 5547   | 108 | 48    | 2 (3)          | 8                   | 222             | 11         |
|   | 516110854  | 5796               | 6375   | 108 | 54    | 3              | 8                   | 250             | 13         |
|   | 516112042  | 5269               | 5796   | 120 | 42    | 2 (3)          | 8                   | 216             | 11         |
|   | 516112048* | 5946               | 6541   | 120 | 48    | 2 (3)          | 10                  | 247             | 12         |
|   | 516112054  | 6624               | 7287   | 120 | 54    | 3              | 10                  | 278             | 14         |
|   | 516112060  | 7375               | 8116   | 120 | 60    | 3              | 10                  | 307             | 15         |
|   | 516114448  | 6773               | 7452   | 144 | 48    | 2 (3)          | 10                  | 297             | 15         |
|   | 516114454  | 7603               | 8364   | 144 | 54    | 3              | 12                  | 333             | 17         |
|   | 516114460  | 8506               | 9357   | 144 | 60    | 3              | 12                  | 369             | 18         |
|   | 516115654  | 8280               | 9109   | 156 | 54    | 3 (4)          | 12                  | 362             | 18         |
|   | 516115660  | 9334               | 10266  | 156 | 60    | 3 (4)          | 12                  | 401             | 20         |
| 516116848   | 8957       | 9853               | 168    | 48  | 3 (4) | 12             | 347                 | 17              |            |
| 516116854   | 10086      | 11095              | 168    | 54  | 4     | 12             | 390                 | 19              |            |
| 516116860   | 11366      | 12502              | 168    | 60  | 4     | 12             | 431                 | 21              |            |
| 516119248   | 10463      | 11510              | 192    | 48  | 3 (4) | 14             | 397                 | 20              |            |
| 516119254   | 11741      | 12915              | 192    | 54  | 4     | 14             | 445                 | 22              |            |
| 516119260   | 13172      | 14488              | 192    | 60  | 4     | 14             | 492                 | 24              |            |
| 516121654   | 12946      | 14240              | 216    | 54  | 5     | 16             | 501                 | 24              |            |
| 516121660   | 14526      | 15978              | 216    | 60  | 5     | 16             | 554                 | 27              |            |
| 516124060   | 16408      | 18048              | 240    | 60  | 5     | 18             | 617                 | 30              |            |
| 516126460   | 18592      | 20447              | 264    | 60  | 6     | 20             | 680                 | 33              |            |
| 516128860   | 20997      | 23096              | 288    | 60  | 6     | 22             | 740                 | 36              |            |

**NOTE:** Support Beams are included in top price. An additional line item for the support beam will be included on the order acknowledgment at no charge.

**RECTANGULAR - SQUARE CORNER TOPS:**

Rectangular tops with square corners are available. Replace the model prefix with **5101**. e.g. **516114448** becomes **510114448** Pricing is the same as standard tops.

**LAMINATE TABLE SECTIONS:**

The number in brackets under table sections, refers to the number of sections when ordering laminate tops, if different than the number of sections for the same size wood top. Please note the grain direction of wood grain laminates will run lengthwise on 1 piece tops and crosswise on multiple piece table tops.

**ORDERING PROCEDURES**

To order, please specify the following:

- 1) Table top shape, size, model number and wood species
- 2) Base model number
- 3) Console location and size option
- 4) Cross seam console model number, where applicable
- 5) Console power module and data options

**DIMENSION KEY**

L - length

W - Width

Dimensions are in inches and approximate.

Contact Customer Service if dimensions are critical.

**STANDARD FINISHES**

For a complete list of standard wood finishes, please see page 347

**BASE REQUIREMENTS**

See page 60 for base requirements

**CONSOLE SIZE & LOCATIONS**

For information on Console locations and size options, see page 15 for wood and page 25 for laminate.

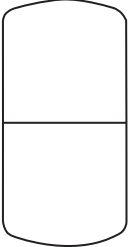
**CONSOLE POWER/DATA MODULE OPTIONS**

See page 49 for Console Module Options

**TABLE SECTION SIZE**

Section sizes can be calculated by dividing the table length by the # of sections

# NUVO | ARC END CONFERENCE TOPS

| Description  | Model     | Laminate           |        | L   | W  | Table Sections | Approximate Seating | Shipping Weight | Cubic Feet |
|--|-----------|--------------------|--------|-----|----|----------------|---------------------|-----------------|------------|
|  |           | Oak, Maple, Cherry | Walnut |     |    |                |                     |                 |            |
| Arc End Table -<br>Rounded Corners   | 51666036  | 2760               | 3037   | 60  | 36 | 1              | 4                   | 89              | 5          |
|  | 51666042  | 2941               | 3235   | 60  | 42 | 1              | 4                   | 103             | 5          |
|  | 51666048  | 3119               | 3433   | 60  | 48 | 1              | 4                   | 117             | 6          |
|  | 51667236  | 2948               | 3242   | 72  | 36 | 1              | 6                   | 107             | 5          |
|  | 51667242  | 3127               | 3438   | 72  | 42 | 1              | 6                   | 123             | 6          |
|  | 51667248  | 3305               | 3637   | 72  | 48 | 1              | 6                   | 140             | 7          |
|  | 51667836  | 3190               | 3510   | 78  | 36 | 1              | 6                   | 116             | 6          |
|  | 51667842  | 3398               | 3738   | 78  | 42 | 1              | 6                   | 134             | 7          |
|  | 51667848  | 3607               | 3969   | 78  | 48 | 1              | 6                   | 153             | 8          |
|  | 51668436  | 3407               | 3747   | 84  | 36 | 1              | 6                   | 125             | 7          |
|  | 51668442  | 3659               | 4021   | 84  | 42 | 1              | 6                   | 144             | 8          |
|  | 51668448  | 3908               | 4298   | 84  | 48 | 1              | 6                   | 164             | 9          |
|  | 51669636  | 3550               | 3904   | 96  | 36 | 1              | 8                   | 144             | 7          |
|  | 51669642  | 4159               | 4574   | 96  | 42 | 2              | 8                   | 167             | 9          |
|  | 51669648* | 4768               | 5245   | 96  | 48 | 2              | 8                   | 190             | 10         |
|  | 516610842 | 4300               | 4732   | 108 | 42 | 2 (3)          | 8                   | 188             | 10         |
|  | 516610848 | 4983               | 5482   | 108 | 48 | 2 (3)          | 8                   | 214             | 11         |
|  | 516610854 | 5735               | 6309   | 108 | 54 | 3              | 8                   | 240             | 12         |
|  | 516612042 | 5162               | 5679   | 120 | 42 | 2 (3)          | 10 (8)              | 211             | 11         |
|  | 516612048 | 5844               | 6428   | 120 | 48 | 2 (3)          | 10                  | 239             | 12         |
|  | 516612054 | 6524               | 7176   | 120 | 54 | 3              | 10                  | 268             | 14         |
|  | 516612060 | 7278               | 8005   | 120 | 60 | 3              | 10                  | 297             | 15         |
|  | 516614448 | 6631               | 7294   | 144 | 48 | 2 (3)          | 10                  | 289             | 15         |
|  | 516614454 | 7457               | 8201   | 144 | 54 | 3              | 12                  | 324             | 16         |
|  | 516614460 | 8351               | 9187   | 144 | 60 | 3              | 12                  | 359             | 18         |
|  | 516615654 | 8101               | 8912   | 156 | 54 | 3 (4)          | 12 (10)             | 353             | 18         |
|  | 516615660 | 9140               | 10055  | 156 | 60 | 3 (4)          | 12                  | 390             | 20         |
|  | 516616848 | 8710               | 9582   | 168 | 48 | 3 (4)          | 12                  | 338             | 17         |
|  | 516616854 | 9821               | 10804  | 168 | 54 | 4              | 12                  | 380             | 19         |
|  | 516616860 | 11075              | 12183  | 168 | 60 | 4              | 12                  | 421             | 21         |
|  | 516619248 | 10144              | 11158  | 192 | 48 | 3 (4)          | 14                  | 388             | 20         |
| 516619254  | 11398     | 12538              | 192    | 54  | 4  | 14             | 435                 | 22              |            |
| 516619260  | 12795     | 14077              | 192    | 60  | 4  | 14             | 482                 | 24              |            |
| 516621654  | 12545     | 13799              | 216    | 54  | 5  | 16             | 491                 | 25              |            |
| 516621660  | 14085     | 15494              | 216    | 60  | 5  | 16             | 544                 | 27              |            |
| 516624060  | 15878     | 17466              | 240    | 60  | 5  | 20 (18)        | 606                 | 30              |            |
| 516626460  | 17957     | 19752              | 264    | 60  | 6  | 20             | 668                 | 33              |            |
| 516628860  | 20250     | 22275              | 288    | 60  | 6  | 22             | 729                 | 36              |            |

**NOTE:** Support Beams are included in top price. An additional line item for the support beam will be included on the order acknowledgment at no charge.

**ARC END TABLE - SQUARE CORNERS:**

Arc End tops are available with square corners. Replace the model number prefix with **5106**. e.g. **516612042** becomes **510612042**. Pricing is the same as standard tops.

**LAMINATE TABLE SECTIONS:**

The number in brackets under table sections, refers to the number of sections when ordering laminate tops, if different than the number of sections for the same size wood top. Please note the grain direction of wood grain laminates will run lengthwise on 1 piece tops and crosswise on multiple piece table tops.

**SEATING CAPACITY:**

The number in brackets is the seating capacity when formed metal legs are used if different than the seating capacity when other bases are used.

**ORDERING PROCEDURES**

- To order, please specify the following:
- 1) Table top shape, size, model number and wood species
  - 2) Base model number
  - 3) Console location and size option
  - 4) Cross seam console model number, where applicable
  - 5) Console power module and data options

**DIMENSION KEY**

L - Length  
W - Width  
Dimensions are in inches and approximate.  
Contact Customer Service if dimensions are critical.

**STANDARD FINISHES**

For a complete list of standard wood finishes, please see page 347

**BASE REQUIREMENTS**

See page 60 for base requirements

**CONSOLE SIZE & LOCATIONS**

For information on Console locations and size options, see page 15 for wood and page 25 for laminate.

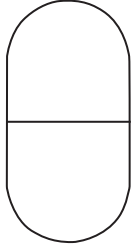
**CONSOLE POWER/DATA MODULE OPTIONS**

See page 49 for Console Module Options

**TABLE SECTION SIZE**

Section sizes can be calculated by dividing the table length by the # of sections

# NUVO | RACETRACK CONFERENCE TOPS

| Description   | Model      | Laminate           |        | L   | W     | Table Sections | Approximate Seating | Shipping Weight | Cubic Feet |
|---|------------|--------------------|--------|-----|-------|----------------|---------------------|-----------------|------------|
|   |            | Oak, Maple, Cherry | Walnut |     |       |                |                     |                 |            |
|  | 51026036   | 2797               | 3078   | 60  | 36    | 1              | 4                   | 83              | 5          |
|   | 51026042   | 2941               | 3235   | 60  | 42    | 1              | 4                   | 94              | 5          |
|   | 51026048   | 3097               | 3408   | 60  | 48    | 1              | 4                   | 104             | 6          |
|   | 51027236   | 2984               | 3281   | 72  | 36    | 1              | 6                   | 101             | 6          |
|   | 51027242   | 3140               | 3455   | 72  | 42    | 1              | 6                   | 115             | 6          |
|   | 51027248   | 3285               | 3612   | 72  | 48    | 1              | 6                   | 127             | 7          |
|   | 51027836   | 3241               | 3564   | 78  | 36    | 1              | 6                   | 110             | 6          |
|   | 51027842   | 3428               | 3770   | 78  | 42    | 1              | 6                   | 126             | 7          |
|   | 51027848   | 3601               | 3959   | 78  | 48    | 1              | 6                   | 140             | 8          |
|   | 51028436   | 3470               | 3817   | 84  | 36    | 1              | 6                   | 119             | 7          |
|   | 51028442   | 3700               | 4069   | 84  | 42    | 1              | 6                   | 136             | 7          |
|   | 51028448   | 3916               | 4306   | 84  | 48    | 1              | 6                   | 152             | 9          |
|   | 51029636   | 3613               | 3975   | 96  | 36    | 1              | 8                   | 138             | 7          |
|   | 51029642   | 4216               | 4637   | 96  | 42    | 2              | 8                   | 159             | 9          |
|   | 51029648   | 4819               | 5299   | 96  | 48    | 2              | 8                   | 178             | 10         |
|   | 510210842  | 4374               | 4812   | 108 | 42    | 2 (3)          | 8                   | 180             | 10         |
|   | 510210848* | 5047               | 5553   | 108 | 48    | 2 (3)          | 8                   | 202             | 11         |
|   | 510210854  | 5808               | 6389   | 108 | 54    | 3              | 10 (8)              | 226             | 12         |
|   | 510212042  | 5276               | 5803   | 120 | 42    | 2 (3)          | 8                   | 202             | 11         |
|   | 510212048  | 5950               | 6544   | 120 | 48    | 2 (3)          | 10                  | 227             | 12         |
|   | 510212054  | 6625               | 7287   | 120 | 54    | 3              | 10                  | 251             | 14         |
|   | 510212060  | 7386               | 8122   | 120 | 60    | 3              | 10 (8)              | 275             | 15         |
|   | 510214448  | 6783               | 7461   | 144 | 48    | 2 (3)          | 12 (10)             | 277             | 15         |
|   | 510214454  | 7614               | 8373   | 144 | 54    | 3              | 12 (10)             | 307             | 16         |
|   | 510214460  | 8516               | 9368   | 144 | 60    | 3              | 12 (10)             | 337             | 16         |
|   | 510215654  | 8286               | 9108   | 156 | 54    | 3 (4)          | 14 (12)             | 336             | 18         |
|   | 510215660  | 9334               | 10266  | 156 | 60    | 3 (4)          | 14 (12)             | 369             | 20         |
|   | 510216848  | 8962               | 9857   | 168 | 48    | 3 (4)          | 12                  | 326             | 17         |
|   | 510216854  | 10093              | 11102  | 168 | 54    | 4              | 14 (12)             | 364             | 19         |
|   | 510216860  | 11371              | 12507  | 168 | 60    | 4              | 14 (12)             | 399             | 21         |
| 510219248   | 10466      | 11514              | 192    | 48  | 3 (4) | 14             | 376                 | 20              |            |
| 510219254   | 11743      | 12916              | 192    | 54  | 4     | 16 (14)        | 418                 | 22              |            |
| 510219260   | 13175      | 14492              | 192    | 60  | 4     | 16 (14)        | 460                 | 24              |            |
| 510221654   | 12947      | 14242              | 216    | 54  | 5     | 18 (16)        | 475                 | 25              |            |
| 510221660   | 14538      | 15992              | 216    | 60  | 5     | 18 (16)        | 522                 | 27              |            |
| 510224060   | 16416      | 18056              | 240    | 60  | 5     | 18 (16)        | 584                 | 30              |            |
| 510226460   | 18594      | 20451              | 264    | 60  | 6     | 20 (18)        | 647                 | 33              |            |
| 510228860   | 21002      | 23102              | 288    | 60  | 6     | 22 (20)        | 707                 | 36              |            |

**NOTE:** Support Beams are included in top price. An additional line item for the support beam will be included on the order acknowledgment at no charge.

**LAMINATE TABLE SECTIONS:**

The number in brackets under table sections, refers to the number of sections when ordering laminate tops, if different than the number of sections for the same size wood top. Please note the grain direction of wood grain laminates will run lengthwise on 1 piece tops and crosswise on multiple piece table tops.

**SEATING CAPACITY:**

The number in brackets is the seating capacity when formed metal legs are used if different than the seating capacity when other bases are used.

**ORDERING PROCEDURES**

To order, please specify the following:

- 1) Table top shape, size, model number and wood species
- 2) Base model number
- 3) Console location and size option
- 4) Cross seam console model number, where applicable
- 5) Console power module and data options

**DIMENSION KEY**

L - length

W - Width

Dimensions are in inches and approximate.

Contact Customer Service if dimensions are critical.

**STANDARD FINISHES**

For a complete list of standard wood finishes, please see page 347

**BASE REQUIREMENTS**

See page 60 for base requirements

**CONSOLE SIZE & LOCATIONS**

For information on Console locations and size options, see page 15 for wood and page 25 for laminate.

**CONSOLE POWER/DATA MODULE OPTIONS**

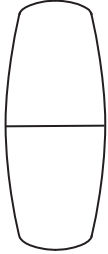
See page 49 for Console Module Options

**TABLE SECTION SIZE**

Section sizes can be calculated by dividing the table length by the # of sections

# NUVO | BOAT SHAPED & VISIO CONFERENCE TOPS

| Description           | Model       | Laminate           |        | L   | W     | Table Sections | Approximate Seating | Shipping Weight | Cubic Feet |
|-----------------------|-------------|--------------------|--------|-----|-------|----------------|---------------------|-----------------|------------|
|                       |             | Oak, Maple, Cherry | Walnut |     |       |                |                     |                 |            |
| Boat-Shaped - Arc End | 5164964842  | 5210               | 5729   | 96  | 48/42 | 2              | 8                   | 181             | 10         |
|                       | 5164965442* | 6109               | 6718   | 96  | 54/42 | 2              | 8                   | 204             | 11         |
| Rounded Corners       | 51641204842 | 6430               | 7071   | 120 | 48/42 | 2 (3)          | 8                   | 229             | 12         |
|                       | 51641205442 | 7164               | 7882   | 120 | 54/42 | 3              | 10 (8)              | 257             | 14         |
|                       | 51641444842 | 7316               | 8046   | 144 | 48/42 | 2 (3)          | 10                  | 276             | 15         |
|                       | 51641445442 | 8220               | 9041   | 144 | 54/42 | 3              | 12                  | 311             | 15         |
|                       | 51641685442 | 10900              | 11987  | 168 | 54/42 | 4              | 12                  | 366             | 19         |
|                       | 51641925442 | 12691              | 13960  | 192 | 54/42 | 4              | 14                  | 419             | 22         |
|                       | 51642166048 | 15702              | 17270  | 216 | 60/48 | 5              | 16                  | 526             | 27         |
|                       | 51642406048 | 17733              | 19505  | 240 | 60/48 | 5              | 18 (16)             | 585             | 30         |
|                       | 51642646048 | 20081              | 22089  | 264 | 60/48 | 6              | 20                  | 646             | 33         |
|                       | 51642886048 | 22684              | 24953  | 288 | 60/48 | 6              | 22                  | 704             | 36         |



**NOTE:** Support Beams are included in top price. An additional line item for the support beam will be included on the order acknowledgment at no charge.

**BOAT SHAPE - ARC END, SQUARE CORNERS:**

Boat Shape tops are available with Arc ends and Square corners. For Arc End, Square Corner tops replace model suffix with **5154**. e.g. **51641204842** becomes **51541204842**. Pricing is the same as standard tops.

**BOAT SHAPE - STRAIGHT END, SQUARE CORNERS:**

Boat Shape tops are available with Straight ends and square corners. For Straight End, Square Corner tops replace model suffix with **5104**. e.g. **51641204842** becomes **51041204842**. Pricing is the same as standard tops.

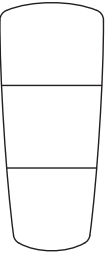
**LAMINATE TABLE SECTIONS:**

The number in brackets under table sections, refers to the number of sections when ordering laminate tops, if different than the number of sections for the same size wood top. Please note the grain direction of wood grain laminates will run lengthwise on 1 piece tops and crosswise on multiple piece table tops.

**SEATING CAPACITY:**

The number in brackets is the seating capacity when formed metal legs are used if different than the seating capacity when other bases are used.

|                                    |              |       |       |     |       |   |    |     |    |
|------------------------------------|--------------|-------|-------|-----|-------|---|----|-----|----|
| Visio - Arc End<br>Rounded Corners | 51681206042  | 9560  | 10514 | 120 | 60/42 | 3 | 8  | 268 | 15 |
|                                    | 51681446042* | 13083 | 14389 | 144 | 60/42 | 3 | 10 | 323 | 18 |
|                                    | 51681686642  | 13909 | 15297 | 168 | 66/42 | 4 | 13 | 407 | 23 |
|                                    | 51681926942  | 14994 | 16494 | 192 | 69/42 | 4 | 15 | 482 | 27 |
|                                    | 51682167342  | 16333 | 17966 | 216 | 73/42 | 5 | 17 | 567 | 32 |
|                                    | 51682407642  | 17508 | 19259 | 240 | 76/42 | 5 | 19 | 651 | 38 |



**NOTE:** Support Beams are included in top price. An additional line item for the support beam will be included on the order acknowledgment at no charge.

**VISIO - ARC END, SQUARE CORNERS:**

Visio Shape Tops with Arc Ends are available with square corners. For Arc End-Square corners, replace the model suffix with **5158**. e.g. **51681446042** becomes **51581446042**. Pricing is the same as standard tops.

**VISIO - STRAIGHT END, SQUARE CORNERS:**

Visio Shape Tops with Straight Ends are available with square corners. For Arc Straight End-Square corners, replace the model suffix with **5108**. e.g. **51681446042** becomes **51081446042**. Pricing is the same as standard tops.

**ORDERING PROCEDURES**

To order, please specify the following:

- 1) Table top shape, size, model number and wood species
- 2) Base model number
- 3) Console location and size option
- 4) Cross seam console model number, where applicable
- 5) Console power module and data options

**DIMENSION KEY**

L - Length

W - Width

Dimensions are in inches and approximate.

Contact Customer Service if dimensions are critical.

12 | USA | CONFERENCE | 2025

**STANDARD FINISHES**

For a complete list of standard wood finishes, please see page 347

**BASE REQUIREMENTS**

See page 60 for base requirements

**CONSOLE SIZE & LOCATIONS**

For information on Console locations and size options, see page 15 for wood and page 25 for laminate.

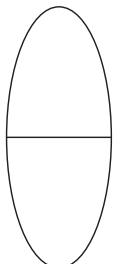
**CONSOLE POWER/DATA MODULE OPTIONS**

See page 49 for Console Module Options

**TABLE SECTION SIZE**

Section sizes can be calculated by dividing the table length by the # of sections

# NUVO | OVAL, ARCED SQUARE & ROUND CONFERENCE TOPS

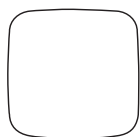
| Description   | Model      | Laminate           |        | L   | W  | Table Sections | Approximate Seating | Shipping Weight | Cubic Feet |
|---|------------|--------------------|--------|-----|----|----------------|---------------------|-----------------|------------|
|   |            | Oak, Maple, Cherry | Walnut |     |    |                |                     |                 |            |
|  | 51598448   | 4503               | 4951   | 84  | 48 | 1              | 6                   | 136             | 9          |
|   | 51599648   | 5751               | 6325   | 96  | 48 | 2              | 8                   | 157             | 10         |
|   | 51599654   | 6232               | 6857   | 96  | 54 | 2              | 8                   | 176             | 11         |
|   | 515912048* | 6850               | 7534   | 120 | 48 | 2 (3)          | 8                   | 196             | 12         |
|   | 515912060  | 7422               | 8163   | 120 | 60 | 3              | 10                  | 243             | 15         |
|   | 515914454  | 8537               | 9388   | 144 | 54 | 3              | 10                  | 264             | 16         |
|   | 515914460  | 8957               | 9853   | 144 | 60 | 3              | 12                  | 292             | 18         |
|   | 515916860  | 10206              | 11228  | 168 | 60 | 4              | 12                  | 341             | 21         |

**NOTE:** Support Beams are included in top price. An additional line item for the support beam will be included on the order acknowledgment at no charge.

**LAMINATE TABLE SECTIONS:**

The number in brackets under table sections, refers to the number of sections when ordering laminate tops, if different than the number of sections for the same size wood top.

**Arced Square Top**

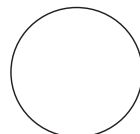


|          |      |      |    |    |   |   |     |   |
|----------|------|------|----|----|---|---|-----|---|
| 51663636 | 2033 | 2237 | 36 | 36 | 1 | 4 | 59  | 3 |
| 51664242 | 2243 | 2466 | 42 | 42 | 1 | 4 | 79  | 4 |
| 51664848 | 2530 | 2781 | 48 | 48 | 1 | 4 | 101 | 5 |
| 51665454 | 2860 | 3146 | 54 | 54 | 1 | 4 | 127 | 7 |
| 51666060 | 3706 | 4072 | 60 | 60 | 1 | 4 | 155 | 8 |

**ARC SQUARE TOP - SQUARE CORNERS:**

Arc Square tops are available with square corners. For Square Corner tops replace model suffix with **5156**. e.g. **51664242** becomes **51564242**. Pricing is the same as standard tops.

**Round Top**



|        |      |      |         |  |   |   |     |   |
|--------|------|------|---------|--|---|---|-----|---|
| 510536 | 1988 | 2188 | 36 Dia. |  | 1 | 3 | 47  | 3 |
| 510542 | 2197 | 2418 | 42 Dia. |  | 1 | 3 | 63  | 4 |
| 510548 | 2470 | 2716 | 48 Dia. |  | 1 | 4 | 80  | 5 |
| 510554 | 3192 | 3512 | 54 Dia. |  | 1 | 5 | 100 | 7 |
| 510560 | 3718 | 4090 | 60 Dia. |  | 1 | 5 | 123 | 8 |

**ORDERING PROCEDURES**

To order, please specify the following:

- 1) Table top shape, size, model number and wood species
- 2) Base model number
- 3) Console location and size option
- 4) Cross seam console model number, where applicable
- 5) Console power module and data options

**DIMENSION KEY**

L - Length  
W - Width  
D - Depth  
H - Height

Dimensions are in inches and approximate.  
Contact Customer Service if dimensions are critical.

**STANDARD FINISHES**

For a complete list of standard wood finishes, please see page 347

**BASE REQUIREMENTS**

See page 60 for base requirements

**CONSOLE SIZE & LOCATIONS**

For information on Console locations and size options, see page 15 for wood and page 25 for laminate.

**CONSOLE POWER/DATA MODULE OPTIONS**

See page 49 for Console Module Options

**TABLE SECTION SIZE**

Section sizes can be calculated by dividing the table length by the # of sections

# NUVO | CONSOLE PLANNING FOR WOOD TOPS

## CONSOLE ORDERING CODE (WITHIN THE TABLE SECTION - 4 CHARACTER CODE)

1st character specifies top sections from left to right on table: A, B, C, D, E, F

2nd character specifies console location within top section: M, I, L, R

M- Middle of top on one piece table

M- Middle of top section on multi section table

I - Inset 3" from seam on end sections

L- Left side of a one piece top

R- Right side of a one piece top

3rd and 4th characters specify console size: 14, 27, 36, 42, 50

Examples:

Table Size: 96" x 36"

AM42

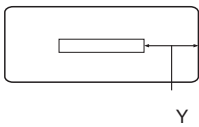


Table Size: 168" x 48"

AM14

BM50

CM14

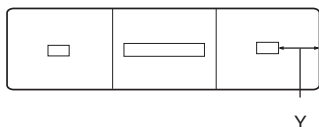


Table Size: 96 "x 36"

AL14

AR14

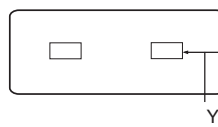
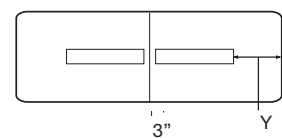


Table Size: 144" x 48"

AI42

BI42



Y= Dimension from end of table to end of console  
18" or greater, cannot be less than 18"

## CONSOLE ORDERING CODE (ACROSS SEAM - 5 CHARACTER CODE)

1st and 2nd character specifies section from left to right on table: AB, BC, CD, DE, EF

3rd character specifies console location across the seam: X

4th and 5th characters specify console size: 14, 27, 36, 42, 50

Examples:

Table Size: 288" x 60"

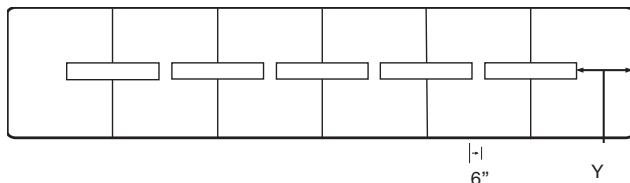
ABX42

BCX42

CDX42

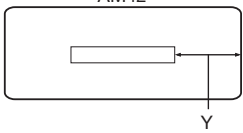
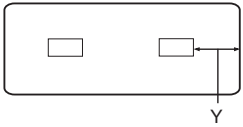
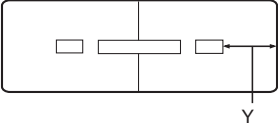
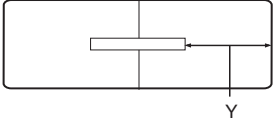
DEX42

EFX42



Y= Dimension from end of table to end of console

# NUVO | CONSOLE SIZE & LOCATION - RECTANGULAR, ARC END, RACETRACK

| Wood Top Console Options  | Top Length | Console Options Top End Section | Console Options Within Top Center Section | Console Options Across Seam | Y           |      |
|---|------------|---------------------------------|---|-----------------------------|-------------|------|
| <b>WIDTHS 36" - 48"</b>   | 60         | M14                             |   |                             | 23          |      |
| 60" - 84" X 36", 42", 48"   | 72         | M14                             |   |                             | 29          |      |
| 96" X 36"   |            | M27                             |   |                             | 22.5        |      |
| Example   | 78         | M14                             |   |                             | 32          |      |
|    |            | M27                             |   |                             | 25.5        |      |
|   |            | M36                             |   |                             | 21          |      |
|   |            | M42                             |   |                             | 18          |      |
|   | 84         | M14                             |   |                             | 35          |      |
|   |            | M27                             |   |                             | 28.5        |      |
|   |            | M36                             |   |                             | 24          |      |
|   |            | M42                             |   |                             | 21          |      |
|   | 96         | M14                             |   |                             | 41          |      |
|   |            | M27                             |   |                             | 34.5        |      |
|   |            | M36                             |   |                             | 30          |      |
|   |            | M42                             |   |                             | 27          |      |
|   |            | M50                             |   |                             | 23          |      |
| <b>78" - 84" X 36", 42", 48"</b>  | 78         | L14 / R14                       |   |                             | 18          |      |
| 96" X 36"   | 84         | L14 / R14                       |   |                             | 18          |      |
| Example   | 96         | L14 / R14                       |   |                             | 18          |      |
|   |            |                                 |   |                             |             |      |
|   |            |                                 |   |                             |             |      |
|   |            |                                 |   |                             |             |      |
| <b>96" - 144" X 42", 48"</b>  | 96         | M14                             |   |                             | 18          |      |
| Example   | 108        | M14                             |   | X27                         | 20          |      |
|  |            | M14                             |   | X27                         | 23          |      |
|   |            | 144                             | M14                                       |                             | X27 X36 X42 | 29   |
|   |            |                                 | M27                                       |                             | X27         | 22.5 |
| <b>96" - 144" X 42", 48"</b>  | 96         |                                 |   | X27                         | 34.5        |      |
| Example   |            |                                 |   | X36                         | 30          |      |
|   |            |                                 |   | X42                         | 27          |      |
|   |            |                                 |   | X50                         | 23          |      |
|   | 108        |                                 |   | X27                         | 40.5        |      |
|  |            |                                 |   | X36                         | 36          |      |
|   |            |                                 |   | X42                         | 33          |      |
|   |            |                                 |   | X50                         | 29          |      |
|   | 120        |                                 |   | X36                         | 42          |      |
|   |            |                                 |   | X42                         | 39          |      |
|   |            |                                 |   | X50                         | 35          |      |
|   | 144        |                                 |   | X50                         | 47          |      |

## CODE KEY

M - Console location, middle of top section  
 I - Console location, Inset 3" from seam on end sections  
 X - Console location, across a seam of two top sections  
 L - Console location, left side of a one piece top  
 R - Console location, right side of a one piece top  
 Y - Dimension from end of table to end of Console

Caution: Y greater than 30" makes access to Console Power/Data difficult from the end of the table

## CONSOLE SIZE & LOCATIONS

See page 15 for information on console locations and size options for wood tops, and page 25 for laminate tops locations and sizes

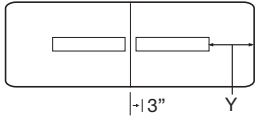
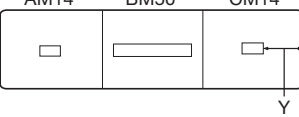
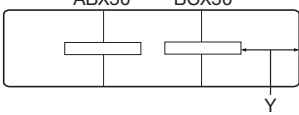
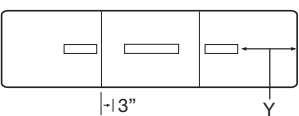
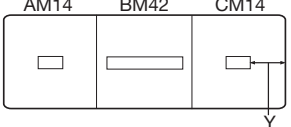
## CONSOLE MODULE OPTIONS

See page 49 for power / data options

## ORDERING NOTES

Tops may be specified with fewer consoles and configurations other than shown. Consoles can be different sizes within the same top. Dimension from end of cut-out to table end cannot be less than 18".

# NUVO | CONSOLE SIZE & LOCATION - RECTANGULAR, ARC END, RACETRACK

| Wood Top Console Options   | Top Length | Console Options Top End Section | Console Options Within Top Center Section | Console Options Across Seam | Y    |
|--|------------|---------------------------------|---|-----------------------------|------|
| <b>WIDTHS 36" - 48"</b>  | 96         | I27                             |   |                             | 18   |
| 96" - 144" X 42", 48"  | 108        | I27                             |   |                             | 24   |
| Example  | 120        | I27                             |   |                             | 30   |
|    | 144        | I36                             |   |                             | 21   |
|  |            | I27                             |   |                             | 42   |
|  |            | I36                             |   |                             | 33   |
|  |            | I42                             |   |                             | 27   |
|  |            | I50                             |   |                             | 19   |
| <b>168" - 192" X 48"</b>   | 168        | M14                             | M14 M27 M36 M42 M50                       |                             | 21   |
|  |            | I27                             | M14 M27 M36 M42 M50                       |                             | 26   |
| Example  | 192        | M14                             | M14 M27 M36 M42 M50                       |                             | 25   |
|    |            | I27                             | M14 M27 M36 M42 M50                       |                             | 34   |
|  |            | I36                             | M14 M27 M36 M42 M50                       |                             | 25   |
| <b>168" - 192" X 48"</b>   | 168        |                                 |   | X14                         | 49   |
|  |            |                                 |   | X27                         | 42.5 |
| Example  |            |                                 |   | X36                         | 38   |
|   |            |                                 |   | X42                         | 35   |
|  | 192        |                                 |   | X50                         | 31   |
|  |            |                                 |   | X36                         | 46   |
|  |            |                                 |   | X42                         | 43   |
|  |            |                                 |   | X50                         | 39   |
| <b>168" - 192" X 48"</b>   | 168        | M14                             | M14 M27 M36 M42                           |                             | 21   |
|  |            | I27                             | M14 M27 M36 M42                           |                             | 26   |
| Example  | 192        | M14                             | M14 M27 M36 M42 M50                       |                             | 25   |
|    |            | I27                             | M14 M27 M36 M42 M50                       |                             | 34   |
| <b>WIDTHS 54" OR GREATER</b>   | 108        | I14                             | M14 M27                                   |                             | 19   |
| 108" - 156" X 54", 60"   | 120        | I14                             | M14 M27                                   |                             | 23   |
| Example  | 144        | M14                             | M14 M27 M36 M42                           |                             | 18   |
|  |            | I14                             | M14 M27 M36 M42                           |                             | 31   |
|  |            | I27                             | M14 M27 M36 M42                           |                             | 18   |
|  | 156        | M14                             | M14 M27 M36 M42                           |                             | 19   |
|  |            | I14                             | M14 M27 M36 M42                           |                             | 35   |
|  |            | I27                             | M14 M27 M36 M42                           |                             | 22   |

## CODE KEY

M - Console location, middle of top section  
 I - Console location, Inset 3" from seam on end sections  
 X - Console location, across a seam of two top sections  
 L - Console location, left side of a one piece top  
 R - Console location, right side of a one piece top  
 Y - Dimension from end of table to end of Console

Caution: Y greater than 30" makes access to Console Power/Data difficult from the end of the table

## CONSOLE SIZE & LOCATIONS

See page 15 for information on console locations and size options for wood tops, and page 25 for laminate tops locations and sizes

## CONSOLE MODULE OPTIONS

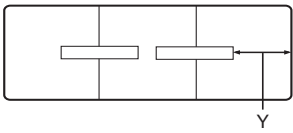
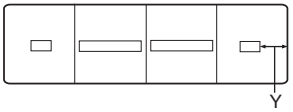
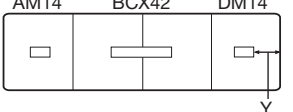
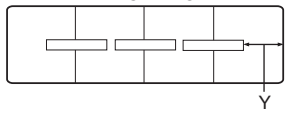
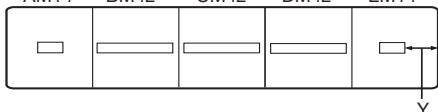
See page 49 for power / data options

## ORDERING NOTES

Tops may be specified with fewer consoles and configurations other than shown. Consoles can be different sizes within the same top. Dimension from end of cut-out to table end cannot be less than 18".



# NUVO | CONSOLE SIZE & LOCATION - RECTANGULAR, ARC END, RACETRACK

| Wood Top Console Options  | Top Length             | Console Options Top End Section | Console Options Within Top Center Section             | Console Options Across Seam   | Y                |
|---|------------------------|---------------------------------|---|-------------------------------|------------------|
| <b>WIDTHS 54" OR GREATER</b>  | 108                    |                                 |   | X27                           | 22.5             |
| 108" - 156" X 54", 60"  | 120                    |                                 |   | X27                           | 26.5             |
| Example   | 144                    |                                 |   | X36<br>X42                    | 30<br>27         |
|    | 156                    |                                 |   | X36<br>X42                    | 34<br>31         |
| 168"-192" X 54", 60"  | 168                    | I14                             | M14 M27 M36   |                               | 25               |
| Example   | 192                    | M14<br>I14<br>I27               | M14 M27 M36 M42<br>M14 M27 M36 M42<br>M14 M27 M36 M42 |                               | 18<br>31<br>18   |
|    | 168" - 192" X 54", 60" | I14                             |   | X27 X36 X42                   | 25               |
| Example   | 192                    | M14<br>I14<br>I27               |   | X36 X42<br>X36 X42<br>X36 X42 | 18<br>31<br>18   |
|   | 168" - 192" x 54", 60" |                                 |   | X27<br>X36                    | 28.5<br>24       |
| Example   | 192                    |                                 |   | X27<br>X36<br>X42             | 34.5<br>30<br>27 |
|  | 216"- 240" X 54", 60"  | I14                             | M14 M27 M36   |                               | 26               |
| Example   | 240                    | M14<br>14<br>I27                | M14 M27 M36 M42<br>M14 M27 M36 M42<br>M14 M27 M36 M42 |                               | 18<br>31<br>18   |
|  |                        |                                 |   |                               |                  |

## CODE KEY

M - Console location, middle of top section  
 I - Console location, Inset 3" from seam on end sections  
 X - Console location, across a seam of two top sections  
 L - Console location, left side of a one piece top  
 R - Console location, right side of a one piece top  
 Y- Dimension from end of table to end of Console

Caution: Y greater than 30" makes access to Console Power/Data difficult from the end of the table

## CONSOLE SIZE & LOCATIONS

See page 15 for information on console locations and size options for wood tops, and page 25 for laminate tops locations and sizes

## CONSOLE MODULE OPTIONS

See page 49 for power / data options

## ORDERING NOTES

Tops may be specified with fewer consoles and configurations other than shown. Consoles can be different sizes within the same top. Dimension from end of cut-out to table end cannot be less than 18".

# NUVO | CONSOLE SIZE & LOCATION - RECTANGULAR, ARC END, RACETRACK

| Wood Top Console Options      | Top Length | Console Options Top End Section | Console Options Within Top Center Section                                | Console Options Across Seam               | Y                      |
|-------------------------------|------------|---------------------------------|--|---|------------------------|
| <b>WIDTHS 54" OR GREATER</b>  | 216        |                                 |  | X27<br>X36                                | 29.5<br>25             |
| 216" - 240" X 54", 60"        |            |                                 |  |   |                        |
| Example                       | 240        |                                 |  | X27<br>X36<br>X42                         | 34.5<br>30<br>27       |
| ABX42 BCX42 CDX42 DEX42       |            |                                 |  |   |                        |
|                               |            |                                 |  |   |                        |
| 216" - 240" X 54", 60"        | 216        |                                 | M14 M27 M36<br>M14 M27 M36<br>M14 M27 M36                                | X27<br>X36<br>X42                         | 29.5<br>25<br>22       |
| Example                       | 240        |                                 | M14 M27 M36 M42<br>M14 M27 M36 M42<br>M14 M27 M36 M42<br>M14 M27 M36 M42 | X27<br>X36<br>X42<br>X50                  | 34.5<br>30<br>27<br>23 |
| ABX42 CM42 DEX42              |            |                                 |  |   |                        |
|                               |            |                                 |  |   |                        |
| 264" - 288" X 60"             | 264        | M14<br>I14                      | M14 M27 M36  |   | 18<br>27               |
| Example                       | 288        | M14<br>I14<br>I27               | M14 M27 M36 M42<br>M14 M27 M36 M42<br>M14 M27 M36 M42                    |   | 18<br>31<br>18         |
| AM14 BM42 CM42 DM42 EM42 FM14 |            |                                 |  |   |                        |
|                               |            |                                 |  |   |                        |
| 264" - 288" X 60"             | 264        | M14<br>I14                      |  | X36 X42 X50                               | 18<br>27               |
| Example                       | 288        | M14<br>I14<br>I27               |  | X36 X42 X50<br>X36 X42 X50<br>X36 X42 X50 | 18<br>31<br>18         |
| AM14 BCX42 DEX42 FM14         |            |                                 |  |   |                        |
|                               |            |                                 |  |   |                        |
| 264" - 288" X 60"             | 264        |                                 |  | X27<br>X36                                | 30.5<br>26             |
| Example                       | 288        |                                 |  | X27<br>X36<br>X42                         | 34.5<br>30<br>27       |
| ABX42 BCX42 CDX42 DEX42 EFX42 |            |                                 |  |   |                        |
|                               |            |                                 |  |   |                        |
| 264" - 288" X 60"             | 264        |                                 |  | X27<br>X36<br>X42                         | 30.5<br>26<br>23       |
| Example                       | 288        |                                 |  | X27<br>X36<br>X42<br>X50                  | 34.5<br>30<br>27<br>23 |
| ABX42 CDX42 EFX42             |            |                                 |  |   |                        |
|                               |            |                                 |  |   |                        |

## CODE KEY

M - Console location, middle of top section  
 I - Console location, Inset 3" from seam on end sections  
 X - Console location, across a seam of two top sections  
 L - Console location, left side of a one piece top  
 R - Console location, right side of a one piece top  
 Y- Dimension from end of table to end of Console

Caution: Y greater than 30" makes access to Console Power/Data difficult from the end of the table

## CONSOLE SIZE & LOCATIONS

See page 15 for information on console locations and size options for wood tops, and page 25 for laminate tops locations and sizes

## CONSOLE MODULE OPTIONS

See page 49 for power / data options

## ORDERING NOTES

Tops may be specified with fewer consoles and configurations other than shown. Consoles can be different sizes within the same top. Dimension from end of cut-out to table end cannot be less than 18".

# NUVO | CONSOLE SIZE & LOCATION - BOAT SHAPED

| Wood Top Console Options              | Top Length | Console Options Top End Section | Console Options Within Top Center Section             | Console Options Across Seam | Y                    |
|---------------------------------------|------------|---------------------------------|---|-----------------------------|----------------------|
| 96" - 144" X 48"/42"<br>96" X 54"/42" | 96         | M14                             |   |                             | 18                   |
| Example                               | 120        | M14                             |   | X27                         | 23                   |
| AM14 ABX42 BM14                       | 144        | M14<br>M27                      |   | X27 X36 X42                 | 29<br>22.5           |
|                                       |            |                                 |   |                             |                      |
| 96" - 144" X 48"/42"<br>96" X 54"/42" | 96         |                                 |   | X27<br>X36<br>X42           | 34.5<br>30<br>27     |
| Example                               | 120        |                                 |   | X50                         | 23                   |
| ABX50                                 | 144        |                                 |   | X36<br>X42<br>X50           | 42<br>39<br>35       |
|                                       |            |                                 |   |                             |                      |
| 96" - 144" X 48"/42"<br>96" X 54"/42" | 96         | I27                             |   |                             | 18                   |
| Example                               | 120        | I27<br>I36                      |   |                             | 30<br>21             |
| A142 BI42                             | 144        | I27<br>I36<br>I42<br>I50        |   |                             | 42<br>33<br>27<br>19 |
|                                       |            |                                 |   |                             |                      |
| 120" - 144" x 54"/42"                 | 120        | I14                             | M14 M27   |                             | 23                   |
| Example                               | 144        | M14<br>I14<br>I27               | M14 M27 M36 M42<br>M14 M27 M36 M42<br>M14 M27 M36 M42 |                             | 18<br>31<br>18       |
| AM14 BM42 CM14                        |            |                                 |   |                             |                      |
|                                       |            |                                 |   |                             |                      |
| 120" - 144" x 54"/42"                 | 120        |                                 |   | X27                         | 26.5                 |
| Example                               | 144        |                                 |   | X36<br>X42                  | 30<br>27             |
| ABX42 BCX42                           |            |                                 |   |                             |                      |
|                                       |            |                                 |   |                             |                      |
| 168" - 192" X 54"/42"                 | 168        | I14                             | M14 M27 M36   |                             | 25                   |
| Example                               | 192        | M14<br>I14<br>I27               | M14 M27 M36 M42<br>M14 M27 M36 M42<br>M14 M27 M36 M42 |                             | 18<br>31<br>18       |
| AM14 BM42 CM42 DM14                   |            |                                 |   |                             |                      |
|                                       |            |                                 |   |                             |                      |

## CODE KEY

M - Console location, middle of top section  
 I - Console location, Inset 3" from seam on end sections  
 X - Console location, across a seam of two top sections  
 L - Console location, left side of a one piece top  
 R - Console location, right side of a one piece top  
 Y - Dimension from end of table to end of Console

Caution: Y greater than 30" makes access to Console Power/Data difficult from the end of the table

## CONSOLE SIZE & LOCATIONS

See page 15 for information on console locations and size options for wood tops, and page 25 for laminate tops locations and sizes

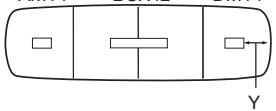
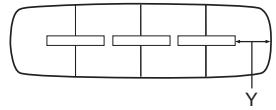
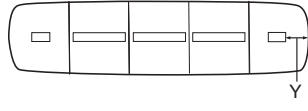
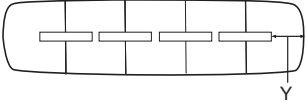
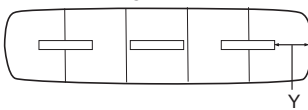
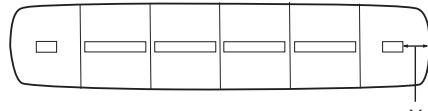
## CONSOLE MODULE OPTIONS

See page 49 for power / data options

## ORDERING NOTES

Tops may be specified with fewer consoles and configurations other than shown. Consoles can be different sizes within the same top. Dimension from end of cut-out to table end cannot be less than 18".

# NUVO | CONSOLE SIZE & LOCATION - BOAT SHAPED

| Wood Top Console Options   | Top Length | Console Options Top End Section | Console Options Within Top Center Section                                | Console Options Across Seam   | Y                      |
|--|------------|---------------------------------|--|-------------------------------|------------------------|
| 168" - 192" X 54"/42"  | 168        | I14                             |  | X27 X36 X42                   | 25                     |
| Example  | 192        | M14<br>I14<br>I27               |  | X36 X42<br>X36 X42<br>X36 X42 | 18<br>31<br>18         |
|    |            |                                 |  |                               |                        |
| 168" - 192" X 54"/42"  | 168        |                                 |  | X27<br>X36                    | 28.5<br>24             |
| Example  | 192        |                                 |  | X27<br>X36<br>X42             | 34.5<br>30<br>27       |
|    |            |                                 |  |                               |                        |
| 216" - 240" X 60"/48"  | 216        | I14                             | M14 M27 M36  |                               | 26                     |
| Example  | 240        | M14<br>I14<br>I27               | M14 M27 M36 M42<br>M14 M27 M36 M42<br>M14 M27 M36 M42                    |                               | 18<br>31<br>18         |
|    |            |                                 |  |                               |                        |
| 216" - 240" X 60"/48"  | 216        |                                 |  | X27<br>X36                    | 29.5<br>24             |
| Example  | 240        |                                 |  | X27<br>X36<br>X42             | 34.5<br>30<br>27       |
|  |            |                                 |  |                               |                        |
| 216" - 240" X 60"/48"  | 216        |                                 | M14 M27 M36<br>M14 M27 M36<br>M14 M27 M36                                | X27<br>X36<br>X42             | 29.5<br>25<br>22       |
| Example  | 240        |                                 | M14 M27 M36 M42<br>M14 M27 M36 M42<br>M14 M27 M36 M42<br>M14 M27 M36 M42 | X27<br>X36<br>X42<br>X50      | 34.5<br>30<br>27<br>23 |
|  |            |                                 |  |                               |                        |
| 264" - 288" X 60"/48"  | 264        | M14<br>I14                      | M14 M36  |                               | 18<br>27               |
| Example  | 288        | M14<br>I14<br>I27               | M14 M36 M42<br>M14 M36 M42<br>M14 M36 M42                                |                               | 18<br>31<br>18         |
|  |            |                                 |  |                               |                        |

## CODE KEY

- M - Console location, middle of top section
- I - Console location, Inset 3" from seam on end sections
- X - Console location, across a seam of two top sections
- L - Console location, left side of a one piece top
- R - Console location, right side of a one piece top
- Y - Dimension from end of table to end of Console

Caution: Y greater than 30" makes access to Console Power/Data difficult from the end of the table

## CONSOLE SIZE & LOCATIONS

See page 15 for information on console locations and size options for wood tops, and page 25 for laminate tops locations and sizes

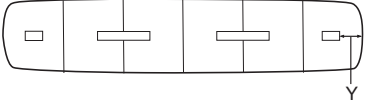
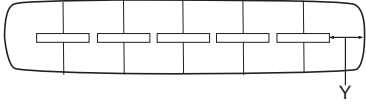
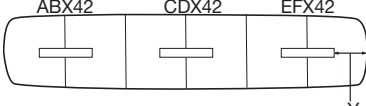
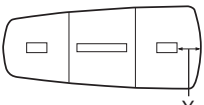
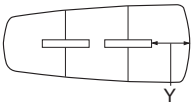
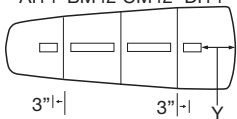
## CONSOLE MODULE OPTIONS

See page 49 for power / data options

## ORDERING NOTES

Tops may be specified with fewer consoles and configurations other than shown. Consoles can be different sizes within the same top. Dimension from end of cut-out to table end cannot be less than 18".

# NUVO | CONSOLE SIZE & LOCATION - BOAT SHAPED & VISIO

| Wood Top Console Options  | Top Length | Console Options Top End Section | Console Options Within Top Center Section | Console Options Across Seam | Y                      |
|---|------------|---------------------------------|---|-----------------------------|------------------------|
| 264" - 288" X 60"/48"   | 264        | M14<br>I14                      |   | X36 X42 X50                 | 18<br>27               |
| Example   |            |                                 |   |                             |                        |
| AM14 BCX42 DEX42 FM14   | 288        | M14<br>I14<br>I27               |   | X36 X42 X50                 | 18<br>31<br>18         |
|    |            |                                 |   |                             |                        |
| 264" - 288" X 60"/48"   | 264        |                                 |   | X27<br>X36                  | 30.5<br>26             |
| Example   | 288        |                                 |   | X27<br>X36<br>X42           | 34.5<br>30<br>27       |
|    |            |                                 |   |                             |                        |
| 264" - 288" X 60"/48"   | 264        |                                 |   | X27<br>X36<br>X42           | 30.5<br>26<br>23       |
| Example   | 288        |                                 |   | X27<br>X36<br>X42<br>X50    | 34.5<br>30<br>27<br>23 |
|    |            |                                 |   |                             |                        |
| 120" - 144" X 60"/42"   | 120        | I14                             | M14 M27                                   |                             | 23                     |
| Example   |            |                                 |   |                             |                        |
| AM14 BM42 CM14  | 144        | M14<br>I27                      | M14 M27 M36 M42<br>M14 M27 M36 M42        |                             | 18<br>18               |
|    |            |                                 |   |                             |                        |
| 120" - 144" X 60/42   | 120        |                                 |   | X27                         | 26.5                   |
| Example   |            |                                 |   |                             |                        |
| ABX42 BCX42   | 144        |                                 |   | X36<br>X42                  | 30<br>27               |
|    |            |                                 |   |                             |                        |
| 168" X 66/42"<br>192" X 69/42"  | 168        | I14                             | M14 M27 M36                               |                             | 25                     |
| Example   |            |                                 |   |                             |                        |
| AI14 BM42 CM42 DI14   | 192        | M14<br>I27                      | M14 M27 M36 M42<br>M14 M27 M36 M42        |                             | 18<br>18               |
|  |            |                                 |   |                             |                        |

## CODE KEY

M - Console location, middle of top section  
 I - Console location, Inset 3" from seam on end sections  
 X - Console location, across a seam of two top sections  
 L - Console location, left side of a one piece top  
 R - Console location, right side of a one piece top  
 Y - Dimension from end of table to end of Console

Caution: Y greater than 30" makes access to Console Power/Data difficult from the end of the table

## CONSOLE SIZE & LOCATIONS

See page 15 for information on console locations and size options for wood tops, and page 25 for laminate tops locations and sizes

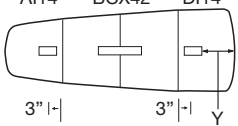
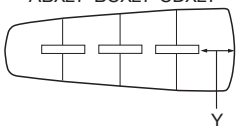
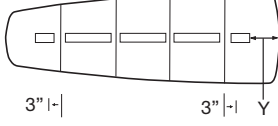
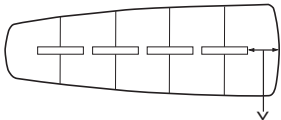
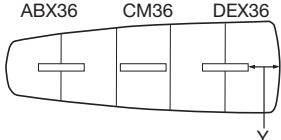
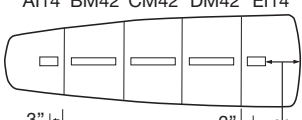
## CONSOLE MODULE OPTIONS

See page 49 for power / data options

## ORDERING NOTES

Tops may be specified with fewer consoles and configurations other than shown. Consoles can be different sizes within the same top. Dimension from end of cut-out to table end cannot be less than 18".

# NUVO | CONSOLE SIZE & LOCATION - VISIO

| Wood Top Console Options   | Top Length | Console Options Top End Section | Console Options Within Top Center Section             | Console Options Across Seam        | Y              |
|--|------------|---------------------------------|---|------------------------------------|----------------|
| 168" X 66/42"  | 168        | I14                             |   | X27 X36 X42 X50                    | 25             |
| 192" X 69/42"<br>AI14 BCX42 DI14   | 192        | M14<br>I27                      |   | X27 X36 X42 X50<br>X27 X36 X42 X50 | 18<br>18       |
|    |            |                                 |   |                                    |                |
| 168" X 66/42" 192" X 69/42"  | 168        |                                 |   | X27                                | 28.5           |
| Example<br>ABX27 BCX27 CDX27   | 192        |                                 |   | X27                                | 28.5           |
|    |            |                                 |   |                                    |                |
| 216" X 73"/42"   | 216        | I14                             | M14 M27 M36   |                                    | 26             |
| Example<br>AI14 BM36 CM36 DM36 EI14  |            |                                 |   |                                    |                |
|    |            |                                 |   |                                    |                |
| 216" X 73"/42"   | 216        |                                 |   | X27<br>X36                         | 25.5<br>25     |
| ABX36 BCX36 CDX36 DEX36  |            |                                 |   |                                    |                |
|  |            |                                 |   |                                    |                |
| 216" X 73"/42"   | 216        |                                 | M14 M27 M36<br>M14 M27 M36<br>M14 M27 M36             | X27<br>X36<br>X42                  | 30<br>25<br>22 |
| Example<br>ABX36 CM36 DEX36  |            |                                 |   |                                    |                |
|  |            |                                 |   |                                    |                |
| 240" X 76"/42"   | 240        | M14<br>I14<br>I27               | M14 M27 M36 M42<br>M14 M27 M36 M42<br>M14 M27 M36 M42 |                                    | 18<br>31<br>18 |
| Example<br>AI14 BM42 CM42 DM42 EI14  |            |                                 |   |                                    |                |
|  |            |                                 |   |                                    |                |

## CODE KEY

M - Console location, middle of top section  
 I - Console location, Inset 3" from seam on end sections  
 X - Console location, across a seam of two top sections  
 L - Console location, left side of a one piece top  
 R - Console location, right side of a one piece top  
 Y - Dimension from end of table to end of Console

Caution: Y greater than 30" makes access to Console Power/Data difficult from the end of the table

## CONSOLE SIZE & LOCATIONS

See page 15 for information on console locations and size options for wood tops, and page 25 for laminate tops locations and sizes

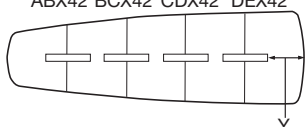
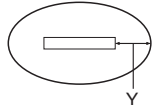
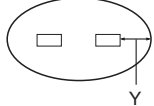
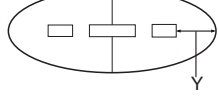
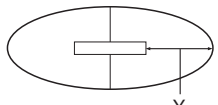
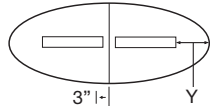
## CONSOLE MODULE OPTIONS

See page 49 for power / data options

## ORDERING NOTES

Tops may be specified with fewer consoles and configurations other than shown. Consoles can be different sizes within the same top. Dimension from end of cut-out to table end cannot be less than 18".

# NUVO | CONSOLE SIZE & LOCATION - VISIO & OVAL

| Wood Top Console Options  | Top Length | Console Options Top End Section | Console Options Within Top Center Section | Console Options Across Seam                   | Y  |
|---|------------|---------------------------------|---|---|--|
| 240" X 76"/42"<br>Example<br>ABX42 BCX42 CDX42 DEX42                                | 240        |                                 |   | X27<br>X36<br>X42                             | 34.5<br>30<br>27                         |
|    |            |                                 |   |   |  |
| 84" x 48"<br>Example<br>AM42  | 84         | M14<br>M27<br>M36<br>M42        |   |   | 35<br>28.5<br>24<br>21                   |
|    |            |                                 |   |   |  |
| 84" x 48"<br>Example<br>AL14 AR14   | 84         | L14/R14                         |   |   | 18                                       |
|    |            |                                 |   |   |  |
| 96" - 120" X 48"<br>96" X 54"<br>AM14 ABX27 BM14                                    | 96<br>120  | M14<br>M14                      |   | X27   | 18<br>23                                 |
|  |            |                                 |   |   |  |
| 96" - 120" X 48"<br>96" X 54"<br>Example<br>ABX42                                   | 96<br>120  |                                 |   | X27<br>X36<br>X42<br>X50<br>X36<br>X42<br>X50 | 34.5<br>30<br>27<br>23<br>42<br>39<br>35 |
|  |            |                                 |   |   |  |
| 96" - 120" X 48"<br>96" X 54"<br>AI36 BI36  | 96<br>120  | I27<br>I36                      |   |   | 18<br>30<br>21                           |
|  |            |                                 |   |   |  |

## CODE KEY

M - Console location, middle of top section  
 I - Console location, Inset 3" from seam on end sections  
 X - Console location, across a seam of two top sections  
 L - Console location, left side of a one piece top  
 R - Console location, right side of a one piece top  
 Y - Dimension from end of table to end of Console

Caution: Y greater than 30" makes access to Console Power/Data difficult from the end of the table

## CONSOLE SIZE & LOCATIONS

See page 15 for information on console locations and size options for wood tops, and page 25 for laminate tops locations and sizes

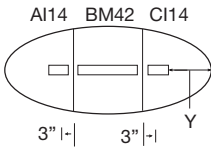
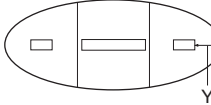
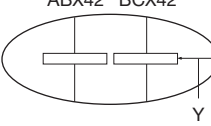
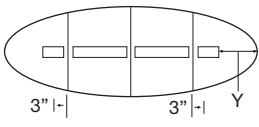
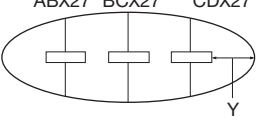
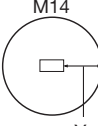
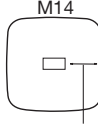
## CONSOLE MODULE OPTIONS

See page 49 for power / data options

## ORDERING NOTES

Tops may be specified with fewer consoles and configurations other than shown. Consoles can be different sizes within the same top. Dimension from end of cut-out to table end cannot be less than 18".

# NUVO | CONSOLE SIZE & LOCATION - OVAL, ROUND, ARCED SQUARE

| Wood Top Console Options   | Top Length | Console Options Top End Section | Console Options Within Top Center Section             | Console Options Across Seam | Y              |
|--|------------|---------------------------------|---|-----------------------------|----------------|
| 144" X 54"   | 144        | M14<br>I14<br>I27               | M14 M27 M36 M42<br>M14 M27 M36 M42<br>M14 M27 M36 M42 |                             | 18<br>31<br>18 |
| Example<br>AI14 BM42 CI14<br>        |            |                                 |   |                             |                |
| 120" - 144" X 60"  | 120        | I14                             | M14 M27   |                             | 23             |
| Example<br>AM14 BM42 CM14<br>        | 144        | M14<br>I14<br>I27               | M14 M27 M36 M42<br>M14 M27 M36 M42<br>M14 M27 M36 M42 |                             | 18<br>31<br>18 |
| 120" - 144" X 60"<br>144" X 54"  | 120        |                                 |   | X27                         | 26.5           |
| Example<br>ABX42 BCX42<br>           | 144        |                                 |   | X36<br>X42                  | 30<br>27       |
| 168" X 60"   | 168        | I14                             | M14 M27 M36   |                             | 25             |
| Example<br>AI14 BM36 CM36 DI14<br> |            |                                 |   |                             |                |
| 168" X 60"   | 168        |                                 |   | X27<br>X36                  | 28.5<br>24     |
| Example<br>ABX27 BCX27 CDX27<br>   |            |                                 |   |                             |                |
| 36" - 60"  | 36         | M14                             |   |                             | 11             |
| Examples<br>M14<br>                | 42         | M14                             |   |                             | 14             |
| M14<br>                           | 48         | M14                             |   |                             | 17             |
|  | 54         | M14                             |   |                             | 20             |
|  | 60         | M14                             |   |                             | 23             |

## CODE KEY

M - Console location, middle of top section  
 I - Console location, Inset 3" from seam on end sections  
 X - Console location, across a seam of two top sections  
 L - Console location, left side of a one piece top  
 R - Console location, right side of a one piece top  
 Y - Dimension from end of table to end of Console

Caution: Y greater than 30" makes access to Console Power/Data difficult from the end of the table

## CONSOLE SIZE & LOCATIONS

See page 15 for information on console locations and size options for wood tops, and page 25 for laminate tops locations and sizes

## CONSOLE MODULE OPTIONS

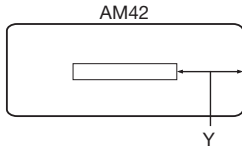
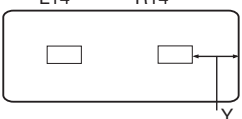
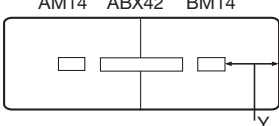
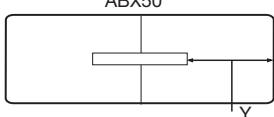
See page 49 for power / data options

## ORDERING NOTES

Tops may be specified with fewer consoles and configurations other than shown. Consoles can be different sizes within the same top. Dimension from end of cut-out to table end cannot be less than 18".



# NUVO | CONSOLE SIZE & LOCATION - RECTANGULAR, ARC END, RACETRACK

| Laminate Top Console Options  | Top Length | Console Options Top End Section | Console Options Within Top Center Section | Console Options Across Seam | Y    |  |
|---|------------|---------------------------------|---|-----------------------------|------|--|
| <b>WIDTHS 36" - 48"</b>   | 60         | M14                             |   |                             | 23   |  |
| 60" - 84" X 36", 42", 48"   | 72         | M14                             |   |                             | 29   |  |
| 96" X 36"   |            | M27                             |   |                             | 22.5 |  |
| Example   | 78         | M14                             |   |                             | 32   |  |
|    |            | M27                             |   |                             | 25.5 |  |
|   |            | M36                             |   |                             | 21   |  |
|   |            | M42                             |   |                             | 18   |  |
|   | 84         | M14                             |   |                             | 35   |  |
|   |            | M27                             |   |                             | 28.5 |  |
|   |            | M36                             |   |                             | 24   |  |
|   |            | M42                             |   |                             | 21   |  |
|   | 96         | M14                             |   |                             | 41   |  |
|   |            | M27                             |   |                             | 34.5 |  |
|   |            | M36                             |   |                             | 30   |  |
|   |            | M42                             |   |                             | 27   |  |
|   |            | M50                             |   |                             | 23   |  |
| <hr/>   |            |                                 |   |                             |      |  |
| 78" - 84" X 36", 42", 48"   | 78         | L14 / R14                       |   |                             | 18   |  |
| 96" X 36"   | 84         | L14 / R14                       |   |                             | 18   |  |
| Example   | 96         | L14 / R14                       |   |                             | 18   |  |
|   |            |                                 |   |                             |      |  |
|   |            |                                 |   |                             |      |  |
| <hr/>   |            |                                 |   |                             |      |  |
| 96" X 42", 48"  | 96         | M14                             |   |                             | 18   |  |
| Example   |            |                                 |   |                             |      |  |
|  |            |                                 |   |                             |      |  |
|   |            |                                 |   |                             |      |  |
|   |            |                                 |   |                             |      |  |
|   |            |                                 |   |                             |      |  |
| <hr/>   |            |                                 |   |                             |      |  |
| 96" X 42", 48"  | 96         |                                 |   |                             |      |  |
| Example   |            |                                 |   |                             |      |  |
|  |            |                                 |   |                             |      |  |
|   |            |                                 |   |                             |      |  |
|   |            |                                 |   |                             |      |  |
|   |            |                                 |   |                             |      |  |

## CODE KEY

M - Console location, middle of top section  
 I - Console location, Inset 3" from seam on end sections  
 X - Console location, across a seam of two top sections  
 L - Console location, left side of a one piece top  
 R - Console location, right side of a one piece top  
 Y - Dimension from end of table to end of Console

Caution: Y greater than 30" makes access to Console Power/Data difficult from the end of the table

## CONSOLE SIZE & LOCATIONS

See page 15 for information on console locations and size options for wood tops, and page 25 for laminate tops locations and sizes

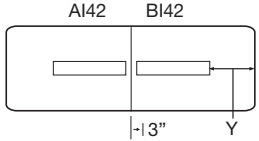
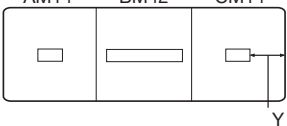
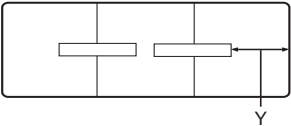
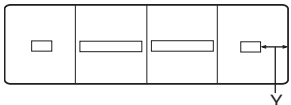
## CONSOLE MODULE OPTIONS

See page 49 for power / data options

## ORDERING NOTES

Tops may be specified with fewer consoles and configurations other than shown. Consoles can be different sizes within the same top. Dimension from end of cut-out to table end cannot be less than 18".

# NUVO | CONSOLE SIZE & LOCATION - RECTANGULAR, ARC END, RACETRACK

| Laminate Top Console Options   | Top Length | Console Options Top End Section | Console Options Within Top Center Section             | Console Options Across Seam | Y              |
|--|------------|---------------------------------|---|-----------------------------|----------------|
| <b>WIDTHS 42" - 60"</b>  | 96         | I27                             |   |                             | 18             |
| 96" X 42", 48"   |            |                                 |   |                             |                |
| Example  |            |                                 |   |                             |                |
|   |            |                                 |   |                             |                |
| <b>108"-144" X 42", 48", 54", 60"</b>  | 108        | I14                             | M14 M27   | 19                          |                |
| Example  | 120        | M14<br>I14                      | M14 M27<br>M14 M27                                    |                             | 23             |
|    | 144        | M14<br>I14<br>I27               | M14 M27 M36 M42<br>M14 M27 M36 M42<br>M14 M27 M36 M42 |                             | 18<br>31<br>18 |
| <b>108"-144" X 42", 48", 54", 60"</b>  | 108        |                                 |   | X27                         | 22.5           |
| Example  | 120        |                                 |   | X27                         | 26.5           |
|  | 144        |                                 |   | X36<br>X42                  | 30<br>27       |
| <b>156"-192" X 48", 54", 60"</b>   | 156        | I14                             | M14 M27   |                             | 22             |
| Example  | 168        | I14                             | M14 M27 M36   |                             | 25             |
|  | 192        | M14<br>I14<br>I27               | M14 M27 M36 M42<br>M14 M27 M36 M42<br>M14 M27 M36 M42 |                             | 18<br>31<br>18 |

## CODE KEY

M - Console location, middle of top section  
 I - Console location, Inset 3" from seam on end sections  
 X - Console location, across a seam of two top sections  
 L - Console location, left side of a one piece top  
 R - Console location, right side of a one piece top  
 Y - Dimension from end of table to end of Console

Caution: Y greater than 30" makes access to Console Power/Data difficult from the end of the table

## CONSOLE SIZE & LOCATIONS

See page 15 for information on console locations and size options for wood tops, and page 25 for laminate tops locations and sizes

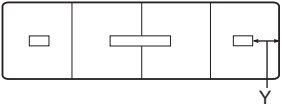
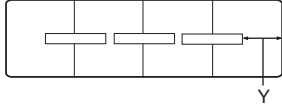
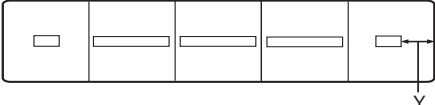
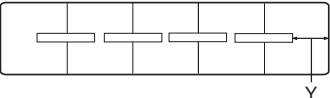
## CONSOLE MODULE OPTIONS

See page 49 for power / data options

## ORDERING NOTES

Tops may be specified with fewer consoles and configurations other than shown. Consoles can be different sizes within the same top. Dimension from end of cut-out to table end cannot be less than 18".

# NUVO | CONSOLE SIZE & LOCATION - RECTANGULAR, ARC END, RACETRACK

| Laminate Top Console Options  | Top Length | Console Options Top End Section | Console Options Within Top Center Section             | Console Options Across Seam   | Y                |
|---|------------|---------------------------------|---|-------------------------------|------------------|
| <b>WIDTHS 54" OR GREATER</b>  |            |                                 |   |                               |                  |
| 156" - 192" X 48" 54", 60"  | 156        | I14                             |   | X27 X36 X42                   | 22               |
| Example   |            |                                 |   |                               |                  |
| AM14 BCX42 DM14   | 168        | I14                             |   | X27 X36                       | 25               |
|    | 192        | M14<br>I14<br>I27               |   | X36 X42<br>X36 X42<br>X36 X42 | 18<br>31<br>18   |
| 156" - 192" x 48" 54", 60"  | 156        |                                 |   | X27<br>X36                    | 25.5<br>21       |
| Example   |            |                                 |   |                               |                  |
| ABX42 BCX42 CDX42   | 168        |                                 |   | X27<br>X36                    | 28.5<br>24       |
|    | 192        |                                 |   | X27<br>X36<br>X42             | 34.5<br>30<br>27 |
| 216" - 240" X 54", 60"  | 216        | I14                             | M14 M27 M36   |                               | 26               |
|   | 240        | M14<br>14<br>I27                | M14 M27 M36 M42<br>M14 M27 M36 M42<br>M14 M27 M36 M42 |                               | 18<br>31<br>18   |
| Example   |            |                                 |   |                               |                  |
| AM14 BM42 CM42 DM42 EM14  |            |                                 |   |                               |                  |
|  |            |                                 |   |                               |                  |
| 216" - 240" X 54", 60"  | 216        |                                 |   | X27<br>X36                    | 29.5<br>25       |
| Example   |            |                                 |   |                               |                  |
| ABX42 BCX42 CDX42 DEX42   | 240        |                                 |   | X27<br>X36<br>X42             | 34.5<br>30<br>27 |
|  |            |                                 |   |                               |                  |

## CODE KEY

M - Console location, middle of top section  
 I - Console location, Inset 3" from seam on end sections  
 X - Console location, across a seam of two top sections  
 L - Console location, left side of a one piece top  
 R - Console location, right side of a one piece top  
 Y- Dimension from end of table to end of Console

Caution: Y greater than 30" makes access to Console Power/Data difficult from the end of the table

## CONSOLE SIZE & LOCATIONS

See page 15 for information on console locations and size options for wood tops, and page 25 for laminate tops locations and sizes

## CONSOLE MODULE OPTIONS

See page 49 for power / data options

## ORDERING NOTES

Tops may be specified with fewer consoles and configurations other than shown. Consoles can be different sizes within the same top. Dimension from end of cut-out to table end cannot be less than 18".

# NUVO | CONSOLE SIZE & LOCATION - RECTANGULAR, ARC END, RACETRACK

| Laminate Top Console Options  | Top Length | Console Options Top End Section | Console Options Within Top Center Section | Console Options Across Seam | Y    |
|-------------------------------|------------|---------------------------------|---|-----------------------------|------|
| <b>WIDTHS 54" OR GREATER</b>  | 216        |                                 | M14 M27 M36                               | X27                         | 29.5 |
| 216" - 240" X 54", 60"        |            |                                 | M14 M27 M36                               | X36                         | 25   |
|                               |            |                                 | M14 M27 M36                               | X42                         | 22   |
| Example                       | 240        |                                 | M14 M27 M36 M42                           | X27                         | 34.5 |
| ABX42 CM42 DEX42              |            |                                 | M14 M27 M36 M42                           | X36                         | 30   |
|                               |            |                                 | M14 M27 M36 M42                           | X42                         | 27   |
|                               |            |                                 | M14 M27 M36 M42                           | X50                         | 23   |
| <b>264" - 288" X 60"</b>      | 264        | M14                             |   |                             | 18   |
|                               |            | I14                             | M14 M27 M36                               |                             | 27   |
| Example                       |            |                                 |   |                             |      |
| AM14 BM42 CM42 DM42 EM42 FM14 | 288        | M14                             | M14 M27 M36 M42                           |                             | 18   |
|                               |            | I14                             | M14 M27 M36 M42                           |                             | 31   |
|                               |            | I27                             | M14 M27 M36 M42                           |                             | 18   |
| <b>264" - 288" X 60"</b>      | 264        | M14                             |   |                             | 18   |
|                               |            | I14                             |   | X36 X42 X50                 | 27   |
| Example                       |            |                                 |   |                             |      |
| AM14 BCX42 DEX42 FM14         | 288        | M14                             |   | X36 X42 X50                 | 18   |
|                               |            | I14                             |   | X36 X42 X50                 | 31   |
|                               |            | I27                             |   | X36 X42 X50                 | 18   |
| <b>264" - 288" X 60"</b>      | 264        |                                 |   | X27                         | 30.5 |
|                               |            |                                 |   | X36                         | 26   |
| Example                       |            |                                 |   |                             |      |
| ABX42 BCX42 CDX42 DEX42 EFX42 | 288        |                                 |   | X27                         | 34.5 |
|                               |            |                                 |   | X36                         | 30   |
|                               |            |                                 |   | X42                         | 27   |
| <b>264" - 288" X 60"</b>      | 264        |                                 |   | X27                         | 30.5 |
|                               |            |                                 |   | X36                         | 26   |
| Example                       |            |                                 |   | X42                         | 23   |
| ABX42 CDX42 EFX42             | 288        |                                 |   | X27                         | 34.5 |
|                               |            |                                 |   | X36                         | 30   |
|                               |            |                                 |   | X42                         | 27   |
|                               |            |                                 |   | X50                         | 23   |

## CODE KEY

- M - Console location, middle of top section
- I - Console location, Inset 3" from seam on end sections
- X - Console location, across a seam of two top sections
- L - Console location, left side of a one piece top
- R - Console location, right side of a one piece top
- Y - Dimension from end of table to end of Console

Caution: Y greater than 30" makes access to Console Power/Data difficult from the end of the table

## CONSOLE SIZE & LOCATIONS

See page 15 for information on console locations and size options for wood tops, and page 29 for laminate tops locations and sizes

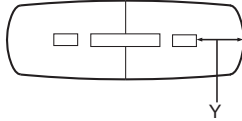
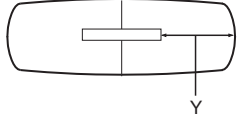
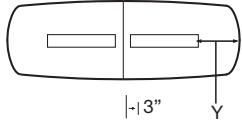
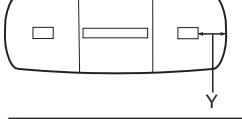
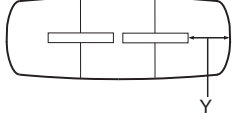
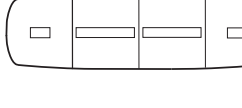
## CONSOLE MODULE OPTIONS

See page 49 for power / data options

## ORDERING NOTES

Tops may be specified with fewer consoles and configurations other than shown. Consoles can be different sizes within the same top. Dimension from end of cut-out to table end cannot be less than 18".

# NUVO | CONSOLE SIZE & LOCATION - BOAT SHAPED

| Laminate Top Console Options   | Top Length | Console Options Top End Section | Console Options Within Top Center Section             | Console Options Across Seam | Y                      |
|--|------------|---------------------------------|---|-----------------------------|------------------------|
| 96" - 144" X 48"/42"<br>96" X 54"/42"  | 96         | M14                             |   |                             | 18                     |
| Example<br>AM14 ABX42 BM14   |            |                                 |   |                             |                        |
|   |            |                                 |   |                             |                        |
| 96" - 144" X 48"/42"<br>96" X 54"/42"  | 96         |                                 |   | X27<br>X36<br>X42<br>X50    | 34.5<br>30<br>27<br>23 |
| Example<br>ABX50   |            |                                 |   |                             |                        |
|   |            |                                 |   |                             |                        |
| 96" - 144" X 48"/42"<br>96" X 54"/42"  | 96         | I27                             |   |                             | 18                     |
| Example<br>AI42 BI42   |            |                                 |   |                             |                        |
|  |            |                                 |   |                             |                        |
| 120" - 144" x 54"/42"  | 120        | I14                             | M14 M27   |                             | 23                     |
| Example<br>AM14 BM42 CM14  | 144        | M14<br>I14<br>I27               | M14 M27 M36 M42<br>M14 M27 M36 M42<br>M14 M27 M36 M42 |                             | 18<br>31<br>18         |
|   |            |                                 |   |                             |                        |
| 120" - 144" x 54"/42"  | 120        |                                 |   | X27<br>X36<br>X42           | 26.5<br>30<br>27       |
| Example<br>ABX42 BCX42   | 144        |                                 |   |                             |                        |
|   |            |                                 |   |                             |                        |
| 168" - 192" X 54"/42"  | 168        | I14                             | M14 M27 M36   |                             | 25                     |
| Example<br>AM14 BM42 CM42 DM14   | 192        | M14<br>I14<br>I27               | M14 M27 M36 M42<br>M14 M27 M36 M42<br>M14 M27 M36 M42 |                             | 18<br>31<br>18         |
|   |            |                                 |   |                             |                        |

**CODE KEY**

- M - Console location, middle of top section
- I - Console location, Inset 3" from seam on end sections
- X - Console location, across a seam of two top sections
- L - Console location, left side of a one piece top
- R - Console location, right side of a one piece top
- Y- Dimension from end of table to end of Console

Caution: Y greater than 30" makes access to Console Power/Data difficult from the end of the table

**CONSOLE SIZE & LOCATIONS**

See page 15 for information on console locations and size options for wood tops, and page 25 for laminate tops locations and sizes

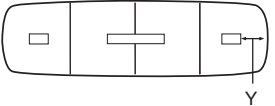
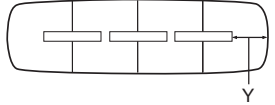
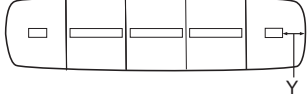
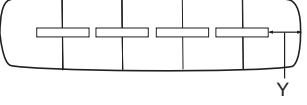
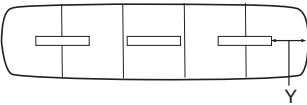
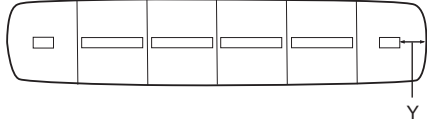
**CONSOLE MODULE OPTIONS**

See page 49 for power / data options

**ORDERING NOTES**

Tops may be specified with fewer consoles and configurations other than shown. Consoles can be different sizes within the same top. Dimension from end of cut-out to table end cannot be less than 18".

# NUVO | CONSOLE SIZE & LOCATION - BOAT SHAPED

| Laminate Top Console Options   | Top Length | Console Options Top End Section |     | Console Options Within Top Center Section |     |     |  | Console Options Across Seam |     |     | Y    |
|--|------------|---------------------------------|-----|---|-----|-----|--|-----------------------------|-----|-----|------|
|  |            |                                 |     |   |     |     |  |                             |     |     |      |
| 168" - 192" X 54"/42"  | 168        | I14                             |     |   |     |     |  | X27                         | X36 | X42 | 25   |
| Example  | 192        | M14                             |     |   |     |     |  | X36                         | X42 |     | 18   |
| AM14 BCX42 DM14  |            | I14                             |     |   |     |     |  | X36                         | X42 |     | 31   |
|    |            | I27                             |     |   |     |     |  | X36                         | X42 |     | 18   |
| 168" - 192" X 54"/42"  | 168        |                                 |     |   |     |     |  | X27                         |     |     | 28.5 |
| Example  | 192        |                                 |     |   |     |     |  | X36                         |     |     | 24   |
| ABX42 BCX42 CDX42  |            |                                 |     |   |     |     |  | X27                         |     |     | 34.5 |
|    |            |                                 |     |   |     |     |  | X36                         |     |     | 30   |
|  |            |                                 |     |   |     |     |  | X42                         |     |     | 27   |
| 216" - 240" X 60"/48"  | 216        | I14                             | M14 | M27                                       | M36 |     |  |                             |     |     | 26   |
| Example  | 240        | M14                             | M14 | M27                                       | M36 | M42 |  |                             |     |     | 18   |
| AM14 BM42 CM42 DM42 EM14   |            | I14                             | M14 | M27                                       | M36 | M42 |  |                             |     |     | 31   |
|    |            | I27                             | M14 | M27                                       | M36 | M42 |  |                             |     |     | 18   |
| 216" - 240" X 60"/48"  | 216        |                                 |     |   |     |     |  | X27                         |     |     | 29.5 |
| Example  | 240        |                                 |     |   |     |     |  | X36                         |     |     | 24   |
| ABX42 BCX42 CDX42 DEX42  |            |                                 |     |   |     |     |  | X27                         |     |     | 34.5 |
|  |            |                                 |     |   |     |     |  | X36                         |     |     | 30   |
|  |            |                                 |     |   |     |     |  | X42                         |     |     | 27   |
| 216" - 240" X 60"/48"  | 216        |                                 | M14 | M27                                       | M36 |     |  | X27                         |     |     | 29.5 |
| Example  | 240        |                                 | M14 | M27                                       | M36 |     |  | X36                         |     |     | 25   |
| ABX42 CM42 DEX42   |            |                                 | M14 | M27                                       | M36 |     |  | X42                         |     |     | 22   |
|  |            |                                 | M14 | M27                                       | M36 | M42 |  | X27                         |     |     | 34.5 |
|  |            |                                 | M14 | M27                                       | M36 | M42 |  | X36                         |     |     | 30   |
|  |            |                                 | M14 | M27                                       | M36 | M42 |  | X42                         |     |     | 27   |
|  |            |                                 | M14 | M27                                       | M36 | M42 |  | X50                         |     |     | 23   |
| 264" - 288" X 60"/48"  | 264        | M14                             |     |   |     |     |  |                             |     |     | 18   |
| Example  | 288        | I14                             | M14 | M36                                       |     |     |  |                             |     |     | 27   |
| AM14 BM42 CM42 DM42 EM42 FM14  |            | M14                             | M14 | M36                                       | M42 |     |  |                             |     |     | 18   |
|  |            | I14                             | M14 | M36                                       | M42 |     |  |                             |     |     | 31   |
|  |            | I27                             | M14 | M36                                       | M42 |     |  |                             |     |     | 18   |

## CODE KEY

- M - Console location, middle of top section
- I - Console location, Inset 3" from seam on end sections
- X - Console location, across a seam of two top sections
- L - Console location, left side of a one piece top
- R - Console location, right side of a one piece top
- Y - Dimension from end of table to end of Console

Caution: Y greater than 30" makes access to Console Power/Data difficult from the end of the table

## CONSOLE SIZE & LOCATIONS

See page 15 for information on console locations and size options for wood tops, and page 25 for laminate tops locations and sizes

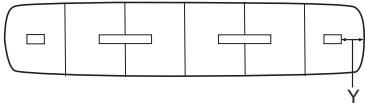
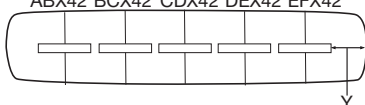
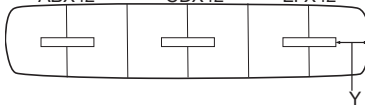
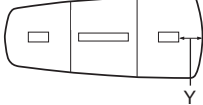
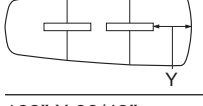
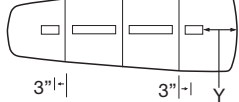
## CONSOLE MODULE OPTIONS

See page 49 for power / data options

## ORDERING NOTES

Tops may be specified with fewer consoles and configurations other than shown. Consoles can be different sizes within the same top. Dimension from end of cut-out to table end cannot be less than 18".

# NUVO | CONSOLE SIZE & LOCATION - BOAT SHAPED & VISIO

| Laminate Top Console Options   | Top Length | Console Options Top End Section | Console Options Within Top Center Section | Console Options Across Seam | Y                      |
|--|------------|---------------------------------|---|-----------------------------|------------------------|
| 264" - 288" X 60"/48"  | 264        | M14<br>I14                      |   | X36 X42 X50                 | 18<br>27               |
| Example  |            |                                 |   |                             |                        |
| AM14 BCX42 DEX42 FM14  | 288        | M14<br>I14<br>I27               |   | X36 X42 X50<br>X36 X42 X50  | 18<br>31<br>18         |
|   |            |                                 |   |                             |                        |
| 264" - 288" X 60"/48"  | 264        |                                 |   | X27<br>X36                  | 30.5<br>26             |
| Example  | 288        |                                 |   | X27<br>X36<br>X42           | 34.5<br>30<br>27       |
|   |            |                                 |   |                             |                        |
| 264" - 288" X 60"/48"  | 264        |                                 |   | X27<br>X36<br>X42           | 30.5<br>26<br>23       |
| Example  | 288        |                                 |   | X27<br>X36<br>X42<br>X50    | 34.5<br>30<br>27<br>23 |
|   |            |                                 |   |                             |                        |
| 120" - 144" X 60"/42"  | 120        | I14                             | M14 M27                                   |                             | 23                     |
| Example  | 144        | M14<br>I27                      | M14 M27 M36 M42<br>M14 M27 M36 M42        |                             | 18<br>18               |
|   |            |                                 |   |                             |                        |
| 120" - 144" X 60/42  | 120        |                                 |   | X27                         | 26.5                   |
| Example  | 144        |                                 |   | X36<br>X42                  | 30<br>27               |
|   |            |                                 |   |                             |                        |
| 168" X 66/42"<br>192" X 69/42"   | 168        | I14                             | M14 M27 M36                               |                             | 25                     |
| Example  | 192        | M14<br>I27                      | M14 M27 M36 M42<br>M14 M27 M36 M42        |                             | 18<br>18               |
|  |            |                                 |   |                             |                        |

## CODE KEY

M - Console location, middle of top section  
 I - Console location, Inset 3" from seam on end sections  
 X - Console location, across a seam of two top sections  
 L - Console location, left side of a one piece top  
 R - Console location, right side of a one piece top  
 Y - Dimension from end of table to end of Console

Caution: Y greater than 30" makes access to Console Power/Data difficult from the end of the table

## CONSOLE SIZE & LOCATIONS

See page 15 for information on console locations and size options for wood tops, and page 25 for laminate tops locations and sizes

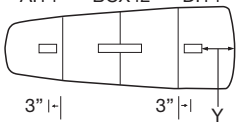
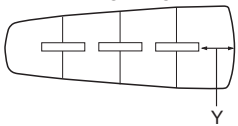
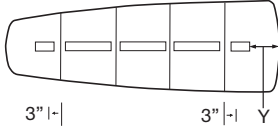
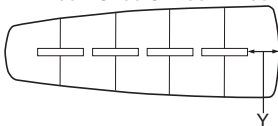
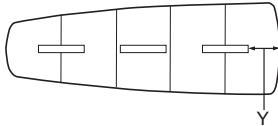
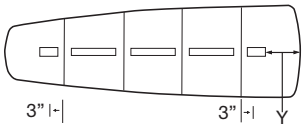
## CONSOLE MODULE OPTIONS

See page 49 for power / data options

## ORDERING NOTES

Tops may be specified with fewer consoles and configurations other than shown. Consoles can be different sizes within the same top. Dimension from end of cut-out to table end cannot be less than 18".

# NUVO | CONSOLE SIZE & LOCATION - VISIO

| Laminate Top Console Options   | Top Length | Console Options Top End Section | Console Options Within Top Center Section             | Console Options Across Seam | Y              |
|--|------------|---------------------------------|---|-----------------------------|----------------|
| 168" X 66/42"  | 168        | I14                             |   | X27 X36 X42 X50             | 25             |
| 192" X 69/42"  | 192        | M14<br>I27                      |   | X27 X36 X42 X50             | 18<br>18       |
|    |            |                                 |   |                             |                |
| 168" X 66/42" 192" X 69/42"  | 168        |                                 |   | X27                         | 28.5           |
| Example<br>ABX27 BCX27 CDX27   | 192        |                                 |   | X27                         | 28.5           |
|    |            |                                 |   |                             |                |
| 216" X 73"/42"   | 216        | I14                             | M14 M27 M36   |                             | 26             |
| Example<br>AI14 BM36 CM36 DM36 EI14  |            |                                 |   |                             |                |
|    |            |                                 |   |                             |                |
| 216" X 73"/42"   | 216        |                                 |   | X27<br>X36                  | 25.5<br>25     |
|  |            |                                 |   |                             |                |
| 216" X 73"/42"   | 216        |                                 | M14 M27 M36<br>M14 M27 M36<br>M14 M27 M36             | X27<br>X36<br>X42           | 30<br>25<br>22 |
| Example<br>ABX36 CM36 DEX36  |            |                                 |   |                             |                |
|  |            |                                 |   |                             |                |
| 240" X 76"/42"   | 240        | M14<br>I14<br>I27               | M14 M27 M36 M42<br>M14 M27 M36 M42<br>M14 M27 M36 M42 |                             | 18<br>31<br>18 |
| Example<br>AI14 BM42 CM42 DM42 EI14  |            |                                 |   |                             |                |
|  |            |                                 |   |                             |                |

## CODE KEY

- M - Console location, middle of top section
- I - Console location, Inset 3" from seam on end sections
- X - Console location, across a seam of two top sections
- L - Console location, left side of a one piece top
- R - Console location, right side of a one piece top
- Y - Dimension from end of table to end of Console

Caution: Y greater than 30" makes access to Console Power/Data difficult from the end of the table

## CONSOLE SIZE & LOCATIONS

See page 15 for information on console locations and size options for wood tops, and page 25 for laminate tops locations and sizes

## CONSOLE MODULE OPTIONS

See page 49 for power / data options

## ORDERING NOTES

Tops may be specified with fewer consoles and configurations other than shown. Consoles can be different sizes within the same top. Dimension from end of cut-out to table end cannot be less than 18".



# NUVO | CONSOLE SIZE & LOCATION - VISIO & OVAL

| Laminate Top Console Options       | Top Length | Console Options Top End Section | Console Options Within Top Center Section | Console Options Across Seam | Y                      |
|------------------------------------|------------|---------------------------------|---|-----------------------------|------------------------|
| 240" X 76"/42"                     | 240        |                                 |   | X27<br>X36<br>X42           | 34.5<br>30<br>27       |
| Example<br>ABX42 BCX42 CDX42 DEX42 |            |                                 |   |                             |                        |
| 84" x 48"                          | 84         | M14<br>M27<br>M36<br>M42        |   |                             | 35<br>28.5<br>24<br>21 |
| Example<br>AM42                    |            |                                 |   |                             |                        |
| 84" x 48"                          | 84         | L14/R14                         |   |                             | 18                     |
| Example<br>AL14 AR14               |            |                                 |   |                             |                        |
| 96" - 120" X 48"<br>96" X 54"      | 96         | M14                             |   |                             | 18                     |
| AM14 ABX27 BM14                    | 120        | M14                             |   | X27                         | 23                     |
|                                    |            |                                 |   |                             |                        |
| 96" - 120" X 48"<br>96" X 54"      | 96         |                                 |   | X27<br>X36<br>X42<br>X50    | 34.5<br>30<br>27<br>23 |
| Example<br>ABX42                   | 120        |                                 |   | X36<br>X42<br>X50           | 42<br>39<br>35         |
|                                    |            |                                 |   |                             |                        |
| 96" - 120" X 48"<br>96" X 54"      | 96         | I27                             |   |                             | 18                     |
| AI36 BI36                          | 120        | I27<br>I36                      |   |                             | 30<br>21               |
|                                    |            |                                 |   |                             |                        |

## CODE KEY

M - Console location, middle of top section  
 I - Console location, Inset 3" from seam on end sections  
 X - Console location, across a seam of two top sections  
 L - Console location, left side of a one piece top  
 R - Console location, right side of a one piece top  
 Y- Dimension from end of table to end of Console

Caution: Y greater than 30" makes access to Console Power/Data difficult from the end of the table

## CONSOLE SIZE & LOCATIONS

See page 15 for information on console locations and size options for wood tops, and page 25 for laminate tops locations and sizes

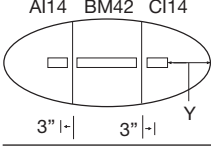
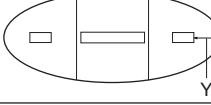
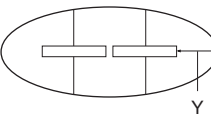
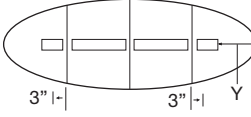
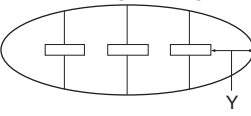
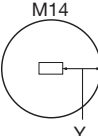
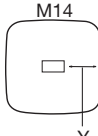
## CONSOLE MODULE OPTIONS

See page 49 for power / data options

## ORDERING NOTES

Tops may be specified with fewer consoles and configurations other than shown. Consoles can be different sizes within the same top. Dimension from end of cut-out to table end cannot be less than 18".

# NUVO | CONSOLE SIZE & LOCATION - OVAL, ROUND, ARCED SQUARE

| Laminate Top Console Options   | Top Length | Console Options Top End Section | Console Options Within Top Center Section             | Console Options Across Seam | Y              |
|--|------------|---------------------------------|---|-----------------------------|----------------|
| 144" X 54"   | 144        | M14<br>I14<br>I27               | M14 M27 M36 M42<br>M14 M27 M36 M42<br>M14 M27 M36 M42 |                             | 18<br>31<br>18 |
| Example<br>AI14 BM42 CI14<br>        |            |                                 |   |                             |                |
| 120" - 144" X 60"  | 120        | I14                             | M14 M27   |                             | 23             |
| Example<br>AM14 BM42 CM14<br>        | 144        | M14<br>I14<br>I27               | M14 M27 M36 M42<br>M14 M27 M36 M42<br>M14 M27 M36 M42 |                             | 18<br>31<br>18 |
| 120" - 144" X 60"<br>144" X 54"  | 120        |                                 |   | X27                         | 26.5           |
| Example<br>ABX42 BCX42<br>           | 144        |                                 |   | X36<br>X42                  | 30<br>27       |
| 168" X 60"   | 168        | I14                             | M14 M27 M36   |                             | 25             |
| Example<br>AI14 BM36 CM36 DI14<br> |            |                                 |   |                             |                |
| 168" X 60"   | 168        |                                 |   | X27<br>X36                  | 28.5<br>24     |
| Example<br>ABX27 BCX27 CDX27<br>   |            |                                 |   |                             |                |
| 36" - 60"  | 36         | M14                             |   |                             | 11             |
| Examples<br>                       | 42         | M14                             |   |                             | 14             |
|                                   | 48         | M14                             |   |                             | 17             |
|  | 54         | M14                             |   |                             | 20             |
|  | 60         | M14                             |   |                             | 23             |

## CODE KEY

M - Console location, middle of top section  
 I - Console location, Inset 3" from seam on end sections  
 X - Console location, across a seam of two top sections  
 L - Console location, left side of a one piece top  
 R - Console location, right side of a one piece top  
 Y - Dimension from end of table to end of Console

Caution: Y greater than 30" makes access to Console Power/Data difficult from the end of the table

## CONSOLE SIZE & LOCATIONS

See page 15 for information on console locations and size options for wood tops, and page 25 for laminate tops locations and sizes

## CONSOLE MODULE OPTIONS

See page 49 for power / data options


## ORDERING NOTES

Tops may be specified with fewer consoles and configurations other than shown. Consoles can be different sizes within the same top. Dimension from end of cut-out to table end cannot be less than 18".

# NUVO | CONSOLES FOR WOOD & LAMINATE TOPS

## CONSOLE - WITHIN A TOP SECTION


Consoles located within a top section are factory installed. The model numbers are determined by the location within each section and the size. For example, when ordering a rectangular top 96" x 54" a console M14 can be specified in both the A and/or B section of the table. When ordering, simply add AM14 and BM14 to your purchase order and add the list price for each console to your order.

| Description   | Model             | Console size | Price | Weights | Cubes |
|---|-------------------|--------------|-------|---------|-------|
|  | M14, I14, L14,R14 | 14           | 265   | 3       | .25   |
|   | M27, I27          | 27           | 295   | 4       | .25   |
|   | M36, I36          | 36           | 333   | 5       | .25   |
|   | M42, I42          | 42           | 363   | 5.5     | 0.5   |
|   | M50, I50          | 50           | 402   | 6       | 0.5   |

Consoles are available in 5 standard lengths.

## CONSOLE - ACROSS SEAMS

Consoles located across the seam are field installed and have separate model numbers that need to be included on your purchase order along with the desired console position. For example, when ordering a rectangular top 120" x 54" with a console across the seam, purchase orders need to specify the model number for the console (51CONSOLEX27) and the location ABX27.

| Description   | Model         | Console size | Price | Weights | Cubes |
|---|---------------|--------------|-------|---------|-------|
|  | 51CONSOLE-X14 | 14           | 265   | 3       | 0.25  |
|   | 51CONSOLE-X27 | 27           | 295   | 4       | 0.25  |
|   | 51CONSOLE-X36 | 36           | 333   | 5       | 0.25  |
|   | 51CONSOLE-X42 | 42           | 363   | 5.5     | 0.5   |
|   | 51CONSOLE-X50 | 50           | 402   | 6       | 0.5   |

Consoles are available in 5 standard lengths.

Note: 50" Consoles have 3 lid supports, while all other sized have 2.

## CONSOLE POWER/DATA MODULES

Console modules provide an extensive range of power, data and audio-visual solutions for today's conferencing environments. Console modules are available in 18 preconfigured data and power options, or alternatively console modules with just electrical ports can be selected allowing units to be designed and built specifically to meet your connectivity needs by using the Snap-in or Plate mounted port options.

Consoles are available with 3 power options in both preconfigured & custom console modules.

Power Module A (PMA) consists of 2 duplex receptacles with 3 cord lengths 6', 16' & 25'.

Power Module B (PMB) consists of 1 duplex receptacle with 3 cord lengths 6', 16' & 25'.

Power Module C (PMC) consists of 2 duplex receptacles with a utility outlet & circuit breaker with 2 cord lengths 6' & 16'.

The utility outlet in Module C allows another power module within the table to be plugged into it resulting in 1 cord going to the power source for both modules, as well as circuit protection for both modules. This also means shorter cord lengths can be specified resulting in a more cost effective power solution. Krug recommends the use of Module C's on the Console at the end of the table or location in the table nearest the power source.

### Examples:

120" table with 2 consoles & the power source at right end.

Use a PMC06 in the 1st console from the right & the cord goes to power source.

Use a PMA06 in the 2nd console from the right & the cord goes to the utility outlet of the first console module.

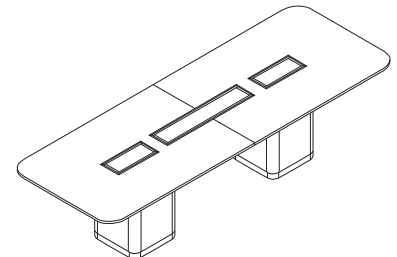
168" table with 4 consoles & power source at right hand end.

Use a PMC06 in the 1st console from the right & the cord goes to power source.

Use a PMC06 in the 2nd console from the right & the cord goes to power source.

Use a PMA06 in the 3rd console from the right & the cord goes to utility the outlet in the 1st console module.

Use a PMA06 in the 4th console from the right & the cord goes to utility the outlet in the 2nd console module.



### CODE KEY

M - Console location, middle of top section

I - Console location, Inset 3" from seam on end sections

X - Console location, across a seam of two top sections

L - Console location, left side of a one piece top

R - Console location, right side of a one piece top

Y - Dimension from end of table to end of Console

Caution: Y greater than 30" makes access to Console Power/Data difficult from the end of the table

### CONSOLE SIZE & LOCATIONS

See page 15 for information on console locations and size options for wood tops, and page 25 for laminate tops locations and sizes


### CONSOLE MODULE OPTIONS

See page 49 for power / data options

### ORDERING NOTES

Tops may be specified with fewer consoles and configurations other than shown. Consoles can be different sizes within the same top. Dimension from end of cut-out to table end cannot be less than 18".

# NUVO | BACK-PAINTED GLASS RECTANGULAR CONFERENCE TOPS

| Description  | Model      | Glass | L  | W  | Table Sections | Approximate Seating | Shipping Weight | Cubic Feet |
|--|------------|-------|----|----|----------------|---------------------|-----------------|------------|
| Rectangular- Rounded Corners   | 5161GP6036 | 5667  | 60 | 36 | 1              | 4                   | 190             | 42         |
|  | 5161GP6042 | 6612  | 60 | 42 | 1              | 4                   | 220             | 49         |
|  | 5161GP6048 | 7556  | 60 | 48 | 1              | 4                   | 250             | 53         |
|  | 5161GP7236 | 6802  | 72 | 36 | 1              | 6                   | 226             | 50         |
|  | 5161GP7242 | 7935  | 72 | 42 | 1              | 6                   | 262             | 58         |
|  | 5161GP7248 | 9067  | 72 | 48 | 1              | 6                   | 296             | 66         |
|  | 5161GP7836 | 7369  | 78 | 36 | 1              | 6                   | 244             | 55         |
|  | 5161GP7842 | 8596  | 78 | 42 | 1              | 6                   | 284             | 63         |
|  | 5161GP7848 | 9817  | 78 | 48 | 1              | 6                   | 322             | 72         |
|  | 5161GP8436 | 7935  | 84 | 36 | 1              | 6                   | 262             | 59         |
|  | 5161GP8442 | 9258  | 84 | 42 | 1              | 6                   | 304             | 68         |
|  | 5161GP8448 | 10571 | 84 | 48 | 1              | 6                   | 346             | 77         |
|  | 5161GP9636 | 9067  | 96 | 36 | 1              | 8                   | 300             | 67         |
|  | 5161GP9642 | 10578 | 96 | 42 | 2              | 8                   | 350             | 39         |
|  | 5161GP9648 | 12018 | 96 | 48 | 2              | 8                   | 396             | 45         |
| 5161GP10842  | 11949      | 108   | 42 | 2  | 8              | 390                 | 44              |            |
| 5161GP10848  | 13641      | 108   | 48 | 2  | 8              | 444                 | 50              |            |
| 5161GP12042  | 14119      | 120   | 42 | 2  | 8              | 432                 | 49              |            |
| 5161GP12048*   | 16086      | 120   | 48 | 2  | 10             | 494                 | 56              |            |
| 5161GP12054  | 18154      | 120   | 54 | 3  | 10             | 556                 | 40              |            |
| 5161GP12060  | 20170      | 120   | 60 | 3  | 10             | 614                 | 47              |            |
| 5161GP14448  | 19365      | 144   | 48 | 2  | 10             | 594                 | 66              |            |
| 5161GP14454  | 21785      | 144   | 54 | 3  | 12             | 666                 | 50              |            |
| 5161GP14460  | 24203      | 144   | 60 | 3  | 12             | 738                 | 56              |            |
| 5161GP15654  | 23599      | 156   | 54 | 3  | 12             | 724                 | 54              |            |
| 5161GP15660  | 26221      | 156   | 60 | 3  | 12             | 802                 | 60              |            |
| 5161GP16848  | 22590      | 168   | 48 | 3  | 12             | 694                 | 52              |            |
| 5161GP16854  | 25414      | 168   | 54 | 4  | 12             | 780                 | 44              |            |
| 5161GP16860  | 28238      | 168   | 60 | 4  | 12             | 862                 | 49              |            |
| 5161GP19248  | 25818      | 192   | 48 | 3  | 14             | 794                 | 59              |            |
| 5161GP19254  | 29046      | 192   | 54 | 4  | 14             | 890                 | 50              |            |
| 5161GP19260  | 32272      | 192   | 60 | 4  | 14             | 984                 | 56              |            |

**NOTE:** Support Beams are included in top price. An additional line item for the support beam will be included on the order acknowledgment at no charge.

#### RECTANGULAR - SQUARE CORNER TOPS:

Rectangular tops with square corners are available. Replace the model prefix with **5101GP**. e.g. **5161GP14448** becomes **5101GP14448**. Pricing is the same as standard tops.

#### ORDERING PROCEDURES

To order, please specify the following:

- 1) Table top shape, size, model number, glass color
- 2) Base model number
- 3) Console location and size option
- 4) Cross seam console model number, where applicable
- 5) Console power module and data options

#### DIMENSION KEY

L - length

W - Width

Dimensions are in inches and approximate.

Contact Customer Service if dimensions are critical.

#### BASE REQUIREMENTS

See page 60 for base requirements

#### CONSOLE SIZE & LOCATIONS

See page 41 for information on Console locations and size options


#### CONSOLE POWER/DATA MODULE OPTIONS

See page 49 for Console Module Options

#### TABLE SECTION SIZE

Section sizes can be calculated by dividing the table length by the # of sections

# NUVO | BACK-PAINTED GLASS ARC END CONFERENCE TOPS

| Description   | Model       | Glass | L  | W  | Table Sections | Approximate Seating | Shipping Weight | Cubic Feet |
|---|-------------|-------|----|----|----------------|---------------------|-----------------|------------|
| Arc End Table -<br>Rounded Corners  | 5166GP6036  | 5758  | 60 | 36 | 1              | 4                   | 178             | 42         |
|   | 5166GP6042  | 6717  | 60 | 42 | 1              | 4                   | 206             | 49         |
|   | 5166GP6048  | 7679  | 60 | 48 | 1              | 4                   | 234             | 53         |
|  | 5166GP7236  | 6911  | 72 | 36 | 1              | 6                   | 214             | 50         |
|   | 5166GP7242  | 8061  | 72 | 42 | 1              | 6                   | 246             | 58         |
|   | 5166GP7248  | 9213  | 72 | 48 | 1              | 6                   | 280             | 66         |
|   | 5166GP7836  | 8061  | 78 | 36 | 1              | 6                   | 232             | 55         |
|   | 5166GP7842  | 8709  | 78 | 42 | 1              | 6                   | 268             | 63         |
|   | 5166GP7848  | 10096 | 78 | 48 | 1              | 6                   | 306             | 72         |
|   | 5166GP8436  | 8149  | 84 | 36 | 1              | 6                   | 250             | 59         |
|   | 5166GP8442  | 9516  | 84 | 42 | 1              | 6                   | 288             | 68         |
|   | 5166GP8448  | 10874 | 84 | 48 | 1              | 6                   | 328             | 77         |
|   | 5166GP9636  | 9322  | 96 | 36 | 1              | 8                   | 288             | 67         |
|   | 5166GP9642  | 10874 | 96 | 42 | 2              | 8                   | 334             | 39         |
|   | 5166GP9648* | 12428 | 96 | 48 | 2              | 8                   | 380             | 45         |
| 5166GP10842   | 12233       | 108   | 42 | 2  | 8              | 376                 | 44              |            |
| 5166GP10848   | 13982       | 108   | 48 | 2  | 8              | 428                 | 50              |            |
| 5166GP12042   | 15231       | 120   | 42 | 2  | 10 (8)         | 422                 | 49              |            |
| 5166GP12048   | 16096       | 120   | 48 | 2  | 10             | 478                 | 56              |            |
| 5166GP12054   | 18154       | 120   | 54 | 3  | 10             | 536                 | 40              |            |
| 5166GP12060   | 20170       | 120   | 60 | 3  | 10             | 594                 | 47              |            |
| 5166GP14448   | 19365       | 144   | 48 | 2  | 10             | 578                 | 66              |            |
| 5166GP14454   | 21785       | 144   | 54 | 3  | 12             | 648                 | 50              |            |
| 5166GP14460   | 24203       | 144   | 60 | 3  | 12             | 718                 | 56              |            |
| 5166GP15654   | 23599       | 156   | 54 | 3  | 12 (10)        | 706                 | 54              |            |
| 5166GP15660   | 26221       | 156   | 60 | 3  | 12             | 780                 | 60              |            |
| 5166GP16848   | 22590       | 168   | 48 | 3  | 12             | 676                 | 52              |            |
| 5166GP16854   | 25414       | 168   | 54 | 4  | 12             | 760                 | 44              |            |
| 5166GP16860   | 28238       | 168   | 60 | 4  | 12             | 842                 | 49              |            |
| 5166GP19248   | 25818       | 192   | 48 | 3  | 14             | 776                 | 59              |            |
| 5166GP19254   | 29046       | 192   | 54 | 4  | 14             | 870                 | 50              |            |
| 5166GP19260   | 32272       | 192   | 60 | 4  | 14             | 964                 | 56              |            |

**NOTE:** Support Beams are included in top price. An additional line item for the support beam will be included on the order acknowledgment at no charge.

#### ARC END TABLE - SQUARE CORNERS:

Arc End tops are available with square corners. Replace the model number prefix with **5106GP**. e.g. **5166GP12042** becomes **5106GP12042**. Pricing is the same as standard tops.

#### SEATING CAPACITY:

The number in brackets is the seating capacity when formed metal legs are used if different than the seating capacity when other bases are used.

#### ORDERING PROCEDURES

To order, please specify the following:

- 1) Table top shape, size, model number, glass color
- 2) Base model number
- 3) Console location and size option
- 4) Cross seam console model number, where applicable
- 5) Console power module and data options

#### DIMENSION KEY

L - Length

W - Width

Dimensions are in inches and approximate.

Contact Customer Service if dimensions are critical.

#### BASE REQUIREMENTS

See page 60 for base requirements

#### CONSOLE SIZE & LOCATIONS

See page 45 for information on Console locations and size options

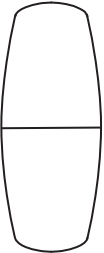
#### CONSOLE POWER/DATA MODULE OPTIONS

See page 49 for Console Module Options

#### TABLE SECTION SIZE

Section sizes can be calculated by dividing the table length by the # of sections

# NUVO | BACK-PAINTED GLASS BOAT SHAPED & VISIO CONFERENCE TOPS

| Description   | Model         | Glass | L   | W     | Table Sections | Approximate Seating | Shipping Weight | Cubic Feet |
|---|---------------|-------|-----|-------|----------------|---------------------|-----------------|------------|
| Boat-Shaped - Arc End Rounded Corners<br> | 5164GP964842  | 12675 | 96  | 48/42 | 2              | 8                   | 362             | 45         |
|   | 5164GP965442* | 14262 | 96  | 54/42 | 2              | 8                   | 408             | 50         |
|   | 5164GP1204842 | 16417 | 120 | 48/42 | 2              | 8                   | 458             | 56         |
|   | 5164GP1205442 | 18517 | 120 | 54/42 | 3              | 10 (8)              | 514             | 40         |
|   | 5164GP1444842 | 19752 | 144 | 48/42 | 2              | 10                  | 552             | 66         |
|   | 5164GP1445442 | 22219 | 144 | 54/42 | 3              | 12                  | 622             | 50         |
|   | 5164GP1685442 | 25923 | 168 | 54/42 | 4              | 12                  | 732             | 44         |
|   | 5164GP1925442 | 29625 | 192 | 54/42 | 4              | 14                  | 838             | 50         |

**NOTE:** Support Beams are included in top price. An additional line item for the support beam will be included on the order acknowledgment at no charge.

#### BOAT SHAPE - ARC END, SQUARE CORNERS:

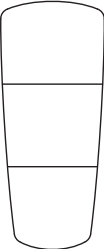
Boat Shape tops are available with Arc ends and Square corners. For Arc End, Square Corner tops replace model suffix with **5154GP**. e.g. **5164GP1204842** becomes **5154GP1204842**. Pricing is the same as standard tops.

#### BOAT SHAPE - STRAIGHT END, SQUARE CORNERS:

Boat Shape tops are available with Straight ends and square corners. For Straight End, Square Corner tops replace model suffix with **5104GP**. e.g. **5164GP1204842** becomes **5104GP1204842**. Pricing is the same as standard tops.

#### SEATING CAPACITY:

The number in brackets is the seating capacity when formed metal legs are used if different than the seating capacity when other bases are used.

|   |                |       |     |       |   |    |     |    |
|---|----------------|-------|-----|-------|---|----|-----|----|
| Visio - Arc End Rounded Corners<br> | 5168GP1206042  | 20314 | 120 | 60/42 | 3 | 8  | 536 | 47 |
|   | 5168GP1446042* | 22002 | 144 | 60/42 | 3 | 10 | 646 | 56 |
|   | 5168GP1686642  | 31295 | 168 | 66/42 | 4 | 13 | 814 | 62 |
|   | 5168GP1926942  | 37391 | 192 | 69/42 | 4 | 15 | 964 | 73 |

**NOTE:** Support Beams are included in top price. An additional line item for the support beam will be included on the order acknowledgment at no charge.

#### VISIO - ARC END, SQUARE CORNERS:

Visio Shape Tops with Arc Ends are available with square corners. For Arc End-Square corners, replace the model suffix with **5158GP**. e.g. **5168GP1446042** becomes **5158GP1446042**. Pricing is the same as standard tops.

#### VISIO - STRAIGHT END, SQUARE CORNERS:

Visio Shape Tops with Straight Ends are available with square corners. For Arc Straight End-Square corners, replace the model suffix with **5108GP**. e.g. **5168GP1446042** becomes **5108GP1446042**. Pricing is the same as standard tops.

#### ORDERING PROCEDURES

To order, please specify the following:

- 1) Table top shape, size, model number, glass color
- 2) Base model number
- 3) Console location and size option
- 4) Cross seam console model number, where applicable
- 5) Console power module and data options

#### DIMENSION KEY

L - Length

W - Width

Dimensions are in inches and approximate.

Contact Customer Service if dimensions are critical.

#### BASE REQUIREMENTS

See page 60 for base requirements

#### CONSOLE SIZE & LOCATIONS

See page 41 for information on Console locations and size options

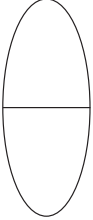
#### CONSOLE POWER/DATA MODULE OPTIONS

See page 49 for Console Module Options

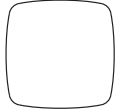
#### TABLE SECTION SIZE

Section sizes can be calculated by dividing the table length by the # of sections

# NUVO | BACK-PAINTED GLASS OVAL, ARCED SQUARE & ROUND CONFERENCE TOPS

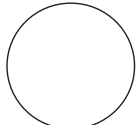
| Description   | Model        | Glass | L   | W  | Table Sections | Approximate Seating | Shipping Weight | Cubic Feet |
|---|--------------|-------|-----|----|----------------|---------------------|-----------------|------------|
|  | 5159GP8448   | 11118 | 84  | 48 | 1              | 6                   | 272             | 77         |
|   | 5159GP9648   | 11967 | 96  | 48 | 2              | 8                   | 314             | 45         |
|   | 5159GP9654   | 14679 | 96  | 54 | 2              | 8                   | 352             | 50         |
|   | 5159GP12048* | 16258 | 120 | 48 | 2              | 8                   | 392             | 56         |
|   | 5159GP12060  | 20314 | 120 | 60 | 3              | 10                  | 486             | 40         |
|   | 5159GP14454  | 21947 | 144 | 54 | 3              | 10                  | 528             | 50         |
|   | 5159GP14460  | 22002 | 144 | 60 | 3              | 12                  | 584             | 56         |
|   | 5159GP16860  | 28448 | 168 | 60 | 4              | 12                  | 682             | 49         |

**NOTE:** Support Beams are included in top price. An additional line item for the support beam will be included on the order acknowledgment at no charge.

|   |                  |            |      |    |    |   |     |     |    |
|---|------------------|------------|------|----|----|---|-----|-----|----|
|  | Arced Square Top | 5166GP3636 | 3456 | 36 | 36 | 1 | 4   | 118 | 31 |
|   | 5166GP4242       | 4705       | 42   | 42 | 1  | 4 | 158 | 41  |    |
|   | 5166GP4848       | 6141       | 48   | 48 | 1  | 4 | 202 | 52  |    |
|   | 5166GP5454       | 7865       | 54   | 54 | 1  | 4 | 254 | 64  |    |

#### ARC SQUARE TOP - SQUARE CORNERS

Arc Square tops are available with square corners. For Square Corner tops replace model suffix with **5156GP**. e.g. **5166GP4242** becomes **5156GP4242**. Pricing is the same as standard tops.

|   |           |          |         |         |   |   |     |    |    |
|---|-----------|----------|---------|---------|---|---|-----|----|----|
|  | Round Top | 5105GP36 | 3523    | 36 Dia. |   | 1 | 3   | 94 | 31 |
|   | 5105GP42  | 4795     | 42 Dia. |         | 1 | 3 | 126 | 41 |    |
|   | 5105GP48  | 6266     | 48 Dia. |         | 1 | 4 | 160 | 52 |    |
|   | 5105GP54  | 8024     | 54 Dia. |         | 1 | 5 | 200 | 64 |    |

#### ORDERING PROCEDURES

To order, please specify the following:

- 1) Table top shape, size, model number, glass color
- 2) Base model number
- 3) Console location and size option
- 4) Cross seam console model number, where applicable
- 5) Console power module and data options

#### DIMENSION KEY

L - Length

W - Width

Dimensions are in inches and approximate.

Contact Customer Service if dimensions are critical.

#### BASE REQUIREMENTS

See page 60 for base requirements

#### CONSOLE SIZE & LOCATIONS

See page 41 for information on Console locations and size options

#### CONSOLE POWER/DATA MODULE OPTIONS

See page 49 for Console Module Options

#### TABLE SECTION SIZE

Section sizes can be calculated by dividing the table length by the # of sections

# NUVO | CONSOLE PLANNING FOR BACK-PAINTED GLASS TOPS

## CONSOLE ORDERING CODE (WITHIN THE TABLE SECTION - 4 CHARACTER CODE)

1st character specifies top sections from left to right on table: A, B, C, D

2nd character specifies console location within top section: M, L, R

M- Middle of top on one piece table

M- Middle of top section on multi section table

L- Left side of a one piece top

R- Right side of a one piece top

3rd and 4th characters specify console size: 14, 27, 36,

Examples:

Table Size: 96" x 36"

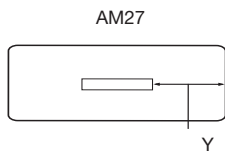


Table Size: 168" x 48"

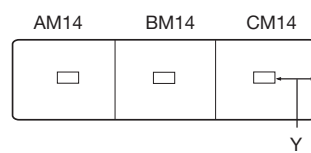


Table Size: 96 "x 36"

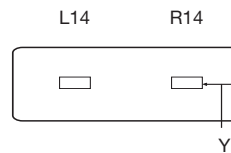
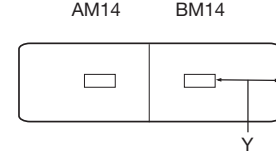


Table Size: 144" x 48"



Y= Dimension from end of table to end of console

## CONSOLE ORDERING CODE (ACROSS SEAM - 5 CHARACTER CODE)

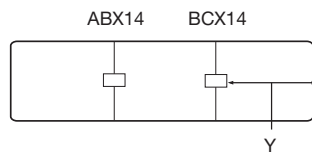
1st and 2nd character specifies section from left to right on table: AB, BC, CD

3rd character specifies console location across the seam: X

4th and 5th characters specify console size: 14, 27, 36,

Example:

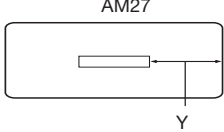
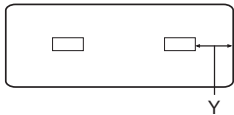
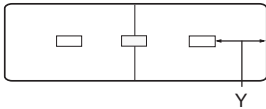
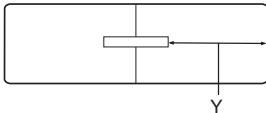
Table Size 168" - 192" X 48"



Y= Dimension from end of table to end of console



# NUVO | CONSOLE SIZE & LOCATION - RECTANGULAR, ARC END, RACETRACK

| Back-Painted Glass Console Options  | Top Length | Console Options Top End Section  | Console Options Within Top Center Section | Console Options Across Seam | Y                |
|---|------------|--|---|-----------------------------|------------------|
| <b>WIDTHS 48" OR LESS</b>   |            |  |   |                             |                  |
| 60" - 84" X 36", 42", 48"   | 60         | M14  |   |                             | 23               |
| 96" X 36"   | 72         | M14  |   |                             | 29               |
|   | 78         | M14<br>M27   |   |                             | 32<br>25.5       |
| Example   | 84         | M14<br>M27   |   |                             | 35<br>28.5       |
|    | 96         | M14<br>M27   |   |                             | 41<br>34.5       |
| 84" X 36", 42", 48"   | 84         | L14 / R14  |   |                             | 18               |
| 96" X 36"   | 96         | L14 / R14  |   |                             | 18               |
| Example   |            |  |   |                             |                  |
|    |            |  |   |                             |                  |
| 96" - 144" X 42", 48"   | 96         | *M14   |   |                             | 18               |
| Example   | 108        | M14  |   |                             | 20               |
| AM14 ABX14 BM14   | 120        | M14  |   | X14                         | 23               |
|  | 144        | M14  |   | X14                         | 29               |
|   |            | *The "M" position of these consoles is not exactly in the center of the section. |   |                             |                  |
| 96" - 144" X 42", 48"   | 96         |  |   | X14<br>X27                  | 41<br>34.5       |
| Example   | 108        |  |   | X14<br>X27<br>X36           | 47<br>40.5<br>36 |
|  | 120        |  |   | X14<br>X27<br>X36           | 53<br>46.5<br>42 |
|   | 144        |  |   | X14<br>X27<br>X36           | 65<br>58.5<br>54 |

## CODE KEY:

M - Console location, middle of top section  
 X - Console location, across a seam of two top sections  
 L - Console location, left side of a one piece top  
 R - Console location, right side of a one piece top  
 Y - Dimension from end of table to end of Console

Caution: Y greater than 30" makes access to Console Power/Data difficult from the end of the table

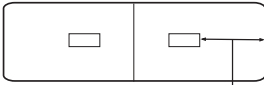
## CONSOLE POWER/DATA MODULE OPTIONS

See page 49 for Console Module Options

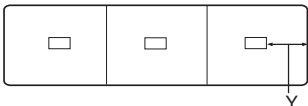
## ORDERING NOTES

Tops may be specified with fewer consoles and configurations other than shown. Consoles can be different sizes within the same top. Dimension from end of cut-out to table end cannot be less than 18".

# NUVO | CONSOLE SIZE & LOCATION - RECTANGULAR, ARC END, RACETRACK & BOAT SHAPED

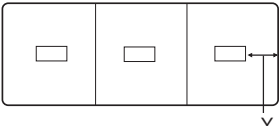
| Back-Painted Glass Console Options   | Top Length | Console Options Top End Section | Console Options Within Top Center Section | Console Options Across Seam | Y  |
|--|------------|---------------------------------|---|-----------------------------|----|
| 96" - 144" X 42", 48"  | 96         | *M14                            |   |                             | 18 |
| Example  | 108        | M14                             |   |                             | 20 |
| AM14 BM14  | 120        | M14                             |   |                             | 23 |
|  | 144        | M14                             |   |                             | 29 |

\*The "M" position of these consoles is not exactly in the center of the section.

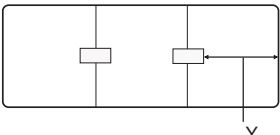
|                   |  |     |     |  |    |
|-------------------|--|-----|-----|--|----|
| 168" - 192" X 48" | 168  | M14 | M14 |  | 21 |
| Example           | 192  | M14 | M14 |  | 25 |
| AM14 BM14 CM14    |  |     |     |  |    |

|                   |   |  |  |     |    |
|-------------------|---|--|--|-----|----|
| 168" - 192" X 48" | 168   |  |  | X14 | 49 |
| Example           | 192   |  |  | X14 | 57 |
| ABX14 BCX14       |  |  |  |     |    |

|  |     |      |     |  |    |
|--|-----|------|-----|--|----|
| <b>GLASS TOP WIDTHS 54" OR GREATER</b> | 120 | *M14 | M14 |  | 18 |
|  | 144 | *M14 | M14 |  | 18 |
| 120" - 156" X 54", 60"                 | 156 | M14  | M14 |  | 19 |

|                |  |  |  |  |  |
|----------------|--|--|--|--|--|
| Example        |  |  |  |  |  |
| AM14 BM14 CM14 |  |  |  |  |  |

\*The "M" position of these consoles is not exactly in the center of the section.

|  |     |  |  |     |    |
|--|-----|--|--|-----|----|
| 120" - 156" X 54", 60"   | 120 |  |  | X14 | 33 |
| Example  | 144 |  |  | X14 | 41 |
| ABX14 BCX14  | 156 |  |  | X14 | 45 |
|  |     |  |  |     |    |

## CODE KEY

- M - Console location, middle of top section
- X - Console location, across a seam of two top sections
- L - Console location, left side of a one piece top
- R - Console location, right side of a one piece top
- Y - Dimension from end of table to end of Console

Caution: Y greater than 30" makes access to Console Power/Data difficult from the end of the table

## CONSOLE POWER/DATA MODULE OPTIONS

See page 49 for Console Module Options

## ORDERING NOTES

Tops may be specified with fewer consoles and configurations other than shown. Consoles can be different sizes within the same top. Dimension from end of cut-out to table end cannot be less than 18".

# NUVO | CONSOLE SIZE & LOCATION - RECTANGULAR, ARC END, RACETRACK & BOAT SHAPED

| Back-Painted Glass Console Options    | Top Length | Console Options Top End Section  | Console Options Within Top Center Section | Console Options Across Seam | Y                |
|---------------------------------------|------------|--|---|-----------------------------|------------------|
| 168"-192" X 54", 60"                  | 168        | *M14   | M14                                       |                             | 18               |
| Example                               | 192        | M14  | M14                                       |                             | 18               |
| AM14 BM14 CM14 DM14                   |            |  |   |                             |                  |
|                                       |            | *The "M" position of these consoles is not exactly in the center of the section. |   |                             |                  |
| 168" - 192" X 54", 60"                | 168        | *M14   |   | X14<br>X27                  | 18               |
| Example                               | 192        | M14  |   | X14<br>X27                  | 18<br>18         |
| AM14 BCX14 DM14                       |            |  |   |                             |                  |
|                                       |            | *The "M" position of these consoles is not exactly in the center of the section. |   |                             |                  |
| 96" - 144" X 48"/42"<br>96" X 54"/42" | 96         | *M14   |   |                             | 18               |
| Example                               | 120        | M14  |   | X14                         | 23               |
| AM14 ABX14 BM14                       | 144        | M14  |   | X14                         | 29               |
|                                       |            | *The "M" position of these consoles is not exactly in the center of the section. |   |                             |                  |
| 96" - 144" X 48"/42"<br>96" X 54"/42" | 96         |  |   | X14<br>X27                  | 41<br>34.5       |
| Example                               | 120        |  |   | X14<br>X36<br>X27           | 53<br>42<br>46.5 |
| ABX36                                 | 144        |  |   | X14<br>X27<br>X36           | 65<br>58.5<br>54 |
|                                       |            | *The "M" position of these consoles is not exactly in the center of the section. |   |                             |                  |
| 96" - 144" X 48"/42"<br>96" X 54"/42" | 96         | *M14   |   |                             | 18               |
| Example                               | 120        | M14  |   |                             | 23               |
| AM14 BM14                             | 144        | M14  |   |                             | 29               |
|                                       |            | *The "M" position of these consoles is not exactly in the center of the section. |   |                             |                  |

## CODE KEY

M - Console location, middle of top section  
 X - Console location, across a seam of two top sections  
 L - Console location, left side of a one piece top  
 R - Console location, right side of a one piece top  
 Y- Dimension from end of table to end of Console

Caution: Y greater than 30" makes access to Console Power/Data difficult from the end of the table.

## CONSOLE POWER/DATA MODULE OPTIONS

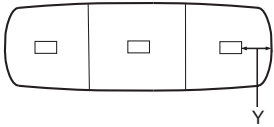
See page 49 for Console Module Options

## ORDERING NOTES

Tops may be specified with fewer consoles and configurations other than shown. Consoles can be different sizes within the same top. Dimension from end of cut-out to table end cannot be less than 18".

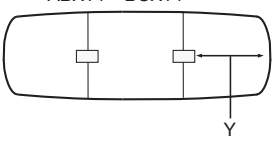
# NUVO | CONSOLE SIZE & LOCATION - BOAT SHAPED

| Back-Painted Glass Top Console Options | Top Length | Console Options Top End Section | Console Options Within Top Center Section | Console Options Across Seam | Y  |
|--|------------|---------------------------------|---|-----------------------------|----|
| 120" - 144" x 54"/42"                  | 120        | *M14                            | M14                                       |                             | 18 |
| Example<br>AM14 BM14 CM14              | 144        | *M14                            | M14                                       |                             | 18 |

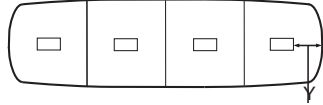


\*The "M" position of these consoles is not exactly in the center of the section.

|                        |     |  |  |     |    |
|------------------------|-----|--|--|-----|----|
| 120" - 144" x 54"/42"  | 120 |  |  | X14 | 33 |
| Example<br>ABX14 BCX14 | 144 |  |  | X14 | 41 |

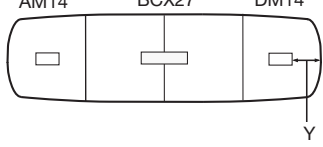


|                                |     |      |     |  |    |
|--------------------------------|-----|------|-----|--|----|
| 168" - 192" X 54"/42"          | 168 | *M14 | M14 |  | 18 |
| Example<br>AM14 BM14 CM14 DM14 | 192 | M14  | M14 |  | 18 |



\*The "M" position of these consoles is not exactly in the center of the section.

|                            |     |      |  |            |    |
|----------------------------|-----|------|--|------------|----|
| 168" - 192" X 54"/42"      | 168 | *M14 |  | X14<br>X27 | 18 |
| Example<br>AM14 BCX27 DM14 | 192 | *M14 |  | X14<br>X27 | 18 |



\*The "M" position of these consoles is not exactly in the center of the section.

## CODE KEY

M - Console location, middle of top section  
 X - Console location, across a seam of two top sections  
 L - Console location, left side of a one piece top  
 R - Console location, right side of a one piece top  
 Y - Dimension from end of table to end of Console

Caution: Y greater than 30" makes access to Console Power/Data difficult from the end of the table

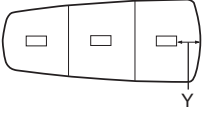
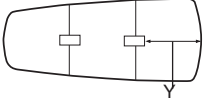
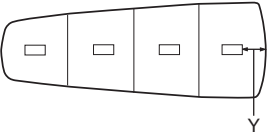
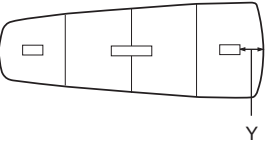
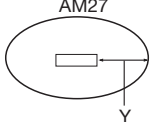
## CONSOLE POWER/DATA MODULE OPTIONS

See page 49 for Console Module Options

## ORDERING NOTES

Tops may be specified with fewer consoles and configurations other than shown. Consoles can be different sizes within the same top. Dimension from end of cut-out to table end cannot be less than 18".

# NUVO | CONSOLE SIZE & LOCATION - VISIO & OVAL

| Back-Painted Glass Top Console Options  | Top Length | Console Options Top End Section  | Console Options Within Top Center Section | Console Options Across Seam | Y          |
|---|------------|--|---|-----------------------------|------------|
| 120" - 144" X 60"/42"   | 120        | *M14   | M14                                       |                             | 18         |
| Example<br>AM14 BM14 CM14   | 144        | M14  | M14                                       |                             | 18         |
|    |            |  |   |                             |            |
|   |            | *The "M" position of these consoles is not exactly in the center of the section. |   |                             |            |
| 120" - 144" X 60/42   | 120        |  |   | X14                         | 33         |
| Example<br>ABX14 BCX14  | 144        |  |   | X14                         | 41         |
|    |            |  |   |                             |            |
| 168" X 66/42"<br>192" X 69/42"  | 168        | *M14   | M14                                       |                             | 18         |
| AM14 BM14 CM14 DM14   | 192        | M14  |   |                             | 18         |
|   |            |  |   |                             |            |
|   |            | *The "M" position of these consoles is not exactly in the center of the section. |   |                             |            |
| 168" X 66/42"<br>192" X 69/42"  | 168        | *M14   |   | X14<br>X27                  | 18         |
| AM14 BCX27 DM14   | 192        | *M14   |   | X14<br>X27                  | 18         |
|  |            |  |   |                             |            |
|   |            | *The "M" position of these consoles is not exactly in the center of the section. |   |                             |            |
| 84" x 48"   | 84         | M14<br>M27   |   |                             | 35<br>28.5 |
| Example<br>AM27   |            |  |   |                             |            |
|  |            |  |   |                             |            |

## CODE KEY

M - Console location, middle of top section  
 X - Console location, across a seam of two top sections  
 L - Console location, left side of a one piece top  
 R - Console location, right side of a one piece top  
 Y - Dimension from end of table to end of Console

Caution: Y greater than 30" makes access to Console Power/Data difficult from the end of the table

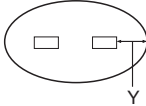
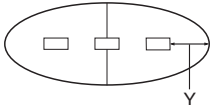
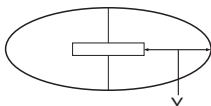
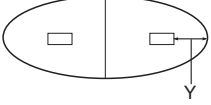
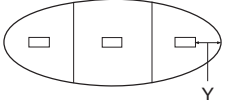
## CONSOLE POWER/DATA MODULE OPTIONS

See page 49 for Console Module Options

## ORDERING NOTES

Tops may be specified with fewer consoles and configurations other than shown. Consoles can be different sizes within the same top. Dimension from end of cut-out to table end cannot be less than 18".

# NUVO | CONSOLE SIZE & LOCATION - OVAL

| Back-Painted Glass Top Console Options   | Top Length | Console Options Top End Section  | Console Options Within Top Center Section | Console Options Across Seam | Y                |
|--|------------|--|---|-----------------------------|------------------|
| 84" x 48"  | 84         | L14/R14  |   |                             | 18               |
| Example<br>AL14 AR14   |            |  |   |                             |                  |
|    |            |  |   |                             |                  |
| 96" - 120" X 48"<br>96" X 54"  | 96         | *M14   |   |                             | 18               |
| AM14 ABX14 BM14  | 120        | M14  |   | X14                         | 23               |
|    |            |  |   |                             |                  |
|  |            | *The "M" position of these consoles is not exactly in the center of the section. |   |                             |                  |
| 96" - 120" X 48"<br>96" X 54"  | 96         |  |   | X27<br>X14                  | 34.5<br>41       |
| Example<br>ABX36   | 120        |  |   | X36<br>X27<br>X14           | 42<br>46.5<br>53 |
|    |            |  |   |                             |                  |
| 96" - 120" X 48"<br>96" X 54"  | 96         | *M14   |   |                             | 18               |
| AM14 BM14  | 120        | M14  |   |                             | 23               |
|  |            |  |   |                             |                  |
|  |            | *The "M" position of these consoles is not exactly in the center of the section. |   |                             |                  |
| 144" X 54"   | 144        | *M14   | M14                                       |                             | 18               |
| Example<br>AM14 BM14 CM14  |            |  |   |                             |                  |
|  |            |  |   |                             |                  |
|  |            | *The "M" position of these consoles is not exactly in the center of the section. |   |                             |                  |

## CODE KEY

M - Console location, middle of top section  
 X - Console location, across a seam of two top sections  
 L - Console location, left side of a one piece top  
 R - Console location, right side of a one piece top  
 Y - Dimension from end of table to end of Console

Caution: Y greater than 30" makes access to Console Power/Data difficult from the end of the table

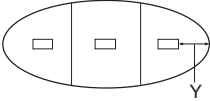
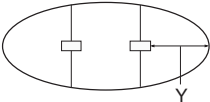
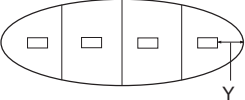
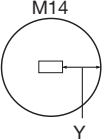
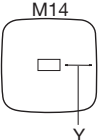
## CONSOLE POWER/DATA MODULE OPTIONS

See page 49 for Console Module Options

## ORDERING NOTES

Tops may be specified with fewer consoles and configurations other than shown. Consoles can be different sizes within the same top. Dimension from end of cut-out to table end cannot be less than 18".

# NUVO | CONSOLE SIZE & LOCATION - OVAL, ROUND, ARCED SQUARE

| Back-Painted Glass Top Console Options  | Top Length | Console Options Top End Section  | Console Options Within Top Center Section | Console Options Across Seam | Y  |
|---|------------|--|---|-----------------------------|----|
| 120" - 144" X 60"   | 120        | *M14   | M14                                       |                             | 18 |
| Example<br>AM14 BM14 CM14   | 144        | M14  | M14                                       |                             | 18 |
|    |            | *The "M" position of these consoles is not exactly in the center of the section. |   |                             |    |
| 120" - 144" X 60"<br>144" X 54"   | 120        |  |   | X14                         | 33 |
| Example<br>ABX14 BCX14  | 144        |  |   | X14                         | 41 |
|    |            |  |   |                             |    |
| 168" X 60"  | 168        | M14  | M14                                       |                             | 18 |
| Example<br>AM14 BM14 CM14 DM14  |            |  |   |                             |    |
|   |            |  |   |                             |    |
| 36" - 60"   | 36         | M14  |   |                             | 11 |
| Examples  | 42         | M14  |   |                             | 14 |
|  | 48         | M14  |   |                             | 17 |
|  | 54         | M14  |   |                             | 20 |

## CODE KEY

M - Console location, middle of top section  
 X - Console location, across a seam of two top sections  
 L - Console location, left side of a one piece top  
 R - Console location, right side of a one piece top  
 Y - Dimension from end of table to end of Console

Caution: Y greater than 30" makes access to Console Power/Data difficult from the end of the table

## CONSOLE POWER/DATA MODULE OPTIONS

See page 49 for Console Module Options

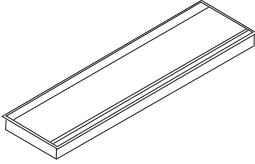
## ORDERING NOTES

Tops may be specified with fewer consoles and configurations other than shown. Consoles can be different sizes within the same top. Dimension from end of cut-out to table end cannot be less than 18".

# NUVO | CONSOLES FOR BACK-PAINTED GLASS TOPS

## CONSOLE - WITHIN A TOP SECTION

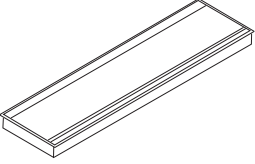
Consoles located within a top section are factory installed. The model numbers are determined by the location within each section and the size. For example, when ordering a rectangular top 96" x 54" a console M14 can be specified in both the A and/or B section of the table. When ordering, simply add AM14 and BM14 to your purchase order and add the list price for each console to your order.

| Description  | Model        | Console Size | Price | Weights | Cubes |
|--|--------------|--------------|-------|---------|-------|
|  | M14, L14,R14 | 14           | 265   | .25     |       |
|  | M27          | 27           | 295   | 4       | .25   |

Consoles are available in 2 standard lengths.

## CONSOLE - ACROSS SEAMS

Consoles located across the seam are field installed and have separate model numbers that need to be included on your purchase order along with the desired console position. For example, when ordering a rectangular top 120" x 54" with a console across the seam, purchase orders need to specify the model number for the console (51CONSOLEX-14) and the location ABX14.

| Description  | Model         | Console Size | Price | Weights | Cubes |
|--|---------------|--------------|-------|---------|-------|
|  | 51CONSOLE-X14 | 14           | 265   | 3       | 0.25  |
|  | 51CONSOLE-X27 | 27           | 295   | 4       | 0.25  |
|  | 51CONSOLE-X36 | 36           | 333   | 5       | 0.25  |

## CONSOLE POWER/DATA MODULES

Console modules provide an extensive range of power, data and audio-visual solutions for today's conferencing environments. Console modules are available in 18 preconfigured data and power options, or alternatively console modules with just electrical ports can be selected allowing units to be designed and built specifically to meet your connectivity needs by using the Snap-in or Plate mounted port options.

Consoles are available with 3 power options in both preconfigured & custom console modules.

Power Module A (PMA) consists of 2 duplex receptacles with 3 cord lengths 6', 16' & 25'.

Power Module B (PMB) consists of 1 duplex receptacle with 3 cord lengths 6', 16' & 25'.

Power Module C (PMC) consists of 2 duplex receptacles with a utility outlet & circuit breaker with 2 cord lengths 6' & 16'. The utility outlet in Module C allows another power module within the table to be plugged into it resulting in 1 cord going to the power source for both modules, as well as circuit protection for both modules. This also means shorter cord lengths can be specified resulting in a more cost effective power solution. Krug recommends the use of Module C's on the Console at the end of the table or location in the table nearest the power source.

### Examples:

120" table with 2 consoles & the power source at right end.

Use a PMC06 in the 1st console from the right & the cord goes to power source.

Use a PMA06 in the 2nd console from the right & the cord goes to the utility outlet of the first console module.

168" table with 4 consoles & power source at right hand end.

Use a PMC06 in the 1st console from the right & the cord goes to power source.

Use a PMC06 in the 2nd console from the right & the cord goes to power source.

Use a PMA06 in the 3rd console from the right & the cord goes to utility the outlet in the 1st console module.

Use a PMA06 in the 4th console from the right & the cord goes to utility the outlet in the 2nd console module.

### CODE KEY

M - Console location, middle of top section

X - Console location, across a seam of two top sections

L - Console location, left side of a one piece top

R - Console location, right side of a one piece top

Y - Dimension from end of table to end of Console

Caution: Y greater than 30" makes access to Console Power/Data difficult from the end of the table

### CONSOLE POWER/DATA MODULE OPTIONS

See page 49 for Console Module Options

### ORDERING NOTES

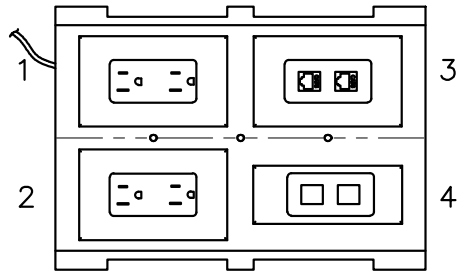
Tops may be specified with fewer consoles and configurations other than shown. Consoles can be different sizes within the same top. Dimension from end of cut-out to table end cannot be less than 18".



# NUVO | STANDARD CONSOLE POWER/DATA/MEDIA CONFIGURATIONS

There are 3 versions of console power/data module: A, B, C. Version C has an utility outlet, this also allows another power module to be plugged into it allowing a shorter cord to be used.

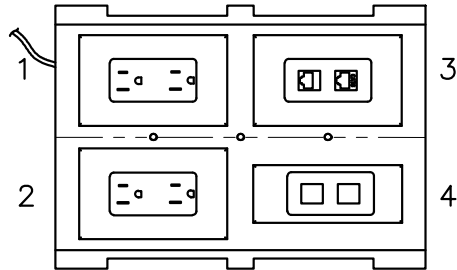
## POWER MODULE A PRECONFIGURED



| PORT OPTIONS | MODEL # | CORD LENGTH | LIST PRICE |
|--------------|---------|-------------|------------|
|--------------|---------|-------------|------------|

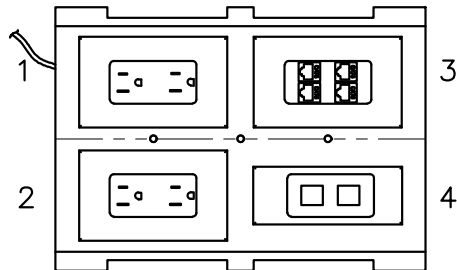
### BASIC DATA

|                                    |             |     |     |
|------------------------------------|-------------|-----|-----|
| ① (1) Duplex Receptacle            | 51PDAD01-06 | 6'  | 508 |
|                                    | 51PDAD01-16 | 16' | 596 |
| ② (1) Duplex Receptacle            | 51PDAD01-25 | 25' | 670 |
| ③ (2) RJ45 Port (Cat 6)            |             |     |     |
| ④ (2) Blank Ports (for future use) |             |     |     |



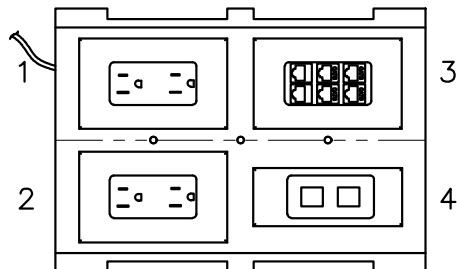
### BASIC VOICE DATA

|                                    |             |     |     |
|------------------------------------|-------------|-----|-----|
| ① (1) Duplex Receptacle            | 51PDAD02-06 | 6'  | 483 |
|                                    | 51PDAD02-16 | 16' | 571 |
| ② (1) Duplex Receptacle            | 51PDAD02-25 | 25' | 648 |
| ③ (1) RJ45 Port (Cat 6)            |             |     |     |
| ③ (1) RJ11 (Voice) Port            |             |     |     |
| ④ (2) Blank Ports (for future use) |             |     |     |



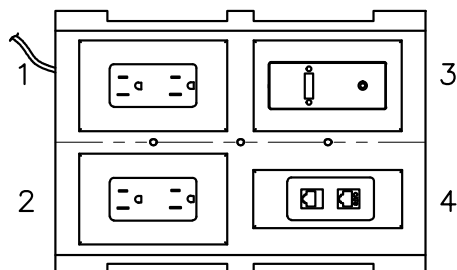
### EXPANDED DATA

|                                    |             |     |     |
|------------------------------------|-------------|-----|-----|
| ① (1) Duplex Receptacle            | 51PDAD03-06 | 6'  | 589 |
|                                    | 51PDAD03-16 | 16' | 678 |
| ② (1) Duplex Receptacle            | 51PDAD03-25 | 25' | 753 |
| ③ (4) RJ45 Port (Cat 6)            |             |     |     |
| ④ (2) Blank Ports (for future use) |             |     |     |



### EXPANDED VOICE DATA

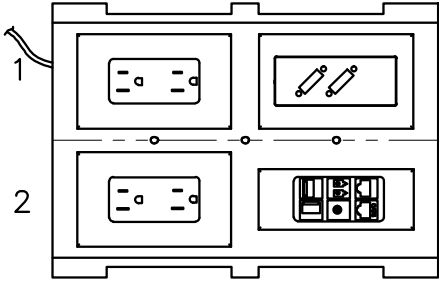
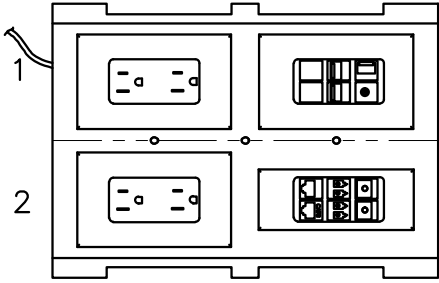
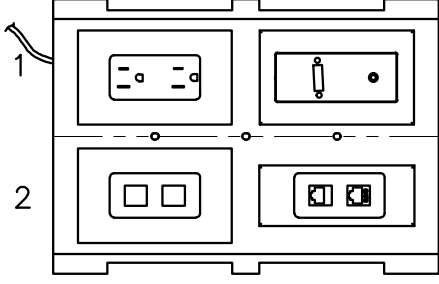
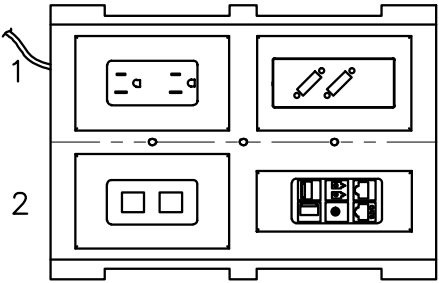
|                                    |             |     |     |
|------------------------------------|-------------|-----|-----|
| ① (1) Duplex Receptacle            | 51PDAD04-06 | 6'  | 626 |
|                                    | 51PDAD04-16 | 16' | 716 |
| ② (1) Duplex Receptacle            | 51PDAD04-25 | 25' | 791 |
| ③ (4) RJ45 Port (Cat 6)            |             |     |     |
| ③ (2) RJ11 (Voice) Port            |             |     |     |
| ④ (2) Blank Ports (for future use) |             |     |     |



### BASIC MULTIMEDIA

|                          |             |     |     |
|--------------------------|-------------|-----|-----|
| ① (1) Duplex Receptacle  | 51PDAD05-06 | 6'  | 633 |
|                          | 51PDAD05-16 | 16' | 723 |
| ② (1) Duplex Receptacle  | 51PDAD05-25 | 25' | 799 |
| ③ (1) Stereo 3.5 Mini    |             |     |     |
| ③ (1) VGA Type 15 pin HD |             |     |     |
| ④ (1) RJ45 Port (Cat 6)  |             |     |     |
| ④ (1) RJ11 (Voice) Port  |             |     |     |

# NUVO | STANDARD CONSOLE POWER/DATA/MEDIA CONFIGURATIONS

|   | PORT OPTIONS   | MODEL #                                   | CORD LENGTH      | LIST PRICE           |
|---|--|---|------------------|----------------------|
|   | <b>ENHANCED MULTIMEDIA</b>   |   |                  |                      |
|   | ① (1) Duplex Receptacle<br>② (1) Duplex Receptacle<br>③ (1) DVI-I<br>(1) VGA<br>(1) RJ11 (Voice) Port<br>(1) RJ45 Port (Cat 6)<br>④ (1) Fibre Optic LC Duplex<br>(1) Stereo 3.5 mm Mini<br>(1) USB "A"<br>(1) HDMI   | 51PDAD06-06<br>51PDAD06-16<br>51PDAD06-25 | 6'<br>16'<br>25' | 1282<br>1372<br>1446 |
|   | <b>BASIC FIBRE OPTIC AND MULTIMEDIA</b>  |   |                  |                      |
|   | ① (1) Duplex Receptacle<br>② (1) Duplex Receptacle<br>(1) HDMI<br>(1) Stereo 3.5 mm Mini<br>(2) USB "A"<br>(2) Blank Ports (for future use)<br>③ (2) Fibre Optic SC Simplex<br>(2) Fibre Optic LC Duplex<br>④ (1) RJ45 Port (Cat 6)<br>(1) RJ11 (Voice) Port | 51PDAD07-06<br>51PDAD07-16<br>51PDAD07-25 | 6'<br>16'<br>25' | 1173<br>1266<br>1341 |
| <b>POWER MODULE B PRECONFIGURED</b><br> | <b>BASIC MULTIMEDIA</b>  |   |                  |                      |
|   | ① (1) Duplex Receptacle<br>② (2) Blank Ports (for future use)<br>③ (1) Stereo 3.5 mm Mini<br>(1) VGA Type 15 pin HD<br>④ (1) RJ45 Port (Cat 6)<br>(1) RJ11 (Voice) Port  | 51PDBD05-06<br>51PDBD05-16<br>51PDBD05-25 | 6'<br>16'<br>25' | 542<br>633<br>708    |
|   | <b>ENHANCED MULTIMEDIA</b>   |   |                  |                      |
|   | ① (1) Duplex Receptacle<br>② (2) Blank Ports (for future use)<br>③ (1) DVI-I<br>(1) VGA<br>(1) RJ11 (Voice) Port<br>(1) RJ45 Port (Cat 6)<br>④ (1) Fibre Optic LC Duplex<br>(1) Stereo 3.5 mm Mini<br>(1) USB "A"<br>(1) HDMI                                | 51PDBD06-06<br>51PDBD06-16<br>51PDBD06-25 | 6'<br>16'<br>25' | 1198<br>1288<br>1361 |





# NUVO | CONSOLE POWER MODULES FOR CUSTOM CONFIGURATIONS

|   | PORT OPTIONS  | MODEL #            | CORD LENGTH | LIST PRICE |
|---|---|--------------------|-------------|------------|
| <b>POWER MODULE A</b>   |   |                    |             |            |
|   | ① (1) Duplex Receptacle   | 51PMA06            | 6'          | 483        |
|   | ② (1) Duplex Receptacle   | 51PMA16            | 16'         | 565        |
|   | ③ (1) Open for data   | 51PMA25            | 25'         | 641        |
|   | ④ (1) Open for data   |                    |             |            |
| <b>POWER MODULE B</b>   |   |                    |             |            |
|   | ① (1) Duplex Receptacle   | 51PMB06            | 6'          | 363        |
|   | ② (1) Open for data   | 51PMB16            | 16'         | 446        |
|   | ③ (1) Open for data   | 51PMB25            | 25'         | 530        |
|   | ④ (1) Open for data   |                    |             |            |
| <b>POWER MODULE C WITH UTILITY OUTLET</b>   |   |                    |             |            |
|   | ① (1) Duplex Receptacle w/ 15 amp circuit breaker                 | 51PMC06<br>51PMC16 | 6'<br>16'   | 508<br>582 |
|   | ② (1) Duplex Receptacle with Utility Outlet                       |                    |             |            |
|   | ③ (1) Open for data   |                    |             |            |
|   | ④ (1) Open for data   |                    |             |            |
| <b>DATA MODULE D</b>  |   |                    |             |            |
|   | ① (1) Open for data   | 51PMD              |             | 128        |
|   | ② (1) Open for data   |                    |             |            |
|   | ③ (1) Open for data   |                    |             |            |
|   | ④ (1) Open for data   |                    |             |            |
| <p>This open module can also be used if hard wiring power is required. Electrical boxes and receptacles can be installed in open spaces and a Decora face plate is mounted on top. All components would be provided by a qualified electrician.</p> |   |                    |             |            |
| <b>POWER MODULE E WITH UTILITY OUTLET</b>   |   |                    |             |            |
|   | ① (1) Duplex Receptacle w/15 amp circuit breaker                  | 51PME06            |             | 764        |
|   | ② (1) Simplex Receptacle/ 2 USB Charging Port with Utility Outlet | 51PME16            |             | 865        |
|   | ③ (1) open for data   |                    |             |            |
|   | ④ (1) open for data   |                    |             |            |
| <b>POWER MODULE A - HARD WIRED</b>  |   |                    |             |            |
|   | ① (1) Duplex Receptacle   | 51PMA16HW          | 16'         | 648        |
|   | ② (1) Duplex Receptacle   |                    |             |            |
|   | ③ (1) Open for data   |                    |             |            |
|   | ④ (1) Open for data   |                    |             |            |

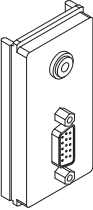
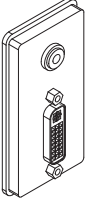
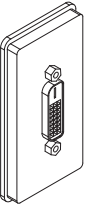
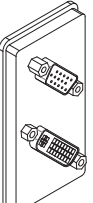
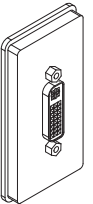
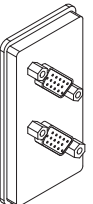
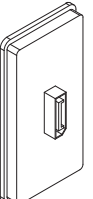
**NOTE:** Open positions will accept 1 Plate Mounted Data Option or up to 6 Snap-In Data Options. Please order a blank port when an odd number of snap-in ports are specified.

When specifying data within the power console module, please provide reference code and port position (1, 2, 3 or 4).


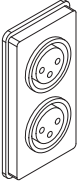
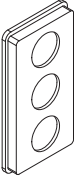
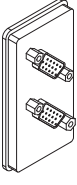
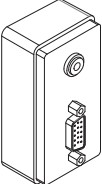

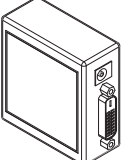
**PLATE MOUNTED DATA OPTIONS**  
See page 54 for Plate Mounted Data Options

**SNAP-IN DATA OPTIONS**  
See page 56 for Snap-In Data Options

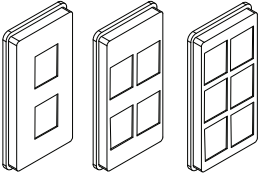

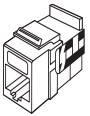

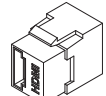



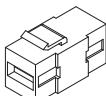
# NUVO | CONSOLE DATA/MEDIA OPTIONS

| PLATE MOUNTED PORTS  | Reference Code | Description  | List Price |
|--|----------------|--|------------|
|    | P01            | <b>VGA &amp; 3.5 STEREO MINI</b> - Use for VGA (DB15) connections and for 3.5mm stereo connections. VGA connectors is a female-to-female pass through and the 3.5 Mini is a female-to-female pass through.   | 143        |
|    | P02            | <b>DVI-I DUAL (DIGITAL/ANALOG) &amp; 3.5 STEREO MINI</b> - Use for DVI Integrated - Digital and Analog connections and for 3.5mm stereo connection. The DVI connector is a Dual Link. DVI-I connector is a female-to-female pass through and the 3.5 Mini is a female input with screw terminal output (back side of Console interface). | 212        |
|    | P03            | <b>DVI-D DUAL (DIGITAL)</b> - Use for DVI-D Digital only connection. The connector is a Dual Link. Connector is a female-to-female pass through.   | 137        |
|   | P04            | <b>DVI-I DUAL (DIGITAL/ANALOG) &amp; VGA</b> - Use for DVI Integrated - Digital and Analog and for VGA (DB15) connections. The DVI connector is a Dual Link. Both connectors are female-to-female pass through.  | 271        |
|  | P05            | <b>DVI-I DUAL (DIGITAL/ANALOG)</b> - Use for DVI Integrated -Digital and Analog connections. DVI connector is a Dual Link. Connector is a female-to-female pass through.   | 173        |
|  | P06            | <b>VGA-2</b> - Use for two VGA (DB15) connections. Both connectors are female-to-female pass through.  | 168        |
|  | P07            | <b>DISPLAYPORT</b> - Use for DisplayPort connection. This connector is primarily used to connect a video source to a display device and also carries audio signals, Connector is a female input to a 3' corded output (back side of Console interface) with a male Display Port termination.   | 168        |

# NUVO | CONSOLE DATA/MEDIA OPTIONS

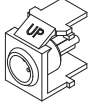
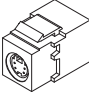
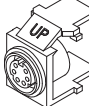

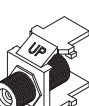
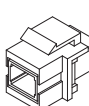
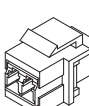
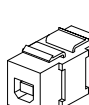
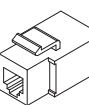

| PLATE MOUNTED PORTS   | Reference Code | Description   | List Price |
|---|----------------|---|------------|
|    | <b>P08</b>     | <b>MICROPHONE XLR STANDARD</b> - Use for standard size XLR microphone connection. Connector is a female input with a 3 pin screw terminal output (back side of Console interface).  | 228        |
|    | <b>P09</b>     | <b>MICROPHONE STANDARD XLR -2</b> - Use for two standard size XLR microphone connections. Each connector is a female input with a 3 pin screw terminal output (back side of Console interface).   | 333        |
|    | <b>P10</b>     | <b>3 HOLE CABLE PASS THROUGH</b> - Use for running loose cables from the under side of the table up into the Console interface cavity. Often used with running wires for PolyCom™ devices.  | 54         |
|   | <b>P11</b>     | <b>VGA-to-BNCx2</b> - Use for two VGA (DB15) connections that are input female pass through and are terminated on the output (back side of Console interface) with 5 BNC female pigtail connections, for each VGA connector.  | 542        |
|  | <b>P12</b>     | <b>INPUT VGA &amp; 3.5 Stereo (POWERED)</b> - VGA + Audio Line Driver designed for VGA (DB15) connections and for 3.5mm stereo connections. This unit provides a method of transmitting signals to a remote display and audio receiver or amplifier. VGA connector is a female input and comes with cabling for either VGA output, or 5 BNC output and the 3.5 Mini is a female input with screw terminal output (back side of Console interface). A 9 volt DC 500mA power supply is required to power this unit. | 1327       |
|  | <b>P13</b>     | <b>BLANK DECORA ADAPTER</b> - Use for covering a full Decora sides blank opening.   | 38         |
|  | <b>DVIR</b>    | <b>DVI-REPEATER</b> - Is a cable equalizer that automatically compensates for long DVI cable runs. This unit extends the usable cable distance up to 130 ft depending on the quality of the cable and the resolution of the video signal. Additionally, it is capable of extending dual link signals allowing for much greater resolutions and refresh rates. This unit comes with a power supply and is generally mounted underneath a table.  | 1046       |

# NUVO | CONSOLE DATA/MEDIA OPTIONS

| SNAP IN PORTS   | Reference Code | Description  | List Price |
|---|----------------|--|------------|
| <b>ADAPTOR PLATES</b>   |                |  |            |
|               | <b>M02</b>     | <b>Adaptor Plate (2)</b> - accepts two snap in data ports  | 38         |
|   | <b>M04</b>     | <b>Adaptor Plate (4)</b> - accepts four snap in data ports   | 38         |
|   | <b>M06</b>     | <b>Adaptor Plate (6)</b> - accepts six snap in data ports  | 38         |
| <b>ORDERING NOTES:</b> Blank covers are required when port is not in use, please see page 55. |                |  |            |
|               | <b>S01W</b>    | RJ45-CAT6 (White)  | 47         |
|   | <b>S01B</b>    | RJ45-CAT6 (Blue)   |            |
|   | <b>S01R</b>    | RJ45-CAT6 (Red)  |            |
|               | <b>S02W</b>    | RJ11 (White)   | 32         |
|   | <b>S02B</b>    | RJ11-B (Black)   |            |
|   | <b>S02G</b>    | RJ11-G (Green)   |            |
|   | <b>S02R</b>    | RJ11-R (Red)   |            |
|   | <b>S02Y</b>    | RJ11-Y (Yellow)  |            |
|             | <b>S03</b>     | <b>3.5 STEREO MINI</b> - 3.5mm stereo connection. Connector is a female input with screw terminal output (back side of Console interface).                   | 92         |
|             | <b>S04</b>     | <b>HDMI</b> - High Definition Multimedia Interface connection. Connector carries both HD audio and video data. Connector is a female-to-female pass through. | 173        |
|             | <b>S05</b>     | <b>RCA-LEFT</b> - RCA left audio channel connection. Color coded with black. Connector is a female-to-female pass through.                                   | 38         |
|             | <b>S06</b>     | <b>RCA-RIGHT</b> - RCA right audio channel connection. Color coded with red. Connector is a female-to-female pass through.                                   | 38         |
|             | <b>S07</b>     | <b>RCA- VIDEO</b> - RCA video channel connection. Color coded with yellow. Connector is a female-to-female pass through.                                     | 38         |
|             | <b>S08</b>     | <b>USB-A</b> - Full size USB "A" style connection. Connector is a female-to-female pass through.   | 61         |



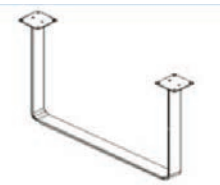
# NUVO | CONSOLE DATA/MEDIA OPTIONS

| SNAP IN PORTS   | Reference Code | Description   | List Price |
|---|----------------|---|------------|
|    | <b>S09</b>     | <b>3 PIN MINI XLR</b> - 3 Pin Mini XLR microphone connection. Connector is a female input to a 6' corded output (back side of Console interface) with a 3 Pin Mini XLR male termination.  | 739        |
|    | <b>S10</b>     | <b>S-VIDEO</b> - S-Video connection. Connector is a female-to-female pass through.  | 68         |
|    | <b>S11</b>     | <b>PS/2 (6 PIN MINI DIN)</b> - PS/2 (mouse, keyboard, other input devices) connections. Connector is a female-to-female pass through.   | 85         |
|    | <b>S12</b>     | <b>BNC</b> - BNC style data connection for use with co-axial cable. Connector is a female-to-female pass through.   | 47         |
|   | <b>S13</b>     | <b>F-TYPE</b> - F-Type (DSL, Cable) connections, generally for high speed Internet or video applications. Connector is a female-to-female threaded pass through.  | 38         |
|  | <b>S14</b>     | <b>FIBER OPTIC SC</b> - Fibre Optic SC Simplex connection. Connector is a female-to-female pass through. Please note that two of these connectors are required to complete the data transmissions to and from the source and destination units. | 47         |
|  | <b>S15</b>     | <b>FIBER OPTIC LC</b> - Fibre Optic LC Duplex connection. Connector is a female-to-female pass through. One connector only is required to complete the data transmissions to and from source and destination units.                             | 92         |
|  | <b>S16</b>     | <b>USB-B</b> - USB "B" type connection. Connector is a female "B" input to a female "A" output (back side of Console interface). This connector is reversible.  | 137        |
|  | <b>S17</b>     | <b>RJ12 (White)</b> - RJ12 style PolyCom™ connection. Connector is a female input with a 6' corded output (back side) of Console interface) with a male RJ12 termination.   | 295        |
|  | <b>S00</b>     | <b>BLANK COVER</b> - Blank covers are required when port is not in use.   | 16         |

**NOTE:** Up to 6 snap-in data ports can be ordered for open data positions. Snap-in adaptors can accept 2, 4 or 6 snap-in data ports. Please order a blank port when an odd number of snap-in ports are specified.

# NUVO | BASES

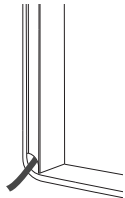
| Description | Model | Price | W | D | H | Shipping Weight | Cubic Feet |
|-------------|-------|-------|---|---|---|-----------------|------------|
|-------------|-------|-------|---|---|---|-----------------|------------|



|                   |           |      |    |   |    |    |      |
|-------------------|-----------|------|----|---|----|----|------|
| Formed Metal Base | 514124328 | 1173 | 24 | 3 | 28 | 29 | 2.75 |
|                   | 514136328 | 1311 | 36 | 3 | 28 | 31 | 3.75 |
|                   | 514148328 | 1446 | 47 | 3 | 28 | 37 | 4.5  |

**ORDERING NOTE:** Formed Metal bases are available in Matte Chrome. There are two cable management options available for Formed Metal bases – Metal Cable Manager or Spine Cable Manager. To order either of these options, please add the cable manager suffix to the end of the model number and add the upcharge listed below. For Example: To add the Metal Cable Manager to the Formed Metal base, please add **CM1** to the end of the base model number. e.g. 514124328 changes to 514124328**CM1** & add the upcharge from below. To add the Spine Cable Manager to the table, please add **CM2** to the end of the Formed Metal base model number. e.g. 514124328 changes to 514124328 **CM2** & add the upcharge from below.

Formed Metal Base Cable Management



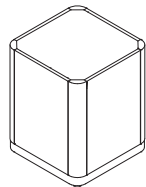
|                     |     |
|---------------------|-----|
| Metal Cable Manager | 182 |
| CM1                 |     |

**NOTE:** Metal Cable Manager attaches to the Formed Metal Base magnetically.



|                     |     |
|---------------------|-----|
| Spine Cable Manager | 212 |
| CM2                 |     |

| Description                               | Model      | Laminate<br>Oak, Maple<br>Cherry<br>Palette | Walnut | W  | D  | H  | Shipping Weight | Cubic Feet |
|---|------------|---|--------|----|----|----|-----------------|------------|
| Square Base for Arc Square and Round Tops | 5142161628 | 1064  | 1194   | 16 | 16 | 28 | 136             | 7.25       |
|   | 5142202028 | 1192  | 1309   | 20 | 20 | 28 | 160             | 12.5       |



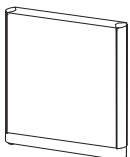
**ORDERING NOTES:** Bases are available in Oak, Maple, Cherry, Walnut, Palette finishes and Laminate. Base plates are available in Gloss Aluminum, Palette, Laminate or Wood, please specify requirement on order.

**BASE SIZES FOR ARCDED SQUARE TABLES AND FOR ROUND TABLES**

| Top Size Arc Square | Top Size Round Tops | Quantity | W  | D  | H  |
|---------------------|---------------------|----------|----|----|----|
| 36-36               | 36 Dia.             | 1        | 16 | 16 | 28 |
| 42-42               | 42 Dia.             | 1        | 16 | 16 | 28 |
| 48-48               | 48 Dia.             | 1        | 20 | 20 | 28 |
| 54-54               | 54 Dia.             | 1        | 20 | 20 | 28 |
| 60-60               | 60 Dia.             | 1        | 20 | 20 | 28 |

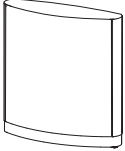
These bases include a weighted ballast to provide stability.

Panel Base

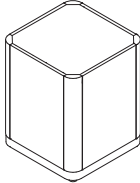


|           |      |      |      |   |    |    |      |
|-----------|------|------|------|---|----|----|------|
| 513921325 | 882  | 971  | 20.5 | 3 | 25 | 30 | 2    |
| 513925325 | 957  | 1054 | 24.5 | 3 | 25 | 33 | 2.25 |
| 513931325 | 1017 | 1119 | 30.5 | 3 | 25 | 38 | 2.5  |

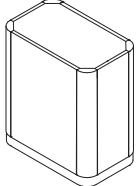
**ORDERING NOTE:** Base plates are available in Gloss Aluminum, Palette, Laminate or Wood, please specify requirement on order.

| Description   | Model      | Laminate<br>Oak, Maple,<br>Cherry,<br>Palette | Walnut | W  | D  | H  | Shipping<br>Weight | Cubic<br>Feet |
|---|------------|---|--------|----|----|----|--------------------|---------------|
|  | 514521825  | 994   | 1093   | 21 | 8  | 25 | 28                 | 3.5           |
|   | 5145251025 | 1068  | 1177   | 25 | 10 | 25 | 33                 | 5.75          |
|   | 5145311225 | 1162  | 1275   | 31 | 12 | 25 | 38                 | 7.75          |


**ORDERING NOTE:** Base plates are available in Gloss Aluminum, Palette, Laminate or Wood, please specify requirement on order.

| Description   | Model      | Laminate<br>Oak, Maple,<br>Cherry,<br>Palette | Walnut | W  | D  | H  | Shipping<br>Weight | Cubic<br>Feet |
|---|------------|---|--------|----|----|----|--------------------|---------------|
|  | 5143161625 | 1173  | 1292   | 16 | 16 | 25 | 60                 | 7.25          |
|   | 5143202025 | 1236  | 1358   | 20 | 20 | 25 | 75                 | 8.5           |
|   | 5143242425 | 1282  | 1409   | 24 | 24 | 25 | 88                 | 12            |
|   | 5143303025 | 1416  | 1558   | 30 | 30 | 25 | 95                 | 14            |

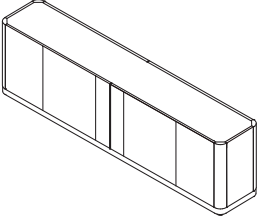
**ORDERING NOTE:** Base plates are available in Gloss Aluminum, Palette, Laminate or Wood, please specify requirement on order.

| Description  | Model      | Laminate<br>Oak, Maple,<br>Cherry,<br>Palette | Walnut | W    | D  | H  | Shipping<br>Weight | Cubic<br>Feet |
|--|------------|---|--------|------|----|----|--------------------|---------------|
|  | 5144211225 | 1039  | 1142   | 21.5 | 12 | 25 | 55                 | 7             |
|  | 5144251225 | 1173  | 1292   | 25   | 12 | 25 | 61                 | 8             |
|  | 5144311225 | 1311  | 1441   | 31   | 12 | 25 | 69                 | 9.5           |

**ORDERING NOTE:** Base plates are available in Gloss Aluminum, Palette, Laminate or Wood, please specify requirement on order.

| Description   | Model       | Laminate<br>Oak, Maple,<br>Cherry,<br>Palette | Walnut | W  | D   | H  | Shipping<br>Weight | Cubic<br>Feet |
|---|-------------|---|--------|----|-----|----|--------------------|---------------|
|  | 5146184725  | 2500  | 2747   | 18 | 47  | 25 | 118                | 19            |
|   | 5146187125  | 3208  | 3529   | 18 | 71  | 25 | 175                | 28            |
|   | 5146247125  | 4185  | 4604   | 24 | 71  | 25 | 270                | 41            |
|   | 5146249525  | 5345  | 5878   | 24 | 95  | 25 | 308                | 46.5          |
|   | 51462410725 | 6308  | 6938   | 24 | 107 | 25 | 346                | 52            |

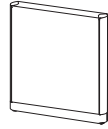
**ORDERING NOTE:** Base plates are available in Gloss Aluminum, Palette, Laminate or Wood, please specify requirement on order.

| Description   | Model       | Laminate<br>Oak, Maple,<br>Cherry,<br>Palette | Walnut | W  | D   | H  | Shipping<br>Weight | Cubic<br>Feet |
|---|-------------|---|--------|----|-----|----|--------------------|---------------|
|  | 5147182725  | 1192  | 1309   | 18 | 27  | 25 | 46                 | 11.5          |
|   | 5147183925  | 1612  | 1773   | 18 | 39  | 25 | 65                 | 16            |
|   | 5147186325  | 2168  | 2385   | 18 | 63  | 25 | 102                | 25            |
|   | 5147189925  | 2996  | 3294   | 18 | 99  | 25 | 157                | 38            |
|   | 51471812325 | 3706  | 4072   | 18 | 123 | 25 | 193                | 47            |
|   | 51471817125 | 4998  | 5498   | 18 | 171 | 25 | 267                | 65            |
|   | 5147246325  | 2576  | 2831   | 24 | 63  | 25 | 134                | 31.5          |
|   | 5147249925  | 3088  | 3396   | 24 | 99  | 25 | 207                | 48.5          |
|   | 51472412325 | 4366  | 4802   | 24 | 123 | 25 | 256                | 60            |
|   | 51472417125 | 5766  | 6343   | 24 | 171 | 25 | 351                | 82.5          |
|   | 51472421925 | 6504  | 7154   | 24 | 219 | 25 | 451                | 105           |

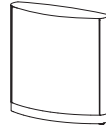
**ORDERING NOTE:** Base plates are available in Gloss Aluminum, Palette, Laminate or Wood, please specify requirement on order. Rectangular island bases greater than 99" are constructed in two pieces requiring assembly in the field.

# NUVO | BASE REQUIREMENTS CHART

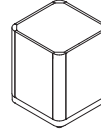
Panel Base  
5139



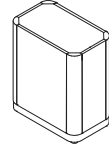
Oval Base  
5145



Square Base  
5143



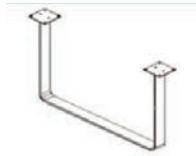
Rectangular Base  
5144



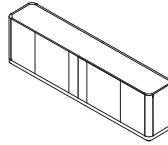
| Model#  | Quantity | Size | Quantity | Size | Quantity | Size | Quantity | Size |
|---|----------|------|----------|------|----------|------|----------|------|
| <b>BASE REQUIREMENTS FOR RECTANGULAR (5161) &amp; ARC END (5166) TOPS</b> |          |      |          |      |          |      |          |      |
| 60-36   | 2        | 21   | 2        | 21   |          |      |          |      |
| 60-42   | 2        | 21   | 2        | 21   |          |      |          |      |
| 60-48   | 2        | 21   | 2        | 21   |          |      |          |      |
| 72-36   | 2        | 21   | 2        | 21   |          |      |          |      |
| 72-42   | 2        | 21   | 2        | 21   |          |      |          |      |
| 72-48   | 2        | 21   | 2        | 21   |          |      |          |      |
| 78-36   | 2        | 21   | 2        | 21   |          |      | 2        | 21   |
| 78-42   | 2        | 21   | 2        | 21   |          |      | 2        | 21   |
| 78-48   | 2        | 21   | 2        | 21   |          |      | 2        | 21   |
| 84-36   | 2        | 21   | 2        | 21   |          |      | 2        | 21   |
| 84-42   | 2        | 21   | 2        | 21   |          |      | 2        | 21   |
| 84-48   | 2        | 21   | 2        | 21   |          |      | 2        | 21   |
| 96-36   | 2        | 21   | 2        | 21   | 2        | 16   | 2        | 21   |
| 96-42   | 2        | 21   | 2        | 21   | 2        | 16   | 2        | 21   |
| 96-48   | 2        | 21   | 2        | 21   | 2        | 20   | 2        | 21   |
| 108-42  | 2        | 21   | 2        | 21   | 2        | 16   | 2        | 21   |
| 108-48  | 2        | 21   | 2        | 21   | 2        | 20   | 2        | 21   |
| 108-54  | 2        | 25   | 2        | 25   | 2        | 24   | 2        | 25   |
| 120-42  | 2        | 21   | 2        | 21   | 2        | 16   | 2        | 21   |
| 120-48  | 2        | 21   | 2        | 21   | 2        | 20   | 2        | 21   |
| 120-54  | 2        | 25   | 2        | 25   | 2        | 24   | 2        | 25   |
| 120-60  | 2        | 25   | 2        | 25   | 2        | 24   | 2        | 25   |
| 144-48  | 3        | 21   | 3        | 21   | 2        | 20   | 3        | 21   |
| 144-54  | 3        | 25   | 3        | 25   | 2        | 24   | 3        | 25   |
| 144-60  | 3        | 25   | 3        | 25   | 2        | 24   | 3        | 25   |
| 156-54  | 3        | 25   | 3        | 25   | 2        | 24   | 3        | 25   |
| 156-60  | 3        | 25   | 3        | 25   | 2        | 24   | 3        | 25   |
| 168-48  | 3        | 21   | 3        | 21   | 3        | 20   | 3        | 21   |
| 168-54  | 3        | 25   | 3        | 25   | 3        | 24   | 3        | 25   |
| 168-60  | 3        | 25   | 3        | 25   | 3        | 24   | 3        | 25   |
| 192-48  | 3        | 21   | 3        | 21   | 3        | 20   | 3        | 21   |
| 192-54  | 3        | 25   | 3        | 25   | 3        | 24   | 3        | 25   |
| 192-60  | 3        | 25   | 3        | 25   | 3        | 24   | 3        | 25   |
| 216-54  | 4        | 25   | 4        | 25   | 3        | 24   | 4        | 25   |
| 216-60  | 4        | 25   | 4        | 25   | 3        | 24   | 4        | 25   |
| 240-60  | 4        | 25   | 4        | 25   | 3        | 24   | 4        | 25   |
| 264-60  | 4        | 25   | 4        | 25   | 3        | 24   | 4        | 25   |
| 288-60  | 5        | 25   | 5        | 25   | 4        | 24   | 5        | 25   |

# NUVO | BASE REQUIREMENTS CHART

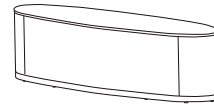
Formed Metal Base  
5141



Rectangular Island Base  
5147



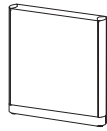
Oval Island Base  
5146



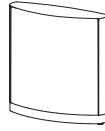
| Model#  | Quantity | Size | Quantity | Size   | Quantity | Size |
|---|----------|------|----------|--------|----------|------|
| <b>BASE REQUIREMENTS FOR RECTANGULAR (5161) &amp; ARC END (5166) TOPS</b> |          |      |          |        |          |      |
| 60-36   | 2        | 24   |          |        |          |      |
| 60-42   | 2        | 24   |          |        |          |      |
| 60-48   | 2        | 36   | 1        | 18x27  |          |      |
| 72-36   | 2        | 24   |          |        |          |      |
| 72-42   | 2        | 24   |          |        |          |      |
| 72-48   | 2        | 36   | 1        | 18x27  |          |      |
| 78-36   | 2        | 24   |          |        |          |      |
| 78-42   | 2        | 24   |          |        |          |      |
| 78-48   | 2        | 36   | 1        | 18x39  |          |      |
| 84-36   | 2        | 24   |          |        |          |      |
| 84-42   | 2        | 24   |          |        |          |      |
| 84-48   | 2        | 36   | 1        | 18x39  |          |      |
| 96-36   | 2        | 24   |          |        |          |      |
| 96-42   | 2        | 24   |          |        |          |      |
| 96-48   | 2        | 36   | 1        | 18x39  |          |      |
| 108-42  | 2        | 24   |          |        |          |      |
| 108-48  | 2        | 36   | 1        | 18x63  |          |      |
| 108-54  | 2        | 36   | 1        | 24x63  |          |      |
| 120-42  | 2        | 24   |          |        |          |      |
| 120-48  | 2        | 36   | 1        | 18x63  |          |      |
| 120-54  | 2        | 36   | 1        | 24x63  |          |      |
| 120-60  | 2        | 48   | 1        | 24x63  |          |      |
| 144-48  | 3        | 36   | 1        | 18x99  |          |      |
| 144-54  | 3        | 36   | 1        | 24x99  |          |      |
| 144-60  | 3        | 48   | 1        | 24x99  |          |      |
| 156-54  | 3        | 36   | 1        | 24x99  |          |      |
| 156-60  | 3        | 48   | 1        | 24x99  |          |      |
| 168-48  | 3        | 36   | 1        | 18x123 |          |      |
| 168-54  | 3        | 36   | 1        | 24x123 |          |      |
| 168-60  | 3        | 48   | 1        | 24x123 |          |      |
| 192-48  | 3        | 36   | 1        | 18x123 |          |      |
| 192-54  | 3        | 36   | 1        | 24x123 |          |      |
| 192-60  | 3        | 48   | 1        | 24x123 |          |      |
| 216-54  | 4        | 36   | 1        | 24x171 |          |      |
| 216-60  | 4        | 48   | 1        | 24x171 |          |      |
| 240-60  | 4        | 48   | 1        | 24x171 |          |      |
| 264-60  | 4        | 48   | 1        | 24x219 |          |      |
| 288-60  | 5        | 48   | 1        | 24x219 |          |      |

# NUVO | BASE REQUIREMENTS CHART

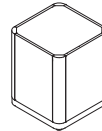
Panel Base  
5139



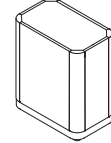
Oval Base  
5145



Square Base  
5143

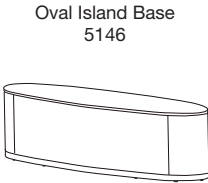
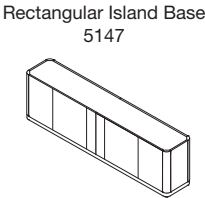


Rectangular Base  
5144



| Model#   | Quantity | Size | Quantity | Size | Quantity | Size | Quantity | Size |
|--|----------|------|----------|------|----------|------|----------|------|
| <b>BASE REQUIREMENTS FOR RACETRACK TOPS - (5102)</b> |          |      |          |      |          |      |          |      |
| 60-36  | 2        | 21   | 2        | 21   |          |      |          |      |
| 60-42  | 2        | 21   | 2        | 21   |          |      |          |      |
| 60-48  | 2        | 21   | 2        | 21   |          |      |          |      |
| 72-36  | 2        | 21   | 2        | 21   |          |      |          |      |
| 72-42  | 2        | 21   | 2        | 21   |          |      |          |      |
| 72-48  | 2        | 21   | 2        | 21   |          |      |          |      |
| 78-36  | 2        | 21   | 2        | 21   |          |      | 2        | 21   |
| 78-42  | 2        | 21   | 2        | 21   |          |      | 2        | 21   |
| 78-48  | 2        | 21   | 2        | 21   |          |      | 2        | 21   |
| 84-36  | 2        | 21   | 2        | 21   |          |      | 2        | 21   |
| 84-42  | 2        | 21   | 2        | 21   |          |      | 2        | 21   |
| 84-48  | 2        | 21   | 2        | 21   |          |      | 2        | 21   |
| 96-36  | 2        | 21   | 2        | 21   | 2        | 16   | 2        | 21   |
| 96-42  | 2        | 21   | 2        | 21   | 2        | 16   | 2        | 21   |
| 96-48  | 2        | 21   | 2        | 21   | 2        | 20   | 2        | 21   |
| 108-42   | 2        | 21   | 2        | 21   | 2        | 16   | 2        | 21   |
| 108-48   | 2        | 21   | 2        | 21   | 2        | 20   | 2        | 21   |
| 108-54   | 2        | 21   | 2        | 21   | 2        | 20   | 2        | 21   |
| 120-42   | 2        | 21   | 2        | 21   | 2        | 16   | 2        | 21   |
| 120-48   | 2        | 21   | 2        | 21   | 2        | 20   | 2        | 21   |
| 120-54   | 2        | 21   | 2        | 21   | 2        | 20   | 2        | 21   |
| 120-60   | 2        | 25   | 2        | 25   | 2        | 24   | 2        | 25   |
| 144-48   | 3        | 21   | 3        | 21   | 2        | 20   | 3        | 21   |
| 144-54   | 3        | 21   | 3        | 21   | 2        | 20   | 3        | 21   |
| 144-60   | 3        | 25   | 3        | 25   | 2        | 24   | 3        | 25   |
| 156-54   | 3        | 21   | 3        | 21   | 2        | 20   | 3        | 21   |
| 156-60   | 3        | 25   | 3        | 25   | 2        | 24   | 3        | 25   |
| 168-48   | 3        | 21   | 3        | 21   | 3        | 20   | 3        | 21   |
| 168-54   | 3        | 21   | 3        | 21   | 3        | 20   | 3        | 21   |
| 168-60   | 3        | 25   | 3        | 25   | 3        | 24   | 3        | 25   |
| 192-48   | 3        | 21   | 3        | 21   | 3        | 20   | 3        | 21   |
| 192-54   | 3        | 21   | 3        | 21   | 3        | 20   | 3        | 21   |
| 192-60   | 3        | 25   | 3        | 25   | 3        | 24   | 3        | 25   |
| 216-54   | 4        | 21   | 4        | 21   | 3        | 20   | 4        | 21   |
| 216-60   | 4        | 25   | 4        | 25   | 3        | 24   | 4        | 25   |
| 240-60   | 4        | 25   | 4        | 25   | 3        | 24   | 4        | 25   |
| 264-60   | 4        | 25   | 4        | 25   | 3        | 24   | 4        | 25   |
| 288-60   | 5        | 25   | 5        | 25   | 4        | 24   | 5        | 25   |

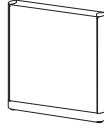
# NUVO | BASE REQUIREMENTS CHART



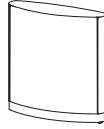
| Model#   | Quantity | Size | Quantity | Size   | Quantity | Size |
|--|----------|------|----------|--------|----------|------|
| <b>BASE REQUIREMENTS FOR RACETRACK TOPS - (5102)</b> |          |      |          |        |          |      |
| 60-36  | 2        | 24   |          |        |          |      |
| 60-42  | 2        | 24   |          |        |          |      |
| 60-48  | 2        | 36   | 1        | 18x27  |          |      |
| 72-36  | 2        | 24   |          |        |          |      |
| 72-42  | 2        | 24   |          |        |          |      |
| 72-48  | 2        | 36   | 1        | 18x27  |          |      |
| 78-36  | 2        | 24   |          |        |          |      |
| 78-42  | 2        | 24   |          |        |          |      |
| 78-48  | 2        | 36   | 1        | 18x39  |          |      |
| 84-36  | 2        | 24   |          |        |          |      |
| 84-42  | 2        | 24   |          |        |          |      |
| 84-48  | 2        | 36   | 1        | 18x39  |          |      |
| 96-36  | 2        | 24   |          |        |          |      |
| 96-42  | 2        | 24   |          |        |          |      |
| 96-48  | 2        | 36   | 1        | 18x39  |          |      |
| 108-42   | 2        | 24   |          |        |          |      |
| 108-48   | 2        | 36   | 1        | 18x63  |          |      |
| 108-54   | 2        | 36   | 1        | 18x63  |          |      |
| 120-42   | 2        | 24   |          |        |          |      |
| 120-48   | 2        | 36   | 1        | 18x63  |          |      |
| 120-54   | 2        | 36   | 1        | 18x63  |          |      |
| 120-60   | 2        | 48   | 1        | 24x63  |          |      |
| 144-48   | 3        | 36   | 1        | 18x99  |          |      |
| 144-54   | 3        | 36   | 1        | 18x99  |          |      |
| 144-60   | 3        | 48   | 1        | 24x99  |          |      |
| 156-54   | 3        | 36   | 1        | 18x99  |          |      |
| 156-60   | 3        | 48   | 1        | 24x99  |          |      |
| 168-48   | 3        | 36   | 1        | 18x123 |          |      |
| 168-54   | 3        | 36   | 1        | 18x123 |          |      |
| 168-60   | 3        | 48   | 1        | 24x123 |          |      |
| 192-48   | 3        | 36   | 1        | 18x123 |          |      |
| 192-54   | 3        | 36   | 1        | 18x123 |          |      |
| 192-60   | 3        | 48   | 1        | 24x123 |          |      |
| 216-54   | 4        | 36   | 1        | 18x171 |          |      |
| 216-60   | 4        | 48   | 1        | 24x171 |          |      |
| 240-60   | 4        | 48   | 1        | 24x171 |          |      |
| 264-60   | 4        | 48   | 1        | 24x219 |          |      |
| 288-60   | 5        | 48   | 1        | 24x219 |          |      |

# NUVO | BASE REQUIREMENTS CHART

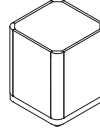
Panel Base  
5139



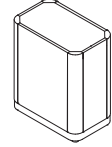
Oval Base  
5145



Square Base  
5143



Rectangular Base  
5144

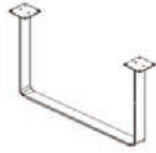


| Model#   | Quantity | Size | Quantity | Size | Quantity | Size | Quantity | Size |
|--|----------|------|----------|------|----------|------|----------|------|
| <b>BASE REQUIREMENTS FOR BOAT-SHAPED TOPS - (5164)</b> |          |      |          |      |          |      |          |      |
| 96-48-42   | 2        | 21   | 2        | 21   | 2        | 20   | 2        | 21   |
| 96-54-42   | 2        | 21   | 2        | 21   | 2        | 20   | 2        | 21   |
| 120-48-42  | 2        | 21   | 2        | 21   | 2        | 20   | 2        | 21   |
| 120-54-42  | 2        | 21   | 2        | 21   | 2        | 20   | 2        | 21   |
| 144-48-42  | 3        | 21   | 3        | 21   | 2        | 20   | 3        | 21   |
| 144-54-42  | 2        | 21   | 2        | 21   | 2        | 20   | 2        | 21   |
|  | 1        | 25   | 1        | 25   |          |      | 1        | 25   |
| 168-54-42  | 2        | 21   | 2        | 21   | 2        | 20   | 2        | 21   |
|  | 1        | 25   | 1        | 25   | 1        | 24   | 1        | 25   |
| 192-54-42  | 2        | 21   | 2        | 21   | 2        | 20   | 2        | 21   |
|  | 1        | 25   | 1        | 25   | 1        | 24   | 1        | 25   |
| 216-60-48  | 2        | 21   | 2        | 21   | 2        | 20   | 2        | 21   |
|  | 2        | 25   | 2        | 25   | 1        | 24   | 2        | 25   |
| 240-60-48  | 2        | 21   | 2        | 21   | 2        | 20   | 2        | 21   |
|  | 2        | 25   | 2        | 25   | 1        | 24   | 2        | 25   |
| 264-60-48  | 2        | 21   | 2        | 21   | 2        | 20   | 2        | 21   |
|  | 2        | 25   | 2        | 25   | 2        | 24   | 2        | 25   |
| 288-60-48  | 4        | 21   | 4        | 21   | 2        | 20   | 4        | 21   |
|  | 1        | 25   | 1        | 25   | 2        | 24   | 1        | 25   |
| <b>BASE REQUIREMENTS FOR VISIO TOPS - (5168)</b>       |          |      |          |      |          |      |          |      |
| 120-60-42  | 2        | 21   | 2        | 21   | 2        | 20   | 2        | 21   |
| 144-60-42  | 3        | 21   | 3        | 21   | 2        | 20   | 3        | 21   |
| 168-66-42  | 2        | 21   | 2        | 21   | 2        | 20   | 2        | 21   |
|  | 1        | 31   | 1        | 31   | 1        | 30   | 1        | 31   |
| 192-69-42  | 2        | 21   | 2        | 21   | 2        | 20   | 2        | 21   |
|  | 1        | 31   | 1        | 31   | 1        | 30   | 1        | 31   |
| 216-73-42  | 2        | 21   | 2        | 21   | 2        | 20   | 2        | 21   |
|  | 2        | 31   | 2        | 31   | 1        | 30   | 2        | 31   |
| 240-76-42  | 2        | 21   | 2        | 21   | 2        | 20   | 2        | 21   |
|  | 2        | 31   | 2        | 31   | 1        | 30   | 2        | 31   |

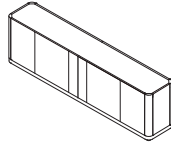


# NUVO | BASE REQUIREMENTS CHART

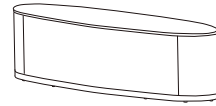
Formed Metal Base  
5141



Rectangular Island Base  
5147



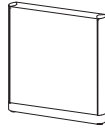
Oval Island Base  
5146



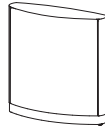
| Model#   | Quantity | Size | Quantity | Size | Quantity | Size |
|--|----------|------|----------|------|----------|------|
| <b>BASE REQUIREMENTS FOR BOAT-SHAPED TOPS - (5164)</b> |          |      |          |      |          |      |
| 96-48-42   | 2        | 36   |          |      |          |      |
| 96-54-42   | 2        | 36   |          |      |          |      |
| 120-48-42  | 2        | 24   |          |      |          |      |
| 120-54-42  | 2        | 36   |          |      |          |      |
| 144-48-42  | 2        | 24   |          |      |          |      |
|  | 1        | 36   |          |      |          |      |
| 144-54-42  | 3        | 36   |          |      |          |      |
| 168-54-42  | 3        | 36   |          |      |          |      |
| 192-54-42  | 3        | 36   |          |      |          |      |
| 216-60-48  | 2        | 36   |          |      |          |      |
|  | 2        | 48   |          |      |          |      |
| 240-60-48  | 2        | 36   |          |      |          |      |
|  | 2        | 48   |          |      |          |      |
| 264-60-48  | 2        | 36   |          |      |          |      |
|  | 2        | 48   |          |      |          |      |
| 288-60-48  | 4        | 36   |          |      |          |      |
|  | 1        | 48   |          |      |          |      |
| <b>BASE REQUIREMENTS FOR VISIO TOPS - (5168)</b>       |          |      |          |      |          |      |
| 120-60-42  | 1        | 36   |          |      |          |      |
|  | 1        | 48   |          |      |          |      |
| 144-60-42  | 1        | 24   |          |      |          |      |
|  | 1        | 36   |          |      |          |      |
|  | 1        | 48   |          |      |          |      |
| 168-66-42  | 1        | 24   |          |      |          |      |
|  | 1        | 36   |          |      |          |      |
|  | 1        | 48   |          |      |          |      |
| 192-69-42  | 1        | 24   |          |      |          |      |
|  | 1        | 36   |          |      |          |      |
|  | 1        | 48   |          |      |          |      |
| 216-73-42  | 1        | 24   |          |      |          |      |
|  | 1        | 36   |          |      |          |      |
|  | 2        | 48   |          |      |          |      |
| 240-76-42  | 1        | 24   |          |      |          |      |
|  | 1        | 36   |          |      |          |      |
|  | 2        | 48   |          |      |          |      |

# NUVO | BASE REQUIREMENTS CHART

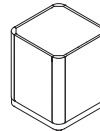
Panel Base  
5139



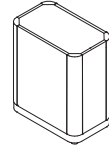
Oval Base  
5145



Square Base  
5143



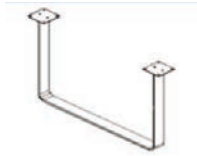
Rectangular Base  
5144



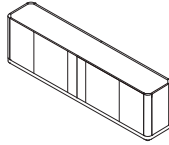
| Model#  | Quantity | Size | Quantity | Size | Quantity | Size | Quantity | Size |
|---|----------|------|----------|------|----------|------|----------|------|
| <b>BASE REQUIREMENTS FOR OVAL TOPS - (5159)</b> |          |      |          |      |          |      |          |      |
| 84-48   | 2        | 21   | 2        | 21   |          |      |          |      |
| 96-48   | 2        | 21   | 2        | 21   |          |      |          |      |
| 96-54   | 2        | 21   | 2        | 21   |          |      |          |      |
| 120-48  | 2        | 21   | 2        | 21   |          |      |          |      |
| 120-60  | 2        | 21   | 2        | 21   |          |      |          |      |
| 144-54  | 3        | 21   | 3        | 21   |          |      |          |      |
| 144-60  | 2        | 21   | 2        | 21   |          |      |          |      |
|   | 1        | 25   | 1        | 25   |          |      |          |      |
| 168-60  | 2        | 21   | 2        | 21   |          |      |          |      |
|   | 1        | 25   | 1        | 25   |          |      |          |      |

# NUVO | BASE REQUIREMENTS CHART

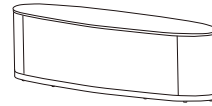
Formed Metal Base  
5141



Rectangular Island Base  
5147



Oval Island Base  
5146



| Model#  | Quantity | Size | Quantity | Size | Quantity | Size   |
|---|----------|------|----------|------|----------|--------|
| <b>BASE REQUIREMENTS FOR OVAL TOPS - (5159)</b> |          |      |          |      |          |        |
| 84-48   | 2        | 24   |          |      | 1        | 18x47  |
| 96-48   | 2        | 24   |          |      | 1        | 18x47  |
| 96-54   | 2        | 36   |          |      | 1        | 18x47  |
| 120-48  | 2        | 24   |          |      | 1        | 18x71  |
| 120-60  | 2        | 36   |          |      | 1        | 24x71  |
| 144-54  | 1        | 36   |          |      | 1        | 24x95  |
|   | 2        | 24   |          |      |          |        |
| 144-60  | 1        | 48   |          |      | 1        | 24x95  |
|   | 2        | 24   |          |      |          |        |
| 168-60  | 1        | 48   |          |      | 1        | 24x107 |
|   | 2        | 24   |          |      |          |        |

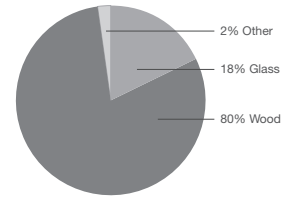
# NUVO | LEED CI CREDIT SUMMARY

LEED CI - Credit Summary

## NUVO CONFERENCE



### MATERIAL CONTENT



PRE-CONSUMER RECYCLED CONTENT - 81%

POST-CONSUMER RECYCLE CONTENT - 3%

### CONTRIBUTES TO

|                  |   |              |
|------------------|---|--------------|
| CREDIT 2.1 - 2.2 | Construction Waste Management                   | 1-2 point(s) |
| CREDIT 4.1       | Recycled Content                                | 1 point      |
| CREDIT 4.2       | Recycled Content                                | 1 point      |
| CREDIT 4.5       | Low Emitting Materials, (MUST BE REQUESTED)     |              |
|                  | Composite Wood & Laminate Adhesives             | 1 point      |
| CREDIT 5.1       | Regional Materials*                             | 1 point      |
| CREDIT 6         | Rapidly Renewable Materials (MUST BE REQUESTED) | 1 point      |
| CREDIT 7         | Certified Wood (MUST BE REQUESTED)              | 1 point      |

\* This credit is only applicable if in total 20% of the combined value of the procurement of construction materials and in the furniture are manufactured within a radius of 500 miles. This credit will apply if the installation of the finished product occurs within 500 miles of Kitchener, Ontario.

Nuvo Media & Storage products compliment Nuvo Conference with 6 veneer species selections. Veneered tops are 1 1/2" thick veneered particle board core and backer material, with a 1/8" wood edge. Laminate tops are 1 1/2" thick with particle board core and backer material, with a matching laminate edge. Glass tops are back painted tempered glass with an 1 1/8" medium density fiberboard painted sub top with bevelled edge. Tops are available with these profiles.



Edge profile for wood & laminate tops



Edge profile for glass tops

## SURFACES

Buffet and Credenza tops are 1 1/2" thick 45lbs per cubic feet particle board core, 3 ply. Gables are 3/4" thick 45lbs per cubic feet particle board core, 3 ply.

## VENEER

Veneers available are Rift White Oak, Quarter Cut Maple, Quarter Cut Cherry, Quarter Cut Walnut

## LAMINATE

Please note the grain direction of wood grain laminate will run horizontal on the backs of credenzas and buffets. Laminate tops are 1 1/2" thick with particle board core and backer material, with a matching laminate edge.

## FINISH

A five step catalyzed varnish finish that when dry has a sheen value of 32°, is applied to all tables, bases and cases. A lower sheen topcoat, 20°, can also be specified, at standard pricing. All purchase orders must clearly note "lower sheen finish" in order to receive this optional selection.

All finished surfaces are well sanded before applying finishing materials. The procedure begins by applying a base color via an NGR stain. A wash coat follows to further enhance the color. Next is the glazing process, which provides the 3rd color step and fills the pores of the wood. A sealer coat is then applied, twice to the horizontal worksurfaces to enhance the finish. The product is then scuff sanded to prepare for the top coat. The top coat is a catalyzed varnish that when dry has a sheen value of 32°. Krug's catalyzed varnish has been tested to be one of the industry's most durable and long lasting. Custom finishes are available

## GLIDES

Credenzas and Buffets feature adjustable glides 1 1/2" long and allow for a range of adjustment of 3/4".

## GLASS SURFACE

Nuvo Casegood tops are available in white back-painted 10mm tempered glass. Please contact customer service, for additional color selections available at no upcharge.

## TESTING

All products have been tested in accordance with ANSI/BIFMA X5.5-2014 or X5.9-2012.

## DRAWERS

Desk box drawers have full progressive full extension slides and are load rated at 100lbs. per drawer. All drawer interiors are veneer on plywood, and include a push to open drawer mechanism.

## LATCHES

Doors open with a touch latch. There are no pulls on Nuvo Media & Storage.

## HINGES

Nuvo Media & Storage utilize European style satin chrome hinges with 3-way adjustment & quick release feature. Hinge opening is 95 degrees.

## CASTERS

Locking casters are standard on the Hospitality Cart and lectern.

## SLIDING DOORS

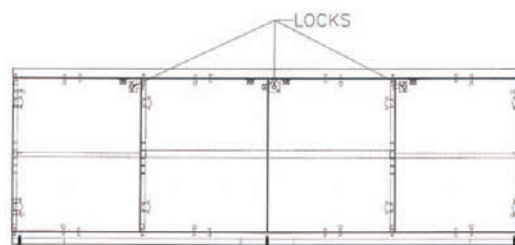
Sliding Doors include a single roller track system.

## BACK-PAINTED GLASS DOORS

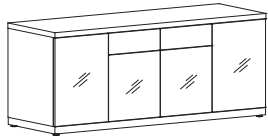
Nuvo glass doors have Back-Painted glass with a satin aluminum frame.

## LOCKS

Locks are optional on hinged wood doors at an upcharge of **\$152 list** per set of 2 doors and **\$152 list** per single door. Buffets and Credenzas with 2 outside doors require 3 locks.

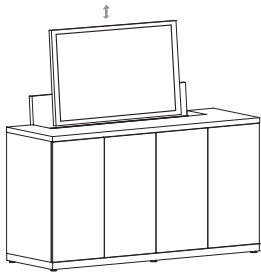
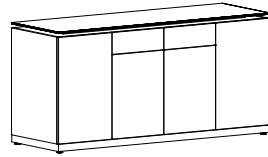


# NUVO | FEATURES & OPTIONS



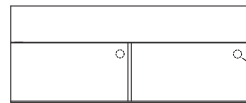
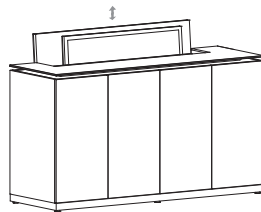
## CREDENZAS AND BUFFETS

- 2 styles of cabinet tops are available: wood top and Back-Painted glass tops.
- Doors are available in Back-Painted glass & wood veneer.
- Storage sections feature one wooden shelf which is height adjustable in increments of 1 1/4".
- Buffets with wood drawers can include an optional cutlery insert.
- Buffet may be specified with optional Recycle/Waste bin.
- Buffet may be specified with optional Mini Refrigerator on 24" deep Buffets at a price of **\$2638 list**.
- Mini refrigerator features volume of 1.1 cu. ft., 2 inner door racks, automatic defrost, and lock.
- Credenzas and Buffets with glass tops are shipped with tops assembled to case.



## TV CABINET WITH LIFT

- Accommodate flat screen televisions up to 130lbs with dimensions no greater than 51 1/4"W x 4 3/4"D x 30"H
- Cabinet is standard with 4 shelves 12 1/2" deep.
- Includes a remote control to raise and lower the television. Remote has a radio frequency control with 15 ft. operating distance
- 2 styles of cabinet tops are available: wood top and Back-Painted glass tops.
- Cable access in shelves and partition

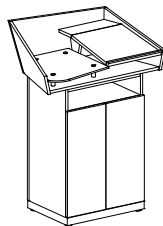


Grommet in each shelf & partition for cord pass through

GROMMET IN EACH SHELF FOR CORD PASS THROUGH

## HOSPITALITY CARTS

- The cart is mounted on heavy-duty locking casters.
- A handle on each end facilitates movement of the cart. Handles are available in a satin aluminum finish.
- The cart features a stainless steel container with removable plastic garbage & recycling bins. A cutlery tray is included.
- 2 styles of cabinet tops are available: wood top and Back-Painted glass tops.
- 2 adjustable shelves behind large door



## LECTERNS

- Glass shelf version has a wood upper flat shelf which provides a place for pens, pencils or a glass of water, and optional reference light at a price of **\$443 list**. It will also accommodate a user-specified microphone.
- Angled wood shelf has a bottom lip to hold papers in place. The shelf lifts to reveal an optional power and data interface point
- Back-Painted glass shelf provides more surface area for equipment such as a laptop. A presenter's open laptop is not visible to the seated audience.
- Cables from the interface point, (or user supplied cables) are routed down through grommeted holes to the bottom of the unit and are accessible via doors on the users side. Optional power bar at a price of **\$208 list**.
- Full width shelf version is available.
- Mobile versions are available.
- Glass shelf is shipped installed.

# NUVO | FEATURES & OPTIONS



## BASE PLATES

- Available in a choice of Wood, Laminate, or Gloss Aluminum finish.



## RECYCLE/WASTE BIN

- Stainless Steel sliding bin containing 2 x 14 L plastic bins for recycling and waste. Opens with the door.
- Approximate dimensions 14.25 x 17.33 x 16.53



## BACK-PAINTED GLASS TOPS

- Back-Painted glass tops are 10mm thick and available as an option.



## CUTLERY TRAY

- Surface silver grained
- Impact-resistant polystyrene
- Environmentally friendly, fully recyclable
- Antistatic, easy to clean

## ALTINEX BOX

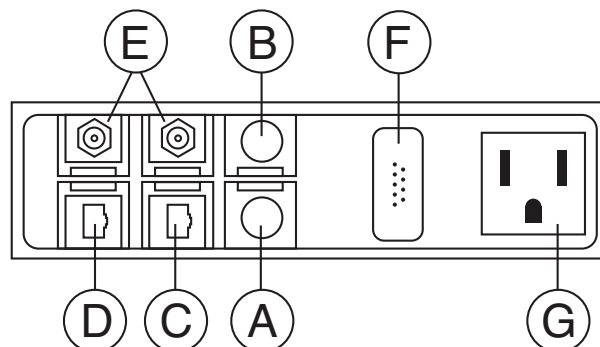
The Altinex box offers an ideal solution for the power and data requirements of a speaker using the NUVO Lectern.

Altinex features the following power/data connectors:

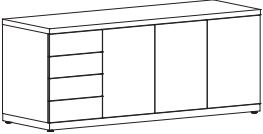
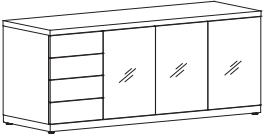
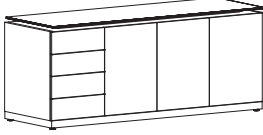
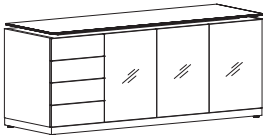
|   |                        |  |
|---|------------------------|--|
| A | (1) Stereo Mini        | 3.5 mm Mini pass-through connector from computer sound card to amplified sound system                              |
| B | (1) BNC port           | High quality pass-through connector from broadcast video or computer video to video display monitor                |
| C | (1) RJ11 port          | Connection for Telephone / Modem   |
| D | (1) RJ45 port          | Connection for Network Connector   |
| E | (2) RCA ports          | Female RCA type pass-through (Left - Black, Right - Red) cable connectors from stereo audio source to audio system |
| F | (1) 15 Pin HD port     | VGA type 15 pin pass-through connector from computer video to display monitor                                      |
| G | (1) Simplex Power port | Power Input  |

For more information or questions regarding the Altinex Box, please contact Krug Customer Service or Altinex Technical Support at 1-800-258-4623.

This option is available on NUVO lecterns at an upcharge of **\$1273 list**.



# NUVO | CREDENZAS

| Description  | Model          | Oak      | Cherry | Maple | W    | D  | H    | Weight | Cube |
|--|----------------|----------|--------|-------|------|----|------|--------|------|
|  |                | Laminate | Walnut |       |      |    |      |        |      |
|  3 Hinged Doors, 4 Drawers                                     | 51C72202907    | 5955     | 6550   |       | 71.5 | 20 | 29.9 | 309    | 31   |
|  | 51C72242907    | 6237     | 6861   |       | 71.5 | 24 | 29.9 | 321    | 36   |
|  | 51C84202907    | 6846     | 7532   |       | 83.5 | 20 | 29.9 | 360    | 36   |
|  | 51C84242907    | 7173     | 7889   |       | 83.5 | 24 | 29.9 | 374    | 42   |
|  Back-Painted Glass Doors, 4 Drawers                           | 51C72202907Z   | 7498     | 8249   |       | 71.5 | 20 | 29.9 | 323    | 31   |
|  | 51C72242907Z   | 7781     | 8559   |       | 71.5 | 24 | 29.9 | 383    | 36   |
|  | 51C84202907Z   | 8622     | 9486   |       | 83.5 | 20 | 29.9 | 376    | 36   |
|  | 51C84242907Z   | 8947     | 9841   |       | 83.5 | 24 | 29.9 | 446    | 42   |
|  3 Hinged Doors, 4 Drawers, Back-Painted Glass Top            | 51CGP72202907  | 8856     | 9739   |       | 71.5 | 20 | 29.9 | 349    | 31   |
|  | 51CGP72242907  | 9719     | 10691  |       | 71.5 | 24 | 29.9 | 369    | 36   |
|  | 51CGP84202907  | 10182    | 11199  |       | 83.5 | 20 | 29.9 | 406    | 36   |
|  | 51CGP84242907  | 11174    | 12291  |       | 83.5 | 24 | 29.9 | 429    | 42   |
|  Back-Painted Glass Doors, 4 Drawers, Back-Painted Glass Top | 51CGP72202907Z | 10399    | 11438  |       | 71.5 | 20 | 29.9 | 363    | 31   |
|  | 51CGP72242907Z | 11262    | 12388  |       | 71.5 | 24 | 29.9 | 383    | 36   |
|  | 51CGP84202907Z | 11958    | 13153  |       | 83.5 | 20 | 29.9 | 423    | 36   |
|  | 51CGP84242907Z | 12951    | 14246  |       | 83.5 | 24 | 29.9 | 446    | 42   |

**ORDERING NOTES:** An optional Recycle/Waste bin, located behind the right door, is available at an upcharge of **\$571 list**, add W - Waste Bin to the model number. An optional Cutlery Tray is available at an upcharge of **\$61 list**. An optional mini fridge, located behind the right door, is available on 24" deep units at an upcharge of **\$2638 list**, add F - fridge to model number.

## ORDERING PROCEDURE

To order, please specify the following:

- 1) Krug product model number
- 2) Wood species and finish

## CODE DESCRIPTION

- GP - Back-Painted Glass Top  
Z - Back-Painted Glass Doors

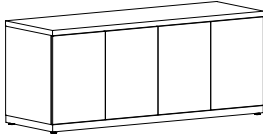
## STANDARD FINISHES

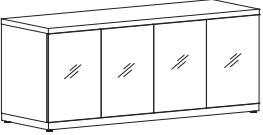
For a complete list of standard wood finishes, please see page 347

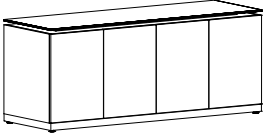
## BASE PLATES

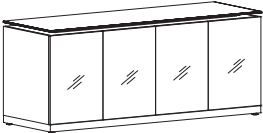
Base plates are available in Gloss Aluminum, Laminate or Wood, please specify requirement on order.



| Description   | Model       | Oak<br>Cherry<br>Maple<br>Laminate |      | W    | D  | H    | Weight | Cube |
|---|-------------|------------------------------------|------|------|----|------|--------|------|
|   |             | Walnut                             |      |      |    |      |        |      |
| <br>4 Hinged Doors | 51C72202911 | 4967                               | 5464 | 71.5 | 20 | 29.9 | 265    | 31   |
|   | 51C72242911 | 5248                               | 5775 | 71.5 | 24 | 29.9 | 277    | 36   |
|   | 51C84202911 | 5713                               | 6284 | 83.5 | 20 | 29.9 | 309    | 36   |
|   | 51C84242911 | 6036                               | 6641 | 83.5 | 24 | 29.9 | 323    | 42   |

|   |              |      |      |      |    |      |     |    |
|---|--------------|------|------|------|----|------|-----|----|
| <br>4 Hinged Back-Painted<br>Glass Doors | 51C72202911Z | 7024 | 7730 | 71.5 | 20 | 29.9 | 283 | 31 |
|   | 51C72242911Z | 7310 | 8040 | 71.5 | 24 | 29.9 | 295 | 36 |
|   | 51C84202911Z | 8079 | 8888 | 83.5 | 20 | 29.9 | 330 | 36 |
|   | 51C84242911Z | 8405 | 9245 | 83.5 | 24 | 29.9 | 344 | 42 |

|  |               |       |       |      |    |      |     |    |
|--|---------------|-------|-------|------|----|------|-----|----|
| <br>4 Hinged Doors, Back-<br>Painted Glass Top | 51CGP72202911 | 7866  | 8654  | 71.5 | 20 | 29.9 | 305 | 31 |
|  | 51CGP72242911 | 8731  | 9604  | 71.5 | 24 | 29.9 | 325 | 36 |
|  | 51CGP84202911 | 9048  | 9952  | 83.5 | 20 | 29.9 | 355 | 36 |
|  | 51CGP84242911 | 10042 | 11044 | 83.5 | 24 | 29.9 | 379 | 42 |

|  |                |       |       |      |    |      |     |    |
|--|----------------|-------|-------|------|----|------|-----|----|
| <br>4 Hinged Back-Painted<br>Glass Doors, Back-Painted<br>Glass Top | 51CGP72202911Z | 9928  | 10918 | 71.5 | 20 | 29.9 | 323 | 31 |
|  | 51CGP72242911Z | 10790 | 11870 | 71.5 | 24 | 29.9 | 343 | 36 |
|  | 51CGP84202911Z | 11415 | 12556 | 83.5 | 20 | 29.9 | 376 | 36 |
|  | 51CGP84242911Z | 12408 | 13648 | 83.5 | 24 | 29.9 | 400 | 42 |

**ORDERING NOTES:** An optional Recycle/Waste bin is available at an upcharge of **\$571 list**, add WL - Waste Bin Left or WR - Waste Bin Right to the model number.

An optional mini fridge is available on 24" deep units, at an upcharge of **\$2638**, add FL fridge left or FR fridge right to model number.

**DIMENSION KEY**

W - width  
D - depth  
H - height

**CODE DESCRIPTION**

GP - Back-Painted Glass Top  
Z - Back-Painted Glass Doors

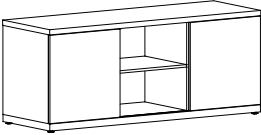
**STANDARD FINISHES**

For a complete list of standard wood finishes, please see page 347

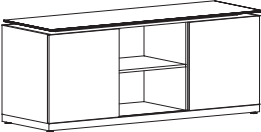
**BASE PLATES**

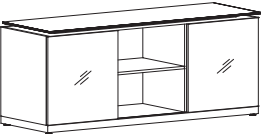
Base plates are available in Gloss Aluminum, Laminate or Wood, please specify requirement on order.

# NUVO | CREDENZAS

| Description   | Model        | Oak<br>Cherry<br>Maple<br>Laminate |      |      | W  | D    | H   | Weight | Cube |
|---|--------------|------------------------------------|------|------|----|------|-----|--------|------|
|   |              | Walnut                             |      |      |    |      |     |        |      |
|  | 51CS72202911 | 5488                               | 6036 | 71.5 | 20 | 29.9 | 246 | 31     |      |
|   | 51CS72242911 | 5769                               | 6347 | 71.5 | 24 | 29.9 | 258 | 36     |      |
|   | 51CS84202911 | 6312                               | 6941 | 83.5 | 20 | 29.9 | 287 | 36     |      |
|   | 51CS84242911 | 6634                               | 7298 | 83.5 | 24 | 29.9 | 301 | 42     |      |

|   |               |      |      |      |    |      |     |    |
|---|---------------|------|------|------|----|------|-----|----|
|  | 51CS72202911Z | 6863 | 7549 | 71.5 | 20 | 29.9 | 259 | 31 |
|   | 51CS72242911Z | 7147 | 7862 | 71.5 | 24 | 29.9 | 271 | 36 |
|   | 51CS84202911Z | 7893 | 8681 | 83.5 | 20 | 29.9 | 302 | 36 |
|   | 51CS84242911Z | 8219 | 9040 | 83.5 | 24 | 29.9 | 316 | 42 |

|  |                |       |       |      |    |      |     |    |
|--|----------------|-------|-------|------|----|------|-----|----|
|  | 51CSGP72202911 | 8389  | 9225  | 71.5 | 20 | 29.9 | 286 | 31 |
|  | 51CSGP72242911 | 9252  | 10177 | 71.5 | 24 | 29.9 | 306 | 36 |
|  | 51CSGP84202911 | 9646  | 10612 | 83.5 | 20 | 29.9 | 333 | 36 |
|  | 51CSGP84242911 | 10638 | 11704 | 83.5 | 24 | 29.9 | 356 | 42 |

|   |                 |       |       |      |    |      |     |    |
|---|-----------------|-------|-------|------|----|------|-----|----|
|  | 51CSGP72202911Z | 9763  | 10741 | 71.5 | 20 | 29.9 | 299 | 31 |
|   | 51CSGP72242911Z | 10629 | 11691 | 71.5 | 24 | 29.9 | 319 | 36 |
|   | 51CSGP84202911Z | 11379 | 12518 | 83.5 | 20 | 29.9 | 348 | 36 |
|   | 51CSGP84242911Z | 12222 | 13445 | 83.5 | 24 | 29.9 | 372 | 42 |

**ORDERING NOTES:** An optional mini fridge is available on 24" deep units, at an upcharge of **\$2638**, add FL fridge left or FR fridge right to model number.

## ORDERING PROCEDURE

To order, please specify the following:  
 1) Krug product model number  
 2) Wood species and finish

## CODE DESCRIPTION

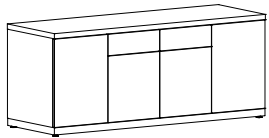
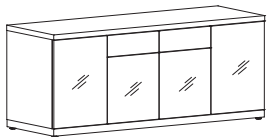
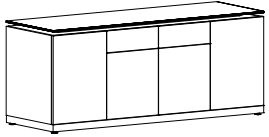
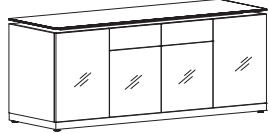
GP - Back-Painted Glass Top  
 Z - Back-Painted Glass Doors

## STANDARD FINISHES

For a complete list of standard wood finishes, please see page 347.

## BASE PLATES

Base plates are available in Gloss Aluminum, Laminate or Wood, please specify requirement on order.

| Description   | Model   | Oak<br>Cherry<br>Maple<br>Laminate | Walnut | W     | D    | H  | Weight | Cube |    |
|---|---|------------------------------------|--------|-------|------|----|--------|------|----|
|    | Door, Drawer/Door,<br>Drawer/Door, Door   | 51C72202914                        | 6044   | 6647  | 71.5 | 20 | 29.9   | 277  | 31 |
|   |   | 51C72242914                        | 6325   | 6959  | 71.5 | 24 | 29.9   | 289  | 36 |
|   |   | 51C84202914                        | 6948   | 7645  | 83.5 | 20 | 29.9   | 323  | 36 |
|   |   | 51C84242914                        | 7273   | 8002  | 83.5 | 24 | 29.9   | 337  | 42 |
|    | Back-Painted Glass Door,<br>Drawer/Door, Drawer/Door,<br>Door                         | 51C72202914Z                       | 7934   | 8727  | 71.5 | 20 | 29.9   | 295  | 31 |
|   |   | 51C72242914Z                       | 8217   | 9038  | 71.5 | 24 | 29.9   | 317  | 36 |
|   |   | 51C84202914Z                       | 9123   | 10035 | 83.5 | 20 | 29.9   | 344  | 36 |
|   |   | 51C84242914Z                       | 9447   | 10392 | 83.5 | 24 | 29.9   | 369  | 42 |
|   | Door, Drawer/Door,<br>Drawer/Door, Door,<br>Back-Painted Glass Top                    | 51CGP72202914                      | 8942   | 9838  | 71.5 | 20 | 29.9   | 317  | 31 |
|   |   | 51CGP72242914                      | 9808   | 10787 | 71.5 | 24 | 29.9   | 337  | 36 |
|   |   | 51CGP84202914                      | 10285  | 11313 | 83.5 | 20 | 29.9   | 369  | 36 |
|   |   | 51CGP84242914                      | 11279  | 12405 | 83.5 | 24 | 29.9   | 393  | 42 |
|  | Back-Painted Glass Door,<br>Drawer/Door, Drawer/Door,<br>Door, Back-Painted Glass Top | 51CGP72202914Z                     | 10834  | 11917 | 71.5 | 20 | 29.9   | 335  | 31 |
|   |   | 51CGP72242914Z                     | 11699  | 12866 | 71.5 | 24 | 29.9   | 365  | 36 |
|   |   | 51CGP84202914Z                     | 12460  | 13707 | 83.5 | 20 | 29.9   | 390  | 36 |
|   |   | 51CGP84242914Z                     | 13454  | 14798 | 83.5 | 24 | 29.9   | 425  | 42 |

**ORDERING NOTES:** An optional Recycle/Waste bin is available at an upcharge of **\$571 list**, add WL - Waste Bin Left or WR - Waste Bin Right to the model number. An optional Cutlery Tray is available at an upcharge of **\$61 list**. Mini fridge is not available in this configuration.

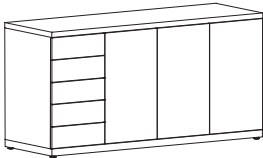
**DIMENSION KEY**  
W - width  
D - depth  
H - height

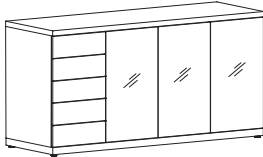
**CODE DESCRIPTION**  
GP - Back-Painted Glass Top  
Z - Back-Painted Glass Doors

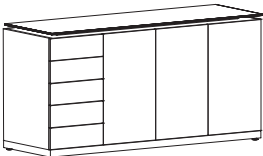
**STANDARD FINISHES**  
For a complete list of standard wood finishes, please see page 347.

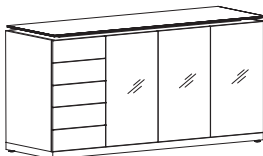
**BASE PLATES**  
Base plates are available in Gloss Aluminum, Laminate or Wood, please specify requirement on order.

# NUVO | BUFFETS

| Description  | Model        | Oak<br>Cherry<br>Maple<br>Laminate |      |      | W  | D  | H   | Weight | Cube |
|--|--------------|------------------------------------|------|------|----|----|-----|--------|------|
|  |              | Walnut                             |      |      |    |    |     |        |      |
|  | 51BU72203507 | 6367                               | 7005 | 71.5 | 20 | 35 | 330 | 36     |      |
|  | 51BU72243507 | 6652                               | 7316 | 71.5 | 24 | 35 | 343 | 42     |      |
|  | 51BU84203507 | 7323                               | 8057 | 83.5 | 20 | 35 | 384 | 42     |      |
|  | 51BU84243507 | 7649                               | 8413 | 83.5 | 24 | 35 | 400 | 49     |      |

|  |               |      |       |      |    |    |     |    |
|--|---------------|------|-------|------|----|----|-----|----|
|  | 51BU72203507Z | 7911 | 8703  | 71.5 | 20 | 35 | 345 | 36 |
|  | 51BU72243507Z | 8195 | 9013  | 71.5 | 24 | 35 | 358 | 42 |
|  | 51BU84203507Z | 9097 | 10007 | 83.5 | 20 | 35 | 402 | 42 |
|  | 51BU84243507Z | 9423 | 10367 | 83.5 | 24 | 35 | 417 | 49 |

|   |                |       |       |      |    |    |     |    |
|---|----------------|-------|-------|------|----|----|-----|----|
|  | 51BUGP72203507 | 9269  | 10196 | 71.5 | 20 | 35 | 370 | 36 |
|   | 51BUGP72243507 | 10132 | 11144 | 71.5 | 24 | 35 | 391 | 42 |
|   | 51BUGP84203507 | 10659 | 11724 | 83.5 | 20 | 35 | 431 | 42 |
|   | 51BUGP84243507 | 11653 | 12818 | 83.5 | 24 | 35 | 455 | 49 |

|  |                 |       |       |      |    |    |     |    |
|--|-----------------|-------|-------|------|----|----|-----|----|
|  | 51BUGP72203507Z | 10812 | 11893 | 71.5 | 20 | 35 | 385 | 36 |
|  | 51BUGP72243507Z | 11676 | 12845 | 71.5 | 24 | 35 | 406 | 42 |
|  | 51BUGP84203507Z | 12433 | 13676 | 83.5 | 20 | 35 | 448 | 42 |
|  | 51BUGP84243507Z | 13430 | 14771 | 83.5 | 24 | 35 | 473 | 49 |

**ORDERING NOTES:** An optional Recycle/Waste bin, located behind the right door, is available at an upcharge of **\$571 list**, add W - Waste Bin to the model number. An optional Cutlery Tray is available at an upcharge of **\$61 list**. An optional mini fridge, located behind the right door, is available on 24" deep units at an upcharge of **\$2638**, add F - fridge to model number.

## ORDERING PROCEDURE

To order, please specify the following:  
 1) Krug product model number  
 2) Wood species and finish

## CODE DESCRIPTION

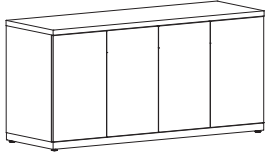
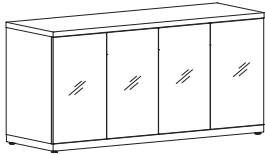
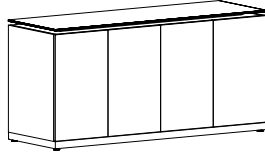
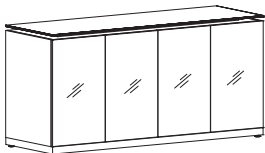
GP - Back-Painted Glass Top  
 Z - Back-Painted Glass Doors

## STANDARD FINISHES

For a complete list of standard wood finishes, please see page 347.

## BASE PLATES

Base plates are available in Gloss Aluminum, Laminate or Wood, please specify requirement on order.

| Description  | Model           | Oak<br>Cherry<br>Maple<br>Laminate |       | W    | D  | H  | Weight | Cube |
|--|-----------------|------------------------------------|-------|------|----|----|--------|------|
|  |                 | Walnut                             |       |      |    |    |        |      |
| 4 Hinged Doors<br><br>  | 51BU72203511    | 5137                               | 5649  | 71.5 | 20 | 35 | 266    | 36   |
|  | 51BU72243511    | 5419                               | 5961  | 71.5 | 24 | 35 | 279    | 42   |
|  | 51BU84203511    | 5905                               | 6496  | 83.5 | 20 | 35 | 310    | 42   |
|  | 51BU84243511    | 6230                               | 6855  | 83.5 | 24 | 35 | 325    | 49   |
| 4 Hinged Back-Painted<br>Glass Doors<br><br>                              | 51BU72203511Z   | 7193                               | 7913  | 71.5 | 20 | 35 | 286    | 36   |
|  | 51BU72243511Z   | 7478                               | 8225  | 71.5 | 24 | 35 | 299    | 42   |
|  | 51BU84203511Z   | 8275                               | 9100  | 83.5 | 20 | 35 | 333    | 42   |
|  | 51BU84243511Z   | 8597                               | 9459  | 83.5 | 24 | 35 | 348    | 49   |
| 4 Hinged Doors, Back-<br>Painted Glass Top<br><br>                       | 51BUGP72203511  | 8037                               | 8839  | 71.5 | 20 | 35 | 306    | 36   |
|  | 51BUGP72243511  | 8899                               | 9790  | 71.5 | 24 | 35 | 327    | 42   |
|  | 51BUGP84203511  | 9241                               | 10167 | 83.5 | 20 | 35 | 356    | 42   |
|  | 51BUGP84243511  | 10235                              | 11259 | 83.5 | 24 | 35 | 381    | 49   |
| 4 Hinged Back-Painted<br>Glass Doors, Back-Painted<br>Glass Top<br><br> | 51BUGP72203511Z | 10094                              | 11110 | 71.5 | 20 | 35 | 326    | 36   |
|  | 51BUGP72243511Z | 10959                              | 12056 | 71.5 | 24 | 35 | 347    | 42   |
|  | 51BUGP84203511Z | 11610                              | 12771 | 83.5 | 20 | 35 | 380    | 42   |
|  | 51BUGP84243511Z | 12604                              | 13861 | 83.5 | 24 | 35 | 404    | 49   |

**ORDERING NOTES:** An optional Recycle/Waste bin, located behind the right door, is available at an upcharge of **\$571 list**, add W - Waste Bin to the model number. An optional Cutlery Tray is available at an upcharge of **\$61 list**. An optional mini fridge, located behind the right door, is available on 24" deep units at an upcharge of **\$2638**, add F - fridge to model number.

**DIMENSION KEY**

W - width  
D - depth  
H - height

**CODE DESCRIPTION**

GP - Back-Painted Glass Top  
Z - Back-Painted Glass Doors

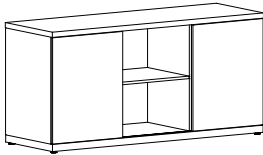
**STANDARD FINISHES**

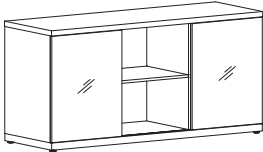
For a complete list of standard wood finishes, please see page 347.

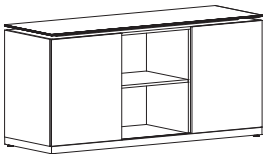
**BASE PLATES**

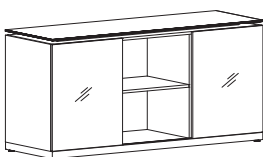
Base plates are available in Gloss Aluminum, Laminate or Wood, please specify requirement on order.

# NUVO | BUFFETS

| Description  | Model         | Oak   | Cherry   | Walnut | W  | D  | H   | Weight | Cube |
|--|---------------|-------|----------|--------|----|----|-----|--------|------|
|  |               | Maple | Laminate |        |    |    |     |        |      |
|  | 51BUS72203511 | 5657  | 6222     | 71.5   | 20 | 35 | 252 | 36     |      |
|  | 51BUS72243511 | 5939  | 6534     | 71.5   | 24 | 35 | 265 | 42     |      |
|  | 51BUS84203511 | 6505  | 7155     | 83.5   | 20 | 35 | 294 | 42     |      |
|  | 51BUS84243511 | 6831  | 7513     | 83.5   | 24 | 35 | 309 | 49     |      |

|  |                |      |      |      |    |    |     |    |
|--|----------------|------|------|------|----|----|-----|----|
|  | 51BUS72203511Z | 7199 | 7920 | 71.5 | 20 | 35 | 267 | 36 |
|  | 51BUS72243511Z | 7484 | 8232 | 71.5 | 24 | 35 | 280 | 42 |
|  | 51BUS84203511Z | 8280 | 9109 | 83.5 | 20 | 35 | 311 | 42 |
|  | 51BUS84243511Z | 8607 | 9467 | 83.5 | 24 | 35 | 326 | 49 |

|   |                 |       |       |      |    |    |     |    |
|---|-----------------|-------|-------|------|----|----|-----|----|
|  | 51BUSGP72203511 | 8556  | 9412  | 71.5 | 20 | 35 | 292 | 36 |
|   | 51BUSGP72243511 | 9419  | 10363 | 71.5 | 24 | 35 | 313 | 42 |
|   | 51BUSGP84203511 | 9840  | 10826 | 83.5 | 20 | 35 | 340 | 42 |
|   | 51BUSGP84243511 | 10834 | 11917 | 83.5 | 24 | 35 | 365 | 49 |

|  |                  |       |       |      |    |    |     |    |
|--|------------------|-------|-------|------|----|----|-----|----|
|  | 51BUSGP72203511Z | 10101 | 11110 | 71.5 | 20 | 35 | 307 | 36 |
|  | 51BUSGP72243511Z | 10964 | 12062 | 71.5 | 24 | 35 | 328 | 42 |
|  | 51BUSGP84203511Z | 11617 | 12778 | 83.5 | 20 | 35 | 358 | 42 |
|  | 51BUSGP84243511Z | 12610 | 13873 | 83.5 | 24 | 35 | 382 | 49 |

**ORDERING NOTES:** An optional mini fridge is available on 24" deep units at an upcharge of **\$2638**, add FL fridge left or FR fridge right to model number.

## ORDERING PROCEDURE

To order, please specify the following:

- 1) Krug product model number
- 2) Wood species and finish

## CODE DESCRIPTION

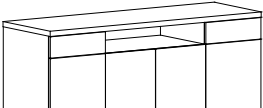
- GP - Back-Painted Glass Top  
Z - Back-Painted Glass Doors

## STANDARD FINISHES

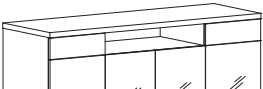
For a complete list of standard wood finishes, please see page 347.

## BASE PLATES

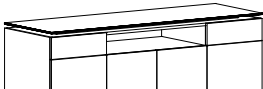
Base plates are available in Gloss Aluminum, Laminate or Wood, please specify requirement on order.

| Description  | Model        | Oak   | Cherry   | Walnut | W    | D  | H  | Weight | Cube |
|--|--------------|-------|----------|--------|------|----|----|--------|------|
|  |              | Maple | Laminate |        |      |    |    |        |      |
|  Drawer/Door, Open/<br>2 Doors, Drawer/Door | 51BU72203513 | 6211  | 6833     | 6833   | 71.5 | 20 | 35 | 294    | 36   |
|  | 51BU72243513 | 6495  | 7145     | 7145   | 71.5 | 24 | 35 | 307    | 42   |
|  | 51BU84203513 | 7145  | 7860     | 7860   | 83.5 | 20 | 35 | 342    | 42   |
|  | 51BU84243513 | 7467  | 8215     | 8215   | 83.5 | 24 | 35 | 358    | 49   |

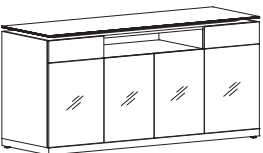
**NOTE:** For Media Buffet version with vents & cable access add M to model number and **\$530 list.**

|   |               |      |       |       |      |    |    |     |    |
|---|---------------|------|-------|-------|------|----|----|-----|----|
|  Back-Painted Glass<br>Drawer/Door, Open/2 Doors,<br>Drawer/Door | 51BU72203513Z | 8269 | 9096  | 9096  | 71.5 | 20 | 35 | 313 | 36 |
|   | 51BU72243513Z | 8553 | 9410  | 9410  | 71.5 | 24 | 35 | 326 | 42 |
|   | 51BU84203513Z | 9511 | 10463 | 10463 | 83.5 | 20 | 35 | 365 | 42 |
|   | 51BU84243513Z | 9836 | 10818 | 10818 | 83.5 | 24 | 35 | 380 | 49 |

**NOTE:** For Media Buffet version with vents & cable access add M to model number and **\$530 list.**

|  |                |       |       |       |      |    |    |     |    |
|--|----------------|-------|-------|-------|------|----|----|-----|----|
|  Drawer/Door, Open/<br>2 Doors, Drawer/Door,<br>Back-Painted Glass Top | 51BUGP72203513 | 9114  | 10022 | 10022 | 71.5 | 20 | 35 | 334 | 36 |
|  | 51BUGP72243513 | 9975  | 10975 | 10975 | 71.5 | 24 | 35 | 355 | 42 |
|  | 51BUGP84203513 | 10481 | 11527 | 11527 | 83.5 | 20 | 35 | 389 | 42 |
|  | 51BUGP84243513 | 11472 | 12618 | 12618 | 83.5 | 24 | 35 | 413 | 49 |

**NOTE:** For Media Buffet version with vents & cable access add M to model number and **\$530 list.**

|  |                 |       |       |       |      |    |    |     |    |
|--|-----------------|-------|-------|-------|------|----|----|-----|----|
|  Back-Painted Glass<br>Drawer/Door, Open/2 Doors,<br>Drawer/Door, Back-Painted<br>Glass Top | 51BUGP72203513Z | 11170 | 12287 | 12287 | 71.5 | 20 | 35 | 353 | 36 |
|  | 51BUGP72243513Z | 12035 | 13240 | 13240 | 71.5 | 24 | 35 | 374 | 42 |
|  | 51BUGP84203513Z | 12846 | 14130 | 14130 | 83.5 | 20 | 35 | 411 | 42 |
|  | 51BUGP84243513Z | 13842 | 15222 | 15222 | 83.5 | 24 | 35 | 436 | 49 |

**NOTE:** For Media Buffet version with vents & cable access add M to model number and **\$530 list.**

**ORDERING NOTES:** An optional Recycle/Waste bin, located behind the right door, is available at an upcharge of **\$571 list**, add W - Waste Bin to the model number. An optional Cutlery Tray is available at an upcharge of **\$61 list**. An optional mini fridge, located behind the right door, is available on 24" deep units at an upcharge of **\$2638**, add F - fridge to model number.

**DIMENSION KEY**

W - width  
D - depth  
H - height

**CODE DESCRIPTION**

GP - Back-Painted Glass Top  
Z - Back-Painted Glass Doors

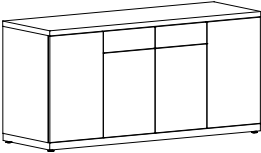
**STANDARD FINISHES**

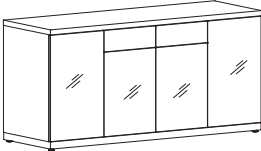
For a complete list of standard wood finishes, please see page 347.

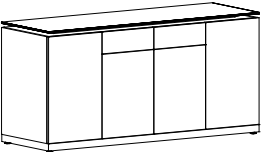
**BASE PLATES**

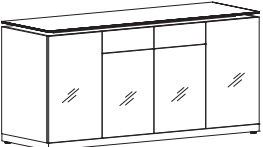
Base plates are available in Gloss Aluminum, Laminate or Wood, please specify requirement on order.

# NUVO | BUFFETS

| Description  | Model        | Oak<br>Cherry<br>Maple<br>Laminate | Walnut | W    | D  | H  | Weight | Cube |
|--|--------------|------------------------------------|--------|------|----|----|--------|------|
|  Door, Drawer/Door,<br>Drawer/Door, Door | 51BU72203514 | 6211                               | 6833   | 71.5 | 20 | 35 | 298    | 36   |
|  | 51BU72243514 | 6495                               | 7145   | 71.5 | 24 | 35 | 311    | 42   |
|  | 51BU84203514 | 7145                               | 7860   | 83.5 | 20 | 35 | 347    | 42   |
|  | 51BU84243514 | 7467                               | 8215   | 83.5 | 24 | 35 | 362    | 49   |

|  |               |       |       |      |    |    |     |    |
|--|---------------|-------|-------|------|----|----|-----|----|
|  Back-Painted Glass Door,<br>Drawer/Door, Drawer/Door,<br>Door | 51BU72203514Z | 8529  | 9383  | 71.5 | 20 | 35 | 308 | 36 |
|  | 51BU72243514Z | 8812  | 9693  | 71.5 | 24 | 35 | 331 | 42 |
|  | 51BU84203514Z | 9809  | 10790 | 83.5 | 20 | 35 | 359 | 42 |
|  | 51BU84243514Z | 10133 | 11145 | 83.5 | 24 | 35 | 385 | 49 |

|  |                |       |       |      |    |    |     |    |
|--|----------------|-------|-------|------|----|----|-----|----|
|  Door, Drawer/Door,<br>Drawer/Door, Door,<br>Back-Painted Glass Top | 51BUGP72203514 | 9114  | 10022 | 71.5 | 20 | 35 | 338 | 36 |
|  | 51BUGP72243514 | 9975  | 10975 | 71.5 | 24 | 35 | 359 | 42 |
|  | 51BUGP84203514 | 10481 | 11527 | 83.5 | 20 | 35 | 394 | 42 |
|  | 51BUGP84243514 | 11472 | 12618 | 83.5 | 24 | 35 | 418 | 49 |

|   |                 |       |       |      |    |    |     |    |
|---|-----------------|-------|-------|------|----|----|-----|----|
|  Back-Painted Glass Door,<br>Drawer/Door, Drawer/Door,<br>Door, Back-Painted Glass<br>Top | 51BUGP72203514Z | 11281 | 12407 | 71.5 | 20 | 35 | 348 | 36 |
|   | 51BUGP72243514Z | 12035 | 13240 | 71.5 | 24 | 35 | 379 | 42 |
|   | 51BUGP84203514Z | 12971 | 14269 | 83.5 | 20 | 35 | 405 | 42 |
|   | 51BUGP84243514Z | 13842 | 15222 | 83.5 | 24 | 35 | 441 | 49 |

**ORDERING NOTES:** An optional Recycle/Waste bin, located behind the right door, is available at an upcharge of **\$571 list**, add W - Waste Bin to the model number. An optional Cutlery Tray is available at an upcharge of **\$61 list**. An optional mini fridge, located behind the right door, is available on 24" deep units at an upcharge of **\$2638**, add F - fridge to model number.

## ORDERING PROCEDURE

To order, please specify the following:  
1) Krug product model number  
2) Wood species and finish

## CODE DESCRIPTION

GP - Back-Painted Glass Top  
Z - Back-Painted Glass Doors

## STANDARD FINISHES

For a complete list of standard wood finishes, please see page 347.

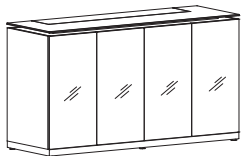
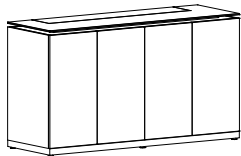
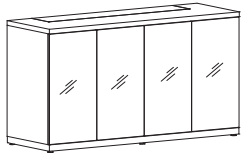
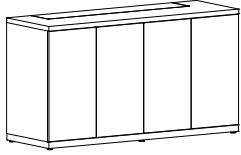
## BASE PLATES

Base plates are available in Gloss Aluminum, Laminate or Wood, please specify requirement on order.



# NUVO | BUFFETS WITH TV LIFT

| Description   | Model         | Oak   | Cherry   | Walnut | W    | D  | H  | Weight | Cube |
|---|---------------|-------|----------|--------|------|----|----|--------|------|
|   |               | Maple | Laminate |        |      |    |    |        |      |
| 4 Doors with TV Lift  | 51TV722439    | 12791 |          | 14070  | 71.5 | 24 | 39 | 345    | 49   |
|   | 51TV842439    | 14711 |          | 16180  | 83.5 | 24 | 39 | 402    | 57   |
| 4 Back-Painted Glass Doors with TV Lift                         | 51TV722439Z   | 16794 |          | 18474  | 71.5 | 24 | 39 | 368    | 49   |
|   | 51TV842439Z   | 19313 |          | 21245  | 83.5 | 24 | 39 | 429    | 57   |
| 4 Doors with TV Lift, Back-Painted Glass Top                    | 51TVGP722439  | 14334 |          | 15767  | 71.5 | 24 | 39 | 372    | 49   |
|   | 51TVGP842439  | 16483 |          | 18132  | 83.5 | 24 | 39 | 433    | 57   |
| 4 Back-Painted Glass Doors with TV Lift, Back-Painted Glass Top | 51TVGP722439Z | 18339 |          | 20171  | 71.5 | 24 | 39 | 395    | 49   |
|   | 51TVGP842439Z | 21090 |          | 23198  | 83.5 | 24 | 39 | 460    | 57   |



**ORDERING NOTE:** Cabinet is standard with 4 shelves 12 1/2" deep.

### DIMENSION KEY

W - width  
D - depth  
H - height

### CODE DESCRIPTION

GP - Back-Painted Glass Top  
Z - Back-Painted Glass Doors

### STANDARD FINISHES

For a complete list of standard wood finishes, please see page 347.

### BASE PLATES

Base plates are available in Gloss Aluminum, Laminate or Wood, please specify requirement on order.

# NUVO | HOSPITALITY CARTS

| Description      | Model       | Laminate               |        |  | W  | D  | H  | Weight | Cube |
|------------------|-------------|------------------------|--------|--|----|----|----|--------|------|
|                  |             | Oak<br>Cherry<br>Maple | Walnut |  |    |    |    |        |      |
| Hospitality Cart | 51MSC422035 | 4928                   | 5420   |  | 42 | 20 | 35 | 213    | 22   |



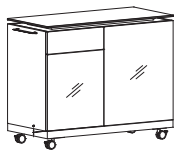
|   |              |      |      |  |    |    |    |     |    |
|---|--------------|------|------|--|----|----|----|-----|----|
| Hospitality Cart - Back-Painted Glass Doors | 51MSC422035Z | 6144 | 6760 |  | 42 | 20 | 35 | 227 | 22 |
|---|--------------|------|------|--|----|----|----|-----|----|



|  |               |      |      |  |    |    |    |     |    |
|--|---------------|------|------|--|----|----|----|-----|----|
| Hospitality Cart, Back-Painted Glass Top | 51MSCGP422035 | 6784 | 7463 |  | 42 | 20 | 35 | 240 | 22 |
|--|---------------|------|------|--|----|----|----|-----|----|



|   |                |      |      |  |    |    |    |     |    |
|---|----------------|------|------|--|----|----|----|-----|----|
| Hospitality Cart - Back-Painted Glass Doors, Back-Painted Glass Top | 51MSCGP422035Z | 8002 | 8803 |  | 42 | 20 | 35 | 275 | 22 |
|---|----------------|------|------|--|----|----|----|-----|----|



## ORDERING NOTES:

Hospitality Cart is standard with Cutlery Tray & Recycle/Waste bin on the left and two adjustable shelves on the right.

### ORDERING PROCEDURE

To order, please specify the following:

- 1) Krug product model number
- 2) Wood species and finish

### CODE DESCRIPTION

- GP - Back-Painted Glass Top  
Z - Back-Painted Glass Doors

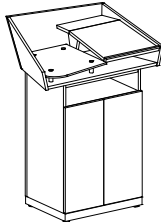
### STANDARD FINISHES

For a complete list of standard wood finishes, please see page 347.

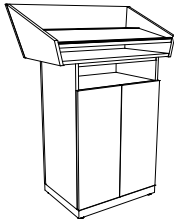
### BASE PLATES

Base plates are available in Gloss Aluminum, Laminate or Wood, please specify requirement on order.

| Description                                     | Model         | Oak<br>Cherry<br>Maple |        |  | W  | D  | H  | Weight | Cube |
|---|---------------|------------------------|--------|--|----|----|----|--------|------|
|   |               | Laminate               | Walnut |  |    |    |    |        |      |
| Lectern with Glass Shelf & Closed Lower Storage | 51LN372250-11 | 6827                   | 7759   |  | 37 | 22 | 50 | 234    | 30   |



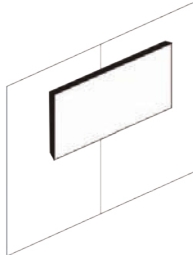
|   |               |      |      |  |    |    |    |     |    |
|---|---------------|------|------|--|----|----|----|-----|----|
| Lectern Full Width & Closed Lower Storage | 51LN372250-11 | 5953 | 6544 |  | 37 | 22 | 50 | 230 | 30 |
|---|---------------|------|------|--|----|----|----|-----|----|



**ORDERING NOTES:** Lecterns feature grommets for cable management. Lecterns are available with casters, add M to the model # and an upcharge of **\$152**. All hinged doors on Lecterns feature standard locks.  
Lectern options:

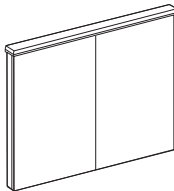
- Altinex Box : **\$1273 list.**
- Power Bar : **\$208 list**
- Reference Light : **\$443 list**

|            |          |      |      |  |    |   |    |     |    |
|------------|----------|------|------|--|----|---|----|-----|----|
| Media Wall | 51MW8483 | 3538 | 3892 |  | 84 | 4 | 83 | 115 | 16 |
|------------|----------|------|------|--|----|---|----|-----|----|



**NOTES:** Media Wall features a T.V. mounting bracket and cable channel for cords to exit at the floor. Media wall can be mounted without a credenza or buffet if no equipment other than the TV is required. Please include TV size on each purchase order, since machining required is dependent on the TV size.

|                          |           |      |      |  |    |   |    |     |    |
|--------------------------|-----------|------|------|--|----|---|----|-----|----|
| Sliding Door Media Board | 51VBS4848 | 4399 | 4841 |  | 48 | - | 48 | 120 | 16 |
|--------------------------|-----------|------|------|--|----|---|----|-----|----|



**NOTE:** Sliding Door Media Board includes white board, eraser and four dry erase makers. For laminate orders marker tray is Black Palette. Sliding Doors slide open and closed independently of each other.

**DIMENSION KEY**  
W - width  
D - depth  
H - height

**CODE DESCRIPTION**  
X - Full Width  
11 - Closed Shelves Below

**STANDARD FINISHES**  
For a complete list of standard wood finishes, please see page 347.

**BASE PLATES**  
Base plates are available in Gloss Aluminum, Laminate or Wood, please specify requirement on order.

# GENERAL INFORMATION

## Terms and Conditions

Net 30 days on approved credit. A late payment charge of 1% per month will be applied on overdue invoices. This charge will be pro-rated to the number of days past 30 days that the invoice is overdue. All applicable sales taxes are extra. Distribution of this price list does not in itself constitute an offer to sell. Orders can be received only from authorized Krug dealers. Acceptance of any order and terms of sale may be established at the discretion of Krug. Deposits are required on orders received from new accounts as well as on large or special orders. Krug reserves the right to discontinue designs, or to change designs, construction, prices, or materials without notice.

## Contact Information

Phone: 1.888.578.KRUG (5784) | Fax: 1.519.748.5177  
Purchase Order Fax: 1.888.236.4783  
Purchase Order E-mail: orders@krug.ca  
Web: www.krug.ca E-mail: solutions@krug.ca

## Customer Service Hours

Please note customer service hours are:  
8:30 am to 5:00 pm est

## Customer Satisfaction

It is the primary goal of Krug and our staff to ensure the complete satisfaction of our customers with our products and performance. If a problem arises with a Krug product after the expiration of the limited warranty period, Krug will exercise its best efforts to achieve the satisfaction of the customer in a manner that is fair to all concerned.

## Order Acknowledgments

Each order will be acknowledged via e-mail or fax. This acknowledgment is the final agreement between Krug and the customer, superseding all previous communications regarding the purchase order. Where there is a discrepancy on a purchase order between a product code and a description, Krug will make every effort to resolve the discrepancy, but will be ruled by the product code ordered. Please check all acknowledgments for accuracy, and advise Krug of any discrepancies with a purchase order.

## Order Cancellation

Krug reserves the right to not accept or allow cancellation of orders. All products are manufactured on a custom-made, make-to-order basis, and the purchasing, engineering and production of orders begins shortly after order placement - and the customer purchase order is a contract that authorizes Krug to manufacture the products. Acceptance of order cancellation (or partial cancellation) is solely at the discretion of Krug, and is dependent on the extent to which engineering, purchasing and manufacturing has been initiated by the time cancellation is requested. No order cancellations (partial or otherwise) are allowable more than 4 weeks from date of order placement (as order production is unable to be terminated by that point), and full payment of the acknowledged order value is required for any orders cancelled after 4 weeks. Cancellations may be allowable in less than 4 weeks after order placement, depending on the extent to which manufacturing has been initiated. An acceptance of order cancellation requires that the purchaser agrees to make payment for all costs incurred to the point of acceptance of cancellation. Cancellation charges include all costs for purchase of dedicated material and components, engineering costs for non-standard products, and all costs for manufacturing completed to that point, as well as a \$367 net charge for processing of the original order and for processing of cancellation invoicing.

## Pricing

Krug endeavors to ensure that all prices in this price list reflect accurately our current prices. However, errors do occur and will be rectified through notices to the field. Krug reserves the right to acknowledge pricing that may be different from the price list.

## Storage Charges

Krug reserves the right to assess a nominal storage charge if a customer does not accept shipment of an order within a week of the ship date.

## Warranty

Krug warrants the construction and the finish of all our products to be free from defects in materials and workmanship for a period of 10 years from the date of purchase. This warranty is applicable to products in use by their original purchaser. This warranty does not apply to components not manufactured by Krug including textiles, which are subject to the specific warranties of those manufacturers, if any. Textiles (fabric, leather, vinyl, or any other covering material) suppliers do not guarantee their products for durability and color fastness, and nor does Krug. Casters, mechanical and electrical components have a warranty of five years from the date of purchase. The Krug warranty does not apply to COM-specified materials, damage caused by a carrier other than Krug, or variation in wood finishes due to natural wood color variation. Krug cannot be held responsible for variations in fabric dye lots from order to order. All fabric is carefully inspected when it is received, but a degree of variation in color should be expected. Repairs or replacement of any defect covered under this warranty by Krug will be made, at our option and method, at no charge to the original purchaser during the warranty period. Krug's judgement is final and binding with respect to the nature or cause of defects or damage, and the necessity or manner of repair or replacement.

This warranty does not apply to defects or damage resulting from:

- normal wear and tear occurring with the use of the product
- negligence, misuse, excessive use, alteration, improper cleaning or repair
- substitution or use of incorrect or unauthorized components or material
- handling or installation that is incorrect, or that causes damage or defect
- damage incurred by a freight carrier other than Krug
- wearing of finishes and fabrics, and normal variations in materials (including dye lot variations)
- properties of natural materials, including wood and leather
- exposure to environments with uncontrolled temperature and humidity (products must be transported, stored and used in climate-controlled conditions)

## Export Packaging

Krug is pleased to provide the option for export packaging on all our products, to provide additional protection from damage. For shipments overseas, a quote for export packaging can be provided, based on the products to be ordered and the delivery destination - please contact Customer Service or Bids & Specification Support for more information and a quotation. KRUG is not responsible for shipment damage occurring on overseas shipments

Export Packaging is STRONGLY RECOMMENDED for:

- (A) all shipments outside of the lower 48 states and Canada.
- (B) all shipments that will be held in storage for an extended period prior to installation.

**Important:** Please note that Krug will not be responsible for damage claims on product shipped or stored in the above conditions but where export packaging has not been utilized.

## Dimensions

Dimensions are in inches and approximate, and subject to change without notice. Contact Customer Service if dimensions are critical.

## Installation Support

For assistance please contact Technical Support at 1-888-578-5784 x216 or e-mail installationhelp@krug.ca and you will be directed to the appropriate installation support person.

## Custom Capabilities

Over 15% of our orders involve some type of custom work, and we invite our customers to make use of our extensive capabilities. These include:

- 1) Dimensional customization of standard size products
- 2) Custom wood finishes
- 3) For larger orders, completely custom-designed products, as well as non-standard wood species can be specified.

Custom orders may require additional production lead times. Contact Customer Service for more information.

## Freight Terms and Conditions

1. All product is shipped FOB the Krug factory. Freight is either pre-paid to the destination or not pre-paid, depending on established customer specific freight terms.
2. Docks at the selected delivery location must be equipped to handle a 53' trailer. If a dock is inadequate for delivery by Krug, Krug will re-deliver to another local location and any additional costs will be charged to the customer.
3. For all deliveries, it is understood that Krug or its agent is making a dock delivery only (equipped to handle a 53' trailer), and any further work of truck unloading, delivery beyond the dock, installation, and removal of packaging is not authorized or paid for by Krug.
4. Drop shipments to the installation site, and timed deliveries, are available on larger shipments (full truckloads or slightly less) at no additional charge. Drop shipments or timed deliveries for smaller shipments may not be available, or if available will require a surcharge. Deliveries on an after hours basis, or on weekends, or any other special requirements, may be subject to a surcharge. Location and contact information, and the requested time of delivery, is required at least one week prior to the acknowledged shipment date. If this information is not provided one week in advance, or if the location or time of the drop shipment is changed less than one week in advance, a surcharge may be applied, and/or the drop shipment may not be scheduled. For deliveries requested Monday to Thursday after 5:00 pm, please apply a surcharge of \$262/shipment. For deliveries requested Monday to Friday before 7:00 am, please apply a surcharge of \$262/shipment. For deliveries requested Friday (after 3:00 pm) or weekends, please apply a surcharge of \$525/shipment. (local times).
5. For all deliveries - whether to the Customer location or drop shipment - any circumstances that result in the delay of our carrier (including unsuitable receiving facilities, or facilities not open or available), service charges will be applied at the rate of \$125/hour. Where re-delivery is necessary because of these circumstances, the full cost of re-delivery will be charged. If Less Than Truck Load is delivering, one hour is allocated to unload. Any additional time required to unload after the first hour is \$125/hour. If a Truck Load is delivering the order, three hours is allocated to unload. Any additional time required to unload is \$125/hour. Direct deliveries to site for large orders are possible, (must exceed \$60,000 net), and accommodate 48 - 53' trailers. Krug is responsible for delivery to the approved delivery address. If an address change is required, this must be authorized by Krug 5 business days prior to ship date. Any additional delivery costs incurred after this time will be charged to the customer.

## Product Strength and Durability Testing

All Krug Conference products meet or exceed the testing requirements of ANSI/BIFMA X5.5-2014 or X5.9-2012.



## Damaged Shipments

All Krug product is well engineered, carefully inspected, and expertly loaded onto our trucks at our Distribution Center. If you receive any damaged freight, we ask that you do not refuse the shipment. Krug is not responsible for damage to goods that occurs in transit or storage. It is the purchaser and/or receiver's responsibility to examine the goods upon receipt and to notify Krug of any damages, overages or shortages. Any discrepancies should be noted on the Bill of Lading. The delivering carrier will not accept responsibility for shortages or damages if signed "clear". Notification of concealed damage claims must be made to Krug Distribution within 5 days of delivery, along with digital pictures if available. All product and packaging must be available for inspection. Krug liability ceases after 5 business days and Krug will not be responsible for concealed damages if shipments are left unopened. Krug is not responsible for the condition of product that is stored or installed in an environment where temperature and humidity are not controlled.

## Field Product Report Authorization

Krug's written authorization, in the form of an FPR number, must be obtained prior to incurring charges of any kind if Krug is expected to pay these charges. This includes authorization for returns, field repairs and replacements, post field repairs, installation and delivery charges. Krug reserves the right to have its representative inspect product related to any request for such authorizations, prior to that authorization being provided. Deductions from invoices paid for any charges to Krug, without prior written authorization in the form of an FPR, will not be accepted. Digital photographs may be required to complete the FPR process.

## Care and Maintenance

**Wood Finishes** - Although Krug's extensive finishing process ensures a durable finish on all our products, there are several steps that can be taken to protect and prolong the life and beauty of the finish. Protect the top by placing felt pads on the bottom of any accessories and mechanical equipment. Rubber and oil will permanently mark surfaces. Use a desk pad to prevent possible damage and imprinting caused by writing instruments and sharp objects. Dust only with a clean, dry cloth, going with the grain. Clean any marks with a damp cloth, using a small quantity of mild soap or detergent. Do not use any wax-based polish, spray or silicone. Eventually, a film will build up and discolor the top. Do not place your furniture in a position of permanent exposure to direct sunlight.

**Plastic Laminates** - Clean plastic laminates with mild soap and warm water. Do not use steel wool, hot water, or any abrasive cleaning product.

## Krug Panel Fabric Program

Tackboards can be upholstered in COM material supplied by the customer, and in a selection of stocked tackboard fabrics supplied by Momentum. The Momentum Panel fabrics are available on Krug Express. They are 100% polyester. For additional information and color selections, please refer to our Panel Fabrics card and Krug's website. [www.krug.ca](http://www.krug.ca) PRODUCTS / FABRICS / PANEL  
The Momentum panel fabrics pass ASTM-E84-87 Fire Codes.  
If memo samples are required please call Momentum at 1-800-366-6839.



## PROGRAM DETAILS

*KrugExpress* orders are ready to ship by the date acknowledged. Delivery and shipping schedules may result in actual shipping of orders at a later date. Statutory holidays and scheduled factory vacations may add to acknowledged lead times of *KrugExpress* orders. Unless otherwise specified on the order, the customer's standard method of shipping Krug products will be utilized.

Available factory capacity for *KrugExpress* is filled by orders received on a "first come, first serve" basis. If the normal *KrugExpress* lead time is not available for your order because available capacity has been filled, you will be immediately advised of the earliest available ready-to-ship date. Please consult your Customer Service representative in advance if you wish to confirm the specific lead time availability for a *KrugExpress* order.

Orders must be received by midnight of a given day for that day to be considered the official day the order is received. Order lead times are acknowledged from the date the order is received, but not including the date the order is received.

*KrugExpress* orders must be "clean" when received in order to be considered officially received on a given day, and lead times will be acknowledged from the date orders are determined to be "clean".

Changes to *KrugExpress* orders are not allowed under any circumstances. Orders for product on *KrugExpress* must clearly state: "*KrugExpress*".

# WOOD FINISHES AND LAMINATES

## Standard Wood Finishes:

(See product pages for individual species availability)

| SPECIES              | FINISH               |
|----------------------|----------------------|
| Cherry               | Light Cherry         |
|                      | Natural Cherry       |
|                      | American Cherry      |
|                      | Medium Cherry        |
|                      | Standard Cherry      |
|                      | Imperial Cherry      |
|                      | Appalachian Cherry   |
| Sable Cherry         |                      |
| Maple                | Clear Maple          |
|                      | Honey Maple          |
|                      | Wheat Maple          |
| Oak                  | Light Oak            |
|                      | SilverGrey on Oak    |
|                      | Harvest Oak          |
|                      | Mahogany Oak         |
|                      | Medium Cherry on Oak |
|                      | Mellow Oak           |
|                      | Walnut on Oak        |
| Espresso on Oak      |                      |
| Walnut               | Natural Walnut       |
|                      | Regular Walnut       |
|                      | Mahogany on Walnut   |
|                      | Dark Walnut          |
|                      | Cordovan Walnut      |
| SilverGrey on Walnut |                      |
| Anigre               | Clear Anigre         |
|                      | Medium Anigre        |
| Palette              | Black                |
|                      | White                |
|                      | Sand                 |
|                      | Soft Green           |
|                      | Steel Blue           |
|                      | Slate                |

## NATURAL CHARACTERISTICS OF WOOD

Wood is a natural product with inherent color variations that will never be fully mitigated by the finishing process. Please anticipate variation in colors within a single unit, from piece to piece, and from Krug wood finish samples. If a very close match is required, a sample must be provided with the order and an upcharge will apply. Exact color matches are not possible.

## CUSTOM WOOD FINISHES

Add 10% list to your order for special finishes, minimum upcharge is \$600 list per finish per order. (For example, on all orders up to \$6000 list, an upcharge of \$600 will apply, on orders \$6000 and up add 10% list to your order.) For orders with special finishes, a sample that is a minimum 3" by 3" must be received with the order. Special finishes may add additional lead time to production schedules. Since wood is a natural product, some variations in grain, color and stain acceptance will occur. In our finishing processes, we try to minimize variations, but some variation between samples and finished goods should be anticipated.

## FINISH

Conference products feature Krug's finish, a proprietary catalyzed varnish formulation, that has repeatedly shown through independent laboratory testing to be the industry leader in durability and abrasion resistance. The Krug finish looks better longer than competitors and is uniquely suited to the demands of high traffic environments.

## WOOD FINISHES TO MATCH STANDARD LAMINATES

- Willow on Rift Oak
- Dune on Rift Oak
- Portobello on Rift Oak
- Ash on Rift Oak
- Copper on Cherry
- Shiraz Cherry
- Park Avenue Walnut
- Chocolate on Walnut
- Nutmeg on Walnut
- Dark Walnut
- Hardrock Maple

## LAMINATES

Krug's in-stock Laminates are available in 17 different laminate selections. Please note that 4 of the colors (Gingerbread, Portobello, Ash and Willow) have textured finishes and may not be appropriate for use in patient areas due to infection control concerns. Minimum order quantities and extended lead times may apply for exotic laminate colors, please check with customer service. Polymer Edge will be selected to match the worksurface. Krug's previous laminate in-stock program will be phased out as in-stock supply depletes. Please contact customer service for availability.

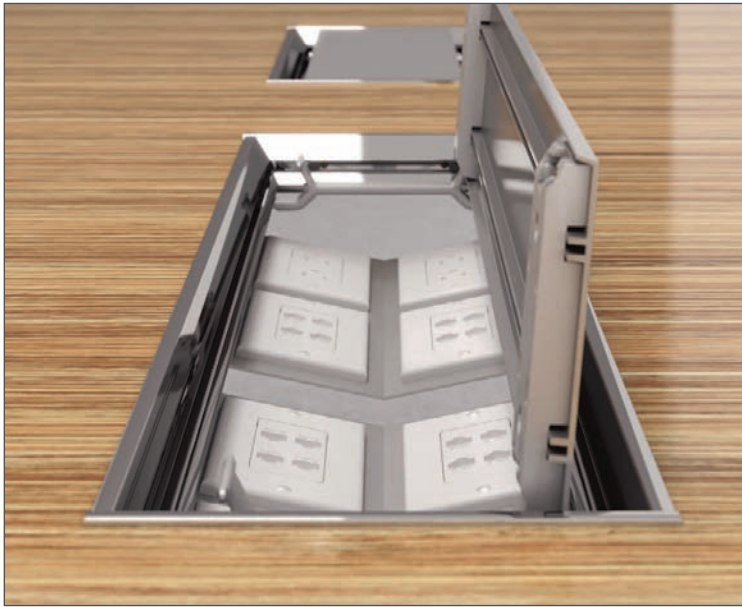
### IN-STOCK LAMINATES

| Wood Grain Laminates | High Pressure Laminate Supplier | Textured Wood Grain Laminates | High Pressure Laminate Supplier |
|----------------------|---------------------------------|-------------------------------|---------------------------------|
| Champagne            | Tafisa T492CR                   | Gingerbread                   | Tafisa T556UR                   |
| Hardrock Maple       | Formica 86992-58                | Portobello                    | Tafisa T557UR                   |
| Dune                 | Tafisa T491CR                   | Ash                           | Tafisa T535AT                   |
| Copper               | Tafisa T521CR                   | Willow                        | Tafisa T543AT                   |
| Shiraz Cherry        | Tafisa T472CR                   | <b>Solid Laminates</b>        |                                 |
| Park Avenue Walnut   | Wilsonart 7984-38               | Designer White                | Wilsonart D354-60               |
| Chocolate            | Tafisa T498CR                   | Platinum                      | Tafisa T202CR                   |
| Nutmeg               | Tafisa T477CR                   | Earth                         | Tafisa T767CR                   |
| Dark Walnut          | Tafisa T469CR                   | Charcoal                      | Tafisa T228CR                   |

**PHASE OUT LAMINATES** Almond - Black- Shadows - Edgewood Sycamore - Gunstock Walnut

### NON-STOCKED LAMINATES

For specific lead time and application questions, please contact Krug Customer Service for your requirement. Upcharges will be applicable for non-stocked laminates, depending on their cost. Non-stock laminates may require a minimum order quantity, please contact customer service. Stocked polymer edges only can be specified for use with non-stocked laminates or tops will be self-edged.



FSC  
www.fsc.org  
FSC® C021699

The mark of responsible forestry



All products are air emissions certified and are available as FSC® certified

# krug

solutions@krug.ca | www.krug.ca | 1.888.578.KRUG