

# SEATING & OCCASIONAL TABLES

Price and Specification Guide

USA



# krug

Advancing Design Through Innovation

# TABLE OF CONTENTS

## PRICING & SPECIFICATIONS

### 2 Management & Task Seating

3	Callisto
7	C5
16	Aqua
22	Dorso E
29	Dorso T
34	Dorso Weave
40	Dorso
47	Me
53	Pan Am
58	Cadence

### 64 Guest Seating

65	Addison
68	Blake
71	Dorso
74	Bali
76	Kita
78	Spence
80	Cadence
82	Faeron Wood
88	Faeron Metal

### 94 Multi-Purpose Seating

95	Libra
102	Mobi
106	Karma
116	Corfu
122	Capri
124	Bank of England

### 126 Barstools & Counter Height Seating

127	Manolo
131	Karma
133	Capri
135	Corfu

### 141 Lounge Seating

142	Avatar
145	Cressida
155	Leyton
170	Zola
187	Zola Privacy
253	Faeron
265	Sutton
267	Carlyle
269	Brio
271	Sloane

### 273 Benches

274	Tate
280	Zola
290	Carlyle

### 292 Occasional Tables

293	Chit Chat
296	Avatar
298	Karma
303	Cressida
306	Leyton
308	Faeron Wood
310	Faeron Metal
312	Zola
317	Sutton
319	Virtu
321	Millennium
323	Prado
325	Carlyle

### General Information

327	General Information
329	Krug Textiles - Upholstery Fabrics
332	Krug Textiles - Leather & Luxe Faux Leather
333	C.O.M.
334	Graded-In Upholstery Programs
334	KrugExpress Program
335	Wood Finishes
336	Laminate Program
336	Solid Surface Program
337	Base Styles

# MANAGEMENT & TASK SEATING

3	Callisto
7	C5
16	Aqua
22	Dorso E
29	Dorso T
34	Dorso Weave
40	Dorso
47	Me
53	Pan Am
58	Cadence

# CALLISTO | ENVIRONMENTAL SUMMARY

## LEED CI CREDITS



### MATERIAL CONTENT:

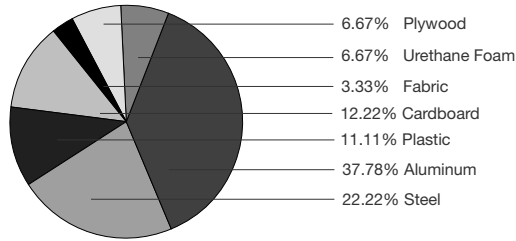

PRE-CONSUMER  
RECYCLED CONTENT = 28.83%

POST-CONSUMER  
RECYCLED CONTENT = 21.67%

Up to 70.56% of this Callisto product is recyclable at the end of its useful life.

### CONTRIBUTES TO

CREDIT 2.1 - 2.2	Construction Waste Management	1-2 point(s)
CREDIT 3.3	Resource Reuse	1 point
CREDIT 4.1	Recycled Content	1 point
CREDIT 4.2	Recycled Content	1 point
CREDIT 4.5	Low Emitting Materials, Systems & Seating	1 point
CREDIT 5.1	Regional Materials*	1 point
CREDIT 7	Certified Wood (MUST BE REQUESTED)	1 point(s)

\*This credit is only applicable if in total 20% of the combined value of the procurement of construction materials and in the furniture are manufactured within a radius of 500 miles. This credit will apply if the installation of the finished product occurs within 500 miles of Kitchener, Ontario.

## level® CERTIFICATION, AIR EMISSIONS AND FSC® CERTIFICATION



### level® CERTIFICATION

BIFMA's e3 Furniture Sustainability Standard is a voluntary, multi-attribute standard that measures the degree of sustainability of furniture. This standard evaluates product and company environmental attributes and compliance systems in a wide range of elements which include Materials, Energy & Atmosphere, Human & Ecosystem Health and Social Responsibility. Callisto products have earned level®, BIFMA's sustainability certification program for furniture, certification through third-party verification against the e3 standard.



### AIR EMISSIONS

All Callisto products are supplied air-emissions certified. Contact customer service for information.

Architects, designers, and building professionals can specify FSC®-certified products in order to achieve a point from the US. Green Building Council's Leadership in Energy and Environmental Design (LEED) Rating System.



## BREATHABLE MESH

Mesh Seats and Backs are available in 2 colors: Black and Grey.



## UPHOLSTERED CUSHIONING

Upholstered Seats and Backs are available in a wide range of textiles, and seat features molded foam that is supportive for extended periods of sitting.



## ADJUSTABLE LUMBAR SUPPORT

This optional feature provides enhanced support in the lower lumbar area of the back with 3" of adjustment range.



## FIXED CANTILEVER ARM

This arm features Polished Aluminum with an integrated urethane pad surface.



## ADJUSTABLE ARM

Height adjustment range of 2.5". Arm pad forward/backward adjustment of 1.5". Arm pad has a 3 position swivel of 20 degrees inward and 15 degrees outwards.



## ARMLESS

Callisto models are available armless.



## SELF-ADJUSTING SYNCHRO MECHANISM

The tilt feature adjusts automatically to the user's weight. It includes a standard seat slider feature adding an adjustment range of 2", and 4 position tilt lock with anti-kickback, and height adjustability.



## BASES

Base options include Polished Aluminum and Black Polymer, and a soft wheel caster option.



## STOOL BASE

A stool version is available on all Callisto models. It has a standard height adjustment range of 7.5". Foot ring is Polished Chrome, and standard gas lift is Black.

The Seat Slider and Seat Slider Plus option is not available with the Stool base. Stool base is only available with a swivel mechanism.

## WEIGHT CAPACITIES

Callisto has been tested and complies with ANSI/BIFMA x5.1-2011 standards. Callisto has been load tested to 450lbs

## OPTIONS



## ADJUSTABLE ARMS PLUS

Height adjustment range of 2.5". Arm pad forward/backward adjustment of 1.5". Arm pad has a 3 position swivel of 20 degrees inward and 15 degrees outwards. Adjustable Arms Plus provides a width adjustment range of 3".

## SEAT SLIDER PLUS

The optional enhanced seat slider, has an adjustment range of 3". When the 3" seat slider option is selected a larger chair base is included. Seat Slider Plus option is not available with the Stool base.

## COMBINATION UPHOLSTERY OPTION

When combination upholstery is specified with fabric of the same grade or COM, an upcharge for dual fabrics is **\$33 list** per unit will be applied. When graded in combination upholstery is selected, use the highest grade upholstery selected or to obtain a quote for blended grading contact Customer Service (please provide the fabrics specified and location of where each fabric is to be applied on the product).

## REPLACEABLE COMPONENTS

Callisto is uniquely designed to allow major components to be field replaced, providing a very cost-effective means to significantly extend the life of the product.

## CAL 133 & MOISTURE BARRIER





California Technical Bulletin 133 is a flammability test for seating. Krug offers a compliance method which, in combination with non-flammable upholstery covers, may enable the products to meet certification requirements for this test. This process at the same time also provides the products with a Moisture Barrier - a treatment that helps to prevent the passage of liquids and moisture to inside of upholstered components - thereby conferring sanitary and anti-infection benefits. So when CAL 133 is specified, the product also automatically has a Moisture Barrier, and when a Moisture Barrier is specified, the product also features the compliance method and low flammability features of CAL 133.

The application of this upcharge and the compliance method does not mean that the specific configuration of product and upholstery cover are tested and officially certified as being CAL 133 compliant. If official certification is required, Krug will provide this (through an independent certified testing laboratory) at a charge of \$917 per item, plus the cost of the product to be tested. Lead time for certification testing is typically 4-8 weeks. Krug assumes no responsibility for the testing of our products in combination with upholstery covers, or for the results of any testing conducted. Some specific configurations of product and upholstery have already been tested. Please contact Customer Service for additional information.

# CALLISTO | DIMENSIONS & COM REQUIREMENTS

	Overall Width	Overall Depth	Overall Height	Overall Height -Stool	Seat Height Min/Max	Seat Height -Stool Min/Max	Height Arms From Floor Min/Max	Height Arms From Floor-Stool Min/Max	Width Between Arms	Seat Depth	Shipping Weight	Cubes	COM YRD
CAL1M10	20	26	38.75	44.75	17-21	23-30.5	n/a	n/a	n/a	19	39	14.5	-
CAL1M11	25	26	38.75	44.75	17-21	23-30.5	25.5-30	31.5-39	21	19	45	14.5	-
CAL1M12	24	26	38.75	44.75	17-21	23-30.5	25.5-30	31.5-39	17	19	45	14.5	-
CAL1M20	20	26	38.75	44.75	17-21	23-30.5	n/a	n/a	n/a	19	39	14.5	.85
CAL1M21	27	26	38.75	44.75	17-21	23-30.5	25.5-30	31.5-39	21	19	45	14.5	.85
CAL1M22	26	26	38.75	44.75	17-21	23-30.5	25.5-30	31.5-39	19	19	45	14.5	.85
CAL1M30	20	26	38.75	44.75	17-21	23-30.5	n/a	n/a	n/a	19	39	14.5	1.68
CAL1M31	27	26	38.75	44.75	17-21	23-30.5	25.5-30	31.5-39	21	19	45	14.5	1.68
CAL1M32	26	26	38.75	44.75	17-21	23-30.5	25.5-30	31.5-39	19	19	45	14.5	1.68

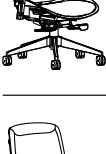
## CALLISTO









DESCRIPTION/MODEL	COM		COL			FABRIC GRADES			LEATHER		
	1	2	3	4	5	6	7	8	9		
 Mesh Back & Seat, Armless with Black Base CAL1M10B	865										
 Mesh Back & Seat, Armless with Polished Aluminum Base CAL1M10P	889										
 Mesh Back & Seat, Adjustable T-Arm with Black Base CAL1M12B	968										
 Mesh Back & Seat, Adjustable T-Arm with Polished Aluminum Base CAL1M12P	992										
 Mesh Back & Seat, Fixed Cantilever Arm with Black Base CAL1M11B	992										
 Mesh Back & Seat, Fixed Cantilever Arm with Polished Aluminum Base CAL1M11P	1017										

**ORDERING NOTES:** To add Adjustable Lumbar Support option add "L" to the model number above, "W" for Adjustable Arms Plus, "S" for Seat Slider Plus and upcharge below.

Callisto Option Upcharges	\$ List	\$ List
CAL 133 & Moisture Barrier (per yard)	64	Seat Slider Plus (S) 71
Soft Wheel Casters	64	
Adjustable Lumbar Support (L)	59	
Adjustable Arms Plus (W)	94	
Stool Base	108	

### PRODUCT CODE KEY

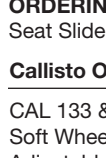
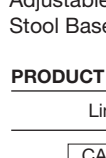
Line	Series	Back Style	Chair Style	Arm Style	Base Style
CAL Callisto	1 Management, Task & Conference Seating	M Mid Back	1 Mesh Back & Seat	0 Armless	B Black Polymer
CAT Callisto Stool			2 Mesh Back, Upholstered Seat	1 Fixed Cantilever Arm	P Polished Aluminum
			3 Fully Upholstered	2 Adjustable T-Arm	

DESCRIPTION/MODEL	COM		COL			FABRIC GRADES			LEATHER	
	1	2	3	4	5	6	7	8	9	
	Mesh Back & Upholstered Seat, Armless with Black Base									
	CAL1M20B	931	953	976	1017	1062	1106	1149	1194	1281
	Mesh back & Upholstered Seat, Adjustable T-Arm with Black Base									
	CAL1M22B	1037	1059	1081	1122	1166	1210	1256	1298	1386
	Mesh back & Upholstered Seat, Adjustable T-Arm with Polished Aluminum Base									
	CAL1M22P	1062	1084	1106	1148	1194	1237	1281	1323	1412
	Mesh Back & Upholstered Seat, Fixed Cantilever Arm with Black Base									
	CAL1M21B	1062	1083	1106	1148	1193	1237	1281	1323	1411
	Mesh Back & Upholstered Seat, Fixed Cantilever Arm with Polished Aluminum Base									
	CAL1M21P	1087	1109	1131	1173	1218	1262	1306	1348	1437
	Fully Upholstered Back & Seat, Armless with Black Base									
	CAL1M30B	976	1018	1063	1148	1236	1323	1408	1495	1668
	Fully Upholstered Back & Seat, Armless with Polished Aluminum Base									
	CAL1M30P	1003	1043	1087	1173	1262	1347	1436	1521	1693
	Fully Upholstered Back & Seat, Adjustable T-Arm with Black Base									
	CAL1M32B	1082	1124	1168	1253	1340	1429	1513	1601	1773
	Fully Upholstered Back & Seat, Adjustable T-Arm with Polished Aluminum Base									
	CAL1M32P	1108	1149	1194	1281	1369	1453	1539	1624	1798
	Fully Upholstered Back & Seat, Fixed Cantilever Arm with Black Base									
	CAL1M31B	1107	1149	1194	1281	1367	1453	1539	1624	1798
	Fully Upholstered Back & Seat, Fixed Cantilever Arm with Polished Aluminum Base									
	CAL1M31P	1135	1177	1218	1306	1393	1479	1565	1653	1825

**ORDERING NOTES:** To add Adjustable Lumbar Support option add "L" to the model number above, "W" for Adjustable Arms Plus, "S" for Seat Slider Plus and upcharge below.

Callisto Option Upcharges	\$ List	\$ List
CAL 133 & Moisture Barrier (per yard)	64	Seat Slider Plus (S)
Soft Wheel Casters	64	Combination Upholstery - dual
Adjustable Lumbar Support (L)	59	
Adjustable Arms Plus (W)	94	
Stool Base	108	

**PRODUCT CODE KEY**

Line	Series	Back Style	Chair Style	Arm Style	Base Style
CAL	1	M	1	0	B
Callisto	Management, Task & Conference Seating	Mid Back	Mesh Back & Seat	Armless	Black Polymer
CAT			2	1	P
Callisto Stool			Mesh Back, Upholstered Seat	Fixed Cantilever Arm	Polished Aluminum
			3	2	
			Fully Upholstered	Adjustable T-Arm	

# C5 | ENVIRONMENTAL SUMMARY

## LEED CI CREDITS



### MATERIAL CONTENT:

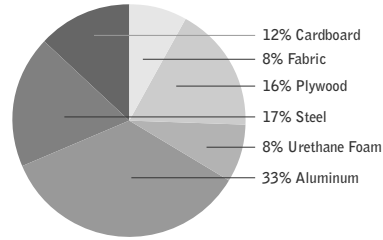

PRE-CONSUMER RECYCLED CONTENT = 24.5%

POST-CONSUMER RECYCLED CONTENT = 19.4%

Up to 60.1% of this C5 product is recyclable at the end of its useful life.

### CONTRIBUTES TO

CREDIT	CONTRIBUTES TO	POINTS
CREDIT 2.1 - 2.2	Construction Waste Management	1-2 point(s)
CREDIT 3.3	Resource Reuse	1 point
CREDIT 4.1	Recycled Content	1 point
CREDIT 4.2	Recycled Content	1 point
CREDIT 4.5	Low Emitting Materials, Systems & Seating	1 point
CREDIT 5.1	Regional Materials*	1 point
CREDIT 7	Certified Wood (MUST BE REQUESTED)	1 point(s)

\*This credit is only applicable if in total 20% of the combined value of the procurement of construction materials and in the furniture are manufactured within a radius of 500 miles. This credit will apply if the installation of the finished product occurs within 500 miles of Kitchener, Ontario.

## level® CERTIFICATION, AIR EMISSIONS AND FSC® CERTIFICATION



### level® CERTIFICATION

BIFMA's e3 Furniture Sustainability Standard is a voluntary, multi-attribute standard that measures the degree of sustainability of furniture. This standard evaluates product and company environmental attributes and compliance systems in a wide range of elements which include Materials, Energy & Atmosphere, Human & Ecosystem Health and Social Responsibility. C5 products have earned level®, BIFMA's sustainability certification program for furniture, certification through third-party verification against the e3 standard.

### AIR-EMISSIONS

All C5 products are supplied with air-emissions certified. Contact customer service for information.



### FSC®

In 2005, Krug received Forest Stewardship Council® (FSC®) Chain-of-Custody certification for our manufacturing facilities. The FSC® Chain-of-Custody tracks certified wood from seedling to final sale. It verifies that the material for our FSC® certified products only come from well-managed, FSC®-certified forests and other controlled sources. FSC® is dedicated to the promotion of responsible forest management worldwide helping to take care of forests for future generations. C5 and other Krug products can be specified with FSC® Certification. Contact customer service for further information, pricing and lead times.



Architects, designers, and building professionals can specify FSC®-certified products in order to achieve a point from the U.S. Green Building Council's Leadership in Energy and Environmental Design (LEED) Rating System.



## ARM STYLES

C5 features four styles of fixed arms; polished aluminum with polymer pad, polished aluminum with upholstered pad, full black polymer arm, and fully upholstered arm.



**Polished Aluminum Arm with Polymer Pad**



**Polished Aluminum Arm with Upholstered Pad**



**Black Polymer Arm**



**Fully Upholstered - Leather or Fabric wrapped upholstered arm with detailed top stitching.**



## MECHANISM OPTIONS

**Swivel-Tilt** - Provides excellent value, durability and simplicity: forward and backward tilt, tilt lock, and 360 degree swivel, as well as vertical adjustment. Right side activated tension control. Available in Black only.



**Knee Tilt** - Right side activated tension control and vertical adjustment. Left side 4 position activated tilt lock. Available in Black powdercoat or Polished Aluminum.

## BASE STYLES

C5 seating is available in two base options. Choose from a black nylon, or a polished aluminum.



**Polished Aluminum**



**Black Glass Reinforced Nylon**



## Jury Base

The C5 series is available with a jury base. Jury base assembly consists of a black 9" diameter conical/cast base for permanently mounting a chair to the floor. Into the base is inserted a black pneumatic gas cylinder with self returning action from rotation, and self returning height feature when exiting the chair. Allows for full 360 degree rotation. Limited degrees of rotation are not available.

## SEAT

The seat has been carefully researched and shaped to provide extended sitting comfort, with a foam density that provides an optimal combination of softness and firmness.

## REPLACEABLE COMPONENTS

C5 chairs are uniquely designed to allow virtually all major components to be field replaced, providing a very cost effective means to significantly extend the life of the product. Seats, backs, mechanisms, arms, base and casters are field replaceable.

## OPTIONS

### COMBINATION UPHOLSTERY

When combination upholstery is with upholstery of the same grade or COM, an upcharge for dual fabrics is **\$33 list** per unit. When graded in combination upholstery is selected, use the highest upholstery grade or contact customer service for a quote. Please provide the fabric specified and a description of where each fabric is to be applied on the product in order to obtain a quote.

### CAL 133 & MOISTURE BARRIER

California Technical Bulletin 133 is a flammability test for seating. Krug offers a compliance method which, in combination with non-flammable upholstery covers, may enable the products to meet certification requirements for this test. This process at the same time also provides the products with a Moisture Barrier - a treatment that helps to prevent the passage of liquids and moisture to inside of upholstered components - thereby conferring sanitary and anti-infection benefits. So when CAL 133 is specified, the product also automatically has a Moisture Barrier, and when a Moisture Barrier is specified, the product also features the compliance method and low flammability features of CAL 133.

The application of this upcharge and the compliance method does not mean that the specific configuration of product and upholstery cover are tested and officially certified as being CAL 133 compliant. If official certification is required, Krug will provide this (through an independent certified testing laboratory) at a charge of \$917 per item, plus the cost of the product to be tested. Lead time for certification testing is typically 4-8 weeks. Krug assumes no responsibility for the testing of our products in combination with upholstery covers, or for the results of any testing conducted. Some specific configurations of product and upholstery have already been tested. Please contact Customer Service for additional information.

## C5 | DIMENSIONS & COM REQUIREMENTS

	Overall Width	Overall Depth	Overall Height	Seat Height min/max	Height of Arms from Floor	Width between Arms	Seat Depth	Shipping Weight	Cube	COM Yardage
<b>Mid Back</b>										
Polished Aluminum Arm with Polymer pad	25	23.8	43.9	18.9 - 22.8	26.5 - 30.4	21	17.8	43	17.4	1.7
Polished Aluminum Arm with Uph. Pad	25	23.8	43.9	18.9 - 22.8	26.5 - 30.4	21	17.8	43	17.4	1.9
Black Polymer Arm	25	23.8	43.9	18.9 - 22.8	26.5 - 30.4	21	17.8	43	17.4	1.7
Upholstered Arm	25	23.8	43.9	18.9 - 22.8	26.5 - 30.4	21	17.8	43	17.4	2.5

<b>High Back</b>										
Polished Aluminum Arm with Polymer Pad	25	23.8	49.9	18.9 - 22.8	26.5 - 30.4	21	17.8	46	20.0	2.1
Polished Aluminum Arm with Uph. Pad	25	23.8	49.9	18.9 - 22.8	26.5 - 30.4	21	17.8	46	20.0	2.3
Black Polymer Arm	25	23.8	49.9	18.9 - 22.8	26.5 - 30.4	21	17.8	46	20.0	2.1
Upholstered Arm	25	23.8	49.9	18.9 - 22.8	26.5 - 30.4	21	17.8	46	20.0	2.9

### MULTIPLE YARDAGE REQUIREMENTS

	Yardage Seat & Back Rest	Yardage Seat only	Yardage Back rest only	Yardage Upholstered Arm Pad (2)	Yardage Full Upholstered Arm (2)
<b>Mid Back</b>					
1 Chair	1.7	.9	1.5	.19	.8
2 Chairs	3.3	1.14	2.4	.19	1.06
3 Chairs	5	2.04	3.2	.19	1.5
4 Chairs	6.6	2.28	4	.19	2.19
<b>High Back</b>					
1 Chair	2.1	.9	1.95	.19	.8
2 Chairs	3.4	1.14	3.1	.19	1.06
3 Chairs	5.5	2.04	4.2	.19	1.5
4 Chairs	7.4	2.28	5.8	.19	2.19

#### DIMENSIONS:

Height measurements of C5 tilter are taken with the pneumatic lift in the lowest position and with a standard height range gas lift. All dimensions are in inches and approximate and are subject to change without notice. Contact Customer Service if dimensions are critical.

#### COM APPROVAL PROCESS:

The approval process is as follows:

1. A sample of the COM fabric must be provided to Krug Customer Service prior to or at time of order.
2. The sample will be reviewed and the customer advised if the fabric is unsuitable.
3. The COM fabric will be inspected when received at the factory to identify any further concerns with its suitability.

#### WEIGHT CAPACITY:

C5 has been tested to ANSI BIFMA.  
C5 is load rated to 300lbs

# C5 EXECUTIVE | MID BACK

DESCRIPTION/MODEL	COM		COL	FABRIC GRADES			LEATHER		
	1	2	3	4	5	6	7	8	9



### FULLY UPHOLSTERED ARM

C5E1MB41A	1381	1447	1514	1609	1716	1810	1918	2053	2188
Polished Aluminum knee tilt, Polished Aluminum base									
C5E1MB42B	1342	1411	1479	1569	1677	1773	1880	2014	2146
Black Aluminum knee tilt, Black base									



### POLISHED ALUMINUM ARM WITH POLYMER PAD

C5E1MB11A	1205	1265	1320	1404	1499	1581	1673	1792	1909
Polished Aluminum knee tilt, Polished Aluminum base									
C5E1MB12B	1168	1227	1285	1367	1461	1540	1636	1752	1870
Black Aluminum knee tilt, Black base									



### BLACK POLYMER ARM

C5E1MB32B	1082	1139	1198	1315	1433	1551	1667	1782	2018
Black Aluminum knee tilt, Black base									



### BLACK POLYMER ARM

C5E1MB33C	1039	1096	1157	1240	1333	1416	1509	1626	1745
Black Swivel tilt, Polished Aluminum base									
C5E1MB33D	1012	1068	1127	1209	1305	1386	1481	1597	1715
Black Swivel tilt, Black base									



### ORDERING NOTES:

For jury base, please add a 'J' for the base style at the end of the model number and add **\$80 list**. Hard casters are the standard and soft wheel casters can be ordered for **\$64 list** per chair. CAL 133 and Moisture Barrier options are available for an upcharge of **\$64 list per yard**. For **UPHOLSTERED ARM PAD** on polished arm versions only select arm style 2 and add upcharge below.

1	2	3	4	5	6	7	8	9
114	120	126	136	145	155	164	178	190

### PRODUCT CODE KEY

Line	Series	Back Style	Arm Style	Mechanism	Base Style
C5E C5 Executive (Horizontal Ribbed)	1 Tilter	MB Mid Back	1 Polished Aluminum Arm with Polymer Pad	1 Polished Aluminum Knee Tilt	A Polished Aluminum Base for Knee Tilt
		HB High Back	2 Polished Aluminum Arm with Uph. Pad	2 Black Aluminum Knee Tilt	B Black Base for Knee Tilt
			3 Black Polymer Arm	3 Black Swivel Tilt	C Polished Aluminum Base for Swivel Tilt
			4 Fully Uph. Arm		D Black Base for Swivel Tilt
					J Jury Base

# C5 EXECUTIVE | HIGH BACK

DESCRIPTION/MODEL	COM		COL		FABRIC GRADES			LEATHER	
	1	2	3	4	5	6	7	8	9



### FULLY UPHOLSTERED ARM

C5E1HB41A	1433	1508	1584	1689	1809	1915	2035	2188	2339
Polished Aluminum knee tilt, Polished Aluminum base									
C5E1HB42B	1393	1468	1545	1651	1772	1878	1998	2147	2299
Black Aluminum knee tilt, Black base									



### POLISHED ALUMINUM ARM WITH POLYMER PAD

C5E1HB11A	1257	1320	1390	1483	1592	1686	1792	1927	2061
Polished Aluminum knee tilt, Polished Aluminum base									
C5E1HB12B	1218	1285	1354	1446	1555	1646	1753	1887	2023
Black Aluminum knee tilt, Black base									



### BLACK POLYMER ARM

C5E1HB32B	1134	1198	1266	1358	1465	1560	1667	1802	1935
Black Aluminum knee tilt, Black base									



### BLACK POLYMER ARM

C5E1HB33C	1090	1158	1226	1318	1425	1519	1629	1764	1896
Black Swivel tilt, Polished Aluminum base									
C5E1HB33D	1062	1127	1197	1289	1396	1492	1597	1732	1866
Black Swivel tilt, Black base									



### ORDERING NOTES:

For jury base, please add a 'J' for the base style at the end of the model number and add **\$80 list**.  
 Hard casters are the standard and soft wheel casters can be ordered for **\$64 list** per chair. CAL 133 and Moisture Barrier options are available for an upcharge of **\$64 list per yard**.  
 For **UPHOLSTERED ARM PAD** on polished arm versions only select arm style 2 and add upcharge below.

1	2	3	4	5	6	7	8	9
114	120	126	136	145	155	164	178	190

### PRODUCT CODE KEY

Line	Series	Back Style	Arm Style	Mechanism	Base Style
C5E C5 Executive (Horizontal Ribbed)	1 Tilter	MB Mid Back	1 Polished Aluminum Arm with Polymer Pad	1 Polished Aluminum Knee Tilt	A Polished Aluminum Base for Knee Tilt
		HB High Back	2 Polished Aluminum Arm with Uph. Pad	2 Black Aluminum Knee Tilt	B Black Base for Knee Tilt
			3 Black Polymer Arm	3 Black Swivel Tilt	C Polished Aluminum Base for Swivel Tilt
			4 Fully Uph. Arm		D Black Base for Swivel Tilt
					J Jury Base

# C5 CONTEMPORARY | MID BACK

DESCRIPTION/MODEL	COM		COL		FABRIC GRADES			LEATHER	
	1	2	3	4	5	6	7	8	9



### FULLY UPHOLSTERED ARM

C5C1MB41A	1245	1314	1380	1477	1583	1673	1781	1918	2053
Polished Aluminum knee tilt, Polished Aluminum base									
C5C1MB42B	1216	1284	1351	1445	1555	1645	1752	1886	2020
Black Aluminum knee tilt, Black base									



### POLISHED ALUMINUM ARM WITH POLYMER PAD

C5C1MB11A	1068	1127	1187	1270	1361	1446	1538	1659	1774
Polished Aluminum knee tilt, Polished Aluminum base									
C5C1MB12B	1042	1098	1158	1240	1334	1416	1510	1629	1746
Black Aluminum knee tilt, Black base									



### BLACK POLYMER ARM

C5C1MB32B	943	1003	1062	1143	1239	1319	1415	1533	1647
Black Aluminum knee tilt, Black base									



### BLACK POLYMER ARM

C5C1MB33C	906	962	1022	1106	1199	1282	1376	1493	1610
Black Swivel tilt, Polished Aluminum base									
C5C1MB33D	875	934	992	1074	1169	1252	1346	1463	1581
Black Swivel tilt, Black base									



### ORDERING NOTES:

For jury base, please add a 'J' for the base style at the end of the model number and add **\$80 list**.  
 Hard casters are the standard and soft wheel casters can be ordered for **\$64 list** per chair. CAL 133 and Moisture Barrier options are available for an upcharge of **\$64 list per yard**.  
 For **UPHOLSTERED ARM PAD** on polished arm versions only select arm style 2 and add upcharge below.

1	2	3	4	5	6	7	8	9
114	120	126	136	145	155	164	178	190

### PRODUCT CODE KEY

Line	Series	Back Style	Arm Style	Mechanism	Base Style
C5C C5 Contemporary	1 Tilter	MB Mid Back	1 Polished Aluminum Arm with Polymer Pad	1 Polished Aluminum Knee Tilt	A Polished Aluminum Base for Knee Tilt
		HB High Back	2 Polished Aluminum Arm with Uph. Pad	2 Black Aluminum Knee Tilt	B Black Base for Knee Tilt
			3 Black Polymer Arm	3 Black Swivel Tilt	C Polished Aluminum Base for Swivel Tilt
			4 Fully Uph. Arm		D Black Base for Swivel Tilt
					J Jury Base

# C5 CONTEMPORARY | HIGH BACK

DESCRIPTION/MODEL	COM		COL	FABRIC GRADES			LEATHER		
	1	2	3	4	5	6	7	8	9



FULLY UPHOLSTERED ARM

C5C1HB41A	1292	1369	1443	1548	1669	1776	1896	2046	2196
Polished Aluminum knee tilt, Polished Aluminum base									
C5C1HB42B	1263	1336	1415	1519	1640	1746	1866	2018	2168
Black Aluminum knee tilt, Black base									



POLISHED ALUMINUM ARM WITH POLYMER PAD

C5C1HB11A	1117	1183	1251	1346	1452	1545	1653	1788	1922
Polished Aluminum knee tilt, Polished Aluminum base									
C5C1HB12B	1087	1153	1223	1315	1421	1515	1623	1756	1892
Black Aluminum knee tilt, Black base									



BLACK POLYMER ARM

C5C1HB32B	990	1059	1124	1218	1328	1420	1528	1662	1796
Black Aluminum knee tilt, Black base									



BLACK POLYMER ARM

C5C1HB33C	953	1018	1087	1179	1286	1381	1487	1622	1755
Black Swivel tilt, Polished Aluminum base									
C5C1HB33D	922	988	1058	1149	1258	1351	1458	1592	1728
Black Swivel tilt, Black base									



**ORDERING NOTES:**

For jury base, please add a 'J' for the base style at the end of the model number and add **\$80 list**.  
 Hard casters are the standard and soft wheel casters can be ordered for **\$64 list** per chair. CAL 133 and Moisture Barrier options are available for an upcharge of **\$64 list per yard**.  
 For **UPHOLSTERED ARM PAD** on polished arm versions only select arm style 2 and add upcharge below.

1	2	3	4	5	6	7	8	9
114	120	126	136	145	155	164	178	190

**PRODUCT CODE KEY**

Line	Series	Back Style	Arm Style	Mechanism	Base Style
C5C C5 Contemporary	1 Tilter	MB Mid Back	1 Polished Aluminum Arm with Polymer Pad	1 Polished Aluminum Knee Tilt	A Polished Aluminum Base for Knee Tilt
		HB High Back	2 Polished Aluminum Arm with Uph. Pad	2 Black Aluminum Knee Tilt	B Black Base for Knee Tilt
			3 Black Polymer Arm	3 Black Swivel Tilt	C Polished Aluminum Base for Swivel Tilt
			4 Fully Uph. Arm		D Black Base for Swivel Tilt
					J Jury Base

# C5 PULLS | MID BACK

DESCRIPTION/MODEL	COM		COL		FABRIC GRADES			LEATHER	
	1	2	3	4	5	6	7	8	9



### FULLY UPHOLSTERED ARM

C5P1MB41A	1267	1334	1402	1495	1603	1695	1804	1938	2072
Polished Aluminum knee tilt, Polished Aluminum base									
C5P1MB42B	1229	1295	1361	1456	1565	1660	1767	1899	2034
Black Aluminum knee tilt, Black base									



### POLISHED ALUMINUM ARM WITH POLYMER PAD

C5P1MB11A	1090	1149	1207	1290	1384	1466	1560	1677	1796
Polished Aluminum knee tilt, Polished Aluminum base									
C5P1MB12B	1054	1111	1170	1253	1347	1429	1524	1640	1756
Black Aluminum knee tilt, Black base									



### BLACK POLYMER ARM

C5P1MB32B	963	1026	1084	1166	1260	1342	1437	1555	1669
Black Aluminum knee tilt, Black base									



### BLACK POLYMER ARM

C5P1MB33C	928	985	1044	1124	1222	1303	1395	1513	1632
Black Swivel tilt, Polished Aluminum base									
C5P1MB33D	896	956	1015	1095	1192	1272	1367	1483	1601
Black Swivel tilt, Black base									



### ORDERING NOTES:

For jury base, please add a 'J' for the base style at the end of the model number and add **\$80 list**.

Hard casters are the standard and soft wheel casters can be ordered for **\$64 list** per chair. CAL 133 and Moisture Barrier options are available for an upcharge of **\$64 list per yard**.

For **UPHOLSTERED ARM PAD** on polished arm versions only select arm style 2 and add upcharge below.

1	2	3	4	5	6	7	8	9
114	120	126	136	145	155	164	178	190

### PRODUCT CODE KEY

Line	Series	Back Style	Arm Style	Mechanism	Base Style
C5P C5 Pulls	1 Tilter	MB Mid Back	1 Polished Aluminum Arm with Polymer Pad	1 Polished Aluminum Knee Tilt	A Polished Aluminum Base for Knee Tilt
		HB High Back	2 Polished Aluminum Arm with Uph. Pad	2 Black Aluminum Knee Tilt	B Black Base for Knee Tilt
			3 Black Polymer Arm	3 Black Swivel Tilt	C Polished Aluminum Base for Swivel Tilt
			4 Fully Uph. Arm		D Black Base for Swivel Tilt
					J Jury Base

# C5 PULLS | HIGH BACK

DESCRIPTION/MODEL	COM		COL		FABRIC GRADES			LEATHER	
	1	2	3	4	5	6	7	8	9



### FULLY UPHOLSTERED ARM

C5P1HB41A	1323	1398	1477	1581	1703	1808	1927	2079	2229
Polished Aluminum knee tilt, Polished Aluminum base									
C5P1HB42B	1286	1360	1438	1540	1663	1769	1890	2040	2192
Black Aluminum knee tilt, Black base									



### POLISHED ALUMINUM ARM WITH POLYMER PAD

C5P1HB11A	1147	1215	1283	1376	1483	1578	1685	1818	1954
Polished Aluminum knee tilt, Polished Aluminum base									
C5P1HB12B	1110	1177	1244	1336	1445	1538	1645	1779	1914
Black Aluminum knee tilt, Black base									



### BLACK POLYMER ARM

C5P1HB32B	1022	1089	1157	1251	1357	1452	1559	1692	1827
Black Aluminum knee tilt, Black base									



### BLACK POLYMER ARM

C5P1HB33C	962	1031	1096	1193	1302	1393	1501	1634	1771
Black Swivel tilt, Polished Aluminum base									
C5P1HB33D	934	1002	1066	1164	1270	1361	1473	1606	1741
Black Swivel tilt, Black base									



### ORDERING NOTES:

For jury base, please add a 'J' for the base style at the end of the model number and add **\$80 list**.  
 Hard casters are the standard and soft wheel casters can be ordered for **\$64 list per chair**. CAL 133 and Moisture Barrier options are available for an upcharge of **\$64 list per yard**.  
 For **UPHOLSTERED ARM PAD** on polished arm versions only select arm style 2 and add upcharge below.

1	2	3	4	5	6	7	8	9
114	120	126	136	145	155	164	178	190

### PRODUCT CODE KEY

Line	Series	Back Style	Arm Style	Mechanism	Base Style
C5P C5 Pulls	1 Tilter	MB Mid Back	1 Polished Aluminum Arm with Polymer Pad	1 Polished Aluminum Knee Tilt	A Polished Aluminum Base for Knee Tilt
		HB High Back	2 Polished Aluminum Arm with Uph. Pad	2 Black Aluminum Knee Tilt	B Black Base for Knee Tilt
			3 Black Polymer Arm	3 Black Swivel Tilt	C Polished Aluminum Base for Swivel Tilt
			4 Fully Uph. Arm		D Black Base for Swivel Tilt
					J Jury Base



LEED CI CREDITS



MATERIAL CONTENT:

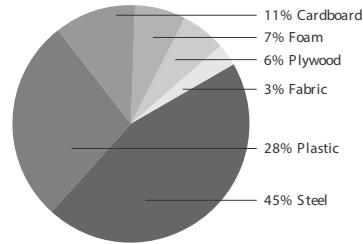

PRE-CONSUMER

RECYCLED CONTENT = 11.5%

POST-CONSUMER

RECYCLE CONTENT = 21.91%

Up to 47.7% of Aqua product is recyclable at the end of its useful life.

CONTRIBUTES TO

CREDIT 2.1 - 2.2	Construction Waste Management	1-2 point(s)
CREDIT 3.3	Resource Reuse	1 point
CREDIT 4.1	Recycled Content	1 point
CREDIT 4.2	Recycled Content	1 point
CREDIT 4.5	Low Emitting Materials, Systems & Seating	1 point
CREDIT 5.1	Regional Materials*	1 point
CREDIT 7	Certified Wood (MUST BE REQUESTED)	1 point(s)

\*This credit is only applicable if in total 20% of the combined value of the procurement of construction materials and in the furniture are manufactured within a radius of 500 miles. This credit will apply if the installation of the finished product occurs within 500 miles of Kitchener, Ontario.

level® CERTIFICATION, AIR EMISSIONS AND FSC® CERTIFICATION



**level® CERTIFICATION**

BIFMA's e3 Furniture Sustainability Standard is a voluntary, multi-attribute standard that measures the degree of sustainability of furniture. This standard evaluates product and company environmental attributes and compliance systems in a wide range of elements which include Materials, Energy & Atmosphere, Human & Ecosystem Health and Social Responsibility. Aqua products have earned level®, BIFMA's sustainability certification program for furniture, certification through third-party verification against the e3 standard.

**AIR-EMISSIONS**

All Aqua products are supplied with air-emissions certified. Contact customer service for information.



**FSC®**

In 2005, Krug received Forest Stewardship Council® (FSC®) Chain-of-Custody certification for our manufacturing facilities. The FSC® Chain-of-Custody tracks certified wood from seedling to final sale. It verifies that the material for our FSC® certified products only come from well-managed, FSC®-certified forests and other controlled sources. FSC® is dedicated to the promotion of responsible forest management worldwide helping to take care of forests for future generations. Aqua and other Krug products can be specified with FSC® Certification. Contact customer service for further information, pricing and lead times.



Architects, designers, and building professionals can specify FSC®-certified products in order to achieve a point from the US Green Building Council's Leadership in Energy and Environmental Design (LEED) Rating System.

# AQUA | FEATURES & OPTIONS

## ARM STYLE

Four arm styles are available on Aqua - Armless, T-Arm, Height Adjustable T-Arm and Fixed Cantilever Arm.



**T-Arm** - A comfortable and supportive urethane pad, 10" in length by 3.5" wide, which can be field replaced if damaged, as can the entire arm.



**Height Adjustable T-Arm** - In addition to the same features as the T-Arm version, the arm pad has a 3-position rotation horizontally: center, left and right. The arm pad also adjusts forward and rearward in 5 positions, and is height-adjustable in 9 positions ranging over 4".



**Cantilever Arm** - The top surface of this arm has been proportioned to provide comfortable arm support, with a resting surface of 10" x 2".

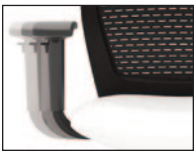

## ARM WIDTH ADJUSTMENT

Width adjustment is a standard feature on Aqua arm styles. T-Arms, and Height Adjustable T-Arms, can be width adjusted, operated by the handwheel located under the seat. The T-Arms are width adjustable in a range of 1.5" per arm, or 3" per chair. Cantilever arms can be width adjusted with tools instead of a handwheel, with adjustment range of 1" per arm, or 2" per chair.



## MECHANISM OPTIONS

**Synchro-Tilt Mechanism** - There are 5 recline/lock positions, in addition to a full range of free-flowing movement. The forward position of the pivot point allows the back and seat to adjust in a 2:1 ratio synchronously, providing comfortable recline of the back with minimal incline of the seat.



**Swivel-Tilt Mechanism** - Provides excellent value, durability and simplicity: forward and backward tilt, tilt lock, and 360 degree swivel, as well as vertical adjustment - ideal for short-term use environments, such as meeting rooms, where numerous adjustability features may not be desirable or necessary. Aqua Stools are only available with a Swivel Mechanism.



**Seat-Slider Option** - Available on the Synchro-Tilt Mechanism, this offers a 2" range of forward and rearward adjustment of the seat, with a locking feature. The addition of the seat slider adds 1/2" to the height of the seat and arms.



## BASE STYLE

Aqua seating is available with Black five star base and black gas cylinder, or optional Polished Aluminum five star base and chrome cylinder for an upcharge of **\$40 list**. Both bases come standard with dual wheel black casters. Hard casters are the standard and soft wheel casters can be ordered for **\$64 list** per chair. Aqua bases are also available with a fixed height option for an upcharge of **\$40 list** per chair.



## JURY BASE

The Aqua series is available with a jury base. Jury base assembly consists of a black 9" diameter conical/cast base for permanently mounting a chair to the floor. Into the base is inserted a black pneumatic gas cylinder with self returning action from rotation, and self returning height feature when exiting the chair. Allows for full 360 degree rotation. Limited degrees of rotation are not available.



## MESH BACKS

Mesh Backs are made of breathable polyester elastomers, the Mesh Back has an ideal tension that provides comfortable lumbar and thoracic support for extended use and healthy sitting - enhanced further with the air circulation provided by the mesh's unique design, and an easy-to-clean surface. The mesh back is also replaceable. Mesh colors available:

- White • Warm Grey • Black • Sky • Clay • Neo • Sunset • Cardinal



## UPHOLSTERED BACKS

A unique construction with a mesh suspension core, combined with extensively-researched ergonomic curvature, gives the Aqua back a form-fitting comfort and a thin profile that is designed for healthy long-term sitting.

## BACK TENSION

Back tension on the mechanism is controlled with an adjustment knob under the seat. It has been designed to provide a range of back tension adjustment suitable for users of varying sizes and preferences.

## REPLACEABLE COMPONENTS

Aqua chairs are uniquely designed to allow virtually all major components to be field replaced, providing a very cost effective means to significantly extend the life of the product. Seats, backs, mechanisms, arms, base and casters are field replaceable. Pricing and model numbers can be viewed online at [www.krug.ca](http://www.krug.ca).

## OPTIONS

### COMBINATION UPHOLSTERY

When combination upholstery is with upholstery of the same grade or COM, an upcharge for dual fabrics is **\$33 list** per unit. When graded in combination upholstery is selected, use the highest upholstery grade or contact customer service for a quote. Please provide the fabric specified and a description of where each fabric is to be applied on the product in order to obtain a quote.

### CAL 133 & MOISTURE BARRIER

California Technical Bulletin 133 is a flammability test for seating. Krug offers a compliance method which, in combination with non-flammable upholstery covers, may enable the products to meet certification requirements for this test. This process at the same time also provides the products with a Moisture Barrier - a treatment that helps to prevent the passage of liquids and moisture to inside of upholstered components - thereby conferring sanitary and anti-infection benefits. So when CAL 133 is specified, the product also automatically has a Moisture Barrier, and when a Moisture Barrier is specified, the product also features the compliance method and low flammability features of CAL 133.

The application of this upcharge and the compliance method does not mean that the specific configuration of product and upholstery cover are tested and officially certified as being CAL 133 compliant. If official certification is required, Krug will provide this (through an independent certified testing laboratory) at a charge of \$917 per item, plus the cost of the product to be tested. Lead time for certification testing is typically 4-8 weeks. Krug assumes no responsibility for the testing of our products in combination with upholstery covers, or for the results of any testing conducted. Some specific configurations of product and upholstery have already been tested. Please contact Customer Service for additional information.

# AQUA | DIMENSIONS & COM REQUIREMENTS

	Overall Width	Overall Depth	Overall Height	Seat Height min/max	Height of Arms from Floor	Width between Arms	Seat Depth	Shipping Weight	Cube	COM Yardage
<b>Standard Height</b>										
Mesh Back										
Armless	20	23	38.3	17.3-21.7	N/A	N/A	17.4	40	18	0.75
T-Arm	26.5	23	38.3	17.3-21.7	25.5-30	17-20	17.4	40	18	0.75
Height Adjustable T-Arm	26.5	23	38.3	17.3-21.7	25.5-30	17-20	17.4	40	18	0.75
Cantilever	25.8	23	38.3	17.3-21.7	25.5-30	21-23	17.4	40	18	0.75
Upholstered Back										
Armless	20	23	38.3	17.3-21.7	N/A	N/A	17.4	41	18	1.4
T-Arm	26.5	23	38.3	17.3-21.7	25.5-30	17-20	17.4	41	18	1.4
Height Adjustable T-Arm	26.5	23	38.3	17.3-21.7	25.5-30	17-20	17.4	41	18	1.4
Cantilever	25.8	23	38.3	17.3-21.7	25.5-30	21-23	17.4	41	18	1.4

<b>Stool Height</b>										
Mesh Back										
Armless	20	23	43.8	24-31	N/A	N/A	17.4	40	20	0.75
T-Arm	26.5	23	43.8	24-31	32.5-36.75	17-20	17.4	40	20	0.75
Height Adjustable T-Arm	26.5	23	43.8	24-31	32.5-36.75	17-20	17.4	40	20	0.75
Cantilever	25.8	23	43.8	24-31	32.5-36.75	21-23	17.4	40	20	0.75
Upholstered Back										
Armless	20	23	43.8	24-31	N/A	N/A	17.4	41	20	1.4
T-Arm	26.5	23	43.8	24-31	32.5-36.75	17-20	17.4	41	20	1.4
Height Adjustable T-Arm	26.5	23	43.8	24-31	32.5-36.75	17-20	17.4	41	20	1.4
Cantilever	25.8	23	43.8	24-31	32.5-36.75	21-23	17.4	41	20	1.4

## MULTIPLE YARDAGE REQUIREMENTS

	Yardage MESH BACK Seats Only	Yardage UPHOLSTERED BACK Back Only	Yardage UPHOLSTERED Full Chair
1 Chair	.75	.94	1.28
2 Chairs	.75	1.8	2.53
3 Chairs	1.5	2.74	3.81
4 Chairs	1.5	3.6	5.06

Height measurements of Aqua tilter and teller chairs are taken with the pneumatic lift in the lowest position and with a standard height range gas lift.

All dimensions are in inches and approximate and are subject to change without notice. Contact Customer Service if dimensions are critical.

The approval process is as follows:

1. A sample of the COM fabric must be provided to Krug Customer Service prior to or at time of order.
2. The sample will be reviewed and the customer advised if the fabric is unsuitable.
3. The COM fabric will be inspected when received at the factory to identify any further concerns with its suitability.

### Aqua Standard Height



Armless



Fixed T- Arms



Adjustable T - Arms



Cantilever Arms





### Aqua Stool Height



### WEIGHT CAPACITY:

Aqua has been tested to 300lbs.

# AQUA | MESH BACK

DESCRIPTION/MODEL	COM		COL		FABRIC GRADES			LEATHER		
	1	2	3	4	5	6	7	8	9	
	Aqua Mesh Back, Armless with Swivel Tilt, 5 star base in black AQU1M03B	829	843	854	883	912	940	968	997	1053
	Aqua Mesh Back, Armless with Synchro Tilt, 5 star base in black AQU1M01B	852	868	882	910	939	963	992	1021	1081
	Aqua Mesh Back, Armless with Synchro Tilt/Seat Slider, 5 star base in black AQU1M02B	900	914	929	957	985	1014	1039	1067	1126
	Aqua Mesh Back, T-Arm in black with Swivel Tilt, 5 star base in black AQU1M13B	976	987	1002	1031	1060	1087	1116	1141	1199
	Aqua Mesh Back, T-Arm in black with Synchro Tilt, 5 star base in black AQU1M11B	1001	1015	1030	1056	1084	1111	1140	1169	1224
	Aqua Mesh Back, T-Arm in black, with Synchro Tilt/Seat Slider, 5 star base in black AQU1M12B	1046	1062	1074	1102	1131	1161	1190	1216	1271
	Aqua Mesh Back, Height Adjustable T-Arm in black with Swivel Tilt, 5 star base in black AQU1M23B	1019	1034	1048	1080	1107	1134	1162	1191	1246
	Aqua Mesh Back, Height Adjustable T-Arm in black, with Synchro Tilt, 5 star base in black AQU1M21B	1045	1061	1073	1102	1131	1161	1190	1215	1271
	Aqua Mesh Back, Height Adjustable T-Arm in black with Synchro Tilt/Seat Slider, 5 star base in black AQU1M22B	1093	1108	1121	1151	1178	1206	1236	1263	1317
	Aqua Mesh Back, Cantilever Arm in black with Swivel Tilt, 5 star base in black AQU1M33B	889	905	916	943	974	1002	1031	1060	1114
	Aqua Mesh Back, Cantilever Arm in black, with Synchro Tilt, 5 star base in black AQU1M31B	914	929	942	973	1001	1029	1056	1084	1140
	Aqua Mesh Back, Cantilever Arm in black with Synchro Tilt/Seat Slider, 5 star base in black AQU1M32B	960	977	989	1018	1046	1073	1102	1131	1190

## ORDERING NOTES

For jury base version, please add a 'J' for the base style at the end of the model number and add **\$80 list**.

CAL 133 and Moisture Barrier options are available for an upcharge of **\$64 list per yard**.

For Polished Aluminum base please change the last letter in the model number from "B" to a "C" and add **\$40 list**.

Hard casters are the standard and **soft wheel casters** can be ordered for **\$64 list** per chair.

Mesh Colors available are listed on page 17.



Armless



T-Arm



Height Adjustable  
T-Arm







Cantilever

## PRODUCT CODE KEY

Line	Series	Back Style	Arm Style	Mechanism	Base Style
AQU	1	M	0	1	B
Aqua	Management, Task & Conference Seating	Mesh Back	Armless	Synchro Tilt	Black (5 Star Base)
		U	1	2	J
		Upholstered	T-Arm	Synchro Tilt/Seat Slider	(Jury Base)
			2	3	C
			Height Adjustable T-Arm	Swivel Tilt	Polished Aluminum
			3		
			Cantilever		

# AQUA | UPHOLSTERED BACK

DESCRIPTION/MODEL	COM		COL		FABRIC GRADES			LEATHER		
	1	2	3	4	5	6	7	8	9	
	Aqua Upholstered Back, Armless with Swivel Tilt, 5 star base in black									
	AQU1U03B	943	992	1043	1141	1240	1338	1438	1536	1732
	Aqua Upholstered Back, Armless with Synchro Tilt, 5 star base in black									
AQU1U01B	971	1018	1067	1168	1266	1363	1463	1560	1758	
Aqua Upholstered Back, Armless with Synchro Tilt/Seat Slider, 5 star base in black										
AQU1U02B	1017	1065	1117	1215	1312	1414	1510	1609	1806	
	Aqua Upholstered Back, T-Arm in black, with Swivel Tilt, 5 star base in black									
	AQU1U13B	1092	1140	1191	1286	1387	1484	1585	1683	1881
	Aqua Upholstered Back, T-Arm in black, with Synchro Tilt, 5 star base in black									
AQU1U11B	1117	1166	1215	1314	1414	1512	1610	1708	1907	
Aqua Upholstered Back, T-Arm in black, with Synchro Tilt/Seat Slider, 5 star base in black										
AQU1U12B	1164	1213	1263	1360	1460	1559	1659	1755	1954	
	Aqua Upholstered Back, Height Adjustable T-Arm in black with Swivel Tilt, 5 star base in black									
	AQU1U23B	1138	1187	1237	1335	1433	1533	1603	1730	1926
	Aqua Upholstered Back, Height Adjustable T-Arm in black with Synchro Tilt, 5 star base in black									
AQU1U21B	1164	1213	1263	1359	1460	1558	1659	1755	1954	
Aqua Upholstered Back, Height Adjustable T-Arm in black, with Synchro Tilt/Seat Slider, 5 star base in black										
AQU1U22B	1212	1262	1310	1408	1508	1606	1704	1803	2001	
	Aqua Upholstered Back, Cantilever Arm in black with Swivel Tilt, 5 star base in black									
	AQU1U33B	1006	1056	1106	1203	1303	1401	1499	1597	1795
	Aqua Upholstered Back, Cantilever Arm in black with Synchro Tilt, 5 star base in black									
AQU1U31B	1032	1082	1131	1229	1328	1425	1526	1622	1819	
Aqua Upholstered Back, Cantilever Arm in black, with Synchro Tilt/Seat Slider, 5 star base in black										
AQU1U32B	1081	1127	1178	1276	1374	1477	1570	1669	1867	

**ORDERING NOTES**



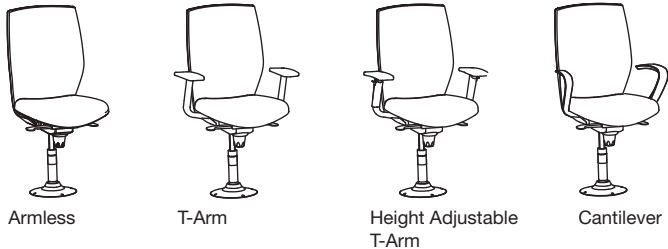





For jury base version, please add a 'J' for the base style at the end of the model number and add **\$80 list**.  
 CAL 133 and Moisture Barrier options are available for an upcharge of **\$64 list per yard**.  
 For Polished Aluminum base please change the last letter in the model number from "B" to a "C" and add **\$40 list**.  
 Hard casters are the standard and **soft wheel casters** can be ordered for **\$64 list** per chair.  
 Mesh Colors available are listed on page 17.



**PRODUCT CODE KEY**

Line	Series	Back Style	Arm Style	Mechanism	Base Style
AQU	1	M	0	1	B
Aqua	Management, Task & Conference Seating	Mesh Back	Armless	Synchro Tilt	Black (5 Star Base)
		U	1	2	J
		Upholstered	T-Arm	Synchro Tilt/Seat Slider	(Jury Base)
			2	3	C
			Height Adjustable T-Arm	Swivel Tilt	Polished Aluminum
			3		
			Cantilever		

# AQUA | STOOL

DESCRIPTION/MODEL	COM		COL		FABRIC GRADES			LEATHER	
	1	2	3	4	5	6	7	8	9
 Aqua Stool Mesh Back, Armless, 5 star in black with glides or casters AQT1M0G (glides)	895	910	924	954	982	1008	1036	1064	1121
	AQT1M0B (casters)								
 Aqua Stool Upholstered Back, Armless, 5 star base in black with glides or casters AQT1U0G (glides)	1014	1062	1111	1209	1309	1408	1506	1606	1802
	AQT1U0B (casters)								
 Aqua Stool Mesh Back, T-Arm in black, with 5 star base in black with glides or casters AQT1M1G (glides)	1043	1058	1068	1097	1126	1155	1183	1212	1268
	AQT1M1B (casters)								
 Aqua Stool Upholstered Back, T-Arm in black, 5 star base in black with glides or casters AQT1U1G (glides)	1161	1207	1257	1357	1455	1556	1653	1749	1947
	AQT1U1B (casters)								
 Aqua Stool Mesh Back, Height Adjustable T-Arm in black, 5 star base in black with glides or casters AQT1M2G (glides)	1090	1102	1117	1143	1172	1202	1230	1257	1314
	AQT1M2B (casters)								
 Aqua Stool Upholstered Back, Height Adjustable T-Arm in black, 5 star base in black with glides or casters AQT1U2G (glides)	1206	1254	1306	1403	1503	1601	1699	1798	1995
	AQT1U2B (casters)								
 Aqua Stool Mesh Back, Cantilever Arm in black, 5 star base in black with glides or casters AQT1M3G (glides)	957	973	985	1015	1043	1067	1096	1126	1183
	AQT1M3B (casters)								
 Aqua Stool Upholstered Back, Cantilever Arm in black, 5 star base in black with glides or casters AQT1U3G (glides)	1073	1122	1172	1271	1371	1467	1567	1667	1862
	AQT1U3B (casters)								

## ORDERING NOTES

Hard casters are the standard and **soft wheel casters** can be ordered for **\$64 list** per chair.

CAL 133 and Moisture Barrier options are available for an upcharge of **\$64 list per yard**.

Mesh Colors available are listed on page 17.

Aqua Stools are only available with a Swivel Mechanism.

## PRODUCT CODE KEY

Line	Series	Back Style	Arm Style	Base Style
AQT	1	M	0	B
Aqua Stool	Management, Task & Conference Seating	Mesh Back	Armless	Black (Casters)
		U	1	G
		Upholstered	T-Arm	(Glides)
			2	
			Height Adjustable T-Arm	
			3	
			Cantilever	

## LEED CI CREDITS



### MATERIAL CONTENT:

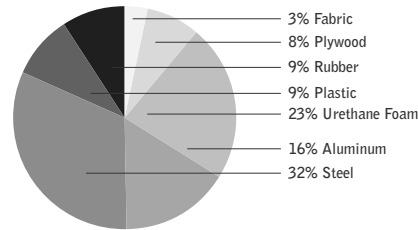

### PRE-CONSUMER

RECYCLED CONTENT = 17.95%

### POST-CONSUMER

RECYCLED CONTENT = 17.72%

Up to 61.36% of Dorso E product is recyclable at the end of its useful life.

### CONTRIBUTES TO

CREDIT 2.1 - 2.2	Construction Waste Management	1-2 point(s)
CREDIT 3.3	Resource Reuse	1 point
CREDIT 4.1	Recycled Content	1 point
CREDIT 4.2	Recycled Content	1 point
CREDIT 4.5	Low Emitting Materials, Systems & Seating	1 point
CREDIT 5.1	Regional Materials*	1 point
CREDIT 7	Certified Wood (MUST BE REQUESTED)	1 point(s)

\*This credit is only applicable if in total 20% of the combined value of the procurement of construction materials and in the furniture are manufactured within a radius of 500 miles. This credit will apply if the installation of the finished product occurs within 500 miles of Kitchener, Ontario.

## level® CERTIFICATION, AIR EMISSIONS AND FSC® CERTIFICATION



### level® CERTIFICATION

BIFMA's e3 Furniture Sustainability Standard is a voluntary, multi-attribute standard that measures the degree of sustainability of furniture. This standard evaluates product and company environmental attributes and compliance systems in a wide range of elements which include Materials, Energy & Atmosphere, Human & Ecosystem Health and Social Responsibility. Dorso products have earned level®, BIFMA's sustainability certification program for furniture, certification through third-party verification against the e3 standard.

### AIR-EMISSIONS

All Dorso products are supplied with air-emissions certified. Contact customer service for information.



### FSC®

In 2005, Krug received Forest Stewardship Council® (FSC®) Chain-of-Custody certification for our manufacturing facilities. The FSC® Chain-of-Custody tracks certified wood from seedling to final sale. It verifies that the material for our FSC® certified products only come from well-managed, FSC®-certified forests and other controlled sources. FSC® is dedicated to the promotion of responsible forest management worldwide helping to take care of forests for future generations. Dorso and other Krug products can be specified with FSC® Certification. Contact customer service for further information, pricing and lead times.



Architects, designers, and building professionals can specify FSC®-certified products in order to achieve a point from the U.S. Green Building Council's Leadership in Energy and Environmental Design (LEED) Rating System.

# DORSO E & T | FEATURES



## ARM STYLES

Optional fixed cantilever or an adjustable black arm constructed of die cast metal with textured plastic arm pads. The adjustable arms feature seven height adjustment positions, with a total adjustment range of 2.75". All Dorso models are also available in armless versions.

## E-LINE

Fixed cantilever and adjustable arms are available in Black, Silver Metallic or Polished Chrome accent finishes to match metal base. The fixed arm is also available in black textured plastic and upholstered fabric/leather version.

## T-LINE

Fixed cantilever and adjustable arms are available in black textured plastic.



## BASE STYLES

### E-LINE & T-LINE

Dorso seating features optional Silver Metallic, polished Chrome or Black finish and dual wheel casters.



## DORSO CONTROLS

All Dorso E-Line and T-Line come with synchro tilt mechanism. The tilt adjustment range offers five recline-lock positions, as well as free flowing movement. The forward pivot mechanism allows the back and the seat to articulate synchronously in a 2:1 ratio, so that upward tilt of the seat is minimized as the back reclines.



## BACK HEIGHT

Back height adjustment is an option on Dorso E & T Line. It offers an adjustment range of 11 positions, over a 2" range of movement. Back height adjustment is operated while in the seated position, by placing the right hand on the right bottom of the chair back, and the left hand on the left bottom of the chair back. The back is lifted and clicked into the desired height. Raising the back to the highest position releases the back height lock so it can be lowered.

## SEAT HEIGHT

In the seated position, a pull upwards on the height adjustment lever located under the seat of the user's right side adjusts the height up or down with a total height range of 4.5".

## BACK TENSION

Back tension on the mechanism is controlled with an adjustment knob under the seat. It has been designed to provide a range of back tension adjustment suitable for users of varying sizes and preferences.

## SEAT SLIDER

All Dorso tilters are available with an optional seat slider mechanism featuring a 2" range of adjustment front to back when seated. The lever to activate this feature is located under the seat of the user's right side and is activated by an upward pull of the lever.

## CAL 133 & MOISTURE BARRIER

California Technical Bulletin 133 is a flammability test for seating. Krug offers a compliance method which, in combination with non-flammable upholstery covers, may enable the products to meet certification requirements for this test. This process at the same time also provides the products with a Moisture Barrier - a treatment that helps to prevent the passage of liquids and moisture to inside of upholstered components - thereby conferring sanitary and anti-infection benefits. So when CAL 133 is specified, the product also automatically has a Moisture Barrier, and when a Moisture Barrier is specified, the product also features the compliance method and low flammability features of CAL 133.

The application of this upcharge and the compliance method does not mean that the specific configuration of product and upholstery cover are tested and officially certified as being CAL 133 compliant. If official certification is required, Krug will provide this (through an independent certified testing laboratory) at a charge of \$917 per item, plus the cost of the product to be tested. Lead time for certification testing is typically 4-8 weeks. Krug assumes no responsibility for the testing of our products in combination with upholstery covers, or for the results of any testing conducted. Some specific configurations of product and upholstery have already been tested. Please contact Customer Service for additional information.



# DORSO E-LINE | DIMENSIONS & COM REQUIREMENTS

Dorso E features a generous seat & back that provides unparalleled comfort and support.

Model Number		Overall Width	Overall Depth	Overall Height	Seat Height Min/Max	Height of Arms from Floor	Width between Arms	Height Range	Seat Depth	Shipping Weight	Cube	COM Yardage
DEC1-HB/DES1-HB	Fixed	25.25	25	50	17.5-22.125	25.6875-30.25	21	47-52	18	44	19	2.2
DEB1-HB	Fixed Upholstered	25.5	25	50	17.5-22.125	25.6875-30.25	20.5	47-52	18	44	19	2.5
	Adjustable	25.5	25	50	17.5-22.125	26-34	21	47-52	18	44	19	2.2
	Armless	20.5	25	50	17.5-22.125	N/A	N/A	47-52	18	40	19	2.2
DEC1-MB/DES1-MB	Fixed	25.25	25	43	17.5-22.125	25.6875-30.25	21	40-45	18	41	16	2
DEB1-MB	Fixed Upholstered	25.5	25	43	17.5-22.125	25.6875-30.25	20.5	40-45	18	41	16	2.3
	Adjustable	25.5	25	43	17.5-22.125	26-34	21	40-45	18	41	16	2
	Armless	20.5	25	43	17.5-22.125	N/A	N/A	40-45	18	37	16	2

## DORSO | E-LINE



Note: Some vinyls, leathers and upholsteries are not suitable for application on Dorso E seating. For vinyls, please submit a sample to Customer Service for pre-approval process at time of order.

The pre-approval process is as follows:

1. A sample of the COM must be provided to Krug Customer Service prior to or at time of order.
2. The sample will be reviewed and the customer advised if the fabric is unsuitable.
3. The COM fabric or leather itself will be inspected when received at the factory, to identify and further concerns with its suitability.

### ORDERING NOTES:

Height measurements of Dorso E are taken with the pneumatic lift in the lowest position. All dimensions are in inches and approximate and are subject to change without notice. Contact Customer Service if dimensions are critical.

# DORSO T-LINE | DIMENSIONS & COM REQUIREMENTS

Dorso T - a strikingly modern chair design, provides a level of long term sitting comfort and support.

Model Number		Overall Width	Overall Depth	Overall Height	Seat Height Min/Max	Height of Arms from Floor	Width between Arms	Height Range	Seat Depth	Shipping Weight	Cube	COM Yardage
DTC1-HB/DTS1-HB/	Fixed	25.25	24	49	16.75-21.375	27.5-30.25	20	46-51	18	44	19	2
	Adjustable	25.5	24	49	16.75-21.375	26-34	20	46-51	18	44	19	2
	Armless	20.5	24	49	16.75-21.375	N/A	N/A	46-51	18	40	19	2
DTB1-HB	Fixed	25.25	24	49	16.75-21.375	27.5-30.25	20	46-51	18	44	19	2
	Adjustable	25.5	24	49	16.75-21.375	26-34	20	46-51	18	44	19	2
	Armless	20.5	24	49	16.75-21.375	N/A	N/A	46-51	18	37	19	2
DTC1-MB/DTS1-MB	Fixed	25.25	24	42	16.75-21.375	27.5-30.25	20	39-44	18	41	16	1.8
DTB1-MB	Adjustable	25.5	24	42	16.75-21.375	26-34	20	39-44	18	41	16	1.8
	Armless	20.5	24	49	16.75-21.375	N/A	N/A	39-44	18	37	16	1.8

## DORSO | T-LINE



Note: Some vinyls, leathers and upholsteries are not suitable for application on Dorso T seating. For vinyls, please submit a sample to Customer Service for pre-approval process at time of order.

The pre-approval process is as follows:

1. A sample of the COM must be provided to Krug Customer Service prior to or at time of order.
2. The sample will be reviewed and the customer advised if the fabric is unsuitable.
3. The COM fabric or leather itself will be inspected when received at the factory, to identify and further concerns with its suitability.

### OPTIONS

Height measurements of Dorso T are taken with the pneumatic lift in the lowest position. All dimensions are in inches and approximate and are subject to change without notice. Contact Customer Service if dimensions are critical.

# DORSO E-LINE | MID BACK

DESCRIPTION/MODEL	COM		COL	FABRIC GRADES			LEATHER			
	1	2	3	4	5	6	7	8	9	
	Fixed Back; Fixed Arms - Synchro									
	DEC1-M111C	1439	1506	1569	1659	1758	1870	2010	2161	2327
	DES1-M111S	1376	1439	1504	1588	1691	1815	1944	2092	2257
	DEB1-M111B	1202	1266	1331	1415	1515	1640	1771	1920	2086
	Fixed Back; Fixed Arms - Synchro/Seat Slider									
	DEC1-M112C	1518	1585	1647	1736	1837	1949	2088	2239	2407
DES1-M112S	1455	1518	1584	1667	1771	1893	2023	2172	2340	
DEB1-M112B	1282	1345	1409	1493	1594	1717	1849	1999	2165	

	Fixed Back; Adjustable Arms - Synchro									
	DEC1-M121C	1644	1708	1774	1860	1962	2072	2212	2361	2531
	DES1-M121S	1534	1604	1667	1749	1854	1964	2105	2254	2421
	DEB1-M121B	1359	1422	1487	1570	1673	1798	1927	2079	2242
	Fixed Back; Adjustable Arms - Synchro/Seat Slider									
	DEC1-M122C	1724	1788	1854	1940	2040	2154	2293	2441	2610
DES1-M122S	1613	1683	1746	1832	1932	2042	2185	2333	2502	
DEB1-M122B	1439	1503	1567	1651	1753	1879	2006	2158	2323	

	Fixed Back; Fixed Arms (Leather/Fabric Pad) - Synchro									
	DEC1-M131C	1662	1734	1808	1902	2011	2132	2279	2451	2618
	DES1-M131S	1597	1668	1743	1834	1944	2073	2212	2385	2551
	Fixed Back; Fixed Arms (Leather/Fabric Pad) - Synchro/Seat Slider									
	DEC1-M132C	1741	1815	1885	1981	2090	2211	2357	2530	2697
	DES1-M132S	1676	1747	1819	1912	2023	2155	2370	2463	2630

	Fixed Back; Armless - Synchro									
	DEC1-M101C	1345	1411	1478	1559	1663	1786	1914	2064	2234
	DES1-M101S	1218	1283	1348	1431	1536	1657	1786	1938	2104
	DEB1-M101B	1146	1212	1279	1359	1464	1585	1714	1866	2032
	Fixed Back; Armless - Synchro/Seat Slider									
	DEC1-M102C	1422	1491	1556	1639	1743	1863	1993	2144	2312
DES1-M102S	1297	1360	1429	1510	1615	1734	1863	2017	2182	
DEB1-M102B	1226	1290	1357	1439	1543	1664	1792	1945	2110	

## Each chair features the Synchro Tilt mechanism





\*The finish applies to exposed metal elements specified for the chair: chair base, fixed and adjustable arm accents.

**ORDERING NOTES:** The upholstered cantilever arm is available for use with leather and upholstery in the Polished Chrome and Silver Metallic arm only. Optional soft wheel casters are available at an upcharge of **\$64 list**. CAL 133 and Moisture Barrier options are available for an upcharge of **\$64 list per yard**.

## PRODUCT CODE KEY

Line	Series	Back Style	Back Adjustment	Arm Style	Mechanism	Base
DEC	1	M	1	0	1	C
Dorso E-Line (Polished Chrome)	Management, Task & Conference Seating	Mid Back	Fixed	Armless	Synchro	Chrome Base
DES		H	2	1	2	S
Dorso E-Line (Silver Metallic)		High Back	Adjustable	Fixed Cantilever	Synchro/ Seat Slider	Silver Metallic Base
DEB				2		B
Dorso E-Line (Black)				Adjustable		Black Base
				3		
				Fixed Cantilever (Upholstered)		

# DORSO E-LINE | MID BACK

DESCRIPTION/MODEL	COM		COL	FABRIC GRADES			LEATHER			
	1	2	3	4	5	6	7	8	9	
	Adjustable Back; Fixed Arms - Synchro									
	DEC1-M211C	1468	1537	1603	1689	1790	1902	2040	2192	2359
	DES1-M211S	1408	1468	1536	1619	1723	1845	1976	2126	2293
	DEB1-M211B	1232	1297	1360	1446	1548	1670	1802	1951	2117
	Adjustable Back; Fixed Arms - Synchro/Seat Slider									
	DEC1-M212C	1551	1617	1680	1769	1869	1981	2119	2271	2437
DES1-M212S	1485	1551	1615	1698	1802	1924	2055	2205	2370	
DEB1-M212B	1312	1376	1440	1526	1626	1749	1881	2031	2195	
	Adjustable Back; Adjustable Arms - Synchro									
	DEC1-M221C	1676	1741	1806	1892	1993	2105	2242	2392	2563
	DES1-M221S	1565	1636	1698	1781	1884	1995	2135	2285	2453
	DEB1-M221B	1391	1455	1521	1604	1706	1832	1959	2109	2274
	Adjustable Back; Adjustable Arms - Synchro/Seat Slider									
	DEC1-M222C	1755	1818	1884	1970	2072	2185	2323	2472	2640
DES1-M222S	1644	1714	1777	1861	1964	2073	2215	2364	2532	
DEB1-M222B	1468	1534	1598	1683	1786	1909	2037	2190	2355	
	Adjustable Back; Fixed Arms (Leather/Fabric Pad) - Synchro									
	DEC1-M231C	1692	1767	1839	1934	2042	2164	2310	2483	2650
	DES1-M231S	1631	1699	1773	1863	1976	2107	2242	2417	2581
	Adjustable Back; Fixed Arms (Leather/Fabric Pad) - Synchro/Seat Slider									
	DEC1-M232C	1772	1845	1918	2012	2122	2241	2388	2562	2728
	DES1-M232S	1708	1778	1853	1944	2055	2186	2323	2495	2661
	Adjustable Back; Armless - Synchro									
	DEC1-M201C	1376	1441	1508	1590	1693	1817	1946	2096	2265
	DES1-M201S	1249	1314	1380	1463	1567	1688	1817	1968	2134
	DEB1-M201B	1178	1244	1310	1391	1495	1617	1746	1897	2063
	Adjustable Back; Armless - Synchro/Seat Slider									
	DEC1-M202C	1455	1522	1587	1669	1773	1896	2026	2174	2343
DES1-M202S	1330	1393	1460	1540	1645	1767	1896	2048	2214	
DEB1-M202B	1257	1320	1389	1468	1573	1695	1823	1977	2143	

**Each chair features the Synchro Tilt mechanism**

\*The finish applies to exposed metal elements specified for the chair: chair base, fixed and adjustable arm accents.

**ORDERING NOTES:** The upholstered cantilever arm is available for use with leather and upholstery in the Polished Chrome and Silver Metallic arm only. Optional soft wheel casters are available at an upcharge of **\$64 list**. CAL 133 and Moisture Barrier options are available for an upcharge of **\$64 list per yard**.

**PRODUCT CODE KEY**

Line	Series	Back Style	Back Adjustment	Arm Style	Mechanism	Base
DEC Dorso E-Line (Polished Chrome)	1 Management, Task & Conference Seating	M Mid Back	1 Fixed	0 Armless	1 Synchro	C Chrome Base
DES Dorso E-Line (Silver Metallic)		H High Back	2 Adjustable	1 Fixed Cantilever	2 Synchro/ Seat Slider	S Silver Metallic Base
DEB Dorso E-Line (Black)				2 Adjustable		B Black Base
				3 Fixed Cantilever (Upholstered)		

# DORSO E-LINE | HIGH BACK

DESCRIPTION/MODEL	COM		COL			FABRIC GRADES			LEATHER	
	1	2	3	4	5	6	7	8	9	
	Fixed Back; Fixed Arms - Synchro									
	DEC1-H111C	1485	1568	1657	1769	1898	2059	2244	2459	2691
	DES1-H111S	1422	1504	1590	1703	1834	1990	2180	2391	2628
	DEB1-H111B	1232	1314	1402	1513	1642	1802	1990	2202	2436
	Fixed Back; Fixed Arms - Synchro/Seat Slider									
	DEC1-H112C	1565	1646	1734	1846	1979	2138	2324	2538	2770
DES1-H112S	1503	1584	1669	1781	1912	2069	2257	2471	2705	
DEB1-H112B	1312	1393	1481	1592	1723	1881	2069	2281	2516	

	Fixed Back; Adjustable Arms - Synchro									
	DEC1-H121C	1692	1774	1860	1974	2104	2263	2448	2654	2896
	DES1-H121S	1631	1713	1798	1908	2039	2195	2383	2591	2833
	DEB1-H121B	1439	1524	1609	1716	1852	2006	2193	2403	2641
	Fixed Back; Adjustable Arms - Synchro/Seat Slider									
	DEC1-H122C	1772	1854	1940	2054	2182	2341	2527	2734	2973
DES1-H122S	1708	1791	1879	1987	2118	2274	2462	2670	2912	
DEB1-H122B	1518	1603	1688	1796	1928	2086	2272	2481	2721	

	Fixed Back; Fixed Arms (Leather/Fabric Pad) - Synchro									
	DEC1-H131C	1708	1796	1893	2012	2154	2319	2515	2747	2983
	DES1-H131S	1644	1732	1827	1947	2086	2252	2449	2683	2917
	Fixed Back; Fixed Arms (Leather/Fabric Pad) - Synchro/Seat Slider									
	DEC1-H132C	1788	1878	1971	2091	2232	2397	2593	2828	3059
	DES1-H132S	1724	1811	1908	2028	2165	2329	2529	2763	2995

## Each chair features the Synchro Tilt mechanism



\*The finish applies to exposed metal elements specified for the chair: chair base, fixed and adjustable arm accents.

**ORDERING NOTES:** The upholstered cantilever arm is available for use with leather and upholstery in the Polished Chrome and Silver Metallic arm only. Optional soft wheel casters are available at an upcharge of **\$64 list**. CAL 133 and Moisture Barrier options are available for an upcharge of **\$64 list per yard**.

## PRODUCT CODE KEY

Line	Series	Back Style	Back Adjustment	Arm Style	Mechanism	Base
DEC	1	M	1	0	1	C
Dorso E-Line (Polished Chrome)	Management, Task & Conference Seating	Mid Back	Fixed	Armless	Synchro	Chrome Base
DES		H	2	1	2	S
Dorso E-Line (Silver Metallic)		High Back	Adjustable	Fixed Cantilever	Synchro/ Seat Slider	Silver Metallic Base
DEB				2		B
Dorso E-Line (Black)				Adjustable		Black Base
				3		
				Fixed Cantilever (Upholstered)		

# DORSO E-LINE | HIGH BACK

DESCRIPTION/MODEL	COM		COL	FABRIC GRADES			LEATHER			
	1	2	3	4	5	6	7	8	9	
	Adjustable Back; Fixed Arms - Synchro									
	DEC1-H211C	1518	1601	1688	1801	1929	2090	2278	2489	2721
	DES1-H211S	1455	1536	1622	1734	1863	2023	2212	2422	2658
	DEB1-H211B	1266	1346	1433	1545	1673	1834	2023	2236	2466
	Adjustable Back; Fixed Arms - Synchro/Seat Slider									
	DEC1-H212C	1597	1678	1767	1880	2010	2169	2356	2569	2803
DES1-H212S	1534	1615	1702	1815	1944	2103	2293	2503	2738	
DEB1-H212B	1345	1423	1512	1623	1753	1912	2103	2313	2548	
	Adjustable Back; Adjustable Arms - Synchro									
	DEC1-H221C	1724	1806	1892	2004	2134	2294	2480	2684	2928
	DES1-H221S	1662	1745	1832	1940	2070	2228	2415	2623	2864
	DEB1-H221B	1468	1556	1640	1748	1882	2037	2223	2433	2673
	Adjustable Back; Adjustable Arms - Synchro/Seat Slider									
	DEC1-H222C	1803	1884	1970	2085	2214	2373	2559	2764	3008
DES1-H222S	1741	1822	1909	2018	2148	2307	2493	2701	2944	
DEB1-H222B	1551	1634	1717	1827	1960	2117	2303	2513	2754	
	Adjustable Back; Fixed Arms (Leather/Fabric Pad) - Synchro									
	DEC1-H231C	1741	1832	1924	2045	2185	2352	2545	2780	3013
	DES1-H231S	1676	1765	1860	1980	2117	2282	2481	2715	2948
	Adjustable Back; Fixed Arms (Leather/Fabric Pad) - Synchro/Seat Slider									
	DEC1-H232C	1818	1909	2003	2124	2264	2431	2625	2859	3092
	DES1-H232S	1755	1844	1940	2059	2195	2361	2560	2793	3028

## Each chair features the Synchro Tilt mechanism

\*The finish applies to exposed metal elements specified for the chair: chair base, fixed and adjustable arm accents.

**ORDERING NOTES:** The upholstered cantilever arm is available for use with leather and upholstery in the Polished Chrome and Silver Metallic arm only. Optional soft wheel casters are available at an upcharge of **\$64 list**. CAL 133 and Moisture Barrier options are available for an upcharge of **\$64 list per yard**. Please see page 333 for more information.

## PRODUCT CODE KEY

Line	Series	Back Style	Back Adjustment	Arm Style	Mechanism	Base
DEC Dorso E-Line (Polished Chrome)	1 Management, Task & Conference Seating	M Mid Back	1 Fixed	0 Armless	1 Synchro	C Chrome Base
DES Dorso E-Line (Silver Metallic)		H High Back	2 Adjustable	1 Fixed Cantilever	2 Synchro/ Seat Slider	S Silver Metallic Base
DEB Dorso E-Line (Black)				2 Adjustable		B Black Base
				3 Fixed Cantilever (Upholstered)		

# DORSO T-LINE | ENVIRONMENTAL SUMMARY

## LEED CI CREDITS



MATERIAL CONTENT:

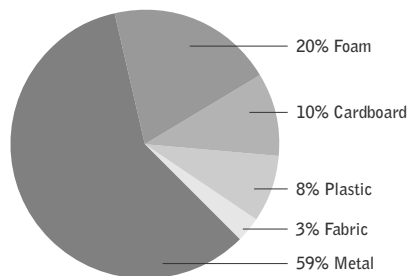

PRE-CONSUMER RECYCLED CONTENT = 7.91%

POST-CONSUMER RECYCLED CONTENT = 18.91%

Up to 63.75% of this Dorso T product is recyclable at the end of its useful life.

### CONTRIBUTES TO

CREDIT 2.1 - 2.2	Construction Waste Management	1-2 point(s)
CREDIT 3.3	Resource Reuse	1 point
CREDIT 4.1	Recycled Content	1 point
CREDIT 4.2	Recycled Content	1 point
CREDIT 4.5	Low Emitting Materials, Systems & Seating	1 point
CREDIT 5.1	Regional Materials*	1 point

\*This credit is only applicable if in total 20% of the combined value of the procurement of construction materials and in the furniture are manufactured within a radius of 500 miles. This credit will apply if the installation of the finished product occurs within 500 miles of Kitchener, Ontario.

## level® CERTIFICATION & AIR EMISSIONS CERTIFICATION



### level® CERTIFICATION



BIFMA's e3 Furniture Sustainability Standard is a voluntary, multi-attribute standard that measures the degree of sustainability of furniture. This standard evaluates product and company environmental attributes and compliance systems in a wide range of elements which include Materials, Energy & Atmosphere, Human & Ecosystem Health and Social Responsibility. Dorso products have earned level®, BIFMA's sustainability certification program for furniture, certification through third-party verification against the e3 standard.



### AIR EMISSIONS

All Dorso products are supplied air-emissions certified. Contact customer service for information.

# DORSO T-LINE | MID BACK

DESCRIPTION/MODEL	COM		COL	FABRIC GRADES			LEATHER			
	1	2	3	4	5	6	7	8	9	
	Fixed Back; Fixed Arms - Synchro									
	DTC1-M111C	1323	1386	1446	1526	1618	1720	1849	1988	2140
	DTS1-M111S	1266	1323	1384	1461	1556	1668	1789	1926	2080
	DTB1-M111B	1107	1164	1224	1302	1394	1509	1626	1767	1918
	Fixed Back; Fixed Arms - Synchro/Seat Slider									
	DTC1-M112C	1403	1464	1526	1604	1697	1801	1927	2065	2219
DTS1-M112S	1345	1403	1463	1539	1634	1747	1867	2004	2160	
DTB1-M112B	1185	1244	1304	1378	1477	1588	1706	1845	1997	
	Fixed Back; Adjustable Arms - Synchro									
	DTC1-M121C	1513	1570	1633	1712	1806	1908	2034	2172	2328
	DTS1-M121S	1411	1478	1534	1610	1704	1808	1938	2073	2228
	DTB1-M121B	1251	1310	1371	1446	1539	1654	1773	1912	2063
	Fixed Back; Adjustable Arms - Synchro/Seat Slider									
	DTC1-M122C	1592	1651	1712	1790	1884	1987	2113	2252	2408
DTS1-M122S	1491	1556	1613	1689	1782	1885	2017	2155	2307	
DTB1-M122B	1331	1389	1449	1526	1619	1732	1853	1990	2143	
	Fixed Back; Armless - Synchro									
	DTC1-M101C	1237	1298	1357	1434	1529	1642	1761	1899	2055
	DTS1-M101S	1120	1179	1241	1316	1414	1524	1642	1781	1935
	DTB1-M101B	1056	1116	1173	1251	1347	1459	1578	1716	1869
	Fixed Back; Armless - Synchro/Seat Slider									
	DTC1-M102C	1315	1377	1437	1513	1609	1723	1840	1980	2118
DTS1-M102S	1199	1260	1319	1396	1492	1603	1723	1861	2016	
DTB1-M102B	1135	1194	1253	1331	1425	1537	1657	1796	1947	

**Each chair features the Synchro Tilt mechanism**

\*The finish applies to exposed metal elements specified for the chair: chair base, fixed and adjustable arm accents.

**ORDERING NOTES**

Dorso T-Line versions are available without back metal accent detail. Please contact Customer Service for ordering information. Optional soft wheel casters are available at an upcharge of **\$64 list**. CAL 133 and Moisture Barrier options are available for an upcharge of **\$64 list per yard**. Please see page 333 for more information.

The upholstered cantilever arm is available for use with leather and upholstery in the polished chrome and silver metal arm only.



Upcharge for Fixed Cantilever Upholstered cap:

GR1/COM	GR2	GR3	GR4	GR5	GR6	GR7	GR8	GR9
223	231	239	245	255	261	270	291	301

**PRODUCT CODE KEY**

Line	Series	Back Style	Back Adjustment	Arm Style	Mechanism	Base
<b>DTC</b> Dorso T-Line (Polished Chrome)	<b>1</b> Management, Task & Conference Seating	<b>M</b> Mid Back	<b>1</b> Fixed	<b>0</b> Armless	<b>1</b> Synchro	<b>C</b> Chrome Base
<b>DTS</b> Dorso T-Line (Silver Metallic)		<b>H</b> High Back	<b>2</b> Adjustable	<b>1</b> Fixed Cantilever	<b>2</b> Synchro/ Seat Slider	<b>S</b> Silver Metallic Base
<b>DTB</b> Dorso T-Line (Black)				<b>2</b> Adjustable		<b>B</b> Black Base
				<b>3</b> Fixed Cantilever Upholstered		

# DORSO T-LINE | MID BACK

DESCRIPTION/MODEL	COM		COL	FABRIC GRADES			LEATHER			
	1	2	3	4	5	6	7	8	9	
	Adjustable Back; Fixed Arms - Synchro									
	DTC1-M211C	1355	1415	1477	1556	1645	1749	1880	2017	2170
	DTS1-M211S	1295	1355	1414	1491	1585	1698	1817	1955	2108
	DTB1-M211B	1137	1193	1252	1331	1423	1537	1659	1795	1947
	Adjustable Back; Fixed Arms - Synchro/Seat Slider									
	DTC1-M212C	1433	1493	1555	1634	1727	1832	1957	2094	2250
DTS1-M212S	1374	1433	1492	1568	1664	1777	1896	2033	2188	
DTB1-M212B	1215	1271	1332	1409	1504	1617	1736	1872	2028	
	Adjustable Back; Adjustable Arms - Synchro									
	DTC1-M221C	1540	1601	1663	1741	1835	1938	2063	2202	2357
	DTS1-M221S	1440	1504	1562	1640	1734	1836	1965	2104	2256
	DTB1-M221B	1282	1338	1398	1478	1569	1683	1803	1941	2092
	Adjustable Back; Adjustable Arms - Synchro/Seat Slider									
	DTC1-M222C	1620	1678	1743	1818	1913	2017	2143	2281	2436
DTS1-M222S	1521	1584	1641	1717	1815	1914	2045	2182	2337	
DTB1-M222B	1359	1417	1479	1556	1647	1761	1882	2019	2172	
	Adjustable Back; Armless - Synchro									
	DTC1-M201C	1268	1331	1389	1465	1560	1673	1792	1932	2086
	DTS1-M201S	1152	1212	1273	1348	1445	1556	1673	1815	1967
	DTB1-M201B	1087	1146	1206	1283	1378	1491	1609	1748	1899
	Adjustable Back; Armless - Synchro/Seat Slider									
	DTC1-M202C	1347	1409	1466	1545	1640	1753	1871	2011	2177
DTS1-M202S	1230	1290	1354	1429	1524	1634	1753	1893	2046	
DTB1-M202B	1166	1226	1285	1360	1459	1568	1688	1827	1980	

## Each chair features the Synchro Tilt mechanism

\*The finish applies to exposed metal elements specified for the chair: chair base, fixed and adjustable arm accents.

## ORDERING NOTES

Dorso T-Line versions are available without back metal accent detail. Please contact Customer Service for ordering information. Optional soft wheel casters are available at an upcharge of **\$64 list**. CAL 133 and Moisture Barrier options are available for an upcharge of **\$64 list per yard**. Please see page 333 for more information.

The upholstered cantilever arm is available for use with leather and upholstery in the polished chrome and silver metal arm only.

Upcharge for Fixed Cantilever Upholstered cap:



GR1/COM	GR2	GR3	GR4	GR5	GR6	GR7	GR8	GR9
223	231	239	245	255	261	270	291	301

## PRODUCT CODE KEY

Line	Series	Back Style	Back Adjustment	Arm Style	Mechanism	Base
<b>DTC</b> Dorso T-Line (Polished Chrome)	<b>1</b> Management, Task & Conference Seating	<b>M</b> Mid Back	<b>1</b> Fixed	<b>0</b> Armless	<b>1</b> Synchro	<b>C</b> Chrome Base
<b>DTS</b> Dorso T-Line (Silver Metallic)		<b>H</b> High Back	<b>2</b> Adjustable	<b>1</b> Fixed Cantilever	<b>2</b> Synchro/ Seat Slider	<b>S</b> Silver Metallic Base
<b>DTB</b> Dorso T-Line (Black)				<b>2</b> Adjustable		<b>B</b> Black Base
				<b>3</b> Fixed Cantilever Upholstered		



# DORSO T-LINE | HIGH BACK

DESCRIPTION/MODEL	COM		COL	FABRIC GRADES			LEATHER			
	1	2	3	4	5	6	7	8	9	
	Fixed Back; Fixed Arms - Synchro									
	DTC1-H111C	1370	1445	1524	1626	1747	1894	2064	2264	2478
	DTS1-H111S	1310	1384	1464	1567	1686	1833	2006	2201	2417
	DTB1-H111B	1137	1209	1289	1391	1512	1659	1833	2028	2241
	Fixed Back; Fixed Arms - Synchro/Seat Slider									
	DTC1-H112C	1447	1524	1603	1706	1825	1974	2144	2342	2555
DTS1-H112S	1389	1463	1543	1645	1765	1911	2086	2280	2495	
DTB1-H112B	1215	1289	1370	1468	1590	1736	1911	2107	2321	
	Fixed Back; Adjustable Arms - Synchro									
	DTC1-H121C	1557	1633	1712	1816	1935	2083	2252	2441	2664
	DTS1-H121S	1499	1573	1654	1755	1879	2020	2192	2385	2608
	DTB1-H121B	1323	1402	1481	1581	1702	1845	2018	2210	2432
	Fixed Back; Adjustable Arms - Synchro/Seat Slider									
	DTC1-H122C	1636	1712	1790	1894	2016	2161	2329	2520	2743
DTS1-H122S	1579	1654	1732	1835	1956	2100	2271	2463	2685	
DTB1-H122B	1403	1481	1559	1661	1779	1924	2112	2286	2511	
	Fixed Back; Armless - Synchro									
	DTC1-H101C	1273	1348	1429	1533	1653	1801	1970	2168	2382
	DTS1-H101S	1152	1226	1307	1409	1528	1671	1849	2042	2256
	DTB1-H101B	1082	1155	1232	1336	1456	1603	1776	1971	2188
	Fixed Back; Armless - Synchro/Seat Slider									
	DTC1-H102C	1354	1429	1508	1611	1731	1880	2051	2247	2460
DTS1-H102S	1230	1306	1386	1487	1607	1752	1927	2122	2337	
DTB1-H102B	1161	1232	1312	1416	1536	1680	1855	2053	2266	

**Each chair features the Synchro Tilt mechanism**

\*The finish applies to exposed metal elements specified for the chair: chair base, fixed and adjustable arm accents.

**ORDERING NOTES**

Dorso T-Line versions are available without back metal accent detail. Please contact Customer Service for ordering information.

Optional soft wheel casters are available at an upcharge of **\$64 list**. CAL 133 and Moisture Barrier options are available for an upcharge of **\$64 list per yard**. Please see page 333 for more information.

The upholstered cantilever arm is available for use with leather and upholstery in the polished chrome and silver metal arm only.



Upcharge for Fixed Cantilever Upholstered cap:

GR1/COM	GR2	GR3	GR4	GR5	GR6	GR7	GR8	GR9
223	231	239	245	255	261	270	291	301

**PRODUCT CODE KEY**

Line	Series	Back Style	Back Adjustment	Arm Style	Mechanism	Base
<b>DTC</b> Dorso T-Line (Polished Chrome)	<b>1</b> Management, Task & Conference Seating	<b>M</b> Mid Back	<b>1</b> Fixed	<b>0</b> Armless	<b>1</b> Synchro	<b>C</b> Chrome Base
<b>DTS</b> Dorso T-Line (Silver Metallic)		<b>H</b> High Back	<b>2</b> Adjustable	<b>1</b> Fixed Cantilever	<b>2</b> Synchro/ Seat Slider	<b>S</b> Silver Metallic Base
<b>DTB</b> Dorso T-Line (Black)				<b>2</b> Adjustable		<b>B</b> Black Base
				<b>3</b> Fixed Cantilever Upholstered		

# DORSO T-LINE | HIGH BACK

DESCRIPTION/MODEL	COM		COL	FABRIC GRADES			LEATHER			
	1	2	3	4	5	6	7	8	9	
	Adjustable Back; Fixed Arms - Synchro									
	DTC1-H211C	1396	1473	1555	1657	1776	1923	2094	2293	2504
	DTS1-H211S	1338	1414	1493	1594	1715	1861	2034	2230	2447
	DTB1-H211B	1246	1319	1401	1503	1622	1769	1942	2138	2354
	Adjustable Back; Fixed Arms - Synchro/Seat Slider									
	DTC1-H212C	1478	1554	1633	1734	1855	2002	2173	2370	2584
DTS1-H212S	1417	1492	1570	1673	1795	1941	2113	2308	2526	
DTB1-H212B	1327	1401	1480	1583	1702	1846	2020	2217	2432	
	Adjustable Back; Adjustable Arms - Synchro									
	DTC1-H221C	1587	1663	1741	1845	1964	2109	2281	2470	2695
	DTS1-H221S	1528	1606	1683	1782	1907	2051	2220	2412	2636
	DTB1-H221B	1356	1433	1512	1611	1732	1879	2051	2240	2463
	Adjustable Back; Adjustable Arms - Synchro/Seat Slider									
	DTC1-H222C	1666	1743	1818	1924	2042	2190	2360	2549	2773
DTS1-H222S	1607	1685	1761	1862	1985	2130	2301	2492	2715	
DTB1-H222B	1434	1512	1590	1691	1811	1956	2130	2319	2542	
	Adjustable Back; Armless - Synchro									
	DTC1-H201C	1306	1380	1460	1563	1685	1833	2002	2198	2412
	DTS1-H201S	1183	1257	1338	1440	1559	1704	1881	2073	2287
	DTB1-H201B	1111	1187	1266	1370	1487	1634	1808	2003	2218
	Adjustable Back; Armless - Synchro/Seat Slider									
	DTC1-H202C	1384	1460	1538	1642	1764	1911	2083	2279	2492
DTS1-H202S	1263	1336	1417	1521	1639	1782	1959	2155	2369	
DTB1-H202B	1192	1266	1345	1447	1567	1713	1885	2084	2298	

## Each chair features the Synchro Tilt mechanism

\*The finish applies to exposed metal elements specified for the chair: chair base, fixed and adjustable arm accents.

## ORDERING NOTES

Dorso T-Line versions are available without back metal accent detail. Please contact Customer Service for ordering information. Optional soft wheel casters are available at an upcharge of **\$64 list**. CAL 133 and Moisture Barrier options are available for an upcharge of **\$9 list per yard**. Please see page 333 for more information.

The upholstered cantilever arm is available for use with leather and upholstery in the polished chrome and silver metal arm only.

Upcharge for Fixed Cantilever Upholstered cap:

GR1/COM	GR2	GR3	GR4	GR5	GR6	GR7	GR8	GR9
223	231	239	245	255	261	270	291	301

## PRODUCT CODE KEY

Line	Series	Back Style	Back Adjustment	Arm Style	Mechanism	Base
<b>DTC</b> Dorso T-Line (Polished Chrome)	<b>1</b> Management, Task & Conference Seating	<b>M</b> Mid Back	<b>1</b> Fixed	<b>0</b> Armless	<b>1</b> Synchro	<b>C</b> Chrome Base
<b>DTS</b> Dorso T-Line (Silver Metallic)		<b>H</b> High Back	<b>2</b> Adjustable	<b>1</b> Fixed Cantilever	<b>2</b> Synchro/ Seat Slider	<b>S</b> Silver Metallic Base
<b>DTB</b> Dorso T-Line (Black)				<b>2</b> Adjustable		<b>B</b> Black Base
				<b>3</b> Fixed Cantilever Upholstered		

# DORSO WEAVE | ENVIRONMENTAL SUMMARY

## LEED CI CREDITS



### MATERIAL CONTENT:

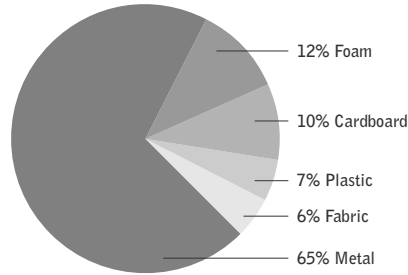

PRE-CONSUMER  
RECYCLED CONTENT = 11.32%

POST-CONSUMER  
RECYCLED CONTENT = 21.48%

Up to 74.04% of this Dorso Weave product is recyclable at the end of its useful life.

### CONTRIBUTES TO

CREDIT 2.1 - 2.2	Construction Waste Management	1-2 point(s)
CREDIT 3.3	Resource Reuse	1 point
CREDIT 4.1	Recycled Content	1 point
CREDIT 4.2	Recycled Content	1 point
CREDIT 4.5	Low Emitting Materials, Systems & Seating	1 point
CREDIT 5.1	Regional Materials*	1 point

\*This credit is only applicable if in total 20% of the combined value of the procurement of construction materials and in the furniture are manufactured within a radius of 500 miles. This credit will apply if the installation of the finished product occurs within 500 miles of Kitchener, Ontario.

## level® CERTIFICATION & AIR EMISSIONS CERTIFICATION



### level® CERTIFICATION

BIFMA's e3 Furniture Sustainability Standard is a voluntary, multi-attribute standard that measures the degree of sustainability of furniture. This standard evaluates product and company environmental attributes and compliance systems in a wide range of elements which include Materials, Energy & Atmosphere, Human & Ecosystem Health and Social Responsibility. Dorso products have earned level®, BIFMA's sustainability certification program for furniture, certification through third-party verification against the e3 standard.



### AIR EMISSIONS

All Dorso products are supplied air-emissions certified. Contact customer service for information.

# DORSO WEAVE | FEATURES



## ARM STYLES

Optional fixed cantilever or an adjustable black arm constructed of die cast metal with textured plastic arm pads. The adjustable arms feature seven height adjustment positions, with a total adjustment range of 2.75". All Dorso models are also available in armless versions.

## S-LINE

Fixed cantilever and adjustable arms are available in Black, Silver Metallic or Polished Chrome accent finishes to match metal base. The fixed arm is also available in black textured plastic and upholstered fabric/leather version.

## N-LINE

Fixed cantilever and adjustable arms are available in black textured plastic only.



## BASE STYLES

Dorso seating features injection molded, glass reinforced black nylon bases with dual wheel casters. Dorso seating features optional Silver Metallic or Polished Chrome finish. S-Line models feature steel upper and lower seat back exposed frame rail available in Silver Metallic or Polished Chrome finish.



## SEAT HEIGHT

In the seated position, a pull upwards on the height adjustment lever located under the seat of the user's right side adjusts the height up or down with a total height range of 4.5".

## BACK TENSION

Back tension on the mechanism is controlled with an adjustment knob under the seat. It has been designed to provide a range of back tension adjustment suitable for users of varying sizes and preferences.

## SEAT SLIDER

All Dorso tilters are available with an optional seat slider mechanism featuring a 2" range of adjustment front to back when seated. The lever to activate this feature is located under the seat of the user's right side and is activated by an upward pull of the lever.

## BACK HEIGHT

Back height adjustment is a standard feature on S-Line chairs, and an option on N-Line chairs. It offers an adjustment range of 11 positions, over a 2" range of movement. Back height adjustment is operated while in the seated position, by placing the right hand on the right bottom of the chair back, and the left hand on the left bottom of the chair back. The back is lifted and clicked into the desired height. Raising the back to the highest position releases the back height lock so it can be lowered.

## BACK COLOR OPTIONS

Black • Warm Grey • Tan • Soft Beige • Winter White



## DORSO CONTROLS

All Dorso S-Line and N-Line tilters come with a synchro tilt mechanism. The tilt adjustment range offers five recline-lock positions, as well as free flowing movement. The forward pivot of the mechanism allows the back and the seat to articulate synchronously in a 2:1 ratio, so that upward tilt of the seat is minimized as the back reclines.



## DIMENSIONS & COM REQUIREMENTS

		Overall Width	Overall Depth	Overall Height	Seat Height	Height of Arms from Floor	Width between Arms	Seat Depth	Shipping Weight	Cube	COM Yardage
S-LINE MID BACK	Fixed	24.5	22.5	42.5	18-22	27-30.5	20	18	51	15	0.75
	Adjustable	25	22.5	42.5	18-22	25.5-32	19.5	18	51	15	0.75
	Armless	19.5	22.5	42.5	18-22	N/A	N/A	18	46	15	0.75
S-LINE HIGH BACK	Fixed	24.5	22.5	47	18-22	27-30.5	20	18	52	18	0.75
	Adjustable	25	22.5	47	18-22	25.5-32	19.5	18	52	18	0.75
	Armless	19.5	22.5	47	18-22	N/A	N/A	18	47	18	0.75
S-LINE HIGH BACK with Headrest	Fixed	24.5	22.5	50.5	18-22	27-30.5	20	18	54	18	0.75
	Adjustable	25	22.5	50.5	18-22	25.5-32	19.5	18	54	18	0.75
N-LINE MID BACK	Fixed	24.5	21.5	41	18-22	27-30.5	20	18	50	15	0.75
	Adjustable	25	21.5	41	18-22	25.5-32	19.5	18	50	15	0.75
	Armless	19.5	21.5	41	18-22	N/A	N/A	18	45	15	0.75
N-LINE HIGH BACK	Fixed	24.5	21.5	45.5	18-22	27-30.5	20	18	51	18	0.75
	Adjustable	25	21.5	45.5	18-22	25.5-32	19.5	18	51	18	0.75
N-LINE HIGH BACK with Headrest	Fixed	24.5	21.5	50.5	18-22	27-30.5	20	18	53	19.5	0.75
	Adjustable	25	21.5	50.5	18-22	25.5-32	19.5	18	53	19.5	0.75

Note: Some vinyls, leathers and upholsteries are not suitable for application on Dorso seating. For information on COM approval process see page 333.

Height measurements of Dorso are taken with the pneumatic lift in the lowest position. All dimensions are in inches and approximate and are subject to change without notice. Contact Customer Service if dimensions are critical.

# DORSO WEAVE S-LINE | MID BACK

DESCRIPTION/MODEL	COM		COL	FABRIC GRADES			LEATHER			
	1	2	3	4	5	6	7	8	9	
	FIXED ARMS (Black with metal accent)									
	DOS1-M2211M	1673	1691	1706	1731	1755	1779	1811	1845	1880
	Silver Metallic									
	DOS1-M2231M	1897	1922	1945	1977	2009	2042	2083	2136	2180
	Silver Metallic									
	DOC1-M2211M	1752	1771	1786	1809	1835	1857	1892	1923	1956
Polished Chrome										
DOC1-M2231M	1974	2001	2024	2055	2088	2118	2163	2214	2256	
Polished Chrome										
	ADJUSTABLE ARMS (Black with metal accent)									
	DOS1-M2221M	1609	1623	1640	1666	1689	1714	1746	1778	1810
	Silver Metallic									
	DOC1-M2221M	1691	1706	1724	1747	1773	1796	1832	1861	1894
	Polished Chrome									
	ARMLESS									
	DOS1-M2201M	1501	1515	1533	1558	1583	1607	1639	1670	1703
	Silver Metallic									
	DOC1-M2201M	1570	1588	1606	1631	1653	1677	1712	1744	1776
Polished Chrome										

## ORDERING NOTES

Dorso S-Line versions are available without the back metal accent detail. Please contact Customer Service for ordering information.

Seat slider option is available on all tilter chair models at an upcharge of **\$80 list**.

Clearly indicate on order fabric selection for seat and weave selection for back.

For jury base version of this chair, please add a 'J' for the base style at the end of the model number and add **\$80 list**.



CAL 133 and Moisture Barrier options are available for an upcharge of **\$64 list per yard**. Please see page 333 for more information.





## PRODUCT CODE KEY

Line	Series	Back Style	Back Adjustment	Back Details	Arm Style	Mechanism	Base
DOS	1	M	2	2	0	1	M
Dorso S-Line (Silver Metallic)	Management, Task & Conference Seating	Mid Back	Adjustment	No Headrest Weave	Armless	Synchro	Metal Base
DOC		H		3	1	2	J
Dorso S-Line (Polished Chrome)		High Back		Headrest (No trim) (High back only) Weave	Fixed Cantilever	Synchro/Seat Slider	Jury Base
					2		
					Adjustable (Black)		
					3		
					Fixed Cantilever Upholstered		

# DORSO WEAVE S-LINE | HIGH BACK

DESCRIPTION/MODEL	COM		COL	FABRIC GRADES			LEATHER			
	1	2	3	4	5	6	7	8	9	
	FIXED ARMS (Black with metal accent)									
	DOS1-H2211M	1809	1825	1841	1866	1892	1914	1947	1980	2012
	Silver Metallic									
	DOS1-H2231M	2031	2056	2081	2112	2145	2176	2218	2271	2313
	Polished Chrome									
	DOC1-H2211M	1887	1907	1922	1946	1970	1995	2028	2061	2092
Polished Chrome										
DOC1-H2231M	2110	2136	2161	2192	2222	2256	2297	2353	2394	
	ADJUSTABLE ARMS (Black with metal accent)									
	DOS1-H2221M	1746	1761	1778	1803	1827	1853	1884	1915	1949
	Silver Metallic									
	DOC1-H2221M	1827	1844	1860	1884	1909	1934	1965	1999	2031
	Polished Chrome									

# DORSO WEAVE S-LINE | HIGH BACK WITH HEADREST

	FIXED ARMS (Black with metal accent)									
	DOS1-H2311M	1991	2007	2024	2051	2072	2098	2131	2164	2194
	Silver Metallic									
	DOS1-H2331M	2214	2238	2263	2296	2326	2360	2401	2453	2495
	Silver Metallic									
	DOC1-H2311M	2072	2088	2107	2131	2157	2177	2212	2242	2278
Polished Chrome										
DOC1-H2331M	2295	2319	2345	2376	2410	2440	2481	2533	2579	
Polished Chrome										
	ADJUSTABLE ARMS (Black with metal accent)									
	DOS1-H2321M	1928	1945	1960	1987	2010	2033	2065	2100	2132
	Silver Metallic									
	DOC1-H2321M	2010	2026	2042	2065	2091	2114	2147	2180	2214
	Polished Chrome									

## ORDERING NOTES

Dorso S-Line versions are available without the back metal accent detail. Please contact Customer Service for ordering information.

Seat slider option is available on all tilter chair models at an upcharge of **\$80 list**.

Clearly indicate on order fabric selection for seat and weave selection for back.

For jury base version of this chair, please add a 'J' for the base style at the end of the model number and add **\$80 list**.



CAL 133 and Moisture Barrier options are available for an upcharge of **\$64 list per yard**. Please see page 333 for more information.



## PRODUCT CODE KEY

Line	Series	Back Style	Back Adjustment	Back Details	Arm Style	Mechanism	Base
DOS	1	M	2	2	0	1	M
Dorso S-Line (Silver Metallic)	Management, Task & Conference Seating	Mid Back	Adjustment	No Headrest Weave	Armless	Synchro	Metal Base
DOC		H		3	1	2	J
Dorso S-Line (Polished Chrome)		High Back		Headrest (No trim) (High back only) Weave	Fixed Cantilever	Synchro/Seat Slider	Jury Base
					2		
					Adjustable (Black)		
					3		
					Fixed Cantilever Upholstered		

# DORSO WEAVE N-LINE | MID BACK

DESCRIPTION/MODEL	COM		COL		FABRIC GRADES			LEATHER		
	1	2	3	4	5	6	7	8	9	
 FIXED ARMS (Black) DON1-M1211B No back adjustment DON1-M2211B With back adjustment	1468	1485	1504	1528	1555	1578	1610	1641	1673	
	1557	1570	1588	1613	1638	1663	1693	1728	1758	
 ADJUSTABLE ARMS (Black) DON1-M1221B No back adjustment DON1-M2221B With back adjustment	1408	1422	1440	1464	1487	1513	1545	1579	1611	
	1491	1508	1524	1548	1570	1594	1631	1663	1693	
 ARMLESS DON1-M1201B No back adjustment DON1-M2201B With back adjustment	1297	1312	1330	1355	1377	1403	1434	1466	1501	
	1371	1387	1403	1425	1452	1478	1509	1539	1572	

## ORDERING NOTES

Dorso N-Line tilter models feature black bases and are available with an optional chrome base at an upcharge of **\$199**.

Seat slider option is available on all tilter chair models at an upcharge of **\$80 list**.

Clearly indicate on order fabric selection for seat. Only black weave is offered on Dorso N.

For jury base version of this chair, please add a 'J' for the base style at the end of the model number and **add \$77** to the list price.



CAL 133 and Moisture Barrier options are available for an upcharge of **\$64 list per yard**. See page 333 for more information.





## PRODUCT CODE KEY

Line	Series	Back Style	Back Adjustment	Back Details	Arm Style	Mechanism	Base
DON	1	M	1	2	0	1	B
Dorso N-Line	Management, Task & Conference Seating	Mid Back	No Adjustment	No Headrest Weave	Armless	Synchro	Black Base
		H	2	3	1	2	J
		High Back	Adjustment	Headrest (No trim) (High back only) Weave	Fixed (Black) Cantilever	Synchro/Seat Slider	Jury Base
					2		
					Adjustable (Black)		

# DORSO WEAVE N-LINE | HIGH BACK

DESCRIPTION/MODEL	COM		COL			FABRIC GRADES			LEATHER	
	1	2	3	4	5	6	7	8	9	
 FIXED ARMS (Black) DON1-H1211B No back adjustment DON1-H211B With back adjustment	1644	1663	1677	1702	1728	1749	1782	1816	1849	
	1728	1744	1758	1782	1808	1834	1863	1897	1929	
 ADJUSTABLE ARMS (Black) DON1-H1221B No back adjustment DON1-H221B With back adjustment	1583	1597	1615	1639	1664	1688	1720	1752	1786	
	1663	1677	1693	1717	1744	1769	1801	1834	1863	

# DORSO WEAVE N-LINE | HIGH BACK with Headrest

 FIXED ARMS (Black) DON1-H1311B No back adjustment DON1-H2311B With back adjustment	1827	1844	1860	1884	1909	1934	1965	1999	2031
	1911	1926	1944	1967	1991	2017	2051	2083	2113
 ADJUSTABLE ARMS (Black) DON1-H1321B No back adjustment DON1-H2321B With back adjustment	1764	1779	1796	1821	1845	1869	1902	1935	1967
	1845	1861	1880	1902	1926	1951	1985	2017	2051

Each chair features the Synchro Tilt mechanism

## ORDERING NOTES

Dorso N-Line tilter models feature black bases and are available with an optional chrome base at an upcharge of **\$199**.

Seat slider option is available on all tilter chair models at an upcharge of **\$80 list**.

Clearly indicate on order fabric selection for seat. Only black weave is offered on Dorso N.

For jury base version of this chair, please add a 'J' for the base style at the end of the model number and **add \$77** to the list price.

CAL 133 and Moisture Barrier options are available for an upcharge of **\$64 list per yard**. See page 333 for more information.



## PRODUCT CODE KEY

Line	Series	Back Style	Back Adjustment	Back Details	Arm Style	Mechanism	Base
DON	1	M	1	2	0	1	B
Dorso N-Line	Management, Task & Conference Seating	Mid Back	No Adjustment	No Headrest Weave	Armless	Synchro	Black Base
		H	2	3	1	2	J
		High Back	Adjustment	Headrest (No trim) (High back only) Weave	Fixed (Black) Cantilever	Synchro/Seat Slider	Jury Base
					2		
					Adjustable (Black)		
					3		
					Fixed Cantilever Upholstered		



# DORSO S-LINE & N-LINE | ENVIRONMENTAL SUMMARY

## LEED CI CREDITS



### MATERIAL CONTENT:

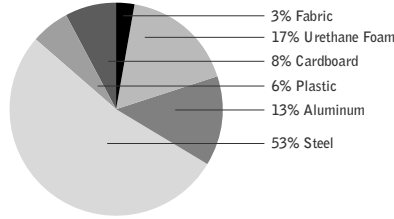

### PRE-CONSUMER

RECYCLED CONTENT = 21.68%

### POST-CONSUMER

RECYCLED CONTENT = 20.03%

Up to 77.88% of Dorso S product is recyclable at the end of its useful life.

### CONTRIBUTES TO

CREDIT 2.1 - 2.2	Construction Waste Management	1-2 point(s)
CREDIT 3.3	Resource Reuse	1 point
CREDIT 4.1	Recycled Content	1 point
CREDIT 4.2	Recycled Content	1 point
CREDIT 4.5	Low Emitting Materials, Systems & Seating	1 point
CREDIT 5.1	Regional Materials*	1 point

\*This credit is only applicable if in total 20% of the combined value of the procurement of construction materials and in the furniture are manufactured within a radius of 500 miles. This credit will apply if the installation of the finished product occurs within 500 miles of Kitchener, Ontario.

## level® CERTIFICATION & AIR EMISSIONS CERTIFICATION



### level® CERTIFICATION

BIFMA's e3 Furniture Sustainability Standard is a voluntary, multi-attribute standard that measures the degree of sustainability of furniture. This standard evaluates product and company environmental attributes and compliance systems in a wide range of elements which include Materials, Energy & Atmosphere, Human & Ecosystem Health and Social Responsibility. Dorso products have earned level®, BIFMA's sustainability certification program for furniture, certification through third-party verification against the e3 standard.



### AIR EMISSIONS

All Dorso products are supplied air-emissions certified. Contact customer service for information.

# DORSO S-LINE & N-LINE | FEATURES



## ARM STYLES

Optional fixed cantilever or an adjustable black arm constructed of die cast metal with textured plastic arm pads. The adjustable arms feature seven height adjustment positions, with a total adjustment range of 2.75". All Dorso models are also available in armless versions.

## S-LINE

Fixed cantilever and adjustable arms are available in Black, Silver Metallic or Polished Chrome accent finishes to match metal base. The fixed arm is also available in black textured plastic and upholstered fabric/leather version.

## N-LINE

Fixed cantilever and adjustable arms are available in black textured plastic.



## BASE STYLES

Dorso seating features injection molded, glass reinforced black nylon bases with dual wheel casters. Dorso seating features optional Silver Metallic or Polished Chrome finish. S-Line models feature steel upper and lower seat back exposed frame rail available in Silver Metallic or Polished Chrome finish.

## DORSO GUEST SEATING

### S-LINE

Dorso seating is available in three base styles:  
Cantilever  
4-Leg  
4-Leg with twin wheel casters



Each is offered in a Silver Metallic or Polished Chrome steel frame. Cantilever and 4-Leg versions of Guest Seating feature rubber glides.

### N-LINE

Dorso seating is available in three base styles:  
Cantilever  
4-Leg  
4-Leg with twin wheel casters

Each is offered in a Silver Metallic steel frame.

## BACK HEIGHT

Back height adjustment is a standard feature on S-Line chairs, and an option on N-Line chairs. It offers an adjustment range of 11 positions, over a 2" range of movement. Back height adjustment is operated while in the seated position, by placing the right hand on the right bottom of the chair back, and the left hand on the left bottom of the chair back. The back is lifted and clicked into the desired height. Raising the back to the highest position releases the back height lock so it can be lowered.



## BACK TENSION

Back tension on the synchro tilt mechanism is controlled with an adjustment knob under the seat. It has been designed to provide a range of back tension adjustment suitable for users of varying sizes and preferences.



## DORSO CONTROLS

All Dorso S-Line and N-Line tilters come with a synchro tilt mechanism. One of the best engineered and most user-friendly chair controls, the synchro tilt mechanism is unique in providing a single, easy-accessed lever to adjust tilt lock positions and seat height. The tilt adjustment range offers five recline-lock positions, as well as free flowing movement. The forward pivot of the mechanism allows the back and the seat to articulate synchronously in a 2:1 ratio, so that upward tilt of the seat is minimized as the back reclines. The synchro tilt mechanism also features an anti-kickback lock release, providing a smooth transition from locked to unlocked tilt adjustment.

## SEAT HEIGHT

In the seated position, a pull upwards on the height adjustment lever located under the seat of the user's right side adjusts the height up or down with a total height range of 4.5".

## SEAT SLIDER

All Dorso tilters are available with an optional seat slider mechanism featuring a 2" range of adjustment front to back when seated. The lever to activate this feature is located under the seat of the user's right side and is activated by an upward pull of the lever.

## CAL 133 & MOISTURE BARRIER

California Technical Bulletin 133 is a flammability test for seating. Krug offers a compliance method which, in combination with non-flammable upholstery covers, may enable the products to meet certification requirements for this test. This process at the same time also provides the products with a Moisture Barrier - a treatment that helps to prevent the passage of liquids and moisture to inside of upholstered components - thereby conferring sanitary and anti-infection benefits. So when CAL 133 is specified, the product also automatically has a Moisture Barrier, and when a Moisture Barrier is specified, the product also features the compliance method and low flammability features of CAL 133.

The application of this upcharge and the compliance method does not mean that the specific configuration of product and upholstery cover are tested and officially certified as being CAL 133 compliant. If official certification is required, Krug will provide this (through an independent certified testing laboratory) at a charge of \$917 per item, plus the cost of the product to be tested. Lead time for certification testing is typically 4-8 weeks. Krug assumes no responsibility for the testing of our products in combination with upholstery covers, or for the results of any testing conducted. Some specific configurations of product and upholstery have already been tested. Please contact Customer Service for additional information.

# DORSO S-LINE & N-LINE | DIMENSIONS & COM REQUIREMENTS

Presenting one of the world's most advanced seating concepts: new technology that offers outstanding ergonomics in a strikingly modern chair design, while providing a level of long-term sitting comfort and support that has been the hallmark of European seating.  
DORSO: Designed by Gabriel Teixidó

		Overall Width	Overall Depth	Overall Height	Seat Height	Height of Arms from Floor	Width between Arms	Seat Depth	Shipping Weight	Cube	COM Yardage
S-LINE MID BACK	Fixed	24.5	22.5	42.5	18-22	27-30.5	20	18	51	15	1.7
	Adjustable	25	22.5	42.5	18-22	25.5-32	19.5	18	51	15	1.7
	Armless	19.5	22.5	42.5	18-22	N/A	N/A	18	46	15	1.7
S-LINE HIGH BACK	Fixed	24.5	22.5	47	18-22	27-30.5	20	18	52	18	1.9
	Adjustable	25	22.5	47	18-22	25.5-32	19.5	18	52	18	1.9
	Armless	19.5	22.5	47	18-22	N/A	N/A	18	47	18	1.9
S-LINE HIGH BACK with Headrest	Fixed	24.5	22.5	50.5	18-22	27-30.5	20	18	54	18	1.9
	Adjustable	25	22.5	50.5	18-22	25.5-32	19.5	18	54	18	1.9
N-LINE MID BACK	Fixed	24.5	21.5	41	18-22	27-30.5	20	18	50	15	1.7
	Adjustable	25	21.5	41	18-22	25.5-32	19.5	18	50	15	1.7
	Armless	19.5	21.5	41	18-22	N/A	N/A	18	45	15	1.7
N-LINE HIGH BACK	Fixed	24.5	21.5	45.5	18-22	27-30.5	20	18	51	18	1.9
	Adjustable	25	21.5	45.5	18-22	25.5-32	19.5	18	51	18	1.9
N-LINE HIGH BACK with Headrest	Fixed	24.5	21.5	50.5	18-22	27-30.5	20	18	53	19.5	1.9
	Adjustable	25	21.5	50.5	18-22	25.5-32	19.5	18	53	19.5	1.9

GUEST		Overall Width	Overall Depth	Seat Height	Height of Arms from Floor	Width between Arms	Seat Depth	Height Range	Shipping Weight	Cube	COM Yardage
S-LINE/4LEG	Armless	20.75	25.50	18.5	27.5	19.5	19.5	36	32	14	1.3
	Fixed	24.5	25.50	18.5	27.5	19.5	19.5	36	37	14	1.3
S-LINE/4LEG with Casters	Armless	20.75	24.75	18.5	27.5	19.5	19.5	36	33	14	1.3
	Fixed	24.5	24.75	18.5	27.5	19.5	19.5	36	38	14	1.3
S-LINE/ Cantilever Base	Armless	20.75	24.75	18.5	27.5	19.5	19.5	36	39	14	1.3
	Fixed	24.5	24.75	18.5	27.5	19.5	19.5	36	44	14	1.3
N-LINE/4LEG	Armless	20.75	25.50	18.5	27.5	19.5	19.5	34.75	31	14	1.3
	Fixed	24.5	25.50	18.5	27.5	19.5	19.5	34.75	36	14	1.3
N-LINE/4LEG with Casters	Armless	20.75	24.75	18.5	27.5	19.5	19.5	34.75	32	14	1.3
	Fixed	24.5	24.75	18.5	27.5	19.5	19.5	34.75	37	14	1.3
N-LINE/ Cantilever Base	Armless	20.75	24.75	18.5	27.5	19.5	19.5	34.75	38	14	1.3
	Fixed	24.5	24.75	18.5	27.5	19.5	19.5	34.75	43	14	1.3

## ORDERING NOTE

Add 0.5 yards for seating with leather wrapped arm option.

Note: Some vinyls are not suitable for application on Dorso seating. For vinyls other than Maharam's Lariat, or Momentum's Cashmere, please submit a sample to Customer Service for an approval process at time of order.

The approval process is as follows:



1. A sample of the COM vinyl fabric must be provided to Krug Customer Service prior to or at time of order.
2. The sample will be reviewed and the customer advised if the fabric is unsuitable.
3. The COM vinyl will be inspected when received at the factory to identify and further concerns with its suitability.

## ORDERING NOTES

All Dorso swivel and tilter models are available with an optional seat slider mechanism at an upcharge of **\$80 list**.

Height measurements of Dorso are taken with the pneumatic lift in the lowest position. All dimensions are in inches and approximate and are subject to change without notice. Contact Customer Service if dimensions are critical.

# DORSO S-LINE | MID BACK

DESCRIPTION/MODEL	COM		COL	FABRIC GRADES			LEATHER			
	1	2	3	4	5	6	7	8	9	
	FIXED ARMS (Black with metal accent)									
	DOS1-M2011M	1761	1827	1894	1980	2086	2212	2346	2502	2671
	Silver Metallic									
	DOS1-M2031M	1984	2058	2133	2223	2340	2473	2615	2791	2971
	Silver Metallic									
	DOC1-M2011M	1845	1913	1980	2069	2173	2287	2433	2587	2761
Polished Chrome										
DOC1-M2031M	2066	2144	2218	2315	2429	2551	2703	2879	3059	
Polished Chrome										
	ADJUSTABLE ARMS (Black with metal accent)									
	DOS1-M2021M	1691	1761	1827	1913	2019	2134	2279	2433	2607
	Silver Metallic									
	DOC1-M2021M	1779	1845	1913	2001	2107	2220	2364	2518	2694
Polished Chrome										
	ARMLESS									
	DOS1-M2001M	1579	1644	1714	1798	1907	2031	2164	2319	2489
	Silver Metallic									
	DOC1-M2001M	1654	1723	1789	1872	1980	2107	2240	2394	2567
Polished Chrome										

## ORDERING NOTES

Dorso S-Line versions are available without the back metal accent detail. Please contact Customer Service for ordering information. Seat slider option is available on all tilter chair models at an upcharge of **\$80 list**. The upholstered leather cantilever arm is only available for use with Krug in-stock leathers. For jury base version of this chair, please add a 'J' for the base style at the end of the model number and **add \$77** to the list price. CAL 133 and Moisture Barrier options are available for an upcharge of **\$64 list per yard**. See page 333 for more information.



## PRODUCT CODE KEY

Line	Series	Back Style	Back Adjustment	Back Details	Arm Style	Mechanism	Base
DOS	1	M	2	0	0	1	M
Dorso S-Line (Silver Metallic)	Management, Task & Conference Seating	Mid Back	Adjustment	No Headrest	Armless	Synchro	Metal Base
DOC		H		1	1	2	J
Dorso S-Line (Polished Chrome)		High Back		Headrest (No trim) (High back only)	Fixed Cantilever	Synchro/Seat Slider	Jury Base
					2		
					Adjustable (Black)		
					3		
					Fixed Cantilever Upholstered		

# DORSO S-LINE | HIGH BACK

DESCRIPTION/MODEL	COM		COL	FABRIC GRADES			LEATHER			
	1	2	3	4	5	6	7	8	9	
	FIXED ARMS (Black with metal accent)									
	DOS1-H2011M	1907	1989	2079	2194	2327	2489	2684	2903	3144
	Silver Metallic									
	DOS1-H2031M	2130	2219	2316	2440	2581	2751	2955	3192	3445
	Silver Metallic									
	DOC1-H2011M	1991	2077	2165	2281	2415	2577	2772	2989	3234
Polished Chrome										
DOC1-H2031M	2214	2306	2404	2527	2669	2838	3042	3280	3534	
Polished Chrome										

	ADJUSTABLE ARMS (Black with metal accent)									
	DOS1-H2021M	1837	1924	2011	2124	2263	2420	2614	2828	3078
	Silver Metallic									
	DOC1-H2021M	1924	2011	2096	2212	2346	2511	2701	2913	3163
Polished Chrome										

# DORSO S-LINE | HIGH BACK WITH HEADREST

	FIXED ARMS (Black with metal accent)									
	DOS1-H2111M	2096	2202	2299	2433	2587	2770	2982	3210	3470
	Silver Metallic									
	DOS1-H2131M	2319	2433	2538	2680	2842	3032	3249	3501	3770
	Silver Metallic									
	DOC1-H2111M	2182	2287	2386	2518	2671	2854	3068	3299	3560
Polished Chrome										
DOC1-H2131M	2404	2518	2625	2764	2926	3117	3339	3591	3859	
Polished Chrome										

	ADJUSTABLE ARMS (Black with metal accent)									
	DOS1-H2121M	2031	2124	2229	2364	2518	2701	2903	3144	3404
	Silver Metallic									
	DOC1-H2121M	2114	2212	2319	2452	2607	2789	2991	3231	3490
Polished Chrome										

## ORDERING NOTES



Dorso S-Line versions are available without the back metal accent detail. Please contact Customer Service for ordering information. Seat slider option is available on all tilter chair models at an upcharge of **\$80 list**. The upholstered leather cantilever arm is only available for use with Krug in-stock leathers. For jury base version of this chair, please add a 'J' for the base style at the end of the model number and **add \$77** to the list price. CAL 133 and Moisture Barrier options are available for an upcharge of **\$64 list per yard**. See page 333 for more information.



## PRODUCT CODE KEY

Line	Series	Back Style	Back Adjustment	Back Details	Arm Style	Mechanism	Base
DOS	1	M	2	0	0	1	M
Dorso S-Line (Silver Metallic)	Management, Task & Conference Seating	Mid Back	Adjustment	No Headrest	Armless	Synchro	Metal Base
DOC		H		1	1	2	J
Dorso S-Line (Polished Chrome)		High Back		Headrest (No trim) (High back only)	Fixed Cantilever	Synchro/Seat Slider	Jury Base
					2		
					Adjustable (Black)		
					3		
					Fixed Cantilever Upholstered		

# DORSO N-LINE | MID BACK

DESCRIPTION/MODEL	COM		COL		FABRIC GRADES			LEATHER		
	1	2	3	4	5	6	7	8	9	
 FIXED ARMS (Black) DON1-M1011B No back adjustment DON1-M2011B With back adjustment	1548	1617	1692	1779	1872	2001	2134	2299	2471	
	1638	1702	1779	1866	1964	2086	2220	2386	2557	
 ADJUSTABLE ARMS (Black) DON1-M1021B No back adjustment DON1-M2021B With back adjustment	1482	1548	1617	1702	1808	1932	2069	2220	2394	
	1568	1638	1702	1789	1894	2019	2157	2307	2481	
 ARMLESS DON1-M1001B No back adjustment DON1-M2001B With back adjustment	1363	1433	1509	1594	1692	1818	1954	2114	2287	
	1441	1521	1588	1673	1779	1894	2037	2194	2364	

Each chair features the Synchro Tilt mechanism

## ORDERING NOTES

Dorso N-Line tilter models feature black bases and are available with an optional polished chrome base or silver metallic base at an upcharge of **\$199**.

Seat slider option is available on all tilter chair models at an upcharge of **\$80 list**.

For jury base version of this chair, please add a 'J' for the base style at the end of the model number and **add \$77** to the list price.



CAL 133 and Moisture Barrier options are available for an upcharge of **\$64 list per yard**. See page 333 for more information.





## PRODUCT CODE KEY

Line	Series	Back Style	Back Adjustment	Back Details	Arm Style	Mechanism	Base
DON	1	M	1	0	0	1	B
Dorso N-Line	Management, Task & Conference Seating	Mid Back	No Adjustment	No Headrest	Armless	Synchro	Black Nylon Base
		H	2	1	1	2	J
		High Back	Adjustment	Headrest (No trim) (High back only)	Fixed (Black) Cantilever	Synchro/Seat Slider	Jury Base
					2		
					Adjustable (Black)		

## DORSO N-LINE | HIGH BACK

DESCRIPTION/MODEL	COM		COL			FABRIC GRADES			LEATHER	
	1	2	3	4	5	6	7	8	9	
	FIXED ARMS (Black)									
	DON1-H1011B									
	1730	1818	1907	2019	2157	2319	2511	2732	2971	
	No back adjustment									
DON1-H2011B										
1818	1907	1989	2107	2240	2406	2595	2819	3058		
With back adjustment										
	ADJUSTABLE ARMS (Black)									
	DON1-H1021B									
	1664	1748	1837	1954	2086	2252	2443	2654	2903	
	No back adjustment									
DON1-H2021B										
1748	1837	1924	2037	2173	2337	2530	2741	2991		
With back adjustment										

## DORSO N-LINE | HIGH BACK WITH HEADREST

	FIXED ARMS (Black)									
	DON1-H1111B									
	1924	2031	2124	2263	2415	2595	2807	3038	3299	
	No back adjustment									
DON1-H2111B										
2011	2114	2212	2346	2502	2684	2894	3127	3383		
With back adjustment										
	ADJUSTABLE ARMS (Black)									
	DON1-H1121B									
	1857	1954	2058	2194	2346	2530	2732	2971	3231	
	No back adjustment									
DON1-H2121B										
1944	2037	2145	2279	2433	2614	2819	3058	3316		
With back adjustment										

### ORDERING NOTES

Dorso N-Line tilter models feature black bases and are available with an optional polished chrome base or silver metallic base at an upcharge of **\$199**.

Seat slider option is available on all tilter chair models at an upcharge of **\$80 list**.

For jury base version of this chair, please add a 'J' for the base style at the end of the model number and **add \$77** to the list price.

CAL 133 and Moisture Barrier options are available for an upcharge of **\$64 list per yard**. See page 333 for more information.



### PRODUCT CODE KEY

Line	Series	Back Style	Back Adjustment	Back Details	Arm Style	Mechanism	Base
DON	1	M	1	0	0	1	B
Dorso N-Line	Management, Task & Conference Seating	Mid Back	No Adjustment	No Headrest	Armless	Synchro	Black Nylon Base
		H	2	1	1	2	J
		High Back	Adjustment	Headrest (No trim) (High back only)	Fixed (Black) Cantilever	Synchro/Seat Slider	Jury Base
					2		
					Adjustable (Black)		

# ME | ENVIRONMENTAL SUMMARY

## LEED CI CREDITS



### MATERIAL CONTENT:

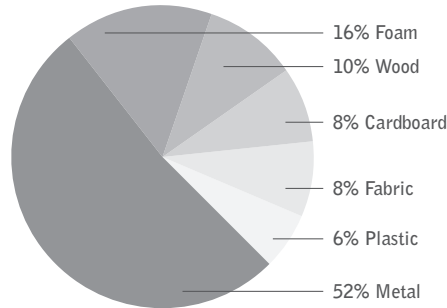

PRE-CONSUMER  
RECYCLED CONTENT = 4.67%

POST-CONSUMER  
RECYCLED CONTENT = 17.3%

Up to 26.67% of this Cadence product is recyclable at the end of its useful life.

### CONTRIBUTES TO

CREDIT 2.1 - 2.2	Construction Waste Management	1-2 point(s)
CREDIT 3.3	Resource Reuse	1 point
CREDIT 4.1	Recycled Content	1 point
CREDIT 4.5	Low Emitting Materials, Systems & Seating	1 point
CREDIT 5.1	Regional Materials*	1 point
CREDIT 7	Certified Wood (MUST BE REQUESTED)	1 point(s)

\*This credit is only applicable if in total 20% of the combined value of the procurement of construction materials and in the furniture are manufactured within a radius of 500 miles. This credit will apply if the installation of the finished product occurs within 500 miles of Kitchener, Ontario.

## level® CERTIFICATION, AIR EMISSIONS AND FSC® CERTIFICATION



### level® CERTIFICATION

BIFMA's e3 Furniture Sustainability Standard is a voluntary, multi-attribute standard that measures the degree of sustainability of furniture. This standard evaluates product and company environmental attributes and compliance systems in a wide range of elements which include Materials, Energy & Atmosphere, Human & Ecosystem Health and Social Responsibility. Me products have earned level®, BIFMA's sustainability certification program for furniture, certification through third-party verification against the e3 standard.

### AIR-EMISSIONS

All Me products are supplied with air-emissions certified. Contact customer service for information.



### FSC®

In 2005, Krug received Forest Stewardship Council® (FSC®) Chain-of-Custody certification for our manufacturing facilities. The FSC® Chain-of-Custody tracks certified wood from seedling to final sale. It verifies that the material for our FSC® certified products only come from well-managed, FSC®-certified forests and other controlled sources. FSC® is dedicated to the promotion of responsible forest management worldwide helping to take care of forests for future generations. Me and other Krug products can be specified with FSC® Certification. Contact customer service for further information, pricing and lead times.



Architects, designers, and building professionals can specify FSC®-certified products in order to achieve a point from the U.S. Green Building Council's Leadership in Energy and Environmental Design (LEED) Rating System.



Me brings new meaning to custom seating. Your comfort. Your style. Your chair.

With Me, options, styling and versatility are virtually endless, and comfort is superior. With Me, Krug has created a chair that not only provides unprecedented comfort and natural posture support, but also exceptional styling. Me is an adaptable seating solution for any management, task and conference environment.



#### ARM STYLES

Four arm styles are available on Me. In addition to the armless version, is the urethane over molded steel supported fixed cantilever arm, or the adjustable pad arms: urethane pad arms, or upholstered pad arms. Both adjustable arm versions feature: pivoting arms that adjust 30 degrees inward or outward, 1 1/2" left and right width adjustment control, and a 6 stop position arm height range with a total of 2.6" of height adjustment. When specifying leather on the upholstered arm pad version, the user has the option of a perforated arm pad (available when specifying Krug's stock leather only). When specifying polished aluminum bases on Me, the arm upright will also be finished in polished aluminum (on adjustable arm versions only).



#### BASE STYLES

Me seating is available in two base options. Choose from an injection molded, glass reinforced black nylon base or polished cast aluminum base, both with 2 1/4" dual wheel casters.



#### ME CONTROLS

Me features a standard synchro tilt mechanism that allows the back and the seat to articulate synchronously in a 2:1 ratio. This feature insures that the upward tilt of the seat is minimized as the back reclines. The mechanism that also features a standard tilt lock mechanism that allows the user an infinite number of recline lock positions. Simply push the tilt lock lever downward to lock and upward to free-float the back.

#### SEAT HEIGHT

In the seated position, a pull upwards on the height adjustment lever located under the seat of the user's right side adjusts the height up or down with a total height range of:

Standard gas lift: 4.25" without seat slider and 4.0" with seat slider.

Low gas lift: 3.5" without seat slider and 3.5" with seat slider.

#### BACK TENSION

The back tension adjustment knob is located on the front underside of the seat. A simple turn of the knob provides a range of back tension adjustment suitable for users of varying sizes and preferences.

#### UPHOLSTERY OPTIONS

With Me comes the ability to choose contrasting fabrics/leathers for the seat, upper and lower back sections, as well as the upholstered arm pads. This option allows for an endless possibility of custom designed seating options (see upcharges on the following pages). When specifying leather from Krug's in-stock leather program, the option to perforate the leather on the lower back and upholstered pad arms is available (see pricing on the following pages).

#### SEAT SLIDER

All Me adjustable arm versions are available with an optional seat slider mechanism featuring a 2" range of adjustment front to back when seated. The lever to activate this feature is located under the seat of the user's left side and is activated by a simple twist of the knob.



#### BACK HEIGHT

Me is available in three back heights: low, mid and high. Back height adjustment is a standard feature on all Me models. This feature offers an adjustment range of 11 positions over a 2 1/2" range of movement. Back height adjustment is operated while in the seated position, by placing the right hand of the right bottom of the chair back, and the left hand on the left bottom of the chair back. The back is lifted and clicked into the desired height. Raising the back to the highest position releases the back height lock so it can be lowered to the first and lowest stop position.

#### OPTIONAL GAS LIFT HEIGHT RANGES

Me is available with two gas lift ranges. Unless clearly specified on order, Me seating will be provided with the standard gas lift. The gas lift ranges measured from the seat height are as follows:

**Non Seat Slider Versions:** Standard gas lifts give a seat height of no greater than 16" when lowered and no less than 20" when extended. Low gas lifts give a seat height of no greater than 15 1/8" when lowered and no less than 18 5/16" when extended.

**Seat Slider Versions:** Standard gas lifts give a seat height of no greater than 16 1/4" when lowered and no less than 20 5/16" when extended. Low gas lifts give a seat height of no greater than 15 3/8" when lowered and no less than 18 15/16" when extended. If dimensions are critical, please contact Customer Service.

#### CAL 133 & MOISTURE BARRIER

California Technical Bulletin 133 is a flammability test for seating. Krug offers a compliance method which, in combination with non-flammable upholstery covers, may enable the products to meet certification requirements for this test. This process at the same time also provides the products with a Moisture Barrier - a treatment that helps to prevent the passage of liquids and moisture to inside of upholstered components - thereby conferring sanitary and anti-infection benefits. So when CAL 133 is specified, the product also automatically has a Moisture Barrier, and when a Moisture Barrier is specified, the product also features the compliance method and low flammability features of CAL 133.

The application of this upcharge and the compliance method does not mean that the specific configuration of product and upholstery cover are tested and officially certified as being CAL 133 compliant. If official certification is required, Krug will provide this (through an independent certified testing laboratory) at a charge of \$917 per item, plus the cost of the product to be tested. Lead time for certification testing is typically 4-8 weeks. Krug assumes no responsibility for the testing of our products in combination with upholstery covers, or for the results of any testing conducted. Some specific configurations of product and upholstery have already been tested. Please contact Customer Service for additional information.

# ME | DIMENSIONS & COM REQUIREMENTS

		Overall Width	Overall Depth	Overall Height	Height of Arms from Floor	Width between Arms	Seat Depth	Shipping Weight	Cube	COM Yardage
LOW BACK	Armless	20	21.75	36.5	N/A	N/A	19	39	16	1.7
	Fixed	23	21.75	36.5	27.13	19	19	46	16	1.7
	Adjustable Urethane	24.75	21.75	36.5	24	17.25	19	46	16	1.7
	Adjustable Upholstered	25.5	21.75	36.5	24.25	16.75	19	46	16	1.7
MID BACK	Armless	20	21.75	39	N/A	N/A	19	43	18	1.8
	Fixed	23	21.75	39	27.13	19	19	48	18	1.8
	Adjustable Urethane	24.75	21.75	39	24	17.25	19	48	18	1.8
	Adjustable Upholstered	25.5	21.75	39	24.25	16.75	19	48	18	1.8
HIGH BACK	Armless	20	21.75	41.6	N/A	N/A	19	45	20	1.9
	Fixed	23	21.75	41.6	27.13	19	19	50	20	1.9
	Adjustable Urethane	24.75	21.75	41.6	24	17.25	19	50	20	1.9
	Adjustable Upholstered	25.5	21.75	41.6	24.25	16.75	19	50	20	1.9

Height measurements of Me are taken with the pneumatic lift in the lowest position and with a standard height range gas lift. All dimensions are in inches and approximate and are subject to change without notice. Contact Customer Service if dimensions are critical.

**Note:** Some vinyls are not suitable for upholstery on Me seating. For vinyls other than Maharam's Lariat, or Momentum's Cashmere, please submit a sample to Customer Service.

The approval process is as follows:

1. A sample of the COM vinyl fabric must be provided to Krug Customer Service prior to or at time of order. For Maharam or Momentum fabric, Krug will obtain the fabric sample.
2. The sample will be reviewed and the customer advised if the fabric is unsuitable.
3. The COM vinyl will be inspected when received at the factory to identify and further concerns with its suitability.

## COM REQUIREMENTS PER CHAIR SECTION

Upper Back*	Lower Back*	Seat	Arm Pads
0.7	0.5	0.75	0.4

Measurements above are provided in yards.

\*Upper and Lower Backs consist of both the inside and outside back.

Me | LOW BACK







Me | MID BACK



Me | HIGH BACK







DESCRIPTION/MODEL	COM		COL		FABRIC GRADES			LEATHER		
	1	2	3	4	5	6	7	8	9	
	FIXED ARMS									
	MTH1 L2 11B	1251	1316	1363	1548	1638	1714	1857	2164	2420
	Standard back upholstery, black base									
	MTH1 L2 21B								2337	
	Perforated back upholstery, black base									
	MTH1 L2 11A	1376	1441	1499	1683	1771	1837	1980	2299	2557
Standard back upholstery, silver metallic base										
MTH1 L2 21A								2471		
Perforated back upholstery, silver metallic base										
	ADJUSTABLE URETHANE PAD ARMS									
	MTH1 L2 12B	1213	1268	1330	1480	1579	1644	1789	2079	2345
	Standard back upholstery, black base									
	MTH1 L2 22B								2252	
	Perforated back upholstery, black base									
	MTH1 L2 12A	1347	1393	1452	1617	1714	1779	1912	2212	2481
Standard back upholstery, silver metallic base										
MTH1 L2 22A								2386		
Perforated back upholstery, silver metallic base										
	UPHOLSTERED ADJUSTABLE PAD ARMS									
	MTH1 L2 13B	1268	1330	1393	1557	1654	1730	1866	2182	2471
	Standard back upholstery, black base									
	MTH1 L2 23B								2356	
	Perforated back upholstery, black base									
	MTH1 L2 13A	1404	1452	1521	1692	1789	1866	1999	2307	2595
Standard back upholstery, silver metallic base										
MTH1 L2 23A								2481		
Perforated back upholstery, silver metallic base										
	ARMLESS									
	MTH1 L2 10B	1135	1203	1260	1441	1521	1594	1741	2058	2307
	Standard back upholstery, black base									
	MTH1 L2 20B								2230	
	Perforated back upholstery, black base									
	MTH1 L2 10A	1282	1338	1386	1567	1654	1723	1866	2182	2443
Standard back upholstery, silver metallic base										
MTH1 L2 20A								2356		
Perforated back upholstery, silver metallic base										

**ORDERING NOTES:** Perforated leather option is available with only the Krug in stock leather program. The perforated leather option is not available on the *KrugExpress* program. Please specify clearly on purchase order if low gas lift is to be applied. Seat slider option is available on all armless and adjustable arm versions at an upcharge of **\$80 list**. For Jury Base version of this chair, please add a 'J' for the base style at the end of the model number and **add \$77** to the list price. Value Mechanism Option - for a price reduction of \$100 per chair, we offer a lower-function mechanism option, which includes full swivel and reward tilt capability, tilt tension control, and gas lift height adjustable activator. CAL 133 and Moisture Barrier options are available for an upcharge of **\$64 list per yard**.

**PRODUCT CODE KEY**

Line	Series	Back Style	Back Adjustment	Back Details	Arm Style	Base
MTH	1	L	2	1	0	B
Me	Management, Task & Conference Seating	Low Back	Adjustable	Standard Back Upholstery	Armless	Black Base
		M		2	1	A
		Mid Back		Perforated Back Upholstery	Fixed Cantilever	Silver Metallic Base
		H			2	J
		High Back			Adjustable Urethane Pad Arms	Jury Base
					3	
					Adjustable Upholstered Pad Arms	



# ME | MID BACK

DESCRIPTION/MODEL	COM		COL		FABRIC GRADES			LEATHER		
	1	2	3	4	5	6	7	8	9	
	FIXED ARMS									
	MTH1 M2 11B	1347	1414	1473	1664	1761	1837	1989	2327	2607
	Standard back upholstery, black base									
	MTH1 M2 21B								2502	
	Perforated back upholstery, black base									
	MTH1 M2 11A	1473	1538	1607	1789	1885	1964	2124	2462	2732
Standard back upholstery, silver metallic base										
MTH1 M2 21A										
Perforated back upholstery, silver metallic base										
	ADJUSTABLE URETHANE PAD ARMS									
	MTH1 M2 12B	1298	1363	1423	1594	1692	1771	1912	2230	2518
	Standard back upholstery, black base									
	MTH1 M2 22B								2406	
	Perforated back upholstery, black base									
	MTH1 M2 12A	1433	1492	1548	1730	1825	1907	2037	2364	2654
Standard back upholstery, silver metallic base										
MTH1 M2 22A										
Perforated back upholstery, silver metallic base										
	UPHOLSTERED ADJUSTABLE PAD ARMS									
	MTH1 M2 13B	1363	1433	1492	1673	1789	1857	2011	2345	2654
	Standard back upholstery, black base									
	MTH1 M2 23B								2518	
	Perforated back upholstery, black base									
	MTH1 M2 13A	1499	1557	1617	1798	1912	1980	2134	2481	2776
Standard back upholstery, silver metallic base										
MTH1 M2 23A										
Perforated back upholstery, silver metallic base										
	ARMLESS									
	MTH1 M2 10B	1222	1289	1347	1538	1638	1714	1866	2212	2481
	Standard back upholstery, black base									
	MTH1 M2 20B								2386	
	Perforated back upholstery, black base									
	MTH1 M2 10A	1347	1422	1480	1594	1771	1845	1999	2337	2614
Standard back upholstery, silver metallic base										
MTH1 M2 20A										
Perforated back upholstery, silver metallic base										

**ORDERING NOTES:** Perforated leather option is available with only the Krug in stock leather program. The perforated leather option is not available on the *KrugExpress* program. Please specify clearly on purchase order if low gas lift is to be applied. Seat slider option is available on all armless and adjustable arm versions at an upcharge of **\$80 list**. For Jury Base version of this chair, please add a 'J' for the base style at the end of the model number and **add \$77** to the list price. Value Mechanism Option - for a price reduction of \$100 per chair, we offer a lower-function mechanism option, which includes full swivel and reward tilt capability, tilt tension control, and gas lift height adjustable activator. CAL 133 and Moisture Barrier options are available for an upcharge of **\$64 list per yard**.

PRODUCT CODE KEY						
Line	Series	Back Style	Back Adjustment	Back Details	Arm Style	Base
MTH	1	L	2	1	0	B
Me	Management, Task & Conference Seating	Low Back	Adjustable	Standard Back Upholstery	Armless	Black Base
		M		2	1	A
		Mid Back		Perforated Back Upholstery	Fixed Cantilever	Silver Metallic Base
		H			2	J
		High Back			Adjustable Urethane Pad Arms	Jury Base
					3	
					Adjustable Upholstered Pad Arms	

# ME | HIGH BACK

DESCRIPTION/MODEL	COM		COL		FABRIC GRADES			LEATHER		
	1	2	3	4	5	6	7	8	9	
	FIXED ARMS									
	MTH1 H2 11B	1463	1548	1617	1837	1944	2031	2212	2587	2894
	Standard back upholstery, black base									
	MTH1 H2 21B								2761	
	Perforated back upholstery, black base									
	MTH1 H2 11A	1594	1683	1748	1954	2069	2157	2337	2721	3021
Standard back upholstery, silver metallic base										
MTH1 H2 21A										
Perforated back upholstery, silver metallic base										
	ADJUSTABLE URETHANE PAD ARMS									
	MTH1 H2 12B	1416	1492	1557	1761	1866	1954	2124	2489	2795
	Standard back upholstery, black base									
	MTH1 H2 22B								2671	
	Perforated back upholstery, black base									
	MTH1 H2 12A	1538	1617	1692	1885	1999	2079	2252	2628	2921
Standard back upholstery, silver metallic base										
MTH1 H2 22A										
Perforated back upholstery, silver metallic base										
	UPHOLSTERED ADJUSTABLE PAD ARMS									
	MTH1 H2 13B	1480	1567	1638	1845	1964	2037	2230	2614	2934
	Standard back upholstery, black base									
	MTH1 H2 23B								2789	
	Perforated back upholstery, black base									
	MTH1 H2 13A	1617	1692	1771	1971	2096	2173	2355	2748	3068
Standard back upholstery, silver metallic base										
MTH1 H2 23A										
Perforated back upholstery, silver metallic base										

**ORDERING NOTES:** Perforated leather option is available with only the Krug in stock leather program. The perforated leather option is not available on the *KrugExpress* program. Please specify clearly on purchase order if low gas lift is to be applied. Seat slider option is available on all armless and adjustable arm versions at an upcharge of **\$80 list**. For Jury Base version of this chair, please add a 'J' for the base style at the end of the model number and **add \$77** to the list price. Value Mechanism Option - for a price reduction of \$100 per chair, we offer a lower-function mechanism option, which includes full swivel and reward tilt capability, tilt tension control, and gas lift height adjustable activator. CAL 133 and Moisture Barrier options are available for an upcharge of **\$64 list per yard**.

## PRODUCT CODE KEY

Line	Series	Back Style	Back Adjustment	Back Details	Arm Style	Base
MTH	1	L	2	1	0	B
Me	Management, Task & Conference Seating	Low Back	Adjustable	Standard Back Upholstery	Armless	Black Base
		M		2	1	A
		Mid Back		Perforated Back Upholstery	Fixed Cantilever	Silver Metallic Base
		H			2	J
		High Back			Adjustable Urethane Pad Arms	Jury Base
					3	
					Adjustable Upholstered Pad Arms	

# PAN AM | ENVIRONMENTAL SUMMARY

## LEED CI CREDITS



### MATERIAL CONTENT:

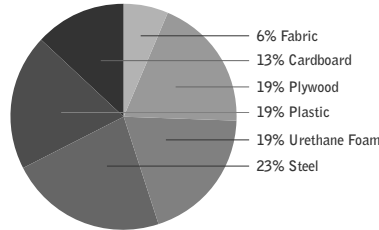

PRE-CONSUMER  
RECYCLED CONTENT = 6.29%

POST-CONSUMER  
RECYCLE CONTENT = 18.32%

Up to 24.19% of Pan Am product is recyclable at the end of its useful life.

### CONTRIBUTES TO

CREDIT 2.1 - 2.2	Construction Waste Management	1-2 point(s)
CREDIT 3.3	Resource Reuse	1 point
CREDIT 4.1	Recycled Content	1 point
CREDIT 4.2	Recycled Content	1 point
CREDIT 4.5	Low Emitting Materials, Systems & Seating	1 point
CREDIT 5.1	Regional Materials*	1 point
CREDIT 7	Certified Wood (MUST BE REQUESTED)	1 point(s)

\*This credit is only applicable if in total 20% of the combined value of the procurement of construction materials and in the furniture are manufactured within a radius of 500 miles. This credit will apply if the installation of the finished product occurs within 500 miles of Kitchener, Ontario.

## level® CERTIFICATION & AIR EMISSIONS CERTIFICATION



### level® CERTIFICATION

BIFMA's e3 Furniture Sustainability Standard is a voluntary, multi-attribute standard that measures the degree of sustainability of furniture. This standard evaluates product and company environmental attributes and compliance systems in a wide range of elements which include Materials, Energy & Atmosphere, Human & Ecosystem Health and Social Responsibility. Pan Am products have earned level®, BIFMA's sustainability certification program for furniture, certification through third-party verification against the e3 standard.



The mark of responsible forestry

### AIR EMISSIONS

All Pan Am products are supplied air-emissions certified. Contact customer service for information.

### FSC®

In 2005, Krug received Forest Stewardship Council® (FSC®) Chain-of-Custody certification for our manufacturing facilities. The FSC® Chain-of-Custody tracks certified wood from seedling to final sale. It verifies that the material for our FSC® certified products only come from well-managed, FSC®-certified forests and other controlled sources. FSC® is dedicated to the promotion of responsible forest management worldwide helping to take care of forests for future generations. Pan Am and other Krug products can be specified with FSC® Certification. Contact customer service for further information, pricing and lead times.



Architects, designers, and building professionals can specify FSC®-certified products in order to achieve a point from the U.S. Green Building Council's Leadership in Energy and Environmental Design (LEED) Rating System.



**ARM STYLES**

Pan Am features three styles of fixed arms, including open urethane, closed upholstered and open upholstered versions.



**BACK STYLES**

Available with two different back options, Mid and High, Pan Am is perfect for desk and conference applications.



**BASE STYLES**

Featuring a five blade caster base with 2 1/4" hooded dual wheel casters, Pan Am bases are available in both glass reinforced molded nylon base and polished cast aluminum base. (upcharge applies.)



**SEAT HEIGHT**

In the seated position, a pull upwards on the height adjustment lever located under the seat of the user's right side adjusts the height up or down with a total height range of:  
Standard gas lift: 3.5"  
Low gas lift: 3.0"



**TILT TENSION**

A tilt tension knob is located under the seat for all versions of Pan Am. For Knee Tilt versions a push of the height adjustment lever toward the gas lift cylinder activates the tilt lock feature.

**PAN AM CONTROLS**

Pan Am is available with either a Swivel Tilt of Knee Tilt mechanism. All Pan Am seating features an adjustable tilt tension knob, and height adjustment lever. On the Knee Tilt version of Pan Am, the height adjustment lever also operates a forward tilt lock.

**OPTIONAL GAS LIFT HEIGHT RANGES**

PAN AM is available with two gas lift ranges. Unless clearly specified on order, PAN AM seating will be provided with the standard gas lift. The gas lift ranges measured from the seat height are as follows: Pan Am standard gas lift give a seat height no greater than 16.4" when lowered and no less than 20.2" when extended. Low gas lift give a seat height no greater than 15.04" when lowered and no less than 18" when extended.

**OPTIONAL JURY BASE**

Jury Bases assembly consists of a black 9" diameter conical/cast base for permanently mounting a chair to the floor. Into the base is inserted a black pneumatic gas cylinder with self returning action from rotation, and self returning height feature when exiting the chair. Allows for full 360 degree rotation. Limited degrees of rotation are not available

**CAL 133 & MOISTURE BARRIER**

California Technical Bulletin 133 is a flammability test for seating. Krug offers a compliance method which, in combination with non-flammable upholstery covers, may enable the products to meet certification requirements for this test. This process at the same time also provides the products with a Moisture Barrier - a treatment that helps to prevent the passage of liquids and moisture to inside of upholstered components - thereby conferring sanitary and anti-infection benefits. So when CAL 133 is specified, the product also automatically has a Moisture Barrier, and when a Moisture Barrier is specified, the product also features the compliance method and low flammability features of CAL 133.

The application of this upcharge and the compliance method does not mean that the specific configuration of product and upholstery cover are tested and officially certified as being CAL 133 compliant. If official certification is required, Krug will provide this (through an independent certified testing laboratory) at a charge of \$917 per item, plus the cost of the product to be tested. Lead time for certification testing is typically 4-8 weeks. Krug assumes no responsibility for the testing of our products in combination with upholstery covers, or for the results of any testing conducted. Some specific configurations of product and upholstery have already been tested. Please contact Customer Service for additional information.

**DIMENSIONS & COM REQUIREMENTS**

		Overall Width	Overall Depth	Overall Height	Height of Arms from Floor	Width between Arms	Seat Depth	Shipping Weight	Cube	COM Yardage
MID BACK	Open Urethane	24.5	24.5	34.5	25	18.5	19	31	15.03	1.8
	Closed Upholstered	27.25	24.5	34.5	26.75	19	19	33	15.03	2.7
	Open Upholstered	24.5	24.5	34.5	25	18.5	19	31	15.03	2.2
HIGH BACK	Open Urethane	24.5	24.5	40	25	18.5	19	35	17.06	1.9
	Closed Upholstered	27.25	24.5	40	26.75	19	19	37	17.06	2.8
	Open Upholstered	24.5	24.5	40	25	18.5	19	35	17.06	2.3
HIGH BACK with Headrest	Open Urethane	24.5	24.5	46	25	18.5	19	37	18.75	2.5
	Closed Upholstered	27.25	24.5	46	26.75	19	19	39	18.75	3.4
	Open Upholstered	24.5	24.5	46	25	18.5	19	37	18.75	2.9



Note: Some vinyls are not suitable for upholstery on Pan Am seating. For vinyls other than Maharam's Lariat, or Momentum's Cashmere, please submit a sample to Customer Service for a pre-approval process at time of order.

The pre-approval process is as follows:

1. A sample of the COM vinyl fabric must be provided to Krug Customer Service prior to or at time of order.
2. The sample will be reviewed and the customer advised if the fabric is unsuitable.
3. The COM vinyl will be inspected when received at the factory to identify and further concerns with its suitability.

Please contact Customer Service for more information on options for the Pan Am series. Height measurements of Pan Am are taken with the pneumatic lift in the lowest position. All dimensions are in inches and approximate and are subject to change without notice. Contact Customer Service if dimensions are critical.

# PAN AM | MID BACK

DESCRIPTION/MODEL	COM		COL	FABRIC GRADES			LEATHER			
	1	2	3	4	5	6	7	8	9	
	OPEN URETHANE ARMS									
	PAN1-M11B	1092	1185	1295	1390	1499	1601	1702	1803	1979
	Black base, swivel tilt									
	PAN1-M12B	1230	1333	1433	1536	1645	1738	1852	1944	2117
	Black base, knee tilt									
	PAN1-M11A	1230	1333	1433	1528	1639	1738	1840	1944	2117
Polished aluminum base, swivel tilt										
PAN1-M12A	1370	1468	1572	1673	1786	1879	1988	2083	2256	
Polished aluminum base, knee tilt										
	CLOSED UPHOLSTERED ARMS									
	PAN1-M21B	1601	1747	1907	2054	2201	2347	2505	2656	2829
	Black base, swivel tilt									
	PAN1-M22B	1747	1896	2054	2201	2347	2497	2642	2803	2978
	Black base, knee tilt									
	PAN1-M21A	1738	1886	2045	2192	2340	2487	2642	2791	2968
Polished aluminum base, swivel tilt										
PAN1-M22A	1886	2035	2192	2340	2487	2636	2781	2942	3115	
Polished aluminum base, knee tilt										
	OPEN UPHOLSTERED ARMS									
	PAN1-M31B	1713	1857	2007	2164	2313	2460	2608	2757	2933
	Black base, swivel tilt									
	PAN1-M32B	1852	2007	2157	2301	2451	2608	2757	2903	3080
	Black base, knee tilt									
	PAN1-M31A	1852	1997	2146	2301	2451	2596	2727	2894	3071
Polished aluminum base, swivel tilt										
PAN1-M32A	1988	2146	2294	2441	2590	2746	2894	3040	3217	
Polished aluminum base, knee tilt										

## ORDERING NOTES

Please specify clearly on purchase order if low gas lift is to be applied.

For jury base version of this chair, please add a 'J' for the base style at the end of the model number and **add \$77** to the list price.

CAL 133 and Moisture Barrier options are available for an upcharge of **\$64 list per yard**.

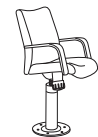



## PRODUCT CODE KEY

Line	Series	Back Style	Arm Style	Mechanism	Base
PAN	1	M	1	1	B
PAN AM	Management, Task & Conference Seating	Mid Back	Open Urethane Arm	Swivel Tilt	Black Base
		H	2	2	A
		High Back	Closed Upholstered Arm	Knee Tilt	Polished Aluminum Base
		HR	3		
		High Back with Headrest	Open Upholstered Arm		



# PAN AM | HIGH BACK

DESCRIPTION/MODEL	COM		COL		FABRIC GRADES			LEATHER		
	1	2	3	4	5	6	7	8	9	
	OPEN URETHANE ARMS									
	PAN1-H11B	1098	1203	1312	1423	1528	1639	1738	1852	2024
	Black base, swivel tilt									
	PAN1-H12B	1240	1354	1463	1572	1673	1786	1886	1997	2173
	Black base, knee tilt									
	PAN1-H11A	1240	1341	1452	1563	1666	1776	1879	1988	2164
Polished aluminum base, swivel tilt										
PAN1-H12A	1376	1487	1601	1713	1810	1867	2024	2138	2313	
Polished aluminum base, knee tilt										
	CLOSED UPHOLSTERED ARMS									
	PAN1-H21B	1610	1769	1923	2083	2237	2386	2552	2699	2877
	Black base, swivel tilt									
	PAN1-H22B	1756	1913	2072	2228	2386	2533	2694	2847	3024
	Black base, knee tilt									
	PAN1-H21A	1747	1907	2061	2219	2378	2526	2694	2838	3014
Polished aluminum base, swivel tilt										
PAN1-H22A	1896	2054	2212	2366	2526	2670	2829	2986	3161	
Polished aluminum base, knee tilt										
	OPEN UPHOLSTERED ARMS									
	PAN1-H31B	1720	1879	2035	2182	2340	2497	2656	2810	2986
	Black base, swivel tilt									
	PAN1-H32B	1867	2024	2182	2329	2487	2642	2803	2959	3135
	Black base, knee tilt									
	PAN1-H31A	1857	2017	2173	2323	2479	2636	2791	2948	3127
Polished aluminum base, swivel tilt										
PAN1-H32A	2007	2164	2323	2466	2628	2781	2942	3097	3271	
Polished aluminum base, knee tilt										

## ORDERING NOTES

Please specify clearly on purchase order if low gas lift is to be applied.

For jury base version of this chair, please add a 'J' for the base style at the end of the model number and **add \$77** to the list price.

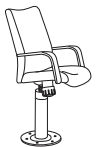

CAL 133 and Moisture Barrier options are available for an upcharge of **\$64 list per yard**.



## PRODUCT CODE KEY

Line	Series	Back Style	Arm Style	Mechanism	Base
PAN	1	M	1	1	B
PAN AM	Management, Task & Conference Seating	Mid Back	Open Urethane Arm	Swivel Tilt	Black Base
		H	2	2	A
		High Back	Closed Upholstered Arm	Knee Tilt	Polished Aluminum Base
		HR	3		
		High Back with Headrest	Open Upholstered Arm		

# PAN AM | HIGH BACK WITH HEADREST

DESCRIPTION/MODEL	COM		COL	FABRIC GRADES			LEATHER			
	1	2	3	4	5	6	7	8	9	
	OPEN URETHANE ARMS									
	PAN1-HR-11B	1166	1268	1377	1491	1592	1703	1803	1914	2088
	Black base, swivel tilt									
	PAN1-HR-12B	1306	1417	1528	1639	1741	1852	1954	2062	2239
	Black base, knee tilt									
	PAN1-HR-11A	1306	1405	1515	1631	1730	1840	1942	2054	2228
Polished aluminum base, swivel tilt										
PAN1-HR-12A	1441	1556	1667	1777	1879	1934	2088	2205	2378	
Polished aluminum base, knee tilt										
	CLOSED UPHOLSTERED ARMS									
	PAN1-HR-21B	1673	1834	1989	2146	2301	2451	2615	2765	2942
	Black base, swivel tilt									
	PAN1-HR-22B	1822	1979	2138	2294	2451	2601	2757	2912	3088
	Black base, knee tilt									
	PAN1-HR-21A	1811	1970	2126	2283	2443	2590	2757	2903	3080
Polished aluminum base, swivel tilt										
PAN1-HR-22A	1960	2117	2278	2432	2590	2736	2894	3052	3223	
Polished aluminum base, knee tilt										
	OPEN UPHOLSTERED ARMS									
	PAN1-HR-31B	1786	1942	2103	2247	2405	2563	2718	2877	3052
	Black base, swivel tilt									
	PAN1-HR-32B	1934	2088	2247	2394	2552	2712	2866	3025	3200
	Black base, knee tilt									
	PAN1-HR-31A	1923	2083	2239	2387	2542	2699	2858	3014	3189
Polished aluminum base, swivel tilt										
PAN1-HR-32A	2072	2228	2387	2533	2694	2848	3006	3162	3340	
Polished aluminum base, knee tilt										

## ORDERING NOTES

Please specify clearly on purchase order if low gas lift is to be applied.

For jury base version of this chair, please add a 'J' for the base style at the end of the model number and **add \$77** to the list price.

CAL 133 and Moisture Barrier options are available for an upcharge of **\$64 list per yard**.



## PRODUCT CODE KEY

Line	Series	Back Style	Arm Style	Mechanism	Base
PAN	1	M	1	1	B
PAN AM	Management, Task & Conference Seating	Mid Back	Open Urethane Arm	Swivel Tilt	Black Base
		H	2	2	A
		High Back	Closed Upholstered Arm	Knee Tilt	Polished Aluminum Base
		HR	3		
		High Back with Headrest	Open Upholstered Arm		

## LEED CI CREDITS

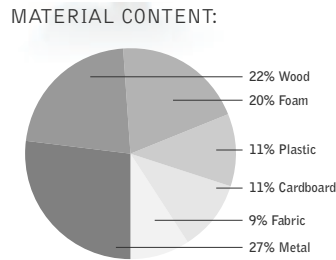

PRE-CONSUMER  
RECYCLED CONTENT = 4.67%

POST-CONSUMER  
RECYCLED CONTENT = 17.3%

Up to 26.67% of this Cadence product is recyclable at the end of its useful life.

### CONTRIBUTES TO

CREDIT	CONTRIBUTES TO	POINTS
CREDIT 2.1 - 2.2	Construction Waste Management	1-2 point(s)
CREDIT 3.3	Resource Reuse	1 point
CREDIT 4.1	Recycled Content	1 point
CREDIT 4.5	Low Emitting Materials, Systems & Seating	1 point
CREDIT 5.1	Regional Materials*	1 point
CREDIT 7	Certified Wood (MUST BE REQUESTED)	1 point(s)

\*This credit is only applicable if in total 20% of the combined value of the procurement of construction materials and in the furniture are manufactured within a radius of 500 miles. This credit will apply if the installation of the finished product occurs within 500 miles of Kitchener, Ontario.

## level® CERTIFICATION, AIR EMISSIONS AND FSC® CERTIFICATION



### level® CERTIFICATION

BIFMA's e3 Furniture Sustainability Standard is a voluntary, multi-attribute standard that measures the degree of sustainability of furniture. This standard evaluates product and company environmental attributes and compliance systems in a wide range of elements which include Materials, Energy & Atmosphere, Human & Ecosystem Health and Social Responsibility. Cadence products have earned level®, BIFMA's sustainability certification program for furniture, certification through third-party verification against the e3 standard.

### AIR-EMISSIONS

All Cadence products are supplied with air-emissions certified. Contact customer service for information.



### FSC®

In 2005, Krug received Forest Stewardship Council® (FSC®) Chain-of-Custody certification for our manufacturing facilities. The FSC® Chain-of-Custody tracks certified wood from seedling to final sale. It verifies that the material for our FSC® certified products only come from well-managed, FSC®-certified forests and other controlled sources. FSC® is dedicated to the promotion of responsible forest management worldwide helping to take care of forests for future generations. Cadence and other Krug products can be specified with FSC® Certification. Contact customer service for further information, pricing and lead times.



Architects, designers, and building professionals can specify FSC®-certified products in order to achieve a point from the U.S. Green Building Council's Leadership in Energy and Environmental Design (LEED) Rating System.

# CADENCE | FEATURES



## RECLINE ADJUSTMENT

The recline adjustment on the Cadence series allows a 24 degree range of motion. The foremost lever located on the right-hand side (when you are in a seated position) engages a device to lock the back in any position within the chair's range of movement. Lowering the lever locks the back at any position within the range. Raising the lever releases the lock and the back will move freely through the entire range.



## SEAT HEIGHT ADJUSTMENTS

The rear-most lever located in the right-hand side (when you are in the seated position) activates the seat height adjustment. Pull up on the lever to adjust seat height up or down through a range of adjustment of 3 inches.



## BACK HEIGHT ADJUSTMENT

(on selected models only)

The back height is adjustable on selected models of Cadence series. The mechanism adjusts the back while in the seated position. The adjustable height back has a 4 inch range of movement with an 8 position stop mechanism. Place both hands on either side of the lower back cushion and lift and click to the desired height. Raise the back to the highest position to release the back height lock and lower to the first and lowest position.



## BACK TENSION

A hand wheel centrally located near the front underside of the chair controls the amount of tension applied to the back. Turning the knob clockwise when you are in the seated position lessens the tension. Turning the knob counter-clockwise increases the tension.

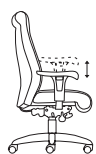

## ARM HEIGHT

(on selected models only)

A trigger release button located outside and below the arm pad adjusts the arm height. Depress the trigger to raise arm through its height range of 3.5 inches and 8 settings. Depress the trigger to raise the arm, release when desired height is reached to lock in position.

## CAL 133 & MOISTURE BARRIER

California Technical Bulletin 133 is a flammability test for seating. Krug offers a compliance method which, in combination with non-flammable upholstery covers, may enable the products to meet certification requirements for this test. This process at the same time also provides the products with a Moisture Barrier - a treatment that helps to prevent the passage of liquids and moisture to inside of upholstered components - thereby conferring sanitary and anti-infection benefits. So when CAL 133 is specified, the product also automatically has a Moisture Barrier, and when a Moisture Barrier is specified, the product also features the compliance method and low flammability features of CAL 133. CAL 133 and Moisture Barrier are available for an upcharge of **\$64 list per yard.**

The application of this upcharge and the compliance method does not mean that the specific configuration of product and upholstery cover are tested and officially certified as being CAL 133 compliant. If official certification is required, Krug will provide this (through an independent certified testing laboratory) at a charge of \$917 per item, plus the cost of the product to be tested. Lead time for certification testing is typically 4-8 weeks. Krug assumes no responsibility for the testing of our products in combination with upholstery covers, or for the results of any testing conducted. Some specific configurations of product and upholstery have already been tested. Please contact Customer Service for additional information.

## DIMENSIONS & COM REQUIREMENTS

		Overall Width	Overall Depth	Overall Height	Seat Height	Height of Arms from floor	Width between Arms	Seat Depth	Height Range	Shipping Weight	Cube	COM Yardage
<b>MID BACK</b>	Urethane	24.5	26	36.75	17.75	26.75	19.5	19.75	4	43	18	2.3
	Narrow Width Adjustable	25	26	36.75	17.75	24.25-30.25	19.5	19.75	4	43	18	2.3
	Wood & Urethane	24.5	26	36.75	17.75	26.75	19.5	19.75	4	43	18	2.3
	Wood & Upholstered	24.5	26	36.75	17.75	26.75	19.5	19.75	4	43	18	2.8
	Completely Upholstered	24.5	26	36.75	17.75	26.75	19.5	19.75	4	43	18	3.0
Wide Width	Armless	19.5	26	36.75	17.75	-	-	19.75	4	41	18	2.3
	Urethane	26	26	36.75	17.75	26.75	21	19.75	4	45	18	2.3
	Adjustable	26.5	26	36.75	17.75	24.25-30.25	21	19.75	4	45	18	2.3
	Wood & Urethane	26	26	36.75	17.75	26.75	21	19.75	4	45	18	2.3
	Wood & Upholstered	26	26	36.75	17.75	26.75	21	19.75	4	45	18	2.8
<b>HIGH BACK</b>	Completely Upholstered	26	26	36.75	17.75	26.75	21	19.75	4	45	18	3.0
	Armless	21	26	36.75	17.75	-	-	19.75	4	43	18	2.3
	Narrow Width Urethane	24.5	26	43	17.75	26.75	19.5	19.75	4	46	20	2.5
	Narrow Width Adjustable	25	26	43	17.75	24.25-30.25	19.5	19.75	4	46	20	2.5
	Narrow Width Wood & Urethane	24.5	26	43	17.75	26.75	19.5	19.75	4	46	20	2.5
Wide Width	Wood & Upholstered	24.5	26	43	17.75	26.75	19.5	19.75	4	46	20	3.0
	Completely Upholstered	24.5	26	43	17.75	26.75	19.5	19.75	4	46	20	3.2
	Urethane	26	26	43	17.75	26.75	21	19.75	4	48	20	2.5
	Adjustable	26.5	26	43	17.75	24.25-30.25	21	19.75	4	48	20	2.5
	Wood & Urethane	26	26	43	17.75	26.75	21	19.75	4	48	20	2.5
<b>ARM CHAIR</b>	Wood & Upholstered	26	26	43	17.75	26.75	21	19.75	4	48	20	3.0
	Completely Upholstered	26	26	43	17.75	26.75	21	19.75	4	48	20	3.2
	Urethane	27.25	27	36	18.25	26	18.75	18	-	23	18	1.7

Height measurements are taken with the pneumatic lift (and adjustable arm and back when applicable) in the lowest position. All dimensions are in inches and approximate and are subject to change without notice. Contact Customer Service if dimensions are critical.

# CADENCE | MID BACK

DESCRIPTION/MODEL	WOOD FINISH	COM		COL		FABRIC GRADES			LEATHER		
		1	2	3	4	5	6	7	8	9	
	URETHANE ARMS										
	CAD1-MW11B		1493	1569	1638	1844	1955	2054	2211	2584	2817
	CAD1-MN11B										
	CAD1-MW21B										
	CAD1-MN21B										
	CAD1-MW11W	Cherry, Maple, Walnut, Medium Anigre	1774	1852	1913	2122	2238	2321	2489	2864	3087
	CAD1-MN11W	Cherry, Maple, Walnut, Medium Anigre									
	CAD1-MW21W	Cherry, Maple, Walnut, Medium Anigre									
CAD1-MN21W	Cherry, Maple, Walnut, Medium Anigre										

	ADJUSTABLE ARMS										
	CAD1-MW15B		1437	1509	1572	1778	1883	1965	2130	2485	2721
	CAD1-MN15B										
	CAD1-MW25B										
	CAD1-MN25B										
	CAD1-MW15W	Cherry, Maple, Walnut, Medium Anigre	1717	1790	1854	2056	2163	2247	2410	2767	2992
	CAD1-MN15W	Cherry, Maple, Walnut, Medium Anigre									
	CAD1-MW25W	Cherry, Maple, Walnut, Medium Anigre									
CAD1-MN25W	Cherry, Maple, Walnut, Medium Anigre										

### ORDERING NOTES:

**CAD-MW25 CAD-MN25** versions are available with optional seat slider mechanism at an upcharge of **\$80 list**. Specifying seat slider option may add additional lead time to production schedules. Please contact Customer Service for more information.

	WOOD AND URETHANE ARMS										
	CAD1-MW12B		1588	1666	1792	1960	2079	2166	2348	2742	2970
	CAD1-MN12B										
	CAD1-MW22B										
	CAD1-MN22B										
	CAD1-MW12W	Cherry, Maple, Walnut, Medium Anigre	1866	1946	2018	2241	2357	2451	2632	3024	3239
	CAD1-MN12W	Cherry, Maple, Walnut, Medium Anigre									
	CAD1-MW22W	Cherry, Maple, Walnut, Medium Anigre									
CAD1-MN22W	Cherry, Maple, Walnut, Medium Anigre										



**ORDERING NOTES:** Value Mechanism Option - for a price reduction of \$100 per chair, we offer a lower-function mechanism option, which includes full swivel and rearward tilt capability, tilt tension control, and gas lift height adjustment activator. For jury base version of this chair, please add a 'J' for the base style at the end of the model number and **add \$77** to the list price. Cadence arms and bases are available in Cherry, Maple, Walnut and Medium Anigre finishes. Please see page 335 for finish color selection and clearly mark on your purchase order. CAL 133 and Moisture Barrier options are available for an upcharge of **\$64 list per yard**.



### PRODUCT CODE KEY

Line	Series	Back Style	Back Adjustment	Arm Style	Base Style
CAD	1	MW	1	1	W
Cadence	Management Seating	Mid Back Wide	Fixed Back	Urethane	Wood
		MN	2	2	B
		Mid Back Narrow	Adjustable Back	Wood And Urethane	Black Nylon
				5	J
				Adjustable	Jury Base

# CADENCE | MID BACK

DESCRIPTION/MODEL	WOOD FINISH	COM		COL			FABRIC GRADES			LEATHER	
		1	2	3	4	5	6	7	8	9	
	WOOD AND UPHOLSTERED ARM										
	CAD1-MW13B		1792	1871	2002	2166	2285	2377	2557	2949	3239
	CAD1-MN13B										
	CAD1-MW23B										
	CAD1-MN23B										
	CAD1-MW13W	Cherry, Maple, Walnut, Medium Anigre	2073	2157	2227	2451	2564	2658	2838	3234	3512
	CAD1-MN13W	Cherry, Maple, Walnut, Medium Anigre									
CAD1-MW23W	Cherry, Maple, Walnut, Medium Anigre										
CAD1-MN23W	Cherry, Maple, Walnut, Medium Anigre										
	COMPLETELY UPHOLSTERED										
	CAD1-MW14B		1744	1822	1951	2114	2232	2324	2505	2898	3219
	CAD1-MN14B										
	CAD1-MW24B										
	CAD1-MN24B										
	CAD1-MW14W	Cherry, Maple, Walnut, Medium Anigre	2020	2104	2173	2397	2515	2607	2788	3182	3490
	CAD1-MN14W	Cherry, Maple, Walnut, Medium Anigre									
CAD1-MW24W	Cherry, Maple, Walnut, Medium Anigre										
CAD1-MN24W	Cherry, Maple, Walnut, Medium Anigre										
	ARMLESS										
	CAD1-MW10B		1338	1414	1480	1688	1798	1896	2055	2427	2685
	CAD1-MN10B										
	CAD1-MW20B										
	CAD1-MN20B										
	CAD1-MW10W	Cherry, Maple, Walnut, Medium Anigre	1618	1693	1760	1968	2083	2164	2334	2707	2936
	CAD1-MN10W	Cherry, Maple, Walnut, Medium Anigre									
CAD1-MW20W	Cherry, Maple, Walnut, Medium Anigre										
CAD1-MN20W	Cherry, Maple, Walnut, Medium Anigre										

## ORDERING NOTES

Value Mechanism Option - for a price reduction of \$100 per chair, we offer a lower-function mechanism option, which includes full swivel and rearward tilt capability, tilt tension control, and gas lift height adjustment activator.

For jury base version of this chair, please add a 'J' for the base style at the end of the model number and **add \$77** to the list price.

Cadence arms and bases are available in Cherry, Maple, Walnut and Medium Anigre finishes. Please see page 335 for finish color selection and clearly mark on your purchase order.

CAL 133 and Moisture Barrier options are available for an upcharge of **\$64 list per yard**.



## PRODUCT CODE KEY

Line	Series	Back Style	Back Adjustment	Arm Style	Base Style
CAD	1	MW	1	0	W
Cadence	Management Seating	Mid Back Wide	Fixed Back	Armless	Wood
		MN	2	3	B
		Mid Back Narrow	Adjustable Back	Wood And Upholstered	Black Nylon
				4	J
				Completely Upholstered	Jury Base

DESCRIPTION/MODEL	WOOD FINISH	COM		COL		FABRIC GRADES		LEATHER				
		1	2	3	4	5	6	7	8	9		
	URETHANE ARMS											
	CAD1-HW11B		1622	1723	1796	2019	2157	2249	2451	2874	3127	
	CAD1-HN11B											
	CAD1-HW21B											
	CAD1-HN21B											
	CAD1-HW11W		Cherry, Maple, Walnut, Medium Anigre	1907	2002	2079	2302	2436	2530	2732	3155	3396
	CAD1-HN11W		Cherry, Maple, Walnut, Medium Anigre									
CAD1-HW21W		Cherry, Maple, Walnut, Medium Anigre										
CAD1-HN21W		Cherry, Maple, Walnut, Anigre										

	ADJUSTABLE ARMS											
	CAD1-HW15B		1559	1654	1729	1946	2072	2164	2357	2767	3022	
	CAD1-HN15B											
	CAD1-HW25B											
	CAD1-HN25B											
	CAD1-HW15W		Cherry, Maple, Walnut, Medium Anigre	1841	1935	2010	2227	2355	2448	2639	3043	3290
	CAD1-HN15W		Cherry, Maple, Walnut, Medium Anigre									
CAD1-HW25W		Cherry, Maple, Walnut, Medium Anigre										
CAD1-HN25W		Cherry, Maple, Walnut, Medium Anigre										

**ORDERING NOTES:** CAD-MW25 versions are available with optional seat slider mechanism at an upcharge of **\$80 list**. Specifying seat slider option may add additional lead time to production schedules. Please contact Customer Service for more information.

	WOOD AND URETHANE ARM											
	CAD1-HW12B		1724	1832	1909	2154	2293	2390	2602	3053	3295	
	CAD1-HN12B											
	CAD1-HW22B											
	CAD1-HN22B											
	CAD1-HW12W		Cherry, Maple, Walnut, Medium Anigre	2006	2108	2192	2432	2569	2669	2882	3333	3565
	CAD1-HN12W		Cherry, Maple, Walnut, Medium Anigre									
CAD1-HW22W		Cherry, Maple, Walnut, Medium Anigre										
CAD1-HN22W		Cherry, Maple, Walnut, Medium Anigre										

**ORDERING NOTES**

Value Mechanism Option - for a price reduction of \$100 per chair, we offer a lower-function mechanism option, which includes full swivel and rearward tilt capability, tilt tension control, and gas lift height adjustment activator.

For jury base version of this chair, please add a 'J' for the base style at the end of the model number and **add \$77** to the list price.

Cadence arms and bases are available in Cherry, Maple, Walnut and Medium Anigre finishes. Please see page 335 for finish color selection and clearly mark on your purchase order.



CAL 133 and Moisture Barrier options are available for an upcharge of **\$64 list per yard**.



**PRODUCT CODE KEY**

Line	Series	Back Style	Back Adjustment	Arm Style	Base Style
CAD	1	HW	1	1	W
Cadence	Management Seating	High Back Wide	Fixed Back	Urethane	Wood
		HN	2	2	B
		High Back Narrow	Adjustable Back	Wood And Urethane	Black Nylon
				5	J
				Adjustable	Jury Base

# CADENCE | HIGH BACK

DESCRIPTION/MODEL	WOOD FINISH	COM		COL		FABRIC GRADES			LEATHER		
		1	2	3	4	5	6	7	8	9	
	WOOD AND UPHOLSTERED ARM										
	CAD1-HW13B		1932	2035	2114	2357	2500	2595	2808	3260	3565
	CAD1-HN13B										
	CAD1-HW23B										
	CAD1-HN23B										
	CAD1-HW13W	Cherry, Maple, Walnut, Medium Anigre	2212	2316	2397	2639	2778	2880	3090	3542	3840
	CAD1-HN13W	Cherry, Maple, Walnut, Medium Anigre									
CAD1-HW23W	Cherry, Maple, Walnut, Medium Anigre										
CAD1-HN23W	Cherry, Maple, Walnut, Medium Anigre										
	COMPLETELY UPHOLSTERED ARM										
	CAD1-HW14B		1882	1985	2062	2304	2448	2543	2757	3208	3546
	CAD1-HN14B										
	CAD1-HW24B										
	CAD1-HN24B										
	CAD1-HW14W	Cherry, Maple, Walnut, Medium Anigre	2161	2265	2346	2587	2727	2828	3038	3490	3816
	CAD1-HN14W	Cherry, Maple, Walnut, Medium Anigre									
CAD1-HW24W	Cherry, Maple, Walnut, Medium Anigre										
CAD1-HN24W	Cherry, Maple, Walnut, Medium Anigre										

## ORDERING NOTES

Value Mechanism Option - for a price reduction of \$100 per chair, we offer a lower-function mechanism option, which includes full swivel and rearward tilt capability, tilt tension control, and gas lift height adjustment activator.

For jury base version of this chair, please add a 'J' for the base style at the end of the model number and add \$77 to the list price.

Cadence arms and bases are available in Cherry, Maple, Walnut and Medium Anigre finishes. Please see page 335 for finish color selection and clearly mark on your purchase order.

CAL 133 and Moisture Barrier options are available for an upcharge of **\$64 list per yard**.



## PRODUCT CODE KEY

Line	Series	Back Style	Back Adjustment	Arm Style	Base Style
CAD	1	HW	1	3	W
Cadence	Management Seating	High Back Wide	Fixed Back	Wood and Upholstered	Wood
	2	HN	2	4	B
	Guest Seating	High Back Narrow	Adjustable Back	Completely Upholstered	Black Nylon
		A			J
		Arm Chair			Jury Base



## GUEST SEATING

65	Addison
68	Blake
71	Dorso
74	Bali
76	Kita
78	Spence
80	Cadence
82	Faeron Wood
88	Faeron Metal

# ADDISON | ENVIRONMENTAL SUMMARY

## LEED CI CREDITS



MATERIAL CONTENT:

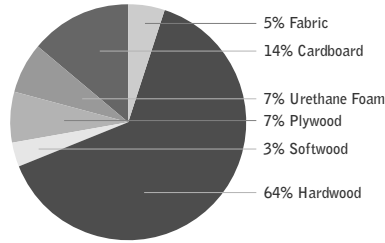

PRE-CONSUMER RECYCLED CONTENT = .69%

POST-CONSUMER RECYCLED CONTENT = 13.10%

Up to 13.79% of this Addison product is recyclable at the end of its useful life.

### CONTRIBUTES TO

CREDIT 2.1 - 2.2	Construction Waste Management	1-2 point(s)
CREDIT 3.3	Resource Reuse	1 point
CREDIT 4.1	Recycled Content	1 point
CREDIT 4.5	Low Emitting Materials, Systems & Seating	1 point
CREDIT 5.1	Regional Materials*	1 point
CREDIT 7	Certified Wood (MUST BE REQUESTED)	1 point(s)

## level® CERTIFICATION, AIR EMISSIONS AND FSC® CERTIFICATION



### level® CERTIFICATION

BIFMA's e3 Furniture Sustainability Standard is a voluntary, multi-attribute standard that measures the degree of sustainability of furniture. This standard evaluates product and company environmental attributes and compliance systems in a wide range of elements which include Materials, Energy & Atmosphere, Human & Ecosystem Health and Social Responsibility. Addison products have earned level®, BIFMA's sustainability certification program for furniture, certification through third-party verification against the e3 standard.

### AIR-EMISSIONS

All Addison products are supplied with air-emissions certified. Contact customer service for information.





### FSC®

In 2005, Krug received Forest Stewardship Council® (FSC®) Chain-of-Custody certification for our manufacturing facilities. The FSC® Chain-of-Custody tracks certified wood from seedling to final sale. It verifies that the material for our FSC® certified products only come from well-managed, FSC®-certified forests and other controlled sources. FSC® is dedicated to the promotion of responsible forest management worldwide helping to take care of forests for future generations. Addison and other Krug products can be specified with FSC® Certification. Contact customer service for further information, pricing and lead times.



Architects, designers, and building professionals can specify FSC®-certified products in order to achieve a point from the U.S. Green Building Council's Leadership in Energy and Environmental Design (LEED) Rating System.

DESCRIPTION/MODEL	WOOD FINISH	COM		COL			FABRIC GRADES			LEATHER	
		1	2	3	4	5	6	7	8	9	
	OPEN ARM, OPEN BACK ADD-2-A-1	Cherry, Oak, Walnut, Beech, Medium Anigre	937	961	988	1039	1093	1143	1198	1249	1355
	Maple		1011	1036	1063	1116	1166	1218	1270	1320	1425
	OPEN ARM, FULLY UPHOLSTERED BACK ADD-2-A-2	Cherry, Oak, Walnut, Beech, Medium Anigre	985	1032	1080	1166	1254	1346	1434	1526	1703
	Maple		1052	1095	1141	1231	1319	1411	1501	1589	1771
	OPEN ARM, UPPER UPHOLSTERED BACK ADD-2-A-3	Cherry, Oak, Walnut, Beech, Medium Anigre	971	1003	1037	1106	1171	1239	1306	1372	1508
	Maple		1043	1080	1110	1178	1245	1311	1377	1446	1581

### ORDERING NOTES:

Addison Guest Chairs are available with a removable upholstered seat cover at an upcharge of **\$80 list** per chair. Chair frames are available in Cherry, Oak, Walnut, Beech, Maple and Medium Anigre finishes. Please see page 335 for finish color selection and clearly mark on your purchase order. Ganging is optional on all wood arm and side chairs at an upcharge of **\$80 list** per chair. Please specify at time of order. CAL 133 and Moisture Barrier options are available for an upcharge of **\$64 list per yard**.

### DIMENSIONS & COM REQUIREMENTS

	Overall Width	Overall Depth	Overall Height	Seat Height	Height of Arms from Floor	Width between Arms	Seat Depth	Shipping Weight	Cube	COM Yardage
<b>ADD-2-A-1</b>	23.5	24.5	33	18.5	26	20	19	28	13.7	0.7
<b>ADD-2-A-2</b>	23.5	24.5	33	18.5	26	20	19	28	13.7	1.2
<b>ADD-2-A-3</b>	23.5	24.5	33	18.5	26	20	19	29	13.7	0.9
<b>ADD-2-A-4</b>	23.5	24.5	33	18.5	26	20	19	29	13.7	0.7
<b>ADD-2-A-5</b>	23.5	24.5	33	18.5	26	20	19	29	13.7	0.7

### ORDERING PROCEDURE

To order please specify the following:



1. Krug product model number
2. Select a finish for the chair frame
3. Select a textile or leather

Dimensions are in inches and approximate. Contact Customer Service if dimensions are critical.

### PRODUCT CODE KEY

Line	Series	Chair Type	Chair Style
<input type="text" value="ADD"/>	<input type="text" value="2"/>	<input type="text" value="A"/>	<input type="text" value="1"/>
Addison	Guest Seating	Arm Chair	Open Arm, Open Back
			<input type="text" value="2"/>
			Open Arm, Fully Upholstered Back
			<input type="text" value="3"/>
			Open Arm, Upper Upholstered Back
			<input type="text" value="4"/>
			Open Arm, Horizontal Slat Back
			<input type="text" value="5"/>
			Open Arm, Solid Wood Back

# ADDISON

DESCRIPTION/MODEL	WOOD FINISH	COM		COL			FABRIC GRADES			LEATHER	
		1	2	3	4	5	6	7	8	9	
	OPEN ARM, HORIZONTAL SLAT BACK ADD-2-A-4	Cherry, Oak, Walnut, Beech, Medium Anigre	955	979	1006	1058	1109	1162	1213	1266	1371
	Maple	1018	1044	1068	1138	1173	1228	1281	1332	1434	
	OPEN ARM, SOLID WOOD BACK ADD-2-A-5	Cherry, Oak, Walnut, Beech, Medium Anigre	960	987	1015	1065	1118	1170	1223	1273	1377
	Maple	1029	1053	1081	1131	1183	1236	1286	1340	1445	

## ORDERING NOTES:

Addison Guest Chairs are available with a removable upholstered seat cover at an upcharge of **\$80 list** per chair. Chair frames are available in Cherry, Oak, Walnut, Beech, Maple and Medium Anigre finishes. Please see page 335 for finish color selection and clearly mark on your purchase order. Ganging is optional on all wood arm and side chairs at an upcharge of **\$80 list** per chair. Please specify at time of order. CAL 133 and Moisture Barrier options are available for an upcharge of **\$64 list per yard**.

## DIMENSIONS & COM REQUIREMENTS

	Overall Width	Overall Depth	Overall Height	Seat Height	Height of Arms from Floor	Width between Arms	Seat Depth	Shipping Weight	Cube	COM Yardage
<b>ADD-2-A-1</b>	23.5	24.5	33	18.5	26	20	19	28	13.7	0.7
<b>ADD-2-A-2</b>	23.5	24.5	33	18.5	26	20	19	28	13.7	1.2
<b>ADD-2-A-3</b>	23.5	24.5	33	18.5	26	20	19	29	13.7	0.9
<b>ADD-2-A-4</b>	23.5	24.5	33	18.5	26	20	19	29	13.7	0.7
<b>ADD-2-A-5</b>	23.5	24.5	33	18.5	26	20	19	29	13.7	0.7

## ORDERING PROCEDURE

To order please specify the following:

1. Krug product model number
2. Select a finish for the chair frame
3. Select a textile or leather

Dimensions are in inches and approximate. Contact Customer Service if dimensions are critical.

## PRODUCT CODE KEY

Line	Series	Chair Type	Chair Style
<input type="text" value="ADD"/>	<input type="text" value="2"/>	<input type="text" value="A"/>	<input type="text" value="1"/>
Addison	Guest Seating	Arm Chair	Open Arm, Open Back
			<input type="text" value="2"/>
			Open Arm, Fully Upholstered Back
			<input type="text" value="3"/>
			Open Arm, Upper Upholstered Back
			<input type="text" value="4"/>
			Open Arm, Horizontal Slat Back
			<input type="text" value="5"/>
			Open Arm, Solid Wood Back

**LEED CI CREDITS**



MATERIAL CONTENT:

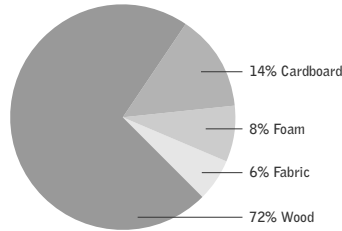

PRE-CONSUMER  
RECYCLED CONTENT = 14%

POST-CONSUMER  
RECYCLED CONTENT = 86%

Up to 86% of this Blake product is recyclable at the end of its useful life.

CONTRIBUTES TO

CREDIT 2.1 - 2.2	Construction Waste Management	1-2 point(s)
CREDIT 3.3	Resource Reuse	1 point
CREDIT 4.1	Recycled Content	1 point
CREDIT 4.2	Recycled Content	1 point
CREDIT 4.5	Low Emitting Materials, Systems & Seating	1 point
CREDIT 5.1	Regional Materials*	1 point

\*This credit is only applicable if in total 20% of the combined value of the procurement of construction materials and in the furniture are manufactured within a radius of 500 miles. This credit will apply if the installation of the finished product occurs within 500 miles of Kitchener, Ontario.

**level® CERTIFICATION, AIR EMISSIONS AND FSC® CERTIFICATION**



**level® CERTIFICATION**

BIFMA's e3 Furniture Sustainability Standard is a voluntary, multi-attribute standard that measures the degree of sustainability of furniture. This standard evaluates product and company environmental attributes and compliance systems in a wide range of elements which include Materials, Energy & Atmosphere, Human & Ecosystem Health and Social Responsibility. Blake products have earned level®, BIFMA's sustainability certification program for furniture, certification through third-party verification against the e3 standard.

**AIR-EMISSIONS**

All Blake products are supplied with air-emissions certified. Contact customer service for information.





**FSC®**

In 2005, Krug received Forest Stewardship Council® (FSC®) Chain-of-Custody certification for our manufacturing facilities. The FSC® Chain-of-Custody tracks certified wood from seedling to final sale. It verifies that the material for our FSC® certified products only come from well-managed, FSC®-certified forests and other controlled sources. FSC® is dedicated to the promotion of responsible forest management worldwide helping to take care of forests for future generations. Blake and other Krug products can be specified with FSC® Certification. Contact customer service for further information, pricing and lead times.

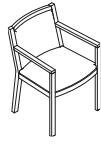
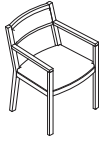

Architects, designers, and building professionals can specify FSC®-certified products in order to achieve a point from the U.S. Green Building Council's Leadership in Energy and Environmental Design (LEED) Rating System.

# BLAKE

DESCRIPTION/MODEL	WOOD FINISH	COM		COL			FABRIC GRADES			LEATHER	
		1	2	3	4	5	6	7	8	9	
	OPEN ARM, OPEN BACK BLA-2-A-1	Cherry, Oak, Walnut, Beech, Medium Anigre	854	882	909	959	1014	1064	1117	1169	1271
	Maple		921	946	974	1026	1080	1128	1181	1232	1338
	OPEN ARM, FULLY UPHOLSTERED BACK BLA-2-A-2	Cherry, Oak, Walnut, Beech, Medium Anigre	896	941	987	1080	1166	1254	1346	1434	1615
	Maple		960	1008	1053	1141	1231	1319	1411	1501	1678
	OPEN ARM, UPPER UPHOLSTERED BACK BLA-2-A-3	Cherry, Oak, Walnut, Beech, Medium Anigre	888	922	957	1022	1090	1157	1224	1290	1423
	Maple		955	987	1021	1089	1155	1223	1289	1356	1491
	OPEN ARM, VERTICAL SLAT BACK BLA-2-A-4	Cherry, Oak, Walnut, Beech, Medium Anigre	927	954	978	1031	1083	1135	1187	1239	1342
	Maple		985	1014	1037	1090	1141	1194	1246	1298	1403

## ORDERING NOTES

Blake Guest Chairs are available with a removable upholstered seat cover at an upcharge of **\$80 list** per chair. Chair frames are available in Cherry, Oak, Walnut, Beech, Maple and Medium Anigre finishes. Please see page 335 for finish color selection and clearly mark on your purchase order. CAL 133 and Moisture Barrier options are available for an upcharge of **\$64 list per yard**.

## DIMENSIONS & COM REQUIREMENTS

	Overall Width	Overall Depth	Overall Height	Seat Height	Height of Arms from Floor	Width between Arms	Seat Depth	Shipping Weight	Cube	COM Yardage
<b>BLA-2-A-1</b>	23	24	32	18.5	26	19.75	19	25	12.5	0.7
<b>BLA-2-A-2</b>	23	24	32	18.5	26	19.75	19	29	12.5	1.2
<b>BLA-2-A-3</b>	23	24	32	18.5	26	19.75	19	27	12.5	0.9
<b>BLA-2-A-4</b>	23	24	32	18.5	26	19.75	19	25	12.5	0.7
<b>BLA-2-A-5</b>	23	24	32	18.5	26	19.75	19	26	12.5	1.0
<b>BLA-2-A-6</b>	23	24	32	18.5	26	19.75	19	39	12.5	1.7
<b>BLA-2-A-7</b>	23	24	32	18.5	26	19.75	19	36	12.5	1.8

## ORDERING PROCEDURE



To order please specify the following:

1. Krug product model number
2. Select a finish for the chair frame
3. Select a textile or leather

Dimensions are in inches and approximate. Contact Customer Service if dimensions are critical.

## PRODUCT CODE KEY

Line	Series	Chair Type	Chair Style
<input type="text" value="BLA"/>	<input type="text" value="2"/>	<input type="text" value="A"/>	<input type="text" value="1"/>
Blake	Guest Seating	Arm Chair	Open Arm, Open Back
			<input type="text" value="2"/>
			Open Arm, Fully Upholstered Back
			<input type="text" value="3"/>
			Open Arm, Upper Upholstered Back
			<input type="text" value="4"/>
			Open Arm, Vertical Slat Back
			<input type="text" value="5"/>
			Open Arm, Lower Upholstered Back
			<input type="text" value="6"/>
			Closed Arm, Lower Upholstered Back
			<input type="text" value="7"/>
			Closed Arm, Fully Upholstered Back

DESCRIPTION/MODEL	WOOD FINISH	COM		COL			FABRIC GRADES			LEATHER	
		1	2	3	4	5	6	7	8	9	
	OPEN ARM, LOWER UPHOLSTERED BACK BLA-2-A-5	Cherry, Oak, Walnut, Beech, Medium Anigre	924	960	999	1073	1147	1224	1298	1373	1524
	Maple	992	1032	1067	1142	1218	1294	1370	1445	1592	
	CLOSED ARM, LOWER UPHOLSTERED BACK BLA-2-A-6	Cherry, Oak, Walnut, Beech, Medium Anigre	960	1026	1089	1215	1342	1467	1594	1724	1977
	Maple	1034	1096	1162	1289	1416	1540	1669	1796	2053	
	CLOSED ARM, FULLY UPHOLSTERED BACK BLA-2-A-7	Cherry, Oak, Walnut, Beech, Medium Anigre	985	1053	1120	1253	1390	1526	1662	1795	2064
	Maple	1052	1118	1185	1317	1455	1589	1727	1860	2131	

### ORDERING NOTES

Blake Guest Chairs are available with a removable upholstered seat cover at an upcharge of **\$80 list** per chair.

Chair frames are available in Cherry, Oak, Walnut, Beech, Maple and Medium Anigre finishes. Please see page 335 for finish color selection and clearly mark on your purchase order. CAL 133 and Moisture Barrier options are available for an upcharge of **\$64 list per yard**.

### DIMENSIONS & COM REQUIREMENTS

	Overall Width	Overall Depth	Overall Height	Seat Height	Height of Arms from Floor	Width between Arms	Seat Depth	Shipping Weight	Cube	COM Yardage
<b>BLA-2-A-1</b>	23	24	32	18.5	26	19.75	19	25	12.5	0.7
<b>BLA-2-A-2</b>	23	24	32	18.5	26	19.75	19	29	12.5	1.2
<b>BLA-2-A-3</b>	23	24	32	18.5	26	19.75	19	27	12.5	0.9
<b>BLA-2-A-4</b>	23	24	32	18.5	26	19.75	19	25	12.5	0.7
<b>BLA-2-A-5</b>	23	24	32	18.5	26	19.75	19	26	12.5	1.0
<b>BLA-2-A-6</b>	23	24	32	18.5	26	19.75	19	39	12.5	1.7
<b>BLA-2-A-7</b>	23	24	32	18.5	26	19.75	19	36	12.5	1.8

### ORDERING PROCEDURE

To order please specify the following:

1. Krug product model number
2. Select a finish for the chair frame
3. Select a textile or leather

Dimensions are in inches and approximate. Contact Customer Service if dimensions are critical.

### PRODUCT CODE KEY

Line	Series	Chair Type	Chair Style
<input type="text" value="BLA"/>	<input type="text" value="2"/>	<input type="text" value="A"/>	<input type="text" value="1"/>
Blake	Guest Seating	Arm Chair	Open Arm, Open Back
			<input type="text" value="2"/>
			Open Arm, Fully Upholstered Back
			<input type="text" value="3"/>
			Open Arm, Upper Upholstered Back
			<input type="text" value="4"/>
			Open Arm, Vertical Slat Back
			<input type="text" value="5"/>
			Open Arm, Lower Upholstered Back
			<input type="text" value="6"/>
			Closed Arm, Lower Upholstered Back
			<input type="text" value="7"/>
			Closed Arm, Fully Upholstered Back

# DORSO GUEST | ENVIRONMENTAL SUMMARY

## LEED CI CREDITS



MATERIAL CONTENT:

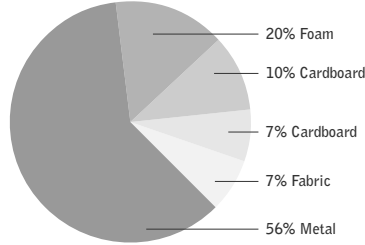

PRE-CONSUMER  
RECYCLED CONTENT = 9.82%

POST-CONSUMER  
RECYCLED CONTENT = 19.98%

Up to 73.17% of this Dorso product is recyclable at the end of its useful life.

### CONTRIBUTES TO

CREDIT 2.1 - 2.2	Construction Waste Management	1-2 point(s)
CREDIT 3.3	Resource Reuse	1 point
CREDIT 4.1	Recycled Content	1 point
CREDIT 4.2	Recycled Content	1 point
CREDIT 4.5	Low Emitting Materials, Systems & Seating	1 point
CREDIT 5.1	Regional Materials*	1 point

\*This credit is only applicable if in total 20% of the combined value of the procurement of construction materials and in the furniture are manufactured within a radius of 500 miles. This credit will apply if the installation of the finished product occurs within 500 miles of Kitchener, Ontario.

## level® CERTIFICATION, AIR EMISSIONS AND FSC® CERTIFICATION



### level® CERTIFICATION

BIFMA's e3 Furniture Sustainability Standard is a voluntary, multi-attribute standard that measures the degree of sustainability of furniture. This standard evaluates product and company environmental attributes and compliance systems in a wide range of elements which include Materials, Energy & Atmosphere, Human & Ecosystem Health and Social Responsibility. Dorso products have earned level®, BIFMA's sustainability certification program for furniture, certification through third-party verification against the e3 standard.













### AIR EMISSIONS

All Dorso products are supplied air-emissions certified. Contact customer service for information.





# DORSO S-LINE | GUEST

DESCRIPTION/MODEL	COM		COL	FABRIC GRADES			LEATHER		
	1	2	3	4	5	6	7	8	9
	4 Leg Base, armless with Silver Metallic base								
	DOS2-10	1058 1108	1163	1231	1316	1423	1538	1683	1837
	4 Leg Base, armless with Polished Chrome base								
	DOC2-10	1163 1213	1260	1338	1423	1521	1644	1779	1944
	4 Leg Base, fixed arms with Silver Metallic base								
	DOS2-11	1203 1260	1307	1376	1463	1568	1692	1827	1980
	4 Leg Base, fixed arms with Polished Chrome base								
	DOC2-11	1330 1376	1433	1499	1588	1692	1808	1954	2107
	4 Leg Base with Casters, armless with Silver Metallic base								
	DOS2-20	1146 1193 1251	1251	1316	1404	1509	1623	1771	1924
	4 Leg Base with Casters, armless with Polished Chrome base,								
	DOC2-20	1193 1251 1298	1298	1363	1452	1557	1683	1818	1971
	4 Leg Base with Casters, fixed arms and Silver Metallic base								
	DOS2-21	1289 1347 1396	1396	1463	1548	1654	1779	1913	2069
	4 Leg Base with Casters, fixed arms and Polished Chrome base								
	DOC2-21	1414 1463 1521	1521	1588	1673	1779	1894	2037	2194
	Cantilever Base, armless with Silver Metallic base								
	DOS2-30	1172 1222	1268	1347	1433	1530	1654	1789	1954
	Cantilever Base, armless with Polished Chrome base								
	DOC2-30	1282 1338	1386	1452	1538	1644	1771	1907	2058
	Cantilever Base, fixed arms with Silver Metallic base								
	DOS2-31	1463 1521 1568	1568	1638	1723	1827	1954	2086	2240
	Cantilever Base, fixed arms with Polished Chrome base								
	DOC2-31	1521 1579 1623	1623	1692	1779	1885	2011	2145	2299

## ORDERING NOTES

Dorso Chairs are available with a removable upholstered seat cover at an upcharge of **\$80 list** per chair.  
 CAL 133 and Moisture Barrier options are available for an upcharge of **\$64 list per yard**. See page 333 for more information.

## ORDERING PROCEDURE

To order please specify the following:







1. Krug product model number
2. Select a textile or leather

Dimensions are in inches and approximate.  
 Contact Customer Service if dimensions are critical.

## PRODUCT CODE KEY

Line	Series	Base	Arm Style
<input type="text" value="DOS"/>	<input type="text" value="2"/>	<input type="text" value="1"/>	<input type="text" value="0"/>
Dorso S-Line (Silver Metallic)	Guest Seating	Four Leg	Armless
<input type="text" value="DOC"/>		<input type="text" value="2"/>	<input type="text" value="1"/>
Dorso S-Line (Polished Chrome)		Four Leg with Casters	Fixed Cantilever
<input type="text" value="DON"/>		<input type="text" value="3"/>	
Dorso N-Line (Silver Metallic)		Cantilever	

# DORSO N-LINE | GUEST

DESCRIPTION/MODEL	COM		COL	FABRIC GRADES			LEATHER		
	1	2	3	4	5	6	7	8	9
 4 Leg Base, armless with Silver Metallic base DON2-10	914	961	1009	1089	1172	1268	1396	1530	1692
 4 Leg Base, fixed arms with Silver Metallic base DON2-11	1019	1074	1124	1193	1282	1386	1509	1644	1798
 4 Leg Base with Casters, armless with Silver Metallic base DON2-20	1002	1048	1096	1172	1260	1357	1482	1617	1779
 4 Leg Base with Casters, fixed arms and Silver Metallic base DON2-21	1109	1161	1213	1282	1363	1473	1594	1730	1885
 Cantilever Base, armless with Silver Metallic base DON2-30	1019	1074	1124	1193	1282	1386	1509	1644	1798
 Cantilever Base, fixed arms with Silver Metallic base DON2-31	1203	1260	1307	1376	1463	1568	1692	1827	1980

## ORDERING NOTES

Dorso Chairs are available with a removable upholstered seat cover at an upcharge of **\$80 list** per chair.  
 CAL 133 and Moisture Barrier options are available for an upcharge of **\$64 list per yard**. See page 333 for more information.

## DIMENSIONS & COM REQUIREMENTS

		Overall Width	Overall Depth	Seat Height	Height of Arms from Floor	Width between Arms	Seat Depth	Height Range	Shipping Weight	Cube	COM Yardage
S-LINE/4LEG	Armless	20.75	25.50	18.5	27.5	19.5	19.5	36	32	14	1.3
	Fixed	24.5	25.50	18.5	27.5	19.5	19.5	36	37	14	1.3
S-LINE/4LEG with Casters	Armless	20.75	24.75	18.5	27.5	19.5	19.5	36	33	14	1.3
	Fixed	24.5	24.75	18.5	27.5	19.5	19.5	36	38	14	1.3
S-LINE/ Cantilever Base	Armless	20.75	24.75	18.5	27.5	19.5	19.5	36	39	14	1.3
	Fixed	24.5	24.75	18.5	27.5	19.5	19.5	36	44	14	1.3
N-LINE/4LEG	Armless	20.75	25.50	18.5	27.5	19.5	19.5	34.75	31	14	1.3
	Fixed	24.5	25.50	18.5	27.5	19.5	19.5	34.75	36	14	1.3
N-LINE/4LEG with Casters	Armless	20.75	24.75	18.5	27.5	19.5	19.5	34.75	32	14	1.3
	Fixed	24.5	24.75	18.5	27.5	19.5	19.5	34.75	37	14	1.3
N-LINE/ Cantilever Base	Armless	20.75	24.75	18.5	27.5	19.5	19.5	34.75	38	14	1.3
	Fixed	24.5	24.75	18.5	27.5	19.5	19.5	34.75	43	14	1.3

**LEED CI CREDITS**



MATERIAL CONTENT:

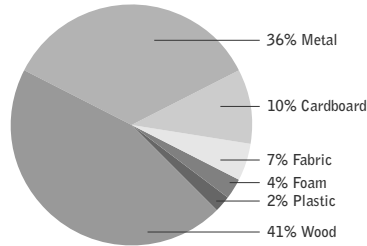

PRE-CONSUMER RECYCLED CONTENT = 4.68%

POST-CONSUMER RECYCLED CONTENT = 16.42%

Up to 74.19% of this Bali product is recyclable at the end of its useful life.

CONTRIBUTES TO

CREDIT 2.1 - 2.2	Construction Waste Management	1-2 point(s)
CREDIT 3.3	Resource Reuse	1 point
CREDIT 4.1	Recycled Content	1 point
CREDIT 4.5	Low Emitting Materials, Systems & Seating	1 point
CREDIT 5.1	Regional Materials*	1 point
CREDIT 7	Certified Wood (MUST BE REQUESTED)	1 point(s)

**level® CERTIFICATION, AIR EMISSIONS AND FSC® CERTIFICATION**



**level® CERTIFICATION**

BIFMA's e3 Furniture Sustainability Standard is a voluntary, multi-attribute standard that measures the degree of sustainability of furniture. This standard evaluates product and company environmental attributes and compliance systems in a wide range of elements which include Materials, Energy & Atmosphere, Human & Ecosystem Health and Social Responsibility. Bali products have earned level®, BIFMA's sustainability certification program for furniture, certification through third-party verification against the e3 standard.

**AIR-EMISSIONS**

All Bali products are supplied with air-emissions certified. Contact customer service for information.







**FSC®**

In 2005, Krug received Forest Stewardship Council® (FSC®) Chain-of-Custody certification for our manufacturing facilities. The FSC® Chain-of-Custody tracks certified wood from seedling to final sale. It verifies that the material for our FSC® certified products only come from well-managed, FSC®-certified forests and other controlled sources. FSC® is dedicated to the promotion of responsible forest management worldwide helping to take care of forests for future generations. Bali and other Krug products can be specified with FSC® Certification. Contact customer service for further information, pricing and lead times.



Architects, designers, and building professionals can specify FSC®-certified products in order to achieve a point from the U.S. Green Building Council's Leadership in Energy and Environmental Design (LEED) Rating System.

# BALI

DESCRIPTION/MODEL	COM		COL	FABRIC GRADES			LEATHER		
	1	2	3	4	5	6	7	8	9
 Wood with Black back leg BAL2A1B	833								
Wood with Chrome back leg BAL2A1C	916								
 Upholstered Front with Black back leg BAL2A2B	1128	1169	1223	1281	1336	1402	1478	1551	1671
Upholstered Front with Chrome back leg BAL2A2C	1244	1289	1336	1391	1447	1524	1594	1680	1810
 Upholstered Seat Cushion with Black back leg BAL2A3B	1084	1120	1158	1205	1244	1289	1336	1409	1484
Upholstered Seat Cushion with Chrome back leg BAL2A3C	1158	1205	1244	1289	1345	1420	1478	1558	1636
 Caddie DOL6	838								

## DIMENSIONS & COM REQUIREMENTS

	Overall Width	Overall Depth	Overall Height	Seat Height	Height of Arms from Floor	Width between Arms	Seat Depth	Shipping Weight	Cube	COM Yardage
<b>WOOD SHELL</b>	23.25	23	34.25	17.25	26	19.5	18	30	15.3	-
<b>UPHOLSTERED FRONT</b>	23.25	23	34.25	18.11	26	19.5	17	30	15.3	0.8
<b>UPHOLSTERED SEAT CUSHION</b>	23.25	23	34.25	18.25	26	19.5	18	30	15.3	0.4

## ORDERING NOTES

Bali Guest Chairs are available with a removable upholstered seat cover at an upcharge of **\$80 list** per chair.  
 Bali Guest Chairs are available with a removable upholstered back cover at an upcharge of **\$48 list** per chair.  
 Ganging is optional on all wood arm and side chairs at an upcharge of **\$80 list** per chair. Please specify at time of order.  
 When used with Caddie (stacking cart), Bali stacks to a maximum of 10 chairs high, and 6 high without Caddie.  
 Chair frames are available in Cherry and Beech finishes. Please see page 335 for finish color selection and clearly mark on your purchase order. CAL 133 and Moisture Barrier options are available for an upcharge of **\$64 list per yard**. See page 333 for more information.

## ORDERING PROCEDURE

To order please specify the following:

1. Krug product model number
2. Select a finish for the chair frame
3. Select a textile or leather

Dimensions are in inches and approximate. Contact Customer Service if dimensions are critical.

## PRODUCT CODE KEY

Line	Series	Base	Chair Style	Back Leg Style
BAL	2	A	1	B
Bali	Guest Seating	Arm Chair	Wood	Black
			2	C
			Upholstered Front	Chrome
			3	
			Upholstered Seat Cushion	

LEED CI CREDITS



MATERIAL CONTENT:

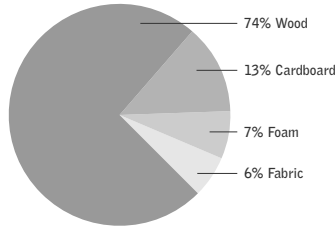

PRE-CONSUMER  
RECYCLED CONTENT = .80%

POST-CONSUMER  
RECYCLED CONTENT = 15.28%

Up to 16% of this Kita product is recyclable at the end of its useful life.

CONTRIBUTES TO

CREDIT 2.1 - 2.2	Construction Waste Management	1-2 point(s)
CREDIT 3.3	Resource Reuse	1 point
CREDIT 4.1	Recycled Content	1 point
CREDIT 4.5	Low Emitting Materials, Systems & Seating	1 point
CREDIT 5.1	Regional Materials*	1 point
CREDIT 7	Certified Wood (MUST BE REQUESTED)	1 point(s)

level® CERTIFICATION, AIR EMISSIONS AND FSC® CERTIFICATION



**level® CERTIFICATION**

BIFMA's e3 Furniture Sustainability Standard is a voluntary, multi-attribute standard that measures the degree of sustainability of furniture. This standard evaluates product and company environmental attributes and compliance systems in a wide range of elements which include Materials, Energy & Atmosphere, Human & Ecosystem Health and Social Responsibility. Kita products have earned level®, BIFMA's sustainability certification program for furniture, certification through third-party verification against the e3 standard.



the mark of responsible forest

**AIR EMISSIONS**

All Kita products are supplied air-emissions certified. Contact customer service for information.





**FSC®**

In 2005, Krug received Forest Stewardship Council® (FSC®) Chain-of-Custody certification for our manufacturing facilities. The FSC® Chain-of-Custody tracks certified wood from seedling to final sale. It verifies that the material for our FSC® certified products only come from well-managed, FSC®-certified forests and other controlled sources. FSC® is dedicated to the promotion of responsible forest management worldwide helping to take care of forests for future generations. Kita and other Krug products can be specified with FSC® Certification. Contact customer service for further information, pricing and lead times.



Architects, designers, and building professionals can specify FSC®-certified products in order to achieve a point from the U.S. Green Building Council's Leadership in Energy and Environmental Design (LEED) Rating System.

# KITA

DESCRIPTION/MODEL	Species	COM		COL			FABRIC GRADES			LEATHER	
		1	2	3	4	5	6	7	8	9	
 Open Arm, Full Width Upholstered Back 1320-OA	Maple	1317	1372	1411	1503	1559	1609	1692	1887	2033	
 Closed Arm, Full Width Upholstered Back 1320-CA	Maple	1715	1786	1834	1955	2033	2090	2201	2453	2714	
 3/4 Width Upholstered Back 1321-A	Maple	1317	1372	1411	1503	1559	1609	1692	1887	2033	
 Slat Back 1322-A	Maple	1372	1422	1452	1537	1587	1618	1688	1841	1959	
 Shoji Back 1323-A	Maple	1303	1348	1378	1461	1509	1537	1615	1769	1883	

## ORDERING NOTES

Kita Guest Chairs are available with a removable upholstered seat cover at an upcharge of **\$80 list** per chair. CAL 133 and Moisture Barrier options are available for an upcharge of **\$64 list per yard**. See page 333 for more information.

## DIMENSIONS & COM REQUIREMENTS

	Overall Width	Overall Depth	Overall Height	Seat Height	Height of Arms from Floor	Width between Arms	Seat Depth	Shipping Weight	Cube	COM Yardage
<b>1320-OA</b>	22	24	32	18.5	26	18.75	19	25	12	1
<b>1320-CA</b>	22	24	32	18.5	26	18.75	19	25	12	1.8
<b>1321-A</b>	22	24	32	18.5	26	18.75	19	25	12	1
<b>1322-A</b>	22	24	32	18.5	26	18.75	19	26	12	0.8*
<b>1323-A</b>	22	24	32	18.5	26	18.75	19	26	12	0.8*

## ORDERING PROCEDURE

To order please specify the following:

1. Krug product model number
2. Select a finish for the chair frame
3. Select a textile or leather

Dimensions are in inches and approximate. Contact Customer Service if dimensions are critical.

## STANDARD FINISHES

Chair frames are available in Oak, Cherry, Maple, Walnut, Medium Anigre finishes. Please see page 335 for finish color selection and clearly mark on your purchase order.

## GANGING

Ganging is optional on all wood arm and side chairs at an upcharge of **\$80 list** per chair. Please specify at time of order.

## LEED CI CREDITS



MATERIAL CONTENT:

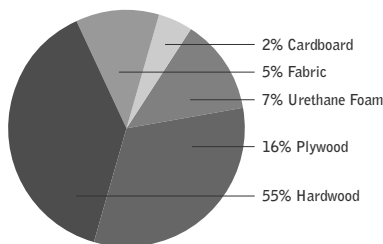

PRE-CONSUMER  
RECYCLED CONTENT = .45%

POST-CONSUMER  
RECYCLED CONTENT = 17.27%

Up to 18.18% of this Spence product is recyclable at the end of its useful life.

### CONTRIBUTES TO

CREDIT 2.1 - 2.2	Construction Waste Management	1-2 point(s)
CREDIT 3.3	Resource Reuse	1 point
CREDIT 4.1	Recycled Content	1 point
CREDIT 4.5	Low Emitting Materials, Systems & Seating	1 point
CREDIT 5.1	Regional Materials*	1 point
CREDIT 7	Certified Wood (MUST BE REQUESTED)	1 point(s)

## level® CERTIFICATION, AIR EMISSIONS AND FSC® CERTIFICATION



### level® CERTIFICATION

BIFMA's e3 Furniture Sustainability Standard is a voluntary, multi-attribute standard that measures the degree of sustainability of furniture. This standard evaluates product and company environmental attributes and compliance systems in a wide range of elements which include Materials, Energy & Atmosphere, Human & Ecosystem Health and Social Responsibility. Spence products have earned level®, BIFMA's sustainability certification program for furniture, certification through third-party verification against the e3 standard.



FSC  
www.fsc.org  
FSC® C021699

the mark of responsible forest

### AIR EMISSIONS

All Spence products are supplied air-emissions certified. Contact customer service for information.



### FSC®

In 2005, Krug received Forest Stewardship Council® (FSC®) Chain-of-Custody certification for our manufacturing facilities. The FSC® Chain-of-Custody tracks certified wood from seedling to final sale. It verifies that the material for our FSC® certified products only come from well-managed, FSC®-certified forests and other controlled sources. FSC® is dedicated to the promotion of responsible forest management worldwide helping to take care of forests for future generations. Spence and other Krug products can be specified with FSC® Certification. Contact customer service for further information, pricing and lead times.

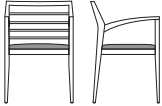

Architects, designers, and building professionals can specify FSC®-certified products in order to achieve a point from the U.S. Green Building Council's Leadership in Energy and Environmental Design (LEED) Rating System.

# SPENCE

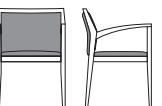
DESCRIPTION/MODEL	WOOD FINISH	COM		COL			FABRIC GRADES			LEATHER	
		1	2	3	4	5	6	7	8	9	
	Slat Back 1400	Oak	1192	1257	1345	1431	1534	1645	1761	1909	2011
		Cherry, Maple, Walnut, Medium Anigre	1335	1403	1487	1573	1671	1786	1902	2045	2145
	Slat & Upholstered Back 1401	Oak	1229	1297	1386	1473	1581	1697	1810	1967	2110
		Cherry, Maple, Walnut, Medium Anigre	1372	1445	1534	1620	1723	1839	1959	2107	2252
	Split Upholstered Back 1402	Oak	1251	1317	1411	1503	1609	1729	1846	2006	2185
		Cherry, Maple, Walnut, Medium Anigre	1401	1473	1559	1653	1758	1871	1997	2146	2327
	Full Upholstered Back 1403	Oak	1262	1336	1423	1515	1622	1745	1866	2020	2239
		Cherry, Maple, Walnut, Medium Anigre	1411	1485	1581	1667	1772	1893	2016	2165	2385

## ORDERING NOTES

Spence Guest Chairs are available with a removable upholstered seat cover at an upcharge of **\$80 list** per chair. CAL 133 and Moisture Barrier options are available for an upcharge of **\$64 list per yard**.

## DIMENSIONS & COM REQUIREMENTS

	Overall Width	Overall Depth	Overall Height	Seat Height	Height of Arms from Floor	Width between Arms	Seat Depth	Shipping Weight	Cube	COM Yardage
<b>1400</b>	22	24	33	18	27	18	20	21	13	0.7
<b>1401</b>	22	24	33	18	27	18	20	22	13	1.0
<b>1402</b>	22	24	33	18	27	18	20	22	13	1.25
<b>1403</b>	22	24	33	18	27	18	20	23	13	1.5

### ORDERING PROCEDURE

To order please specify the following:

1. Krug product model number
2. Select a finish for the chair frame
3. Select a textile or leather

Dimensions are in inches and approximate. Contact Customer Service if dimensions are critical.

### STANDARD FINISHES

Chair frames are available in Oak, Cherry, Maple, Walnut, Medium Anigre finishes. Please see page 335 for finish color selection and clearly mark on your purchase order.

### GANGING

Ganging is optional on all wood arm and side chairs at an upcharge of **\$80 list** per chair. Please specify at time of order.



## LEED CI CREDITS



MATERIAL CONTENT:

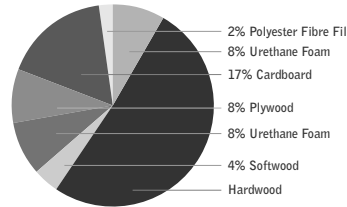

PRE-CONSUMER  
RECYCLED CONTENT = .43%

POST-CONSUMER  
RECYCLED CONTENT = 16.46%

Up to 16.91% of this Cadence product is recyclable at the end of its useful life.

CONTRIBUTES TO		
CREDIT 2.1 - 2.2	Construction Waste Management	1-2 point(s)
CREDIT 3.3	Resource Reuse	1 point
CREDIT 4.1	Recycled Content	1 point
CREDIT 4.5	Low Emitting Materials, Systems & Seating	1 point
CREDIT 5.1	Regional Materials*	1 point
CREDIT 7	Certified Wood (MUST BE REQUESTED)	1 point(s)

## level® CERTIFICATION, AIR EMISSIONS AND FSC® CERTIFICATION



### level® CERTIFICATION

BIFMA's e3 Furniture Sustainability Standard is a voluntary, multi-attribute standard that measures the degree of sustainability of furniture. This standard evaluates product and company environmental attributes and compliance systems in a wide range of elements which include Materials, Energy & Atmosphere, Human & Ecosystem Health and Social Responsibility. Cadence products have earned level®, BIFMA's sustainability certification program for furniture, certification through third-party verification against the e3 standard.

### AIR-EMISSIONS

All Cadence products are supplied with air-emissions certified. Contact customer service for information.



### FSC®

In 2005, Krug received Forest Stewardship Council® (FSC®) Chain-of-Custody certification for our manufacturing facilities. The FSC® Chain-of-Custody tracks certified wood from seedling to final sale. It verifies that the material for our FSC® certified products only come from well-managed, FSC®-certified forests and other controlled sources. FSC® is dedicated to the promotion of responsible forest management worldwide helping to take care of forests for future generations. Cadence and other Krug products can be specified with FSC® Certification. Contact customer service for further information, pricing and lead times.



Architects, designers, and building professionals can specify FSC®-certified products in order to achieve a point from the U.S. Green Building Council's Leadership in Energy and Environmental Design (LEED) Rating System.

# CADENCE | GUEST

DESCRIPTION/MODEL	WOOD FINISH	COM		COL 3	FABRIC GRADES			LEATHER		
		1	2		4	5	6	7	8	9
 CAD2A	Cherry, Maple, Walnut, Medium Anigre	1515	1587	1654	1767	1879	1989	2105	2241	2488

## ORDERING NOTES

CAL 133 and Moisture Barrier options are available for an upcharge of **\$64 list per yard**.

## DIMENSIONS & COM REQUIREMENTS

	Overall Width	Overall Depth	Overall Height	Seat Height	Height of Arms from Floor	Width between Arms	Seat Depth	Shipping Weight	Cube	COM Yardage
<b>CAD2A</b>	22.75	27	36	18.25	26	18.75	18	23	18	1.7

### ORDERING PROCEDURE

To order please specify the following:

1. Krug product model number
2. Select a finish for the chair frame
3. Select a textile or leather

Dimensions are in inches and approximate. Contact Customer Service if dimensions are critical.

### STANDARD FINISHES

Chair frames are available in Cherry, Maple, Walnut and Medium Anigre finishes. Please see Page 335 for finish color selection and clearly mark on your purchase order.

LEED CI CREDITS



MATERIAL CONTENT:

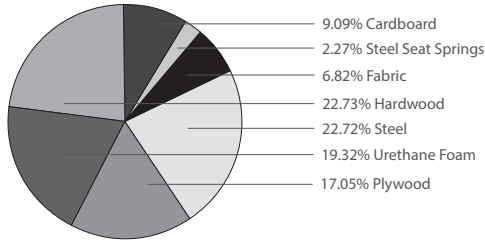

PRE-CONSUMER RECYCLED CONTENT = 6.25%

POST-CONSUMER RECYCLED CONTENT = 13.64%

Up to 31.82% of this Faeron product is recyclable at the end of its useful life.

CREDIT	CONTRIBUTES TO	POINTS
CREDIT 2.1 - 2.2	Construction Waste Management	1-2 point(s)
CREDIT 3.3	Resource Reuse	1 point
CREDIT 4.1	Recycled Content	1 point
CREDIT 4.5	Low Emitting Materials, Systems & Seating	1 point
CREDIT 5.1	Regional Materials*	1 point
CREDIT 7	Certified Wood (MUST BE REQUESTED)	1 point(s)

\*This credit is only applicable if in total 20% of the combined value of the procurement of construction materials and in the furniture are manufactured within a radius of 500 miles. This credit will apply if the installation of the finished product occurs within 500 miles of Kitchener, Ontario.

level® CERTIFICATION, AIR EMISSIONS AND FSC® CERTIFICATION



**level® CERTIFICATION**

BIFMA's e3 Furniture Sustainability Standard is a voluntary, multi-attribute standard that measures the degree of sustainability of furniture. This standard evaluates product and company environmental attributes and compliance systems in a wide range of elements which include Materials, Energy & Atmosphere, Human & Ecosystem Health and Social Responsibility. Faeron products have earned level®, BIFMA's sustainability certification program for furniture, certification through third-party verification against the e3 standard.

**AIR-EMISSIONS**

All Faeron products are supplied with air-emissions certified. Contact customer service for information.



**FSC®**

In 2005, Krug received Forest Stewardship Council® (FSC®) Chain-of-Custody certification for our manufacturing facilities. The FSC® Chain-of-Custody tracks certified wood from seedling to final sale. It verifies that the material for our FSC® certified products only come from well-managed, FSC®-certified forests and other controlled sources. FSC® is dedicated to the promotion of responsible forest management worldwide helping to take care of forests for future generations. Faeron and other Krug products can be specified with FSC® Certification. Contact customer service for further information, pricing and lead times.



Architects, designers, and building professionals can specify FSC®-certified products in order to achieve a point from the U.S. Green Building Council's Leadership in Energy and Environmental Design (LEED) Rating System.

HEALTHCARE DISCOUNT APPLIES TO THESE PRODUCTS

# FAERON WOOD | GUEST, PATIENT, MULTIPLE & EASY ACCESS FEATURES

HEALTHCARE DISCOUNT APPLIES TO THESE PRODUCTS

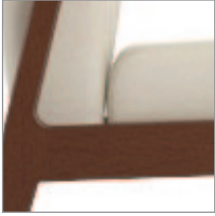

## CLEAN OUT

All Faeron seating models have a built-in clean out feature: a space at the back of the seat that allows dirt, debris and liquid to fall to the floor for easy clean up and maintenance - designed so that it does not detract from the comfort or appearance of the product.



## FLEX BACK

The ergonomically designed back has been designed with a slight flexing action, to enhance the level of long-term sitting comfort, and provide greater ease of egress.



## WALL SAVER

The angle of the back and the rear legs are designed to keep the back away from the wall, to prevent wear and damage to both the chairs and to the walls of the facility.



## STEEL SEAT FRAME

Steel seat frames are joined to other components with hardened steel bolts and inserts, ensuring exceptional durability and strength. In addition they ease re-configurability and on-site replacement of damaged or degraded components.



## SEAT COMFORT

Seats feature a spring suspension across the entire model range for exceptional comfort while high grade foam provides superior support and longevity.



## PLUS UPGRADE

Faeron 30" and 44" models feature Plus Upgrade. Plus Upgraded seating has been engineered to support higher weight capacities, accommodating a wider variety of users.



## GLIDES

Faeron's Beech wood legs feature non-marring glides.

## FINISH DURABILITY

The Krug's finish, a proprietary catalyzed varnish formulation, has been repeatedly shown, through independent laboratory testing, to be the industry leader in durability and abrasion resistance. The Krug finish looks better longer than competitors, and is uniquely suited to the demands of healthcare environments.

## LATEX FREE

Krug products are made with latex-free materials to prevent the allergic reaction that latex causes in some people.

## REPLACEABLE COMPONENTS

Faeron chairs are uniquely designed to allow virtually all major components to be field replaced, providing a very cost effective means to significantly extend the life of the product. Seats, backs, frames are field replaceable. Pricing and model numbers can be viewed online at [www.krug.ca](http://www.krug.ca).

## CUSTOM CAPABILITIES

Modifications in dimension, seat and back shape or thickness, and other modifications are possible with Krug's capability to customize for specific requirements and needs. We can also provide custom finishes.

## WEIGHT CAPACITIES

Faeron weight capacities are as follows:

Guest & Patient Chairs (21" & 24") - 500 lbs

Plus Chairs (30" & 44") - 750 lbs

Easy Access Chairs - 500 lbs

Multiple Seating & Pre-configured - 500 lbs per seat

2-Seat Freespan - 625 lbs per unit

3-Seat Freespan - 750 lbs per unit

# FAERON WOOD | GUEST, PATIENT, MULTIPLE & EASY ACCESS OPTIONS



## ARM PANELS

Panel arms are available in semi and fully closed styles for optimum design flexibility.



## URETHANE ARM CAP

The optional Urethane Arm Cap provides enhanced durability and protection for the arms. This is field replaceable if this becomes damaged or degraded and is available in three colors; Black, Grey and Taupe.

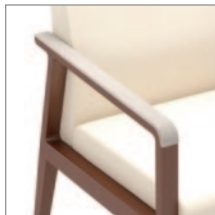

## SOLID SURFACE ARM CAP

The optional Solid Surface Arm Cap provides enhanced durability, protection and cleanability for the arms. This is field replaceable if this becomes damaged or degraded and is available in 8 standard colors.

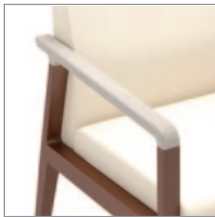

## SOLID SURFACE ARM FRAME

The optional Solid Surface Arm provides a fully seamless armrest for enhanced durability, protection and cleanability. It is available in 8 standard colors and replaceable as a full side frame if it becomes damaged or degraded.



## COMBINATION UPHOLSTERY OPTIONS

Faeron can be upholstered in combinations of two or more upholstery covers on the same units: seats, backs and closed arm panels can be individually upholstered with a specific cover. When combination upholstery is with upholstery of the same grade or COM, an upcharge for dual fabrics is **\$33 list** per unit and **\$64 list** per unit for three fabrics will be applied. When graded-in combination upholstery is selected, use the highest upholstery selected or contact Customer Service for a quote (please provide the fabrics specified and a description of where each fabric is to be applied on the product in order to obtain a quote)



## KINETIC BACK OPTION

Provides the chair back with a very pleasant and comfortable rocking motion, which can significantly enhance long-term sitting for patients and guests alike. The durable spring-loaded mechanism provides a range of motion of 20 degrees, and can be field-installed or replaced. It's available on any Faeron Guest or Patient chair back with the exception of the Plus styles (30" and 44").



## CLEANABLE UNDER-SEAT SPLASHGUARD

All Faeron seating models are available with a plastic moisture barrier that covers and encloses the underside of the seat (while still allowing air transfer and ventilation in and out of the seat cushion). The Splashguard significantly enhances the germ resistance properties of the product, by enclosing the part of the chair that can be most susceptible to infection-causing pathogens. The Splashguard is a smooth, easy to clean surface, either while on the chair or when removed, and is also field replaceable.

## GANGING

All Faeron freestanding Guest/Patient chairs can be ganged using a ganging bracket. The powder coated metal bracket is fastened to the inside face of each side frame. Ganging Brackets are available for an upcharge of **\$50 list** per chair.

## REMOVABLE COVERS

Faeron chairs (all sizes) are available with removeable seat and back covers. Replacement seat and back covers can be quickly installed on Faeron products that were originally ordered with the Removeable cover option. Replacement seat and back covers can also be installed on Faeron products that were not originally ordered with the removeable cover option, with some simple staple removal on the original seats and backs

## MOISTURE BARRIER & CAL 133

California Technical Bulletin 133 is a flammability test for seating. Krug offers a compliance method, in combination with non-flammable upholstery covers, may enable products to meet certification requirements for this test. This process at the same time also provides the products with a Moisture Barrier - a treatment that helps to prevent the passage of liquids and moisture to inside of the upholstered components - thereby conferring sanitary and anti-infection benefits. So when CAL 133 is specified, the product also automatically has a Moisture Barrier, and when a Moisture Barrier is specified, the product also features the compliance method and low flammability features of CAL 133.

The application of this up-charge and the compliance method does not mean that the specific configuration of product and upholstery cover are tested and officially certified as being CAL133 compliant. If the official certification is required, Krug will provide this (through an independent certified testing laboratory) at a charge of \$917 per item, plus the cost of the product to be tested. Lead time for certification testing is typically 4-8 weeks. Krug assumes no responsibility for the testing of our products in combination with upholstery covers, or for the results of any testing conducted. Some specific configurations of products and upholstery have already been tested. Please contact Customer Service for additional information.

HEALTHCARE DISCOUNT APPLIES TO THESE PRODUCTS

# FAERON WOOD | GUEST, DIMENSIONS & COM REQUIREMENTS

HEALTHCARE DISCOUNT APPLIES TO THESE PRODUCTS

## DIMENSIONS

	Overall Width	Overall Depth	Overall Height	Seat Height	Height of Arms from Floor	Width Between Arms	Seat Depth	Shipping Weight	Cube
21" Seat	25.0	26.3	34.5	19.0	25.0	21	19.5	44	14
24" Seat	28.0	26.3	34.5	19.0	25.0	24	19.5	48	19
30" Seat	34.0	26.3	34.5	19.0	25.0	30	19.5	54	20
44" Seat	48.0	26.3	34.5	19.0	25.0	44	19.5	71	28

## COM- YARDAGE REQUIREMENTS

	COM Yardage Seat & Back	COM Yardage Seats Only	COM Yardage Back Only	COM Yardage Closed Arm Panel
21" & 24" - One Chair	1.6	0.9	1.4	0.8
30" - One Chair	2.3	0.9	1.4	0.8
44" - One Chair	2.9	1.5	1.6	0.8

Note: Some vinyls, leathers & upholsteries are not suitable for application on Faeron seating.

The approval process is as follows:

1. A sample of the COM must be provided to Krug Customer Service prior to or at the time of order.
2. The sample will be reviewed and the customer advised if the fabric is unsuitable.
3. The COM fabric or leather will be inspected when received at the factory, to identify any further concerns with its suitability.

## ORDERING NOTES:

Combination upholstery (more than one upholstery cover within the same unit) is an option on all Faeron upholstered products. When combination upholstery is with upholstery of the same grade or COM, an upcharge for dual fabrics is **\$33 list** per unit and **\$64 list** per unit for three fabrics. When graded in combination upholstery is selected, use the highest grade upholstery selected or contact Customer Service for a quote -please provide the fabrics specified and a description of where each fabric is to be applied on the product in order to obtain a quote.

## WEIGHT CAPACITIES







Faeron weight capacities are as follows:

Guest Chairs (21" & 24") - 500 lbs

Guest Plus Chairs (30" & 44") - 750 lbs

Faeron Option Upcharges	\$ List		\$ List
CAL 133 & Moisture Barrier (per yard)	64	Solid Surface Arm Cap (per pair) - Gr A White	364
Ganging Bracket	58	Solid Surface Arm Cap (per pair) - Gr A Color	376
Kinetic Back (not available for 30" & 44")	120	Solid Surface Arm Cap (per pair) - Gr B	396
21" & 24" Under-seat Splashguard	58	Solid Surface Arm Cap (per pair) - Gr C	410
30" Under-seat Splashguard	72	Solid Surface Arm (per pair) - Gr A White	573
44" Under-seat Splashguard	91	Solid Surface Arm (per pair) - Gr A Color	598
Removeable Seat Cover	90	Solid Surface Arm (per pair) - Gr B	645
Removeable Back Cover	58	Solid Surface Arm (per pair) - Gr C	678
Urethane Arm Cap (per pair)	138		

HEALTHCARE DISCOUNT APPLIES TO THESE PRODUCTS

DESCRIPTION/MODEL	Species	COM		COL		FABRIC GRADES			LEATHER	
		1	2	3	4	5	6	7	8	9
 21" Open Arm FAE2-G21ONC	Beech Palette	1134	1178	1223	1314	1404	1495	1588	1678	1861
 21" Semi Closed Arm FAE2-G21SNC	Beech Palette	1539	1609	1676	1813	1951	2087	2222	2361	2635
 21" Closed Arm FAE2-G21CNC	Beech Palette	1554	1619	1689	1825	1964	2100	2237	2374	2646
 24" Open Arm FAE2-G24ONC	Beech Palette	1213	1258	1305	1396	1487	1580	1669	1760	1944
 24" Semi Closed Arm FAE2-G24SNC	Beech Palette	1620	1690	1758	1896	2032	2169	2306	2443	2717
 24" Closed Arm FAE2-G24CNC	Beech Palette	1634	1703	1772	1908	2044	2184	2319	2457	2728





**ORDERING NOTES:** Faeron chairs can be specified with Urethane Arm Caps (UC), Solid Surface Arm Caps (SC) or Solid Surface Arm (SA), replace "NC" in the model number with the **Arm Style** selection below and add the upcharge listed on page 85.

PRODUCT CODE KEY

Line	Series	Chair Type	Size	Arm Type	Arm Style
FAE Faeron	2 Chair	G Guest Seating	21	O Open Arm	NC No Cap
			24	S Semi Closed Arm	UC Urethane Cap
			30	C Closed Arm	SC Solid Surface Cap
			44		SA Solid Surface Arm

# FAERON WOOD | GUEST

HEALTHCARE DISCOUNT APPLIES TO THESE PRODUCTS

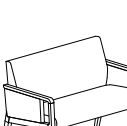
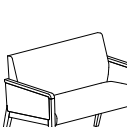
DESCRIPTION/MODEL	Species	COM		COL	FABRIC GRADES			LEATHER		
		1	2	3	4	5	6	7	8	9
 30" Open Arm FAE2-G30ONC	Beech Palette	1384	1451	1514	1645	1778	1909	2040	2170	2433
 30" Semi Closed Arm FAE2-G30SNC	Beech Palette	1792	1881	1968	2146	2323	2500	2678	2853	3207
 30" Closed Arm FAE2-G30CNC	Beech Palette	1804	1893	1981	2160	2334	2511	2690	2866	3219
 44" Open Arm FAE2-G44ONC	Beech Palette	1702	1782	1866	2032	2196	2362	2529	2694	3025
 44" Semi Closed Arm FAE2-G44SNC	Beech Palette	2109	2214	2321	2531	2742	2954	3163	3374	3797
 44" Closed Arm FAE2-G44CNC	Beech Palette	2121	2227	2332	2543	2754	2965	3177	3386	3811

**ORDERING NOTES:** Faeron chairs can be specified with Urethane Arm Caps (UC), Solid Surface Arm Caps (SC) or Solid Surface Arm (SA), replace "NC" in the model number with the **Arm Style** selection below and add the upcharge listed on page 85.

PRODUCT CODE KEY

Line	Series	Chair Type	Size	Arm Type	Arm Style
Faeron	2 Chair	G Guest Seating	21	O Open Arm	NC No Cap
			24	S Semi Closed Arm	UC Urethane Cap
			30	C Closed Arm	SC Solid Surface Cap
			44		SA Solid Surface Arm



LEED CI CREDITS



MATERIAL CONTENT:

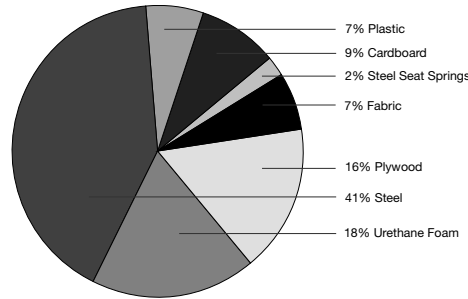

PRE-CONSUMER RECYCLED CONTENT = 10.87 %

POST-CONSUMER RECYCLED CONTENT = 17.48 %

Up to 50% of this Faeron Metal product is recyclable at the end of its useful life.

CONTRIBUTES TO

CREDIT 2.1 - 2.2	Construction Waste Management	1-2 point(s)
CREDIT 3.3	Resource Reuse	1 point
CREDIT 4.1	Recycled Content	1 point
CREDIT 4.2	Recycled Content	1 point
CREDIT 4.5	Low Emitting Materials, Systems & Seating	1 point
CREDIT 5.1	Regional Materials*	1 point
CREDIT 7	Certified Wood (MUST BE REQUESTED)	1 point(s)

\*This credit is only applicable if in total 20% of the combined value of the procurement of construction materials and in the furniture are manufactured within a radius of 500 miles. This credit will apply if the installation of the finished product occurs within 500 miles of Kitchener, Ontario.

level® CERTIFICATION, AIR EMISSIONS AND FSC® CERTIFICATION



level® CERTIFICATION

BIFMA's e3 Furniture Sustainability Standard is a voluntary, multi-attribute standard that measures the degree of sustainability of furniture. This standard evaluates product and company environmental attributes and compliance systems in a wide range of elements which include Materials, Energy & Atmosphere, Human & Ecosystem Health and Social Responsibility. Faeron products have earned level®, BIFMA's sustainability certification program for furniture, certification through third-party verification against the e3 standard.

AIR-EMISSIONS

All Faeron products are supplied with air-emissions certified. Contact customer service for information.



FSC®

In 2005, Krug received Forest Stewardship Council® (FSC®) Chain-of-Custody certification for our manufacturing facilities. The FSC® Chain-of-Custody tracks certified wood from seedling to final sale. It verifies that the material for our FSC® certified products only come from well-managed, FSC®-certified forests and other controlled sources. FSC® is dedicated to the promotion of responsible forest management worldwide helping to take care of forests for future generations. Faeron and other Krug products can be specified with FSC® Certification. Contact customer service for further information, pricing and lead times.



Architects, designers, and building professionals can specify FSC®-certified products in order to achieve a point from the U.S. Green Building Council's Leadership in Energy and Environmental Design (LEED) Rating System.

HEALTHCARE DISCOUNT APPLIES TO THESE PRODUCTS

# FAERON METAL | GUEST, PATIENT, MULTIPLE & EASY ACCESS FEATURES

HEALTHCARE DISCOUNT APPLIES TO THESE PRODUCTS

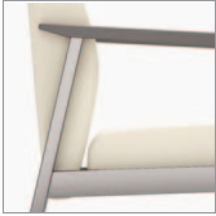

## CLEAN OUT

All Faeron Metal seating models have a built-in clean out feature: a space at the back of the seat that allows dirt, debris and liquid to fall to the floor for easy clean up and maintenance - designed so that it does not detract from the comfort or appearance of the product.



## FLEX BACK

The ergonomically designed back has been designed with a slight flexing action, to enhance the level of long-term sitting comfort, and provide greater ease of egress.



## WALL SAVER

The angle of the back and the rear legs are designed to keep the back away from the wall, to prevent wear and damage to both the chairs and to the walls of the facility.



## STEEL SEAT FRAME

Steel seat frames are joined to other components with hardened steel bolts and inserts, ensuring exceptional durability and strength. The seats features a spring system that substantially enhances comfort and extends product life cycle. Seats are removable, and field replaceable.



## SEAT COMFORT

Seats feature a spring suspension for exceptional comfort while high grade foam provides superior support and longevity.

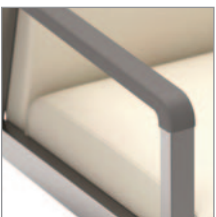

## POLYMER ARM

Faeron arms are durable, comfortable, and long lasting. They are made with injected polymer that is a solid color throughout the arm and are available in three color options: Black, Grey and Taupe.

## METAL FINISHES

Faeron Metal chairs are available in two metal finishes; Silver Metallic and Brushed Nickel.

## FINISH DURABILITY

The Krug's finish, a proprietary catalyzed varnish formulation, has been repeatedly shown, through independent laboratory testing, to be the industry leader in durability and abrasion resistance. The Krug finish looks better longer and is especially suited to the demands of healthcare environments.

## LATEX FREE

Krug products are made with latex-free materials to prevent the allergic reaction that latex causes in some people.

## REPLACEABLE COMPONENTS

Faeron Metal chairs are uniquely designed to allow virtually all major components to be field replaced, providing a very cost effective means to significantly extend the life of the product. Seats, backs, frames are field replaceable. Pricing and model numbers can be viewed online at [www.krug.ca](http://www.krug.ca).

## CUSTOM CAPABILITIES

Modifications in dimension, seat and back shape or thickness, and other modifications are possible with Krug's capability to customize for specific requirements and needs. We can also provide custom finishes.

## WEIGHT CAPACITIES

Faeron Metal weight capacities are as follows:  
Guest & Patient Chairs (21" & 24") - 500 lbs  
Plus Chairs (30" & 44") - 750 lbs  
Easy Access Chairs - 500 lbs  
Multiple Seating & Pre-configured - 500 lbs per seat  
2-Seat Freespan - 625 lbs per unit  
3-Seat Freespan - 750 lbs per unit

## PLUS UPGRADE

Faeron 30" and 44" models feature Plus Upgrade. Plus Upgraded seating has been engineered to support higher weight capacities, accommodating a wider variety of users.

[Faeron Metal Images | www.krug.ca](http://www.krug.ca)

# FAERON METAL | GUEST, PATIENT, MULTIPLE & EASY ACCESS OPTIONS



## ARM PANEL

Upholstered arm panels are available in both semi- and fully-closed styles, and are field replaceable if damaged.



## SOLID SURFACE ARM

The optional Solid Surface Arm provides a fully seamless armrest for enhanced durability, protection and cleanability. It is available in 8 standard Corian colors, and custom colors (at an upcharge). Arms are replaceable as a full side frame if they become damaged or degraded.



## WOOD ARM

Wood arms are solid Beech and available in standard and custom finishes. Krug's wood finish is a proprietary high-durability formulation that has been shown to be an industry leader in abrasion resistance. Arms can be replaced if they do become damaged or degraded.



## COMBINATION UPHOLSTERY OPTIONS

Faeron Metal can be upholstered in combinations of two or more upholstery covers on the same units: seats, backs and closed arm panels can be individually upholstered with a specific cover. When combination upholstery is with upholstery of the same grade or COM, an upcharge for dual fabrics is **\$33 list** per unit and **\$64 list** per unit for three fabrics will be applied. When graded-in combination upholstery is selected, use the highest upholstery selected or contact Customer Service for a quote (please provide the fabrics specified and a description of where each fabric is to be applied on the product in order to obtain a quote)



## KINETIC BACK OPTION

The optional Kinetic Back provides the chair back with a very pleasant and comfortable rocking motion, which can significantly enhance long-term sitting for patients and guests alike. The durable spring-loaded mechanism provides a range of motion of 20 degrees, and can be field-installed or replaced. It's available on any Faeron Guest or Patient chair back with the exception of the Plus styles (30" and 44").



## CLEANABLE UNDER-SEAT SPLASHGUARD

All Faeron Metal seating models are available with a plastic moisture barrier that covers and encloses the underside of the seat (while still allowing air transfer and ventilation in and out of the seat cushion). The Splashguard significantly enhances the anti-microbial and germ resistance properties of the product, by enclosing the part of the chair that can be most susceptible to infection-causing pathogens. The Splashguard is a smooth, easy to clean surface, either while on the chair or when removed, and is also field replaceable.



## REMOVABLE COVERS

Faeron Metal chairs (all sizes) are available with removable seat and back covers. Replacement seat and back covers can be quickly installed on Faeron products that were originally ordered with the Removeable cover option. Replacement seat and back covers can also be installed on Faeron products that were not originally ordered with the removeable cover option, with some simple staple removal on the original seats and backs.

## METAL FINISH OPTIONS

Silver Metallic frames are available with an anti-microbial finish for an upcharge of **\$64 list** per arm frame pair or table. Additional Frame Finishes, which include anti-microbial finish, are available for an upcharge of **\$64 list** per arm frame pair or table. Available colors are: White, Parchment, Sand, Taupe, Warm Grey, Cool Grey or Black. For all metal finishes other than Silver Metallic Standard, there is a minimum order quantity of 30 units per color. Upcharges for order quantities less than 30 units per color or custom metal finishes, please contact Customer Service to obtain a quote.

## MOISTURE BARRIER & CAL 133

California Technical Bulletin 133 is a flammability test for seating. Krug offers a compliance method, in combination with non-flammable upholstery covers, may enable products to meet certification requirements for this test. This process at the same time also provides the products with a Moisture Barrier - a treatment that helps to prevent the passage of liquids and moisture to inside of the upholstered components - thereby conferring sanitary and anti-infection benefits. So when CAL 133 is specified, the product also automatically has a Moisture Barrier, and when a Moisture Barrier is specified, the product also features the compliance method and low flammability features of CAL 133.

The application of this up-charge and the compliance method does not mean that the specific configuration of product and upholstery cover are tested and officially certified as being CAL133 compliant. If the official certification is required, Krug will provide this (through an independent certified testing laboratory) at a charge of \$917 per item, plus the cost of the product to be tested. Lead time for certification testing is typically 4-8 weeks. Krug assumes no responsibility for the testing of our products in combination with upholstery covers, or for the results of any testing conducted. Some specific configurations of products and upholstery have already been tested. Please contact Customer Service for additional information.

## GANGING

All Faeron Metal freestanding Guest/Patient chairs can be ganged using a ganging bracket. The powder coated metal bracket is fastened to the inside face of each side frame. Ganging Brackets are available for an upcharge of **\$58 list** per chair.

HEALTHCARE DISCOUNT APPLIES TO THESE PRODUCTS

# FAERON METAL | GUEST

## DIMENSIONS

	Overall Width	Overall Depth	Overall Height	Seat Height	Height of Arms from Floor	Width Between Arms	Seat Depth	Shipping Weight	Cube
21" Seat	25.0	26.3	34.5	19.0	25.0	21	19.5	56	14
24" Seat	28.0	26.3	34.5	19.0	25.0	24	19.5	60	19
30" Seat	34.0	26.3	34.5	19.0	25.0	30	19.5	66	20
44" Seat	48.0	26.3	34.5	19.0	25.0	44	19.5	83	28

## COM- YARDAGE REQUIREMENTS

	COM Yardage Seat & Back	COM Yardage Seats Only	COM Yardage Back Only	COM Yardage Closed Arm Panel
21" & 24" - One Chair	1.6	0.9	1.4	0.96
30" - One Chair	2.3	0.9	1.4	0.96
44" - One Chair	2.9	1.5	1.6	0.96

## ORDERING NOTES:

The approval process is as follows:

1. A sample of the COM must be provided to Krug Customer Service prior to or at the time of order.
  2. The sample will be reviewed and the customer advised if the fabric is unsuitable.
  3. The COM fabric or leather will be inspected when received at the factory, to identify any further concerns with its suitability.
- Note: Some vinyls, leathers & upholsteries are not suitable for application on Faeron Metal seating.

**A drawing showing the configuration of the multiple seating and tables is required with each purchase order.**

**Combination upholstery** (more than one upholstery cover within the same unit) is an option on all Faeron Metal upholstered products. When combination upholstery is with upholstery of the same grade or COM, an upcharge for dual fabrics is **\$33 list** per unit and **\$64 list** per unit for three fabrics. When graded in combination upholstery is selected, use the highest grade upholstery selected or contact Customer Service for a quote -please provide the fabrics specified and a description of where each fabric is to be applied on the product in order to obtain a quote.

Faeron Option Upcharges	\$ List		\$ List
CAL 133 & Moisture Barrier (per yard)	64	Solid Surface Arm (per pair) - Gr A White	573
Ganging Bracket	58	Solid Surface Arm (per pair) - Gr A Color	598
Kinetic Back (not available for Plus)	120	Solid Surface Arm (per pair) - Gr B	645
21" & 24" Under-seat Splashguard	58	Solid Surface Arm (per pair) - Gr C	678
30" Under-seat Splashguard	72	Beech/Palette Wood Arm (per pair)	215
44" Under-seat Splashguard	91		
Removeable Seat Cover	90		
Removable Back Cover	58		
Non-Marring Glides	16		

## WEIGHT CAPACITIES







Faeron Metal weight capacities are as follows:

Guest Chairs (21" & 24") - 500 lbs

Plus Chairs (30" & 44") - 750 lbs

HEALTHCARE DISCOUNT APPLIES TO THESE PRODUCTS

# FAERON METAL | GUEST

DESCRIPTION/MODEL	COM		COL	FABRIC GRADES			LEATHER				
	1	2	3	4	5	6	7	8	9		
	21" Open Polymer Arm, Silver Metallic Frame FAE2M-G21OPAS		1014	1059	1098	1187	1272	1360	1447	1535	1708
	21" Open Polymer Arm, Brushed Nickel Frame FAE2M-G21OPAN		1207	1251	1294	1380	1466	1555	1642	1729	1902
	21" Semi Closed Polymer Arm, Silver Metallic Frame FAE2M-G21SPAS		1402	1466	1533	1663	1793	1923	2055	2185	2445
	21" Semi Closed Polymer Arm, Brushed Nickel Frame FAE2M-G21SPAN		1596	1661	1727	1857	1987	2117	2249	2378	2639
	21" Closed Polymer Arm, Silver Metallic Frame FAE2M-G21CPAS		1414	1480	1543	1673	1804	1935	2065	2195	2458
	21" Closed Polymer Arm, Brushed Nickel Frame FAE2M-G21CPAN		1609	1671	1737	1869	1999	2130	2261	2390	2652
	24" Open Polymer Arm, Silver Metallic Frame FAE2M-G24OPAS		1092	1136	1179	1266	1354	1438	1527	1613	1788
	24" Open Polymer Arm, Brushed Nickel Frame FAE2M-G24OPAN		1285	1330	1373	1460	1545	1633	1719	1806	1980
	24" Semi Closed Polymer Arm, Silver Metallic Frame FAE2M-G24SPAS		1481	1544	1611	1743	1871	2002	2133	2263	2523
	24" Semi Closed Polymer Arm, Brushed Nickel Frame FAE2M-G24SPAN		1672	1738	1803	1935	2064	2194	2326	2457	2717
	24" Closed Polymer Arm, Silver Metallic Frame FAE2M-G24CPAS		1492	1557	1622	1753	1883	2013	2145	2274	2535
	24" Closed Polymer Arm, Brushed Nickel Frame FAE2M-G24CPAN		1686	1751	1816	1946	2077	2208	2339	2466	2728

### ORDERING NOTES:

Faeron Metal chairs can also be specified with a Wood Arm (WA) or a Solid Surface Arm (SA), replace "PA" in the model number with the **Arm Style** selection below and add the upcharge listed.

### Arm Style Option Upcharges

	\$ List
Solid Surface Arm (per pair) - Gr A White	573
Solid Surface Arm (per pair) - Gr A Color	598
Solid Surface Arm (per pair) - Gr B	645
Solid Surface Arm (per pair) - Gr C	678
Beech/Palette Wood Arm (per pair)	215







### PRODUCT CODE KEY

Line	Series	Chair Type	Size	Arm Type	Arm Style	Metal Finish
FAE	2M	G	21	O	PA	S
Faeron	Chair	Guest Seating		Open Arm	Polymer Arm	Silver Metallic
			24	S	WA	N
				Semi Closed Arm	Wood Arm	Brushed Nickel
			30	C	SA	
				Closed Arm	Solid Surface Arm	
			44			

HEALTHCARE DISCOUNT APPLIES TO THESE PRODUCTS

# FAERON METAL | GUEST

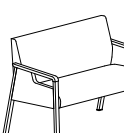
HEALTHCARE DISCOUNT APPLIES TO THESE PRODUCTS

DESCRIPTION/MODEL	COM		COL	FABRIC GRADES			LEATHER		
	1	2	3	4	5	6	7	8	9
 30" Open Polymer Arm, Silver Metallic Frame FAE2M-G30OPAS	1254	1316	1378	1505	1629	1755	1879	2003	2254
	1447	1509	1571	1697	1822	1947	2072	2196	2448
 30" Semi Closed Polymer Arm, Silver Metallic Frame FAE2M-G30SPAS	1643	1728	1811	1980	2147	2317	2485	2654	2989
	1837	1921	2004	2173	2342	2510	2678	2847	3185
 30" Closed Polymer Arm, Silver Metallic Frame FAE2M-G30CPAS	1656	1738	1822	1990	2160	2328	2496	2664	3003
	1849	1932	2016	2186	2354	2523	2690	2859	3195
 44" Open Polymer Arm, Silver Metallic Frame FAE2M-G44OPAS	1556	1634	1713	1870	2029	2186	2343	2502	2816
	1749	1827	1907	2063	2221	2381	2536	2695	3009
 44" Semi Closed Polymer Arm, Silver Metallic Frame FAE2M-G44SPAS	1944	2044	2145	2345	2546	2746	2948	3147	3553
	2138	2239	2340	2539	2741	2942	3142	3343	3745
 44" Closed Polymer Arm, Silver Metallic Frame FAE2M-G44CPAS	1956	2058	2157	2357	2559	2760	2959	3161	3563
	2149	2252	2352	2552	2753	2954	3156	3355	3759

**ORDERING NOTES:**

Faeron Metal chairs can also be specified with a Wood Arm (WA) or a Solid Surface Arm (SA), replace "PA" in the model number with the Arm Style selection below and add the upcharge listed.

**Arm Style Option Upcharges**

**\$ List**

Solid Surface Arm (per pair) - Gr A White	573
Solid Surface Arm (per pair) - Gr A Color	598
Solid Surface Arm (per pair) - Gr B	645
Solid Surface Arm (per pair) - Gr C	678
Beech/Palette Wood Arm (per pair)	215

**PRODUCT CODE KEY**

Line	Series	Chair Type	Size	Arm Type	Arm Style	Metal Finish
FAE Faeron	2M Chair	G Guest Seating	21	O Open Arm	PA Polymer Arm	S Silver Metallic
			24	S Semi Closed Arm	WA Wood Arm	N Brushed Nickel
			30	C Closed Arm	SA Solid Surface Arm	
			44			

## MULTI-PURPOSE SEATING

95	Libra
102	Mobi
106	Karma
116	Corfu
122	Capri
124	Bank of England

# LIBRA | ENVIRONMENTAL SUMMARY

## LEED CI CREDIT



MATERIAL CONTENT:

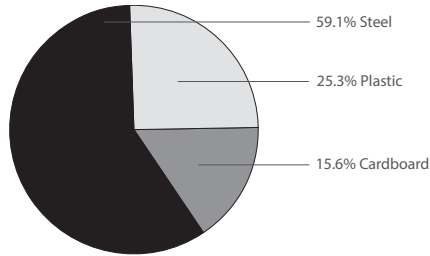

PRE-CONSUMER  
RECYCLED CONTENT = 18.68%

POST-CONSUMER  
RECYCLED CONTENT = 28.64%

Up to 74.71% of this Krug product is recyclable at the end of its useful life.

### CONTRIBUTES TO

CREDIT 2.1 - 2.2	Construction Waste Management	1-2 point(s)
CREDIT 3.3	Resource Reuse	1 point
CREDIT 4.1	Recycled Content	1 point
CREDIT 4.2	Recycled Content	1 point
CREDIT 4.5	Low Emitting Materials, Systems & Seating	1 point
CREDIT 5.1	Regional Materials*	1 point

\*This credit is only applicable if in total 20% of the combined value of the procurement of construction materials and in the furniture are manufactured within a radius of 500 miles. This credit will apply if the installation of the finished product occurs within 500 miles of Kitchener, Ontario.

## level® CERTIFICATION, AIR EMISSIONS AND FSC® CERTIFICATION



### level® CERTIFICATION

BIFMA's e3 Furniture Sustainability Standard is a voluntary, multi-attribute standard that measures the degree of sustainability of furniture. This standard evaluates product and company environmental attributes and compliance systems in a wide range of elements which include Materials, Energy & Atmosphere, Human & Ecosystem Health and Social Responsibility. Krug products have earned level®, BIFMA's sustainability certification program for furniture, certification through third-party verification against the e3 standard.



### AIR EMISSIONS

All Krug products are supplied air-emissions certified. Contact customer service for information.



**FEATURES**



**POLYMER BACK & SEAT**  
Libra chairs feature Black polymer seat and back. The polymer back provides contoured lumbar support and flex for greater comfort. The seat tilts down for the sitting position and flips up when ready to nest the chairs.



**UPHOLSTERED SEAT & BACK**  
Libra chairs are available with upholstered seat and Black polymer back or upholstered seat and back.



**FRAME**  
Metal frame finish is available in Black or Silver Metallic.



**ARMS**  
Libra chairs are available in both Armless and Armed chair styles. Armed chairs feature a fixed, forward-sloping Black polymer armrest.



**GLIDES**  
Libra Black nylon glides are non-adjustable, non-marring and field-replaceable if damaged or degraded.



**CASTERS**  
The twin-wheel casters promote easy storage and repositioning and are also available with a locking option.



**NESTING**  
Libra chairs nest by raising the seat into its upright position, they can be nested with both the book rack and tablet in place.



**REPLACEABLE COMPONENTS**  
Libra is designed to allow major components to be field replaced, providing a very cost effective means to significantly extend the life of the product.

**WEIGHT CAPACITIES**  
Libra has been laboratory tested to meet a weight capacity of 300lbs, for arm and armless versions.

**OPTIONS**



**TABLET**  
Libra swivel folding tablet is available in Black polymer. The tablet is fastened to the left side (facing).



**BOOK RACK**  
The wire book rack is available in Black or Silver Metallic to coordinate with the frame selection. It can conveniently remain in place when the chairs are nested but is also removable without tools if needed.

**COMBINATION UPHOLSTERY COVERS**  
When combination upholstery is with upholstery of the same grade or COM, an upcharge for dual fabrics is **\$33 list** per unit. When graded in combination upholstery is selected, use the highest upholstery grade or contact customer service for a quote. Please provide the fabric specified and a description of where each fabric is to be applied on the product in order to obtain a quote.

**CAL 133 & MOISTURE BARRIER**  
California Technical Bulletin 133 is a flammability test for seating. Krug offers a compliance method which, in combination with non-flammable upholstery covers, may enable the products to meet certification requirements for this test. This process at the same time also provides the products with a Moisture Barrier - a treatment that helps to prevent the passage of liquids and moisture to inside of upholstered components - thereby conferring sanitary and anti-infection benefits. So when CAL 133 is specified, the product also automatically has a Moisture Barrier, and when a Moisture Barrier is specified, the product also features the compliance method and low flammability features of CAL 133. CAL 133 and Moisture Barrier are available for an upcharge of **\$64 list** per yard. The application of this upcharge and the compliance method does not mean that the specific configuration of product and upholstery cover are tested and officially certified as being CAL 133 compliant. If official certification is required, Krug will provide this (through an independent certified testing laboratory) at a charge of \$917 per item, plus the cost of the product to be tested. Lead time for certification testing is typically 4-8 weeks. Krug assumes no responsibility for the testing of our products in combination with upholstery covers, or for the results of any testing conducted. Some specific configurations of product and upholstery have already been tested. Please contact Customer Service for additional information.

# LIBRA | DIMENSIONS & COM REQUIREMENTS

	Overall Width	Overall Depth	Overall Height	Seat Height	Arms From Floor	Between Arms	Seat Depth	Shipping Weight	Cubes
Armless	22	23	33.5	18	n/a	n/a	17.5	25	13
Fixed Arm	25.5	23	33.5	18	26.25	22	17.5	27	13
Tablet Arm	27	24	33.5	18	29	n/a	17.5	35	13

## DIMENSIONS:







All dimensions are in inches and approximate and are subject to change without notice. Contact Customer Service if dimensions are critical. Overall dimensions shown are for chairs with glides. Tablet arm dimensions are with tablet folded down.

## COM Yardage

Seat & Back	1.19
Seat only	0.56
Back only	0.65



# LIBRA | ARMLESS

DESCRIPTION/MODEL	COM		COL			FABRIC GRADES			LEATHER		
	1	2	3	4	5	6	7	8	9		
	Polymer Back & Seat with Glides and Black Frame LIB2111B		434								
	Polymer Back & Seat with Glides and Silver Frame LIB2111S		434								
	Polymer Back & Upholstered Seat with Glides and Black Frame LIB2121B		553	568	583	605	630	652	677	708	739
	Polymer Back & Upholstered Seat with Glides and Silver Frame LIB2121S		553	568	583	605	630	652	677	708	739
	Upholstered Back & Seat with Glides and Black Frame LIB2131B		633	664	699	746	800	847	901	970	1037
	Upholstered Back & Seat with Glides and Silver Frame LIB2131S		633	664	699	746	800	847	901	970	1037
	Polymer Back & Seat with Casters and Black Frame LIB2112B		442								
	Polymer Back & Seat with Casters and Silver Frame LIB2112S		442								
	Polymer Back & Upholstered Seat with Casters and Black Frame LIB2122B		560	574	590	612	637	659	683	715	746
	Polymer Back & Upholstered Seat with Casters and Silver Frame LIB2122S		560	574	590	612	637	659	683	715	746
	Upholstered Back & Seat with Casters and Black Frame LIB2132B		640	672	705	752	807	854	909	976	1044
	Upholstered Back & Seat with Casters and Silver Frame LIB2132S		640	672	705	752	807	854	909	976	1044

**ORDERING NOTES:** To specify casters locking, change the base selection (shown below) from a "2" to a "3".

## LIBRA OPTION UPCHARGES







**\$ List**

CAL 133 & Moisture Barrier (per yard)	64
Removable Wire Basket	76

## PRODUCT CODE KEY

Line	Series	Arm	Style	Base	Finish
LIB	2	1	1	1	B
Libra	Multi-Purpose Seating	Armless	Polymer Back & Seat	Glides	Black
		2	2	2	S
		Fixed Arm	Polymer Back & Upholstered Seat	Casters	Silver
		3	3	3	
		Tablet Arm	Upholstered Back & Seat	Locking Casters	

# LIBRA | FIXED ARM

DESCRIPTION/MODEL	COM		COL			FABRIC GRADES			LEATHER	
	1	2	3	4	5	6	7	8	9	
	Polymer Back & Seat with Glides and Black Frame LIB2211B 505									
	Polymer Back & Seat with Glides and Silver Frame LIB2211S 505									
	Polymer Back & Upholstered Seat with Glides and Black Frame LIB2221B 623 638 654 675 700 722 747 778 809									
	Polymer Back & Upholstered Seat with Glides and Silver Frame LIB2221S 623 638 654 675 700 722 747 778 809									
	Upholstered Back & Seat with Glides and Black Frame LIB2231B 703 735 769 816 870 917 972 1039 1107									
	Upholstered Back & Seat with Glides and Silver Frame LIB2231S 703 735 769 816 870 917 972 1039 1107									
	Polymer Back & Seat with Casters and Black Frame LIB2212B 511									
	Polymer Back & Seat with Casters and Silver Frame LIB2212S 511									
	Polymer Back & Upholstered Seat with Casters and Black Frame LIB2222B 631 644 660 682 707 729 753 785 816									
	Polymer Back & Upholstered Seat with Casters and Silver Frame LIB2222S 631 644 660 682 707 729 753 785 816									
	Upholstered Back & Seat with Casters and Black Frame LIB2232B 710 742 775 823 877 925 979 1046 1114									
	Upholstered Back & Seat with Casters and Silver Frame LIB2232S 710 742 775 823 877 925 979 1046 1114									

**ORDERING NOTES:** To specify casters locking, change the base selection (shown below) from a "2" to a "3".

## LIBRA OPTION UPCHARGES







**\$ List**

CAL 133 & Moisture Barrier (per yard)	64
Removable Wire Basket	76

## PRODUCT CODE KEY

Line	Series	Arm	Style	Base	Finish
LIB	2	1	1	1	B
Libra	Multi-Purpose Seating	Armless	Polymer Back & Seat	Glides	Black
		2	2	2	S
		Fixed Arm	Polymer Back & Upholstered Seat	Casters	Silver
		3	3	3	
		Tablet Arm	Upholstered Back & Seat	Locking Casters	

# LIBRA | TABLET ARM

DESCRIPTION/MODEL	COM			COL			FABRIC GRADES			LEATHER		
	1	2	3	4	5	6	7	8	9			
	Polymer Back & Seat with Glides and Black Frame LIB2311B			625								
	Polymer Back & Seat with Glides and Silver Frame LIB2311S			625								
	Polymer Back & Upholstered Seat with Glides and Black Frame LIB2321B			745	759	774	796	822	844	868	899	931
	Polymer Back & Upholstered Seat with Glides and Silver Frame LIB2321S			745	759	774	796	822	844	868	899	931
	Upholstered Back & Seat with Glides and Black Frame LIB2331B			825	856	890	937	992	1039	1094	1161	1229
	Upholstered Back & Seat with Glides and Silver Frame LIB2331S			825	856	890	937	992	1039	1094	1161	1229
	Polymer Back & Seat with Casters and Black Frame LIB2312B			633								
	Polymer Back & Seat with Casters and Silver Frame LIB2312S			633								
	Polymer Back & Upholstered Seat with Casters and Black Frame LIB2322B			751	766	782	804	828	850	875	907	937
	Polymer Back & Upholstered Seat with Casters and Silver Frame LIB2322S			751	766	782	804	828	850	875	907	937
	Upholstered Back & Seat with Casters and Black Frame LIB2332B			831	864	897	945	999	1046	1100	1168	1235
	Upholstered Back & Seat with Casters and Silver Frame LIB2332S			831	864	897	945	999	1046	1100	1168	1235

**ORDERING NOTES:** To specify casters locking, change the base selection (shown below) from a “2” to a “3”.

## LIBRA OPTION UPCHARGES





**\$ List**

CAL 133 & Moisture Barrier (per yard)	64
Removable Wire Basket	76

## PRODUCT CODE KEY

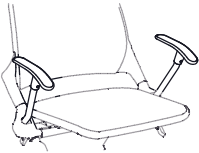
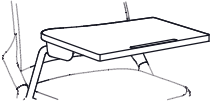
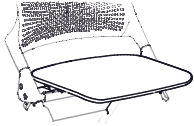
Line	Series	Arm	Style	Base	Finish
LIB	2	1	1	1	B
Libra	Multi-Purpose Seating	Armless	Polymer Back & Seat	Glides	Black
		2	2	2	S
		Fixed Arm	Polymer Back & Upholstered Seat	Casters	Silver
		3	3	3	
		Tablet Arm	Upholstered Back & Seat	Locking Casters	

# LIBRA | REPLACEMENT COMPONENTS

DESCRIPTION/MODEL	COM		COL			FABRIC GRADES				LEATHER		Yds	Weight	Cube
	1	2	3	4	5	6	7	8	9					
 Replacement Fixed Arm (Pair) LIB2-RA2 66												2.5	0.8	
 Replacement Tablet Arm (per arm) LIB2-RA3 159												11.3	2.3	
 Replacement Polymer Seat LIB2-RS1 115												3.8	0.7	
 Replacement Upholstered Seat LIB2-RS2 201 216 232 253 278 300 325 355 387												0.65	5.9	0.7
 Replacement Glides (Set of 4) LIB2-RB1 17												0.2	0.1	
 Replacement Caster (Set of 4) LIB2-RB2 39												0.6	0.1	
 Replacement Locking Caster (Set of 4) LIB2-RB3 39														

**LEED CI CREDITS**



MATERIAL CONTENT:

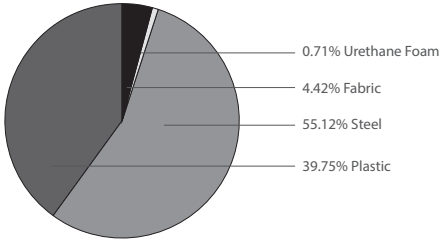

PRE-CONSUMER RECYCLED CONTENT = 13.78%

POST-CONSUMER RECYCLED CONTENT = 14.33%

Up to 55.11% of this Mobi product is recyclable at the end of its useful life.

CONTRIBUTES TO

CREDIT 2.1 - 2.2	Construction Waste Management	1-2 point(s)
CREDIT 3.3	Resource Reuse	1 point
CREDIT 4.1	Recycled Content	1 point
CREDIT 4.2	Recycled Content	1 point
CREDIT 4.5	Low Emitting Materials, Systems & Seating	1 point
CREDIT 5.1	Regional Materials*	1 point

\*This credit is only applicable if in total 20% of the combined value of the procurement of construction materials and in the furniture are manufactured within a radius of 500 miles. This credit will apply if the installation of the finished product occurs within 500 miles of Kitchener, Ontario.

**level® CERTIFICATION & AIR EMISSIONS**



**level® CERTIFICATION**

BIFMA's e3 Furniture Sustainability Standard is a voluntary, multi-attribute standard that measures the degree of sustainability of furniture. This standard evaluates product and company environmental attributes and compliance systems in a wide range of elements which include Materials, Energy & Atmosphere, Human & Ecosystem Health and Social Responsibility. Mobi products have earned level®, BIFMA's sustainability certification program for furniture, certification through third-party verification against the e3 standard.



**AIR EMISSIONS**

All Mobi products are supplied with air emissions-certified materials. Contact customer service for specific test results.

# MOBI | FEATURES, OPTIONS, DIMENSIONS & COM REQUIREMENTS



## ARMS

Arms are available in the full range of polymer colors: Black, White, Grey, Taupe, Yellow, Red, Blue, Green. Please specify when ordering.



## ARMLESS



## POLYMER SEATS & BACKS

Available Polymer colors: White, Grey, Taupe, Yellow, Red, Blue, Green and Black.



## UPHOLSTERED SEATS & BACKS

Optional Removable covers can be quickly installed on Mobi products that were originally ordered with the removable cover option.



## MESH BACKS

Available mesh colors: Grey, Black & White. Please specify when ordering.



## STACKABILITY

Mobi chairs are stackable to a maximum of 8 chairs high on the floor as well as dolly.



## LEGS & GLIDES

Mobi legs are structural steel legs in Polished Chrome with non-marring glides.

## WEIGHT CAPACITY

Mobi has been tested and complies with ANSI/BIFMA x5.1-2011 standards. Mobi has been load tested up to 300lbs.



## CADDIE

The Mobi caddy provides enhanced stackability, along with the ease of movement and storage. It has a durable tubular construction and 4 soft-wheel swivel, locking casters. Its design allows for the stacking and storage of all Krug stackable chairs.



## COMBINATION COLORS

More than one polymer color can be selected in any combination for seats, backs and arms. Please specify when ordering.

## OPTIONS

### REPLACEMENT AND REMOVABLE COMPONENTS

Mobi is designed to allow major components to be field replaced, providing a very cost effective means to significantly extend the life of the product. Mobi Chairs are available with Removable Seat and Removable Back Covers,

### CAL 133 & MOISTURE BARRIER





California Technical Bulletin 133 is a flammability test for seating. Krug offers a compliance method which, in combination with non-flammable upholstery covers, may enable the products to meet certification requirements for this test. This process at the same time also provides the products with a Moisture Barrier - a treatment that helps to prevent the passage of liquids and moisture to inside of upholstered components - thereby conferring sanitary and anti-infection benefits. So when CAL 133 is specified, the product also automatically has a Moisture Barrier, and when a Moisture Barrier is specified, the product also features the compliance method and low flammability features of CAL 133.

The application of this upcharge and the compliance method does not mean that the specific configuration of product and upholstery cover are tested and officially certified as being CAL 133 compliant. If official certification is required, Krug will provide this (through an independent certified testing laboratory) at a charge of \$917 per item, plus the cost of the product to be tested. Lead time for certification testing is typically 4-8 weeks. Krug assumes no responsibility for the testing of our products in combination with upholstery covers, or for the results of any testing conducted. Some specific configurations of product and upholstery have already been tested. Please contact Customer Service for additional information.

## DIMENSIONS & COM REQUIREMENTS

	Overall Width	Overall Depth	Overall Height	Seat Height	Arms From Floor	Between Arms	Seat Depth	Shipping Weight	Cubes	COM YRD
MOB210P	18	21	31	17	n/a	n/a	18.75	21	14	-
MOB211P	21.25	21	31	17	27	20.5	18.75	21	14	-
MOB220P	18	21	31	17	n/a	n/a	18.75	21	14	.63
MOB221P	21.25	21	31	17	27	20.5	18.75	21	14	.63
MOB230P	18	21	31	17	n/a	n/a	18.75	21	14	.63
MOB231P	21.25	21	31	17	27	20.5	18.75	21	14	.63
MOB240P	18	21	31	17	n/a	n/a	18.75	21	14	-
MOB241P	21.25	21	31	17	27	20.5	18.75	21	14	-
MOB250P	18	21	31	17	n/a	n/a	18.75	21	14	1.22
MOB251P	21.25	21	31	17	27	20.5	18.75	21	14	1.22



DESCRIPTION/MODEL	COM		COL	FABRIC GRADES			LEATHER		
	1	2	3	4	5	6	7	8	9
 Polymer Seat and Back, Armless MOB210P	383								
 Polymer Seat and Back, with Arms MOB211P	423								
 Polymer Back and Upholstered Seat, Armless MOB220P	505	529	552	598	646	694	740	789	885
 Polymer Back and Upholstered Seat, with Arms MOB221P	555	576	599	647	695	743	790	837	932
 Mesh Back and Upholstered Seat, Armless MOB230P	513	537	561	610	656	703	752	798	894

**Mobi Option Upcharges**







**\$ List**

CAL 133 & Moisture Barrier (per yard)	64
Removable Seat Covers	71
Removeable Back Covers	71

**PRODUCT CODE KEY**

Line	Series	Chair Style	Arm Style	Metal Finish
MOB	2	1	0	P
Mobi	Multi-Purpose	Polymer Seat & Back	Armless	Polished Chrome
		2	1	
		Polymer Back & Upholstered Seat	Armed	
		3		
		Mesh Back & Upholstered Seat		
		4		
		Mesh Back & Polymer Seat		
		5		
		Fully Upholstered Seat & Back		

# MOBI

DESCRIPTION/MODEL	COM		COL	FABRIC GRADES			LEATHER		
	1	2	3	4	5	6	7	8	9
 Mesh Back and Upholstered Seat, with Arms MOB231P	562	586	611	658	705	753	799	848	942
 Mesh Back and Polymer Seat, Armless MOB240P	392								
 Mesh Back and Polymer Seat, with Arms MOB241P	441								
 Fully Upholstered Seat and Back, Armless MOB250P	611	647	686	761	838	914	989	1065	1220
 Fully Upholstered Seat and Back, with Arms MOB251P	648	687	725	803	877	955	1031	1107	1257
 Caddie DOL6	838								

## Mobi Option Upcharges

## \$ List

CAL 133 & Moisture Barrier (per yard)	64
Removable Seat Covers	71
Removeable Back Covers	71

## PRODUCT CODE KEY

Line	Series	Chair Style	Arm Style	Metal Finish
MOB Mobi	2 Multi-Purpose	1 Polymer Seat & Back	0 Armless	P Polished Chrome
		2 Polymer Back & Upholstered Seat	1 Armed	
		3 Mesh Back & Upholstered Seat		
		4 Mesh Back & Polymer Seat		
		5 Fully Upholstered Seat & Back		

LEED CI CREDITS



MATERIAL CONTENT:

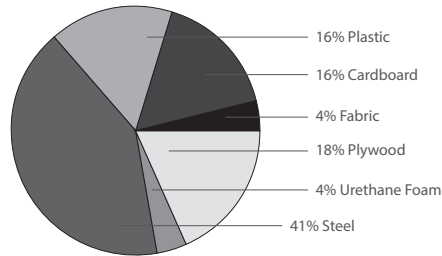

PRE-CONSUMER RECYCLED CONTENT = 5.51%

POST-CONSUMER RECYCLED CONTENT = 24.98%

Up to 73.47% of this Karma product is recyclable at the end of its useful life.

CONTRIBUTES TO

CREDIT 2.1 - 2.2	Construction Waste Management	1-2 point(s)
CREDIT 3.3	Resource Reuse	1 point
CREDIT 4.1	Recycled Content	1 point
CREDIT 4.2	Recycled Content	1 point
CREDIT 4.5	Low Emitting Materials, Systems & Seating	1 point
CREDIT 5.1	Regional Materials*	1 point
CREDIT 7	Certified Wood (MUST BE REQUESTED)	1 point(s)

\*This credit is only applicable if in total 20% of the combined value of the procurement of construction materials and in the furniture are manufactured within a radius of 500 miles. This credit will apply if the installation of the finished product occurs within 500 miles of Kitchener, Ontario.

level® CERTIFICATION, AIR EMISSIONS AND FSC® CERTIFICATION



level® CERTIFICATION

BIFMA's e3 Furniture Sustainability Standard is a voluntary, multi-attribute standard that measures the degree of sustainability of furniture. This standard evaluates product and company environmental attributes and compliance systems in a wide range of elements which include Materials, Energy & Atmosphere, Human & Ecosystem Health and Social Responsibility. Karma products have earned level®, BIFMA's sustainability certification program for furniture, certification through third-party verification against the e3 standard.



The mark of responsible forestry

AIR EMISSIONS

All Karma products are supplied air-emissions certified. Contact customer service for information.

FSC®

In 2005, Krug received Forest Stewardship Council® (FSC®) Chain-of-Custody certification for our manufacturing facilities. The FSC® Chain-of-Custody tracks certified wood from seedling to final sale. It verifies that the material for our FSC® certified products only come from well-managed, FSC®-certified forests and other controlled sources. FSC® is dedicated to the promotion of responsible forest management worldwide helping to take care of forests for future generations. Karma and other Krug products can be specified with FSC® Certification. Contact customer service for further information, pricing and lead times.



Architects, designers, and building professionals can specify FSC®-certified products in order to achieve a point from the U.S. Green Building Council's Leadership in Energy and Environmental Design (LEED) Rating System.

# KARMA | FEATURES & OPTIONS



## DESIGNED FOR COMFORT

The seat features an enhanced standard foam thickness, combined with our proprietary webbing suspension system, to provide superior comfort and a longer life cycle. The back is contoured and angled to provide supportive sitting.



## LIGHT GREY POLYMER BACK

Polypropylene backs are injection molded, with Light Grey pigment diffused throughout the mold, featuring a compound that provides UV resistance to fading and brittleness from exposure to light. Backs have a minimum wall thickness of 5 mm, providing excellent strength and shock resistance.



## WALL SAVER

The angle of the back and the rear legs are designed to keep the back away from the wall, to prevent wear and damage to both the chairs and to the walls of the facility.



## POLYMER ARM

Karma arms are durable, comfortable, and long lasting. They are made with injected polymer that is a solid color throughout the arm and are available in three color options: Black, Grey, Light Grey and Taupe.



## STANDARD GLIDE

Karma's black domed polymer glides are non-adjustable, and field-replaceable if damaged or degraded. Ideal for carpeted flooring.



## STACKING

Karma stacks 7 high on the floor, and 12 chairs on the Caddie. The optional Underseat Cover can be specified to help prevent indenting of seat upholstery on chairs that will be stacked. Karma chairs with the Sled Base option do not stack.



## TANDEM SEATING

Karma chairs, and in-line tables, are designed to be instantly converted to (or ordered as) tandem seating. Armed and armless chairs can be connected -when joining arm chairs the positioning prevents a pinch point between the arms. In-line tables can be configured between chairs or as end tables. And the tandem components can be easily removed to convert to freestanding.



## REPLACEABLE COMPONENTS

Karma is designed to allow major components to be field replaced, providing a very cost effective means to significantly extend the life of the product.

## FRAME COLORS AVAILABLE

The Karma Leg is available in 2 standard finishes; Silver Metallic and Matte Black. Polished Chrome is also available for an upcharge.

## WEIGHT CAPACITIES

Karma has been laboratory tested to meet a weight capacity of 500 lbs, in all versions: arm and armless, and all widths.



## OPTIONS

### SLED BASE OPTION

Optional Sled Base frames are available in Silver Metallic and Matte Black. The integrated steel rail spans between the front and rear legs which are fitted with black nylon glides. Karma chairs with the Sled Base option do not stack.



### UNDERSEAT COVER

As an alternative to the standard dust cover under the seat, this option, in black polymer, closes off the underside of the chair, functioning as a cleanable Splashguard to protect the interior from moisture. It also assists in chair stacking, by distributing the weight to eliminate any indentations in the seat upholstery.



### CASTERS OPTION

Karma features durable low profile 1 1/2" diameter casters in black nylon offering an impressive 500lb load rating. Karma chairs with the caster option do not stack.



### FLOOR SAVER GLIDE

Karma's Floor Saver Glides are a larger, white, nylon glide incorporating a much larger surface area, and is a self-adjusting to help protect LVT, vinyl, tile, or hardwood where risk of marking might occur. Available at a **\$37 list** upcharge.



### NON-SLIP GLIDE

Features a much larger surface area and is also self-adjusting. It also features a softer outer coating to hold and prevent chair from sliding on LVT, vinyl, or tile flooring. Perfect for more slippery/smooth floor areas where prevention of chair movement is required. Available at a **\$37 list** upcharge.



### COMBINATION UPHOLSTERY COVERS

When combination upholstery is with upholstery of the same grade or COM, an upcharge for dual fabrics is **\$33 list** per unit. When graded in combination upholstery is selected, use the highest upholstery grade or contact customer service for a quote. Please provide the fabric specified and a description of where each fabric is to be applied on the product in order to obtain a quote.

### REMOVABLE COVERS & REPLACEMENT COMPONENTS

Optional Removeable covers can be quickly installed on Karma products that were originally ordered with the Removable cover option. Replacement covers can also be installed on Karma products that were not originally ordered with the Removable cover option, with some simple staple removal.

### CAL 133 & MOISTURE BARRIER

California Technical Bulletin 133 is a flammability test for seating. Krug offers a compliance method which, in combination with non-flammable upholstery covers, may enable the products to meet certification requirements for this test. This process at the same time also provides the products with a Moisture Barrier - a treatment that helps to prevent the passage of liquids and moisture to inside of upholstered components - thereby conferring sanitary and anti-infection benefits. See page 333 for more information.







# KARMA | DIMENSIONS & COM REQUIREMENTS

	Overall Width	Overall Depth	Overall Height	Seat Height	Arms From Floor	Between Arms	Seat Depth	Shipping Weight/box			COM YRD	Cubes
								1 Chair	2 Chairs	3 Chairs		
<b>Leg Base Stacking Chair Upholstered</b>												
<b>Armless</b>												
KAR2C-18.5	20.2	21.9	33.9	18	n/a	n/a	17	22.5	41	59.5	1	18
KAR2C-22	23.7	21.9	33.9	18	n/a	n/a	17	24	44	64	1	18
KAR2C-26	27.7	21.9	33.9	18	n/a	n/a	17	25.5	47	68.5	1.7	21
<b>With Arms</b>												
KAR2C-18.5	24.5	21.9	33.9	18	26.8	18.5	17	24	44	64	1	18
KAR2C-22	28	21.9	33.9	18	26.8	22	17	25.5	47	68.5	1	18
KAR2C-26	32	21.9	33.9	18	26.8	26	17	27	50	73	1.7	21
<b>Leg Base Stacking Chair Wood Back</b>												
<b>Armless</b>												
KAR2C-18.5	20.2	21.9	33.9	18	n/a	n/a	17	22.5	41	59.5	0.7	18
KAR2C-22	23.7	21.9	33.9	18	n/a	n/a	17	24	44	64	0.7	18
KAR2C-26	27.7	21.9	33.9	18	n/a	n/a	17	25.5	47	68.5	0.7	21
<b>With Arms</b>												
KAR2C-18.5	24.5	21.9	33.9	18	26.8	18.5	17	24	44	64	0.7	18
KAR2C-22	28	21.9	33.9	18	26.8	22	17	25.5	47	68.5	0.7	18
KAR2C-26	32	21.9	33.9	18	26.8	26	17	27	50	73	0.7	21
<b>Leg Base Stacking Chair Polymer Back</b>												
<b>Armless</b>												
KAR2C-18.5	20.2	21.9	33.9	18	n/a	n/a	17	22.5	41	59.5	n/a	18
<b>With Arms</b>												
KAR2C-18.5	24.5	21.9	33.9	18	26.8	18.5	17	24	44	64	n/a	18
<b>Caster Base Chair Upholstered - With Arms</b>												
KAR2C-18.5	24.5	21.9	33.9	18	26.8	18.5	17	24	44	64	1	18
KAR2C-22	28	21.9	33.9	18	26.8	22	17	25.5	47	68.5	1	18
<b>Caster Base Chair Wood Back - With Arms</b>												
KAR2C-18.5	24.5	21.9	33.9	18	26.8	18.5	17	24	44	64	0.7	18
KAR2C-22	28	21.9	33.9	18	26.8	22	17	25.5	47	68.5	0.7	18
<b>Caster Base Chair Polymer Back - With Arms</b>												
KAR2C-18.5	24.5	21.9	33.9	18	26.8	18.5	17	24	44	64	0.7	18
<b>Sled Base Chair Upholstered</b>												
<b>Armless</b>												
KAR2C-18.5	20.2	21.9	33.9	18	n/a	n/a	17	25.5	-	-	1	18
KAR2C-22	23.7	21.9	33.9	18	n/a	n/a	17	27	-	-	1	18
KAR2C-26	27.7	21.9	33.9	18	n/a	n/a	17	28.5	-	-	1.7	21
<b>With Arms</b>												
KAR2C-18.5	24.5	21.9	33.9	18	26.8	18.5	17	27	-	-	1	18
KAR2C-22	28	21.9	33.9	18	26.8	22	17	28.5	-	-	1	18
KAR2C-26	32	21.9	33.9	18	26.8	26	17	30	-	-	1.7	21
<b>Sled Base Chair Wood Back</b>												
<b>Armless</b>												
KAR2C-18.5	20.2	21.9	33.9	18	n/a	n/a	17	25.5	-	-	0.7	18
KAR2C-22	23.7	21.9	33.9	18	n/a	n/a	17	27	-	-	0.7	18
KAR2C-26	27.7	21.9	33.9	18	n/a	n/a	17	28.5	-	-	0.7	21
<b>With Arms</b>												
KAR2C-18.5	24.5	21.9	33.9	18	26.8	18.5	17	27	-	-	0.7	18
KAR2C-22	28	21.9	33.9	18	26.8	22	17	28.5	-	-	0.7	18
KAR2C-26	32	21.9	33.9	18	26.8	26	17	30	-	-	0.7	21
<b>Sled Base Chair Polymer Back</b>												
<b>Armless</b>												
KAR2C-18.5	20.2	21.9	33.9	18	n/a	n/a	17	25.5	-	-	0.7	18
<b>With Arms</b>												
KAR2C-18.5	24.5	21.9	33.9	18	26.8	18.5	17	27	-	-	0.7	18
Yardage for Individual Components			Back	Seat								
Fabric 18.5"			0.50	0.75								
Fabric 22"			0.50	0.75								
Fabric 26"			0.50	0.75								

## DIMENSIONS:

All dimensions are in inches and approximate and are subject to change without notice. Contact Customer Service if dimensions are critical.

# KARMA | LEG BASE

DESCRIPTION/MODEL	COM		COL	FABRIC GRADES			LEATHER		
	1	2	3	4	5	6	7	8	9
 18.5" Leg Base, Matte Black or Silver Metallic - Upholstered Seat & Polymer Back, No Arm with Standard Dust Cover KAR2C-18.5L_PNAD	450	477	501	540	583	620	662	716	768
18.5" Leg Base, Polished Chrome - Upholstered Seat & Polymer Back, No Arm with Standard Dust Cover KAR2C-18.5LCPNAD	559	586	613	651	694	731	773	825	878
 18.5" Leg Base, Matte Black or Silver Metallic - Fully Upholstered, No Arm with Standard Dust Cover KAR2C-18.5L_UNAD	486	513	538	576	619	656	697	751	805
18.5" Leg Base, Polished Chrome - Fully Upholstered, No Arm, and Standard Dust Cover KAR2C-18.5LCUNAD	596	622	648	687	730	766	808	861	914
 18.5" Leg Base, Matte Black or Silver Metallic - Upholstered Seat & Wood Back, No Arm with Standard Dust Cover KAR2C-18.5L_WNAD	518	535	546	565	588	605	627	655	680
18.5" Leg Base, Polished Chrome - Upholstered Seat & Wood Back, No Arm with Standard Dust Cover KAR2C-18.5LCWNAD	630	644	658	676	697	716	738	765	793
 18.5" Leg Base, Matte Black or Silver Metallic - Upholstered Seat & Polymer Back, with Arm and Standard Dust Cover KAR2C-18.5L_PA_D	487	513	541	580	620	658	701	753	807
18.5" Leg Base, Polished Chrome - Upholstered Seat & Polymer Back, with Arm and Standard Dust Cover KAR2C-18.5LCPA_D	599	625	652	690	731	768	810	866	917
 18.5" Leg Base, Matte Black or Silver Metallic - Fully Upholstered, with Arm and Standard Dust Cover KAR2C-18.5L_UA_D	522	548	577	615	656	694	737	789	843
18.5" Leg Base, Polished Chrome - Fully Upholstered, with Arm and Standard Dust Cover KAR2C-18.5LCUA_D	634	661	688	725	766	805	846	900	954
 18.5" Leg Base, Matte Black or Silver Metallic - Upholstered Seat & Wood Back, with Arm and Standard Dust Cover KAR2C-18.5L_WA_D	547	562	576	595	617	634	656	685	710
18.5" Leg Base, Polished Chrome - Upholstered Seat & Wood Back, with Arm and Standard Dust Cover KAR2C-18.5LCWA_D	659	673	687	705	727	744	766	794	821

**ORDERING NOTES:** When selecting Frame Color and Arm Style please see Product Code Key below.

## Karma Option Upcharges







### \$ List

CAL 133 & Moisture Barrier (per yard)	64
Removable Seat Covers	71
Removable Back Covers	71
Polymer Underseat Shroud 18.5"	47
Combination Upholstery - dual fabrics	33

## PRODUCT CODE KEY

Line	Series	Frame Size	Frame Color	Style	Arm Style	Underseat Shroud
<b>KAR</b>	<b>2C</b>	<b>18.5L</b>	<b>B</b>	<b>U</b>	<b>NA</b>	<b>S</b>
Karma	Stacking Chair	18.5" Leg Base	Matte Black	Fully Upholstered	No Arm	Polymer Shroud
			<b>S</b>	<b>W</b>	<b>AB</b>	<b>D</b>
			Silver Metallic	Beech Wood Back	Black	Standard Dust Cover
			<b>C</b>	<b>P</b>	<b>AG</b>	
			Polished Chrome	Polymer Back	Grey	
					<b>ALG</b>	
					Light Grey	
					<b>AT</b>	
					Taupe	

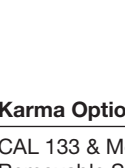
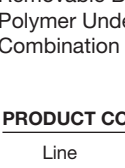
# KARMA | LEG BASE

DESCRIPTION/MODEL	COM		COL		FABRIC GRADES			LEATHER		
	1	2	3	4	5	6	7	8	9	
	22" Leg Base, Matte Black or Silver Metallic - Fully Upholstered, No Arm with Standard Dust Cover									
	KAR2C-22L_UNAD	529	555	582	618	659	696	739	793	845
	22" Leg Base, Polished Chrome - Fully Upholstered, No Arm, and Standard Dust Cover									
	KAR2C-22LCUNAD	662	688	715	752	794	832	873	928	981
	22" Leg Base, Matte Black or Silver Metallic - Upholstered Seat & Wood back, No Arm with Standard Dust Cover									
	KAR2C-22L_WNAD	567	582	595	614	634	654	674	701	729
	22" Leg Base, Polished Chrome - Upholstered Seat & Wood back, No Arm with Standard Dust Cover									
	KAR2C-22LCWNAD	702	715	730	747	768	786	809	835	864
	22" Leg Base, Matte Black or Silver Metallic - Fully Upholstered, with Arm and Standard Dust Cover									
	KAR2C-22L_U_D	564	591	618	655	697	733	778	830	883
	22" Leg Base, Polished Chrome - Fully Upholstered, with Arm and Standard Dust Cover									
	KAR2C-22LCU_D	699	727	752	789	833	869	912	962	1017
	22" Leg Base, Matte Black or Silver Metallic- Upholstered Seat & Wood back, with Arm and Standard Dust Cover									
	KAR2C-22L_W_D	596	610	622	642	664	680	703	730	757
	22" Leg Base, Polished Chrome - Upholstered Seat & Wood back, with Arm and Standard Dust Cover									
	KAR2C-22LCW_D	731	743	759	778	798	816	838	865	890

**ORDERING NOTES:** When selecting Frame Color and Arm Style please see Product Code Key below. Karma chairs all include the Standard Dust Cover ("D"), for optional Polymer Shroud change "D" to "S" and add upcharge listed below.







## Karma Option Upcharges \$ List

CAL 133 & Moisture Barrier (per yard)	64
Removable Seat Covers	71
Removable Back Covers	71
Polymer Underseat Shroud 22"	63
Combination Upholstery - dual fabrics	33

## PRODUCT CODE KEY

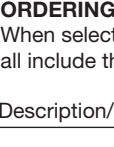
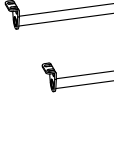
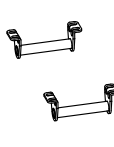

Line	Series	Frame Size	Frame Color	Style	Arm Style	Underseat Shroud
<b>KAR</b>	<b>2C</b>	<b>22L</b>	<b>B</b>	<b>U</b>	<b>NA</b>	<b>S</b>
Karma	Stacking Chair	22" Leg Base	Matte Black	Fully Upholstered	No Arm	Polymer Shroud
			<b>S</b>	<b>W</b>	<b>AB</b>	<b>D</b>
			Silver Metallic	Beech Wood Back	Black	Standard Dust Cover
			<b>C</b>		<b>AG</b>	
			Polished Chrome		Grey	
					<b>ALG</b>	
					Light Grey	
					<b>AT</b>	
					Taupe	

# KARMA | LEG BASE

DESCRIPTION/MODEL	COM		COL			FABRIC GRADES			LEATHER	
	1	2	3	4	5	6	7	8	9	
	26" Leg Base, Matte Black or Silver Metallic - Fully Upholstered, Armless with Standard Dust Cover									
	KAR2C-26L_UNAD	632	680	733	806	887	958	1039	1141	1244
	26" Leg Base, Polished Chrome - Fully Upholstered, Armless, with Standard Dust Cover									
	KAR2C-26LCUNAD	767	819	870	941	1022	1094	1177	1279	1380
	26" Leg Base, Matte Black or Silver Metallic - Upholstered Seat & Wood back, Armless, with Standard Dust Cover									
	KAR2C-26L_WNAD	651	674	697	732	768	805	843	889	937
	26" Leg Base, Polished Chrome - Upholstered Seat & Wood back, Armless, with Standard Dust Cover									
	KAR2C-26LCWNAD	785	810	834	869	906	940	979	1027	1072
	26" Leg Base, Matte Black or Silver Metallic - Fully Upholstered, with Arm and Standard Dust Cover									
	KAR2C-26L_U_D	669	721	769	843	924	995	1080	1179	1283
	26" Leg Base, Polished Chrome - Fully Upholstered, with Arm and Standard Dust Cover									
	KAR2C-26LCU_D	806	856	908	979	1061	1134	1213	1315	1419
	26" Leg Base, Matte Black or Silver Metallic- Upholstered Seat & Wood back, with Arm and Standard Dust Cover									
	KAR2C-26L_W_D	678	703	727	761	798	833	871	917	963
	26" Leg Base, Polished Chrome - Upholstered Seat & Wood back, with Arm and Standard Dust Cover									
	KAR2C-26LCW_D	815	840	864	896	934	968	1008	1056	1102

## ORDERING NOTES:

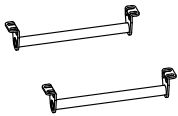
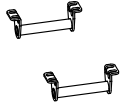
When selecting Frame Color and Arm Style please see Product Code Key below. See following page for additional options. Karma chairs all include the Standard Dust Cover ("D"), for optional Polymer Shroud change "D" to "S" and add upcharge listed on page 112.





Description/Model	Price
	Tandem Seating Bracket -Matte Black (for armed chair) KAR2C-GB BA 80
	Tandem Seating Bracket- Silver Metallic (for armed chair) KAR2C-GB BSA 80
	Tandem Seating Bracket- Polished Chrome (for armed chair) KAR2C-GB BCA 91
	Tandem Seating Bracket-Matte Black (for chairs without arms) KAR2C-GB BNA 71
	Tandem Seating Bracket- Silver Metallic (for chairs without arms) KAR2C-GB BSNA 71
	Tandem Seating Bracket- Polished Chrome (for chairs without arms) KAR2C-GB BCNA 81
	Caddie DOL6 838

## PRODUCT CODE KEY

Line	Series	Frame Size	Frame Color	Style	Arm Style	Underseat Shroud
<b>KAR</b> Karma	<b>2C</b> Stacking Chair	<b>26L</b> 26" Leg Base	<b>B</b> Matte Black	<b>U</b> Fully Upholstered	<b>NA</b> No Arm	<b>S</b> Polymer Shroud
			<b>S</b> Silver Metallic	<b>W</b> Beech Wood Back	<b>AB</b> Black	<b>D</b> Standard Dust Cover
			<b>C</b> Polished Chrome		<b>AG</b> Grey	
					<b>ALG</b> Light Grey	
					<b>AT</b> Taupe	



# KARMA | CASTER BASE

DESCRIPTION/MODEL	COM		COL			FABRIC GRADES			LEATHER	
	1	2	3	4	5	6	7	8	9	
 18.5" Caster Base, Silver Metallic - Upholstered Seat & Polymer Back, with Arm with Standard Dust Cover KAR2CS-18.5MSP_D	571	598	625	662	703	741	783	835	890	
 18.5" Caster Base, Silver Metallic - Fully Upholstered, with Arm and Standard Dust Cover KAR2CS-18.5MSU_D	606	633	661	697	739	778	820	871	927	
 18.5" Caster Base, Silver Metallic - Upholstered Seat & Wood back, with Arm and Standard Dust Cover KAR2CS-18.5MSW_D	632	645	659	677	699	717	739	766	793	
 22" Caster Base, Silver Metallic - Fully Upholstered, with Arm and Standard Dust Cover KAR2C-22MSU_D	646	674	701	738	781	816	859	913	963	
 22" Caster Base, Silver Metallic- Upholstered Seat & Wood back, with Arm and Standard Dust Cover KAR2C-22MSW_D	678	691	706	723	746	764	785	811	840	

**ORDERING NOTES:** When selecting Arm Style please see Product Code Key below.  
Karma chairs all include the Standard Dust Cover ("D"), for optional Polymer Shroud change "D" to "S" and add upcharge listed below.

## Karma Option Upcharges



## \$ List

CAL 133 & Moisture Barrier (per yard)	64
Removable Seat Covers	71
Removable Back Covers	71
Polymer Underseat Shroud 18.5"	47
Polymer Underseat Shroud 22"	63
Polymer Underseat Shroud 26"	80
Combination Upholstery - dual fabrics	33

## PRODUCT CODE KEY

Line	Series	Frame Size	Frame Color	Style	Arm Style	Underseat Shroud
<b>KAR</b> Karma	<b>2C</b> Stacking Chair	<b>18.5M</b> 18.5" Caster Base <b>22M</b> 22" Caster Base	<b>S</b> Silver Metallic	<b>U</b> Fully Upholstered <b>W</b> Beech Wood Back <b>P</b> Polymer Back	<b>AB</b> Black <b>AG</b> Grey <b>ALG</b> Light Grey <b>AT</b> Taupe	<b>S</b> Polymer Shroud <b>D</b> Standard Dust Cover

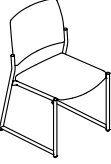
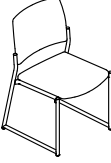
# KARMA | SLED BASE

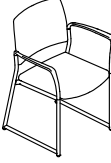
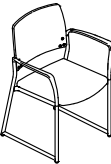
DESCRIPTION/MODEL	COM		COL		FABRIC GRADES			LEATHER	
	1	2	3	4	5	6	7	8	9
 18.5" Sled Base, Matte Black or Silver Metallic - Upholstered Seat & Polymer Back, No Arm with Standard Dust Cover KAR2C-18.5S_PNAD	586	600	614	632	655	672	694	721	747
 18.5" Sled Base, Matte Black or Silver Metallic - Fully Upholstered, No Arm with Standard Dust Cover KAR2C-18.5S_UNAD	622	635	649	667	690	707	730	757	783
 18.5" Sled Base, Matte Black or Silver Metallic - Upholstered Seat & Wood back, No Arm with Standard Dust Cover KAR2C-18.5S_WNAD	658	672	686	703	725	743	765	793	820
 18.5" Sled Base, Matte Black or Silver Metallic - Upholstered Seat & Polymer Back, No Arm with Standard Dust Cover KAR2C-18.5S_P_D	626	652	679	718	759	796	838	892	945
 18.5" Sled Base, Matte Black or Silver Metallic - Fully Upholstered, with Arm and Standard Dust Cover KAR2C-18.5S_U_D	662	688	716	753	794	832	873	928	981
 18.5" Sled Base, Matte Black or Silver Metallic - Upholstered Seat & Wood back, with Arm and Standard Dust Cover KAR2C-18.5S_W_D	687	701	715	732	754	771	794	822	848

**ORDERING NOTES:** When selecting Frame Color and Arm Style please see Product Code Key below.  
Karma chairs all include the Standard Dust Cover ("D"), for optional Polymer Shroud change "D" to "S" and add up-charge listed below.

### Karma Option Upcharges



### \$ List

CAL 133 & Moisture Barrier (per yard)	64
Removable Seat Covers	71
Removable Back Covers	71
Polymer Underseat Shroud 18.5"	47
Combination Upholstery - dual fabrics	33

### PRODUCT CODE KEY

Line	Series	Frame Size	Frame Color	Style	Arm Style	Underseat Shroud
<b>KAR</b>	<b>2C</b>	<b>18.5S</b>	<b>B</b>	<b>U</b>	<b>NA</b>	<b>S</b>
Karma	Chair	18.5" Sled Base	Matte Black	Fully Upholstered	No Arm	Polymer Shroud
			<b>S</b>	<b>W</b>	<b>AB</b>	<b>D</b>
			Silver Metallic	Beech Wood Back	Black	Standard Dust Cover
				<b>P</b>	<b>AG</b>	
				Polymer Back	Grey	
					<b>ALG</b>	
					Light Grey	
					<b>AT</b>	
					Taupe	

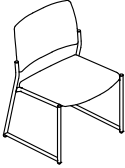
# KARMA | SLED BASE

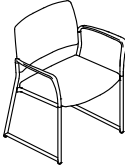
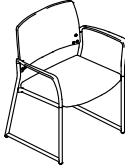
DESCRIPTION/MODEL	COM		COL	FABRIC GRADES			LEATHER		
	1	2	3	4	5	6	7	8	9
 22" Sled Base, Matte Black or Silver Metallic - Fully Upholstered, No Arm with Standard Dust Cover KAR2C-22S_UNAD	665	691	719	756	796	834	877	931	983
 22" Sled Base, Matte Black or Silver Metallic - Upholstered Seat & Wood back, No Arm with Standard Dust Cover KAR2C-22S_WNAD	705	719	732	752	771	791	811	838	866
 22" Sled Base, Matte Black or Silver Metallic - Fully Upholstered, with Arm and Standard Dust Cover KAR2C-22S_U_D	702	730	756	793	835	871	914	968	1019
 22" Sled Base, Matte Black or Silver Metallic- Upholstered Seat & Wood back, with Arm and Standard Dust Cover KAR2C-22S_W_D	733	746	761	780	803	820	842	868	895

**ORDERING NOTES:** When selecting Frame Color and Arm Style please see Product Code Key below. Karma chairs all include the Standard Dust Cover ("D"), for optional Polymer Shroud change "D" to "S" and add upcharge listed below.

## Karma Option Upcharges \$ List

CAL 133 & Moisture Barrier (per yard)	64
Removable Seat Covers	71
Removable Back Covers	71
Polymer Underseat Shroud 22"	63
Combination Upholstery - dual fabrics	33

## PRODUCT CODE KEY

Line	Series	Frame Size	Frame Color	Style	Arm Style	Underseat Shroud
KAR	2C	22S	B	U	NA	S
Karma	Chair	22" Sled Base	Matte Black	Fully Upholstered	No Arm	Polymer Shroud
			S	W	AB	D
			Silver Metallic	Beech Wood Back	Black	Standard Dust Cover
					AG	
					Grey	
					ALG	
					Light Grey	
					AT	
					Taupe	

# KARMA | SLED BASE

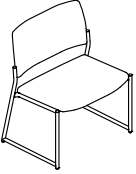
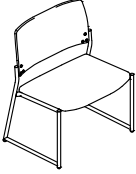
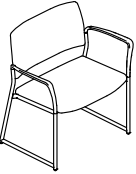
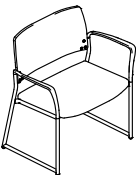
DESCRIPTION/MODEL	COM		COL		FABRIC GRADES			LEATHER		
	1	2	3	4	5	6	7	8	9	
 26" Sled Base, Matte Black or Silver Metallic - Fully Upholstered, Armless with Standard Dust Cover KAR2C-26S_UNAD	768	820	871	942	1026	1095	1178	1281	1381	
 26" Sled Base, Matte Black or Silver Metallic - Upholstered Seat & Wood back, Armless, with Standard Dust Cover KAR2C-26S_WNAD	789	811	835	870	908	941	981	1029	1074	
 26" Sled Base, Matte Black or Silver Metallic - Fully Upholstered, with Arm and Standard Dust Cover KAR2C-26S_U_D	807	859	909	981	1062	1135	1216	1316	1420	
 26" Sled Base, Matte Black or Silver Metallic- Upholstered Seat & Wood back, with Arm and Standard Dust Cover KAR2C-26S_W_D	816	842	865	898	935	971	1009	1058	1103	

**ORDERING NOTES:** When selecting Frame Color and Arm Style please see Product Code Key below. Karma chairs all include the Standard Dust Cover ("D"), for optional Polymer Shroud change "D" to "S" and add upcharge listed below.

## Karma Option Upcharges

### \$ List

CAL 133 & Moisture Barrier (per yard)	64
Removable Seat Covers	71
Removable Back Covers	71
Polymer Underseat Shroud 26"	80
Combination Upholstery - dual fabrics	33

## PRODUCT CODE KEY

Line	Series	Frame Size	Frame Color	Style	Arm Style	Underseat Shroud
<b>KAR</b>	<b>2C</b>	<b>26S</b>	<b>B</b>	<b>U</b>	<b>NA</b>	<b>S</b>
Karma	Chair	26" Sled Base	Matte Black	Fully Upholstered	No Arm	Polymer Shroud
			<b>S</b>	<b>W</b>	<b>AB</b>	<b>D</b>
			Silver Metallic	Beech Wood Back	Black	Standard Dust Cover
					<b>AG</b>	
					Grey	
					<b>ALG</b>	
					Light Grey	
					<b>AT</b>	
					Taupe	

LEED CI CREDITS

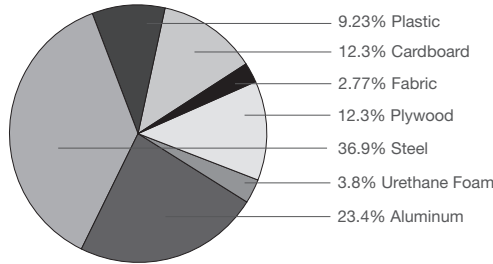

PRE-CONSUMER  
RECYCLED CONTENT = 26.34%

POST-CONSUMER  
RECYCLED CONTENT = 22.74

Up to 55.38% of this Corfu product is recyclable at the end of its useful life.

(COR2-61S)

CONTRIBUTES TO

CREDIT 2.1 - 2.2	Construction Waste Management	1-2 point(s)
CREDIT 3.3	Resource Reuse	1 point
CREDIT 4.1	Recycled Content	1 point
CREDIT 4.2	Recycled Content	1 point
CREDIT 4.5	Low Emitting Materials, Systems & Seating	1 point
CREDIT 5.1	Regional Materials*	1 point
CREDIT 7	Certified Wood (MUST BE REQUESTED)	1 point(s)

\*This credit is only applicable if in total 20% of the combined value of the procurement of construction materials and in the furniture are manufactured within a radius of 500 miles. This credit will apply if the installation of the finished product occurs within 500 miles of Kitchener, Ontario.

level® CERTIFICATION, AIR EMISSIONS AND FSC® CERTIFICATION



**level® CERTIFICATION**

BIFMA's e3 Furniture Sustainability Standard is a voluntary, multi-attribute standard that measures the degree of sustainability of furniture. This standard evaluates product and company environmental attributes and compliance systems in a wide range of elements which include Materials, Energy & Atmosphere, Human & Ecosystem Health and Social Responsibility. Corfu products have earned level®, BIFMA's sustainability certification program for furniture, certification through third-party verification against the e3 standard.

**AIR-EMISSIONS**

All Corfu products are supplied with air-emissions certified. Contact customer service for information.



**FSC®**

In 2005, Krug received Forest Stewardship Council® (FSC®) Chain-of-Custody certification for our manufacturing facilities. The FSC® Chain-of-Custody tracks certified wood from seedling to final sale. It verifies that the material for our FSC® certified products only come from well-managed, FSC®-certified forests and other controlled sources. FSC® is dedicated to the promotion of responsible forest management worldwide helping to take care of forests for future generations. Corfu and other Krug products can be specified with FSC® Certification. Contact customer service for further information, pricing and lead times.



Architects, designers, and building professionals can specify FSC®-certified products in order to achieve a point from the U.S. Green Building Council's Leadership in Energy and Environmental Design (LEED) Rating System.

## CORFU | FEATURES & OPTIONS



### SUSTAINABLE DESIGN

Corfu is made with recycled materials, with an overall recycled content of 40%. Many of these same materials are also recyclable. Corfu is air emissions certified.



### STEEL FRAME

Corfu seating is built with high strength steel castings and extrusions. Finish options are Silver Metallic and Polished Chrome.



### UNDER SEAT COVER

Each Corfu includes an underseat system for stacking: a grey polypropylene seat pan that nests into the seat below and protects it from the frame above. It also provides for easy cleaning and maintenance by covering the underside of the chair.



### PLASTIC COMPONENTS

Polypropylene seats, backs and other components are injection molded, with pigment diffused throughout the mold, and featuring a compound that provides UV resistance to fading and brittleness from exposure to light. Seats and backs have a minimum wall thickness of 5 mm, providing excellent strength and shock resistance. Corfu (Plastic Seat & Back) is available in six different colors. Please specify a color when ordering.

Color Selection:

White, Black, Grey, Red, Blue, Sand



### WOOD FINISH

Krug's Enduraguard™ finish is a catalyzed conversion varnish topcoat, combined with a vinyl polymer-based sealer, that in independent testing has been shown to have exceptional durability characteristics in its resistance to scratching, marring, and degradation from cleaning materials and other substances.



### BEECH PLYWOOD

Wood seats and backs are made with European Beech hardwood veneers, featuring nine (9) plies of cross grain for added strength and durability.



### STACKING

Corfu chairs are stackable, to a maximum of 13 chairs for the wood or plastic versions, and 10 chairs for the upholstered version, when stacked on the Corfu caddie. Corfu chairs are stackable to a maximum of 9 chairs for the wood or plastic versions and 6 chairs for the upholstered version when stacked on the floor. The upholstered versions stack to a height of 74" in the armless version, and 76" with arms. The non-upholstered versions stack to a height of 70" in the armless version and 72" in the version with arms.

### CADDIE

The Corfu caddie provides enhanced stackability, along with the ease of movement and storage. Its design allows for the stacking and storage of all Krug stackable chairs. It has a durable tubular construction and 4 soft-wheel swivel, locking casters. This caddie is designed to stack and transport Krug's other stacking chairs.

### GANGING

Corfu can be ordered with the option of ganging for the upcharge of **\$33 list** per chair. Please specify ganging when ordering.

### PACKAGING

Corfu packaging features recycled, recyclable cardboard. The arm and armless chairs are shipped 4 units per carton.

## OPTIONS

### COMBINATION UPHOLSTERY COVERS

When combination upholstery is with upholstery of the same grade or COM, an upcharge for dual fabrics is **\$33 list** per unit. When graded in combination upholstery is selected, use the highest upholstery grade or contact customer service for a quote. Please provide the fabric specified and a description of where each fabric is to be applied on the product in order to obtain a quote.

### CAL 133 & MOISTURE BARRIER

California Technical Bulletin 133 is a flammability test for seating. Krug offers a compliance method which, in combination with non-flammable upholstery covers, may enable the products to meet certification requirements for this test. This process at the same time also provides the products with a Moisture Barrier - a treatment that helps to prevent the passage of liquids and moisture to inside of upholstered components - thereby conferring sanitary and anti-infection benefits. So when CAL 133 is specified, the product also automatically has a Moisture Barrier, and when a Moisture Barrier is specified, the product also features the compliance method and low flammability features of CAL 133. CAL 133 and Moisture Barrier are available for an upcharge of **\$64 list** per yard. The application of this upcharge and the compliance method does not mean that the specific configuration of product and upholstery cover are tested and officially certified as being CAL 133 compliant. If official certification is required, Krug will provide this (through an independent certified testing laboratory) at a charge of \$917 per item, plus the cost of the product to be tested. Lead time for certification testing is typically 4-8 weeks. Krug assumes no responsibility for the testing of our products in combination with upholstery covers, or for the results of any testing conducted. Some specific configurations of product and upholstery have already been tested. Please contact Customer Service for additional information.

## DIMENSIONS

	Overall Width	Overall Depth	Overall Height	Seat Height	Height of Arms from Floor	Width Between Arms	Seat Depth	Shipping Weights & Cubes			
								1 unit W C	2 units W C	3 units W C	4 units W C
COR2-10S	20.87	20.87	32.28	17.5	n/a	n/a	17	28 16	46 17	65 18	83 20
COR2-10C	20.87	20.87	32.28	17.5	n/a	n/a	17				
COR2-11S	23.23	20.87	32.28	17.5	26.75	21.25	17	30 16	51 17	73 18	93 20
COR2-11C	23.23	20.87	32.28	17.5	26.75	21.25	17				
COR2-20S	20.87	20.87	32.28	17.5	n/a	n/a	17	30 16	51 17	73 18	94 20
COR2-20C	20.87	20.87	32.28	17.5	n/a	n/a	17				
COR2-21S	23.23	20.87	32.28	17.5	26.75	21.25	17	36 16	63 17	92 18	119 20
COR2-21C	23.23	20.87	32.28	17.5	26.75	21.25	17				
COR2-30S	20.87	20.87	32.28	17.5	n/a	n/a	17	31 16	52 17	75 18	97 20
COR2-30C	20.87	20.87	32.28	17.5	n/a	n/a	17				
COR2-31S	23.23	20.87	32.28	17.5	26.75	21.25	17	33 16	57 17	83 18	106 20
COR2-31C	23.23	20.87	32.28	17.5	26.75	21.25	17				
COR2-40S	20.87	20.87	32.28	17.5	n/a	n/a	17	31 16	52 17	75 18	97 20
CORS-40C	20.87	20.87	32.28	17.5	n/a	n/a	17				
COR2-41S	23.23	20.87	32.28	17.5	26.75	21.25	17	33 16	57 17	83 18	106 20
COR2-41C	23.23	20.87	32.28	17.5	26.75	21.25	17				
COR2-50S	20.87	20.87	32.28	17.5	n/a	n/a	17	29 16	48 17	69 18	89 20
COR2-50C	20.87	20.87	32.28	17.5	n/a	n/a	17				
COR2-51S	23.23	20.87	32.28	17.5	26.75	21.25	17	32 16	54 17	77 18	99 20
COR2-51C	23.23	20.87	32.28	17.5	26.75	21.25	17				
COR2-60S	20.87	20.87	32.28	17.5	n/a	n/a	17	31 16	52 17	75 18	97 20
COR2-60C	20.87	20.87	32.28	17.5	n/a	n/a	17				
COR2-61S	23.23	20.87	32.28	17.5	26.75	21.25	17	33 16	57 17	82 18	106 20
COR2-61C	23.23	20.87	32.28	17.5	26.75	21.25	17				
COR6	24	31	15.75								

## COM REQUIREMENTS

	COM Yardage Seat Pad Only	Yardage Per Chair - Seat Pad Only	COM Yardage Fully Upholstered Seat Only	Yardage Per Chair - Fully Upholstered Seat Only	COM Yardage Seat & Back Pads	Yardage Per Chair - Seat & Back Pads	COM Yardage Fully Upholstered Seat & Back	Yardage Per Chair - Fully Upholstered Seat & Back
One Chair	0.7	0.7	0.7	0.7	0.7	0.7	1	1
Two Chair	0.7	0.35	0.7	0.35	1.1	0.55	1.7	0.85
Three Chair	1.4	0.47	1.4	0.47	1.8	0.6	2.7	0.9
Four Chair	1.4	0.35	1.4	0.35	2.2	0.55	3.4	0.85

Note: Some vinyls, leathers & upholsteries are not suitable on Corfu seating.









The approval process is as follows:

1. A sample of the COM must be provided to Krug Customer Service prior to or at the time of order.
2. The sample will be reviewed and the customer advised if the upholstery cover is unsuitable.
3. The COM upholstery cover or leather will be inspected when received at the factory, to identify any further concerns with its suitability.

## WEIGHT CAPACITY

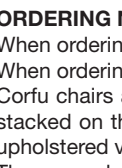
Corfu has been tested and complies with ANSI/BIFMA x5.1-2011 standards. Corfu has been load tested up to 350lbs.

# CORFU | MULTI-PURPOSE SEATING

DESCRIPTION/MODEL	COM		COL	FABRIC GRADES			LEATHER		
	1	2	3	4	5	6	7	8	9
	Plastic Seat & Back, Armless, with Silver Metallic Frame								
	COR2-10S	491							
	Plastic Seat & Back, Armless, with Polished Chrome Frame								
	COR2-10C	556							
	Plastic Seat & Back, Plastic Arms, with Silver Metallic Frame								
	COR2-11S	569							
	Plastic Seat & Back, Polished Aluminum Arms, with Polished Chrome Frame								
	COR2-11C	624							
	Plastic Seat & Back with Upholstered Pads, Armless, with Silver Metallic Frame								
	COR2-20S	658	693	727	761	796	832	866	900
	Plastic Seat & Back with Upholstered Pads, Armless, with Polished Chrome Frame								
	COR2-20C	721	756	789	823	859	894	929	961
	Plastic Seat & Back with Upholstered Pads, Plastic Arms, with Silver Metallic Frame								
	COR2-21S	737	769	806	840	875	910	943	979
	Plastic Seat & Back with Upholstered Pads, Polished Aluminum Arms, with Polished Chrome Frame								
	COR2-21C	791	827	861	895	930	963	1001	1034

## ORDERING NOTES:

When ordering the Silver Metallic frame with Plastic Seat and Back, the arm color matches the seat and back.

When ordering the Polished Chrome frame, arms are Polished Aluminum.

Corfu chairs are stackable, to a maximum of 13 chairs for the wood or plastic versions, and 10 chairs for the upholstered version, when stacked on the Corfu caddie. Corfu chairs are stackable to a maximum of 9 chairs for the wood or plastic versions and 6 chairs for the upholstered version when stacked on the floor. The upholstered versions stack to a height of 74" in the armless version, and 76" with arms. The non-upholstered versions stack to a height of 70" in the armless version and 72" in the version with arms.

Ganging is optional on all Corfu Multi-purpose seating for an upcharge of **\$33 list** per chair, please specify on order.







CAL 133 and Moisture Barrier options are available for an upcharge of **\$64 list per yard**.

## PRODUCT CODE KEY

Line	Series	Chair Style	Arm Style	Frame Finish
<b>COR</b>	<b>2</b> Multi-Purpose	<b>1</b> Plastic Seat & Back	<b>0</b> Armless	<b>S</b> Silver Metallic
		<b>2</b> Plastic with Upholstered Seat & Back Pads	<b>1</b> Arms	<b>C</b> Polished Chrome
		<b>3</b> Wood Seat & Back		
		<b>4</b> Fully Upholstered Seat & Back		
		<b>5</b> Plastic Back, Plastic Seat with Upholstered Pad		
		<b>6</b> Wood Back, Fully Upholstered Seat		

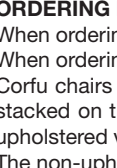

# CORFU | MULTI-PURPOSE SEATING

DESCRIPTION/MODEL	SPECIES	COM		COL		FABRIC GRADES		LEATHER		
		1	2	3	4	5	6	7	8	9
										
	Plastic Back, Plastic Seat with Upholstered Pad, Armless, with Silver Metallic Frame COR2-50S		610 633	658 679	705 729	752 777	799			
										
	Plastic Back, Plastic Seat with Upholstered Pad, Armless, with Polished Chrome Frame COR2-50C		673 696	721 743	767 791	815 838	864			
										
	Plastic Back, Plastic Seat with Upholstered Pad, Plastic Arms with Silver Metallic Frame COR2-51S		689 711	737 760	783 807	832 853	878			
										
	Plastic Back, Plastic Seat with Upholstered Pad, Polished Aluminum Arms, with Polished Chrome Frame COR2-51C		743 767	791 815	838 864	886 910	932			
										
	Wood Seat & Back, Armless, with Silver Metallic Frame COR2-30S Beech		711							
										
	Wood Seat & Back, Armless, with Polished Chrome Frame COR2-30C Beech		783							
										
	Wood Seat & Back, Silver Metallic Arms, with Silver Metallic Frame COR2-31S Beech		853							
										
	Wood Seat & Back, Polished Aluminum Arms, with Polished Chrome Frame COR2-31C Beech		941							

## ORDERING NOTES:

When ordering the Silver Metallic frame with Plastic Seat and Back, the arm color matches the seat and back.

When ordering the Polished Chrome frame, arms are Polished Aluminum.

Corfu chairs are stackable, to a maximum of 13 chairs for the wood or plastic versions, and 10 chairs for the upholstered version, when stacked on the Corfu caddy. Corfu chairs are stackable to a maximum of 9 chairs for the wood or plastic versions and 6 chairs for the upholstered version when stacked on the floor. The upholstered versions stack to a height of 74" in the armless version, and 76" with arms. The non-upholstered versions stack to a height of 70" in the armless version and 72" in the version with arms.





Gangings is optional on all Corfu Multi-purpose seating for an upcharge of **\$33 list** per chair, please specify on order.

CAL 133 and Moisture Barrier options are available for an upcharge of **\$64 list per yard**.

## PRODUCT CODE KEY

Line	Series	Chair Style	Arm Style	Frame Finish
<b>COR</b>	<b>2</b> Multi-Purpose	<b>1</b> Plastic Seat & Back	<b>0</b> Armless	<b>S</b> Silver Metallic
		<b>2</b> Plastic with Upholstered Seat & Back Pads	<b>1</b> Arms	<b>C</b> Polished Chrome
		<b>3</b> Wood Seat & Back		
		<b>4</b> Fully Upholstered Seat & Back		
		<b>5</b> Plastic Back, Plastic Seat with Upholstered Pad		
		<b>6</b> Wood Back, Fully Upholstered Seat		

# CORFU | MULTI-PURPOSE SEATING

DESCRIPTION/MODEL	SPECIES	COM		COL		FABRIC GRADES			LEATHER		
		1	2	3	4	5	6	7	8	9	
	Wood Back, Fully Upholstered Seat, Armless, with Silver Metallic Frame COR2-60S	Beech	777	809	845	879	914	952	984	1018	1054
	Wood Back, Fully Upholstered Seat, Armless, with Polished Chrome Frame COR2-60C	Beech	846	882	915	953	985	1019	1056	1090	1124
	Wood Back, Fully Upholstered Seat, Silver Metallic Arms, with Silver Metallic Frame COR2-61S	Beech	916	954	987	1021	1058	1092	1126	1162	1195
	Wood Back, Fully Upholstered Seat, Polished Aluminum arms, with Polished Chrome Frame COR2-61C	Beech	1004	1038	1073	1109	1142	1178	1213	1247	1283
	Fully Upholstered Seat & Back, Armless, with Silver Metallic Frame COR2-40S		807	853	901	952	997	1044	1092	1139	1187
	Fully Upholstered Seat & Back, Armless, with Polished Chrome Frame COR2-40C		878	927	974	1019	1066	1116	1163	1209	1257
	Fully Upholstered Seat & Back, Silver Metallic Arms, with Silver Metallic Frame COR2-41S		952	997	1044	1092	1139	1187	1232	1282	1330
	Fully Upholstered Seat & Back, Polished Aluminum Arms, with Polished Chrome Frame COR2-41C		1036	1084	1131	1178	1226	1273	1319	1370	1416
	Caddie DOL6		838								

### ORDERING NOTES:

When ordering the Silver Metallic frame with Plastic Seat and Back, the arm color matches the seat and back. When ordering the Polished Chrome frame, arms are Polished Aluminum. Corfu chairs are stackable, to a maximum of 13 chairs for the wood or plastic versions, and 10 chairs for the upholstered version, when stacked on the Corfu caddie. Corfu chairs are stackable to a maximum of 9 chairs for the wood or plastic versions and 6 chairs for the upholstered version when stacked on the floor. The upholstered versions stack to a height of 74" in the armless version, and 76" with arms. The non-upholstered versions stack to a height of 70" in the armless version and 72" in the version with arms. Ganging is optional on all Corfu Multi-purpose seating for an upcharge of **\$33 list** per chair, please specify on order. CAL 133 and Moisture Barrier options are available for an upcharge of **\$64 list per yard**.

### PRODUCT CODE KEY

Line	Series	Chair Style	Arm Style	Frame Finish
<b>COR</b>	<b>2</b> Multi-Purpose	<b>1</b> Plastic Seat & Back	<b>0</b> Armless	<b>S</b> Silver Metallic
		<b>2</b> Plastic with Upholstered Seat & Back Pads	<b>1</b> Arms	<b>C</b> Polished Chrome
		<b>3</b> Wood Seat & Back		
		<b>4</b> Fully Upholstered Seat & Back		
		<b>5</b> Plastic Back, Plastic Seat with Upholstered Pad		
		<b>6</b> Wood Back, Fully Upholstered Seat		

LEED CI CREDITS



MATERIAL CONTENT:

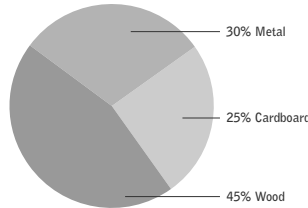

PRE-CONSUMER RECYCLED CONTENT = 15.13%

POST-CONSUMER RECYCLED CONTENT = 30.97%

Up to 66.28% of this Capri product is recyclable at the end of its useful life.

CONTRIBUTES TO

CREDIT 2.1 - 2.2	Construction Waste Management	1-2 point(s)
CREDIT 3.3	Resource Reuse	1 point
CREDIT 4.1	Recycled Content	1 point
CREDIT 4.2	Recycled Content	1 point
CREDIT 4.5	Low Emitting Materials, Systems & Seating	1 point
CREDIT 5.1	Regional Materials*	1 point
CREDIT 7	Certified Wood (MUST BE REQUESTED)	1 point(s)

\*This credit is only applicable if in total 20% of the combined value of the procurement of construction materials and in the furniture are manufactured within a radius of 500 miles. This credit will apply if the installation of the finished product occurs within 500 miles of Kitchener, Ontario.

level® CERTIFICATION, AIR EMISSIONS AND FSC® CERTIFICATION



level® CERTIFICATION

BIFMA's e3 Furniture Sustainability Standard is a voluntary, multi-attribute standard that measures the degree of sustainability of furniture. This standard evaluates product and company environmental attributes and compliance systems in a wide range of elements which include Materials, Energy & Atmosphere, Human & Ecosystem Health and Social Responsibility. Capri products have earned level®, BIFMA's sustainability certification program for furniture, certification through third-party verification against the e3 standard.

AIR-EMISSIONS

All Capri products are supplied with air-emissions certified. Contact customer service for information.





FSC®

In 2005, Krug received Forest Stewardship Council® (FSC®) Chain-of-Custody certification for our manufacturing facilities. The FSC® Chain-of-Custody tracks certified wood from seedling to final sale. It verifies that the material for our FSC® certified products only come from well-managed, FSC®-certified forests and other controlled sources. FSC® is dedicated to the promotion of responsible forest management worldwide helping to take care of forests for future generations. Capri and other Krug products can be specified with FSC® Certification. Contact customer service for further information, pricing and lead times.



Architects, designers, and building professionals can specify FSC®-certified products in order to achieve a point from the U.S. Green Building Council's Leadership in Energy and Environmental Design (LEED) Rating System.

# CAPRI

DESCRIPTION/MODEL/FINISHES	COM		COL		FABRIC GRADES			LEATHER			
	1	2	3	4	5	6	7	8	9		
	ARM CHAIR										
	CAP2A1	Cherry, Beech	1014								
	CAP2A2		1230	1279	1317	1377	1437	1503	1578	1663	1806
	CAP2A3	Cherry, Beech	1117	1161	1205	1254	1307	1359	1411	1497	1587
	CAP2A4	Cherry, Beech	1143								
	CAP2A5	Cherry, Beech	1246	1292	1335	1386	1437	1487	1539	1626	1715
	SIDE CHAIR										
	CAP2S1	Cherry, Beech	932								
	CAP2S2		1143	1192	1240	1298	1359	1421	1482	1568	1714
	CAP2S3	Cherry, Beech	1039	1086	1124	1177	1230	1283	1335	1421	1506
	CAP2S4	Cherry, Beech	1065								
	CAP2S5	Cherry, Beech	1170	1194	1254	1307	1359	1411	1464	1551	1639
	CADDIE		838								
	DOL6										

## DIMENSIONS & COM REQUIREMENTS

	Overall Width	Overall Depth	Overall Height	Seat Height	Height of Arms from Floor	Width between Arms	Seat Depth	Shipping Weight	Cube (2)	COM Yardage
<b>ARM CHAIR</b>										
Wood with arms	22	22.75	33.75	18.5	27	20.5	17.25	12	13	-
Fully Upholstered with arms	22	22.75	34	19	27	20.5	17.75	14	13	1.0
Upholstered seat with arms	22	22.75	33.75	19	27	20.5	17.75	13	13	0.6
<b>SIDE CHAIR</b>										
Wood with arms	19.75	22.75	33.75	18.5	-	-	17.25	12	13	-
Fully Upholstered	19.75	22.75	34	19	-	-	17.75	14	13	1.0
Upholstered seat	19.75	22.75	33.75	19	-	-	17.75	13	13	0.6
<b>ARM CHAIR</b>										
Wood with arms	22	22.75	43.75	29	38.5	20.5	17.25	15	18	-
Fully Upholstered with arms	22	22.75	44	29.5	38.5	20.5	17.75	17	18	1.0
Upholstered seat with arms	22	22.75	43.75	29.5	38.5	20.5	17.75	16	18	0.6
<b>CADDIE</b>	25.5	41	43.75	-	-	-	-	20	17	-

**ORDERING NOTES:** CAL 133 and Moisture Barrier options are available for an upcharge of **\$64 list per yard.**

## PRODUCT CODE KEY

Line	Series	Chair Type	Chair Style	
CAP	2	A	1	<b>CADDIE</b> When used with Caddie, Capri stacks to a maximum of 15 chairs high (10 high for upholstered versions). Barstool versions cannot be stacked with Caddie.  <b>REMOVABLE UPHOLSTERED BACK COVER</b> Capri Chairs are available with removable upholstered back cover at an upcharge of <b>\$48 list</b> per chair.
Capri	Guest Seating	Arm Chair	Wood	
	5	S	2	
	Barstool	Side Chair	Fully Upholstered	
			3	
			4	
			5	
			Upholstered Seat Cushion	
			Wood With Holes	
			Upholstered Seat, Back with Holes	

# BANK OF ENGLAND | ENVIRONMENTAL SUMMARY

## LEED CI CREDITS



### MATERIAL CONTENT:

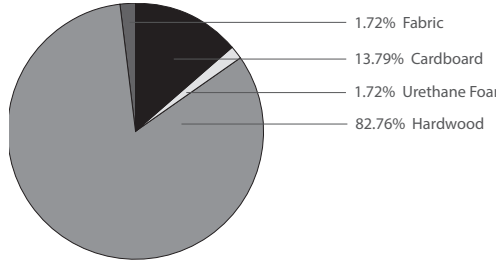

PRE-CONSUMER  
RECYCLED CONTENT = .34%

POST-CONSUMER  
RECYCLED CONTENT = 13.10%

Up to 96.55% of this Bank of England product is recyclable at the end of its useful life.

### CONTRIBUTES TO

CREDIT 2.1 - 2.2	Construction Waste Management	1-2 point(s)
CREDIT 3.3	Resource Reuse	1 point
CREDIT 4.1	Recycled Content	1 point
CREDIT 4.5	Low Emitting Materials, Systems & Seating	1 point
CREDIT 5.1	Regional Materials*	1 point
CREDIT 7	Certified Wood (MUST BE REQUESTED)	1 point(s)

## level® CERTIFICATION, AIR EMISSIONS AND FSC® CERTIFICATION



### level® CERTIFICATION

BIFMA's e3 Furniture Sustainability Standard is a voluntary, multi-attribute standard that measures the degree of sustainability of furniture. This standard evaluates product and company environmental attributes and compliance systems in a wide range of elements which include Materials, Energy & Atmosphere, Human & Ecosystem Health and Social Responsibility. Bank of England products have earned level®, BIFMA's sustainability certification program for furniture, certification through third-party verification against the e3 standard.

### AIR-EMISSIONS

All Bank of England products are supplied with air-emissions certified. Contact customer service for information.





### FSC®

In 2005, Krug received Forest Stewardship Council® (FSC®) Chain-of-Custody certification for our manufacturing facilities. The FSC® Chain-of-Custody tracks certified wood from seedling to final sale. It verifies that the material for our FSC® certified products only come from well-managed, FSC®-certified forests and other controlled sources. FSC® is dedicated to the promotion of responsible forest management worldwide helping to take care of forests for future generations. Bank of England and other Krug products can be specified with FSC® Certification. Contact customer service for further information, pricing and lead times.



Architects, designers, and building professionals can specify FSC®-certified products in order to achieve a point from the U.S. Green Building Council's Leadership in Energy and Environmental Design (LEED) Rating System.

# BANK OF ENGLAND

DESCRIPTION/MODEL/FINISHES	COM		COL		FABRIC GRADES			LEATHER		
	1	2	3	4	5	6	7	8	9	
 WOOD SEAT 177-A Oak, Cherry 1240 177-J Oak, Cherry Jury Base 1403										
 REMOVABLE CUSHION 178-A Oak, Cherry 1512 1584 1653 1720 1788 1855 1918 1988 2096 178-J Oak, Cherry Jury Base 1688 1764 1835 1908 1977 2051 2114 2188 2302										
 UPHOLSTERED SEAT 179-A Oak, Cherry 1512 1584 1653 1720 1788 1855 1918 1988 2096 179-J Oak, Cherry Jury Base 1688 1764 1835 1908 1977 2051 2114 2188 2302										

## DIMENSIONS & COM REQUIREMENTS

	Overall Width	Overall Depth	Overall Height	Seat Height	Height of Arms from Floor	Width between Arms	Seat Depth	Shipping Weight	Cube	COM Yardage
<b>177-A</b>	23.5	24.5	31.5	18.5	28.5	19	17	29	11	-
<b>178-A</b>	23.5	24.5	31.5	18.5	28.5	19	17	29	11	0.75
<b>179-A</b>	23.5	24.5	31.5	18.5	28.5	19	17	29	11	0.75

## ORDERING NOTES

Jury Bases assembly consists of a black 9" diameter conical/cast base for permanently mounting a chair to the floor. Into the base is inserted a black pneumatic gas cylinder with self returning action from rotation, and self returning height feature when exiting the chair. Allows for full 360 degree rotation. Limited degrees of rotation are not available. For jury base version of this chair, please select model number '177-J' for Wood Seat, '178-J' for Removable Cushion, or '179-J' for Removable Cushion Upholstered Seat.



CAL 133 and Moisture Barrier options are available for an upcharge of **\$64 list per yard**.

## ORDERING PROCEDURE

To order please specify the following:

1. Krug product model number
2. Fabric name and number
3. Wood finish

Dimensions are in inches and approximate. Contact Customer Service if dimensions are critical.

## BANK OF ENGLAND

For a complete list of standard wood finishes please see page 335.

# BARSTOOL & COUNTER HEIGHT SEATING

127	Manolo
131	Karma
133	Capri
135	Corfu

# MANOLO | ENVIRONMENTAL SUMMARY

## LEED CI CREDITS



MATERIAL CONTENT:

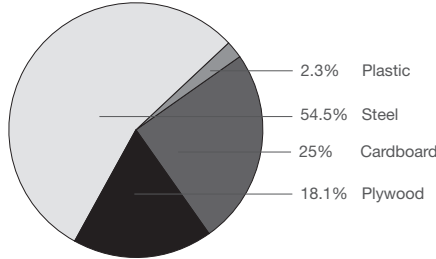

PRE-CONSUMER RECYCLED CONTENT = 14.89%

POST-CONSUMER RECYCLED CONTENT = 34.84%

Up to 69.20% of this Manolo product is recyclable at the end of its useful life.

CONTRIBUTES TO

CREDIT 2.1 - 2.2	Construction Waste Management	1-2 point(s)
CREDIT 3.3	Resource Reuse	1 point
CREDIT 4.1	Recycled Content	1 point
CREDIT 4.2	Recycled Content	1 point
CREDIT 4.5	Low Emitting Materials, Systems & Seating	1 point
CREDIT 5.1	Regional Materials*	1 point
CREDIT 7	Certified Wood (MUST BE REQUESTED)	1 point(s)

\*This credit is only applicable if in total 20% of the combined value of the procurement of construction materials and in the furniture are manufactured within a radius of 500 miles. This credit will apply if the installation of the finished product occurs within 500 miles of Kitchener, Ontario.

## level® CERTIFICATION, AIR EMISSIONS AND FSC® CERTIFICATION



### level® CERTIFICATION

BIFMA's e3 Furniture Sustainability Standard is a voluntary, multi-attribute standard that measures the degree of sustainability of furniture. This standard evaluates product and company environmental attributes and compliance systems in a wide range of elements which include Materials, Energy & Atmosphere, Human & Ecosystem Health and Social Responsibility. Manolo products have earned level®, BIFMA's sustainability certification program for furniture, certification through third-party verification against the e3 standard.



the mark of responsible forests

### AIR EMISSIONS

All Manolo products are supplied air-emissions certified. Contact customer service for information.

### FSC®

In 2005, Krug received Forest Stewardship Council® (FSC®) Chain-of-Custody certification for our manufacturing facilities. The FSC® Chain-of-Custody tracks certified wood from seedling to final sale. It verifies that the material for our FSC® certified products only come from well-managed, FSC®-certified forests and other controlled sources. FSC® is dedicated to the promotion of responsible forest management worldwide helping to take care of forests for future generations. Manolo and other Krug products can be specified with FSC® Certification. Contact customer service for further information, pricing and lead times.



Architects, designers, and building professionals can specify FSC®-certified products in order to achieve a point from the U.S. Green Building Council's Leadership in Energy and Environmental Design (LEED) Rating System.





## SEATS

Manolo seats are available, with two back heights; Backless Seat and Low Back Seat, in Upholstered, Beech and Walnut veneers and Palette finishes.



## BASES

Manolo Stool bases feature Polished Chrome structural steel base frames with non-marring polycarbonate glides. Manolo Stool bases are available in two heights; Counter Height or Bar Height.

## WEIGHT CAPACITY

Manolo complies with ANSI/BIFMA x5.1-2011 test standards. Manolo has been load tested up to 300lbs.

## FINISH DURABILITY

The Krug's finish, a proprietary catalyzed varnish formulation, has been repeatedly shown, through independent laboratory testing, to be the industry leader in durability and abrasion resistance. The Krug finish looks better longer than competitors, and is uniquely suited to the demands of high traffic environments.

## OPTIONS

### CAL 133 & Moisture Barrier

California Technical Bulletin 133 is a flammability test for seating. Krug offers a compliance method which, in combination with non-flammable upholstery covers, may enable the products to meet certification requirements for this test. This process at the same time also provides the products with a Moisture Barrier - a treatment that helps to prevent the passage of liquids and moisture to inside of upholstered components - thereby conferring sanitary and anti-infection benefits. So when CAL 133 is specified, the product also automatically has a Moisture Barrier, and when a Moisture Barrier is specified, the product also features the compliance method and low flammability features of CAL 133. CAL 133 and Moisture Barrier are available for an upcharge of **\$64 list**.

The application of this upcharge and the compliance method does not mean that the specific configuration of product and upholstery cover are tested and officially certified as being CAL 133 compliant. If official certification is required, Krug will provide this (through an independent certified testing laboratory) at a charge of \$917 per item, plus the cost of the product to be tested. Lead time for certification testing is typically 4-8 weeks. Krug assumes no responsibility for the testing of our products in combination with upholstery covers, or for the results of any testing conducted. Some specific configurations of product and upholstery have already been tested. Please contact Customer Service for additional information.





# MANOLO | DIMENSIONS & COM

## DIMENSIONS & COM REQUIREMENTS

	Overall Width	Overall Depth	Overall Height	Seat Width	Seat Depth	Seat Height	Shipping Weight	Cube	COM Yardage
Barstool									
Backless Seat	19	22.5	36	15.75	16	31	19.5	12	1
Low Back Seat	19	22.5	41	15.75	16	31	20	13	1
Counter Stool									
Backless Seat	19	22.5	30	15.75	16	25	18.5	10	1
Low Back Seat	19	22.5	35	15.75	16	25	19	11	1

All dimensions are in inches and approximate and are subject to change without notice. Contact Customer Service if dimensions are critical.

# MANOLO | BARSTOOL & COUNTER STOOL

Description	Model	Species	COM		COL			FABRIC GRADES			LEATHER	
			1	2	3	4	5	6	7	8	9	
	Barstool, Wood, Backless Seat											
	MAN5B01	Beech	810									
		Walnut	851									
	MAN5B03	Palette	780									
	Counter Stool, Wood Seat, Backless Seat											
	MAN5C01	Beech	784									
	Walnut	824										
	MAN5C03	Palette	756									
	Barstool, Fully Upholstered, backless seat											
	MAN5B02		853	886	916	981	1043	1108	1170	1232	1360	
	Counter Stool, Fully Upholstered, Backless Seat											
	MAN5C02		827	859	890	955	1017	1082	1143	1207	1334	
	Barstool, Wood, Low Back Seat											
	MAN5B11	Beech	827									
		Walnut	869									
	MAN5B13	Palette	793									
	Counter Stool, Wood, Low Back Seat											
	MAN5C11	Beech	799									
	Walnut	842										
	MAN5C13	Palette	768									
	Barstool Fully Upholstered, Low Back Seat											
	MAN5B12		906	939	974	1039	1107	1171	1240	1306	1438	
	Counter Stool Fully Upholstered, Low Back Seat											
	MAN5C12		878	913	946	1012	1080	1146	1212	1279	1412	

## Manolo Option Upcharges

## \$ List

CAL 133 & Moisture Barrier (per yard)

64

## PRODUCT CODE KEY

Line	Series	Base Height	Seat Style	Seat Type
MAN	5	B	0	1
Manolo	Stool	Bar Height	Backless Seat	Wood
		C	1	2
		Counter Height	Low Back Seat	Fully Upholstered
				3
				Palette

# KARMA | ENVIRONMENTAL SUMMARY

## LEED CI CREDITS



MATERIAL CONTENT:

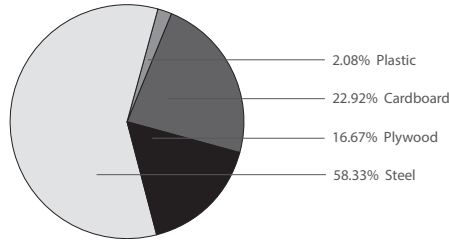

PRE-CONSUMER  
RECYCLED CONTENT = 7.86%

POST-CONSUMER  
RECYCLED CONTENT = 33.6%

Up to 70.10% of this Capri product is recyclable at the end of its useful life.

CONTRIBUTES TO

CREDIT 2.1 - 2.2	Construction Waste Management	1-2 point(s)
CREDIT 3.3	Resource Reuse	1 point
CREDIT 4.1	Recycled Content	1 point
CREDIT 4.2	Recycled Content	1 point
CREDIT 4.5	Low Emitting Materials, Systems & Seating	1 point
CREDIT 5.1	Regional Materials*	1 point
CREDIT 7	Certified Wood (MUST BE REQUESTED)	1 point(s)

\*This credit is only applicable if in total 20% of the combined value of the procurement of construction materials and in the furniture are manufactured within a radius of 500 miles. This credit will apply if the installation of the finished product occurs within 500 miles of Kitchener, Ontario.

## level® CERTIFICATION, AIR EMISSIONS AND FSC® CERTIFICATION



### level® CERTIFICATION

BIFMA's e3 Furniture Sustainability Standard is a voluntary, multi-attribute standard that measures the degree of sustainability of furniture. This standard evaluates product and company environmental attributes and compliance systems in a wide range of elements which include Materials, Energy & Atmosphere, Human & Ecosystem Health and Social Responsibility. Karma products have earned level®, BIFMA's sustainability certification program for furniture, certification through third-party verification against the e3 standard.



The mark of responsible forestry

### AIR EMISSIONS

All Karma products are supplied air-emissions certified. Contact customer service for information.





### FSC®

In 2005, Krug received Forest Stewardship Council® (FSC®) Chain-of-Custody certification for our manufacturing facilities. The FSC® Chain-of-Custody tracks certified wood from seedling to final sale. It verifies that the material for our FSC® certified products only come from well-managed, FSC®-certified forests and other controlled sources. FSC® is dedicated to the promotion of responsible forest management worldwide helping to take care of forests for future generations. Karma and other Krug products can be specified with FSC® Certification. Contact customer service for further information, pricing and lead times.

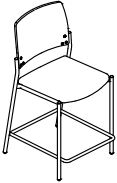

Architects, designers, and building professionals can specify FSC®-certified products in order to achieve a point from the U.S. Green Building Council's Leadership in Energy and Environmental Design (LEED) Rating System.

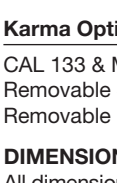
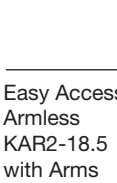
# KARMA | COUNTER STOOL

DESCRIPTION/MODEL	COM		COL		FABRIC GRADES			LEATHER		
	1	2	3	4	5	6	7	8	9	
	18.5" Leg Frame, Matte Black or Silver Metallic - Fully Upholstered, No Arm, with Standard Dust Cover									
	KAR2C-18.5C_UNAD	677	705	731	767	810	848	889	942	995
	18.5" Leg Frame, Polished Chrome - Fully Upholstered, No Arm, with Standard Dust Cover									
	KAR2C-18.5CCUNAD	730	757	782	820	864	900	941	994	1046
	18.5" Leg Frame, Matte Black or Silver Metallic- Upholstered Seat & Wood back, No Arm, with Standard Dust Cover									
	KAR2C-18.5C_WNAD	711	727	739	759	780	798	820	846	873
	18.5" Leg Frame, Polished Chrome - Upholstered Seat & Wood back, No Arm, with Standard Dust Cover									
	KAR2C-18.5CCWNAD	764	779	791	809	832	849	871	898	927
	18.5" Leg Frame, Matte Black or Silver Metallic - Fully Upholstered, with Arm, with Standard Dust Cover									
	KAR2C-18.5C_U_D	716	737	768	807	848	886	929	982	1034
	18.5" Leg Frame, Polished Chrome - Fully Upholstered, with Arm, with Standard Dust Cover									
	KAR2C-18.5CCU_D	767	794	821	857	900	937	981	1033	1087
	18.5" Leg Frame, Matte Black or Silver Metallic- Upholstered Seat & Wood back, with Arm, with Standard Dust Cover									
	KAR2C-18.5C_W_D	740	756	767	785	808	827	848	875	904
	18.5" Leg Frame, Polished Chrome - Upholstered Seat & Wood back, with Arm, with Standard Dust Cover									
	KAR2C-18.5CCW_D	793	807	820	838	859	878	900	928	955

**ORDERING NOTES:** When selecting Frame Color and Arm Style please see Product Code Key below. Karma chairs all include the Standard Dust Cover (select "D" below), for optional Polymer Shroud change "D" to "S" and add upcharge listed below. See page 4 for dimensions and COM requirements.

Karma Option Upcharges	\$ List	\$ List
CAL 133 & Moisture Barrier (per yard)	64	Polymer Underseat Shroud 18.5" 47
Removable Seat Covers	71	Combination Upholstery - dual fabrics 33
Removable Back Covers	71	See page 3 for more information on options and features.

### DIMENSIONS:

All dimensions are in inches and approximate and are subject to change without notice. Contact Customer Service if dimensions are critical.

	Overall Width	Overall Depth	Overall Height	Seat Height	Arms From Floor	Between Arms	Seat Depth	Shipping Weight/box			COM YRD	Cubes
								1 Chair	2 Chairs	3 Chairs		
Easy Access or Counter Seat Upholstered												
Armless												
KAR2-18.5	20.2	21.9	39.9	24	n/a	n/a	17	43	-	-	1	20
with Arms												
KAR2-18.5	24.5	21.9	39.9	24	32.8	18.5	17	44.5	-	-	1	20
Easy Access or Counter Seat Wood Back												
Armless												
KAR2-18.5	20.2	21.9	39.9	24	n/a	n/a	17	43	-	-	1	20
with Arms												
KAR2-18.5	24.5	21.9	39.9	24	32.8	18.5	17	44.5	-	-	1	20

### PRODUCT CODE KEY

Line	Series	Frame Size	Frame Color	Style	Arm Style	Underseat Shroud
<b>KAR</b>	<b>2C</b>	<b>18.5C</b>	<b>B</b>	<b>U</b>	<b>NA</b>	<b>S</b>
Karma	Chair	18.5" Counter Height Stool	Matte Black	Fully Upholstered	No Arm	Polymer Shroud
			<b>S</b>	<b>W</b>	<b>AB</b>	<b>D</b>
			Silver Metallic	Beech Wood Back	Black	Standard Dust Cover
			<b>C</b>		<b>AG</b>	
			Polished Chrome		Grey	
					<b>AT</b>	
					Taupe	

# CAPRI | ENVIRONMENTAL SUMMARY

## LEED CI CREDITS



MATERIAL CONTENT:

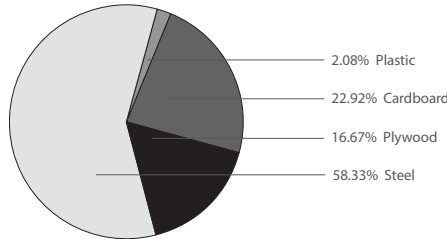

PRE-CONSUMER RECYCLED CONTENT = 7.86%

POST-CONSUMER RECYCLED CONTENT = 33.6%

Up to 70.10% of this Capri product is recyclable at the end of its useful life.

### CONTRIBUTES TO

CREDIT 2.1 - 2.2	Construction Waste Management	1-2 point(s)
CREDIT 3.3	Resource Reuse	1 point
CREDIT 4.1	Recycled Content	1 point
CREDIT 4.2	Recycled Content	1 point
CREDIT 4.5	Low Emitting Materials, Systems & Seating	1 point
CREDIT 5.1	Regional Materials*	1 point
CREDIT 7	Certified Wood (MUST BE REQUESTED)	1 point(s)

\*This credit is only applicable if in total 20% of the combined value of the procurement of construction materials and in the furniture are manufactured within a radius of 500 miles. This credit will apply if the installation of the finished product occurs within 500 miles of Kitchener, Ontario.

## level® CERTIFICATION, AIR EMISSIONS AND FSC® CERTIFICATION



### level® CERTIFICATION

BIFMA's e3 Furniture Sustainability Standard is a voluntary, multi-attribute standard that measures the degree of sustainability of furniture. This standard evaluates product and company environmental attributes and compliance systems in a wide range of elements which include Materials, Energy & Atmosphere, Human & Ecosystem Health and Social Responsibility. Capri products have earned level®, BIFMA's sustainability certification program for furniture, certification through third-party verification against the e3 standard.

### AIR-EMISSIONS

All Capri products are supplied with air-emissions certified. Contact customer service for information.



### FSC®

In 2005, Krug received Forest Stewardship Council® (FSC®) Chain-of-Custody certification for our manufacturing facilities. The FSC® Chain-of-Custody tracks certified wood from seedling to final sale. It verifies that the material for our FSC® certified products only come from well-managed, FSC®-certified forests and other controlled sources. FSC® is dedicated to the promotion of responsible forest management worldwide helping to take care of forests for future generations. Capri and other Krug products can be specified with FSC® Certification. Contact customer service for further information, pricing and lead times.



Architects, designers, and building professionals can specify FSC®-certified products in order to achieve a point from the U.S. Green Building Council's Leadership in Energy and Environmental Design (LEED) Rating System.

# CAPRI | BARSTOOL

DESCRIPTION/MODEL/FINISHES	COM		COL		FABRIC GRADES			LEATHER			
	1	2	3	4	5	6	7	8	9		
	BARSTOOL										
	CAP5A1	Cherry, Beech	1216								
	CAP5A2		1478	1533	1584	1653	1724	1802	1892	1993	2139
	CAP5A3	Cherry, Beech	1341	1393	1445	1508	1569	1632	1693	1798	1885
	CAP5A4	Cherry, Beech	1372								
	CAP5A5	Cherry, Beech	1495	1548	1598	1663	1724	1788	1846	1954	2037

## DIMENSIONS & COM REQUIREMENTS

	Overall Width	Overall Depth	Overall Height	Seat Height	Height of Arms from Floor	Width between Arms	Seat Depth	Shipping Weight	Cube	COM Yardage
<b>BARSTOOL</b>										
Wood with arms	22	22.75	43.75	29	38.5	20.5	17.25	15	18	-
Fully Upholstered with arms	22	22.75	44	29.5	38.5	20.5	17.75	17	18	1.0
Upholstered seat with arms	22	22.75	43.75	29.5	38.5	20.5	17.75	16	18	0.6

**ORDERING NOTES:** CAL 133 and Moisture Barrier options are available for an upcharge of **\$64 list per yard**.

## PRODUCT CODE KEY

Line	Series	Chair Type	Chair Style
CAP	5	A	1
Capri	Barstool	Arm Chair	Wood
			2
			Fully Upholstered
			3
			Upholstered Seat Cushion
			4
			Wood With Holes
			5
			Upholstered Seat, Back with Holes

### BARSTOOL

The Capri barstool version is available with arms only. Capri barstool versions are suitable for use with bar heights in the range of 40" to 42".

### REMOVABLE UPHOLSTERED BACK COVER

Capri Chairs are available with removable upholstered back cover at an upcharge of **\$48 list** per chair.

# CORFU | ENVIRONMENTAL SUMMARY

## LEED CI CREDITS



(COR5-11S)

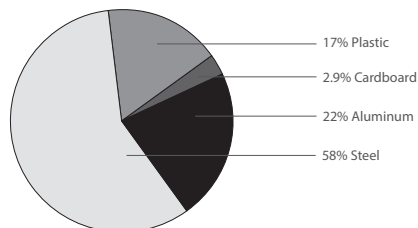

PRE-CONSUMER  
RECYCLED CONTENT = 27.77%

POST-CONSUMER  
RECYCLED CONTENT = 18.44%

Up to 86.71% of this Corfu product is recyclable at the end of its useful life.

### CONTRIBUTES TO

CREDIT 2.1 - 2.2	Construction Waste Management	1-2 point(s)
CREDIT 3.3	Resource Reuse	1 point
CREDIT 4.1	Recycled Content	1 point
CREDIT 4.2	Recycled Content	1 point
CREDIT 4.5	Low Emitting Materials, Systems & Seating	1 point
CREDIT 5.1	Regional Materials*	1 point
CREDIT 7	Certified Wood (MUST BE REQUESTED)	1 point(s)

\*This credit is only applicable if in total 20% of the combined value of the procurement of construction materials and in the furniture are manufactured within a radius of 500 miles. This credit will apply if the installation of the finished product occurs within 500 miles of Kitchener, Ontario.

## level® CERTIFICATION, AIR EMISSIONS AND FSC® CERTIFICATION



### level® CERTIFICATION

BIFMA's e3 Furniture Sustainability Standard is a voluntary, multi-attribute standard that measures the degree of sustainability of furniture. This standard evaluates product and company environmental attributes and compliance systems in a wide range of elements which include Materials, Energy & Atmosphere, Human & Ecosystem Health and Social Responsibility. Corfu products have earned level®, BIFMA's sustainability certification program for furniture, certification through third-party verification against the e3 standard.

### AIR-EMISSIONS

All Corfu products are supplied with air-emissions certified. Contact customer service for information.



### FSC®

In 2005, Krug received Forest Stewardship Council® (FSC®) Chain-of-Custody certification for our manufacturing facilities. The FSC® Chain-of-Custody tracks certified wood from seedling to final sale. It verifies that the material for our FSC® certified products only come from well-managed, FSC®-certified forests and other controlled sources. FSC® is dedicated to the promotion of responsible forest management worldwide helping to take care of forests for future generations. Corfu and other Krug products can be specified with FSC® Certification. Contact customer service for further information, pricing and lead times.



Architects, designers, and building professionals can specify FSC®-certified products in order to achieve a point from the U.S. Green Building Council's Leadership in Energy and Environmental Design (LEED) Rating System.



# CORFU | BARSTOOL - FEATURES & OPTIONS

## SUSTAINABLE DESIGN

Corfu is made with recycled materials, with an overall recycled content of 40%. Many of these same materials are also recyclable. Corfu is air emissions certified.



## WOOD FINISH

Krug's Enduraguard™ finish is a catalyzed conversion varnish topcoat, combined with a vinyl polymer-based sealer, that in independent testing has been shown to have exceptional durability characteristics in its resistance to scratching, marring, and degradation from cleaning materials and other substances.

## BEECH PLYWOOD

Wood seats and backs are made with European Beech hardwood veneers, featuring nine (9) plies of cross grain for added strength and durability.

## STEEL FRAME

Corfu seating is built with high strength steel castings and extrusions. Finish options are Silver Metallic and Chrome.



## PLASTIC COMPONENTS

Polypropylene seats, backs and other components are injection molded, with pigment diffused throughout the mold, and featuring a compound that provides UV resistance to fading and brittleness from exposure to light. Seats and backs have a minimum wall thickness of 5 mm, providing excellent strength and shock resistance. Corfu (Plastic Seat & Back) is available in six different colors. Please specify a color when ordering.

Color Selection:

White, Black, Grey, Red, Blue, Sand



## UNDER SEAT COVER

Each Corfu includes an under-seat system for stacking: a grey polypropylene seat pan that nests into the seat below and protects it from the frame above. It also provides for easy cleaning and maintenance by covering the underside of the chair.

## OPTIONS

### COMBINATION UPHOLSTERY COVERS

When combination upholstery is with upholstery of the same grade or COM, an upcharge for dual fabrics is **\$33 list** per unit. When graded in combination upholstery is selected, use the highest upholstery grade or contact customer service for a quote. Please provide the fabric specified and a description of where each fabric is to be applied on the product in order to obtain a quote.

### CAL 133 & MOISTURE BARRIER

California Technical Bulletin 133 is a flammability test for seating. Krug offers a compliance method which, in combination with non-flammable upholstery covers, may enable the products to meet certification requirements for this test. This process at the same time also provides the products with a Moisture Barrier - a treatment that helps to prevent the passage of liquids and moisture to inside of upholstered components - thereby conferring sanitary and anti-infection benefits. So when CAL 133 is specified, the product also automatically has a Moisture Barrier, and when a Moisture Barrier is specified, the product also features the compliance method and low flammability features of CAL 133. CAL 133 and Moisture Barrier are available for an upcharge of **\$64 list** per yard. The application of this upcharge and the compliance method does not mean that the specific configuration of product and upholstery cover are tested and officially certified as being CAL 133 compliant. If official certification is required, Krug will provide this (through an independent certified testing laboratory) at a charge of \$917 per item, plus the cost of the product to be tested. Lead time for certification testing is typically 4-8 weeks. Krug assumes no responsibility for the testing of our products in combination with upholstery covers, or for the results of any testing conducted. Some specific configurations of product and upholstery have already been tested. Please contact Customer Service for additional information.

# CORFU | BARSTOOL - DIMENSIONS & COM REQUIREMENTS

## COM REQUIREMENTS

	COM Yardage Seat Pad Only	Yardage Per Chair - Seat Pad Only	COM Yardage Fully Upholstered Seat Only	Yardage Per Chair - Fully Upholstered Seat Only	COM Yardage Seat & Back Pads	Yardage Per Chair - Seat & Back Pads	COM Yardage Fully Upholstered Seat & Back	Yardage Per Chair - Fully Upholstered Seat & Back
One Chair	0.7	0.7	0.7	0.7	0.7	0.7	1	1
Two Chair	0.7	0.35	0.7	0.35	1.1	0.55	1.7	0.85
Three Chair	1.4	0.47	1.4	0.47	1.8	0.6	2.7	0.9
Four Chair	1.4	0.35	1.4	0.35	2.2	0.55	3.4	0.85

Note: Some vinyls, leathers & upholsteries are not suitable on Corfu seating.

The approval process is as follows:

1. A sample of the COM must be provided to Krug Customer Service prior to or at the time of order.
2. The sample will be reviewed and the customer advised if the upholstery cover is unsuitable.
3. The COM upholstery cover or leather will be inspected when received at the factory, to identify any further concerns with its suitability.









## DIMENSIONS

	Overall Width	Overall Depth	Overall Height	Seat Height	Height of Arms from Floor	Width Between Arms	Seat Depth	Shipping Weight	Cube
COR5-10S	21.5	22.5	44.3	29.5	NA	NA	17.5	39	22
COR5-10C	21.5	22.5	44.3	29.5	NA	NA	17.5	39	22
COR5-11S	23	22.5	44.3	29.5	38.3	17.5	17.5	11	22
COR5-11C	23	22.5	44.3	29.5	38.3	17.5	17.5	11	22
COR5-20S	21.5	22.5	44.3	29.5	NA	NA	17.5	42	22
COR5-20C	21.5	22.5	44.3	29.5	NA	NA	17.5	42	22
COR5-21S	23	22.5	44.3	29.5	38.3	17.5	17.5	46	22
COR5-21C	23	22.5	44.3	29.5	38.3	17.5	17.5	46	22
COR5-30S	21.5	22.5	44.3	29.5	NA	NA	17.5	44	22
COR5-30C	21.5	22.5	44.3	29.5	NA	NA	17.5	44	22
COR5-31S	23	22.5	44.3	29.5	38.3	17.5	17.5	47	22
COR5-31C	23	22.5	44.3	29.5	38.3	17.5	17.5	47	22
COR5-40S	21.5	22.5	44.3	29.5	NA	NA	17.5	44	22
COR5-40C	21.5	22.5	44.3	29.5	NA	NA	17.5	44	22
COR5-41S	23	22.5	44.3	29.5	38.3	17.5	17.5	47	22
COR5-41C	23	22.5	44.3	29.5	38.3	17.5	17.5	47	22
COR5-50S	21.5	22.5	44.3	29.5	NA	NA	17.5	41	22
COR5-50C	21.5	22.5	44.3	29.5	NA	NA	17.5	41	22
COR5-51S	23	22.5	44.3	29.5	38.3	17.5	17.5	45	22
COR5-51C	23	22.5	44.3	29.5	38.3	17.5	17.5	45	22
COR5-60S	21.5	22.5	44.3	29.5	NA	NA	17.5	44	22
COR5-60C	21.5	22.5	44.3	29.5	NA	NA	17.5	44	22
COR5-61S	23	22.5	44.3	29.5	38.3	17.5	17.5	47	22
COR5-61C	23	22.5	44.3	29.5	38.3	17.5	17.5	47	22

## WEIGHT CAPACITY

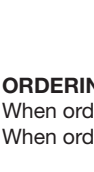
Corfu has been tested and complies with ANSI/BIFMA x5.1-2011 standards. Corfu has been load tested up to 350lbs.

# CORFU | BARSTOOL

DESCRIPTION/MODEL	COM		COL			FABRIC GRADES			LEATHER	
	1	2	3	4	5	6	7	8	9	
	Plastic Seat & Back, Armless, with Silver Metallic Frame									
	COR5-10S	878								
	Plastic Seat & Back, Armless, with Polished Chrome Frame									
	COR5-10C	1029								
	Plastic Seat & Back, Plastic Arms with Silver Metallic Frame									
	COR5-11S	971								
	Plastic Seat & Back, Polished Aluminum Arms with Polished Chrome Frame									
	COR5-11C	1134								
	Plastic with Upholstered Seat & Back Pads, Armless, with Silver Metallic Frame									
	COR5-20S	1169	1186	1205	1242	1276	1314	1349	1386	1459
	Plastic with Upholstered Seat & Back Pads, Armless, with Polished Chrome Frame									
	COR5-20C	1318	1335	1355	1391	1428	1463	1501	1536	1609
	Plastic with Upholstered Seat & Back Pads, Plastic Arms, with Silver Metallic Frame									
	COR5-21S	1262	1281	1297	1333	1371	1407	1441	1480	1552
	Plastic with Upholstered Seat & Back Pads, Polished Aluminum Arms, with Polished Chrome Frame									
	COR5-21C	1422	1440	1460	1494	1533	1567	1604	1641	1713

## ORDERING NOTES:







When ordering the Silver Metallic frame with Plastic Seat and Back, the arm color matches the seat and back.  
When ordering the Polished Chrome frame, arms are Polished Aluminum.

CAL 133 and Moisture Barrier options are available for an upcharge of **\$64 list per yard**.

## PRODUCT CODE KEY

Line	Series	Chair Style	Arm Style	Frame Finish
<b>COR</b>	<b>5</b> Barstool	<b>1</b> Plastic Seat & Back	<b>0</b> Armless	<b>S</b> Silver Metallic
		<b>2</b> Plastic with Upholstered Seat & Back Pads	<b>1</b> Arms	<b>C</b> Polished Chrome
		<b>3</b> Beech Wood Seat & Back		
		<b>4</b> Fully Upholstered Seat & Back		
		<b>5</b> Plastic Back, Plastic Seat with Upholstered Pad		
		<b>6</b> Beech Wood Back, Fully Upholstered Seat		

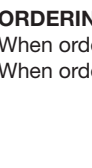
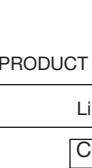
# CORFU | BARSTOOL

DESCRIPTION/MODEL	SPECIES	COM		COL			FABRIC GRADES		LEATHER	
		1	2	3	4	5	6	7	8	9
	Plastic Back, Plastic Seat with Upholstered Pad, Armless, with Silver Metallic Frame									
	COR5-50S		1116	1126	1137	1160	1180	1201	1222	1243
	Plastic Back, Plastic Seat with Upholstered Pad, Plastic Arms with Silver Metallic Frame									
	COR5-51S		1127	1138	1148	1169	1192	1213	1232	1254
	Plastic Back, Plastic Seat with Upholstered Pad, Polished Aluminum Arms, with Polished Chrome Frame									
	COR5-51C		1371	1380	1391	1412	1434	1455	1477	1495
	Wood Seat & Back, Armless, with Silver Metallic Frame									
	COR5-30S	Beech	1218							
	Wood Seat & Back, Armless, with Polished Chrome Frame									
	COR5-30C	Beech	1292							
	Wood Seat & Back, Silver Metallic Arms, with Silver Metallic Frame									
	COR5-31S	Beech	1342							
	Wood Seat & Back, Polished Aluminum Arms, with Polished Chrome Frame									
	COR5-31C	Beech	1396							

### ORDERING NOTES:









When ordering the Silver Metallic frame with Plastic Seat and Back, the arm color matches the seat and back.  
 When ordering the Polished Chrome frame, arms are Polished Aluminum.

CAL 133 and Moisture Barrier options are available for an upcharge of **\$64 list per yard**.

### PRODUCT CODE KEY

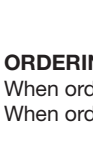
Line	Series	Chair Style	Arm Style	Frame Finish
COR	5 Barstool	1 Plastic Seat & Back	0 Armless	S Silver Metallic
		2 Plastic with Upholstered Seat & Back Pads	1 Arms	C Polished Chrome
		3 Beech Wood Seat & Back		
		4 Fully Upholstered Seat & Back		
		5 Plastic Back, Plastic Seat with Upholstered Pad		
		6 Beech Wood Back, Fully Upholstered Seat		

# CORFU | BARSTOOL

DESCRIPTION/MODEL	SPECIES	COM		COL		FABRIC GRADES		LEATHER			
		1	2	3	4	5	6	7	8	9	
	Wood Back, Fully Upholstered Seat Armless, with Silver Metallic frame										
	COR5-60S Beech	1114	1127	1139	1163	1187	1212	1236	1260	1309	
	Wood Back, Fully Upholstered Seat Armless, with Polished Chrome frame										
	COR5-60C Beech	1190	1201	1213	1239	1262	1286	1310	1333	1381	
	Wood Back, Fully Upholstered Seat, Silver Metallic Arms, with Silver Metallic Frame										
	COR5-61S Beech	1240	1251	1263	1288	1311	1335	1359	1383	1433	
	Wood Back, Fully Upholstered Seat, Polished Aluminum Arms, with Polished Chrome Frame										
	COR5-61C Beech	1292	1306	1317	1341	1367	1390	1414	1438	1487	
	Fully Upholstered Seat & Back, Armless, with Silver Metallic Frame										
	COR5-40S	1124	1151	1177	1227	1281	1331	1381	1434	1536	
	Fully Upholstered Seat & Back, Armless, with Polished Chrome Frame										
	COR5-40C	1199	1224	1251	1303	1354	1404	1456	1507	1610	
	Fully Upholstered Seat & Back, Silver Metallic Arms, with Silver Metallic Frame										
	COR5-41S	1249	1273	1302	1352	1403	1455	1506	1557	1660	
	Fully Upholstered Seat & Back, Polished Aluminum Arms, with Polished Chrome Frame										
	COR5-41C	1304	1330	1355	1405	1458	1509	1560	1612	1714	

### ORDERING NOTES:

When ordering the Silver Metallic frame with Plastic Seat and Back, the arm color matches the seat and back.  
When ordering the Polished Chrome frame, arms are Polished Aluminum.

CAL 133 and Moisture Barrier options are available for an upcharge of **\$64 list per yard**.

### PRODUCT CODE KEY

Line	Series	Chair Style	Arm Style	Frame Finish
<b>COR</b>	<b>5</b> Barstool	<b>1</b> Plastic Seat & Back	<b>0</b> Armless	<b>S</b> Silver Metallic
		<b>2</b> Plastic with Upholstered Seat & Back Pads	<b>1</b> Arms	<b>C</b> Polished Chrome
		<b>3</b> Beech Wood Seat & Back		
		<b>4</b> Fully Upholstered Seat & Back		
		<b>5</b> Plastic Back, Plastic Seat with Upholstered Pad		
		<b>6</b> Beech Wood Back, Fully Upholstered Seat		

## LOUNGE SEATING

142	Avatar
145	Cressida
155	Leyton
170	Zola
187	Zola Privacy
253	Faeron
265	Sutton
267	Carlyle
269	Brio
271	Sloane

## LEED CI CREDITS



MATERIAL CONTENT:

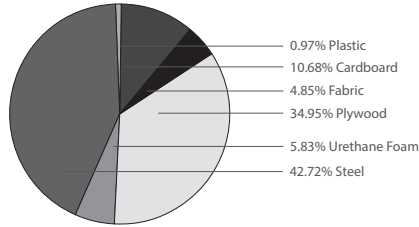

PRE-CONSUMER RECYCLED CONTENT = 11.21%

POST-CONSUMER RECYCLED CONTENT = 18.77%

Up to 45.10% of this Avatar product is recyclable at the end of its useful life.

### CONTRIBUTES TO

CREDIT 2.1 - 2.2	Construction Waste Management	1-2 point(s)
CREDIT 3.3	Resource Reuse	1 point
CREDIT 4.1	Recycled Content	1 point
CREDIT 4.2	Recycled Content	1 point
CREDIT 4.5	Low Emitting Materials, Systems & Seating	1 point
CREDIT 5.1	Regional Materials*	1 point
CREDIT 7	Certified Wood (MUST BE REQUESTED)	1 point(s)

\*This credit is only applicable if in total 20% of the combined value of the procurement of construction materials and in the furniture are manufactured within a radius of 500 miles. This credit will apply if the installation of the finished product occurs within 500 miles of Kitchener, Ontario.

## level® CERTIFICATION, AIR EMISSIONS AND FSC® CERTIFICATION



### level® CERTIFICATION

BIFMA's e3 Furniture Sustainability Standard is a voluntary, multi-attribute standard that measures the degree of sustainability of furniture. This standard evaluates product and company environmental attributes and compliance systems in a wide range of elements which include Materials, Energy & Atmosphere, Human & Ecosystem Health and Social Responsibility. Avatar products have earned level®, BIFMA's sustainability certification program for furniture, certification through third-party verification against the e3 standard.

### AIR-EMISSIONS

All Avatar products are supplied with air-emissions certified. Contact customer service for information.



### FSC®

In 2005, Krug received Forest Stewardship Council® (FSC®) Chain-of-Custody certification for our manufacturing facilities. The FSC® Chain-of-Custody tracks certified wood from seedling to final sale. It verifies that the material for our FSC® certified products only come from well-managed, FSC®-certified forests and other controlled sources. FSC® is dedicated to the promotion of responsible forest management worldwide helping to take care of forests for future generations. Avatar and other Krug products can be specified with FSC® Certification. Contact customer service for further information, pricing and lead times.



Architects, designers, and building professionals can specify FSC®-certified products in order to achieve a point from the U.S. Green Building Council's Leadership in Energy and Environmental Design (LEED) Rating System.

# AVATAR | FEATURES & OPTIONS



**STYLE**  
FIXED ARM

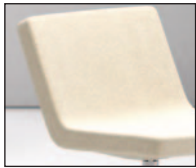

ARMLESS



**LEGS**  
Avatar legs feature Polished Chrome aluminum foot with nylon glides.

### REPLACEABLE COMPONENTS

Avatar is uniquely designed to allow major components to be field replaced, providing a very cost effective means to significantly extend the life of the product. Chair legs, arms, table tops and bases are field replaceable.

### FINISH DURABILITY

The Krug's finish, a proprietary catalyzed varnish formulation, has been repeatedly shown, through independent laboratory testing, to be the industry leader in durability and abrasion resistance. The Krug finish looks better longer than competitors, and is uniquely suited to the demands of high traffic environments.

### WEIGHT CAPACITIES

Avatar complies with ANSI/BIFMA x5.1-2011 test standards. Avatar has a load tested up to 300lbs.

## OPTIONS

### CAL 133 & MOISTURE BARRIER

California Technical Bulletin 133 is a flammability test for seating. Krug offers a compliance method which, in combination with non-flammable upholstery covers, may enable the products to meet certification requirements for this test. This process at the same time also provides the products with a Moisture Barrier - a treatment that helps to prevent the passage of liquids and moisture to inside of upholstered components - thereby conferring sanitary and anti-infection benefits. So when CAL 133 is specified, the product also automatically has a Moisture Barrier, and when a Moisture Barrier is specified, the product also features the compliance method and low flammability features of CAL 133.

The application of this upcharge and the compliance method does not mean that the specific configuration of product and upholstery cover are tested and officially certified as being CAL 133 compliant. If official certification is required, Krug will provide this (through an independent certified testing laboratory) at a charge of \$917 per item, plus the cost of the product to be tested. Lead time for certification testing is typically 4-8 weeks. Krug assumes no responsibility for the testing of our products in combination with upholstery covers, or for the results of any testing conducted. Some specific configurations of product and upholstery have already been tested. Please contact Customer Service for additional information.

## DIMENSIONS & COM REQUIREMENTS



	Overall Width	Overall Depth	Overall Height	Seat Height	Seat Depth	Width Between Arms	Arm Height	Shipping Weight	Cube	COM Yardage
AVA3-1	29	28	30.5	16	18.5	27.5	22	49	17.5	2.65
AVA3-0	26.5	28	30.5	16	18.5	n/a	n/a	46	17.5	2.65

### DIMENSIONS:

All dimensions are in inches and approximate and are subject to change without notice. Contact Customer Service if dimensions are critical.



# AVATAR | LOUNGE

Description	Model	COM		COL	FABRIC GRADES			LEATHER		
		1	2	3	4	5	6	7	8	9
	Armless AVA3-0	1883	1954	2026	2126	2239	2340	2453	2595	2739
	Fixed Arm AVA3-1	2100	2170	2241	2342	2458	2555	2670	2812	2956

## Avatar Option Upcharges

## \$ List

CAL 133 & Moisture Barrier (per yard)

64

## PRODUCT CODE KEY

Line	Series	Arm Style
AVA	3	1
Avatar	Soft Seating	Fixed Arm
		0
		Armless

# CRESSIDA | ENVIRONMENTAL SUMMARY

## LEED CI CREDITS



MATERIAL CONTENT:

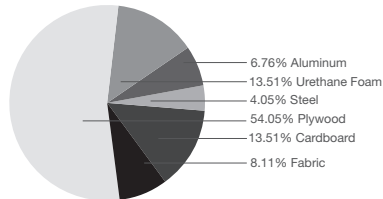

PRE-CONSUMER  
RECYCLED CONTENT - 4.22%

POST-CONSUMER  
RECYCLED CONTENT - 14.49%

Up to 24.32% of this Cressida product is recyclable at the end of its useful life.

### CONTRIBUTES TO

CREDIT 2.1 - 2.2	Construction Waste Management	1-2 point(s)
CREDIT 3.3	Resource Reuse	1 point
CREDIT 4.1	Recycled Content	1 point
CREDIT 4.5	Low Emitting Materials, Systems & Seating	1 point
CREDIT 5.1	Regional Materials*	1 point
CREDIT 7	Certified Wood (MUST BE REQUESTED)	1 point(s)

## level® CERTIFICATION, AIR EMISSIONS AND FSC® CERTIFICATION



### level® CERTIFICATION

BIFMA's e3 Furniture Sustainability Standard is a voluntary, multi-attribute standard that measures the degree of sustainability of furniture. This standard evaluates product and company environmental attributes and compliance systems in a wide range of elements which include Materials, Energy & Atmosphere, Human & Ecosystem Health and Social Responsibility. Cressida products have earned level®, BIFMA's sustainability certification program for furniture, certification through third-party verification against the e3 standard.



FSC  
www.fsc.org  
FSC® C021899

The mark of responsible forestry

### AIR EMISSIONS

All Cressida products are supplied air-emissions certified. Contact customer service for information.

### FSC®

In 2005, Krug received Forest Stewardship Council® (FSC®) Chain-of-Custody certification for our manufacturing facilities. The FSC® Chain-of-Custody tracks certified wood from seedling to final sale. It signifies that the growth, harvesting and production of goods are entirely achieved through responsible forestry, which guarantees a healthy supply of forest resources for generations to come.

Contact customer service for further information, pricing and leadtimes.



Architects, designers, and building professionals can specify FSC®-certified products in order to achieve a point from the U.S. Green Building Council's Leadership in Energy and Environmental Design (LEED) Rating System.

# CRESSIDA | LOUNGE FEATURES & OPTIONS



## CLEAN OUT

Cressida lounge seating models have a built-in clean out feature: a space at the back of the seat that allows dirt, debris and liquid to fall to the floor for easy clean up and maintenance - designed so that it does not detract from the comfort or appearance of the product.



## ARMS AND ARMLESS

Cressida features five arm options; Armless, Open Arm, Open Arm Polymer Arm Cap, Closed Arm, Closed Arm Polymer Arm Cap. Polymer arm cap is available in Black or Grey.



## POLYMER ARM CAP

Available in Grey and Black colors, the Arm Cap is field- replaceable if necessary.

## GLIDES

Cressida Lounge arm and armless versions are standard with nylon glides.

## WEIGHT CAPACITIES

Cressida weight capacities are as follows:

- One-Seat-350 lbs
- One-Seat (Plus) -750 lbs
- One-Seat Wide - 350lbs
- One-Seat Wide (Plus) - 750lbs
- Two-Seat - 525 lbs
- Two-Seat (Plus) - 975lbs
- Three-Seat - 850 lbs
- Three-Seat (Plus) - 1200 lbs

## REPLACEABLE COMPONENTS

Cressida Lounge chairs are uniquely designed to allow virtually all components to be field replaced, providing a very cost effective means to significantly extend the life of the product. Seats, backs and arms are field replaceable.

## OPTIONS



## CASTERS

Cressida Lounge is available with the option of casters. Caster option comes with the two rear casters locking as standard.



## PUSH BAR

This is a option on Cressida lounge when ordered with casters, ergonomically designed to assist care-giving staff in the movement and operation of the chair, and reduce back strain on the caregiver. The push bar is powder-coated steel in Silver Metallic finish.

## PLUS UPGRADE

Cressida seating is available with optional Plus Upgrade. Plus Upgraded seating has been engineered to support higher weight capacities, accommodating a wider variety of users.



## TABLETS

Optional Tablets are available on the Cressida Lounge & Modular in veneer, glass, high pressure laminate, solid surface and palette finishes. The Cressida tablet can be fastened to the Cressida Lounge & Modular chairs by the Universal Tablet Mount (mounted left or right), to existing legs and features an elliptical shape of 16 1/2" x 11 1/2" x 3/4" in size. The Cressida Tablet has a turning radius of 360 degrees, which accommodates any worksurface angle.

## COMBINATION UPHOLSTERY

More than one upholstery cover within the same unit, is an option on all Cressida upholstered products. When combination upholstered products is with upholstery of the same grade or COM, an upcharge for dual fabrics is **\$33 list** per unit and **\$64 list** per unit for three fabrics. When graded in combination upholstery is selected, use the highest grade upholstery selected or contact Customer Service for a quote -please provide the fabrics specified and a description of where each fabric is to be applied on the product in order to obtain a quote.

## METAL FINISH OPTIONS

Silver Metallic frames are available with an anti-microbial finish for an upcharge of **\$64 list** per arm frame pair or table. Additional Frame Finishes, which include anti-microbial finish, are available for an upcharge of **\$64 list** per arm frame pair or table. Available colors are: White, Parchment, Sand, Taupe, Warm Grey, Cool Grey or Black. For all metal finishes other than Silver Metallic Standard, there is a minimum order quantity of 30 units per color. Upcharges for order quantities less than 30 units per color or custom metal finishes, please contact Customer Service to obtain a quote.

## MOISTURE BARRIER & CAL 133

California Technical Bulletin 133 is a flammability test for seating. Krug offers a compliance method, in combination with non-flammable upholstery covers, may enable products to meet certification requirements for this test. This process at the same time also provides the products with a Moisture Barrier - a treatment that helps to prevent the passage of liquids and moisture to inside of the upholstered components - thereby conferring sanitary and anti-infection benefits. So when CAL 133 is specified, the product also automatically has a Moisture Barrier, and when a Moisture Barrier is specified, the product also features the compliance method and low flammability features of CAL 133. The application of this up-charge and the compliance method does not mean that the specific configuration of product and upholstery cover are tested and officially certified as being CAL133 compliant. If the official certification is required, Krug will provide this (through an independent certified testing laboratory) at a charge of \$917 per item, plus the cost of the product to be tested. Lead time for certification testing is typically 4-8 weeks.

## REMOVABLE AND REPLACEABLE COVERS

Cressida Lounge Chairs are available with removable seat and back covers.

# CRESSIDA | LOUNGE

## DIMENSIONS & COM REQUIREMENTS

	Overall Width	Overall Depth	Overall Height	Seat Height	Height of Arms from Floor	Width Between Arms	Seat Depth	Shipping Weight Open Arm	Shipping Weight Closed Arm	Cube
<b>WITH ARMS</b>										
One-Seat	29.5	30.5	32.5	17.25	25.75	23	19.75	52	74	22
One-Seat Wide	36.5	30.5	32.5	17.25	25.75	30	19.75	62	84	34
Two-Seat	52.25	30.5	32.5	17.25	25.75	45.75	19.75	81	103	34
Three-Seat	75	30.5	32.5	17.25	25.75	68.5	19.75	104	126	49
<b>ARMLESS</b>										
One-Seat	23	30.5	32.5	17.25	-	-	19.75	47	-	22
One-Seat Wide	30	30.5	32.5	17.25	-	-	19.75	57	-	34
Two-Seat	45.75	30.5	32.5	17.25	-	-	19.75	76	-	34
Three-Seat	68.75	30.5	32.5	17.25	-	-	19.75	99	-	49

Note: Cressida plus two-seat and three-seat units have the same dimensions as the regular two-seat and three-seat units.

## COM - YARDAGE REQUIREMENTS

	COM Yardage Seat, Back & Arms	COM Yardage Seat & Back	COM Yardage Seat Only	COM Yardage Back Only	COM Yardage Closed Arms (2) Only
One-Seat - One Chair	5	2.7	1.27	1.83	2.9
One-Seat - Two Chairs	9.7	5	2.03	2.7	5.8
One-Seat - Three Chairs	14.7	7.75	3.57	4.53	8.7
One-Seat - Four Chairs	15.4	10	4.06	5.4	11.6
One-Seat Wide - One Chair	6.4	3.5	1.64	1.9	2.9
One-Seat Wide - Two Chairs	12.8	7	3.28	3.8	5.8
One-Seat Wide - Three Chairs	19.2	10.5	4.92	5.7	8.7
One-Seat Wide - Four Chairs	25.6	14	6.56	7.6	11.6
Two-Seat - One Chair	6.4	4	1.7	2.7	2.9
Two-Seat - Two Chairs	12.8	8	3.4	4.6	5.8
Two-Seat - Three Chairs	19.2	12	5.1	7.3	8.7
Two-Seat - Four Chairs	25.6	16	6.8	9.2	11.6
Three-Seat - One Chair	7.6	5.5	2.6	3.4	2.9
Three-Seat - Two Chairs	15.2	11	4.6	6.4	5.8
Three-Seat - Three Chairs	22.8	16.5	7.2	9.8	8.7
Three-Seat - Four Chairs	30.4	22	9.2	12.8	11.6

Note: Some vinyls, leathers & upholsteries are not suitable for application on Cressida seating. Please refer to page 333 for C.O.M approval process.

## ORDERING NOTES:

**Combination upholstery** (more than one upholstery cover within the same unit) is an option on all Cressida upholstered products. When combination upholstery is with upholstery of the same grade or COM, an upcharge for dual fabrics is **\$33 list** per unit and **\$64 list** per unit for three fabrics. When graded in combination upholstery is selected, use the highest grade upholstery selected or contact Customer Service for a quote - please provide the fabrics specified and a description of where each fabric is to be applied on the product in order to obtain a quote.

Cressida Lounge Option Upcharges	\$ List		\$ List
Moisture Barrier (per yard)	64	One-Seat Removable Back Covers	152
Push Bar	64	One-Seat Wide Removable Back Covers	228
Caster Combination (2 legs & 2 rear casters)	152	Two-Seat Removable Back Covers	302
Castors (set of 4)	228	Three-Seat Removable Back Covers	453
One-Seat Removable Seat Covers	152	One-Seat - Plus Upgrade	92
One-Seat Wide Removable Seat Covers	228	One-Seat Wide - Plus Upgrade	121
Two-Seat Removable Seat Covers	302	Two-Seat - Plus Upgrade	199
Three-Seat Removable Seat Covers	453	Three-Seat - Plus Upgrade	228

**NOTE:** Caster options are available for One-Seat size only, and cannot be combined with the Plus Upgrade option.

# CRESSIDA | LOUNGE

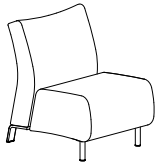
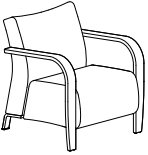
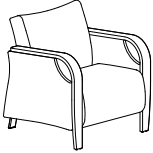
DESCRIPTION/MODEL/SPECIES	COM		COL		FABRIC GRADES			LEATHER		
	1	2	3	4	5	6	7	8	9	
 One-Seat, Armless CRE3-F1ALS1 n/a	1566	1647	1747	1875	2018	2145	2287	2470	2650	
 One-Seat, Open Arm CRE3-F1OPS1 Beech, Maple Palette	1801	1897	1988	2103	2252	2394	2536	2703	2891	
One-Seat, Open Arm with arm cap CRE3-F1OPP1 Beech, Maple Palette	1875	1974	2063	2174	2326	2470	2612	2778	2966	
 One-Seat, Closed Arm CRE3-F1CLS1 Beech, Maple Palette	2523	2686	2853	3088	3357	3591	3862	4203	4532	
One-Seat, Closed Arm with arm cap CRE3-F1CLP1 Beech, Maple Palette	2596	2764	2928	3162	3432	3666	3936	4277	4608	

## ORDERING NOTES:

**Combination upholstery** (more than one upholstery cover within the same unit) is an option on all Cressida upholstered products. When combination upholstery is with upholstery of the same grade or COM, an upcharge for dual fabrics is **\$33 list** per unit and **\$64 list** per unit for three fabrics. When graded in combination upholstery is selected, use the highest grade upholstery selected or contact Customer Service for a quote -please provide the fabrics specified and a description of where each fabric is to be applied on the product in order to obtain a quote.

All Cressida lounge are capable of being upgraded to Plus weight capacity. To order please add a "B" after the 4th digit / before the size, and add appropriate upcharge below.

Example: One-Seat – Open Arm = CRE3-F10PS1, to upgrade to Plus add a "B" = CRE3-FB10PS1

Cressida Lounge Option Upcharges	\$ List		\$ List
Moisture Barrier (per yard)	64	One-Seat Removable Seat Covers	152
Push Bar	64	One-Seat Removable Back Covers	152
Caster Combination (2 legs & 2 rear casters)	152	One-Seat - Plus Upgrade	92
Casters (set of 4)	228		

**NOTE:** Caster options are available for One-Seat size only, and cannot be combined with the Plus Upgrade option.

## PRODUCT CODE KEY

Line	Series	Chair Style	Size	Arm Style	Leg Style
<b>CRE</b> Cressida	<b>3</b> Lounge	<b>F</b> Freestanding	<b>1</b> One-Seat	<b>ALS</b> Armless	<b>1</b> Legs
		<b>FB</b> Freestanding Plus	<b>1.5</b> One-Seat Wide	<b>OPS</b> Open Arm	<b>2</b> Casters
			<b>2</b> Two-Seat	<b>OPP</b> Open Arm Polymer Arm Cap	<b>3</b> Caster Combination 2 legs & 2 Rear Casters
			<b>3</b> Three-Seat	<b>CLS</b> Closed Arm	
				<b>CLP</b> Closed Arm Polymer Arm Cap	

# CRESSIDA | LOUNGE

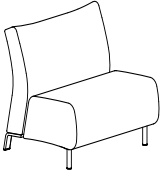
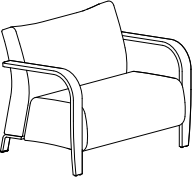
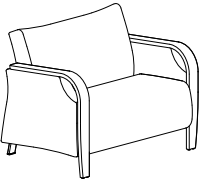
DESCRIPTION/MODEL/SPECIES	COM		COL	FABRIC GRADES			LEATHER		
	1	2	3	4	5	6	7	8	9
 One-Seat Wide, Armless CRE3-FB1.5ALS1 n/a	1657	1765	1872	2026	2198	2353	2527	2744	2963
 One-Seat Wide, Open Arm CRE3-FB1.5OPS1 Beech, Maple Palette	1923	2031	2140	2294	2466	2620	2794	3013	3232
One-Seat Wide, Open Arm with arm cap CRE3-FB1.5OPP1 Beech, Maple Palette	1998	2107	2217	2369	2542	2705	2870	3090	3307
 One-Seat Wide, Closed Arm CRE3-FB1.5CLS1 Beech, Maple Palette	2639	2824	3011	3271	3568	3829	4128	4494	5159
One-Seat Wide, Closed Arm with arm cap CRE3-FB1.5CLP1 Beech, Maple Palette	2715	2899	3088	3346	3644	3906	4204	4570	5235

## ORDERING NOTES:

**Combination upholstery** (more than one upholstery cover within the same unit) is an option on all Cressida upholstered products. When combination upholstery is with upholstery of the same grade or COM, an upcharge for dual fabrics is **\$33 list** per unit and **\$64 list** per unit for three fabrics. When graded in combination upholstery is selected, use the highest grade upholstery selected or contact Customer Service for a quote -please provide the fabrics specified and a description of where each fabric is to be applied on the product in order to obtain a quote.

All Cressida lounge are capable of being upgraded to Plus weight capacity. To order please add a "B" after the 4th digit / before the size, and add appropriate upcharge below.

Example: One-Seat – Open Arm = CRE3-F10PS1, to upgrade to Plus add a "B" = CRE3-FB10PS1

## Cressida Lounge Option Upcharges \$ List

Moisture Barrier (per yard)	64
One-Seat Wide - Plus Upgrade	121
One-Seat Wide Removable Seat Covers	228
One-Seat Wide Removable Back Covers	228

**NOTE:** One-Seat Wide Lounge is not available with caster options.

## PRODUCT CODE KEY

Line	Series	Chair Style	Size	Arm Style	Leg Style
CRE Cressida	3 Lounge	F Freestanding	1 One-Seat	ALS Armless	1 Legs
		FB Freestanding Plus	1.5 One-Seat Wide	OPS Open Arm	
			2 Two-Seat	OPP Open Arm Polymer Arm Cap	
			3 Three-Seat	CLS Closed Arm	
				CLP Closed Arm Polymer Arm Cap	

# CRESSIDA | LOUNGE

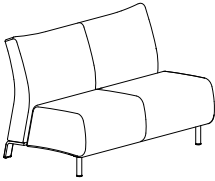
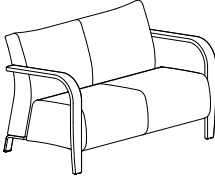
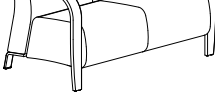
DESCRIPTION/MODEL/SPECIES	COM		COL	FABRIC GRADES			LEATHER		
	1	2	3	4	5	6	7	8	9
 Two-Seat, Armless CRE3-F2ALS1 n/a	2590	2726	2853	3049	3260	3448	3666	3931	4203
 Two-Seat, Open Arm CRE3-F2OPS1 Beech, Maple Palette	2823	2958	3095	3283	3499	3688	3899	4171	4442
Two-Seat, Open Arm with arm cap CRE3-F2OPP1 Beech, Maple Palette	2898	3035	3167	3357	3577	3763	3975	4245	4515
 Two-Seat, Closed Arm CRE3-F2CLS1 Beech, Maple Palette	3545	3757	3966	4261	4600	4893	5232	5660	6081
Two-Seat, Closed Arm with arm cap CRE3-F2CLP1 Beech, Maple Palette	3620	3830	4041	4336	4675	4968	5307	5738	6158

**ORDERING NOTES:**

**Combination upholstery** (more than one upholstery cover within the same unit) is an option on all Cressida upholstered products. When combination upholstery is with upholstery of the same grade or COM, an upcharge for dual fabrics is **\$33 list** per unit and **\$64 list** per unit for three fabrics. When graded in combination upholstery is selected, use the highest grade upholstery selected or contact Customer Service for a quote -please provide the fabrics specified and a description of where each fabric is to be applied on the product in order to obtain a quote.

All Cressida lounge are capable of being upgraded to Plus weight capacity. To order please add a "B" after the 4th digit / before the size, and add appropriate upcharge below.  
Example: One-Seat – Open Arm = CRE3-F10PS1, to upgrade to Plus add a "B" = CRE3-FB10PS1

Cressida Lounge Option Upcharges	\$ List
Moisture Barrier (per yard)	64
Two-Seat - Plus Upgrade	199
Two-Seat Removable Seat Covers	290
Two-Seat Removable Back Covers	290

**NOTE:** Two-Seat Lounge is not available with caster options

**PRODUCT CODE KEY**

Line	Series	Chair Style	Size	Arm Style	Leg Style
<b>CRE</b> Cressida	<b>3</b> Lounge	<b>F</b> Freestanding	<b>1</b> One-Seat	<b>ALS</b> Armless	<b>1</b> Legs
		<b>FB</b> Freestanding Plus	<b>1.5</b> One-Seat Wide	<b>OPS</b> Open Arm	
			<b>2</b> Two-Seat	<b>OPP</b> Open Arm Polymer Arm Cap	
			<b>3</b> Three-Seat	<b>CLS</b> Closed Arm	
				<b>CLP</b> Closed Arm Polymer Arm Cap	

# CRESSIDA | LOUNGE

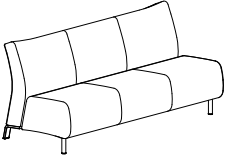
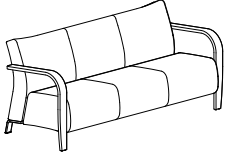
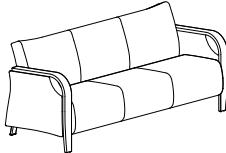
DESCRIPTION/MODEL/SPECIES	COM		COL	FABRIC GRADES			LEATHER		
	1	2	3	4	5	6	7	8	9
 Three-Seat, Armless CRE3-F3ALS1 n/a	3516	3706	3885	4141	4442	4697	4992	5361	5727
 Three-Seat, Open Arm CRE3-F3OPS1 Beech, Maple Palette	3757	3936	4127	4381	4675	4939	5232	5602	5969
Three-Seat, Open Arm with arm cap CRE3-F3OPP1 Beech, Maple Palette	3830	4011	4203	4381	4750	5012	5307	5677	6045
 Three-Seat, Closed Arm CRE3-F3CLS1 Beech, Maple Palette	4471	4735	4998	5361	5782	6149	6565	7091	7611
Three-Seat, Closed Arm with arm cap CRE3-F3CLP1 Beech, Maple Palette	4546	4812	5075	5436	5857	6225	6640	7164	7684

### ORDERING NOTES:

**Combination upholstery** (more than one upholstery cover within the same unit) is an option on all Cressida upholstered products. When combination upholstery is with upholstery of the same grade or COM, an upcharge for dual fabrics is **\$33 list** per unit and **\$64 list** per unit for three fabrics. When graded in combination upholstery is selected, use the highest grade upholstery selected or contact Customer Service for a quote -please provide the fabrics specified and a description of where each fabric is to be applied on the product in order to obtain a quote.

All Cressida lounge are capable of being upgraded to Plus weight capacity. To order please add a "B" after the 4th digit / before the size, and add appropriate upcharge below.

Example: One-Seat – Open Arm = CRE3-F10PS1, to upgrade to Plus add a "B" = CRE3-FB10PS1

### Cressida Lounge Option Upcharges \$ List

Moisture Barrier (per yard)	64
Three-Seat - Plus Upgrade	228
Three-Seat Removable Seat Covers	453
Three-Seat Removable Back Covers	453

**NOTE:** Three-Seat Lounge is not available with caster options



### PRODUCT CODE KEY

Line	Series	Chair Style	Size	Arm Style	Leg Style
CRE Cressida	3 Lounge	F Freestanding	1 One-Seat	ALS Armless	1 Legs
		FB Freestanding Plus	1.5 One-Seat Wide	OPS Open Arm	
			2 Two-Seat	OPP Open Arm Polymer Arm Cap	
			3 Three-Seat	CLS Closed Arm	
				CLP Closed Arm Polymer Arm Cap	





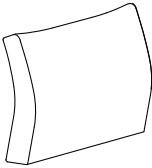
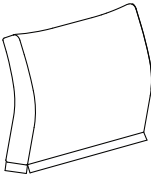
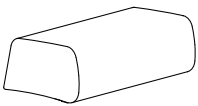
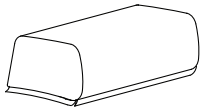
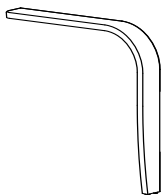
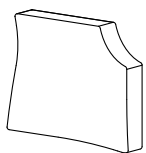

# CRESSIDA | REPLACEMENT LOUNGE COMPONENTS

DESCRIPTION	MODEL	COM		COL 3	FABRIC GRADES			LEATHER			WEIGHT	CUBE
		1	2		4	5	6	7	8	9		
	One-Seat Replacement Back CRE3-RB1	715	778	837	922	1021	1108	1205	1330	1451	23	4.2
	One-Seat Wide Replacement Back CRE3-RB1.5B	808	872	935	1026	1126	1215	1317	1446	1570	28	5.7
	Two-Seat Replacement Back CRE3-RB2	1058	1146	1237	1363	1509	1636	1779	1962	2143	38	8.8
	Three-Seat Replacement Back CRE3-RB3	1414	1528	1642	1802	1984	2143	2324	2554	2780	52	12
	One-Seat Replacement Back Cover CRE3-RBC1	290	348	410	494	595	679	780	901	1026	2.0	1.0
	One-Seat Wide Replacement Back Cover CRE3-RBC1.5	302	365	428	517	620	710	810	939	1065	2.5	1.2
	Two-Seat Replacement Back Cover CRE3-RBC2	403	492	584	710	853	982	1126	1307	1487	3.5	1.8
	Three-Seat Replacement Back Cover CRE3-RBC3	463	577	693	851	1033	1194	1376	1604	1833	5.0	2.5
	One-Seat Replacement Seat CRE3-RS1	603	648	693	752	821	883	954	1039	1126	28	9.5
	One-Seat Wide Replacement Seat CRE3-RS1.5	782	838	892	971	1060	1137	1226	1334	1446	35	12.0
	Two-Seat Replacement Seat CRE3-RS2	939	995	1054	1135	1224	1304	1394	1509	1622	53	18
	Three-Seat Replacement Seat CRE3-RS3	1257	1345	1431	1555	1691	1813	1954	2130	2302	79	24
	One-Seat Replacement Seat Cover CRE3-RSC1	208	253	297	357	427	487	559	644	731	2.0	1.0
	One-Seat Wide Replacement Seat Cover CRE3-RSC1.5	259	313	369	448	536	613	701	811	922	2.5	1.2
	Two-Seat Replacement Seat Cover CRE3-RSC2	276	334	390	471	561	641	732	846	959	3.5	1.8
	Three-Seat Replacement Seat Cover CRE3-RSC3	352	438	527	648	785	909	1048	1224	1396	5.0	2.5
	Replacement Lounge Front Arm & Leg Open Arm CRE3-LROPS Beech, Maple Palette	185									4.0	1.3
	Open Arm Polymer Cap CRE3-LROPP Beech, Maple Palette	223										
	Replacement Closed Arm Panel CRE3-RCA Beech, Maple	406	454	502	569	648	716	794	892	988	20	3.8
	Lounge Replacement Push-Bar CRE3-RPB	61									2	0.3

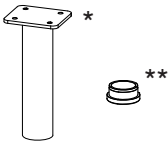
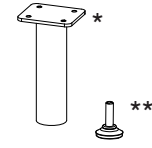
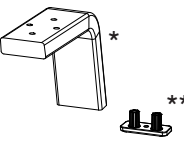
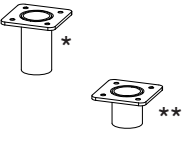
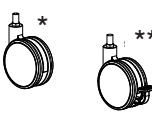
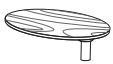
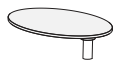
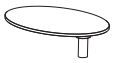
# CRESSIDA | LOUNGE & TABLE REPLACEMENT COMPONENTS

DESCRIPTION	MODEL	PRICE	WEIGHT CUBE				
	Replacement Polymer Arm Cap Black CRE3-RACB	38	1.0	0.5			
	Replacement Polymer Arm Cap Grey CRE3-RACB	38					
	Lounge Replacement Front Leg (for armless version) CRE3-RLAF*	59	0.5	0.5			
	Lounge Replacement Front Leg (for armless version) Glide CRE3-RGAF**	18	0.1	0.2			
	Lounge Replacement Plus Upgrade Center Leg CRE3-RLC*	54	0.5	0.5			
	Lounge Replacement Plus Upgrade Center Leg Glide CRE3-RCG**	23	0.5	0.5			
	Lounge Replacement Back Leg CRE3-RLB*	78	1.8	0.5			
	Lounge Replacement Glide CRE3-RGB**	19	0.1	0.2			
	Lounge Replacement Front Leg (for caster version) CRE3-RLCF*	54	0.5	0.5			
	Lounge Replacement Back Leg (for caster version) CRE3-RLCB**	54	0.5	0.5			
	Replacement Casters Non-Locking CRE3-RC1*	74	.75	0.3			
	Replacement Casters Locking CRE3-RC2**	74	.75	0.3			
	Wood Tablet & Mounting Plate Only CRE3 RT1 Beech/Maple	397	5	0.32			
	Tablet with Palette finish & Mounting Plate Only CRE3 RT2 n/a	278	5	0.32			
	Tablet & Mounting Plate Only - Solid Surface CRE3 RT3 n/a	<b>Grades</b>					
		<b>A-White</b>	<b>A-Color</b>	<b>B</b>	<b>C</b>		
		539	547	577	624	7	0.32
	Laminate Tablet & Mounting Plate Only CRE3 RT4 n/a	397	5	0.32			

# LEYTON | ENVIRONMENTAL SUMMARY

## LEED CI CREDITS



MATERIAL CONTENT:

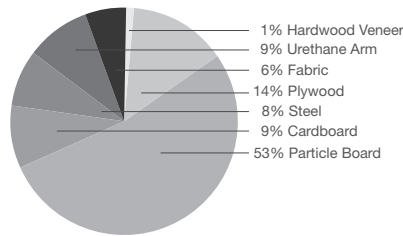

PRE-CONSUMER  
RECYCLED CONTENT = 28.61%

POST-CONSUMER  
RECYCLED CONTENT = 9.91%

Up to 8.81% of this Leyton product is recyclable at the end of its useful life.

### CONTRIBUTES TO

CREDIT	CONTRIBUTES TO	POINTS
CREDIT 2.1 - 2.2	Construction Waste Management	1-2 point(s)
CREDIT 3.3	Resource Reuse	1 point
CREDIT 4.1	Recycled Content	1 point
CREDIT 4.2	Recycled Content	1 point
CREDIT 4.5	Low Emitting Materials, Systems & Seating	1 point
CREDIT 5.1	Regional Materials*	1 point
CREDIT 7	Certified Wood (MUST BE REQUESTED)	1 point(s)

\*This credit is only applicable if in total 20% of the combined value of the procurement of construction materials and in the furniture are manufactured within a radius of 500 miles. This credit will apply if the installation of the finished product occurs within 500 miles of Kitchener, Ontario.

## level® CERTIFICATION, AIR EMISSIONS AND FSC® CERTIFICATION



### level® CERTIFICATION

BIFMA's e3 Furniture Sustainability Standard is a voluntary, multi-attribute standard that measures the degree of sustainability of furniture. This standard evaluates product and company environmental attributes and compliance systems in a wide range of elements which include Materials, Energy & Atmosphere, Human & Ecosystem Health and Social Responsibility. Leyton products have earned level®, BIFMA's sustainability certification program for furniture, certification through third-party verification against the e3 standard.

### AIR EMISSIONS

All Leyton products are supplied air-emissions certified. Contact customer service for information and upcharges.



the mark of responsible forest

### FSC®

In 2005, Krug received Forest Stewardship Council® (FSC®) Chain-of-Custody certification for our manufacturing facilities. The FSC® Chain-of-Custody tracks certified wood from seedling to final sale. It verifies that the material for our FSC® certified products only come from well-managed, FSC®-certified forests and other controlled sources. FSC® is dedicated to the promotion of responsible forest management worldwide helping to take care of forests for future generations. Leyton and other Krug products can be specified with FSC® Certification. Contact customer service for further information, pricing and lead times.

In addition, architects, designers, and building professionals can specify FSC®-certified products in order to achieve a point from the US Green Building Council's Leadership in Energy and Environmental Design (LEED) Rating System.



# LEYTON | FINISHES & FEATURES

## WOOD FINISHES

Standard wood finishes are:

SPECIES	FINISH
<b>OAK</b>	Light Oak SilverGrey on Oak Espresso Oak Harvest Oak Mahogany Mellow oak
<b>MAPLE</b>	Clear Maple Honey Maple Wheat Maple
<b>WALNUT</b>	Natural Walnut SilverGrey on Walnut Regular Walnut Dark Walnut Cordovan Walnut
<b>CHERRY</b>	Appalachian Cherry American Cherry Imperial Cherry Sable Cherry Light Cherry Medium Cherry Natural Cherry Standard Cherry
<b>ANIGRE</b>	Clear Anigre Medium Anigre
<b>SYCAMORE</b>	Clear Sycamore

Please note Cherry, Anigre and Sycamore species require a minimum quantity order, of 5 units for seating and 5 units for tables, per species.

PALETTE	
	Black
	White
	Sand
	Soft Green
	Steel Blue
	Slate

## VENEERS

Leyton veneers are quarter cut, except for White Oak, which is rift cut - both quarter cut and rift cut veneers provide a straight grain appearance. The grain direction of the veneers on vertical faces is horizontal.

## NON-STANDARD VENEER SPECIES

In addition to range of standard wood species, Leyton can be made with virtually any commercially available veneers. Please contact customer service for information and pricing on wood species not included in Leyton's standard offering.

## NATURAL CHARACTERISTICS OF WOOD

Wood is a natural product with inherent color variations that will never be fully mitigated by the finishing process. Please anticipate variation in colors within a single unit, from piece to piece, and from Krug wood finish samples. If a very close match is required, a sample must be provided with the order and an upcharge will apply. Exact color matches are not possible.

## CUSTOM WOOD FINISHES

Add 10% list to your order for special finishes, minimum upcharge is \$500 list per finish per order. (For example, on all orders up to \$5000 list, an upcharge of \$500 will apply, on orders \$5000 and up add 10% list to your order.)

For orders with special finishes, a sample that is a minimum 3" by 3" must be received with the order. Special finishes may add additional lead time to production schedules.

## ENDURAGUARD FINISH

Leyton features the Krug finish, a proprietary catalyzed varnish formulation, that has repeatedly shown through independent laboratory testing to be the industry leader in durability and abrasion resistance. The Krug finish looks better longer than competitors and is uniquely suited to the demands of high traffic environments.

## IN-STOCK LAMINATE

Krug's in-stock laminates are available on Leyton Table surfaces in 4 solid laminate selections. Laminate surfaces are self-edged.

## SOLID LAMINATES

Designer White - Platinum - Earth - Charcoal

# LEYTON | FEATURES



### ARM STYLE

Leyton features four design styles Upholstered Armless, Upholstered Full Arm, Wood Surround Armless and Wood Surround Full Arm.

Upholstered Armless



Upholstered Full Arm



Wood Surround Armless



Wood Surround Full Arm



### LEGS

Leyton Lounge and Tables feature Polished Chrome structural steel legs with Black glides. Non-marring glides are available upon request.

### REPLACEABLE COMPONENTS

Leyton chairs are uniquely designed to allow major components to be field replaced, providing a very cost effective means to significantly extend the life of the product. Seats, backs, arms and frames are field replaceable, with the only exceptions being the Upholstered Armless, Upholstered Full Arm and Upholstered Front Panel as it is one piece.

### WEIGHT CAPACITIES

All Leyton seating feature Plus Weight capacities.  
 One-Seat - 750lbs  
 One-seat Wide - 750lbs  
 Two-Seat - 975lbs  
 Three-Seat - 1200lbs  
 Leyton has been tested to ANSI / BIFMA.

### PLUS UPGRADE

Leyton models feature Plus Upgrade. Plus Upgraded seating has been engineered to support higher weight capacities, accommodating a wider variety of users.

# LEYTON | OPTIONS

## OPTIONS

### Solid Surface Arm Cap

Leyton Lounge Full Arm version is available with an optional Solid Surface Arm Cap providing enhanced durability, protection and cleanability for the arms. This is field replaceable if it becomes damaged or degraded and is available in 8 standard colors.

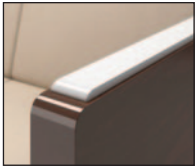

### TABLET

Leyton Solid Surface tablet can be specified left or right as seated. The tablet can be used alone or with solid surface arm cap and is 1/2" thick.



### PUSH BAR

This is an optional feature on Leyton One Seat lounge chairs, designed to assist caregiving staff in the movement and relocation of the chair. It is Silver Metallic in color and retractable for ease of use. The Push bar is field replaceable if necessary.

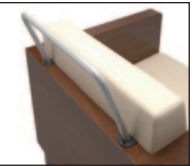

### CASTERS

Optional on Leyton lounge chairs are four - 4" diameter soft wheel swivel locking casters, featuring a large, easy-access foot activation and release lever. The caster locks both directionally and rotationally, keeping the chair securely in place when locked. Note: lounge chairs with casters are not designed or intended as patient transport devices.



### CLEAN OUT

Leyton lounge seating models have an optional built-in clean out feature: a space at the back of the seat that allows dirt debris and liquid to fall to the floor for easy clean up and maintenance - designed so that it does not detract from the comfort or appearance of the product. Clean Out option is available for an upcharge,



### UNDER-MOUNT POWER

The Under-mount Power unit provides dual power/USB C & A outlets for multiple devices. It can be located below seats and tables.



## COMBINATION UPHOLSTERY

When combination upholstery is with upholstery of the same grade or COM, an upcharge for dual fabrics is **\$33 list** per unit and **\$64 list** per unit for three fabrics will be applied. When graded in combination upholstery is selected, use the highest upholstery selected or contact Customer Service for a quote (please provide the fabrics specified and a description of where each fabric is to be applied on the product in order to obtain a quote)

## REMOVABLE COVERS & REPLACEMENT COMPONENTS

Optional Removeable covers (with the exception of the Upholstered Armless, Upholstered Full Arm and Front panel) can be quickly installed on Leyton products that were originally ordered with the Removeable cover option. Replacement covers (with the exception of the Upholstered Armless, Full Upholstered Arm and front panel) can also be installed on Leyton products that were not originally ordered with the Removeable cover option, with some simple staple removal.

## CAL 133 & MOISTURE BARRIER

California Technical Bulletin 133 is a flammability test for seating. Krug offers a compliance method which, in combination with non-flammable upholstery covers, may enable the products to meet certification requirements for this test. This process at the same time also provides the products with a Moisture Barrier - a treatment that helps to prevent the passage of liquids and moisture to inside of upholstered components - thereby conferring sanitary and anti-infection benefits. So when CAL 133 is specified, the product also automatically has a Moisture Barrier, and when a Moisture Barrier is specified, the product also features the compliance method and low flammability features of CAL 133. CAL 133 and Moisture Barrier are available for an upcharge, please see page 158.

The application of this upcharge and the compliance method does not mean that the specific configuration of product and upholstery cover are tested and officially certified as being CAL 133 compliant. If official certification is required, Krug will provide this (through an independent certified testing laboratory) at a charge of \$917 per item, plus the cost of the product to be tested. Lead time for certification testing is typically 4-8 weeks. Krug assumes no responsibility for the testing of our products in combination with upholstery covers, or for the results of any testing conducted. Some specific configurations of product and upholstery have already been tested. Please contact Customer Service for additional information.

# LEYTON | DIMENSIONS, COM REQUIREMENTS, MOISTURE BARRIER & OPTION UPCHARGES

## DIMENSIONS

	Overall Width	Overall Depth	Overall Height	Seat Height min/max	Height of Arms from Floor	Width between Arms	Seat Depth	Shipping Weight	Cube
LEY31UF	28.5	29.25	31	17.75	26.25	23.25	19.25	82	18.5
LEY31.5UF	35.5	29.25	31	17.75	26.25	30.25	19.25	107	25.2
LEY32UF	52	29.25	31	17.75	26.25	47	19.25	131	32.5
LEY33UF	75.75	29.25	31	17.75	26.25	70.5	19.25	179	46.5
LEY31UN	28.5	29.25	31	17.75	n/a	23.25	19.25	78	18.5
LEY31.5UN	35.5	29.25	31	17.75	n/a	30.25	19.25	103	25.2
LEY32UN	52	29.25	31	17.75	n/a	47	19.25	127	32.5
LEY33UN	75.75	29.25	31	17.75	n/a	70.5	19.25	175	46.5
LEY31WF	28.25	29.25	31	17.75	26.25	23.75	19.25	79	18.5
LEY31.5WF	35.25	29.25	31	17.75	26.25	30.25	19.25	104	25.2
LEY32WF	51.75	29.25	31	17.75	26.25	47.25	19.25	128	32.5
LEY33WF	75.5	29.25	31	17.75	26.25	71	19.25	176	46.5
LEY31WN	28.25	29.25	31	17.75	n/a	23.75	19.25	75	18.5
LEY31.5WN	35.25	29.25	31	17.75	n/a	30.25	19.25	100	25.2
LEY32WN	51.75	29.25	31	17.75	n/a	47.25	19.25	124	32.5
LEY33WN	75.5	29.25	31	17.75	n/a	71	19.25	172	46.5

All dimensions are in inches and approximate and are subject to change without notice. Contact Customer Service if dimensions are critical.

## COM YARDAGE REQUIREMENTS

	Fully Upholstered (Complete Unit)	Wood Surround (Seat and Back only)	Seat Cushion only (Wood or Full Uph)	Back Cushion only (Wood or Full Uph)	Full Arm & front panel (Pair)	Armless panel & front panel (pair)	Back Panel only	Full body with arm, Front panel & Back panel
One-Seat - One Chair								
Armless	3.75	1.6	0.9	0.8		1.75	.75	2.5
Full Arm	4.6	1.6	0.9	0.8	2.6		.75	3.35
One & Half-Seat - One Chair								
Armless	5.2	2.3	1.3	1		2.1	.75	2.85
Full Arm	5.7	2.3	1.3	1	2.6		.75	3.35
Two-Seat - One Chair								
Armless	5.7	3	1.5	1.5		2	.75	2.75
Full Arm	6.3	3	1.5	1.5	2.6		.75	3.35
Three-Seat - One Chair								
Armless	8	4.6	2.4	2.2		2.3	1.5	3.8
Full Arm	8.7	4.6	2.4	2.2	3		1.5	4.5

## COM APPROVAL PROCESS:

The approval process is as follows:

1. A sample of the COM fabric must be provided to Krug Customer Service prior to or at time of order.
2. The sample will be reviewed and the customer advised if the fabric is unsuitable.
3. The COM fabric will be inspected when received at the factory to identify any further concerns with its suitability.

## CAL 133 MOISTURE BARRIER

Model	Upcharge	Model	Upcharge	Model	Upcharge	Model	Upcharge
LEY31UN	297	LEY32UN	436	LEY31.5UN	384	LEY33UN	740
LEY31UF	368	LEY32UF	512	LEY31.5UF	478	LEY33UF	810
LEY31WN	136	LEY32WN	208	LEY31.5WN	176	LEY33WN	457
LEY31WF	136	LEY32WF	208	LEY31.5WF	176	LEY33WF	457

## Leyton Option Upcharges

	\$ List		\$ List
One-Seat Clean out	47	One-Seat Removable Seat & Back Covers	152
One & Half-Seat Clean out	68	One & Half-Seat Removable Seat & Back Covers	212
Two-Seat Clean out	92	Two-Seat Removable Seat & Back Covers	302
Three-Seat Clean out	137	Three-Seat Removable Seat & Back Covers	453
Solid Surface Arm Cap (per pair) - Gr A White	359	Seat or Back Cover only Upcharges	
Solid Surface Arm Cap (per pair) - Gr A Color	363	One-Seat	77
Solid Surface Arm Cap (per pair) - Gr B	368	One & Half-Seat	107
Solid Surface Arm Cap (per pair) - Gr C	404	Two-Seat	152
Solid Surface Tablet - Gr A White	539	Three-Seat	228
Solid Surface Tablet - Gr A Color	547		
Solid Surface Tablet - Gr B	577	Casters	180
Solid Surface Tablet - Gr C	624	Casters with Push bar	466

# LEYTON

DESCRIPTION/MODEL	SPECIES	COM		COL	FABRIC GRADES			LEATHER		
		1	2	3	4	5	6	7	8	9

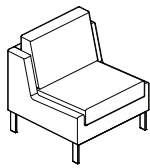

One-seat, Upholstered, Armless LEY31NUN	N/A	2056	2185	2304	2478	2681	2853	3049	3297	3545
--	-----	------	------	------	------	------	------	------	------	------

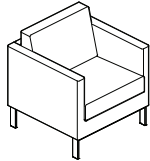

One-seat, Upholstered, Full Arm LEY31NUF	N/A	2185	2394	2590	2878	3200	3487	3811	4208	4622
---	-----	------	------	------	------	------	------	------	------	------

**ORDERING NOTE:** Leyton Lounge, Full Arm is available with an optional Solid Surface Arm Cap for upcharge see chart below, clearly note color selection and add an "S" to the end of the model number following the Arm Style. eg. LEY31NUFS

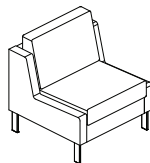

One-seat, Wood Surround, Armless LEY31NPN	Palette	2545	2596	2658	2735	2817	2891	2972	3088	3192
LEY31NWN	Oak, Maple Walnut,	2545	2596	2658	2735	2817	2891	2972	3088	3192
	Cherry, Anigre Sycamore,	3071	3126	3185	3260	3343	3418	3499	3613	3718

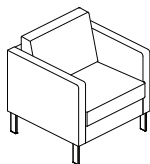

One-seat, Wood Surround, Full Arm LEY31NPF	Palette	2523	2576	2629	2703	2789	2867	2952	3057	3162
LEY31NWF	Oak, Maple Walnut, Palette	2523	2576	2629	2703	2789	2867	2952	3057	3162
	Cherry, Anigre Sycamore,	3049	3102	3156	3231	3315	3396	3479	3582	3688

**ORDERING NOTE:** Leyton Lounge, Full Arm is available with an optional Solid Surface Arm Cap for upcharge see chart below, clearly note color selection and add an "S" to the end of the model number following the Arm Style. eg. LEY31NUFS

## Leyton Option Upcharges

	\$ List	\$ List
Casters	180	Solid Surface Arm Cap (per pair) - Gr A White
Casters with Pushbar	466	Solid Surface Arm Cap (per pair) - Gr A Color
One-Seat Clean out	47	Solid Surface Arm Cap (per pair) - Gr B
One-Seat Removable Seat & Back Covers	152	Solid Surface Arm Cap (per pair) - Gr C
		Solid Surface Tablet - Gr A White
<b>Seat or Back Cover only Upcharges</b>		Solid Surface Tablet - Gr A Color
One-Seat	77	Solid Surface Tablet - Gr B
		Solid Surface Tablet) - Gr C

**ORDERING NOTES:** Leyton Lounge is available with clean out option, to add this option change the first "N" to "C" and add an upcharge above. Please note Cherry, Anigre and Sycamore species require a minimum quantity order of 5 units per species.

## LEYTON LOUNGE PRODUCT CODE KEY

Line	Series	Seat Count	Clean Out	Arm Style	Arm Cap Option (Full Arm Only)
LEY	3	1	N	UF	S
Leyton	Soft Seating	One-Seat	No Clean Out	Upholstered Full Arm	Solid Surface Full Arm Cap
		1.5	C	UN	
		One & Half-Seat	Clean Out	Upholstered Armless	
		2		WF	
		Two-Seat		Wood Surround Full Arm	
		3		WN	
		Three-Seat		Wood Surround Armless	
				PF	
				Pallet Finish Surround Full Arm	
				PN	
				Pallet Finish Surround Armless	



DESCRIPTION/MODEL	SPECIES	COM		COL			FABRIC GRADES			LEATHER	
		1	2	3	4	5	6	7	8	9	

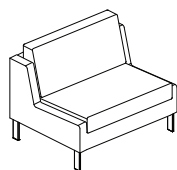

One & Half-seat, Upholstered, Armless LEY31.5NUN	N/A	2639	2822	3004	3260	3553	3809	4099	4462	4830
---	-----	------	------	------	------	------	------	------	------	------

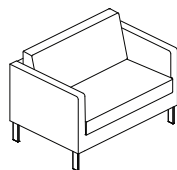

One & Half-seat, Upholstered, Full Arm LEY31.5NUF	N/A	2772	2955	3136	3393	3684	3939	4234	4596	4962
--	-----	------	------	------	------	------	------	------	------	------

**ORDERING NOTE:** Leyton Lounge, Full Arm is available with an optional Solid Surface Arm Cap for upcharge see chart below and clearly note color selection and add an "S" to the end of the model number following the Arm Style. eg. LEY31NUFS

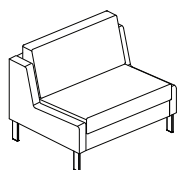

One & Half-seat, Wood Surround Armless LEY31.5NPN	Palette	3025	3122	3220	3355	3512	3647	3803	3997	4192
LEY31.5NWN	Oak, Maple Walnut, Palette	3025	3122	3220	3355	3512	3647	3803	3997	4192
	Cherry, Anigre Sycamore	3552	3646	3743	3880	4037	4172	4328	4524	4718

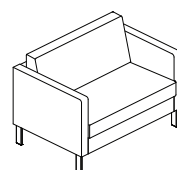

One & Half-seat, Wood Surround Full Arm LEY31.5NPF	Palette	3001	3099	3195	3331	3488	3624	3781	3974	4169
LEY31.5NWF	Oak, Maple Walnut, Palette	3001	3099	3195	3331	3488	3624	3781	3974	4169
	Cherry, Anigre Sycamore	3529	3622	3720	3855	4011	4147	4306	4499	4692

**ORDERING NOTE:** Leyton Lounge, Full Arm is available with an optional Solid Surface Arm Cap for upcharge see chart below and clearly note color selection and add an "S" to the end of the model number following the Arm Style. eg. LEY31NUFS

Leyton Option Upcharges	\$ List	\$ List
Casters	180	Solid Surface Arm Cap (per pair) - Gr A White
Casters with Pushbar	466	Solid Surface Arm Cap (per pair) - Gr A Color
One & Half-Seat Clean out	68	Solid Surface Arm Cap (per pair) - Gr B
One & Half-Seat Removable Seat & Back Covers	212	Solid Surface Arm Cap (per pair) - Gr C
		Solid Surface Tablet - Gr A White
<b>Seat or Back Cover only Upcharges</b>		Solid Surface Tablet - Gr A Color
One & Half-Seat	107	Solid Surface Tablet - Gr B
		Solid Surface Tablet) - Gr C

**ORDERING NOTES:** Leyton Lounge is available with clean out option, to add this option change the first "N" to "C" and add an upcharge above. Please note Cherry, Anigre and Sycamore species require a minimum quantity order of 5 units per species.

**LEYTON LOUNGE PRODUCT CODE KEY**

Line	Series	Seat Count	Clean Out	Arm Style	Arm Cap Option (Full Arm Only)
LEY	3	1	N	UF	S
Leyton	Soft Seating	One-Seat	No Clean Out	Upholstered Full Arm	Solid Surface Full Arm Cap
		1.5	C	UN	
		One & Half-Seat	Clean Out	Upholstered Armless	
		2		WF	
		Two-Seat		Wood Surround Full Arm	
		3		WN	
		Three-Seat		Wood Surround Armless	
				PF	
				Pallet Finish Surround Full Arm	
				PN	
				Pallet Finish Surround Armless	

# LEYTON

DESCRIPTION/MODEL	SPECIES	COM		COL			FABRIC GRADES		LEATHER	
		1	2	3	4	5	6	7	8	9

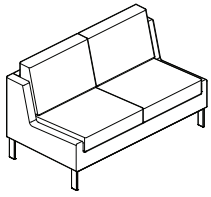

Two-seat, Upholstered, Armless LEY32NUN	N/A	3297	3487	3666	3921	4208	4471	4757	5125	5488
--	-----	------	------	------	------	------	------	------	------	------

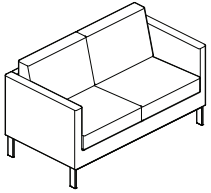

Two-seat, Upholstered, Full Arm LEY32NUF	N/A	3432	3682	3931	4277	4675	5022	5420	5917	6412
---	-----	------	------	------	------	------	------	------	------	------

**ORDERING NOTE:** Leyton Lounge, Full Arm is available with an optional Solid Surface Arm Cap for upcharge see chart below and clearly note color selection and add an "S" to the end of the model number following the Arm Style. eg. LEY31NUFS

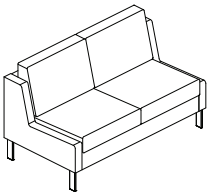

Two-seat, Wood Surround Armless LEY32NPN	Palette	3599	3697	3802	3936	4103	4245	4402	4608	4802
LEY32NWN	Oak, Maple Walnut, Palette	3599	3697	3802	3936	4103	4245	4402	4608	4802
	Cherry, Anigre Sycamore	4203	4296	4402	4539	4706	4846	5006	5210	5406

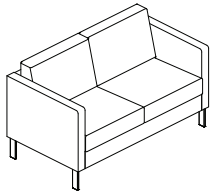

Two-seat, Wood Surround Full Arm LEY32NPF	Palette	3577	3672	3781	3915	4088	4222	4402	4576	4781
LEY32NWF	Oak, Maple Walnut, Palette	3577	3672	3781	3915	4088	4222	4402	4576	4781
	Cherry, Anigre, Sycamore	4179	4277	4381	4515	4690	4823	5006	5179	5384

**ORDERING NOTE:** Leyton Lounge, Full Arm is available with an optional Solid Surface Arm Cap for upcharge see chart below and clearly note color selection and add an "S" to the end of the model number following the Arm Style.

## Leyton Option Upcharges

	\$ List		\$ List
Casters	180	Solid Surface Arm Cap (per pair) - Gr A White	359
Casters with Pushbar	466	Solid Surface Arm Cap (per pair) - Gr A Color	363
Two-Seat Clean out	92	Solid Surface Arm Cap (per pair) - Gr B	368
Two-Seat Removable Seat & Back Covers	302	Solid Surface Arm Cap (per pair) - Gr C	404
Seat or Back Cover only Upcharges		Solid Surface Tablet - Gr A White	539
Two-Seat	152	Solid Surface Tablet - Gr A Color	547
		Solid Surface Tablet - Gr B	577
		Solid Surface Tablet) - Gr C	624

**ORDERING NOTES:** Leyton Lounge is available with clean out option, to add this option change the first "N" to "C" and add an upcharge above. Please note Cherry, Anigre and Sycamore species require a minimum quantity order of 5 units per species.

## LEYTON LOUNGE PRODUCT CODE KEY

Line	Series	Seat Count	Clean Out	Arm Style	Arm Cap Option (Full Arm Only)
LEY	3	1	N	UF	S
Leyton	Soft Seating	One-Seat	No Clean Out	Upholstered Full Arm	Solid Surface Full Arm Cap
		1.5	C	UN	
		One & Half-Seat	Clean Out	Upholstered Armless	
		2		WF	
		Two-Seat		Wood Surround Full Arm	
		3		WN	
		Three-Seat		Wood Surround Armless	
				PF	
				Pallet Finish Surround Full Arm	
				PN	
				Pallet Finish Surround Armless	

# LEYTON

DESCRIPTION/MODEL	SPECIES	COM		COL			FABRIC GRADES			LEATHER	
		1	2	3	4	5	6	7	8	9	

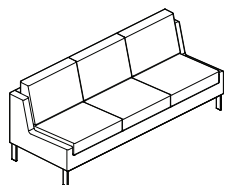

Three-seat, Upholstered, Armless LEY33NUN	N/A	4381	4608	4812	5125	5479	5787	6136	6571	7007
--	-----	------	------	------	------	------	------	------	------	------

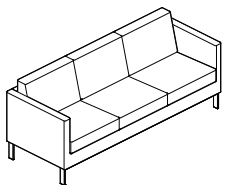

Three-seat, Upholstered, Full Arm LEY33NUF	N/A	4486	4757	5022	5395	5827	6203	6630	7164	7700
---	-----	------	------	------	------	------	------	------	------	------

**ORDERING NOTE:** Leyton Lounge, Full Arm is available with an optional Solid Surface Arm Cap for upcharge see chart below and clearly note color selection and add an "S" to the end of the model number following the Arm Style. eg. LEY31NUFS

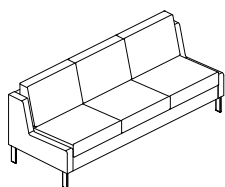

Three-seat, Wood Surround, Armless LEY3NPN	Palette	4697	4856	4998	5223	5466	5684	5932	6241	6549
LEY33NWN	Oak, Maple Walnut, Palette	4697	4856	4998	5223	5466	5684	5932	6241	6549
	Cherry, Anigre Sycamore	5373	5532	5677	5902	6141	6360	6609	6916	7227

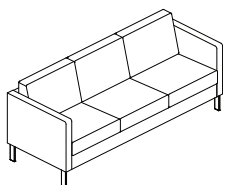

Three-seat, Wood Surround, Full Arm LEY3NPF	Palette	4675	4834	4992	5203	5450	5660	5910	6218	6527
LEY33NWF	Oak, Maple Walnut, Palette	4675	4834	4992	5203	5450	5660	5910	6218	6527
	Cherry, Anigre, Sycamore	5352	5509	5667	5878	6127	6337	6585	6895	7204

**ORDERING NOTE:** Leyton Lounge, Full Arm is available with an optional Solid Surface Arm Cap for upcharge see chart below and clearly note color selection and add an "S" to the end of the model number following the Arm Style.

## Leyton Option Upcharges

	\$ List		\$ List
Casters	180	Solid Surface Arm Cap (per pair) - Gr A White	359
Casters with Pushbar	466	Solid Surface Arm Cap (per pair) - Gr A Color	363
Three-Seat Clean out	137	Solid Surface Arm Cap (per pair) - Gr B	368
Three-Seat Removable Seat & Back Covers	453	Solid Surface Arm Cap (per pair) - Gr C	404
		Solid Surface Tablet - Gr A White	539
<b>Seat or Back Cover only Upcharges</b>		Solid Surface Tablet - Gr A Color	547
Three-Seat	228	Solid Surface Tablet - Gr B	577
		Solid Surface Tablet) - Gr C	624

**ORDERING NOTES:** Leyton Lounge is available with clean out option, to add this option change the first "N" to "C" and add an upcharge above. Please note Cherry, Anigre and Sycamore species require a minimum quantity order of 5 units per species.

## LEYTON LOUNGE PRODUCT CODE KEY

Line	Series	Seat Count	Clean Out	Arm Style	Arm Cap Option (Full Arm Only)
LEY	3	1	N	UF	S
Leyton	Soft Seating	One-Seat	No Clean Out	Upholstered Full Arm	Solid Surface Full Arm Cap
		1.5	C	UN	
		One & Half-Seat	Clean Out	Upholstered Armless	
		2		WF	
		Two-Seat		Wood Surround Full Arm	
		3		WN	
		Three-Seat		Wood Surround Armless	
				PF	
				Pallet Finish Surround Full Arm	
				PN	
				Pallet Finish Surround Armless	

# LEYTON | SLED BASE

DESCRIPTION/MODEL	SPECIES	COM		COL		FABRIC GRADES			LEATHER	
		1	2	3	4	5	6	7	8	9

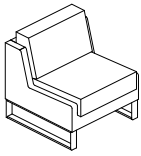

One-seat, No Clean Out, Upholstered, Armless with Sled Base LEY31NUN1	N/A	2109	2231	2345	2510	2704	2868	3054	3290	3527
--	-----	------	------	------	------	------	------	------	------	------

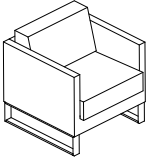

One-seat, No Clean Out, Upholstered, Full Arm with Sled Base LEY31NUF1	N/A	2231	2430	2617	2891	3198	3471	3780	4158	4552
---	-----	------	------	------	------	------	------	------	------	------

**ORDERING NOTE:** Leyton Lounge, Full Arm is available with an optional Solid Surface Arm Cap for upcharge see chart below, clearly note color selection and add an "S" to the end of the model number following the Arm Style. eg. LEY31NUF1S

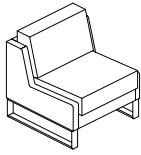

One-seat, No Clean Out, Wood Surround, Armless with Sled Base LEY31NPN1	Palette	2574	2623	2682	2755	2833	2904	2981	3091	3190
LEY31NWN1	Oak, Maple Walnut, Cherry, Anigre Sycamore,	2574	2623	2682	2755	2833	2904	2981	3091	3190
		3075	3128	3184	3255	3334	3406	3483	3591	3691

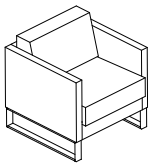

One-seat, No Clean Out, Wood Surround, Full Arm with Sled Base LEY31NPF1	Palette	2553	2604	2654	2725	2807	2881	2962	3062	3162
LEY31NWF1	Oak, Maple Walnut, Palette Cherry, Anigre Sycamore,	2553	2604	2654	2725	2807	2881	2962	3062	3162
		3054	3105	3156	3228	3308	3385	3464	3562	3663

**ORDERING NOTE:** Leyton Lounge, Full Arm is available with an optional Solid Surface Arm Cap for upcharge see chart below, clearly note color selection and add an "S" to the end of the model number following the Arm Style. eg. LEY31NUF1S

## Leyton Option Upcharges

	\$ List	\$ List
One-Seat Clean out	45	Solid Surface Arm Cap (per pair) - Gr A White
One-Seat Removable Seat & Back Covers	145	Solid Surface Arm Cap (per pair) - Gr A Color
		Solid Surface Arm Cap (per pair) - Gr B
		Solid Surface Arm Cap (per pair) - Gr C
<b>Seat or Back Cover only Upcharges</b>		
One-Seat	74	Solid Surface Tablet - Gr A White
		Solid Surface Tablet - Gr A Color
		Solid Surface Tablet - Gr B
		Solid Surface Tablet) - Gr C

**ORDERING NOTES:** Leyton Lounge is available with clean out option, to add this option change the first "N" to "C" and add an upcharge above. Please note Cherry, Anigre and Sycamore species require a minimum quantity order of 5 units per species.

## LEYTON LOUNGE PRODUCT CODE KEY

Line	Series	Seat Count	Clean Out	Arm Style	Base Type	Arm Cap Option (Full Arm Only)
LEY	3	1	N	UF	0	S
Leyton	Soft Seating	One-Seat	No Clean Out	Upholstered Full Arm	Leg Base	Solid Surface Full Arm Cap
		1.5	C	UN	1	
		One & Half-Seat	Clean Out	Upholstered Armless	Sled Base	
		2		WF		
		Two-Seat		Wood Surround Full Arm		
		3		WN		
		Three-Seat		Wood Surround Armless		
				PF		
				Pallet Finish Surround Full Arm		
				PN		
				Pallet Finish Surround Armless		

# LEYTON | SLED BASE

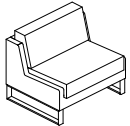
DESCRIPTION/MODEL	SPECIES	COM		COL	FABRIC GRADES			LEATHER		
		1	2	3	4	5	6	7	8	9
	One & Half-seat, No Clean Out, Upholstered, Armless with Sled Base									
	LEY31.5NUN1 N/A	2664	2838	3011	3255	3534	3778	4054	4400	4750

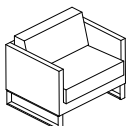
	One & Half-seat, No Clean Out, Upholstered, Full Arm with Sled Base									
	LEY31.5NUF1 N/A	2790	2965	3137	3382	3659	3902	4183	4528	4876

**ORDERING NOTE:** Leyton Lounge, Full Arm is available with an optional Solid Surface Arm Cap for upcharge see chart below and clearly note color selection and add an "S" to the end of the model number following the Arm Style. eg. LEY31.5NUF1S

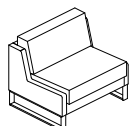
	One & Half-seat, No Clean Out, Wood Surround Armless with Sled Base										
	LEY31.5NPN1 Palette	3031	3124	3217	3346	3495	3624	3772	3957	4143	
	LEY31.5NWN1 Oak, Maple	3031	3124	3217	3346	3495	3624	3772	3957	4143	
	Walnut, Palette										
	Cherry, Anigre	3533	3623	3715	3846	3995	4124	4272	4459	4644	
Sycamore											

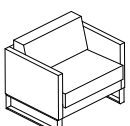
	One & Half-seat, No Clean Out, Wood Surround Full Arm with Sled Base										
	LEY31.5NPF1 Palette	3009	3102	3193	3323	3472	3602	3751	3935	4121	
	LEY31.5NWF1 Oak, Maple	3009	3102	3193	3323	3472	3602	3751	3935	4121	
	Walnut, Palette										
	Cherry, Anigre	3511	3600	3693	3822	3970	4100	4251	4435	4619	
Sycamore											

**ORDERING NOTE:** Leyton Lounge, Full Arm is available with an optional Solid Surface Arm Cap for upcharge see chart below and clearly note color selection and add an "S" to the end of the model number following the Arm Style. eg. LEY31.5NUF1S

Leyton Option Upcharges	\$ List	\$ List
One & Half-Seat Clean out	65	Solid Surface Arm Cap (per pair) - Gr A White 342
One & Half-Seat Removable Seat & Back Covers	202	Solid Surface Arm Cap (per pair) - Gr A Color 346
		Solid Surface Arm Cap (per pair) - Gr B 351
<b>Seat or Back Cover only Upcharges</b>		Solid Surface Arm Cap (per pair) - Gr C 385
One & Half-Seat	102	Solid Surface Tablet - Gr A White 514
		Solid Surface Tablet - Gr A Color 521
		Solid Surface Tablet - Gr B 550
		Solid Surface Tablet) - Gr C 595

**ORDERING NOTES:** Leyton Lounge is available with clean out option, to add this option change the first "N" to "C" and add an upcharge above. Please note Cherry, Anigre and Sycamore species require a minimum quantity order of 5 units per species.

## LEYTON LOUNGE PRODUCT CODE KEY

Line	Series	Seat Count	Clean Out	Arm Style	Base Type	Arm Cap Option (Full Arm Only)
LEY	3	1	N	UF	0	S
Leyton	Soft Seating	One-Seat	No Clean Out	Upholstered Full Arm	Leg Base	Solid Surface Full Arm Cap
		1.5	C	UN	1	
		One & Half-Seat	Clean Out	Upholstered Armless	Sled Base	
		2		WF		
		Two-Seat		Wood Surround Full Arm		
		3		WN		
		Three-Seat		Wood Surround Armless		
				PF		
				Pallet Finish Surround Full Arm		
				PN		
				Pallet Finish Surround Armless		

# LEYTON | SLED BASE

DESCRIPTION/MODEL	SPECIES	COM		COL	FABRIC GRADES			LEATHER		
		1	2	3	4	5	6	7	8	9

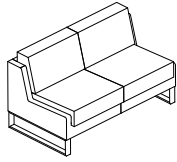

Two-seat, No Clean Out, Upholstered, Armless with Sled Base										
LEY32NUN1	N/A	3290	3471	3642	3885	4158	4409	4681	5031	5377

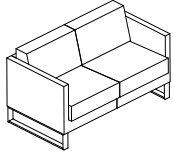

Two-seat, No Clean Out, Upholstered, Full Arm with Sled Base										
LEY32NUF1	N/A	3419	3657	3894	4224	4603	4933	5312	5786	6257

**ORDERING NOTE:** Leyton Lounge, Full Arm is available with an optional Solid Surface Arm Cap for upcharge see chart below and clearly note color selection and add an "S" to the end of the model number following the Arm Style. eg. LEY32NUF1S

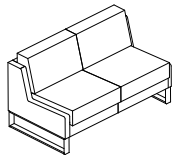

Two-seat, No Clean Out, Wood Surround Armless with Sled Base										
LEY32NPN1	Palette	3578	3671	3771	3899	4058	4193	4343	4539	4724
LEY32NWN1	Oak, Maple	3578	3671	3771	3899	4058	4193	4343	4539	4724
	Walnut, Palette									
	Cherry, Anigre	4153	4242	4343	4473	4632	4766	4918	5112	5299
	Sycamore									

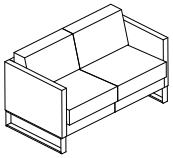

Two-seat, No Clean Out, Wood Surround Full Arm with Sled Base										
LEY32NPF1	Palette	3557	3648	3751	3879	4044	4171	4343	4509	4704
LEY32NWF1	Oak, Maple	3557	3648	3751	3879	4044	4171	4343	4509	4704
	Walnut, Palette									
	Cherry, Anigre,	4130	4224	4323	4450	4617	4744	4918	5083	5278
	Sycamore									

**ORDERING NOTE:** Leyton Lounge, Full Arm is available with an optional Solid Surface Arm Cap for upcharge see chart below and clearly note color selection and add an "S" to the end of the model number following the Arm Style. eg. LEY32NUF1S

## Leyton Option Upcharges

	\$ List		\$ List
Two-Seat Clean out	88	Solid Surface Arm Cap (per pair) - Gr A White	342
Two-Seat Removable Seat & Back Covers	288	Solid Surface Arm Cap (per pair) - Gr A Color	346
		Solid Surface Arm Cap (per pair) - Gr B	351
<b>Seat or Back Cover only Upcharges</b>		Solid Surface Arm Cap (per pair) - Gr C	385
Two-Seat	145	Solid Surface Tablet - Gr A White	514
		Solid Surface Tablet - Gr A Color	521
		Solid Surface Tablet - Gr B	550
		Solid Surface Tablet) - Gr C	595

**ORDERING NOTES:** Leyton Lounge is available with clean out option, to add this option change the first "N" to "C" and add an upcharge above. Please note Cherry, Anigre and Sycamore species require a minimum quantity order of 5 units per species.

## LEYTON LOUNGE PRODUCT CODE KEY

Line	Series	Seat Count	Clean Out	Arm Style	Base Type	Arm Cap Option (Full Arm Only)
LEY	3	1	N	UF	0	S
Leyton	Soft Seating	One-Seat	No Clean Out	Upholstered Full Arm	Leg Base	Solid Surface Full Arm Cap
		1.5	C	UN	1	
		One & Half-Seat	Clean Out	Upholstered Armless	Sled Base	
		2		WF		
		Two-Seat		Wood Surround Full Arm		
		3		WN		
		Three-Seat		Wood Surround Armless		
				PF		
				Pallet Finish Surround Full Arm		
				PN		
				Pallet Finish Surround Armless		

# LEYTON | SLED BASE

DESCRIPTION/MODEL	SPECIES	COM		COL		FABRIC GRADES			LEATHER	
		1	2	3	4	5	6	7	8	9

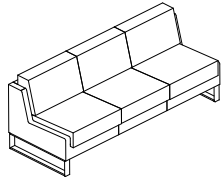

Three-seat, No Clean Out, Upholstered Armless with Sled Base LEY33NUN1	N/A	4323	4539	4733	5031	5369	5662	5994	6409	6824
---	-----	------	------	------	------	------	------	------	------	------

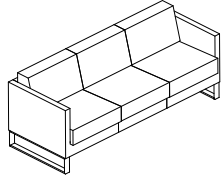

Three-seat, No Clean Out, Upholstered Full Arm with Sled Base LEY33NUF1	N/A	4423	4681	4933	5289	5700	6058	6465	6973	7484
--	-----	------	------	------	------	------	------	------	------	------

**ORDERING NOTE:** Leyton Lounge, Full Arm is available with an optional Solid Surface Arm Cap for upcharge see chart below and clearly note color selection and add an "S" to the end of the model number following the Arm Style. eg. LEY33NUF1S

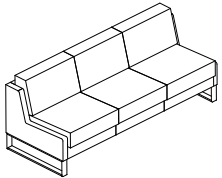

Three-seat, No Clean Out, Wood Surround Armless with Sled Base LEY33NPN1	Palette	4624	4775	4910	5125	5356	5564	5800	6094	6388
LEY33NWN1	Oak, Maple Walnut, Palette	4624	4775	4910	5125	5356	5564	5800	6094	6388
	Cherry, Anigre Sycamore	2109	2231	2345	2510	2704	2868	3054	3290	3527

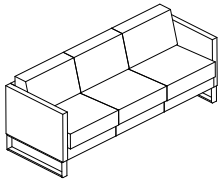

Three-seat, No Clean Out, Wood Surround Full Arm with Sled Base LEY33NPF1	Palette	2109	2231	2345	2510	2704	2868	3054	3290	3527
LEY33NWF1	Oak, Maple Walnut, Palette	2109	2231	2345	2510	2704	2868	3054	3290	3527
	Cherry, Anigre, Sycamore	2109	2231	2345	2510	2704	2868	3054	3290	3527

**ORDERING NOTE:** Leyton Lounge, Full Arm is available with an optional Solid Surface Arm Cap for upcharge see chart below and clearly note color selection and add an "S" to the end of the model number following the Arm Style. eg. LEY33NUF1S

LEYton Option Upcharges	\$ List	\$ List
Three-Seat Clean out	131	Solid Surface Arm Cap (per pair) - Gr A White
Three-Seat Removable Seat & Back Covers	432	Solid Surface Arm Cap (per pair) - Gr A Color
		Solid Surface Arm Cap (per pair) - Gr B
<b>Seat or Back Cover only Upcharges</b>		Solid Surface Arm Cap (per pair) - Gr C
Three-Seat	218	Solid Surface Tablet - Gr A White
		Solid Surface Tablet - Gr A Color
		Solid Surface Tablet - Gr B
		Solid Surface Tablet) - Gr C

**ORDERING NOTES:** Leyton Lounge is available with clean out option, to add this option change the first "N" to "C" and add an upcharge above. Please note Cherry, Anigre and Sycamore species require a minimum quantity order of 5 units per species.

## LEYTON LOUNGE PRODUCT CODE KEY

Line	Series	Seat Count	Clean Out	Arm Style	Base Type	Arm Cap Option (Full Arm Only)
LEY	3	1	N	UF	0	S
Leyton	Soft Seating	One-Seat	No Clean Out	Upholstered Full Arm	Leg Base	Solid Surface Full Arm Cap
		1.5	C	UN	1	
		One & Half-Seat	Clean Out	Upholstered Armless	Sled Base	
		2		WF		
		Two-Seat		Wood Surround Full Arm		
		3		WN		
		Three-Seat		Wood Surround Armless		
				PF		
				Pallet Finish Surround Full Arm		
				PN		
				Pallet Finish Surround Armless		

# LEYTON | REPLACEMENT COMPONENTS

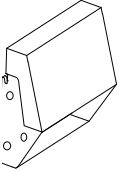
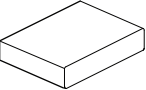
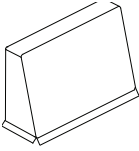
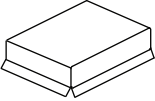
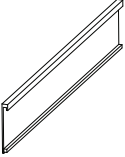



DESCRIPTION	MODEL	COM			COL			FABRIC GRADES			LEATHER			WEIGHTS	CUBES
		1	2	3	4	5	6	7	8	9					
	Replacement Back LEY3RB	485	511	535	569	610	644	687	735	784	12	3.5			
	One & Half-Seat Replacement Back LEY3R1.5B	527	560	592	637	689	735	785	851	916	15	4.5			
	Replacement Seat LEY3RS	695	725	756	796	845	887	935	995	1058	11	2.5			
	One & Half-Seat Replacement Seat LEY3R1.5S	799	843	887	952	1021	1084	1155	1244	1333	14	4			
	Replacement Back Cover LEY3RBC	250	278	302	338	380	412	454	507	556	1	0.75			
	One & Half-Seat Replacement Back Cover LEY3R1.5BC	284	319	350	397	449	493	544	611	676	1.25	1			
	Replacement Seat Cover LEY3RSC	253	280	309	350	394	435	481	538	596	1.25	0.75			
	One & Half-Seat Replacement Seat Cover LEY3R1.5SC	319	363	408	470	541	602	669	764	852	1.5	1			
	One-Seat - Replacement Upholstered Outside Back Panel LEY3R1OBPU	245	271	297	333	372	408	449	497	547	10	1.5			
	One-Seat - Replacement Upholstered Outside Back Panel for Push bar option LEY3R1OBPUPB	259	282	308	343	383	418	457	511	560	10	1.5			
	One & Half-Seat - Replacement Upholstered Outside Back Panel LEY3R1.5OBPU	273	299	321	359	402	434	477	522	573	13	2.5			
	One & Half-Seat - Replacement Upholstered Outside Back Panel for Push bar option LEY3R1.5OBPUPB	283	309	336	369	410	446	486	536	586	13	2.5			
	Two-Seat - Replacement Upholstered Outside Back Panel LEY3R2OBPU	315	340	365	403	438	478	516	567	617	19	3.5			
	Three-Seat - Replacement Upholstered Outside Back Panel LEY3R3OBPU	415	464	515	585	666	737	816	916	1018	28	5			

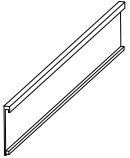
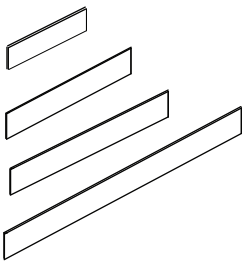
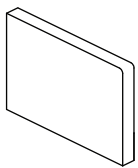
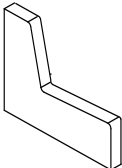

# LEYTON | REPLACEMENT COMPONENTS

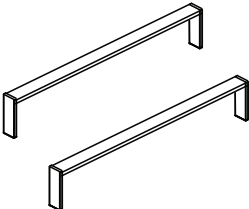
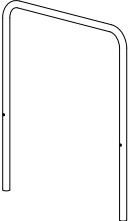
DESCRIPTION	MODEL	OAK	CHERRY	WEIGHTS	CUBES	
		MAPLE WALNUT PALETTE	ANIGRE SYCAMORE			
	One-Seat - Replacement Wood Outside Back Panel LEY3R1OBPW	334	397	10	1.5	
	One-Seat - Replacement Wood Outside Back Panel for Push bar option LEY3R1OBPWPB	352	415	10	1.5	
	One & Half-Seat - Replacement Wood Outside Back Panel LEY3R1.5OBPW	410	508	13	2.5	
	One & Half-Seat - Replacement Wood Outside Back Panel for Push bar option LEY3R1.5OBPWPB	428	521	13	2.5	
	Two-Seat - Replacement Wood Outside Back Panel LEY3R2OBPW	458	584	19	3.5	
	Three-Seat - Replacement Wood Outside Back Panel LEY3R3OBPW	501	688	28	5	
	One-Seat - Replacement Wood Front Panel LEY3R1FP	226	258	4	0.75	
	One & Half-Seat - Replacement Wood Front Panel LEY3R1.5FP	258	278	5	1	
	Two-Seat - Replacement Wood Front Panel LEY3R2FP	287	350	6	1.25	
	Three-Seat - Replacement Wood Front Panel LEY3R3FP	319	412	8	2	
	Replacement Wood Surround Full Arm with arm cap (Left, right specified as seated) LEY3RWFL LEY3RWFLR	610	822	30	1.5	
	Replacement Wood Surround Full Arm with caster (Left, right specified as seated) LEY3RWFCL LEY3RWFCLR	768	983	30	1.5	
	Replacement Wood Surround Full Arm with cup holder (Left, right specified as seated) LEY3RWFCHL LEY3RWFCHR	789	1003	30	1.5	
	Replacement Wood Surround Full Arm with Integrated cup holder (Left, right specified as seated) LEY3RWFICHL LEY3RWFICHR	820	1033	30	1.5	
	Replacement Wood Surround Full Arm Tablet (Left, right specified as seated) LEY3RWFTL LEY3RWFTL	878	1092	30	1.5	
	Replacement Wood Surround Full Arm Integrated Tablet (Left, right specified as seated) LEY3RWFITL LEY3RWFITR	984	1198	30	1.5	
		Replacement Wood Surround Armless (Left, right specified as seated) LEY3RWNLL LEY3RWNLR	620	833	26	1.5
		Replacement Wood Surround Armless with casters (Left, right specified as seated) LEY3RWNCL LEY3RWNCR	780	990	26	1.5

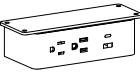
# LEYTON | REPLACEMENT COMPONENTS

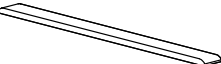
DESCRIPTION	MODEL	PRICE	WEIGHTS	CUBES			
	One-Seat Replacement Leg set (pair) LEY3R1L	180	8	1.25			
	One-Seat Wide Replacement Leg set (pair) LEY3R1.5L	214	10	1.5			
	Two-Seat Replacement Leg set (pair) LEY3R2L	238	13	2.5			
	Three-Seat Replacement Leg set (pair) LEY3R3L	358	22	3			
	Push bar - One-Seat LEY3RPB-1	70	2.0	1.8			
	Push bar - One-Seat Wide LEY3RPB-1.5	78	2.5	2.0			
	Push bar Grommet (pair) LEY3RPBG	10	.2	.1			
<b>Note:</b> Pushbar option is available on One-Seat and One-Seat Wide only.							
	Caster LEY3RC	81	3.4	0.2			
	Replacement Glides - Lounge & Table (set of four) LEY3RG	18	1	.25			
	LEY3-POWERDOC - Undermount	573	3	0.375			
Can be field installed to the underside of Seats and Tables as a replacement part or installed on units not previously specified with a PowerDoc. Standard with 2 Power and USB A & C outlets. PowerDoc's have a 10' cord.							
Solid Surface		Grade A- White	Grade A- Color	Grade- B	Grade- C		
	Replacement Tablet with Mounting Plate - Solid Surface LEY3RT	539	547	577	624	5.0	.7
	Replacement Arm Cap - Solid Surface (to be used with tablet) LEY3TAC	114	116	119	137	1	.3
	Replacement Arm Cap - Solid Surface LEY3RAC	180	182	185	202	1	.25
<b>ORDERING NOTE:</b> Please note Replacement Arm Cap can only be installed on product originally ordered with the Solid Surface Arm Cap option.							

LEED CI CREDITS



MATERIAL CONTENT

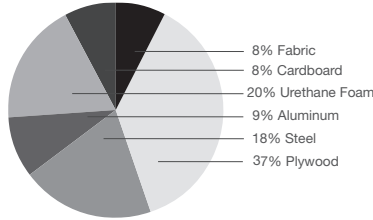

PRE-CONSUMER  
RECYCLED CONTENT = 6%

POST-CONSUMER  
RECYCLED CONTENT = 12.12%

Up to 35.11% of Zola Modular product is recyclable at the end of its useful life.

CONTRIBUTES TO		
CREDIT 2.1 - 2.2	Construction Waste Management	1-2 point(s)
CREDIT 3.3	Resource Reuse	1 point
CREDIT 4.1	Recycled Content	1 point
CREDIT 4.5	Low Emitting Materials, Systems & Seating	1 point
CREDIT 5.1	Regional Materials*	1 point
CREDIT 7	Certified Wood (MUST BE REQUESTED)	1 point(s)

\*This credit is only applicable if in total 20% of the combined value of the procurement of construction materials and in the furniture are manufactured within a radius of 500 miles. This credit will apply if the installation of the finished product occurs within 500 miles of Kitchener, Ontario.

level® CERTIFICATION & AIR-EMISSIONS CERTIFICATION



level® CERTIFICATION

BIFMA's e3 Furniture Sustainability Standard is a voluntary, multi-attribute standard that measures the degree of sustainability of furniture. This standard evaluates product and company environmental attributes and compliance systems in a wide range of elements which include Materials, Energy & Atmosphere, Human & Ecosystem Health and Social Responsibility. Zola products have earned level®, BIFMA's sustainability certification program for furniture, certification through third-party verification against the e3 standard.



The mark of responsible forestry

AIR-EMISSIONS

All Zola products are supplied air-emissions certified. Contact customer service for information.

FSC®

In 2005, Krug received Forest Stewardship Council® (FSC®) Chain-of-Custody certification for our manufacturing facilities. The FSC® Chain-of-Custody tracks certified wood from seedling to final sale. It verifies that the material for our FSC® certified products only come from well-managed, FSC®-certified forests and other controlled sources. FSC® is dedicated to the promotion of responsible forest management worldwide helping to take care of forests for future generations. Zola and other Krug products can be specified with FSC® Certification. Contact customer service for further information, pricing and lead times.



Architects, designers, and building professionals can specify FSC®-certified products in order to achieve a point from the U.S. Green Building Council's Leadership in Energy and Environmental Design (LEED) Rating System.

# ZOLA | FEATURES & OPTIONS



## INTENSIVE USE ENVIRONMENTS

Zola has been designed for healthcare and other intensive use environments, with some important features: removable and replaceable upholstery covers, an anti-microbial finish, the option of a urethane arm cap and a standard clean-out between the seat and back. Modular construction allows for complete cleaning and disinfecting of the entire unit, and air emissions certification, make Zola an excellent solution for healthy spaces and caregiving environments.



## ZOLA LOUNGE & ZOLA MODULAR

Zola Lounge chairs are pre-assembled at Krug and cannot be reconfigured into Modular units. Arms and backs cannot be removed from the seat.



## RECONFIGURABILITY

Zola Modular is designed to enable change: components are inter-changeable, reconfigurable, and replaceable. Metal-to-metal bracketry is designed for fast, easy reconfiguring, that does not damage or degrade the product, and new components can be added and added with ease. Both backs and arms can be reconfigured to either side of the unit. Its unique leveller provides exceptional leveling capability over large spans, and on uneven floors. Heavy duty casters provide seating with mobility.



## LINKING BRACKET

The Zola seat-to-seat linking bracket is made of sturdy, powder-coated steel construction in a black finish. This linking bracket is fastened with metal to metal connections from the seat to another seat with hardened steel bolts to ensure exceptional durability and strength. Brackets mount underneath, and do not mar or damage the tables or seats. This feature is not available on the Lounge version.



## REPLACEABILITY

Zola is built to last: its heavy-duty structure is designed for intensive use environments. When any component is damaged or degraded, it can be easily changed out on its own, instead of having to replace or repair an entire unit. Along with its use of recycled and recyclable materials, the replaceability of components means Zola can provide exceptional long term value, and be an investment in sustainability.



## FINISH DURABILITY

The Krug's finish a proprietary catalyzed varnish formulation, has been repeatedly shown, through independent laboratory testing, to be the industry leader in durability and abrasion resistance. The Krug finish looks better longer than competitors, and is uniquely suited to the demands of high traffic environments.



## WALL SAVER

The angle of the Zola Lounge back is designed to keep the back away from the wall, to prevent wear and damage to both the chairs and to the walls of the room. Zola upholstered chairs are built with a 1/2" clearance between the top of the back and the wall for the wall saver design. Please note wall saver is not a feature on the wood back versions.



## CLEAN OUT

Zola chairs have a built-in clean out feature: a space at the back of the seat that allows dirt and debris to fall to the floor for easy clean up and maintenance. The clean out feature was designed so that it does not detract from the comfort or appearance of the product.



## CASTERS

Optional on the Zola Lounge are the choice of:  
a) Four - 3 1/4" dia hard wheel casters, consisting of two non braking on the front, and two braking on the back. Braking casters have a large, easy access foot activation lever.  
b) Two non braking casters on the back, and two legs on the front. Casters are NOT available on the Plus product(s)



## LEGS

Zola legs are Silver Metallic and come standard with glides that are adjustable up to 1.25", which provide leveling capability over longer spans.



## URETHANE ARM CAP

The optional urethane arm cap provides enhanced durability and protection for the arms. Urethane arm caps are available in two color options; Grey and Taupe. The urethane arm cap is field replaceable if damaged or degraded with the assistance of a skilled upholsterer.



## SOLID SURFACE ARM CAP

The optional Solid Surface Arm Cap provides enhanced durability, protection and cleanability for the arms. This is field replaceable if this becomes damaged or degraded and is available in 8 standard colors.



## FULL DEPTH BENCHES

Modular Curved Benches are offered in two depths. For a flush edge when joining a Modular Curved Bench to Modular seat with back choose the Full Depth.

## PLUS UPGRADE

Zola seating is available with optional Plus Upgrade. Plus Seating has been engineered to support higher weight capacities, accommodating a wider variety of users.

## WEIGHT CAPACITIES

Zola weight capacities are as follows:

One-Seat (Straight or curved)	- 300 lbs
One-Seat Plus	- 750 lbs
Two-seat ( Straight or curved)	- 525lbs
Two-seat Plus	- 975 lbs
Three-seat	- 750 lbs
Three-seat Plus	- 1150 lbs



## TABLETS

Optional Tablets are available on the Zola Lounge & Modular in veneer, clear glass, solid surface, high pressure laminate and palette finishes. The Zola tablet can be fastened to the Zola Lounge & Modular chairs by the Universal Tablet Mount (mounted left or right), to existing legs and features an elliptical shape of 16 1/2" x 11 1/2" x 3/4" in size. The Zola Tablet has a turning radius of 360 degrees, which accommodates any worksurface angle.



## TABLES MATERIALS OPTION

Tables are available in veneer, plastic laminate, and Palette finishes - and an optional Solid Surface top. Tables feature leveling glides on every leg. See 373.



## SOLID SURFACE TOPS

The Solid Surface Top option features Solid Surface material: composed of minerals, acrylic resins and colors, it is a non-porous, scratch and dent-resistant material that does not stain, and does not allow microbes and bacteria to penetrate the surface. Color is throughout the material, so surface scratches are not as visible.



## LINKING TABLES

Zola Linking Tables can be fastened in the field to Zola Modular and Zola Benches with the table to seat bracket without compromising the upholstery. Zola Middle tables have the ability to be easily reconfigured, as they are universal and non-handed. They can be moved to a reverse position in almost any configuration to provide a high level of flexibility when specifying.



## LINKING BRACKETS

The Zola table to seat bracket is made of sturdy, powder-coated steel construction in a Silver Metallic finish to match the legs and casters. This linking bracket is fastened with metal to metal connections from the seat to the table with hardened steel bolts to ensure exceptional durability and strength. Brackets mount underneath, and do not mar or damage the tables or seats. This feature is not available on the Lounge version.



## POWER

The flush-mounted Power unit provides dual power/USB A & C outlets for multiple devices. It can be located on either side of the seat, seat front, (not available on curved fronts) as well as on the front face of tables as standard. See page 190 for locations and page 251 for pricing.



## UNDER-MOUNT POWER

The Under-mount Power unit provides dual power/USB A & C outlets for multiple devices. It can be located below seats and tables. See page 251 for pricing.



## COMBINATION UPHOLSTERY

When combination upholstery is with upholstery of the same grade or COM, an upcharge for dual fabrics is **\$33 list** per unit and **\$64 list** per unit for three fabrics will be applied. When graded-in combination upholstery is selected, use the highest upholstery selected or contact Customer Service for a quote (please provide the fabrics specified and a description of where each fabric is to be applied on the product in order to obtain a quote)

## REPLACEMENT UPHOLSTERY COVERS

Replacement upholstery covers can be easily fitted onto Zola Modular components (with the exception of Zola Curve backs) originally ordered with Removable Upholstery Covers. It is possible to use replacement covers on modular components originally ordered with standard upholstery covers, but this requires some removal of staples and other basic upholstery. Please note that the tailoring of replacement upholstery covers can be less exact and refined in appearance as original upholstery.

## REMOVABLE UPHOLSTERY COVERS

Removable Upholstery Covers are available on most Zola Modular upholstered components, (with the exception of Zola Curve backs) at an upcharge. This feature allows for upholstery covers to be cleaned and disinfected, and allows them to be field-replaced with replacement upholstery covers. Please note that the tailoring of Removable Upholstery Covers can be less exact and refined in appearance than standard upholstery. Replacement and removable covers, (supplied with Velcro) will tailor differently than the permanently stapled upholstery. Overall form and fit is identical, however minor dimensional build up due to the thickness of the velcro can occur. The velcro fastening build up is directed to the least noticeable face (usually the bottom edge of a component) where ever possible.

## MOISTURE BARRIER & CAL 133

California Technical Bulletin 133 is a flammability test for seating. Krug offers a compliance method, in combination with non-flammable upholstery covers, may enable products to meet certification requirements for this test. This process at the same time also provides the products with a Moisture Barrier - a treatment that helps to prevent the passage of liquids and moisture to inside of the upholstered components - thereby conferring sanitary and anti-infection benefits. So when CAL 133 is specified, the product also automatically has a Moisture Barrier, and when a Moisture Barrier is specified, the product also features the compliance method and low flammability features of CAL 133.

The application of this up-charge and the compliance method does not mean that the specific configuration of product and upholstery cover are tested and officially certified as being CAL133 compliant. If the official certification is required, Krug will provide this (through an independent certified testing laboratory) at a charge of \$917 per item, plus the cost of the product to be tested. Lead time for certification testing is typically 4-8 weeks.

Krug assumes no responsibility for the testing of our products in combination with upholstery covers, or for the results of any testing conducted. Some specific configurations of products and upholstery have already been tested. Please contact Customer Service for additional information. CAL 133 and Moisture Barrier is available for **\$64 list** per yard.

# ZOLA | RECONFIGURABILITY

Zola is designed to enable change: components are inter-changeable, reconfigurable, and replaceable. Metal to metal bracketry and frames are designed for fast, easy reconfiguring, and new components can be added at any time. Its unique leveller provides exceptional levelling capability over large spans, and on uneven floors. Heavy duty casters provide seating with mobility. Each of the 6 sample configurations shown here use exactly the same components - highlighting Zola Modular has the ability to reconfigure again and again, in a myriad of different ways. Joining bracketry is underneath seats and backs, so no surfaces are marred or damaged when connected, and re-connected.

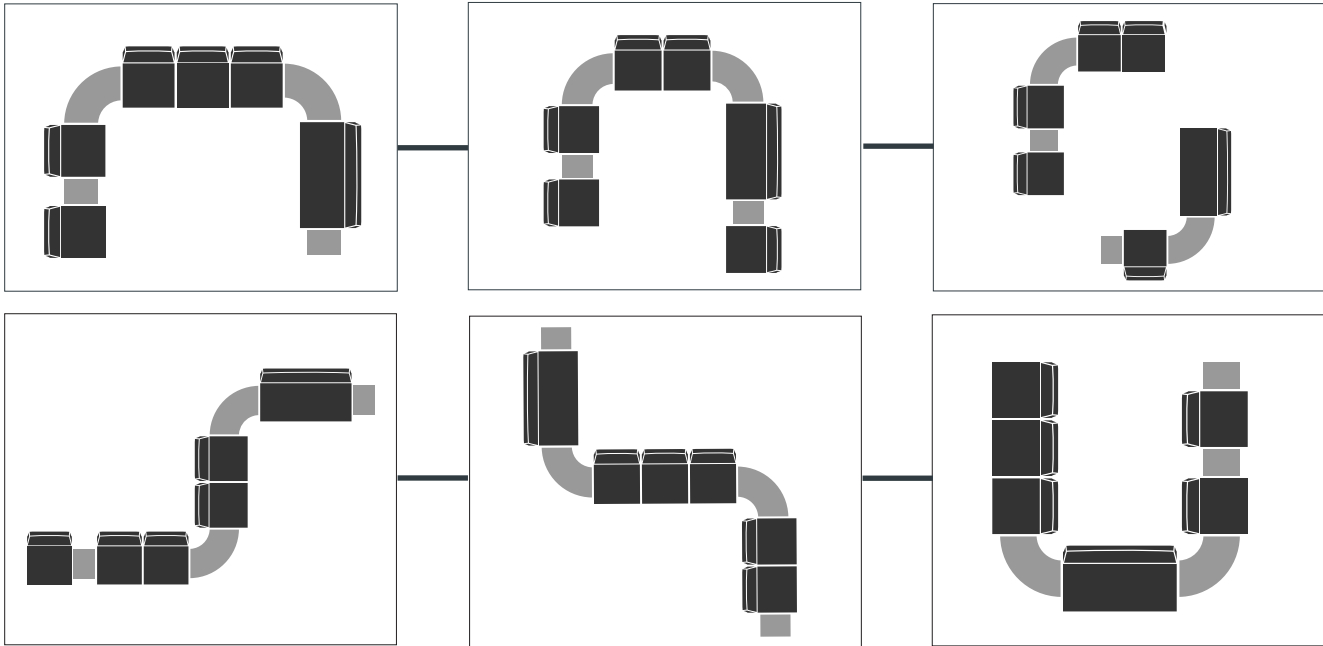

# ZOLA | SEAM LOCATIONS

Due to the curved geometry of the upholstered backs, vertical seams are necessary for quality tailoring of the unit. Patterned Fabrics with "Distinctive details" - such as stripes, squares, straight lines and/or large details, will have noticeable changes in regards to the alignment of the patterns. 90 Degree units -both inside and outside curves are most noticeable. 60, 45 and 30 degree are also subject to this.

Approximate Dimensional Distortions on Patterns:

	Inside Curve	Outside Curve
30 Deg	1 1/2"	1"
45 Deg	2"	1 1/2"
60 Deg	2 1/2"	2"
90 Deg	3"	2 1/2"



Zola seat photo indicates location of seam.

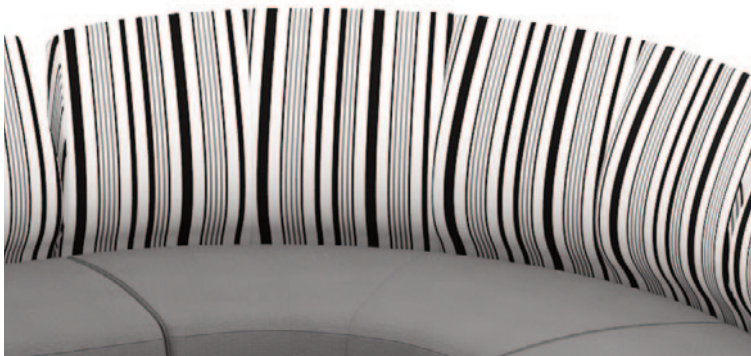

### Inside Curve

Showing colliding stripes at the lumbar portion of the back, and opening stripes at the top and bottom.



### Outside Curve

Showing colliding stripes at the upper and lower portion of the back, with opening stripes at the lumbar.

# ZOLA | SAMPLE CONFIGURATIONS

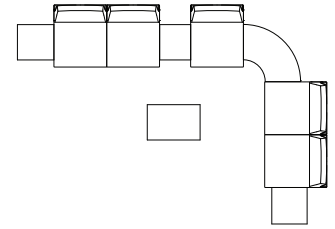
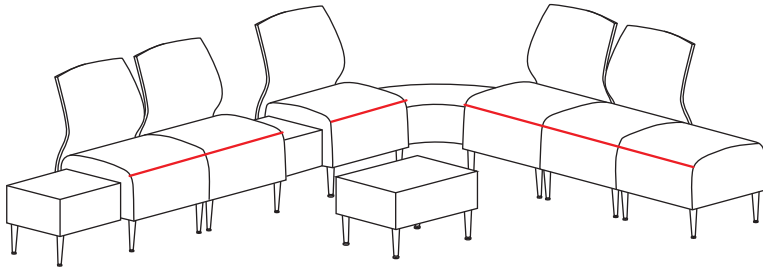

Model	Qty	Price (\$)	Beech
ZOL3 M1201	5	1377	
ZOL3 MS1S1	1	871	
ZOL4 LKM12	1	988	
ZOL4 LKE18	1	1098	
ZOL4 LKC90	1	1283	
ZOL4 241815	1	1187	
<b>Total List</b>		<b>\$12,312</b>	

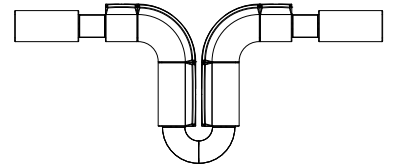
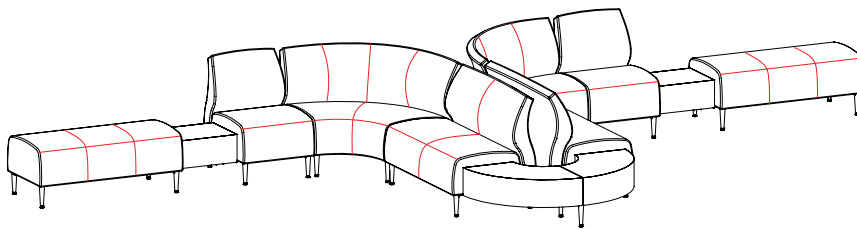

Model	Qty.	Price (\$)
ZOL3 MS2F1	2	1420
ZOL4 LKM18	2	1044
ZOL3 M1101	2	1518
ZOL3 MCIS90D	2	3487
ZOL3 M2101	2	2657
ZOL4 LKC90X2	1	2548
<b>Total List</b>		<b>\$22,800</b>

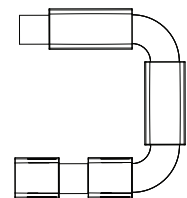
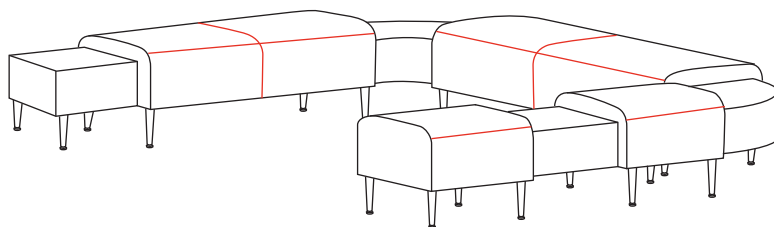

Model	Qty.	Price (\$)
ZOL3 MS1S1	2	871
ZOL3 MS21	2	1218
ZOL4 LKC90	2	1283
ZOL4 LKM18	2	1044
<b>Total List</b>		<b>\$8,832</b>

# ZOLA | LOUNGE

## DIMENSIONS

	Overall Width	Overall Depth	Overall Height	Seat Height	Height of Arms From Floor	Width Between Arms	Seat Depth	Shipping Weight	Cubes
One-Seat	29.25	27	34	18.5	26.75	23	19.25	67	21.5
Two-seat	52.25	27	34	18.5	26.75	46	19.25	90	38
Three-seat	75.25	27	34	18.5	26.75	69	19.25	116	54.5
One-Seat (Plus)	36.25	27	34	18.5	26.75	30	19.25	72	22.6

## COM YARDAGES (Lounge Product Only Available with Arms)

	COM Entire Unit	COM 2 Entire Units	COM 3 Entire Units	COM 4 Entire Units
One-Seat	4	7.25	11.5	14.5
Two-seat	5.5	11	16	21.70
Three-seat	7.1	13.25	19	28
One-Seat (Plus)	4.5	9	13.5	18

## COM YARDAGES (Individual Components)

	COM Yardage Per Seat	COM Yardage Per 2 Seats	COM Yardage Per 3 Seats	COM Yardage Per 4 Seats	COM Yardage Per Back	COM Yardage Per 2 Backs	COM Yardage Per 3 Backs
One-Seat	1.25	2.1	3.35	4.2	1.75	2.75	3.5
Two-seat	1.75	3.4	5.1	6.5	2.5	4.54	6.08
Three-seat	2.5	4.6	7	9	3.5	6.25	9
One-Seat (Plus)	1.25	2.5	3.75	5	1.75	3.5	5.25

## COM YARDAGES (Individual Components)

	COM Yardage Per 4 Backs	COM Yardage Per Arm	COM Yardage Per 2 Arms	COM Yardage Per 3 Arms	COM Yardage Per 4 Arms
One-Seat	5.25	1.5	1.90	2.61	3.3
Two-seat	8.5	1.5	1.90	2.61	3.3
Three-seat	12.5	1.5	1.90	2.61	3.3
One-Seat (Plus)	7	1.5	1.90	2.61	3.3

To calculate the COM Yardage for more than 4 units, take the largest multiple (4 units) and add the closest remainder. See below for example calculations.

5 Units = Take the yardage for 4 units and add the yardage for 1 unit

6 Units = Take the yardage for 4 units and add the yardage for 2 units

7 Units = Take the yardage for 4 units and add the yardage for 3 units

8 Units = Take the yardage for 4 units and multiply by 2

9 Units = Take the yardage for 4 units, multiply by 2, add yardage for 1 unit

10 Units = Take the yardage for 4 units, multiply by 2, add yardage for 2 units

20 Units = Take the yardage for 4 units, multiply by 5

67 Units = Take the yardage for 4 units, multiply by 16, add yardage for 3 units

## COMBINATION UPHOLSTERY

When combination upholstery is with upholstery of the same grade or COM, an upcharge for dual fabrics is **\$33 list** per unit and **\$64 list** per unit for three fabrics will be applied. When graded in combination upholstery is selected, use the highest upholstery selected or contact Customer Service for a quote (please provide the fabrics specified and a description of where each fabric is to be applied on the product in order to obtain a quote)

## ORDERING NOTES:

Please note, Zola Lounge chairs are pre-assembled at Krug and cannot be reconfigured into Modular units. Arms and backs cannot be removed from the seat. Zola Lounge chairs cannot be used in conjunction with Zola Linking Tables. Zola Plus Lounge Two-Seats and Three-Seats units have the same dimensions as the Regular Lounge Two-Seats and Three-seats. Zola Lounge chairs are not available with replacement components or covers. These options are only available on the Modular product.

**FEATURES:** For a complete listing of features see page 171.

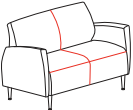
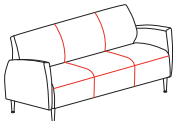

DESCRIPTION/MODEL	COM		COL	FABRIC GRADES			LEATHER			
	1	2	3	4	5	6	7	8	9	
	One-Seat ZOL3 F1111	2182	2301	2419	2625	2830	3036	3242	3283	3745
	One-Seat Plus ZOL3 FB1111	2419	2536	2657	2861	3068	3273	3479	3684	3983
<b>NOTE:</b> One-Seat Plus is 30" wide between arms.										
	Two-seat ZOL3 F2111	3223	3376	3517	3739	3960	4182	4401	4623	4971
	Two-seat Plus ZOL3 FB2111	3313	3462	3605	3825	4045	4268	4488	4710	5059
<b>NOTE:</b> The Two-Seat Plus comes standard with a fifth leg for extra support.										
	Three-seat ZOL3 F3111	4379	4602	4821	5263	5708	6149	6594	7036	7793
	Three-seat Plus ZOL3 FB3111	4483	4705	4924	5366	5810	6253	6692	7136	7896
<b>NOTE:</b> The Three-Seat Plus comes standard with a fifth leg for extra support.										

### Zola Option Upcharges

Option	List	Option	A-White	Grades A-Color	B	C
4 Casters (#2 Leg Type below)	107	Solid Surface Arm Cap (per pair)	454	464	489	514
2 Casters/2 Legs (#3 Leg Type below)	77					
Urethane Arm Caps (pair)	242					

**ORDERING NOTES:** See below for caster and arm option selections, please clearly note Urethane or Solid Surface color on the purchase order. See page 171 for more information on Zola options and features. Plus versions are not available with Caster options.

### PRODUCT CODE KEY

Line	Series	Chair Type	Seat Count	Back Type	Arm Type	Leg Type
ZOL Zola	3 Soft Seating	F Freestanding	1 One-Seat	1 Fully Uph Back	1 Uph Arm	1 Standard Leg + Glide
		FB Freestanding Plus Upgrade	2 Two-seat		2 Urethane Arm Cap	2 Casters
			3 Three-seat		3 Solid Surface Arm Cap	3 Combination 2 Front Standard Legs & 2 Rear Casters

# ZOLA | MODULAR

## DIMENSIONS - ARMLESS UNITS

	Overall Width	Overall Depth Uph. Back	Overall Depth Wood Back	Overall Height	Seat Height	Seat Depth	Shipping Weight	Cubes
One-Seat	23	27	24	34	18.5	19.25	57	9.75
Two-seat	46	27	24	34	18.5	19.25	89	17.6
Three-seat	69	27	24	34	18.5	19.25	122	26.3
One-Seat (Plus)	30	27	24	34	18.5	19.25	62	11.5

## DIMENSIONS - WITH ARMS

	Overall Width	Overall Depth	Overall Height	Seat Height	Seat Depth	Shipping Weight	Cubes
One-Seat	29	27	34	18.5	19.25	88	9.75
Two-seat	52	27	34	18.5	19.25	120	17.6
Three-seat	75	27	34	18.5	19.25	154	26.3
One-Seat (Plus)	36	27	34	18.5	19.25	96	11.5

## COM YARDAGES - ARMLESS UNITS

	COM Yardage Entire Unit wo/ Arms	COM Yardage 2 Entire Units wo/ Arms	COM Yardage 3 Entire Units wo/ Arms	COM Yardage 4 Entire Units wo/ Arms
One-Seat	2.2	4.6	6.38	8.8
Two-seat	3.8	7.9	10.75	14.5
Three-seat	5.75	11	16	22
One-Seat (Plus)	3.0	6.3	9.5	13.86

## COM YARDAGES - WITH ARMS

	COM Yardage Entire Unit w/ Arms	COM Yardage 2 Entire Units w/ Arms	COM Yardage 3 Entire Units w/ Arms	COM Yardage 4 Entire Units w/ Arms
One-Seat	4	7.25	11.5	14.5
Two-seat	5.5	11	16	21.7
Three-seat	7.1	13.25	19	28
One-Seat (Plus)	4.5	9	13.5	18.3

## COM YARDAGES - Individual Components

	COM Arms (Left & Right)	COM Yardage Per Back	COM Yardage Per 2 Backs	COM Yardage Per 3 Backs	COM Yardage Per 4 Backs	COM Yardage Per Seat	COM Yardage Per 2 Seats	COM Yardage Per 3 Seats	COM Yardage Per 4 Seats
One-Seat	1.90	1.75	2.75	3.5	5.25	1.25	2.1	3.4	4.2
Two-seat	1.90	2.5	4.5	6.08	8.5	1.7	3.4	5.1	6.5
Three-seat	1.90	3.5	6.25	9	12.5	2.5	4.6	7	9
One-Seat (Plus)	1.90	1.8	3.5	5.25	7	1.25	2.6	3.75	5.5

To calculate the COM Yardage for more than 4 units, take the largest multiple (4 units) and add the closest remainder. See below for example calculations.

- 5 Units = Take the yardage for 4 units and add the yardage for 1 unit
- 6 Units = Take the yardage for 4 units and add the yardage for 2 units
- 7 Units = Take the yardage for 4 units and add the yardage for 3 units
- 8 Units = Take the yardage for 4 units and multiple by 2
- 9 Units = Take the yardage for 4 units, multiply by 2, add yardage for 1 unit
- 10 Units = Take the yardage for 4 units, multiply by 2, add yardage for 2 units
- 20 Units = Take the yardage for 4 units, multiply by 5
- 67 Units = Take the yardage for 4 units, multiply by 16, add yardage for 3 units

Zola Modular Plus Two-Seats and Three-Seats units have the same dimensions as the Regular Modular Two-Seats and Three-seats.

## COMBINATION UPHOLSTERY

When combination upholstery is with upholstery of the same grade or COM, an upcharge for dual fabrics is **\$33 list** per unit and **\$64 list** per unit for three fabrics will be applied. When graded in combination upholstery is selected, use the highest upholstery selected or contact Customer Service for a quote (please provide the fabrics specified and a description of where each fabric is to be applied on the product in order to obtain a quote)

## PACKAGING

All Modular Units, and tables will be shipped KD (Knocked Down)

## Upcharge for Removable Upholstery Covers:

Option Upcharge	\$ List	Option Upcharge	\$ List
Arms (Right or Left)	77	One-Seat - seat	47
Interim Arm	61	Two-seat - seat	68
One-Seat - back	68	Three-seat - seat	85
Two-seat - back	97	One-Seat Plus - seat	61
Three-seat - back	121		
One-Seat Plus - back	77		

**FEATURES:** For a complete listing of features see 208.

For pricing information on Zola Tables see page 312, Zola Benches see page 280 and Zola Tablets see page 182.

# ZOLA | MODULAR -WOOD BACK



DESCRIPTION/MODEL/SPECIES	COM		COL		FABRIC GRADES				LEATHER		
	1	2	3	4	5	6	7	8	9		
	One-Seat, Wood or Palette Back, Armless										
	ZOL3 MW1201	Beech	1377	1409	1440	1504	1566	1631	1692	1755	1852
		Maple/Cherry	1416	1447	1480	1540	1606	1668	1732	1796	1890
		Palette	1377	1409	1440	1504	1566	1631	1692	1755	1852

	One-Seat, Wood or Palette Back w/ Upholstered Pad, Armless										
	ZOL3 MW1301	Beech	1597	1644	1676	1755	1818	1883	1946	2010	2135
		Maple/Cherry	1638	1685	1715	1796	1858	1922	1985	2048	2173
		Palette	1597	1644	1676	1755	1818	1883	1946	2010	2135

**ORDERING NOTE:** Zola Modular seating with wood backs are designed to be Armless. Zola Modular Arms can be specified on units wood back only as a special, please contact customer service for assistance.

ZOLA OPTION UPCHARGES	\$ List
4 Casters (#2 Leg Type below)	107
2 Casters/2 Legs (#3 Leg Type below)	77

**ORDERING NOTES:** Please note when Zola Modular Chairs are ordered, each chair is automatically supplied with two seat to seat brackets (ZOL3 RLKB2). All Modular Units, and tables will be shipped KD (knocked down).

DESCRIPTION/MODEL	SPECIES	COM		COL		FABRIC GRADES				LEATHER		COM SHIPPING		
		1	2	3	4	5	6	7	8	9	YARDAGE	WEIGHT	CUBES	
	One-Seat Wood/Palette Back w/ UPH Pad													
	ZOL3 MB13	Beech	619	633	648	680	714	744	778	0.6	808	21	853	3.1
		Maple/Cherry	665	680	696	729	760	791	808	0.6	840	21	904	3.1
		Palette	619	633	648	680	714	744	778	0.6	808	25	853	3.1
	One-Seat Wood/Palette Back													
	ZOL3 MB12	Beech	428								-	19	3.1	
		Maple/Cherry	468								-	19	3.1	
		Palette	428								-	23	3.1	

## PRODUCT CODE KEY

Line	Series	Chair Type	Seat Count	Back Type	Arm Type	Leg Type
ZOL	3	MW	1	2	0	1
Zola	Soft Seating	Modular Wood Back	One-Seat	Wood Back	Armless	Standard Leg + Glide
				3		2
				Wood Back with Uph Pad		Casters
						3
						Combination 2 Front Standard Legs & 2 Rear Casters

# ZOLA | MODULAR

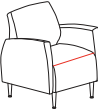
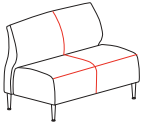
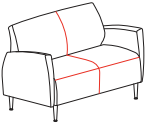
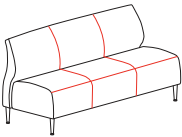
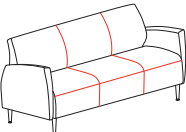
DESCRIPTION/MODEL	COM		COL			FABRIC GRADES			LEATHER		
	1	2	3	4	5	6	7	8	9		
	One-Seat, Upholstered Back Armless										
	ZOL3 M1101	n/a	1518	1597	1676	1818	1960	2105	2244	2387	2640
	One-Seat Plus, Upholstered Back, Armless										
ZOL3 MB1101	n/a	1644	1692	1772	1914	2056	2197	2341	2483	2738	
<b>ORDERING NOTES:</b> One-Seat Plus seat is 30" wide.											
	One-Seat, Upholstered Back with Arms										
	ZOL3 M1111		2324	2443	2554	2760	2964	3167	3376	3580	3890
	One-Seat Plus, Upholstered Back with Arms										
ZOL3 MB1111		2451	2568	2681	2884	3092	3294	3501	3708	4014	
<b>ORDERING NOTES:</b> One-Seat Plus is 30" wide between the arms.											
	Two-seat, Upholstered Back Armless										
	ZOL3 M2101	n/a	2657	2806	2948	3167	3390	3610	3831	4057	4401
	Two-seat Plus, Upholstered Back, Armless										
ZOL3 MB2101	n/a	2743	2893	3036	3257	3477	3699	3920	4142	4488	
	Two-seat, Upholstered Back with Arms										
	ZOL3 M2111		3462	3610	3756	3977	4197	4420	4639	4861	5210
	Two-seat Plus, Upholstered Back with Arms										
ZOL3 MB2111		3547	3699	3843	4064	4286	4505	4728	4948	5296	
	Three-seat, Upholstered Back Armless										
	ZOL3 M3101		3812	4033	4252	4694	5139	5581	6023	6466	7225
	Three-seat Plus Upholstered Back Armless										
ZOL3 MB3101		3914	4133	4355	4796	5241	5684	6124	6568	7327	
	Three-seat, Upholstered Back with Arms										
	ZOL3 M3111	n/a	4615	4838	5059	5502	5943	6387	6829	7270	8031
	Three-seat Plus Upholstered Back with Arms										
ZOL3 MB3111	n/a	4719	4941	5160	5604	6046	6491	6931	7373	8131	



**ORDERING NOTES:** See below for caster and arm option selections, please clearly note Urethane or Solid Surface color selection on the purchase order. Two-seat & Three-seat Plus versions are with a fifth leg or support. Plus versions are not available with Caster options. Please note when Zola Modular Chairs are ordered, each chair is automatically supplied with two seat to seat brackets (ZOL3 RLKB2). All Modular Units, and tables will be shipped KD (knocked down).

Zola Option Upcharges	List	Option	Grades			
			A-White	A-Color	B	C
4 Casters (#2 Leg Type below)	107	Solid Surface Arm Cap (per arm)	227	231	244	257
2 Casters/2 Legs (#3 Leg Type below)	77	Solid Surface Arm Cap (per pair)	454	464	489	514
Urethane Arm Caps (pair)	242	Solid Surface Arm Cap - Interim (per arm)	185	186	189	193

## PRODUCT CODE KEY

Line	Series	Chair Type	Seat Count	Back Type	Arm Type	Leg Type
ZOL	3	M	1	1	0	1
Zola	Lounge	Modular	One-Seat	Fully Uph Back	Armless	Standard Leg + Glide
		MB	2		1	2
		Modular Plus Upgrade	Two-seat		Uph Arm	4 Casters
			3		2	3
			Three-seat		Urethane Arm Cap	Combination
					3	2 Front Standard Legs & 2 Rear Casters
					Solid Surface Arm Cap	

## ZOLA | MODULAR BACKS & ARMS

DESCRIPTION/MODEL	COM		COL	FABRIC GRADES			LEATHER			COM YARDAGE	SHIPPING	
	1	2	3	4	5	6	7	8	9		WEIGHT	CUBES
 Left, Right, or Interim Arm ZOL3 MAL ZOL3 MAR ZOL3 MAI	491	532	569	651	729	808	886	963	1074	1.5	19	3.1
	348	365	381	411	444	477	509	538	586	0.33	13	1.8
	Left, Right, or Interim Arm - Urethane Cap											
 ZOL3 MALU ZOL3 MARU ZOL3 MAIU	619	658	696	778	853	934	1014	1092	1202	1.5	20.5	3
	443	457	476	497	537	568	599	632	678	0.33	13	1.8

### ORDERING NOTES:

The Interim Arm was designed to fit in between two seating units and therefore shortens the width between arms by 1" per seating unit. The interim Arm does not compromise the overall width of the combined benches. Zola Arms (left or right) are specified when seated. To specify Solid Surface Arm Cap add a "3" to the end of the model above, example ZOL3 MAL3, and clearly state color choice. (See page 336 for color selection)

Option	Grades			
	A-White	A-Color	B	C
Solid Surface Arm Cap (per arm)	227	231	244	257
Solid Surface Arm Cap (per pair)	454	464	489	514
Solid Surface Arm Cap - Interim (per arm)	185	186	189	193

DESCRIPTION/MODEL	SPECIES	COM		COL	FABRIC GRADES			LEATHER			COM YARDAGE	SHIPPING	
		1	2	3	4	5	6	7	8	9		WEIGHT	CUBES
 UPH Back ZOL3 MB11* ZOL3 MB21 ZOL3 MB31 ZOL3 MBB11		783	846	910	1036	1164	1289	1572	1699	1852	1.75	23	5.2
		1030	1116	1202	1377	1551	1724	1897	2072	2278	2.5	39	9.4
		1251	1359	1473	1692	1913	2135	2356	2579	2847	3.5	54	14
		871	934	997	1122	1251	1377	1504	1631	1796	2	28	6.1

**ORDERING NOTES:** The Two-seat & Three-seat Upholstered Backs are used for the Two-seat & Three-seat Plus units as well. Only Upholstered Backs can be used on Plus units.

## ZOLA | SEATABLES

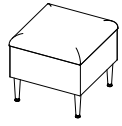
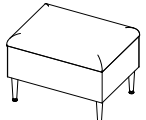
DESCRIPTION	MODEL	COM		COL	FABRIC GRADES			LEATHER			COM YARDAGE	WEIGHT	CUBE
		1	2	3	4	5	6	7	8	9			
 Round Seatable ZOL5-18D ZOL5-24D ZOL5-30D		693	716	739	771	809	843	879	928	974	1.3	18	5.2
		894	943	994	1064	1143	1215	1297	1396	1497	1.5	26	8.5
		1124	1181	1240	1318	1412	1492	1583	1695	1810	1.7	38	10.5
	 Square Seatable ZOL5-1818 ZOL5-2424		759	805	848	912	984	1048	1120	1210	1303	1.3	27
		905	956	1004	1074	1155	1227	1307	1408	1508	1.5	38	8.5
 Rectangular Seatable ZOL5-2418 ZOL5-4824			832	875	921	985	1059	1120	1194	1284	1374	1.3	31
		1178	1240	1303	1389	1487	1572	1672	1798	1922	2.4	62	12.6

### ORDERING NOTES:

The seat height is 17.5" from floor.

# ZOLA | MODULAR - REPLACEMENT COMPONENTS

DESCRIPTION/MODEL	SPECIES	COM		COL			FABRIC GRADES			LEATHER			COM YARDAGE	SHIPPING WEIGHT	CUBES
		1	2	3	4	5	6	7	8	9					

	Replacement Modular One-Seat Wood Back															
	ZOL3 RBM12	Beech	365											-	19	3.1
		Maple/Cherry	405											-	19	3.1
		Palette	365											-	23	3.1

	Replacement Modular One-Seat Wood Back w/ Upholstered Pad															
	ZOL3 RBM13	Beech	556	569	586	619	651	680	714	744	791	0.6	21	3.1		
		Maple/Cherry	601	619	633	665	696	729	744	778	840	0.6	21	3.1		
		Palette	556	569	586	619	651	680	714	744	791	0.6	25	3.1		
	Replacement Back Pad -only		223	239	255	284	318	348	381	411	458	0.6	1.6	2		
	ZOL3 RP															

	Replacement Upholstered Back														
	ZOL3 RBM11*		721	783	846	974	1098	1227	1510	1638	1788	1.75	23	5.2	
	ZOL3 RBM21		963	1053	1139	1314	1485	1662	1835	2010	2214	2.5	39	9.4	
	ZOL3 RBM31		1187	1297	1409	1631	1852	2072	2294	2516	2781	3.5	54	14	
	ZOL3 RBBM11		808	871	934	1061	1187	1314	1440	1566	1732	2	28	6.1	

**ORDERING NOTES:** Modular Upholstered Replacement Backs are supplied with velcro upholstery that allows for assembly of existing "L" brackets on site prior to assembly to the bench. Replacement Backs do not include mounting brackets and legs and Replacement Seat/Benches do not include legs and joining brackets. The hardware can be transferred from the original component to the replacement component. If new hardware is required, Modular Arms/Backs/Benches should be ordered.

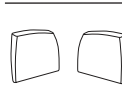
	Right or Left Replacement Upholstered Arm															
	ZOL3 RAMR		435	477	514	595	672	752	832	910	1019	1.5	14	3		
	ZOL3 RAML															
	ZOL3 RAMRU		562	601	641	721	799	878	957	1036	1146	1.5	15.5	3		
	ZOL3 RAMLU															

**ORDERING NOTES:** Zola Replacement arms (left or right) are specified when seated. Replacement Modular Arms are sent without modular hardware. Replacement Arms do not include mounting brackets. ZOL3 RAMRU & ZOL3 RAMLU are replacement arms with urethane cap. Zola replacement arms are available with Solid Surface Arm Caps, see option upcharge chart on page 179. Wood back units are not designed to be specified with standard Zola arms. Arms can be specified on wood back units only as a special - please contact Customer Service for assistance.

	Replacement Upholstered Seat														
	ZOL3 RSM1*		778	822	871	957	1044	1134	1218	1305	1482	1.33	25	5.2	
	ZOL3 RSM2		1122	1178	1232	1354	1473	1589	1708	1827	2024	1.75	39	9.4	
	ZOL3 RSM3		1463	1540	1620	1788	1954	2118	2283	2451	2657	2.5	50	14	
	ZOL3 RSMB1		1004	1053	1098	1195	1289	1384	1480	1572	1715	1.75	26	6.1	
	ZOL3 RSMB2		1202	1266	1330	1447	1566	1685	1803	1922	2118	1.75	39	9.4	
	ZOL3 RSMB3		1755	1835	1914	2056	2197	2341	2483	2625	2847	2.5	50	14	



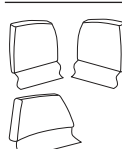

	Back Cover														
	ZOL3 RCB1*		302	365	428	556	680	808	934	1061	1266	2	2.8	1.7	
	ZOL3 RCB2		411	509	601	791	982	1170	1359	1551	1788	3	3.6	1.7	
	ZOL3 RCB3		509	633	760	1014	1266	1518	1772	2024	2341	3.75	4.3	1.7	
	ZOL3 RCBB1		336	397	458	586	714	840	963	1092	1283	2	2.8	1.7	



	Arm Covers Right, Left or Interim															
	ZOL3 RCAR		270	318	365	458	556	651	744	840	963	1.5	2.5	1.7		
	ZOL3 RCAL															
	ZOL3 RCAI		176	190	207	239	270	302	334	365	405	0.33	1.5	1.7		
	ZOL3 RCARU		270	318	365	458	556	651	744	840	963	1.5	2.5	1.7		
	ZOL3 RCALU															

**ORDERING NOTES:** Replacement Arm Covers (left or right) are specified as seated. ZOL3 RCARU & ZOL3 RCALU are arm covers for arms with the urethane arm cap option.

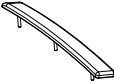
	Seat Cover														
	ZOL3 RCS1*		270	318	365	458	556	651	744	840	982	1.33	2.3	1.7	
	ZOL3 RCS2		348	411	477	601	729	853	982	1108	1314	1.75	2.6	1.7	
	ZOL3 RCS3		444	521	601	680	760	840	916	997	1122	2.5	3.8	1.7	
	ZOL3 RCSB1		411	468	521	633	744	853	963	1074	1232	1.75	2.6	1.7	

# ZOLA | MODULAR - REPLACEMENT COMPONENTS & TABLETS

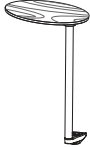
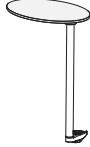
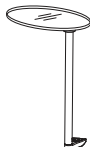
DESCRIPTION/MODEL	PRICE	SHIPPING					
		WEIGHT	CUBES				
 Caster Without Brake ZOL3 RC1	58	0.4	0125				
<b>ORDERING NOTE:</b> Casters cannot be ordered as replacement items for plus units.							
 Caster With Brake ZOL3 RC2	70	0.4	0.125				
<b>ORDERING NOTE:</b> Casters cannot be ordered as replacement items for plus units.							
 Urethane Arm Cap ZOL3 AUR	127	1.5	0.3				
ZOL3 AUL		1.5	0.3				
Urethane Arm Cap - Interim Arm ZOL3 AIU	94	1.0	0.3				
		<b>Grades</b>					
		<b>A-White</b>	<b>A-Color</b>	<b>B</b>	<b>C</b>		
 Solid Surface Arm Cap (per arm) ZOL3 ASR		227	231	244	257	1.5	0.3
ZOL3 ASL							
Solid Surface Arm Cap - Interim (per arm) ZOL3 ASI		185	186	189	193	1.0	0.3

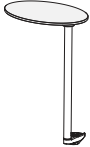
DESCRIPTION	MODEL	SPECIES	PRICE	WEIGHT	CUBE
 Wood Tablet ZOL3 T1		Beech Maple /Cherry	514 538	12	2
 Tablet with Palette Finish ZOL3 T2		n/a	411	12	2
 Clear Glass Tablet ZOL3 T3		n/a	783	13	2
 Laminate Tablet ZOL3 T4		n/a	532	12	2
<b>ORDERING NOTES:</b> The laminate tablet comes standard with a polymer edge. Please note Zola Tablets are universally handed and do not need to be specified right or left when ordering.					
 Solid Surface Tablet - Grade A White ZOL3 T5AW		n/a	641	14	2
Solid Surface Tablet - Grade A Color ZOL3 T5AC		n/a	651	14	2
Solid Surface Tablet - Grade B ZOL3 T5B		n/a	686	14	2
Solid Surface Tablet - Grade C ZOL3 T5C		n/a	741	14	2

# ZOLA | MODULAR CURVE

## DIMENSIONS INSIDE CURVE

	Overall Width	Overall Depth	Overall Height	Seat Height	Seat Depth	Shipping Weight	Cubes
<b>Single seat</b>							
30°	36	28.5	34	18.5	22.5	50	18
45°	42	29	34	18.5	22.5	54	19
60°	48	29	34	18.5	22.5	57	22
90°	59	31	34	18.5	22.5	69	26
<b>Double seat</b>							
30°	58	30	34	18.5	22.5	90	32
45°	64	31	34	18.5	22.5	97.2	33
60°	70	33	34	18.5	22.5	102.6	39
90°	81	36	34	18.5	22.5	124.2	46

## COM Yardages

	COM Yardage Entire Unit	COM Yardage 2 Entire Units	COM Yardage 3 Entire Units	COM Yardage 4 Entire Units
<b>Single seat</b>				
30°	3.70	7.4	11.1	14.8
45°	4.40	8.8	13.2	17.6
60°	4.40	8.8	13.2	17.6
90°	4.61	9.2	13.83	18.44
<b>Double seat</b>				
30°	6.3	12.6	18.9	25.2
45°	6.4	12.8	19.2	25.6
60°	8.2	16.4	24.6	32.8
90°	8.2	16.4	24.6	32.8

## COM Yardages - Individual Components

	COM Yardage Per Back	COM Yardage Per 2 Backs	COM Yardage Per 3 Backs	COM Yardage Per 4 Backs	COM Yardage Per Seat	COM Yardage Per 2 Seats	COM Yardage Per 3 Seats	COM Yardage Per 4 Seats
<b>Single seat</b>								
30°	1.9	3.8	5.7	7.6	1.8	3.6	5.4	7.2
45°	2.6	5.2	7.8	10.4	1.8	3.6	5.4	7.2
60°	2.6	5.2	7.8	10.4	1.8	3.6	5.4	7.2
90°	2.8	5.6	8.4	11.2	1.8	3.6	5.4	7.2
<b>Double seat</b>								
30°	2.9	5.8	8.7	11.6	3.4	6.8	10.2	13.6
45°	3	6.0	9.0	12.0	3.4	6.8	10.2	13.6
60°	4.8	8.8	13.5	17.4	3.4	6.8	10.2	13.6
90°	4.8	8.8	13.5	17.4	3.4	6.8	10.2	13.6

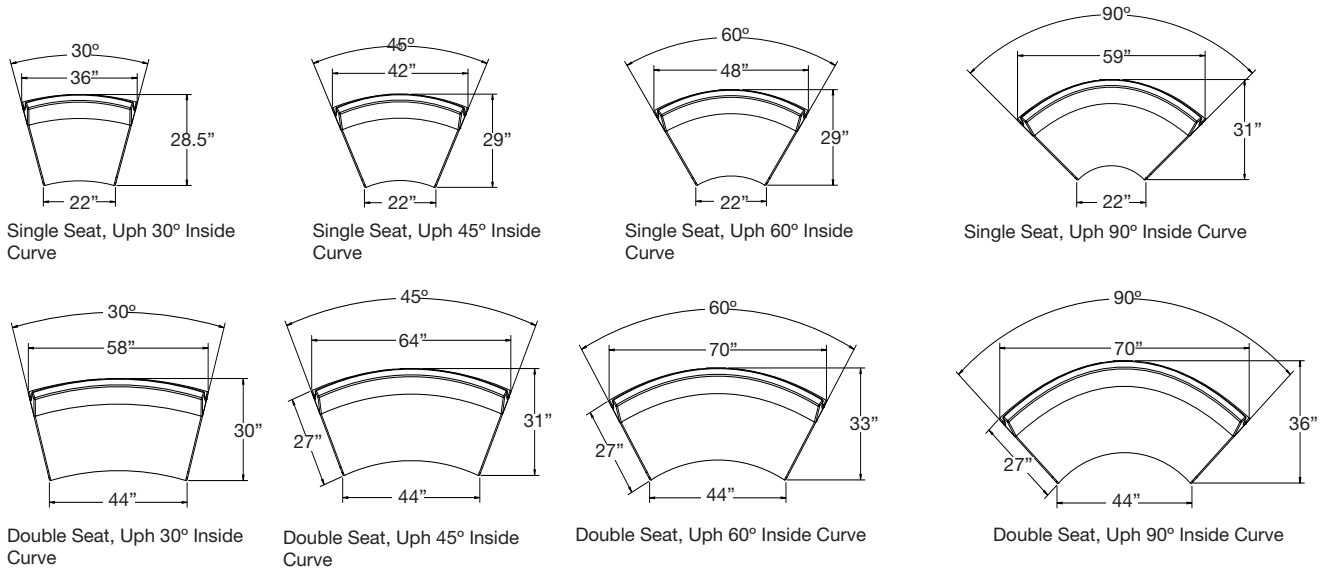

## Upcharge for Removable Upholstery Covers:

Option	\$ List	Option	\$ List
Single-seat curve 30° seat	61	Double-seat curve 30° seat	93
Single-seat curve 45° seat	64	Double-seat curve 45° seat	101
Single-seat curve 60° seat	86	Double-seat curve 60° seat	123
Single-seat curve 90° seat	113	Double-seat curve 90° seat	127



## DIMENSIONS OUTSIDE CURVE

	Overall Width	Overall Depth	Overall Height	Seat Height	Seat Depth	Shipping Weight	Cubes
<b>Single seat</b>							
30°	33.75	28.25	34	18.5	22.5	48	23
45°	38.75	28.75	34	18.5	22.5	49	24
60°	43.5	29.25	34	18.5	22.5	50	29
90°	52	29.75	34	18.5	22.5	51	34
<b>Double seat</b>							
30°	55.75	29.75	34	18.5	22.5	83	36
45°	60.75	31	34	18.5	22.5	84	40
60°	65.75	32.25	34	18.5	22.5	86	45
90°	74	34.5	34	18.5	22.5	96	56

## COM Yardages

	COM Yardage Entire Unit	COM Yardage 2 Entire Units	COM Yardage 3 Entire Units	COM Yardage 4 Entire Units
<b>Single seat</b>				
30°	3.32	6.14	9.46	12.28
45°	3.32	6.14	9.46	12.28
60°	3.32	6.14	9.46	12.28
90°	3.32	6.14	9.46	12.28
<b>Double seat</b>				
30°	6.50	13.0	19.5	26.0
45°	6.50	13.0	19.5	26.0
60°	6.50	13.0	19.5	26.0
90°	6.50	13.0	19.5	26.0

## COM Yardages - Individual Components

	COM Yardage Per Back	COM Yardage Per 2 Backs	COM Yardage Per 3 Backs	COM Yardage Per 4 Backs	COM Yardage Per Seat	COM Yardage Per 2 Seats	COM Yardage Per 3 Seats	COM Yardage Per 4 Seats
<b>Single seat</b>								
30°	1.7	2.95	4.65	5.9	1.8	3.6	5.4	7.2
45°	1.7	2.95	4.65	5.9	1.8	3.6	5.4	7.2
60°	1.7	2.95	4.65	5.9	1.8	3.6	5.4	7.2
90°	1.7	2.95	4.65	5.9	1.8	3.6	5.4	7.2
<b>Double seat</b>								
30°	3.1	6.2	9.3	12.4	3.4	6.8	10.2	13.6
45°	3.1	6.2	9.3	12.4	3.4	6.8	10.2	13.6
60°	3.1	6.2	9.3	12.4	3.4	6.8	10.2	13.6
90°	3.1	6.2	9.3	12.4	3.4	6.8	10.2	13.6
6.8	10.2	13.6						

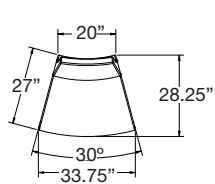

Single Seat, Uph 30° Outside Curve

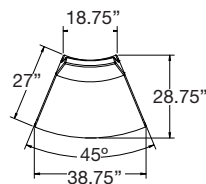

Single Seat, Uph 45° Outside Curve

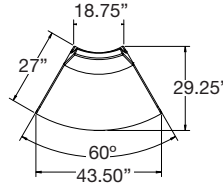

Single Seat, Uph 60° Outside Curve

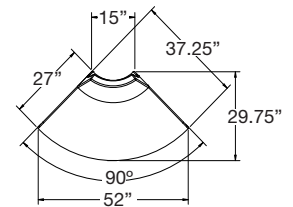

Single Seat, Uph 90° Outside Curve

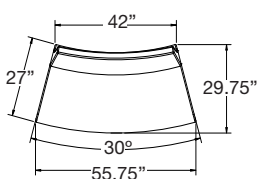

Double Seat, Uph 30° Outside Curve

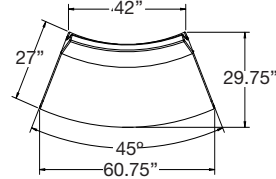

Double Seat, Uph 45° Outside Curve

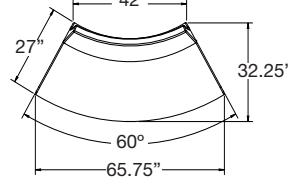

Double Seat, Uph 60° Outside Curve

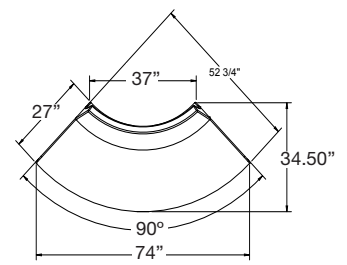



Double Seat, Uph 90° Outside Curve

## Upcharge for Removable Upholstery Covers:

Option	\$ List	Option	\$ List
Single-seat curve 30° seat	61	Double-seat curve 30° seat	93
Single-seat curve 45° seat	64	Double-seat curve 45° seat	101
Single-seat curve 60° seat	86	Double-seat curve 60° seat	123
Single-seat curve 90° seat	113	Double-seat curve 90° seat	127

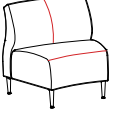
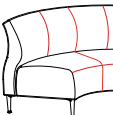
# ZOLA | MODULAR CURVE

DESCRIPTION/MODEL	COM		COL		FABRIC GRADES			LEATHER		
	1	2	3	4	5	6	7	8	9	
	Single-Seat, 30° Inside Curve ZOL3 MCIS30D1	2302	2432	2559	2741	2947	3131	3336	3592	3851
	Single-Seat, 30° Inside Curve Plus ZOL3 MCBIS30D1	2399	2530	2657	2838	3045	3226	3432	3691	3949
	Single-Seat, 45° Inside Curve ZOL3 MCIS45D1	2709	2873	3038	3271	3538	3770	4037	4369	4704
	Single-Seat, 45° Inside Curve Plus ZOL3 MCBIS45D1	2818	2984	3147	3383	3648	3880	4146	4480	4813
	Single-Seat, 60° Inside Curve ZOL3 MCIS60D1	3069	3235	3399	3634	3899	4131	4397	4730	5063
	Single-Seat, 60° Inside Curve Plus ZOL3 MCBIS60D1	3193	3358	3523	3759	4024	4257	4522	4855	5188
	Single-Seat, 90° Inside Curve ZOL3 MCIS90D1	3487	3696	3904	4196	4530	4821	5155	5574	5993
	Single-Seat, 90° Inside Curve Plus ZOL3 MCBIS90D1	3652	3862	4068	4362	4694	4987	5320	5740	6159
	Single-Seat, 30° Outside Curve ZOL3 MCOS30D1	2072	2190	2304	2465	2654	2817	3001	3235	3465
	Single-Seat, 30° Outside Curve Plus ZOL3 MCBOS30D1	2169	2286	2403	2564	2748	2913	3097	3331	3562
	Single-Seat, 45° Outside Curve ZOL3 MCOS45D1	2436	2586	2738	2946	3185	3395	3634	3934	4233
	Single-Seat, 45° Outside Curve Plus ZOL3 MCBOS45D1	2546	2696	2847	3056	3294	3505	3743	4044	4341
	Single-Seat, 60° Outside Curve ZOL3 MCOS60D1	2763	2911	3061	3270	3510	3718	3958	4258	4557
	Single-Seat, 60° Outside Curve Plus ZOL3 MCBOS60D1	2888	3036	3187	3396	3635	3844	4083	4381	4681
	Single-Seat, 90° Outside Curve ZOL3 MCOS90D1	3137	3323	3513	3774	4077	4340	4641	5017	5393
	Single-Seat, 90° Outside Curve Plus ZOL3 MCBOS90D1	3303	3489	3679	3940	4242	4506	4809	5183	5559

**ORDERING NOTES:** Please note when Zola Modular Chairs are ordered, each chair is automatically supplied with two seat to seat brackets (ZOL3 RLKB2). All Modular Units, and tables will be shipped KD (knocked down).

## PRODUCT CODE KEY

Line	Series	Chair Type	Curve Style	Seat Count	Seat Degree	Leg Type
ZOL	3	MC	I	S	30D	1
Zola	Soft Seating	Modular	Inside Curve	Single	30 Degree	Standard Leg + Glide
		MCB	O	D	45D	
		Modular Plus Upgrade	Outside Curve	Double	45 Degree	
					60D	
					60 Degree	
					90D	
					90 Degree	

# ZOLA | MODULAR CURVE

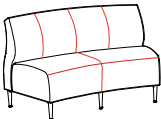
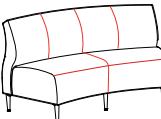
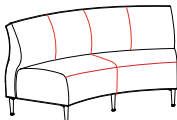
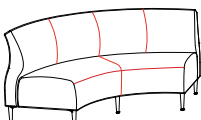
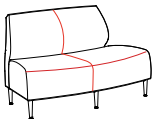
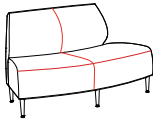
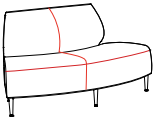
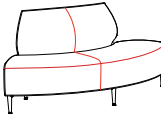
DESCRIPTION/MODEL	COM		COL		FABRIC GRADES			LEATHER	
	1	2	3	4	5	6	7	8	9
 Double-Seat, 30° Inside Curve ZOL3 MCID30D1	4028	4252	4481	4795	5157	5473	5836	6289	6739
	4182	4405	4633	4947	5309	5628	5989	6441	6893
 Double-Seat, 45° Inside Curve ZOL3 MCID45D1	4736	5028	5318	5722	6188	6598	7064	7644	8225
	4917	5209	5497	5903	6369	6778	7242	7822	8406
 Double-Seat, 60° Inside Curve ZOL3 MCID60D1	5367	5659	5948	6357	6821	7229	7696	8276	8858
	5560	5852	6141	6549	7016	7421	7888	8469	9051
 Double-Seat, 90° Inside Curve ZOL3 MCID90D1	6099	6465	6831	7342	7925	8438	9022	9755	10485
	6319	6686	7049	7564	8146	8658	9244	9975	10705
 Double-Seat, 30° Outside Curve ZOL3 MCOD30D1	3626	3828	4033	4316	4643	4928	5254	5659	6069
	3777	3980	4185	4468	4795	5080	5405	5811	6221
 Double-Seat, 45° Outside Curve ZOL3 MCOD45D1	4263	4525	4786	5152	5571	5938	6357	6881	7402
	4442	4706	4966	5331	5751	6117	6536	7060	7582
 Double-Seat, 60° Outside Curve ZOL3 MCOD60D1	4831	5093	5355	5720	6139	6506	6925	7447	7971
	5023	5286	5548	5914	6333	6699	7119	7641	8164
 Double-Seat, 90° Outside Curve ZOL3 MCOD90D1	5488	5819	6146	6607	7134	7594	8121	8781	9438
	5708	6039	6366	6828	7356	7815	8342	8999	9657

**ORDERING NOTES:** Please note when Zola Modular Chairs are ordered, each chair is automatically supplied with two seat to seat brackets (ZOL3 RLKB2). All Modular Units, and tables will be shipped KD (knocked down).

## PRODUCT CODE KEY

Line	Series	Chair Type	Curve Style	Seat Count	Seat Degree	Leg Type
ZOL Zola	3 Soft Seating	MC Modular	I Inside Curve	S Single	30D 30 Degree	1 Standard Leg + Glide
		MCB Modular Plus Upgrade	O Outside Curve	D Double	45D 45 Degree	
					60D 60 Degree	
					90D 90 Degree	

# ZOLA PRIVACY | ENVIRONMENTAL SUMMARY

## LEED CI CREDIT



MATERIAL CONTENT:

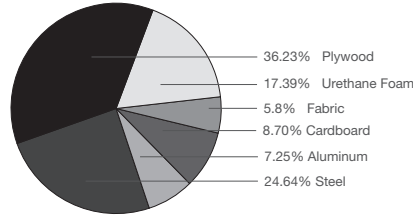

PRE-CONSUMER  
RECYCLED CONTENT = 6.34%

POST-CONSUMER  
RECYCLED CONTENT = 14.09%

Up to 40.58% of this Zola product is recyclable at the end of its useful life.

### CONTRIBUTES TO

CREDIT 2.1 - 2.2	Construction Waste Management	1-2 point(s)
CREDIT 3.3	Resource Reuse	1 point
CREDIT 4.1	Recycled Content	1 point
CREDIT 4.5	Low Emitting Materials, Systems & Seating	1 point
CREDIT 5.1	Regional Materials*	1 point
CREDIT 7	Certified Wood (MUST BE REQUESTED)	1 point(s)

\*This credit is only applicable if in total 20% of the combined value of the procurement of construction materials and in the furniture are manufactured within a radius of 500 miles. This credit will apply if the installation of the finished product occurs within 500 miles of Kitchener, Ontario.

## level® CERTIFICATION & AIR EMISSIONS CERTIFICATION



### level® CERTIFICATION

BIFMA's e3 Furniture Sustainability Standard is a voluntary, multi-attribute standard that measures the degree of sustainability of furniture. This standard evaluates product and company environmental attributes and compliance systems in a wide range of elements which include Materials, Energy & Atmosphere, Human & Ecosystem Health and Social Responsibility. Zola Privacy products have earned level®, BIFMA's sustainability certification program for furniture, certification through third-party verification against the e3 standard.



The mark of responsible forestry

### AIR EMISSIONS

All Zola Privacy products are supplied air-emissions certified. Contact customer service for information.

### FSC®

In 2005, Krug received Forest Stewardship Council® (FSC®) Chain-of-Custody certification for our manufacturing facilities. The FSC® Chain-of-Custody tracks certified wood from seedling to final sale. It signifies that the growth, harvesting and production of goods are entirely achieved through responsible forestry, which guarantees a healthy supply of forest resources for generations to come. Zola Privacy products can be specified with one of two types of FSC® Certification:

- (a) FSC®-certified (which includes FSC®-certified lumber, veneer and substrate material)
  - (b) FSC®-mix certified (which includes substrate material only, and is a lower cost option certification)
- Contact customer service for further information, pricing and leadtimes.



Architects, designers, and building professionals can specify FSC®-certified products in order to achieve a point from the U.S. Green Building Council's Leadership in Energy and Environmental Design (LEED) Rating System.

# ZOLA PRIVACY | FEATURES & OPTIONS

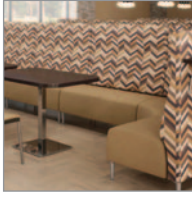

## REPLACEABILITY

Zola is built to last: its heavy-duty structure is designed for intensive use environments. When any component is damaged or degraded, it can be easily changed out on its own, instead of having to replace or repair an entire unit. Along with its use of recycled and recyclable materials, the replaceability of components means Zola can provide exceptional long-term value, and be an investment in sustainability.

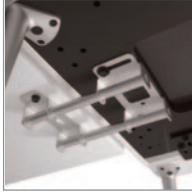

## RECONFIGURABILITY

Zola is designed to enable change: components are inter-changeable, reconfigurable, and replaceable. Metal-to-metal brackets are designed for fast, easy reconfiguring, that does not damage or degrade the product, and new components can be added and added with ease. Arms can be added and reconfigured to either side of the unit. Its unique leveler provides exceptional leveling capability over large spans, and on uneven floors.



## PRECONFIGURED

Zola Privacy can be specified in select preconfigured stand-alone arrangements. The offering includes one, two and three seat units in both Mid Height and Full Height styles. The units are pre-assembled with either full depth or semi-private side panels.



## INTENSIVE USE ENVIRONMENTS

Zola has been designed for healthcare and other intensive use environments, with some important features: removable and replaceable upholstery covers, an anti-microbial finish, the option of a urethane arm cap and a standard clean-out between the seat and back. Modular construction allows for complete cleaning and disinfecting of the entire unit, and air emissions certification, make Zola an excellent solution for healthy spaces and care-giving environments. Plus styles are included in the offering.



## BACK CONNECTION

The Zola Privacy back linking connectors are made of sturdy steel construction. It is a two part bracket fastened with metal-to-metal connections. Brackets are not visible when units are linked. Linked backs can only be reconfigured in the same start/center/end positions.



## LINKING SEAT-TO-SEAT

The Zola seat-to-seat linking bracket is powder-coated steel construction in a black finish. This linking bracket is fastened with metal-to-metal connections from the seat to another seat with hardened steel bolts to ensure exceptional durability and strength. Brackets mount underneath, and do not mar or damage the tables or seats.

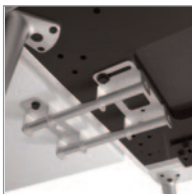

## LINKING TABLE-TO-SEAT

The Zola table-to-seat bracket is powder-coated steel in a Silver Metallic finish to match the legs and casters. This linking bracket is fastened with metal-to-metal connections from the seat to the table.

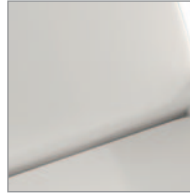

## CLEAN OUT

Zola Lounge chairs have a built-in clean out feature: a space at the back of the seat that allows liquid, dirt and debris to fall to the floor for easy clean up and maintenance. The clean out feature was designed so that it does not detract from the comfort or appearance of the product.



## LEGS

The legs offered on Zola Lounge are Silver Metallic or Matte Black and come standard with glides that are adjustable up to 1.25", which provide leveling capability over longer spans. Caster leg is not available.



## TWIN BACK

Zola Privacy is available in unique Twin Back models for both straight and curves styles. The one piece back-to-back design provides a clean, minimal solution for space division and maximizing seating.



## COMBINATION UPHOLSTERY

When combination upholstery is with upholstery of the same grade or COM, an upcharge for dual fabrics is **\$33 list** per unit and **\$64 list** per unit for three fabrics will be applied. When graded-in combination upholstery is selected, use the highest upholstery selected or contact Customer Service for a quote (please provide the fabrics specified and a description of where each fabric is to be applied on the product in order to obtain a quote).



## ANTI-MICROBIAL FINISH

Zola wood surfaces come with an anti-microbial finish that inhibits the growth of some molds and mildews. Surfaces coated in this finish support the reduction of fungal growth, and spores from germs, microbes and bacteria.

## FINISH DURABILITY

Krug's finish, a proprietary catalyzed varnish formulation, has been repeatedly shown, through independent laboratory testing, to be the industry leader in durability and abrasion resistance. The Krug finish looks better longer than competitors, and is uniquely suited to the demands of high traffic environments.

## PLUS UPGRADE

Zola seating is available with optional Plus Upgrade. Plus Seating has been engineered to support higher weight capacities, accommodating a wider variety of users.

## WEIGHT CAPACITIES

Zola weight capacities are as follows:

One-Seat (Straight or curved)	- 300 lbs
One-Seat plus	- 750 lbs
Two-seat ( Straight or curved)	- 525lbs
Two-seat plus	- 975 lbs
Three-seat	- 750 lbs
Three-seat plus	- 1150 lbs

# ZOLA PRIVACY | OPTIONS



## PRIVACY SCREEN

Zola Privacy Screens are made of durable frosted acrylic and can be mounted to both mid and full height backs. Steel mounting hardware enables screens to be replaced in the field.



## TABLET

Optional Tablets are available in veneer, clear glass, laminate and palette finishes. The Zola can be fastened by the Universal Tablet Mount (mounted left or right), to the single Zola leg, it is not able to mount on the Zola dual leg. The Zola Tablet has a turning radius of 360 degrees. Solid surface is available, contact Customer Service for pricing.



## TABLES

Tables are available in veneer, high pressure laminate or Palette finishes - and an optional solid surface top. An optional flush-mounted Table PowerDoc provides dual power/USB A & C outlets for multiple devices can be located on the front face of Middle or End Tables (not available on curvilinear models). PowerDoc's have a 10' cord.



## MODULAR ARM

Modular arms can attach to the left or right ends of seating units as well as interim locations between units. They are fully upholstered and can optionally be trimmed with urethane or solid surface arm caps.



## URETHANE ARM CAP

The optional urethane arm cap provides enhanced durability and protection for the arms. Urethane arm caps are available in two color options; Grey and Taupe. The urethane arm cap is field replaceable if damaged or degraded.



## SOLID SURFACE ARM CAP

The optional Solid Surface Arm Cap provides enhanced durability, protection and cleanability for the arms. This is field replaceable if this becomes damaged or degraded and is available in 8 standard colors.



## SHELVES & POWER

Back-mounted shelves can be specified in either 30", 36" or 42" and are available in veneer, laminate and Palette finishes (Solid surface overlay also available - contact customer service) The surface-mounted Shelf PowerDoc provides dual power/USB A & C outlets for multiple devices. Units with Shelf Power are not available with Removable Cover option.



## SEAT POWER

The flush-mounted power unit provides dual power/USB A & C outlets for multiple devices. It can be located on either side of the seat, or on the seat front (not available on curved fronts). See page 251 for pricing. Power unit color is white. Units with Seat Power are not available with Removable Cover option.



## PRIVATE MODULAR SIDE PANEL

Side Panels can be specified (in either of two heights) as Start, Center and End locations of configurations to provide an additional degree of privacy and enclosure, and a resting corner position for users - a beneficial element in study, work and waiting area settings. Side Panels will only connect to Center seating units.



## SEMI-PRIVATE MODULAR SIDE PANEL

Semi-Private Side Panels are shallower in depth than standard Side Panels and available in Mid and Full Height back styles. They are specified as Start, Center and Ends and only connect to Center seating units.

In configurations such as banquet settings with tables, they can offer users privacy while still permitting side entry to the seating.



## REPLACEMENT UPHOLSTERY COVERS

Replacement upholstery covers can be easily fitted onto Zola Modular components (with the exception of Zola Curve backs) originally ordered with Removable Upholstery Covers. It is possible to use replacement covers on modular components originally ordered with standard upholstery covers, but this requires some removal of staples and other basic upholstery. Please note that the tailoring of replacement upholstery covers can be less exact and refined in appearance than original upholstery.



## REMOVABLE UPHOLSTERY COVERS

Removable Upholstery Covers are available on most Zola Modular upholstered components, (with the exception of Zola Curve backs) at an upcharge. This feature allows for upholstery covers to be cleaned and disinfected, and allows them to be field-replaced with replacement upholstery covers. Please note that the tailoring of Removable Upholstery Covers can be less exact and refined in appearance than standard upholstery. Replacement and removable covers, (supplied with Velcro) will tailor differently than the permanently stapled upholstery. Overall form and fit is identical, however minor dimensional build up due to the thickness of the Velcro can occur. The Velcro fastening build up is directed to the least noticeable face (usually the bottom edge of a component) where ever possible.

## MOISTURE BARRIER & CAL 133

California Technical Bulletin 133 is a flammability test for seating. Krug offers a compliance method, in combination with non-flammable upholstery covers, may enable products to meet certification requirements for this test. This process at the same time also provides the products with a Moisture Barrier - a treatment that helps to prevent the passage of liquids and moisture to inside of the upholstered components - thereby conferring sanitary and anti-infection benefits. So when CAL 133 is specified, the product also automatically has a Moisture Barrier, and when a Moisture Barrier is specified, the product also features the compliance method and low flammability features of CAL 133.

The application of this up-charge and the compliance method does not mean that the specific configuration of product and upholstery cover are tested and officially certified as being CAL133 compliant. If the official certification is required, Krug will provide this (through an independent certified testing laboratory) at a charge of \$917 per item, plus the cost of the product to be tested. Lead time for certification testing is typically 4-8 weeks.

Krug assumes no responsibility for the testing of our products in combination with upholstery covers, or for the results of any testing conducted. Some specific configurations of products and upholstery have already been tested. Please contact Customer Service for additional information. CAL 133 and Moisture Barrier is available for **\$64 list** per yard.

## ZOLA PRIVACY | POWER LOCATIONS

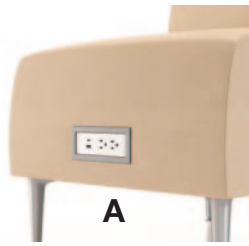

### Seat Power

When ordering Seat Power clearly indicate required location using:

A - for front center of seat (not available on curved fronts)

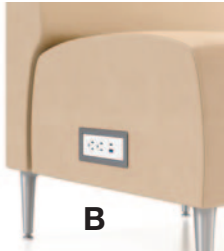

B - for left side of seat (facing)

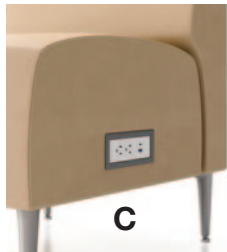

C - for right side of seat (facing)

D - for both left and right of seat

Units with Power are not available with Removable Cover option.



### Shelf Power

Located mid-position on the shelf surface. Units with Shelf Power are not available with Removable Cover option.



### Table Power

Located on the front face of the table as standard. To specify, clearly mark on the order and add **\$647 list**.



### Under-mount Power

The Under-mount Power unit provides dual power/USB A & C outlets for multiple devices. It can be located below seats and tables.

## ZOLA PRIVACY | CONNECTING MULTIPLE UNITS

### SEATING

Start, Center and End multiple units are used to configure continuous runs of seating. Units are specified from left to right (facing). Configurations must include one Start Unit and one End Unit and can be connected to any number of Center Units. Back connecting hardware is concealed once connected to the adjoining unit.

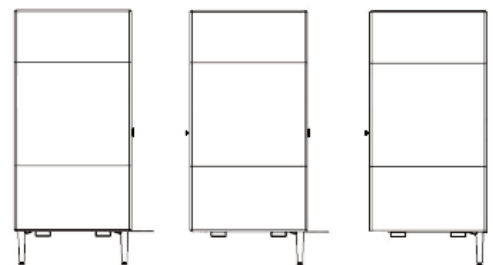

### SIDE PANELS

Start, Center and End Panels are configured in combination with Center Seating only. Start and Center Panel kits contain additional legs which connect to the Center Seat Unit.

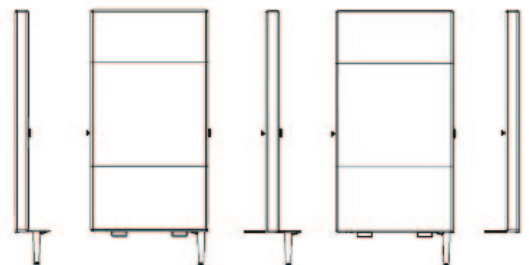

# ZOLA PRIVACY | SAMPLE CONFIGURATIONS & PRICING

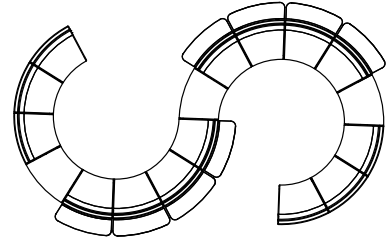
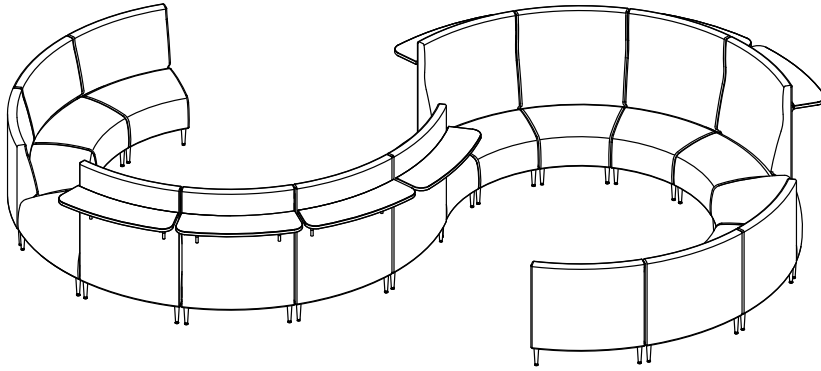

Model	Qty	Price (ea)
ZOP3-MCIS30DM0E	2	3273
ZOP3-MCIS30DM0C	2	3273
ZOP3-MCIS30DM0S	2	3273
ZOL3-MCS30DF1	3	1376
ZOP3-MCIS30DF1E	2	4047
ZOP3-MCIS30DF1C	4	4047
ZOP3-MCIS30DF1S	2	4047

**Total \$56,142**

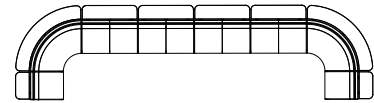
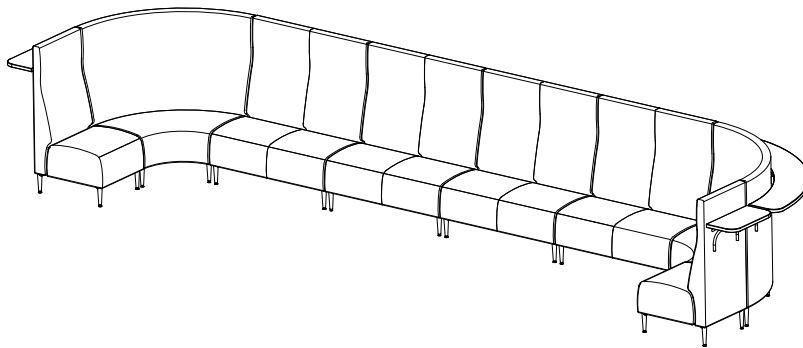

Model	Qty	Price (ea)
ZOP3-M1F1S	1	2364
ZOP3-MCIS90DF1C	2	5866
ZOP3-M2F1C	4	3563
ZOP3-M1F1S	1	2364

**Total \$30,712**

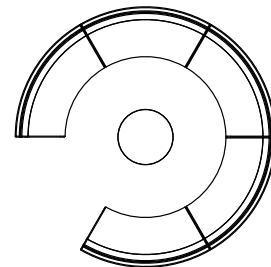
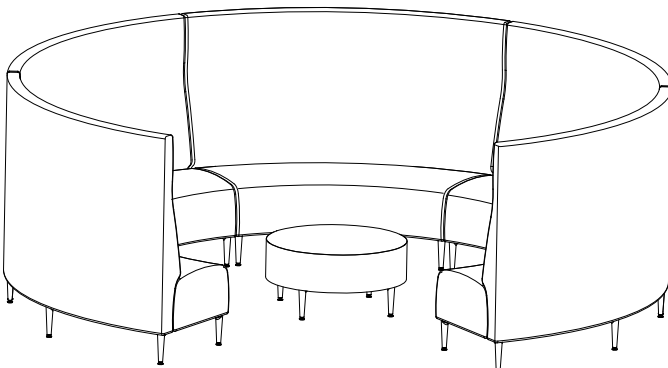

Model	Qty	Price (ea)
ZOP3-MCID60DF0S	1	5910
ZOP3-MCID60DF0C	3	5910
ZOP3-MCID60DF0E	1	5910
ZOL4-30D15	1	1391

**Total \$30,941**



# ZOLA PRIVACY | SAMPLE CONFIGURATIONS & PRICING

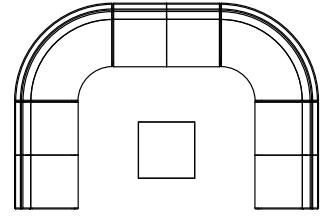
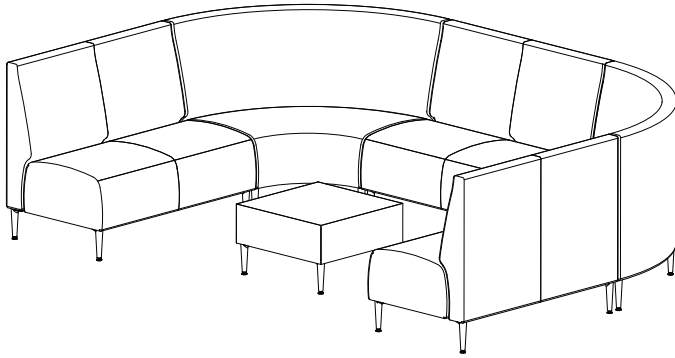

Model	Qty	Price (\$)
ZOP3-M2M0S	1	2595
ZOP3-MCIS90DM0C	2	4571
ZOP3-M2M0C	1	2595
ZOP3-M2M0E	1	2595
ZOL4-242415	1	1187

**Total \$18,114**

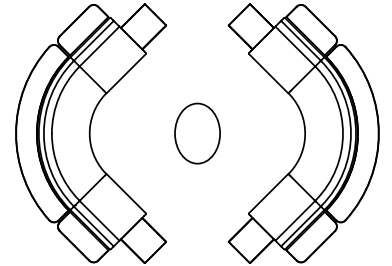
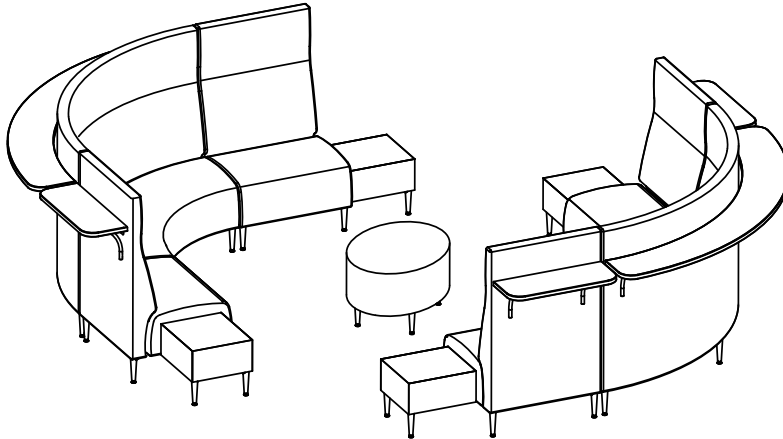

Model	Qty	Price (\$)
ZOL4-LKE18	4	1098
ZOP3-MB1F1S	2	2866
ZOP3-MCID90DF1C	2	7873
ZOP3-MB1F1E	2	2866
ZOL4 E482915	1	2016

**Total \$33,618**

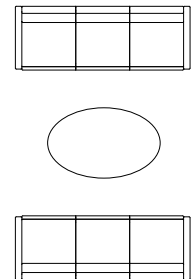
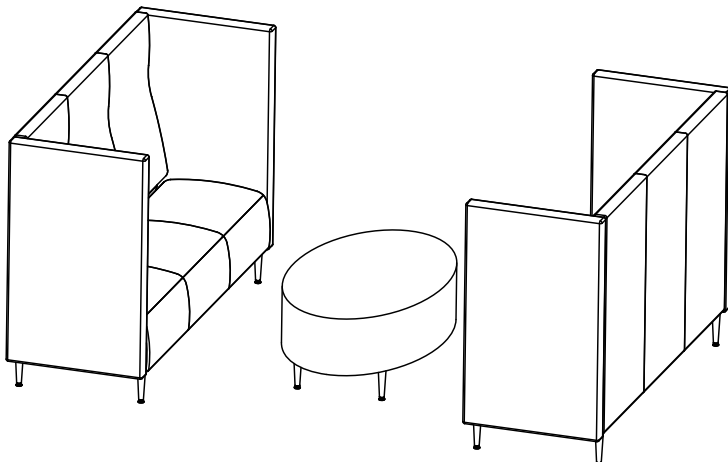

Model	Qty	Price (\$)
ZOP3-MPF0S	2	946
ZOP3-M3F0C	2	3972
ZOP3-MPF0E	2	946
ZOP4-E482915	1	2016

**Total \$13,744**

# ZOLA PRIVACY | PRECONFIGURED - DIMENSIONS & COM REQUIREMENTS

## DIMENSIONS

	Overall Width	Width Between Panels	Overall Depth	Overall Height	Seat Height	Seat Depth	Shipping Weight	Cubes
--	---------------	----------------------	---------------	----------------	-------------	------------	-----------------	-------

### Preconfigured Full Height Back

One-Seat Plus	36	30	27	50	18.5	19.25	134	28.3
Two-seat	52	46	27	50	18.5	19.25	161	40.4
Three-seat	75	69	27	50	18.5	19.25	194	57.5

### Preconfigured Mid Height Back

One-Seat Plus	36	30	27	37.5	18.5	19.25	114	20.4
Two-seat	52	46	27	37.5	18.5	19.25	141	29.1
Three-seat	75	69	27	37.5	18.5	19.25	174	41.3

## COM YARDAGES

	Yardage Entire Unit	Yardage 2 Entire Units	Yardage 3 Entire Units	Yardage 4 Entire Units
--	---------------------	------------------------	------------------------	------------------------

### Preconfigured Full Height Back/Privacy Panel

One-Seat Plus	9.59	13.78	17.97	22.16
Two-seat	11.48	16.13	20.83	26.56
Three-seat	13.56	21.32	29.38	37.04

### Preconfigured Mid Height Back/Privacy Panel

One-Seat Plus	7.31	10.96	14.61	18.26
Two-seat	8.49	12.22	16.72	21.20
Three-seat	10.60	18.36	26.42	34.08

### Preconfigured Full Height Back/Semi-Private Panel

One-Seat Plus	6.63	10.82	15.01	19.20
Two-seat	8.52	13.17	17.87	23.60
Three-seat	10.60	18.36	25.42	34.08

### Preconfigured Mid Height Back/Semi-Private Panel

One-Seat Plus	5.41	9.06	12.71	16.36
Two-seat	6.59	10.32	14.82	19.30
Three-seat	8.48	14.80	21.42	27.20

# ZOLA PRIVACY | PRECONFIGURED

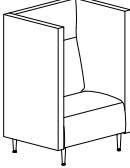
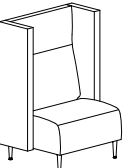
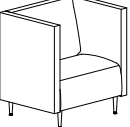
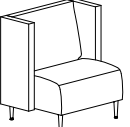
DESCRIPTION/MODEL	COM		COL		FABRIC GRADES			LEATHER	
	1	2	3	4	5	6	7	8	9
 One-Seat Plus with Private Modular Side Panel and Full Height Back ZOP3-PCB1MPF0	3956	4268	4583	5132	5708	6258	6835	7463	8461
 One-Seat Plus with Semi-Private Modular Side Panel and Full Height Back ZOP3-PCB1SMPF0	3229	3455	3683	4059	4461	4838	5241	5695	6347
 One-Seat Plus with Private Modular Side Panel and Mid Height Back ZOP3-PCB1MPM0	3489	3717	3943	4339	4752	5142	5559	6014	6715
 One-Seat Plus with Semi-Private Modular Side Panel and Mid Height Back ZOP3-PCB1SMPM0	2983	3166	3354	3663	3994	4302	4634	5005	5539

## ORDERING NOTES:

Zola Privacy Preconfigured is available in straight units with upholstered side panels. The One-Seat size is offered in 30" only, Plus upgrade is included (23" is not available). PowerDoc is optional on seat front only please mark clearly on the order and add upcharge listed below. PowerDoc's have a 10' cord.

## ZOLA PRIVACY OPTION UPCHARGES



### \$ List

CAL 133 & Moisture Barrier (per yard)	64
Seat Power (per power unit)	641
Plus Upgrade option	included

## PRODUCT CODE KEY

Line	Series	Type	Seat	Side Panel	Height
ZOP	3	PCB	1	MP	F0
Zola Privacy	Lounge	Pre-Configured Plus	One-Seat (30")	Private Modular Side Panel	Full Height
			2	SMP	M0
			Two-Seat	Semi-Private Modular Side Panel	Mid Height
			3		
			Three-Seat		

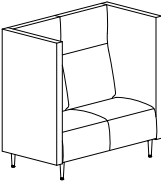
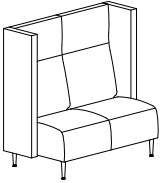
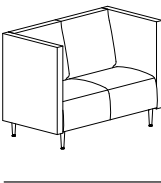
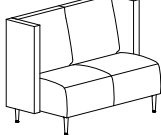
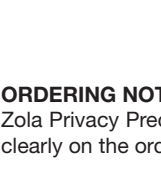
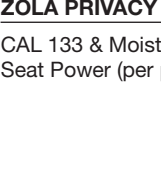
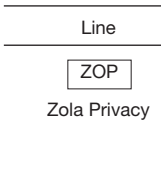
# ZOLA PRIVACY | PRECONFIGURED

DESCRIPTION/MODEL	COM		COL		FABRIC GRADES			LEATHER	
	1	2	3	4	5	6	7	8	9
	Two-Seat with Private Modular Side Panel and Full Height Back								
	ZOP3-PC2MPF0	4571	4947	5327	5970	6653	7295	7977	8739
	Two-Seat Plus with Private Modular Side Panel and Full Height Back								
	ZOP3-PCB2MPF0	4702	5078	5456	6099	6783	7424	8107	8868
	Two-Seat with Semi-Private Modular Side Panel and Full Height Back								
	ZOP3-PC2SMPF0	3843	4134	4426	4897	5407	5876	6386	6970
	Two-Seat Plus with Semi-Private Modular Side Panel and Full Height Back								
	ZOP3-PCB2SMPF0	3972	4265	4557	5027	5537	6007	6515	7101
	Two-Seat with Private Modular Side Panel and Mid Height Back								
	ZOP3-PC2MPM0	3780	4059	4337	4811	5307	5775	6276	6836
	Two-Seat Plus with Private Modular Side Panel and Mid Height Back								
	ZOP3-PCB2MPM0	3909	4189	4467	4941	5437	5905	6406	6965
	Two-Seat with Semi-Private Modular Side Panel and Mid Height Back								
	ZOP3-PC2SMPM0	3271	3510	3746	4133	4548	4933	5349	5825
	Two-Seat Plus with Semi-Private Modular Side Panel and Mid Height Back								
	ZOP3-PCB2SMPM0	3403	3640	3877	4264	4679	5064	5481	5956

## ORDERING NOTES:

Zola Privacy Preconfigured is available in straight units with upholstered side panels. PowerDoc is optional on seat front only please mark clearly on the order and add upcharge listed below. PowerDoc's have a 10' cord.



## ZOLA PRIVACY OPTION UPCHARGES \$ List

CAL 133 & Moisture Barrier (per yard)	64
Seat Power (per power unit)	641

## PRODUCT CODE KEY

Line	Series	Type	Seat	Side Panel	Height
ZOP	3	PC	1	MP	F0
Zola Privacy	Lounge	Pre-Configured	One-Seat (30")	Private Modular Side Panel	Full Height
		PCB	2	SMP	M0
		Pre-Configured Plus Upgrade	Two-Seat	Semi-Private Modular Side Panel	Mid Height
			3		
			Three-Seat		

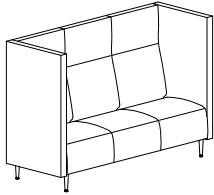
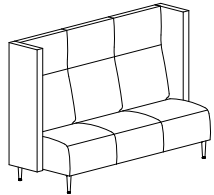
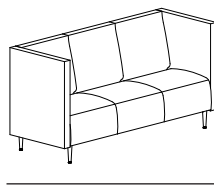
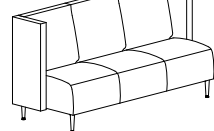
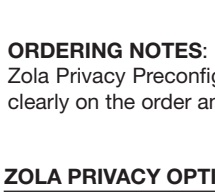
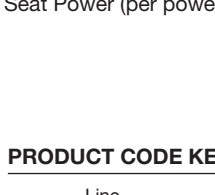
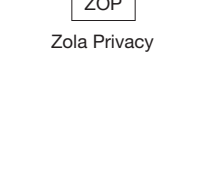
# ZOLA PRIVACY | PRECONFIGURED

DESCRIPTION/MODEL	COM		COL	FABRIC GRADES			LEATHER		
	1	2	3	4	5	6	7	8	9
	Three-Seat with Private Modular Side Panel and Full Height Back								
	ZOP3-PC3MPF0	5495	5940	6390	7131	7923	8663	9457	10354
	Three-Seat Plus with Private Modular Side Panel and Full Height Back								
	ZOP3-PCB3MPF0	5691	6136	6585	7327	8119	8859	9652	10548
	Three-Seat with Semi-Private Modular Side Panel and Full Height Back								
	ZOP3-PC3SMPF0	4768	5128	5488	6057	6678	7243	7864	8587
	Three-Seat Plus with Semi-Private Modular Side Panel and Full Height Back								
	ZOP3-PCB3SMPF0	4964	5322	5684	6253	6872	7441	8059	8783
	Three-Seat with Private Modular Side Panel and Mid Height Back								
	ZOP3-PC3MPM0	4903	5244	5584	6148	6750	7309	7911	8595
	Three-Seat Plus with Private Modular Side Panel and Mid Height Back								
	ZOP3-PCB3MPM0	5098	5441	5781	6344	6945	7504	8107	8790
	Three-Seat with Semi-Private Modular Side Panel and Mid Height Back								
	ZOP3-PC3SMPM0	4396	4696	4995	5471	5990	6466	6985	7586
	Three-Seat Plus with Semi-Private Modular Side Panel and Mid Height Back								
	ZOP3-PCB3SMPM0	4591	4891	5191	5666	6185	6662	7180	7781

## ORDERING NOTES:

Zola Privacy Preconfigured is available in straight units with upholstered side panels. PowerDoc is optional on seat front only please mark clearly on the order and add upcharge listed below. PowerDoc's have a 10' cord.

## ZOLA PRIVACY OPTION UPCHARGES

### \$ List

CAL 133 & Moisture Barrier (per yard)	64
Seat Power (per power unit)	641

## PRODUCT CODE KEY

Line	Series	Type	Seat	Side Panel	Height
ZOP	3	PC	1	MP	F0
Zola Privacy	Lounge	Pre-Configured	One-Seat (30")	Private Modular Side Panel	Full Height
		PCB	2	SMP	M0
		Pre-Configured Plus Upgrade	Two-Seat	Semi-Private Modular Side Panel	Mid Height
			3		
			Three-Seat		

# ZOLA PRIVACY | MODULAR - DIMENSIONS & COM REQUIREMENTS

## DIMENSIONS

	Overall Width	Overall Depth	Depth w/ Shelf	Overall Height	Height w/Screen	Overall Seat Height	Seat Depth	Shipping Weight	Cubes
<b>Full Height Back</b>									
One-Seat	23	27	39	50	62.5	18.5	20.25	69	10.6
Two-seat	46	27	39	50	62.5	18.5	20.25	114	20.8
Three-seat	69	27	39	50	62.5	18.5	20.25	165	31.0
One-Seat (Plus)	30	27	39	50	62.5	18.5	20.25	81	13.8
<b>Mid Height Back</b>									
One-Seat	23	27	39	37.5	50	18.5	20.25	65	9.8
Two-seat	46	27	39	37.5	50	18.5	20.25	107	19.1
Three-seat	69	27	39	37.5	50	18.5	20.25	154	28.5
One-Seat (Plus)	30	27	39	37.5	50	18.5	20.25	76	12.6
<b>Modular Corner Seat with Full Height Back</b>									
One-Seat	27	27	40	50	62.5	18.5	20.25	104	26
One-Seat (Plus)	27	27	40	50	62.5	18.5	20.25	104	26
<b>Modular Corner Seat with Mid Height Back</b>									
One-Seat	27	27	40	37.5	50	18.5	20.25	93	26
One-Seat (Plus)	27	27	40	37.5	50	18.5	20.25	93	26

## COM YARDAGES

	Yardage Entire Unit	Yardage 2 Entire Units	Yardage 3 Entire Units	Yardage 4 Entire Units	Yardage per Back	Yardage per 2 Backs	Yardage per 3 Backs	Yardage per 4 Backs	Yardage per Seat	Yardage per 2 Seats	Yardage per 3 Seats	Yardage per 4 Seats
<b>Full Height Back</b>												
One-Seat	4.1	6.45	10.55	12.9	2.85	4.35	7.2	8.7	1.25	2.1	3.35	4.2
Two-seat	6.08	10.73	16.76	21.16	4.33	7.33	11.66	14.66	1.75	3.4	5.1	6.5
Three-seat	8.16	15.92	23.98	31.64	5.66	11.32	16.98	22.64	2.5	4.6	7	9
One-Seat (Plus)	4.19	8.38	12.57	16.76	2.94	5.88	8.82	11.76	1.25	2.5	3.75	5
<b>Mid Height Back</b>												
One-Seat	3.25	5.2	8.45	10.4	2	3.1	4.2	6.2	1.25	2.1	3.35	4.2
Two-seat	4.83	8.56	13.34	16.82	3.08	5.16	8.24	10.32	1.75	3.4	5.1	6.5
Three-seat	6.72	13.04	19.66	25.88	4.22	8.44	12.66	16.88	2.5	4.6	7	9
One-Seat (Plus)	3.65	7.3	10.95	14.6	2.4	4.8	7.2	9.6	1.25	2.5	3.75	5
<b>Modular Corner Seat with Full Height Back</b>												
One-Seat	7.79	12	18	24	5.70	11.4	16.9	22.4	2.00	4	6	8
One-Seat (Plus)	7.79	12	18	24	5.70	11.4	16.9	22.4	2.00	4	6	8
<b>Modular Corner Seat with Mid Height Back</b>												
One-Seat	6.40	12	18	24	4.00	8	12	18	2.00	4	6	8
One-Seat (Plus)	6.40	12	18	24	4.00	8	12	18	2.00	4	6	8

## ZOLA PRIVACY PLUS OPTION UPCHARGES

### \$ List

Plus Upgrade Two-Seat	129
Plus Upgrade Three-Seat	195

NOTE: One-Seat Plus pricing includes Plus Upgrade, for Two-Seat and Three-Seat add a "B" to the model number and the option upcharge (per unit) above.

# ZOLA PRIVACY | MODULAR - PANELS & ARMS -DIMENSIONS & COM REQUIREMENTS

## DIMENSIONS & COM REQUIREMENTS

		Overall Width	Overall Depth	Overall Height	Shipping Weight	Cubes	COM 1-unit	COM 2-units	COM 3-units	COM 4-units	COM 5-units	COM 6-units
Side Panel, Single, Full Height No Screen												
ZOP3-MPF0S	Start	2.75	27	43.90	38	3	2.7	5.38	8.06	10.75	13.44	16.13
ZOP3-MPF0C	Center	2.75	27	43.90	38	3	2.7	5.38	8.06	10.75	13.44	16.13
ZOP3-MPF0E	End	2.75	27	43.90	38	3	2.7	5.38	8.06	10.75	13.44	16.13
Side Panel, Single, Full Height with Screen												
ZOP3-MPF2S	Start	2.75	27	56.5	40	3	2.7	5.38	8.06	10.75	13.44	16.13
ZOP3-MPF2C	Center	2.75	27	56.5	40	3	2.7	5.38	8.06	10.75	13.44	16.13
ZOP3-MPF2E	End	2.75	27	56.5	40	3	2.7	5.38	8.06	10.75	13.44	16.13
Side Panel, Single, Mid Height No Screen												
ZOP3-MPM0S	Start	2.75	27	31.38	26	2	1.99	3.99	5.98	7.97	9.97	11.96
ZOP3-MPM0C	Center	2.75	27	31.38	26	2	1.99	3.99	5.98	7.97	9.97	11.96
ZOP3-MPM0E	End	2.75	27	31.38	26	2	1.99	3.99	5.98	7.97	9.97	11.96
Side Panel, Single, Mid Height with Screen												
ZOP3-MPM2S	Start	2.75	27	43.88	28	2	1.99	3.99	5.98	7.97	9.97	11.96
ZOP3-MPM2C	Center	2.75	27	43.88	28	2	1.99	3.99	5.98	7.97	9.97	11.96
ZOP3-MPM2E	End	2.75	27	43.88	28	2	1.99	3.99	5.98	7.97	9.97	11.96
Semi-Private Side Panel, Single, Full Height												
ZOP3-MSPF0S	Start	2.75	14.25	44	26	1.5	1.27	2.55	3.83	5.11	6.39	7.67
ZOP3-MSPF0C	Center	2.75	14.25	44	26	1.5	1.27	2.55	3.83	5.11	6.39	7.67
ZOP3-MSPF0E	End	2.75	14.25	44	21	1.5	1.27	2.55	3.83	5.11	6.39	7.67
Semi-Private Side Panel, Single, Mid Height												
ZOP3-MSPM0S	Start	2.75	14.25	31.4	19	1	.88	1.99	2.92	3.72	4.65	5.56
ZOP3-MSPM0C	Center	2.75	14.25	31.4	23	1	.88	1.99	2.92	3.72	4.65	5.56
ZOP3-MSPM0E	End	2.75	14.25	31.4	19	1	.88	1.99	2.92	3.72	4.65	5.56
Modular Upholstered Arm												
ZOP3-MAUPHL*		3	14.5	19.75	25	1.1	1.33	2.11	2.8	3.56	4.44	5
ZOP3-MAUPHR		3	14.5	19.75	25	1.1	1.33	2.11	2.8	3.56	4.44	5
ZOP3-MAUPHC		3	14.5	19.75	25	1.1	1.33	2.11	2.8	3.56	4.44	5
Modular Upholstered Arm w/Urethane Cap												
ZOP3-MAUREL		3	14.5	20.25	28	1.1	1.33	2.11	2.8	3.56	4.44	5
ZOP3-MAURER*		3	14.5	20.25	28	1.1	1.33	2.11	2.8	3.56	4.44	5
ZOP3-MAUREC		3	14.5	20.25	28	1.1	1.33	2.11	2.8	3.56	4.44	5
Modular Upholstered Arm w/Solid Surface Cap												
ZOP3-MASSCL		3	14.5	20.25	28	1.1	1.33	2.11	2.8	3.56	4.44	5
ZOP3-MASSCR		3	14.5	20.25	28	1.1	1.33	2.11	2.8	3.56	4.44	5
ZOP3-MASSCI*		3	14.5	20.25	28	1.1	1.33	2.11	2.8	3.56	4.44	5

# ZOLA PRIVACY | MODULAR

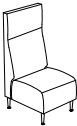
DESCRIPTION/MODEL/SPECIES	COM		COL	FABRIC GRADES			LEATHER		
	1	2	3	4	5	6	7	8	9
 One-Seat, Full Height Back ZOP3-M1F0F	1924	2060	2195	2388	2610	2804	3025	3294	3581

 One-Seat, Full Height Back with Shelf Option ZOP3-M1F1_ Beech/Laminate	2364	2500	2636	2829	3052	3244	3463	3736	4022
Maple/Palette	2460	2594	2732	2924	3144	3340	3560	3829	4116

**ORDERING NOTES:** When ordering units with shelf option please clearly specify on your order the required shelf height - 42", 36" or 30". Freestanding, Start and End units with the shelf option require counterbalance weight added to each seat unit, please add **\$303 list** upcharge per unit. Units with shelf option are not available with Removable Back Cover option.

 One-Seat, Full Height Back with Privacy Screen Option ZOP3-M1F2F	2209	2342	2479	2671	2892	3087	3307	3578	3865
---	------	------	------	------	------	------	------	------	------

**ORDERING NOTES:** Units with Privacy Screen Option are not available with Removable Back Cover option.

 One-Seat, Mid Height Back ZOP3-M1M0F	1811	1918	2026	2176	2348	2502	2673	2888	3109
---	------	------	------	------	------	------	------	------	------

 One-Seat, Mid Height Back with Shelf Option ZOP3-M1M1_ Beech/Laminate	2252	2357	2464	2615	2789	2942	3114	3327	3547
Maple/Palette	2346	2452	2560	2713	2883	3036	3209	3424	3643

**ORDERING NOTES:** When ordering units with shelf option please clearly specify on your order the required shelf height - 42", 36" or 30". Freestanding, Start and End units with the shelf option require counterbalance weight added to each seat unit, please add **\$303 list** upcharge per unit. Units with shelf option are not available with Removable Back Cover option.

 One-Seat, Mid Height Back with Privacy Screen Option ZOP3-M1M2F	2092	2198	2307	2460	2632	2783	2957	3169	3390
--	------	------	------	------	------	------	------	------	------

**ORDERING NOTES:** Units with Privacy Screen Option are not available with Removable Back Cover option.

## Zola Privacy Option Upcharges

	\$ List		\$ List
Moisture Barrier & CAL 133(per yard)	64	Seat Power (per power unit)	641
Removable Seat Covers One-Seat	47	Shelf Power	600
Removable Back Covers One-Seat	68	Table Power	647
Dual Leg (for Multiple unit configurations)	80		

## PRODUCT CODE KEY

Line	Series	Chair Type	Seat Count	Back Type	Leg Type
ZOP	3	M	1	F0	F
Zola	Lounge	Modular	One Seat	Full Height Back	Freestanding Unit
			2	F1	S
			Two Seat	Full Height Back with Shelf Option	Start Unit
			3	F2	C
			Three Seat	Full Height Back with Privacy Screen Option	Center Unit
				M0	E
				Mid Height Back	End Unit
				M1	
				Mid Height Back with Shelf Option	
				M2	
				Mid Height Back with Privacy Screen Option	



# ZOLA PRIVACY | MODULAR

DESCRIPTION/MODEL/SPECIES	COM		COL	FABRIC GRADES			LEATHER		
	1	2	3	4	5	6	7	8	9



One-Seat Plus, Full Height Back  
ZOP3-MB1F0F

2413	2549	2684	2879	3099	3292	3513	3785	4070
------	------	------	------	------	------	------	------	------



One-Seat Plus, Full Height Back with Shelf Option

ZOP3-MB1F1\_ Beech/Laminate  
Maple/Palette

2866	3001	3137	3330	3553	3744	3965	4237	4525
2963	3097	3235	3428	3647	3843	4063	4334	4618

**ORDERING NOTES:** When ordering units with shelf option please clearly specify on your order the required shelf height - 42", 36" or 30". Freestanding, Start and End units with the shelf option require counterbalance weight added to each seat unit, please add **\$303 list** upcharge per unit. Units with shelf option are not available with Removable Back Cover option.



One-Seat Plus, Full Height Back with Privacy Screen Option

ZOP3-MB1F2F

2770	2906	3040	3236	3456	3648	3870	4141	4427
------	------	------	------	------	------	------	------	------

**ORDERING NOTES:** Units with Privacy Screen Option are not available with Removable Back Cover option.



One-Seat Plus, Mid Height Back

ZOP3-MB1M0F

2304	2411	2518	2670	2844	2994	3166	3382	3603
------	------	------	------	------	------	------	------	------



One-Seat Plus, Mid Height Back with Shelf Option

ZOP3-MB1M1\_ Beech/Laminate  
Maple/Palette

2757	2863	2970	3122	3294	3448	3620	3834	4057
2853	2959	3068	3219	3390	3542	3715	3931	4152

**ORDERING NOTES:** When ordering units with shelf option please clearly specify on your order the required shelf height - 42", 36" or 30". Freestanding, Start and End units with the shelf option require counterbalance weight added to each seat unit, please add **\$303 list** upcharge per unit. Units with shelf option are not available with Removable Back Cover option.



One-Seat Plus, Mid Height Back with Privacy Screen Option

ZOP3-MB1M2F

2661	2768	2877	3028	3200	3352	3523	3739	3959
------	------	------	------	------	------	------	------	------

**ORDERING NOTES:** Units with Privacy Screen Option are not available with Removable Back Cover option.

## Zola Privacy Option Upcharges

**\$ List**

**\$ List**

Moisture Barrier & CAL 133(per yard)	64	Seat Power (per power unit)	641
Removable Seat Covers One-Seat	47	Shelf Power	600
Removable Back Covers One-Seat	68	Table Power	647
Dual Leg (for Multiple unit configurations)	80	One-Seat Plus includes Plus Upgrade	

## PRODUCT CODE KEY

Line	Series	Chair Type	Seat Count	Back Type	Leg Type
ZOP Zola	3 Lounge	M Modular	1 One Seat	F0 Full Height Back	F Freestanding Unit
		MB Modular Plus Upgrade	2 Two Seat	F1 Full Height Back with Shelf Option	S Start Unit
			3 Three Seat	F2 Full Height Back with Privacy Screen Option	C Center Unit
				M0 Mid Height Back	E End Unit
				M1 Mid Height Back with Shelf Option	
				M2 Mid Height Back with Privacy Screen Option	

# ZOLA PRIVACY | MODULAR

DESCRIPTION/MODEL/SPECIES	COM		COL	FABRIC GRADES			LEATHER		
	1	2	3	4	5	6	7	8	9



Two-Seat, Full Height Back  
ZOP3-M2F0F

3029	3231	3430	3717	4044	4334	4658	5061	5490
------	------	------	------	------	------	------	------	------



Two-Seat, Full Height Back Shelf Option  
ZOP3-M2F1\_ Beech/Laminate  
Maple/Palette

3563	3763	3963	4252	4580	4867	5192	5595	6023
3663	3864	4064	4352	4679	4967	5292	5693	6122

**ORDERING NOTES:** When ordering units with shelf option please clearly specify on your order the required shelf height - 42", 36" or 30". Freestanding, Start and End units with the shelf option require counterbalance weight added to each seat unit, please add **\$303 list** upcharge per unit. Units with shelf option are not available with Removable Back Cover option.

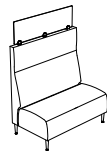

Two-Seat, Full Height Back with Privacy Screen Option  
ZOP3-M2F2F

3519	3718	3920	4207	4534	4822	5006	5549	5978
------	------	------	------	------	------	------	------	------

**ORDERING NOTES:** Units with Privacy Screen Option are not available with Removable Back Cover option.



Two-Seat, Mid Height Back  
ZOP3-M2M0F

2595	2754	2913	3141	3399	3628	3886	4205	4537
------	------	------	------	------	------	------	------	------



Two-Seat, Mid Height Back with Shelf Option  
ZOP3-M2M1\_ Beech/Laminate  
Maple/Palette

3132	3290	3449	3678	3934	4162	4421	4738	5072
3231	3388	3546	3774	4035	4261	4520	4838	5171

**ORDERING NOTES:** When ordering units with shelf option please clearly specify on your order the required shelf height - 42", 36" or 30". Freestanding, Start and End units with the shelf option require counterbalance weight added to each seat unit, please add **\$303 list** upcharge per unit. Units with shelf option are not available with Removable Back Cover option.



Two-Seat, Mid Height Back with Privacy Screen Option  
ZOP3-M2M2F

3087	3245	3404	3633	3891	4117	4377	4693	5030
------	------	------	------	------	------	------	------	------

**ORDERING NOTES:** Units with Privacy Screen Option are not available with Removable Back Cover option.

## Zola Privacy Option Upcharges

**\$ List**

**\$ List**

Moisture Barrier & CAL 133(per yard)	64	Seat Power (per power unit)	641
Removable Seat Covers One-Seat	68	Shelf Power	600
Removable Back Covers One-Seat	97	Table Power	647
Dual Leg (for Multiple unit configurations)	80	Plus Upgrade Two-Seat (B)	129

## PRODUCT CODE KEY

Line	Series	Chair Type	Seat Count	Back Type	Leg Type
ZOP Zola	3 Lounge	M Modular	1 One Seat	F0 Full Height Back	F Freestanding Unit
		MB Modular Plus Upgrade	2 Two Seat	F1 Full Height Back with Shelf Option	S Start Unit
			3 Three Seat	F2 Full Height Back with Privacy Screen Option	C Center Unit
				M0 Mid Height Back	E End Unit
				M1 Mid Height Back with Shelf Option	
				M2 Mid Height Back with Privacy Screen Option	

# ZOLA PRIVACY | MODULAR

DESCRIPTION/MODEL/SPECIES	COM		COL	FABRIC GRADES			LEATHER		
	1	2	3	4	5	6	7	8	9
 Three-Seat, Full Height Back ZOP3-M3F0F	3983	4252	4524	4906	5345	5730	6166	6707	7271

	Three-Seat, Full Height Back Shelf Option ZOP3-M3F1_			Beech/Laminate			4610	4879	5149	5534	5971	6358	6793	7332	7899
				Maple/Palette			4713	4984	5255	5638	6077	6463	6897	7437	8005

**ORDERING NOTES:** When ordering units with shelf option please clearly specify on your order the required shelf height - 42", 36" or 30". Freestanding, Start and End units with the shelf option require counterbalance weight added to each seat unit, please add **\$303 list** upcharge per unit. Units with shelf option are not available with Removable Back Cover option.

	Three-Seat, Full Height Back with Privacy Screen Option ZOP3-M3F2F			4683	4952	5220	5608	6045	6431	6867	7405	7972
---	---	--	--	------	------	------	------	------	------	------	------	------

**ORDERING NOTES:** Units with Privacy Screen Option are not available with Removable Back Cover option.

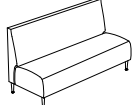
	Three-Seat, Mid Height Back ZOP3-M3M0F			3748	3972	4192	4510	4870	5190	5552	5994	6466
---	---	--	--	------	------	------	------	------	------	------	------	------

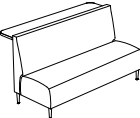
	Three-Seat, Mid Height Back Shelf Option ZOP3-M3M1_			Beech/Laminate			4377	4599	4818	5138	5498	5815	6180	6621	7092
				Maple/Palette			4481	4705	4923	5242	5604	5920	6284	6725	7197

**ORDERING NOTES:** When ordering units with shelf option please clearly specify on your order the required shelf height - 42", 36" or 30". Freestanding, Start and End units with the shelf option require counterbalance weight added to each seat unit, please add **\$303 list** upcharge per unit. Units with shelf option are not available with Removable Back Cover option.

	Three-Seat, Mid Height Back with Privacy Screen Option ZOP3-M3M2F			4449	4670	4891	5211	5572	5890	6252	6692	7164
---	--	--	--	------	------	------	------	------	------	------	------	------





**ORDERING NOTES:** Units with Privacy Screen Option are not available with Removable Back Cover option.

Zola Privacy Option Upcharges		\$ List			\$ List
Moisture Barrier & CAL 133(per yard)		64	Seat Power (per power unit)		641
Removable Seat Covers Three-Seat		85	Shelf Power		600
Removable Back Covers Three-Seat		121	Table Power		647
Dual Leg (for Multiple unit configurations)		80	Plus Upgrade Three-Seat (B)		195

## PRODUCT CODE KEY

Line	Series	Chair Type	Seat Count	Back Type	Leg Type
ZOP Zola	3 Lounge	M Modular	1 One Seat	F0 Full Height Back	F Freestanding Unit
		MB Modular Plus Upgrade	2 Two Seat	F1 Full Height Back with Shelf Option	S Start Unit
			3 Three Seat	F2 Full Height Back with Privacy Screen Option	C Center Unit
				M0 Mid Height Back	E End Unit
				M1 Mid Height Back with Shelf Option	
				M2 Mid Height Back with Privacy Screen Option	

# ZOLA PRIVACY | MODULAR

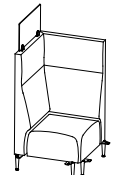
DESCRIPTION/MODEL/SPECIES	COM		COL	FABRIC GRADES			LEATHER			
	1	2	3	4	5	6	7	8	9	
 Modular Corner Seat with Full Height Back ZOP3-MCF0	4058	4290	4522	4846	5219	5546	5917	6382	6848	
 Modular Corner Seat, Full Height Back with Shelves ZOP3-MCF1LR	Beech/Laminate	4937	5169	5403	5727	6099	6424	6796	7262	7729
	Maple/Palette	5033	5264	5497	5823	6196	6521	6893	7358	7822
 Modular Corner Seat, Full Height Back with single shelf left* ZOP3-MCF1L	Beech/Laminate	4744	4988	5233	5574	5966	6308	6697	7185	7333
	Maple/Palette	4749	4992	5236	5579	5970	6312	6703	7190	7337
 Modular Corner Seat, Full Height Back with single shelf right ZOP3-MCF1R	Beech/Laminate	4744	4988	5233	5574	5966	6308	6697	7185	7333
	Maple/Palette	4749	4992	5236	5579	5970	6312	6703	7190	7337
 Modular Corner Seat, Full Height Back with Privacy Screens ZOP3-MCF2LR	4624	4857	5089	5414	5787	6113	6484	6948	7416	
 Modular Corner Seat, Full Height Back with Privacy Screen Left ZOP3-MCF2L	4573	4816	5061	5404	5793	6136	6524	7015	7161	
	Modular Corner Seat, Full Height Back with Privacy Screen Right ZOP3-MCF2R	4573	4816	5061	5404	5793	6136	6524	7015	7161

## Zola Privacy Option Upcharges







## \$ List

Moisture Barrier & CAL 133(per yard)	64
Shelf Power	600
Dual Leg (for Multiple unit configurations)	80
Plus Upgrade- Corner Seat	64

## PRODUCT CODE KEY

Line	Series	Chair Type	Back Type	Shelf/Screen
ZOP Zola	3 Lounge	MC Modular Corner Seat	F0 Full Height Back	L Left Side
		MCB Modular Corner Seat Plus	F1 Full Height Back with Shelf Option	R Right Side
			F2 Full Height Back with Privacy Screen Option	LR Left & Right Sides

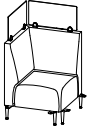
# ZOLA PRIVACY | MODULAR

DESCRIPTION/MODEL/SPECIES	COM		COL	FABRIC GRADES			LEATHER		
	1	2	3	4	5	6	7	8	9
 Modular Corner Seat with Mid Height Back ZOP3-MCM0	3263	3455	3646	3916	4222	4491	4798	5183	5568
 Modular Corner Seat, Mid Height Back with Shelves ZOP3-MCM1LR	Beech/Laminate 4141	4335	4527	4795	5103	5370	5679	6061	6447
	Maple/Palette 4237	4429	4622	4890	5197	5468	5773	6158	6542
 Modular Corner Seat, Mid Height Back with Single Shelf left ZOP3-MCM1L	Beech/Laminate 3909	4112	4313	4595	4919	5201	5524	5925	6052
	Maple/Palette 3914	4116	4385	4600	4922	5205	5528	5929	6055
 Modular Corner Seat, Mid Height Back with Single Shelf Right* ZOP3-MCM1R	Beech/Laminate 3909	4112	4313	4595	4919	5201	5524	5925	6052
	Maple/Palette 3914	4116	4385	4600	4922	5205	5528	5929	6055
 Modular Corner Seat, Mid Height Back with Privacy Screens ZOP3-MCM2LR	3829	4022	4214	4483	4790	5059	5366	5748	6135
 Modular Corner Seat, Full Height Back with Privacy Screen Left* ZOP3-MCM2L	3738	3940	4141	4423	4746	5030	5351	5755	5880
 Modular Corner Seat, Full Height Back with Privacy Screen Right ZOP3-MCM2R	3738	3940	4141	4423	4746	5030	5351	5755	5880

## Zola Privacy Option Upcharges





## \$ List

Moisture Barrier & CAL 133(per yard)	64
Shelf Power	600
Dual Leg (for Multiple unit configurations)	80
Plus Upgrade- Corner Seat	64

## PRODUCT CODE KEY

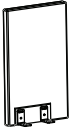
Line	Series	Chair Type	Back Type	Shelf/Screen
ZOP	3	MC	M0	L
Zola	Lounge	Modular Corner Seat	Mid Height Back	Left Side
		MCB	M1	R
		Modular Corner Seat Plus	Mid Height Back with Shelf Option	Right Side
			M2	LR
			Mid Height Back with Privacy Screen Option	Left & Right Sides

# ZOLA PRIVACY | SIDE PANELS

DESCRIPTION/MODEL	COM		COL			FABRIC GRADES			LEATHER		
	1	2	3	4	5	6	7	8	9		
	Side Panel, Single, Full Height No Screen										
	ZOP3-MPF0S	Start	948	1036	1124	1304	1481	1660	1836	2016	2370
	ZOP3-MPF0C	Center	1222	1310	1398	1578	1753	1932	2109	2286	2642
	ZOP3-MPF0E	End	948	1036	1124	1304	1481	1660	1836	2016	2370
	Side Panel, Single, Full Height with Screen										
	ZOP3-MPF2S	Start	1243	1332	1420	1597	1776	1954	2132	2310	2665
	ZOP3-MPF2C	Center	1515	1606	1693	1871	2051	2228	2406	2584	2938
	ZOP3-MPF2E	End	1243	1332	1420	1597	1776	1954	2132	2310	2665
	Side Panel, Single, Mid Height No Screen										
	ZOP3-MPM0S	Start	767	829	888	1011	1131	1251	1372	1492	1732
	ZOP3-MPM0C	Center	1052	1110	1170	1290	1412	1533	1653	1773	2016
	ZOP3-MPM0E	End	767	829	888	1011	1131	1251	1372	1492	1732
	Side Panel, Single, Mid Height with Screen										
	ZOP3-MPM2S	Start	1063	1122	1183	1306	1425	1547	1667	1788	2029
	ZOP3-MPM2C	Center	1346	1405	1465	1587	1706	1827	1947	2066	2310
	ZOP3-MPM2E	End	1063	1122	1183	1306	1425	1547	1667	1788	2029

**ORDERING NOTE:** Side Panels will only connect to Center seating units. Units with Privacy Screen Option are not available with Removable Back Cover option.

## PRODUCT CODE KEY

Line	Series	Chair Type	Height	Position
ZOP	3	MP	F0	S
Zola	Lounge	Modular Side Panel	Full Height	Start
			F2	C
			Full Height with Privacy Screen Option	Center
			M0	E
			Mid Height	End
			M2	
			Mid Height with Privacy Screen Option	

# ZOLA PRIVACY | SEMI-PRIVATE SIDE PANELS & MODULAR ARMS

DESCRIPTION/MODEL	COM		COL			FABRIC GRADES			LEATHER		
	1	2	3	4	5	6	7	8	9		
	Semi-Private Side Panel, Single, Full Height										
	ZOP3-MSPF0S	Start	583	628	674	765	856	949	1039	1132	1314
	ZOP3-MSPF0C	Center	857	905	952	1041	1134	1224	1315	1407	1589
	ZOP3-MSPF0E	End	583	628	674	765	856	949	1039	1132	1314

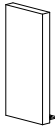
	Semi-Private Side Panel, Single, Mid Height										
	ZOP3-MSPM0S	Start	514	555	592	672	751	829	909	987	1143
	ZOP3-MSPM0C	Center	796	835	875	955	1033	1111	1191	1269	1428
	ZOP3-MSPM0E	End	514	555	592	672	751	829	909	987	1143

**ORDERING NOTE:** Semi-Private Side Panels will only connect to Center seating units.

### PRODUCT CODE KEY

Line	Series	Chair Type	Height	Position
ZOP	3	MSP	F0	S
Zola	Lounge	Modular Semi-Private Side Panel	Full Height	Start
			M0	C
			Mid Height	Center
				E
				End

# ZOLA PRIVACY | MODULAR ARMS

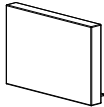
DESCRIPTION/MODEL	COM		COL			FABRIC GRADES			LEATHER	
	1	2	3	4	5	6	7	8	9	
	Modular Upholstered Arm									
	ZOP3-MAUPHL*	702	740	778	853	930	1004	1081	1155	1307
	ZOP3-MAUPHR	702	740	778	853	930	1004	1081	1155	1307
	ZOP3-MAUPHC	784	823	859	935	1012	1087	1163	1239	1390

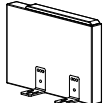
	Modular Upholstered Arm w/Urethane Cap									
	ZOP3-MAUREL	840	878	914	990	1066	1141	1218	1292	1445
	ZOP3-MAURER*	840	878	914	990	1066	1141	1218	1292	1445
	ZOP3-MAUREC	906	942	981	1058	1134	1207	1284	1358	1510

**ORDERING NOTE:** To specify Solid Surface Arm Caps on Modular Upholstered Arms, please add upcharge below and change UPH in the model number to SSC.

Zola Option Upcharges	Grades			
	A-White	A-Color	B	C
Solid Surface Arm Cap (per arm)	129	136	151	157

### PRODUCT CODE KEY

Line	Series	Type	Arm	Position
ZOP	3	MA	UPH	L
Zola	Lounge	Modular Arm	Upholstered	Left Hand Facing
			URE	R
			Upholstered Arm w/Urethane Cap	Right Hand facing
			SSC	C
			Upholstered Arm w/Solid Surface Cap	Center

# ZOLA PRIVACY | TWIN - DIMENSIONS & COM REQUIREMENTS

## DIMENSIONS

	Overall Width	Width with Arms	Overall Depth	Depth w/ Shelf	Overall Height	Overall Height w/Screen	Seat Height	Seat Depth	Shipping Weight	Cubes
<b>Twin Full Height Back</b>										
One-Seat	23	29	52	n/a	50	62.5	18.5	20.25	102	21.0
Two-seat	46	52	52	n/a	50	62.5	18.5	20.25	171	41.2
Three-seat	69	75	52	n/a	50	62.5	18.5	20.25	241	61.3
One-Seat (Plus)	30	36	52	n/a	50	62.5	18.5	20.25	128	27.1
<b>Twin Mid Height Back</b>										
One-Seat	23	29	52	n/a	37.5	50	18.5	20.25	99	15.1
Two-seat	46	52	52	n/a	37.5	50	18.5	20.25	166	29.6
Three-seat	69	75	52	n/a	37.5	50	18.5	20.25	234	44.1
One-Seat (Plus)	30	36	52	n/a	37.5	50	18.5	20.25	124	19.5

## COM YARDAGES

	Yardage Entire Unit	Yardage 2 Entire Units	Yardage 3 Entire Units	Yardage 4 Entire Units	Yardage per Back	Yardage per 2 Backs	Yardage per 3 Backs	Yardage per 4 Backs	Yardage per Seat	Yardage per 2 Seats	Yardage per 3 Seats	Yardage per 4 Seats
<b>Twin Full Height Back</b>												
One-Seat	5.03	8.73	13.76	17.46	2.93	4.53	7.46	9.06	2.1	4.2	6.3	8.4
Two-seat	7.93	14.23	22.16	28.46	4.53	7.73	12.26	15.46	3.4	6.5	9.9	13
Three-seat	10.48	20.76	31.24	41.52	5.88	11.76	17.64	23.52	4.6	9	13.6	18
One-Seat (Plus)	5.6	11.2	16.8	22.4	3.1	6.2	9.3	12.4	2.5	5	7.5	10
<b>Twin Mid Height Back</b>												
One-Seat	4.3	7.52	11.82	15.04	2.2	3.32	5.52	6.64	2.1	4.2	6.3	8.4
Two-seat	6.84	12.38	19.22	24.76	3.44	5.88	9.32	11.76	3.4	6.5	9.9	13
Three-seat	8.9	17.6	26.5	35.2	4.3	8.6	12.9	17.2	4.6	9	13.6	18
One-Seat (Plus)	5	10	15	20	2.5	5	7.5	10	2.5	5	7.5	10

## ZOLA PRIVACY PLUS UPGRADE OPTION UPCHARGES

	\$ List
Plus Upgrade Twin Two-Seat	259
Plus Upgrade Twin Three-Seat	388

NOTE: Twin One-Seat Plus pricing includes Plus Upgrade, for Two-Seat and Three-Seat add a "B" to the model number and the option upcharge (per unit) above.











# ZOLA PRIVACY | TWIN MODULAR PANELS & MODULAR ARMS

## DIMENSIONS & COM REQUIREMENTS

		Overall Width	Overall Depth	Overall Height	Shipping Weight	Cubes	COM 1-unit	COM 2-units	COM 3-units	COM 4-units	COM 5-units	COM 6-units
Side Panel, Single, Full Height No Screen												
ZOP3-MPTF0U	Universal	2.75	51.5	43.9	66	6	4	5.5	9.34	12.03	14.72	18.7
ZOP3-MPTF0C	Center	2.75	51.5	43.9	66	6	4	5.5	9.34	12.03	14.72	18.7
Side Panel, Single, Full Height with Screen												
ZOP3-MPTF2U	Universal	2.75	51.5	56.4	68	6	4	5.5	9.34	12.03	14.72	18.7
ZOP3-MPTF2C	Center	2.75	51.5	56.4	68	6	4	5.5	9.34	12.03	14.72	18.7
Side Panel, Single, Mid Height No Screen												
ZOP3-MPTM0U	Universal	2.75	51.5	31.38	46	4	2.92	4.92	6.91	8.90	10.9	13.82
ZOP3-MPTM0C	Center	2.75	51.5	31.38	46	4	2.92	4.92	6.91	8.90	10.9	13.82
Side Panel, Single, Mid Height with Screen												
ZOP3-MPTM2U	Universal	2.75	51.5	43.88	48	4	2.92	4.92	6.91	8.90	10.9	13.82
ZOP3-MPTM2C	Center	2.75	51.5	43.88	48	4	2.92	4.92	6.91	8.90	10.9	13.82
Twin Semi-Private Side Panel, Single, Full Height												
ZOP3-MSPTF0U	Universal	2.75	26.5	44	43	2.5	2.69	5.38	8.06	10.75	13.44	16.13
ZOP3-MSPTF0C	Center	2.75	26.5	44	52	2.5	2.69	5.38	8.06	10.75	13.44	16.13
Twin Semi-Private Side Panel, Single, Mid Height												
ZOP3-MSPTM0U	Universal	2.75	26.5	31.4	32	1.7	1.75	3.99	5.98	7.97	9.97	11.96
ZOP3-MSPTM0C	Center	2.75	26.5	31.4	39	1.7	1.75	3.99	5.98	7.97	9.97	11.96
Twin Modular Upholstered Arm												
ZOP3-MATUPHU		3	14.5	19.75	22	2.5	2.11	3.56	5	6.5	7.9	9.33
ZOP3-MATUPHC		3	14.5	19.75	22	2.5	2.11	3.56	5	6.5	7.9	9.33
Twin Modular Upholstered Arm w/Urethane Cap												
ZOP3-MATUREU		3	14.5	20.25	16	1.8	2.11	3.56	5	6.5	7.9	9.33
ZOP3-MATUREC		3	14.5	20.25	16	1.8	2.11	3.56	5	6.5	7.9	9.33
Twin Modular Upholstered Arm w/Solid Surface Cap												
ZOP3-MATSSCU		3	14.5	20.25	16	1.8	2.11	3.56	5	6.5	7.9	9.33
ZOP3-MATSSCC		3	14.5	20.25	16	1.8	2.11	3.56	5	6.5	7.9	9.33

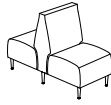







# ZOLA PRIVACY | TWIN SEATS

DESCRIPTION/MODEL	COM		COL			FABRIC GRADES			LEATHER	
	1	2	3	4	5	6	7	8	9	
 Twin One-Seat, Full Height Back ZOP3-MT1F0F	2851	3016	3184	3424	3691	3932	4203	4533	4888	
 Twin One-Seat, Full Height Back with Privacy Screen Option ZOP3-MT1F2F	3134	3299	3465	3707	3975	4214	4484	4816	5170	
<b>ORDERING NOTES:</b> Units with Privacy Screen Option are not available with Removable Back Cover option.										
 Twin One-Seat, Mid Height Back ZOP3-MT1M0F	2713	2853	2995	3200	3430	3635	3866	4149	4454	
 Twin One-Seat, Mid Height Back with Privacy Screen Option ZOP3-MT1M2F	2994	3136	3278	3483	3712	3918	4147	4432	4735	
<b>ORDERING NOTES:</b> Units with Privacy Screen Option are not available with Removable Back Cover option.										
 Twin One-Seat Plus, Full Height Back ZOP3-MBT1F0F	3816	3982	4147	4389	4656	4897	5167	5498	5853	
 Twin One-Seat Plus, Full Height Back with Privacy Screen Option ZOP3-MBT1F2F	4172	4339	4505	4744	5012	5255	5524	5856	6210	
<b>ORDERING NOTES:</b> Units with Privacy Screen Option are not available with Removable Back Cover option.										
 Twin One-Seat Plus, Mid Height Back ZOP3-MBT1M0F	3664	3806	3949	4152	4381	4587	4817	5103	5404	
 Twin One-Seat Plus, Mid Height Back with Privacy Screen Option ZOP3-MBT1M2F	4021	4162	4306	4507	4738	4944	5174	5457	5761	
<b>ORDERING NOTES:</b> Units with Privacy Screen Option are not available with Removable Back Cover option.										

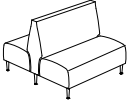
## PRODUCT CODE KEY

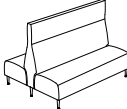
Line	Series	Chair Type	Seat Count	Back Type	Leg Type
ZOP	3	MT	1	F0	F
Zola	Lounge	Modular Twin	One Seat	Full Height Back	Freestanding Unit
		MTB	2	F2	S
		Modular Twin Plus Upgrade (page 207)	Two Seat	Full Height Back with Privacy Screen Option	Start Unit
			3	M0	C
			Three Seat	Mid Height Back	Center Unit
				M2	E
				Mid Height Back with Privacy Screen Option	End Unit

# ZOLA PRIVACY | TWIN SEATS

DESCRIPTION/MODEL	COM		COL			FABRIC GRADES			LEATHER	
	1	2	3	4	5	6	7	8	9	
 Twin Two-Seat, Full Height Back ZOP3-MT2F0F	4235	4496	4756	5143	5578	5966	6399	6921	7516	
 Twin Two-Seat, Full Height Back Privacy Screen Option ZOP3-MT2F2F	4723	4986	5245	5635	6069	6456	6889	7411	8008	
<b>ORDERING NOTES:</b> Units with Privacy Screen Option are not available with Removable Back Cover option.										
 Twin Two-Seat, Mid Height Back ZOP3-MT2M0F	4029	4256	4480	4809	5174	5502	5868	6318	6808	
 Twin Two-Seat, Mid Height Back with Privacy Screen Option ZOP3-MT2M2F	4520	4744	4970	5296	5664	5992	6359	6808	7298	
<b>ORDERING NOTES:</b> Units with Privacy Screen Option are not available with Removable Back Cover option.										
 Twin Three-Seat, Full Height Back ZOP3-MT3F0F	5819	6155	6489	6962	7504	7977	8516	9186	9878	
 Twin Three-Seat, Full Height Back Privacy Screen Option ZOP3-MT3F2F	6518	6854	7186	7660	8203	8678	9217	9885	10575	
<b>ORDERING NOTES:</b> Units with Privacy Screen Option are not available with Removable Back Cover option.										
 Twin Three-Seat, Mid Height Back ZOP3-MT3M0F	5355	5649	5941	6363	6839	7260	7735	8324	8944	
 Twin Three-Seat, Mid Height Back with Privacy Screen Option ZOP3-MT3M2F	6054	6348	6641	7064	7539	7961	8435	9023	9645	
<b>ORDERING NOTES:</b> Units with Privacy Screen Option are not available with Removable Back Cover option.										

## PRODUCT CODE KEY

Line	Series	Chair Type	Seat Count	Back Type	Leg Type
ZOP Zola	3 Lounge	MT Modular Twin	1 One Seat	F0 Full Height Back	F Freestanding Unit
		MTB Modular Twin Plus Upgrade (page 207)	2 Two Seat	F2 Full Height Back with Privacy Screen Option	S Start Unit
			3 Three Seat	M0 Mid Height Back	C Center Unit
				M2 Mid Height Back with Privacy Screen Option	E End Unit

# ZOLA PRIVACY | TWIN - SIDE PANELS

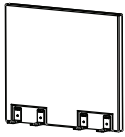
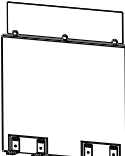
DESCRIPTION/MODEL	COM		COL			FABRIC GRADES			LEATHER		
	1	2	3	4	5	6	7	8	9		
 Twin Side Panel, Full Height No Screen ZOP3-MPTF0U Universal End ZOP3-MPTF0C Center	1428	1559	1691	1955	2218	2483	2745	3010	3536		
	2139	2272	2405	2668	2932	3193	3457	3720	4248		
	<hr/> Twin Side Panel,, Full Height with Screen ZOP3-MPTF2U Universal End 2006 2138 2271 2533 2798 3061 3324 3589 4114 ZOP3-MPTF2C Center 2718 2851 2984 3246 3510 3772 4037 4297 4828										
 Twin Side Panel, Med. Height No Screen ZOP3-MPTM0U Universal End ZOP3-MPTM0C Center	1187	1275	1363	1543	1720	1898	2077	2254	2610		
	1897	1988	2077	2254	2432	2610	2788	2965	3322		
	<hr/> Twin Side Panel, Med. Height with Screen ZOP3-MPTM2U Universal End 1767 1855 1944 2122 2301 2479 2657 2833 3188 ZOP3-MPTM2C Center 2478 2567 2657 2833 3011 3188 3367 3543 3902										

**ORDERING NOTE:** Side Panels will only connect to Center seating units. Units with Privacy Screen Option are not available with Removable Back Cover option. See page 207 for dimensions and COM.

## PRODUCT CODE KEY

Line	Series	Chair Type	Height	Position
ZOP	3	MPT	F0	U
Zola	Lounge	Modular Side Panel Twin	Full Height	Universal (S or E)
			F2	C
			Full Height with Privacy Screen Option	Center /Interim
			M0	
			Mid Height	
			M2	
			Mid Height with Privacy Screen Option	

# ZOLA PRIVACY | TWIN SEMI-PRIVATE SIDE PANELS & MODULAR ARMS

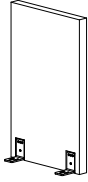
DESCRIPTION/MODEL	COM		COL			FABRIC GRADES			LEATHER		
	1	2	3	4	5	6	7	8	9		
 Twin Semi-Private Side Panel, Single, Full Height	ZOP3-MSPTF0U	Universal	1012	1092	1172	1286	1415	1528	1659	1819	1981
	ZOP3-MSPTF0C	Center	1724	1804	1885	1999	2129	2240	2370	2532	2694

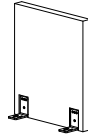
DESCRIPTION/MODEL	COM		COL			FABRIC GRADES			LEATHER		
	1	2	3	4	5	6	7	8	9		
 Twin Semi-Private Side Panel, Single, Mid Height	ZOP3-MSPTM0U	Universal	868	919	973	1045	1131	1203	1288	1393	1497
	ZOP3-MSPTM0C	Center	1581	1633	1686	1758	1842	1915	2001	2106	2211

**ORDERING NOTE:** Semi-Private Side Panels will only connect to Center seating units. See page 207 for dimensions and COM.

## PRODUCT CODE KEY

Line	Series	Type	Height	Position
ZOP	3	MSPT	F0	U
Zola	Lounge	Modular Arm Twin	Full Height	Universal (S or E)
			M0	C
			Mid Height	Center /Interim

# ZOLA PRIVACY | TWIN MODULAR ARMS

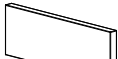
DESCRIPTION/MODEL	COM		COL			FABRIC GRADES			LEATHER	
	1	2	3	4	5	6	7	8	9	
 Twin Modular Upholstered Arm	ZOP3-MATUPHU	1120	1197	1262	1349	1451	1539	1641	1768	1894
	ZOP3-MATUPHC	1846	1909	1974	2062	2164	2253	2354	2481	2608

DESCRIPTION/MODEL	COM		COL			FABRIC GRADES			LEATHER	
	1	2	3	4	5	6	7	8	9	
 Twin Modular Upholstered Arm w/Urethane Cap	ZOP3-MATUREU	1252	1329	1393	1481	1582	1670	1772	1899	2026
	ZOP3-MATUREC	1979	2041	2106	2193	2295	2384	2485	2612	2739

**ORDERING NOTE:** To specify Solid Surface Arm Caps on Modular Upholstered Arms, please add upcharge below and change UPH in the model number to SSC.

Zola Option Upcharges	Grades			
	A-White	A-Color	B	C
Solid Surface Arm Cap (per arm)	276	288	318	328

## PRODUCT CODE KEY

Line	Series	Type	Arm	Position
ZOP	3	MAT	UPH	U
Zola	Lounge	Modular Arm Twin	Upholstered	Universal (S or E)
			URE	C
			Upholstered Arm w/Urethane Cap	Center /Interim
			SSC	
			Upholstered Arm w/Solid Surface Cap	

# ZOLA PRIVACY | CURVED - DIMENSIONS

## DIMENSIONS

	Overall Width	Width with Arms	Overall Depth	Depth w/ Shelf	Overall Height	Overall Height w/Screen	Seat Height	Seat Depth	Shipping Weight	Cubes
<b>Curved Single-Seat - Full Height Back</b>										
30° Inside Curve	36	42	28.5	40.5	50	62.5	18.5	20.25	73	15
45° Inside Curve	42.5	48.5	29	41	50	62.5	18.5	20.25	81	19
60° Inside Curve	48.5	54.5	30	42	50	62.5	18.5	20.25	89	24
90° Inside Curve	59	65	31.5	43.5	50	62.5	18.5	20.25	111	36
30° Outside Curve	33.5	39.5	28.5	40.5	50	62.5	18.5	20.25	65	12
45° Outside Curve	39	45	29	41	50	62.5	18.5	20.25	67	13
60° Outside Curve	43.5	49.5	29	41	50	62.5	18.5	20.25	70	15
90° Outside Curve	52	58	30	42	50	62.5	18.5	20.25	75	16
<b>Curved Single-Seat - Mid Height Back</b>										
30° Inside Curve	36	42	28.5	40.5	37.5	50	18.5	20.25	68	13
45° Inside Curve	42.5	48.5	29	41	37.5	50	18.5	20.25	76	16
60° Inside Curve	48.5	54.5	30	42	37.5	50	18.5	20.25	83	20
90° Inside Curve	59	65	31.5	43.5	37.5	50	18.5	20.25	103	28
30° Outside Curve	33.5	39.5	28.5	40.5	37.5	50	18.5	20.25	62	10
45° Outside Curve	39	45	29	41	37.5	50	18.5	20.25	64	12
60° Outside Curve	43.5	49.5	29	42	37.5	50	18.5	20.25	67	13
90° Outside Curve	52	58	30	43.5	37.5	50	18.5	20.25	73	14
<b>Curved Double-Seat - Full Height Back</b>										
30° Inside Curve	58	64	30	42	50	62.5	18.5	20.25	117	28
45° Inside Curve	64.5	70.5	31.5	43.5	50	62.5	18.5	20.25	124	37
60° Inside Curve	70.5	76.5	33	45	50	62.5	18.5	20.25	132	46
90° Inside Curve	81	87	36	48	50	62.5	18.5	20.25	151	65
30° Outside Curve	55.5	61.5	29.5	41.5	50	62.5	18.5	20.25	101	24
45° Outside Curve	61	67	31	43	50	62.5	18.5	20.25	104	28
60° Outside Curve	65.5	71.5	32	44	50	62.5	18.5	20.25	110	32
90° Outside Curve	74.5	80.5	34.5	46.5	50	62.5	18.5	20.25	121	37
<b>Curved Double-Seat - Mid Height Back</b>										
30° Inside Curve	58	64	30	42	37.5	50	18.5	20.25	110	24
45° Inside Curve	64.5	70.5	31.5	43.5	37.5	50	18.5	20.25	116	31
60° Inside Curve	70.5	76.5	33	45	37.5	50	18.5	20.25	123	38
90° Inside Curve	81	87	36	48	37.5	50	18.5	20.25	141	52
30° Outside Curve	55.5	61.5	29.5	41.5	37.5	50	18.5	20.25	96	21
45° Outside Curve	61	67	31	43	37.5	50	18.5	20.25	99	25
60° Outside Curve	65.5	71.5	32	44	37.5	50	18.5	20.25	105	28
90° Outside Curve	74.5	80.5	34.5	46.5	37.5	50	18.5	20.25	115	32

### Upcharge for Plus Upgrade Option:

Option	\$ List	Option	\$ List
Plus Upgrade -Single-seat curve 30° seat	96	Plus Upgrade -Double-seat curve 30° seat	152
Plus Upgrade -Single-seat curve 45° seat	111	Plus Upgrade -Double-seat curve 45° seat	180
Plus Upgrade -Single-seat curve 60° seat	123	Plus Upgrade -Double-seat curve 60° seat	193
Plus Upgrade -Single-seat curve 90° seat	165	Plus Upgrade -Double-seat curve 90° seat	220

# ZOLA PRIVACY | CURVED - COM REQUIREMENTS







## COM YARDAGES

	Yardage Entire Unit	Yardage 2 Entire Units	Yardage 3 Entire Units	Yardage 4 Entire Units	Yardage per Back	Yardage per 2 Backs	Yardage per 3 Backs	Yardage per 4 Backs	Yardage per Seat	Yardage per 2 Seats	Yardage per 3 Seats	Yardage per 4 Seats
<b>Curved Single-Seat - Full Height Back</b>												
30° Inside Curve	5.2	10.4	15.6	20.8	3.4	6.8	10.2	13.6	1.8	3.6	5.4	7.2
45° Inside Curve	6.3	11.1	15.9	22.2	4.5	7.5	10.5	15	1.8	3.6	5.4	7.2
60° Inside Curve	6.7	12.2	17.67	24.37	4.9	8.6	12.27	17.17	1.8	3.6	5.4	7.2
90° Inside Curve	8.3	16.6	24.9	33.2	6.5	13	19.5	26	1.8	3.6	5.4	7.2
30° Outside Curve	5.3	9.2	13.1	18.4	3.5	5.6	7.7	11.2	1.8	3.6	5.4	7.2
45° Outside Curve	5.3	9.2	13.1	18.4	3.5	5.6	7.7	11.2	1.8	3.6	5.4	7.2
60° Outside Curve	5.3	9.2	13.1	18.4	3.5	5.6	7.7	11.2	1.8	3.6	5.4	7.2
90° Outside Curve	5.3	9.2	13.1	18.4	3.5	5.6	7.7	11.2	1.8	3.6	5.4	7.2
<b>Curved Single-Seat - Mid Height Back</b>												
30° Inside Curve	4.6	9.2	13.8	18.4	2.8	5.6	8.4	11.2	1.8	3.6	5.4	7.2
45° Inside Curve	5.1	9.1	13.15	18.7	3.3	5.5	7.75	11.5	1.8	3.6	5.4	7.2
60° Inside Curve	5.68	10.5	15.2	20.91	3.88	6.9	9.8	13.71	1.8	3.6	5.4	7.2
90° Inside Curve	6.5	13	19.5	26	4.7	9.4	14.1	18.8	1.8	3.6	5.4	7.2
30° Outside Curve	4.7	8.5	12.3	17	2.9	4.9	6.9	9.8	1.8	3.6	5.4	7.2
45° Outside Curve	4.7	8.5	12.3	17	2.9	4.9	6.9	9.8	1.8	3.6	5.4	7.2
60° Outside Curve	4.7	8.5	12.3	17	2.9	4.9	6.9	9.8	1.8	3.6	5.4	7.2
90° Outside Curve	4.7	8.5	12.3	17	2.9	4.9	6.9	9.8	1.8	3.6	5.4	7.2
<b>Curved Double-Seat - Full Height Back</b>												
30° Inside Curve	8.67	17.34	26.01	34.68	5.27	10.54	15.81	21.08	3.4	6.8	10.2	13.6
45° Inside Curve	9.37	18.74	28.11	37.48	5.97	11.94	17.91	23.88	3.4	6.8	10.2	13.6
60° Inside Curve	10.73	20.13	29.53	40.26	7.33	13.33	19.33	26.66	3.4	6.8	10.2	13.6
90° Inside Curve	11.15	20.93	30.73	41.88	7.75	14.13	20.53	28.28	3.4	6.8	10.2	13.6
30° Outside Curve	8.15	14.88	21.61	29.76	4.75	8.08	11.41	16.16	3.4	6.8	10.2	13.6
45° Outside Curve	8.15	14.88	21.61	29.76	4.75	8.08	11.41	16.16	3.4	6.8	10.2	13.6
60° Outside Curve	8.15	14.88	21.45	29.6	4.75	8.08	11.25	16	3.4	6.8	10.2	13.6
90° Outside Curve	8.15	14.88	21.61	29.76	4.75	8.08	11.41	16.16	3.4	6.8	10.2	13.6
<b>Curved Double-Seat - Mid Height Back</b>												
30° Inside Curve	7.8	15.6	23.4	31.2	4.4	8.8	13.2	17.6	3.4	6.8	10.2	13.6
45° Inside Curve	8.09	16.18	24.27	32.36	4.69	9.38	14.07	18.76	3.4	6.8	10.2	13.6
60° Inside Curve	8.9	16.8	24.7	33.6	5.5	10	14.5	20	3.4	6.8	10.2	13.6
90° Inside Curve	8.9	16.8	24.7	33.6	5.5	10	14.5	20	3.4	6.8	10.2	13.6
30° Outside Curve	7.15	13.25	19.7	26.5	3.75	6.45	9.5	12.9	3.4	6.8	10.2	13.6
45° Outside Curve	7.15	13.25	19.7	26.5	3.75	6.45	9.5	12.9	3.4	6.8	10.2	13.6
60° Outside Curve	6.8	12.6	18.4	25.2	3.4	5.8	8.2	11.6	3.4	6.8	10.2	13.6
90° Outside Curve	7.15	13.25	19.7	26.5	3.75	6.45	9.5	12.9	3.4	6.8	10.2	13.6

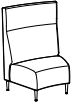
### Upcharge for Removable Upholstery Covers:

Option	\$ List	Option	\$ List
Single-seat curve 30° seat	61	Double-seat curve 30° seat	93
Single-seat curve 45° seat	64	Double-seat curve 45° seat	101
Single-seat curve 60° seat	86	Double-seat curve 60° seat	123
Single-seat curve 90° seat	113	Double-seat curve 90° seat	127

# ZOLA PRIVACY | CURVED

DESCRIPTION/MODEL/SPECIES	COM		COL			FABRIC GRADES			LEATHER	
	1	2	3	4	5	6	7	8	9	
 Single-Seat, 30° Inside Curve, Full Height Back ZOP3-MCIS30DF0F	3430	3618	3806	4068	4369	4634	4931	5308	5684	
 Single-Seat, 30° Inside Curve, Full Height Back with Shelf ZOP3-MCIS30DF1_ Beech/Laminate	4047	4236	4423	4686	4987	5250	5549	5925	6300	
Maple/Palette	4141	4328	4515	4781	5080	5344	5642	6019	6394	
<b>ORDERING NOTE:</b> When ordering a back with Shelf option please clearly specify on your order the required Shelf Height - 42", 36" or 30" and chose required leg type below. Freestanding, Start and End units with the shelf option require counterbalance weight added to each seat unit, please add <b>\$303 list</b> upcharge per unit.										
 Single-Seat, 30° Inside Curve, Full Height Back with Privacy Screen ZOP3-MCIS30DF2F	4023	4212	4398	4664	4962	5227	5527	5902	6277	
 Single-Seat, 30° Inside Curve, Mid Height Back ZOP3-MCIS30DM0F	3273	3437	3604	3834	4098	4328	4592	4922	5250	
 Single-Seat, 30° Inside Curve, Mid Height Back with Shelf ZOP3-MCIS30DM1_ Beech/Laminate	3892	4058	4221	4454	4715	4946	5211	5539	5868	
Maple/Palette	3984	4149	4315	4545	4811	5038	5303	5634	5962	
<b>ORDERING NOTE:</b> When ordering a back with Shelf option please clearly specify on your order the required Shelf Height - 36" or 30" and chose required leg type below. Freestanding, Start and End units with the shelf option require counterbalance weight added to each seat unit, please add <b>\$303 list</b> upcharge per unit.										
 Single-Seat, 30° Inside Curve, Mid Height Back with Privacy Screen Option ZOP3-MCIS30DM2F	3867	4033	4197	4427	4691	4922	5187	5516	5844	

## Zola Privacy Option Upcharges







	\$ List		\$ List
Moisture Barrier & CAL 133(per yard)	64	Plus Upgrade - Single-Seat, 30° Curve	96
Seat Power (per power unit)	641	Dual Leg (for Multiple unit configurations)	80
Shelf Power	600	Removable Seat Covers -Single-Seat, 30° Curve	61
Table Power	647	<b>Note:</b> Removable back covers are not available on curved backs	

## PRODUCT CODE KEY

Line	Series	Chair Type	Curve Style	Seat Degree	Back Type	Leg Type
ZOP	3	MC	IS	30D	F0	F
Zola	Lounge	Modular Curve	Inside Curve -Single		Full Height Back	Freestanding Unit
		MCB	ID	45D	F1	S
		Modular Curve Plus	Inside Curve -Double		Full Height Back with Shelf Option	Start Unit
			OS	60D	F2	C
			Outside Curve -Single		Full Height Back with Privacy Screen Option	Center Unit
			OD	90D	M0	E
			Outside Curve -Double		Mid Height Back	End Unit
					M1	
					Mid Height Back with Shelf Option	
					M2	
					Mid Height Back with Privacy Screen Options	



# ZOLA PRIVACY | CURVED

DESCRIPTION/MODEL/SPECIES	COM		COL		FABRIC GRADES			LEATHER		
	1	2	3	4	5	6	7	8	9	
 Single-Seat, 45° Inside Curve, Full Height Back ZOP3-MCIS45DF0F	3847	4057	4263	4565	4904	5209	5548	5964	6418	
 Single-Seat, 45° Inside Curve, Full Height Back with Shelf ZOP3-MCIS45DF1_	Beech/Laminate	4483	4690	4898	5201	5539	5841	6184	6599	7051
	Maple/Palette	4576	4785	4993	5295	5635	5938	6280	6691	7148
<b>ORDERING NOTE:</b> When ordering a back with Shelf option please clearly specify on your order the required Shelf Height - 42", 36" or 30" and chose required leg type below. Freestanding, Start and End units with the shelf option require counterbalance weight added to each seat unit, please add <b>\$303 list</b> upcharge per unit.										
 Single-Seat, 45° Inside Curve, Full Height Back with Privacy Screen ZOP3-MCIS45DF2F	4447	4655	4863	5167	5506	5809	6149	6565	7018	
 Single-Seat, 45° Inside Curve, Mid Height Back ZOP3-MCIS45DM0F	3642	3811	3979	4215	4486	4722	4994	5329	5673	
 Single-Seat, 45° Inside Curve, Mid Height Back with Shelf ZOP3-MCIS45DM1_	Beech/Laminate	4278	4444	4614	4848	5121	5360	5631	5965	6307
	Maple/Palette	4371	4539	4709	4945	5216	5453	5722	6059	6402
<b>ORDERING NOTE:</b> When ordering a back with Shelf option please clearly specify on your order the required Shelf Height - 36" or 30" and chose required leg type below. Freestanding, Start and End units with the shelf option require counterbalance weight added to each seat unit, please add <b>\$303 list</b> upcharge per unit.										
 Single-Seat, 45° Inside Curve, Mid Height Back with Privacy Screen Option ZOP3-MCIS45DM2F	4243	4411	4580	4816	5086	5323	5595	5931	6271	







## Zola Privacy Option Upcharges

	\$ List		\$ List
Moisture Barrier & CAL 133(per yard)	64	Plus Upgrade -Single-Seat, 45° Curve	111
Seat Power (per power unit)	641	Dual Leg (for Multiple unit configurations)	80
Shelf Power	600	Removable Seat Covers -Single-Seat, 45° Curve	64
Table Power	647	<b>Note:</b> Removable back covers are not available on curved backs	

## PRODUCT CODE KEY

Line	Series	Chair Type	Curve Style	Seat Degree	Back Type	Leg Type
ZOP	3	MC	IS	30D	F0	F
Zola	Lounge	Modular Curve	Inside Curve -Single		Full Height Back	Freestanding Unit
		MCB	ID	45D	F1	S
		Modular Curve Plus	Inside Curve -Double		Full Height Back with Shelf Option	Start Unit
			OS	60D	F2	C
			Outside Curve -Single		Full Height Back with Privacy Screen Option	Center Unit
			OD	90D	M0	E
			Outside Curve -Double		Mid Height Back	End Unit
					M1	
					Mid Height Back with Shelf Option	
					M2	
					Mid Height Back with Privacy Screen Options	

# ZOLA PRIVACY | CURVED

DESCRIPTION/MODEL/SPECIES	COM		COL		FABRIC GRADES			LEATHER	
	1	2	3	4	5	6	7	8	9
 Single-Seat, 60° Inside Curve, Full Height Back ZOP3-MCIS60DF0F	4371	4634	4891	5267	5696	6067	6492	7012	7567
 Single-Seat, 60° Inside Curve, Full Height Back with Shelf ZOP3-MCIS60DF1_ Beech/Laminate	5185	5444	5705	6080	6504	6879	7303	7822	8380
Maple/Palette	5281	5541	5800	6179	6600	6974	7399	7920	8474
<b>ORDERING NOTE:</b> When ordering a back with Shelf option please clearly specify on your order the required Shelf Height - 42", 36" or 30" and chose required leg type below. Freestanding, Start and End units with the shelf option require counterbalance weight added to each seat unit, please add <b>\$303 list</b> upcharge per unit.									
 Single-Seat, 60° Inside Curve, Full Height Back with Privacy Screen ZOP3-MCIS60DF2F	4974	5236	5496	5870	6293	6670	7093	7615	8169
 Single-Seat, 60° Inside Curve, Mid Height Back ZOP3-MCIS60DM0F	4164	4350	4537	4801	5103	5364	5664	6039	6416
 Single-Seat, 60° Inside Curve, Mid Height Back with Shelf ZOP3-MCIS60DM1_ Beech/Laminate	4977	5164	5351	5614	5914	6179	6477	6852	7229
Maple/Palette	5072	5259	5447	5712	6009	6271	6574	6946	7324
<b>ORDERING NOTE:</b> When ordering a back with Shelf option please clearly specify on your order the required Shelf Height - 36" or 30" and chose required leg type below. Freestanding, Start and End units with the shelf option require counterbalance weight added to each seat unit, please add <b>\$303 list</b> upcharge per unit.									
 Single-Seat, 60° Inside Curve, Mid Height Back with Privacy Screen Option ZOP3-MCIS60DM2F	4767	4953	5141	5406	5705	5968	6268	6642	7019

Zola Privacy Option Upcharges	\$ List		\$ List
Moisture Barrier & CAL 133 (per yard)	64	Plus Upgrade - Single-Seat, 60° Curve	123
Seat Power (per power unit)	641	Dual Leg (for Multiple unit configurations)	80
Shelf Power	600	Removable Seat Covers -Single-Seat, 60° Curve	86
Table Power	647	<b>Note:</b> Removable back covers are not available on curved backs	

## PRODUCT CODE KEY

Line	Series	Chair Type	Curve Style	Seat Degree	Back Type	Leg Type
ZOP Zola	3 Lounge	MC Modular Curve	IS Inside Curve -Single	30D	F0 Full Height Back	F Freestanding Unit
		MCB Modular Curve Plus	ID Inside Curve -Double	45D	F1 Full Height Back with Shelf Option	S Start Unit
			OS Outside Curve -Single	60D	F2 Full Height Back with Privacy Screen Option	C Center Unit
			OD Outside Curve -Double	90D	M0 Mid Height Back	E End Unit
					M1 Mid Height Back with Shelf Option	
					M2 Mid Height Back with Privacy Screen Options	

# ZOLA PRIVACY | CURVED

DESCRIPTION/MODEL/SPECIES	COM		COL	FABRIC GRADES			LEATHER		
	1	2	3	4	5	6	7	8	9



Single-Seat, 90° Inside Curve, Full Height Back ZOP3-MCIS90DF0F	4992	5263	5538	5920	6359	6742	7180	7728	8275
--	------	------	------	------	------	------	------	------	------



Single-Seat, 90° Inside Curve, Full Height Back with Shelf ZOP3-MCIS90DF1_ Beech/Laminate	5866	6139	6412	6795	7234	7616	8055	8599	9147
Maple/Palette	5964	6237	6511	6894	7331	7713	8152	8698	9246

**ORDERING NOTE:** When ordering a back with Shelf option please clearly specify on your order the required Shelf Height - 42", 36" or 30" and chose required leg type below. Freestanding, Start and End units with the shelf option require counterbalance weight added to each seat unit, please add **\$303 list** upcharge per unit.



Single-Seat, 90° Inside Curve, Full Height Back with Privacy Screen ZOP3-MCIS90DF2F	5943	6216	6492	6872	7311	7695	8131	8679	9225
--	------	------	------	------	------	------	------	------	------



Single-Seat, 90° Inside Curve, Mid Height Back ZOP3-MCIS90DM0F	4571	4786	5000	5299	5641	5943	6286	6713	7144
---	------	------	------	------	------	------	------	------	------

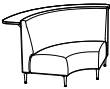

Single-Seat, 90° Inside Curve, Mid Height Back with Shelf ZOP3-MCIS90DM1_ Beech/Laminate	5444	5660	5873	6174	6516	6818	7159	7587	8015
Maple/Palette	5544	5758	5971	6270	6612	6914	7258	7684	8115

**ORDERING NOTE:** When ordering a back with Shelf option please clearly specify on your order the required Shelf Height - 36" or 30" and chose required leg type below. Freestanding, Start and End units with the shelf option require counterbalance weight added to each seat unit, please add **\$303 list** upcharge per unit.









Single-Seat, 90° Inside Curve, Mid Height Back with Privacy Screen Option ZOP3-MCIS90DM2F	5524	5739	5953	6252	6595	6895	7237	7662	8093
--	------	------	------	------	------	------	------	------	------

Zola Privacy Option Upcharges	\$ List		\$ List
Moisture Barrier & CAL 133 (per yard)	64	Plus Upgrade - Single-Seat, 90° Curve	165
Seat Power (per power unit)	641	Dual Leg (for Multiple unit configurations)	80
Shelf Power	600	Removable Seat Covers -Single-Seat, 90° Curve	113
Table Power	647	<b>Note:</b> Removable back covers are not available on curved backs	

**PRODUCT CODE KEY**

Line	Series	Chair Type	Curve Style	Seat Degree	Back Type	Leg Type
ZOP	3	MC	IS	30D	F0	F
Zola	Lounge	Modular Curve	Inside Curve -Single		Full Height Back	Freestanding Unit
		MCB	ID	45D	F1	S
		Modular Curve Plus	Inside Curve -Double		Full Height Back with Shelf Option	Start Unit
			OS	60D	F2	C
			Outside Curve -Single		Full Height Back with Privacy Screen Option	Center Unit
			OD	90D	M0	E
			Outside Curve -Double		Mid Height Back	End Unit
					M1	
					Mid Height Back with Shelf Option	
					M2	
					Mid Height Back with Privacy Screen Options	

# ZOLA PRIVACY | CURVED

DESCRIPTION/MODEL/SPECIES	COM		COL	FABRIC GRADES			LEATHER		
	1	2	3	4	5	6	7	8	9
 Single-Seat, 30° Outside Curve, Full Height Back ZOP3-MCOS30DF0F	3252	3431	3609	3859	4145	4395	4680	5036	5392
 Single-Seat, 30° Outside Curve, Full Height Back with Shelf ZOP3-MCOS30DF1_ Beech/Laminate	3554	3732	3910	4160	4444	4693	4979	5337	5692
Maple/Palette	3642	3819	3999	4248	4533	4784	5068	5425	5782
<b>ORDERING NOTE:</b> When ordering a back with Shelf option please clearly specify on your order the required Shelf Height - 42", 36" or 30" and chose required leg type below. Freestanding, Start and End units with the shelf option require counterbalance weight added to each seat unit, please add <b>\$303 list</b> upcharge per unit.									
 Single-Seat, 30° Outside Curve, Full Height Back with Privacy Screen ZOP3-MCOS30DF2F	3607	3786	3963	4214	4500	4749	5034	5391	5746
 Single-Seat, 30° Outside Curve, Mid Height Back ZOP3-MCOS30DM0F	3135	3290	3445	3664	3914	4131	4380	4690	5007
 Single-Seat, 30° Outside Curve, Mid Height Back with Shelf ZOP3-MCOS30DM1_ Beech/Laminate	3433	3589	3743	3962	4213	4429	4680	4990	5307
Maple/Palette	3522	3679	3831	4053	4299	4520	4769	5079	5394
<b>ORDERING NOTE:</b> When ordering a back with Shelf option please clearly specify on your order the required Shelf Height - 36" or 30" and chose required leg type below. Freestanding, Start and End units with the shelf option require counterbalance weight added to each seat unit, please add <b>\$303 list</b> upcharge per unit.									
 Single-Seat, 30° Outside Curve, Mid Height Back with Privacy Screen Option ZOP3-MCOS30DM2F	3489	3643	3797	4019	4267	4485	4735	5043	5362







## Zola Privacy Option Upcharges

	\$ List		\$ List
Moisture Barrier & CAL 133 (per yard)	64	Plus Upgrade - Single-Seat, 30° Curve	96
Seat Power (per power unit)	641	Dual Leg (for Multiple unit configurations)	80
Shelf Power	600	Removable Seat Covers -Single-Seat, 30° Curve	61
Table Power	647	<b>Note:</b> Removable back covers are not available on curved backs	

## PRODUCT CODE KEY

Line	Series	Chair Type	Curve Style	Seat Degree	Back Type	Leg Type
ZOP	3	MC	IS	30D	F0	F
Zola	Lounge	Modular Curve	Inside Curve -Single		Full Height Back	Freestanding Unit
		MCB	ID	45D	F1	S
		Modular Curve Plus	Inside Curve -Double		Full Height Back with Shelf Option	Start Unit
			OS	60D	F2	C
			Outside Curve -Single		Full Height Back with Privacy Screen Option	Center Unit
			OD	90D	M0	E
			Outside Curve -Double		Mid Height Back	End Unit
					M1	
					Mid Height Back with Shelf Option	
					M2	
					Mid Height Back with Privacy Screen Options	

# ZOLA PRIVACY | CURVED

DESCRIPTION/MODEL/SPECIES	COM		COL		FABRIC GRADES			LEATHER	
	1	2	3	4	5	6	7	8	9
 Single-Seat, 45° Outside Curve, Full Height Back ZOP3-MCOS45DF0F	3508	3685	3864	4113	4398	4648	4932	5288	5646
 Single-Seat, 45° Outside Curve, Full Height Back with Shelf ZOP3-MCOS45DF1_ Beech/Laminate	3803	3981	4158	4407	4693	4944	5230	5584	5941
Maple/Palette	3892	4068	4247	4499	4784	5033	5318	5674	6031
<b>ORDERING NOTE:</b> When ordering a back with Shelf option please clearly specify on your order the required Shelf Height - 42", 36" or 30" and chose required leg type below. Freestanding, Start and End units with the shelf option require counterbalance weight added to each seat unit, please add <b>\$303 list</b> upcharge per unit.									
 Single-Seat, 45° Outside Curve, Full Height Back with Privacy Screen ZOP3-MCOS45DF2F	3859	4038	4215	4466	4752	5002	5286	5641	5999
 Single-Seat, 45° Outside Curve, Mid Height Back ZOP3-MCOS45DM0F	3382	3536	3690	3909	4158	4378	4628	4937	5254
 Single-Seat, 45° Outside Curve, Mid Height Back with Shelf ZOP3-MCOS45DM1_ Beech/Laminate	3678	3830	3985	4205	4455	4672	4922	5232	5547
Maple/Palette	3766	3920	4074	4292	4542	4762	5010	5320	5636
<b>ORDERING NOTE:</b> When ordering a back with Shelf option please clearly specify on your order the required Shelf Height - 36" or 30" and chose required leg type below. Freestanding, Start and End units with the shelf option require counterbalance weight added to each seat unit, please add <b>\$303 list</b> upcharge per unit.									
 Single-Seat, 45° Outside Curve, Mid Height Back with Privacy Screen Option ZOP3-MCOS45DM2F	3735	3890	4042	4261	4510	4730	4979	5288	5605







## Zola Privacy Option Upcharges

	\$ List		\$ List
Moisture Barrier & CAL 133 (per yard)	64	Plus Upgrade - Single-Seat, 45° Curve	111
Seat Power (per power unit)	641	Dual Leg (for Multiple unit configurations)	80
Shelf Power	600	Removable Seat Covers -Single-Seat, 45° Curve	64
Table Power	647	<b>Note:</b> Removable back covers are not available on curved backs	

## PRODUCT CODE KEY

Line	Series	Chair Type	Curve Style	Seat Degree	Back Type	Leg Type
ZOP	3	MC	IS	30D	F0	F
Zola	Lounge	Modular Curve	Inside Curve -Single		Full Height Back	Freestanding Unit
		MCB	ID	45D	F1	S
		Modular Curve Plus	Inside Curve -Double		Full Height Back with Shelf Option	Start Unit
			OS	60D	F2	C
			Outside Curve -Single		Full Height Back with Privacy Screen Option	Center Unit
			OD	90D	M0	E
			Outside Curve -Double		Mid Height Back	End Unit
					M1	
					Mid Height Back with Shelf Option	
					M2	
					Mid Height Back with Privacy Screen Options	

# ZOLA PRIVACY | CURVED

DESCRIPTION/MODEL/SPECIES	COM		COL	FABRIC GRADES			LEATHER		
	1	2	3	4	5	6	7	8	9
 Single-Seat, 60° Outside Curve, Full Height Back ZOP3-MCOS60DF0F	3655	3831	4011	4261	4546	4795	5082	5437	5793
 Single-Seat, 60° Outside Curve, Full Height Back with Shelf ZOP3-MCOS60DF1_ Beech/Laminate	3948	4125	4305	4553	4838	5086	5370	5727	6083
Maple/Palette	4036	4213	4393	4641	4927	5176	5463	5815	6174
<b>ORDERING NOTES:</b> When ordering a back with Shelf option please clearly specify on your order the required Shelf Height - 42", 36" or 30" and chose required leg type below. Freestanding, Start and End units with the shelf option require counterbalance weight added to each seat unit, please add <b>\$303 list</b> upcharge per unit.									
 Single-Seat, 60° Outside Curve, Full Height Back with Privacy Screen ZOP3-MCOS60DF2F	3988	4168	4347	4595	4882	5131	5416	5769	6127
 Single-Seat, 60° Outside Curve, Mid Height Back ZOP3-MCOS60DM0F	3535	3690	3846	4064	4313	4532	4781	5091	5407
 Single-Seat, 60° Outside Curve, Mid Height Back with Shelf ZOP3-MCOS60DM1_ Beech/Laminate	3825	3982	4138	4354	4604	4822	5071	5384	5696
Maple/Palette	3915	4070	4224	4443	4692	4914	5160	5471	5786
<b>ORDERING NOTE:</b> When ordering a back with Shelf option please clearly specify on your order the required Shelf Height - 36" or 30" and chose required leg type below. Freestanding, Start and End units with the shelf option require counterbalance weight added to each seat unit, please add <b>\$303 list</b> upcharge per unit.									
 Single-Seat, 60° Outside Curve, Mid Height Back with Privacy Screen Option ZOP3-MCOS60DM2F	3869	4024	4180	4397	4646	4866	5113	5425	5741







## Zola Privacy Option Upcharges

	\$ List		\$ List
Moisture Barrier & CAL 133 (per yard)	64	Plus Upgrade - Single-Seat, 60° Curve	123
Seat Power (per power unit)	641	Dual Leg (for Multiple unit configurations)	80
Shelf Power	600	Removable Seat Covers -Single-Seat, 60° Curve	86
Table Power	647	<b>Note:</b> Removable back covers are not available on curved backs	

## PRODUCT CODE KEY

Line	Series	Chair Type	Curve Style	Seat Degree	Back Type	Leg Type
ZOP	3	MC	IS	30D	F0	F
Zola	Lounge	Modular Curve	Inside Curve -Single		Full Height Back	Freestanding Unit
		MCB	ID	45D	F1	S
		Modular Curve Plus	Inside Curve -Double		Full Height Back with Shelf Option	Start Unit
			OS	60D	F2	C
			Outside Curve -Single		Full Height Back with Privacy Screen Option	Center Unit
			OD	90D	M0	E
			Outside Curve -Double		Mid Height Back	End Unit
					M1	
					Mid Height Back with Shelf Option	
					M2	
					Mid Height Back with Privacy Screen Options	

# ZOLA PRIVACY | CURVED

DESCRIPTION/MODEL/SPECIES	COM		COL			FABRIC GRADES			LEATHER	
	1	2	3	4	5	6	7	8	9	
 Single-Seat, 90° Outside Curve, Full Height Back ZOP3-MCOS90DF0F	4405	4586	4763	5011	5298	5547	5833	6188	6545	
 Single-Seat, 90° Outside Curve, Full Height Back with Shelf ZOP3-MCOS90DF1_ Beech/Laminate	4686	4866	5043	5293	5579	5828	6113	6470	6828	
Maple/Palette	4773	4952	5131	5381	5664	5914	6199	6556	6913	
<b>ORDERING NOTE:</b> When ordering a back with Shelf option please clearly specify on your order the required Shelf Height - 42", 36" or 30" and chose required leg type below. Freestanding, Start and End units with the shelf option require counterbalance weight added to each seat unit, please add <b>\$303 list</b> upcharge per unit.										
 Single-Seat, 90° Outside Curve, Full Height Back with Privacy Screen ZOP3-MCOS90DF2F	4737	4918	5095	5344	5631	5878	6163	6520	6877	
 Single-Seat, 90° Outside Curve, Mid Height Back ZOP3-MCOS90DM0F	3949	4103	4258	4477	4725	4944	5192	5503	5821	
 Single-Seat, 90° Outside Curve, Mid Height Back with Shelf ZOP3-MCOS90DM1_ Beech/Laminate	4229	4382	4537	4757	5007	5223	5473	5784	6102	
Maple/Palette	4315	4469	4623	4843	5093	5310	5560	5869	6186	
<b>ORDERING NOTE:</b> When ordering a back with Shelf option please clearly specify on your order the required Shelf Height - 36" or 30" and chose required leg type below. Freestanding, Start and End units with the shelf option require counterbalance weight added to each seat unit, please add <b>\$303 list</b> upcharge per unit.										
 Single-Seat, 90° Outside Curve, Mid Height Back with Privacy Screen Option ZOP3-MCOS90DM2F	4279	4433	4588	4810	5057	5275	5525	5834	6153	







## Zola Privacy Option Upcharges

	\$ List		\$ List
Moisture Barrier & CAL 133 (per yard)	64	Plus Upgrade - Single-Seat, 90° Curve	165
Seat Power (per power unit)	641	Dual Leg (for Multiple unit configurations)	80
Shelf Power	600	Removable Seat Covers -Single-Seat, 90° Curve	113
Table Power	647	<b>Note:</b> Removable back covers are not available on curved backs	

## PRODUCT CODE KEY

Line	Series	Chair Type	Curve Style	Seat Degree	Back Type	Leg Type
ZOP	3	MC	IS	30D	F0	F
Zola	Lounge	Modular Curve	Inside Curve -Single		Full Height Back	Freestanding Unit
		MCB	ID	45D	F1	S
		Modular Curve Plus	Inside Curve -Double		Full Height Back with Shelf Option	Start Unit
			OS	60D	F2	C
			Outside Curve -Single		Full Height Back with Privacy Screen Option	Center Unit
			OD	90D	M0	E
			Outside Curve -Double		Mid Height Back	End Unit
					M1	
					Mid Height Back with Shelf Option	
					M2	
					Mid Height Back with Privacy Screen Options	

# ZOLA PRIVACY | CURVED

DESCRIPTION/MODEL/SPECIES	COM		COL		FABRIC GRADES			LEATHER	
	1	2	3	4	5	6	7	8	9
 Double-Seat, 30° Inside Curve, Full Height Back ZOP3-MCID30DF0F	4943	5245	5548	5973	6461	6884	7368	7973	8581
 Double-Seat, 30° Inside Curve, Full Height Back with Shelf ZOP3-MCID30DF1_ Beech/Laminate	5715	6017	6319	6745	7230	7655	8141	8745	9353
Maple/Palette	5811	6114	6418	6842	7329	7754	8236	8843	9447
<b>ORDERING NOTE:</b> When ordering a back with Shelf option please clearly specify on your order the required Shelf Height - 42", 36" or 30" and chose required leg type below. Freestanding, Start and End units with the shelf option require counterbalance weight added to each seat unit, please add <b>\$303 list</b> upcharge per unit.									
 Double-Seat, 30° Inside Curve, Full Height Back with Privacy Screen ZOP3-MCID30DF2F	5888	6190	6494	6918	7403	7829	8312	8918	9525
 Double-Seat, 30° Inside Curve, Mid Height Back ZOP3-MCID30DM0F	4678	4932	5191	5552	5964	6322	6734	7248	7762
 Double-Seat, 30° Inside Curve, Mid Height Back with Shelf ZOP3-MCID30DM1_ Beech/Laminate	5448	5705	5964	6322	6734	7093	7506	8017	8535
Maple/Palette	5546	5802	6060	6420	6832	7191	7603	8117	8632
<b>ORDERING NOTE:</b> When ordering a back with Shelf option please clearly specify on your order the required Shelf Height - 36" or 30" and chose required leg type below. Freestanding, Start and End units with the shelf option require counterbalance weight added to each seat unit, please add <b>\$303 list</b> upcharge per unit.									
 Double-Seat, 30° Inside Curve, Mid Height Back with Privacy Screen Option ZOP3-MCID30DM2F	5620	5878	6137	6496	6909	7267	7680	8193	8706





Zola Privacy Option Upcharges	\$ List		\$ List
Moisture Barrier & CAL 133 (per yard)	64	Plus Upgrade - Double-Seat, 30° Curve	152
Seat Power (per power unit)	641	Dual Leg (for Multiple unit configurations)	80
Shelf Power	600	Removable Seat Covers -Double-Seat, 30° Curve	93
Table Power	647	<b>Note:</b> Removable back covers are not available on curved backs	

## PRODUCT CODE KEY

Line	Series	Chair Type	Curve Style	Seat Degree	Back Type	Leg Type
ZOP	3	MC	IS	30D	F0	F
Zola	Lounge	Modular Curve	Inside Curve -Single		Full Height Back	Freestanding Unit
		MCB	ID	45D	F1	S
		Modular Curve Plus	Inside Curve -Double		Full Height Back with Shelf Option	Start Unit
			OS	60D	F2	C
			Outside Curve -Single		Full Height Back with Privacy Screen Option	Center Unit
			OD	90D	M0	E
			Outside Curve -Double		Mid Height Back	End Unit
					M1	
					Mid Height Back with Shelf Option	
					M2	
					Mid Height Back with Privacy Screen Options	

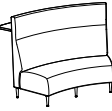

# ZOLA PRIVACY | CURVED





DESCRIPTION/MODEL/SPECIES	COM		COL	FABRIC GRADES			LEATHER		
	1	2	3	4	5	6	7	8	9
 Double-Seat, 45° Inside Curve, Full Height Back ZOP3-MCID45DF0F	5360	5666	5975	6411	6909	7343	7839	8457	9086
 Double-Seat, 45° Inside Curve, Full Height Back with Shelf ZOP3-MCID45DF1_ Beech/Laminate	6161	6469	6779	7214	7711	8146	8643	9261	9887
Maple/Palette	6260	6568	6877	7314	7809	8247	8741	9359	9988
<b>ORDERING NOTE:</b> When ordering a back with Shelf option please clearly specify on your order the required Shelf Height - 42", 36" or 30" and chose required leg type below. Freestanding, Start and End units with the shelf option require counterbalance weight added to each seat unit, please add <b>\$303 list</b> upcharge per unit.									
 Double-Seat, 45° Inside Curve, Full Height Back with Privacy Screen ZOP3-MCID45DF2F	6313	6621	6931	7367	7863	8298	8792	9412	10041
 Double-Seat, 45° Inside Curve, Mid Height Back ZOP3-MCID45DM0F	5103	5367	5635	6014	6444	6822	7255	7787	8340
 Double-Seat, 45° Inside Curve, Mid Height Back with Shelf ZOP3-MCID45DM1_ Beech/Laminate	5904	6170	6438	6817	7248	7625	8056	8590	9143
Maple/Palette	6003	6269	6537	6914	7345	7725	8155	8688	9241
<b>ORDERING NOTE:</b> When ordering a back with Shelf option please clearly specify on your order the required Shelf Height - 36" or 30" and chose required leg type below. Freestanding, Start and End units with the shelf option require counterbalance weight added to each seat unit, please add <b>\$303 list</b> upcharge per unit.									
 Double-Seat, 45° Inside Curve, Mid Height Back with Privacy Screen Option ZOP3-MCID45DM2F	6055	6322	6587	6968	7399	7778	8207	8741	9295

Zola Privacy Option Upcharges	\$ List	\$ List
Moisture Barrier & CAL 133 (per yard)	64	Plus Upgrade - Double-Seat, 45° Curve
Seat Power (per power unit)	641	Dual Leg (for Multiple unit configurations)
Shelf Power	600	Removable Seat Covers -Double-Seat, 45° Curve
Table Power	647	<b>Note:</b> Removable back covers are not available on curved backs

**PRODUCT CODE KEY**

Line	Series	Chair Type	Curve Style	Seat Degree	Back Type	Leg Type
ZOP	3	MC	IS	30D	F0	F
Zola	Lounge	Modular Curve	Inside Curve -Single		Full Height Back	Freestanding Unit
		MCB	ID	45D	F1	S
		Modular Curve Plus	Inside Curve -Double		Full Height Back with Shelf Option	Start Unit
			OS	60D	F2	C
			Outside Curve -Single		Full Height Back with Privacy Screen Option	Center Unit
			OD	90D	M0	E
			Outside Curve -Double		Mid Height Back	End Unit
					M1	
					Mid Height Back with Shelf Option	
					M2	
					Mid Height Back with Privacy Screen Options	

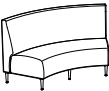
# ZOLA PRIVACY | CURVED

DESCRIPTION/MODEL/SPECIES	COM		COL			FABRIC GRADES			LEATHER	
	1	2	3	4	5	6	7	8	9	
 Double-Seat, 60° Inside Curve, Full Height Back ZOP3-MCID60DF0F	5910	6263	6616	7127	7704	8215	8791	9499	10262	
 Double-Seat, 60° Inside Curve, Full Height Back with Shelf ZOP3-MCID60DF1_	Beech/Laminate 6766	7122	7476	7986	8563	9074	9652	10358	11121	
	Maple/Palette 6867	7219	7573	8085	8662	9172	9751	10458	11219	
<b>ORDERING NOTE:</b> When ordering a back with Shelf option please clearly specify on your order the required Shelf Height - 42", 36" or 30" and chose required leg type below. Freestanding, Start and End units with the shelf option require counterbalance weight added to each seat unit, please add <b>\$303 list</b> upcharge per unit.										
 Double-Seat, 60° Inside Curve, Full Height Back with Privacy Screen ZOP3-MCID60DF2F	6869	7222	7577	8088	8666	9174	9754	10460	11224	
 Double-Seat, 60° Inside Curve, Mid Height Back ZOP3-MCID60DM0F	5588	5884	6175	6595	7069	7487	7963	8548	9161	
 Double-Seat, 60° Inside Curve, Mid Height Back with Shelf ZOP3-MCID60DM1_	Beech/Laminate 6447	6742	7035	7452	7927	8344	8820	9408	10020	
	Maple/Palette 6545	6840	7132	7550	8026	8445	8918	9506	10120	
<b>ORDERING NOTE:</b> When ordering a back with Shelf option please clearly specify on your order the required Shelf Height - 36" or 30" and chose required leg type below. Freestanding, Start and End units with the shelf option require counterbalance weight added to each seat unit, please add <b>\$303 list</b> upcharge per unit.										
 Double-Seat, 60° Inside Curve, Mid Height Back with Privacy Screen Option ZOP3-MCID60DM2F	6549	6842	7135	7553	8029	8447	8920	9508	10123	

## Zola Privacy Option Upcharges

	\$ List	\$ List
Moisture Barrier & CAL 133 (per yard)	64	Plus Upgrade - Double-Seat, 60° Curve 183
Seat Power (per power unit)	641	Dual Leg (for Multiple unit configurations) 80
Shelf Power	600	Removable Seat Covers -Double-Seat, 60° Curve 123
Table Power	647	<b>Note:</b> Removable back covers are not available on curved backs

## PRODUCT CODE KEY

Line	Series	Chair Type	Curve Style	Seat Degree	Back Type	Leg Type
ZOP	3	MC	IS	30D	F0	F
Zola	Lounge	Modular Curve	Inside Curve -Single		Full Height Back	Freestanding Unit
		MCB	ID	45D	F1	S
		Modular Curve Plus	Inside Curve -Double		Full Height Back with Shelf Option	Start Unit
			OS	60D	F2	C
			Outside Curve -Single		Full Height Back with Privacy Screen Option	Center Unit
			OD	90D	M0	E
			Outside Curve -Double		Mid Height Back	End Unit
					M1	
					Mid Height Back with Shelf Option	
					M2	
					Mid Height Back with Privacy Screen Options	

# ZOLA PRIVACY | CURVED

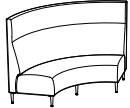
DESCRIPTION/MODEL/SPECIES	COM		COL	FABRIC GRADES			LEATHER		
	1	2	3	4	5	6	7	8	9
 Double-Seat, 90° Inside Curve, Full Height Back ZOP3-MCID90DF0F	6937	7303	7673	8211	8813	9354	9959	10694	11512

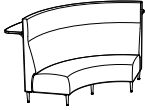
 Double-Seat, 90° Inside Curve, Full Height Back with Shelf ZOP3-MCID90DF1_ Beech/Laminate	7873	8239	8610	9147	9753	10291	10895	11630	12448
Maple/Palette	7973	8341	8709	9249	9853	10390	10994	11732	12549

**ORDERING NOTE:** When ordering a back with Shelf option please clearly specify on your order the required Shelf Height - 42", 36" or 30" and chose required leg type below. Freestanding, Start and End units with the shelf option require counterbalance weight added to each seat unit, please add **\$303 list** upcharge per unit.

 Double-Seat, 90° Inside Curve, Full Height Back with Privacy Screen ZOP3-MCID90DF2F	7942	8308	8678	9217	9818	10358	10963	11699	12514
--	------	------	------	------	------	-------	-------	-------	-------

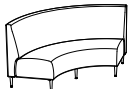
 Double-Seat, 90° Inside Curve, Mid Height Back ZOP3-MCID90DM0F	6441	6735	7028	7446	7921	8340	8813	9403	10014
---	------	------	------	------	------	------	------	------	-------

 Double-Seat, 90° Inside Curve, Mid Height Back with Shelf ZOP3-MCID90DM1_ Beech/Laminate	7379	7674	7966	8385	8859	9277	9753	10339	10953
Maple/Palette	7480	7773	8067	8485	8959	9379	9853	10440	11051

**ORDERING NOTE:** When ordering a back with Shelf option please clearly specify on your order the required Shelf Height - 36" or 30" and chose required leg type below. Freestanding, Start and End units with the shelf option require counterbalance weight added to each seat unit, please add **\$303 list** upcharge per unit.

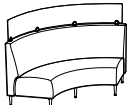
 Double-Seat, 90° Inside Curve, Mid Height Back with Privacy Screen Option ZOP3-MCID90DM2F	7446	7740	8033	8450	8925	9342	9818	10408	11018
--	------	------	------	------	------	------	------	-------	-------

## Zola Privacy Option Upcharges

	\$ List	\$ List
Moisture Barrier & CAL 133 (per yard)	64	Plus Upgrade - Double-Seat, 90° Curve 220
Seat Power (per power unit)	641	Dual Leg (for Multiple unit configurations) 80
Shelf Power	600	Removable Seat Covers - Double-Seat, 90° Curve 127
Table Power	647	<b>Note:</b> Removable back covers are not available on curved backs

## PRODUCT CODE KEY

Line	Series	Chair Type	Curve Style	Seat Degree	Back Type	Leg Type
ZOP	3	MC	IS	30D	F0	F
Zola	Lounge	Modular Curve	Inside Curve -Single		Full Height Back	Freestanding Unit
		MCB	ID	45D	F1	S
		Modular Curve Plus	Inside Curve -Double		Full Height Back with Shelf Option	Start Unit
			OS	60D	F2	C
			Outside Curve -Single		Full Height Back with Privacy Screen Option	Center Unit
			OD	90D	M0	E
			Outside Curve -Double		Mid Height Back	End Unit
					M1	
					Mid Height Back with Shelf Option	
					M2	
					Mid Height Back with Privacy Screen Options	

# ZOLA PRIVACY | CURVED

DESCRIPTION/MODEL/SPECIES	COM		COL			FABRIC GRADES			LEATHER	
	1	2	3	4	5	6	7	8	9	



Double-Seat, 30° Outside Curve, Full Height Back ZOP3-MCOD30DFOF	4593	4879	5166	5563	6020	6419	6873	7445	8015
---	------	------	------	------	------	------	------	------	------



Double-Seat, 30° Outside Curve, Full Height Back with Shelf ZOP3-MCOD30DF1_ Beech/Laminate	5155	5441	5726	6126	6582	6981	7437	8008	8579
Maple/Palette	5248	5534	5821	6219	6676	7073	7531	8099	8670

**ORDERING NOTES:** When ordering a back with Shelf option please clearly specify on your order the required Shelf Height - 42", 36" or 30" and chose required leg type below. Freestanding, Start and End units with the shelf option require counterbalance weight added to each seat unit, please add **\$303 list** upcharge per unit.



Double-Seat, 30° Outside Curve, Full Height Back with Privacy Screen ZOP3-MCOD30DF2F	5192	5478	5764	6163	6620	7018	7474	8044	8615
---	------	------	------	------	------	------	------	------	------



Double-Seat, 30° Outside Curve, Mid Height Back ZOP3-MCOD30DMOF	4398	4637	4873	5206	5586	5918	6296	6770	7245
--	------	------	------	------	------	------	------	------	------



Double-Seat, 30° Outside Curve, Mid Height Back with Shelf ZOP3-MCOD30DM1_ Beech/Laminate	4961	5199	5436	5767	6147	6480	6859	7333	7808
Maple/Palette	5054	5292	5529	5861	6242	6574	6953	7427	7900

**ORDERING NOTES:** When ordering a back with Shelf option please clearly specify on your order the required Shelf Height - 36" or 30" and chose required leg type below. Freestanding, Start and End units with the shelf option require counterbalance weight added to each seat unit, please add **\$303 list** upcharge per unit.



Double-Seat, 30° Outside Curve, Mid Height Back with Privacy Screen Option ZOP3-MCOD30DM2F	4998	5236	5472	5806	6185	6518	6896	7371	7844
---	------	------	------	------	------	------	------	------	------

## Zola Privacy Option Upcharges

	\$ List		\$ List
Moisture Barrier & CAL 133 (per yard)	64	Plus Upgrade - Double-Seat, 30° Curve	152
Seat Power (per power unit)	641	Dual Leg (for Multiple unit configurations)	80
Shelf Power	600	Removable Seat Covers -Double-Seat, 30° Curve	93
Table Power	647	<b>Note:</b> Removable back covers are not available on curved backs	

## PRODUCT CODE KEY

Line	Series	Chair Type	Curve Style	Seat Degree	Back Type	Leg Type
ZOP	3	MC	IS	30D	F0	F
Zola	Lounge	Modular Curve	Inside Curve -Single		Full Height Back	Freestanding Unit
		MCB	ID	45D	F1	S
		Modular Curve Plus	Inside Curve -Double		Full Height Back with Shelf Option	Start Unit
			OS	60D	F2	C
			Outside Curve -Single		Full Height Back with Privacy Screen Option	Center Unit
			OD	90D	M0	E
			Outside Curve -Double		Mid Height Back	End Unit
					M1	
					Mid Height Back with Shelf Option	
					M2	
					Mid Height Back with Privacy Screen Options	

# ZOLA PRIVACY | CURVED

DESCRIPTION/MODEL/SPECIES	COM		COL	FABRIC GRADES			LEATHER		
	1	2	3	4	5	6	7	8	9



Double-Seat, 45° Outside Curve, Full Height Back ZOP3-MCOD45DFOF	4798	5084	5368	5767	6225	6624	7080	7651	8221
---	------	------	------	------	------	------	------	------	------



Double-Seat, 45° Outside Curve, Full Height Back with Shelf ZOP3-MCOD45DF1_ Beech/Laminate	5362	5646	5932	6331	6788	7185	7642	8212	8784
Maple/Palette	5454	5740	6024	6422	6881	7281	7734	8306	8875

**ORDERING NOTE:** When ordering a back with Shelf option please clearly specify on your order the required Shelf Height - 42", 36" or 30" and chose required leg type below. Freestanding, Start and End units with the shelf option require counterbalance weight added to each seat unit, please add **\$303 list** upcharge per unit.



Double-Seat, 45° Outside Curve, Full Height Back with Privacy Screen ZOP3-MCOD45DF2F	5397	5684	5969	6366	6823	7222	7680	8250	8820
---	------	------	------	------	------	------	------	------	------



Double-Seat, 45° Outside Curve, Mid Height Back ZOP3-MCOD45DMOF	4581	4817	5056	5388	5766	6099	6478	6954	7428
--	------	------	------	------	------	------	------	------	------



Double-Seat, 45° Outside Curve, Mid Height Back with Shelf ZOP3-MCOD45DM1_ Beech/Laminate	5142	5381	5616	5947	6330	6661	7042	7515	7989
Maple/Palette	5236	5472	5712	6043	6421	6754	7134	7609	8083

**ORDERING NOTE:** When ordering a back with Shelf option please clearly specify on your order the required Shelf Height - 36" or 30" and chose required leg type below. Freestanding, Start and End units with the shelf option require counterbalance weight added to each seat unit, please add **\$303 list** upcharge per unit.









Double-Seat, 45° Outside Curve, Mid Height Back with Privacy Screen Option ZOP3-MCOD45DM2F	5181	5418	5656	5986	6365	6697	7079	7552	8028
---	------	------	------	------	------	------	------	------	------

Zola Privacy Option Upcharges	\$ List	\$ List
Moisture Barrier & CAL 133 (per yard)	64	Plus Upgrade - Double-Seat, 45° Curve 180
Seat Power (per power unit)	641	Dual Leg (for Multiple unit configurations) 80
Shelf Power	600	Removable Seat Covers - Double-Seat, 45° Curve 101
Table Power	647	<b>Note:</b> Removable back covers are not available on curved backs

## PRODUCT CODE KEY

Line	Series	Chair Type	Curve Style	Seat Degree	Back Type	Leg Type
ZOP	3	MC	IS	30D	F0	F
Zola	Lounge	Modular Curve	Inside Curve -Single		Full Height Back	Freestanding Unit
		MCB	ID	45D	F1	S
		Modular Curve Plus	Inside Curve -Double		Full Height Back with Shelf Option	Start Unit
			OS	60D	F2	C
			Outside Curve -Single		Full Height Back with Privacy Screen Option	Center Unit
			OD	90D	M0	E
			Outside Curve -Double		Mid Height Back	End Unit
					M1	
					Mid Height Back with Shelf Option	
					M2	
					Mid Height Back with Privacy Screen Options	

# ZOLA PRIVACY | CURVED

DESCRIPTION/MODEL/SPECIES	COM		COL	FABRIC GRADES			LEATHER		
	1	2	3	4	5	6	7	8	9
 Double-Seat, 60° Outside Curve, Full Height Back ZOP3-MCOD60DFOF	5050	5336	5619	6019	6474	6873	7331	7900	8471
 Double-Seat, 60° Outside Curve, Full Height Back with Shelf ZOP3-MCOD60DF1_ Beech/Laminate	5609	5894	6181	6579	7035	7435	7890	8460	9028
Maple/Palette	5702	5986	6270	6670	7125	7524	7982	8552	9120
<b>ORDERING NOTE:</b> When ordering a back with Shelf option please clearly specify on your order the required Shelf Height - 42", 36" or 30" and chose required leg type below. Freestanding, Start and End units with the shelf option require counterbalance weight added to each seat unit, please add <b>\$303 list</b> upcharge per unit.									
 Double-Seat, 60° Outside Curve, Full Height Back with Privacy Screen ZOP3-MCOD60DF2F	5647	5933	6218	6616	7072	7472	7928	8499	9067
 Double-Seat, 60° Outside Curve, Mid Height Back ZOP3-MCOD60DMOF	4798	5035	5274	5607	5985	6317	6696	7173	7646
 Double-Seat, 60° Outside Curve, Mid Height Back with Shelf ZOP3-MCOD60DM1_ Beech/Laminate	5360	5595	5833	6164	6543	6875	7257	7731	8205
Maple/Palette	5450	5686	5924	6256	6634	6968	7346	7821	8296
<b>ORDERING NOTE:</b> When ordering a back with Shelf option please clearly specify on your order the required Shelf Height - 36" or 30" and chose required leg type below. Freestanding, Start and End units with the shelf option require counterbalance weight added to each seat unit, please add <b>\$303 list</b> upcharge per unit.									
 Double-Seat, 60° Outside Curve, Mid Height Back with Privacy Screen Option ZOP3-MCOD60DM2F	5395	5634	5870	6206	6582	6914	7294	7768	8241







## Zola Privacy Option Upcharges

	\$ List	\$ List
Moisture Barrier & CAL 133 (per yard)	64	Plus Upgrade - Double-Seat, 60° Curve
Seat Power (per power unit)	641	Dual Leg (for Multiple unit configurations)
Shelf Power	600	Removable Seat Covers - Double-Seat, 60° Curve
Table Power	647	<b>Note:</b> Removable back covers are not available on curved backs

## PRODUCT CODE KEY

Line	Series	Chair Type	Curve Style	Seat Degree	Back Type	Leg Type
ZOP Zola	3 Lounge	MC Modular Curve	IS Inside Curve -Single	30D	F0 Full Height Back	F Freestanding Unit
		MCB Modular Curve Plus	ID Inside Curve -Double	45D	F1 Full Height Back with Shelf Option	S Start Unit
			OS Outside Curve -Single	60D	F2 Full Height Back with Privacy Screen Option	C Center Unit
			OD Outside Curve -Double	90D	M0 Mid Height Back	E End Unit
					M1 Mid Height Back with Shelf Option	
					M2 Mid Height Back with Privacy Screen Options	

# ZOLA PRIVACY | CURVED

DESCRIPTION/MODEL/SPECIES	COM		COL	FABRIC GRADES			LEATHER		
	1	2	3	4	5	6	7	8	9
 Double-Seat, 90° Outside Curve, Full Height Back ZOP3-MCOD90DF0F	5659	5944	6229	6628	7084	7484	7940	8511	9080
 Double-Seat, 90° Outside Curve, Full Height Back with Shelf ZOP3-MCOD90DF1_ Beech/Laminate	6212	6497	6784	7182	7638	8038	8493	9064	9632
Maple/Palette	6304	6587	6873	7271	7730	8129	8584	9157	9725
<b>ORDERING NOTES:</b> When ordering a back with Shelf option please clearly specify on your order the required Shelf Height - 42", 36" or 30" and chose required leg type below. Freestanding, Start and End units with the shelf option require counterbalance weight added to each seat unit, please add <b>\$303 list</b> upcharge per unit.									
 Double-Seat, 90° Outside Curve, Full Height Back with Privacy Screen ZOP3-MCOD90DF2F	6247	6534	6819	7216	7674	8073	8529	9099	9668
 Double-Seat, 90° Outside Curve, Mid Height Back ZOP3-MCOD90DM0F	5507	5833	6159	6663	7216	7722	8276	8930	9737
 Double-Seat, 90° Outside Curve, Mid Height Back with Shelf ZOP3-MCOD90DM1_ Beech/Laminate	6060	6387	6713	7216	7770	8276	8830	9482	10291
Maple/Palette	6154	6477	6805	7310	7863	8367	8919	9573	10382
<b>ORDERING NOTES:</b> When ordering a back with Shelf option please clearly specify on your order the required Shelf Height - 36" or 30" and chose required leg type below. Freestanding, Start and End units with the shelf option require counterbalance weight added to each seat unit, please add <b>\$303 list</b> upcharge per unit.									
 Double-Seat, 90° Outside Curve, Mid Height Back with Privacy Screen Option ZOP3-MCOD90DM2F	6097	6421	6749	7255	7807	8310	8865	9517	10328





## Zola Privacy Option Upcharges

	\$ List		\$ List
Moisture Barrier & CAL 133 (per yard)	64	Plus Upgrade - Double-Seat, 90° Curve	220
Seat Power (per power unit)	641	Dual Leg (for Multiple unit configurations)	80
Shelf Power	600	Removable Seat Covers - Double-Seat, 90° Curve	127
Table Power	647	<b>Note:</b> Removable back covers are not available on curved backs	

## PRODUCT CODE KEY

Line	Series	Chair Type	Curve Style	Seat Degree	Back Type	Leg Type
ZOP	3	MC	IS	30D	F0	F
Zola	Lounge	Modular Curve	Inside Curve -Single		Full Height Back	Freestanding Unit
		MCB	ID	45D	F1	S
		Modular Curve Plus	Inside Curve -Double		Full Height Back with Shelf Option	Start Unit
			OS	60D	F2	C
			Outside Curve -Single		Full Height Back with Privacy Screen Option	Center Unit
			OD	90D	M0	E
			Outside Curve -Double		Mid Height Back	End Unit
					M1	
					Mid Height Back with Shelf Option	
					M2	
					Mid Height Back with Privacy Screen Options	

# ZOLA PRIVACY | SIDE PANELS

DESCRIPTION/MODEL/SPECIES	COM		COL			FABRIC GRADES			LEATHER		
	1	2	3	4	5	6	7	8	9		
	Side Panel, Single, Full Height No Screen										
	ZOP3-MPF0S	Start	948	1036	1124	1304	1481	1660	1836	2016	2370
	ZOP3-MPF0C	Center	1222	1310	1398	1578	1753	1932	2109	2286	2642
	ZOP3-MPF0E	End	948	1036	1124	1304	1481	1660	1836	2016	2370
	Side Panel, Single, Full Height with Screen										
	ZOP3-MPF2S	Start	1243	1332	1420	1597	1776	1954	2132	2310	2665
	ZOP3-MPF2C	Center	1515	1606	1693	1871	2051	2228	2406	2584	2938
	ZOP3-MPF2E	End	1243	1332	1420	1597	1776	1954	2132	2310	2665
	Side Panel, Single, Mid Height No Screen										
	ZOP3-MPM0S	Start	767	829	888	1011	1131	1251	1372	1492	1732
	ZOP3-MPM0C	Center	1052	1110	1170	1290	1412	1533	1653	1773	2016
	ZOP3-MPM0E	End	767	829	888	1011	1131	1251	1372	1492	1732
	Side Panel, Single, Mid Height with Screen										
	ZOP3-MPM2S	Start	1063	1122	1183	1306	1425	1547	1667	1788	2029
	ZOP3-MPM2C	Center	1346	1405	1465	1587	1706	1827	1947	2066	2310
	ZOP3-MPM2E	End	1063	1122	1183	1306	1425	1547	1667	1788	2029

**ORDERING NOTE:** Side Panels will only connect to Center seating units. Units with Privacy Screen Option are not available with Removable Back Cover option. See page 198 for Dimensions and COM.

## PRODUCT CODE KEY

Line	Series	Chair Type	Height	Position
ZOP	3	MP	F0	S
Zola	Lounge	Modular Side Panel	Full Height	Start
			F2	C
			Full Height with Privacy Screen Option	Center
			M0	E
			Mid Height	End
			M2	
			Mid Height with Privacy Screen Option	



# ZOLA PRIVACY | SEMI-PRIVATE SIDE PANELS & MODULAR ARMS

DESCRIPTION/MODEL	COM		COL			FABRIC GRADES			LEATHER		
	1	2	3	4	5	6	7	8	9		
	Semi-Private Side Panel, Single, Full Height										
	ZOP3-MSPF0S	Start	583	628	674	765	856	949	1039	1132	1314
	ZOP3-MSPF0C	Center	857	905	952	1041	1134	1224	1315	1407	1589
	ZOP3-MSPF0E	End	583	628	674	765	856	949	1039	1132	1314

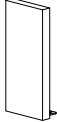
	Semi-Private Side Panel, Single, Mid Height										
	ZOP3-MSPM0S	Start	514	555	592	672	751	829	909	987	1143
	ZOP3-MSPM0C	Center	796	835	875	955	1033	1111	1191	1269	1428
	ZOP3-MSPM0E	End	514	555	592	672	751	829	909	987	1143

**ORDERING NOTE:** Semi-Private Side Panels will only connect to Center seating units.

## PRODUCT CODE KEY

Line	Series	Chair Type	Height	Position
<b>ZOP</b> Zola	<b>3</b> Lounge	<b>MSP</b> Modular Semi-Private Side Panel	<b>F0</b> Full Height <b>M0</b> Mid Height	<b>S</b> Start <b>C</b> Center <b>E</b> End

# ZOLA PRIVACY | MODULAR ARMS

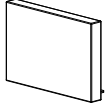
DESCRIPTION/MODEL	COM		COL			FABRIC GRADES			LEATHER		
	1	2	3	4	5	6	7	8	9		
	Modular Upholstered Arm										
	ZOP3-MAUPLH*		702	740	778	853	930	1004	1081	1155	1307
	ZOP3-MAUPHR		702	740	778	853	930	1004	1081	1155	1307
	ZOP3-MAUPHC		784	823	859	935	1012	1087	1163	1239	1390

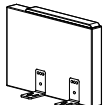
	Modular Upholstered Arm w/Urethane Cap										
	ZOP3-MAUREL		840	878	914	990	1066	1141	1218	1292	1445
	ZOP3-MAURER*		840	878	914	990	1066	1141	1218	1292	1445
	ZOP3-MAUREC		906	942	981	1058	1134	1207	1284	1358	1510

**ORDERING NOTE:** To specify Solid Surface Arm Caps on Modular Upholstered Arms, please add upcharge below and change UPH in the model number to SSC.

Zola Option Upcharges	Grades			
	A-White	A-Color	B	C
Solid Surface Arm Cap (per arm)	129	136	151	157

## PRODUCT CODE KEY

Line	Series	Type	Arm	Position
<b>ZOP</b> Zola	<b>3</b> Lounge	<b>MA</b> Modular Arm	<b>UPH</b> Upholstered <b>URE</b> Upholstered Arm w/Urethane Cap <b>SSC</b> Upholstered Arm w/Solid Surface Cap	<b>L</b> Left Hand Facing <b>R</b> Right Hand facing <b>C</b> Center

# ZOLA PRIVACY | TWIN CURVED - DIMENSIONS & COM REQUIREMENTS

## DIMENSIONS

	Overall Width	Width with Arms	Overall Depth	Overall Height	Height w/Screen	Overall Seat Height	Seat Depth	Shipping Weight	Cubes
<b>Twin Curved Single-Seat - Full Height Back</b>									
30° Curve	49	55	53.5	50	62.5	18.5	20.25	127	31
45° Curve	61.5	67.5	54	50	62.5	18.5	20.25	146	42
60° Curve	73.5	79.5	55	50	62.5	18.5	20.25	164	55
90° Curve	94.5	100.5	56.5	50	62.5	18.5	20.25	207	79
<b>Twin Curved Single-Seat - Mid Height Back</b>									
30° Curve	49	55	53.5	37.5	50	18.5	20.25	122	27
45° Curve	61.5	67.5	54	37.5	50	18.5	20.25	140	37
60° Curve	73.5	79.5	55	37.5	50	18.5	20.25	158	48
90° Curve	94.5	100.5	56.5	37.5	50	18.5	20.25	200	68
<b>Twin Curved Double-Seat - Full Height Back</b>									
30° Curve	71	77	55	50	62.5	18.5	20.25	199	55
45° Curve	83.5	89.5	56	50	62.5	18.5	20.25	215	73
60° Curve	95.5	101.5	58	50	62.5	18.5	20.25	237	92
<b>Twin Curved Double-Seat - Mid Height Back</b>									
30° Curve	71	77	55	37.5	50	18.5	20.25	199	48
45° Curve	83.5	89.5	56	37.5	50	18.5	20.25	215	64
60° Curve	95.5	101.5	58	37.5	50	18.5	20.25	237	81







## COM YARDAGES

	Yardage Entire Unit	Yardage 2 Entire Units	Yardage 3 Entire Units	Yardage 4 Entire Units	Yardage per Back	Yardage per 2 Backs	Yardage per 3 Backs	Yardage per 4 Backs
<b>Curved Single-Seat - Full Height Back</b>								
30° Curve	8.6	15.6	24.2	31.2	4.8	8	12.8	16
45° Curve	9.6	17.6	27.2	35.2	4.8	8	12.8	16
60° Curve	11.53	20.8	31.2	41.6	6.33	10.4	15.6	20.8
90° Curve	11.83	24.50	36.75	48.70	6.33	13.5	20.25	27
<b>Curved Single-Seat - Mid Height Back</b>								
30° Curve	7.63	13.85	21.48	27.7	3.83	6.25	10.08	12.5
45° Curve	8.63	15.85	24.48	31.7	3.83	6.25	10.08	12.5
60° Curve	10.2	18.4	27.6	36.8	5	8	12	16
90° Curve	10.5	21	31.5	41.7	5	10	15	20
<b>Curved Double-Seat - Full Height Back</b>								
30° Curve	12.96	27.1	40.65	54.2	6.16	13.5	20.25	27
45° Curve	13.13	27.1	40.65	54.2	6.33	13.5	20.25	27
60° Curve	13.23	27.3	40.95	54.6	6.33	13.5	20.25	27
90° Curve								
<b>Curved Double-Seat - Mid Height Back</b>								
30° Curve	11.63	23.60	35.4	47.2	4.83	10	15	20
45° Curve	11.8	23.6	35.4	47.2	5	10	15	20
60° Curve	11.9	23.8	35.7	47.6	5	10	15	20

## ZOLA PRIVACY | TWIN CURVED - COM REQUIREMENTS

	Yardage 1 Seat-Small Seat	Yardage 2 Seat-Small Seats	Yardage 3 Seat-Small Seats	Yardage 4 Seat-Small Seats	Yardage 1 Seat-Large Seat	Yardage 2 Seat-Large Seats	Yardage 3 Seat-Large Seats	Yardage 4 Seat-Large Seats
<b>Curved Single-Seat - Full Height Back</b>								
30° Curve	1.8	3.6	5.4	7.2	2	4	6	8
45° Curve	1.8	3.6	5.4	7.2	3	6	9	12
60° Curve	1.8	3.6	5.4	7.2	3.4	6.8	10.2	13.6
90° Curve	1.8	3.6	5.4	7.2	3.7	7.4	11.10	14.5
<b>Curved Single-Seat - Mid Height Back</b>								
30° Curve	1.8	3.6	5.4	7.2	2	4	6	8
45° Curve	1.8	3.6	5.4	7.2	3	6	9	12
60° Curve	1.8	3.6	5.4	7.2	3.4	6.8	10.2	13.6
90° Curve	1.8	3.6	5.4	7.2	3.7	7.4	11.1	14.5
<b>Curved Double-Seat - Full Height Back</b>								
30° Curve	3.4	6.8	10.2	13.6	3.4	6.8	10.2	13.6
45° Curve	3.4	6.8	10.2	13.6	3.4	6.8	10.2	13.6
60° Curve	3.4	6.8	10.2	13.6	3.5	7	10.5	14
<b>Curved Double-Seat - Mid Height Back</b>								
30° Curve	3.4	6.8	10.2	13.6	3.4	6.8	10.2	13.6
45° Curve	3.4	6.8	10.2	13.6	3.4	6.8	10.2	13.6
60° Curve	3.4	6.8	10.2	13.6	3.4	7	10.5	14

# ZOLA PRIVACY | TWIN CURVED

DESCRIPTION/MODEL	COM		COL	FABRIC GRADES			LEATHER		
	1	2	3	4	5	6	7	8	9
 Twin Single-Seat, 30° Curve, Full Height Back ZOP3-MCTS30DF0F	5204	5517	5830	6268	6767	7208	7709	8335	8960
 Twin Single-Seat, 30° Curve, Full Height Back with Privacy Screen Option ZOP3-MCTS30DF2F	5796	6111	6422	6862	7362	7800	8302	8930	9555
 Twin Single-Seat, 30° Curve, Mid Height Back ZOP3-MCTS30DM0F	4930	5213	5494	5888	6336	6731	7180	7741	8305
 Twin Single-Seat, 30° Curve, Mid Height Back with Privacy Screen Option ZOP3-MCTS30DM2F	5525	5806	6085	6480	6931	7323	7773	8337	8896
 Twin Single-Seat, 45° Curve, Full Height Back ZOP3-MCTS45DF0F	5867	6191	6519	6977	7498	7953	8477	9130	9781
 Twin Single-Seat, 45° Curve, Full Height Back with Privacy Screen Option ZOP3-MCTS45DF2F	6468	6793	7120	7577	8098	8555	9079	9730	10382







## Zola Privacy Option Upcharges

	\$ List		\$ List
Moisture Barrier & CAL 133 (per yard)	64	Plus Upgrade - Twin Single-Seat, 30° Curve	287
Seat Power (per power unit)	641	Plus Upgrade - Twin Single-Seat, 45° Curve	345
Shelf Power	600	Removable Seat Covers -Twin Single-Seat, 30° Curve	155
Table Power	647	Removable Seat Covers -Twin Single-Seat, 45° Curve	166
Dual Leg (for Multiple unit configurations)	80	<b>Note:</b> Removable back covers are not available on curved backs	

## PRODUCT CODE KEY

Line	Series	Chair Type	Curve Style	Seat Degree	Back Type	Leg Type
ZOP Zola	3 Lounge	MCT Modular Curve Twin	S Small Radius- Single Width	30D	F0 Full Height Back	F Freestanding Unit
		MCTB Modular Curve Twin Plus	D Small Radius- Double Width	45D	F2 Full Height Back with Privacy Screen Option	S Start Unit
				60D	M0 Mid Height Back	C Center Unit
				90D	M2 Mid Height Back with Privacy Screen Options	E End Unit

# ZOLA PRIVACY | TWIN CURVED

DESCRIPTION/MODEL	COM		COL	FABRIC GRADES			LEATHER		
	1	2	3	4	5	6	7	8	9
 Twin Single-Seat, 45° Curve, Mid Height Back ZOP3-MCTS45DMOF	5556	5850	6142	6556	7027	7438	7909	8499	9087
 Twin Single-Seat, 45° Curve, Mid Height Back with Privacy Screen Option ZOP3-MCTS45DM2F	5531	5812	6093	6489	6938	7331	7781	8342	8905
 Twin Single-Seat, 60° Curve, Full Height Back ZOP3-MCTS60DFOF	6662	7045	7430	7966	8580	9116	9729	10495	11261
 Twin Single-Seat, 60° Curve, Full Height Back with Privacy Screen Option ZOP3-MCTS60DF2F	7266	7649	8033	8569	9184	9719	10333	11098	11866
 Twin Single-Seat, 60° Curve, Mid Height Back ZOP3-MCTS60DMOF	6304	6644	6983	7460	8002	8477	9020	9697	10379
 Twin Single-Seat, 60° Curve, Mid Height Back with Privacy Screen Option ZOP3-MCTS60DM2F	7480	7913	8345	8955	9650	10259	10953	11820	12688



## Zola Privacy Option Upcharges

	\$ List		\$ List
Moisture Barrier & CAL 133 (per yard)	64	Plus Upgrade - Twin Single-Seat, 45° Curve	345
Seat Power (per power unit)	641	Plus Upgrade - Twin Single-Seat, 60° Curve	404
Shelf Power	600	Removable Seat Covers -Twin Single-Seat, 45° Curve	166
Table Power	647	Removable Seat Covers -Twin Single-Seat, 60° Curve	212
Dual Leg (for Multiple unit configurations)	80	<b>Note:</b> Removable back covers are not available on curved backs	

## PRODUCT CODE KEY

Line	Series	Chair Type	Curve Style	Seat Degree	Back Type	Leg Type
ZOP Zola	3 Lounge	MCT Modular Curve Twin	S Small Radius- Single Width	30D	F0 Full Height Back	F Freestanding Unit
		MCTB Modular Curve Twin Plus	D Small Radius- Double Width	45D	F2 Full Height Back with Privacy Screen Option	S Start Unit
				60D	M0 Mid Height Back	C Center Unit
				90D	M2 Mid Height Back with Privacy Screen Options	E End Unit

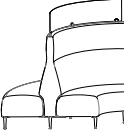
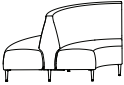
# ZOLA PRIVACY | TWIN CURVED





DESCRIPTION/MODEL/SPECIES	COM		COL	FABRIC GRADES			LEATHER		
	1	2	3	4	5	6	7	8	9
 Twin Single-Seat, 90° Curve, Full Height Back ZOP3-MCTS90DF0F	8312	8702	9091	9644	10270	10818	11446	12225	13017
 Twin Single-Seat, 90° Curve, Full Height Back with Privacy Screen Option ZOP3-MCTS90DF2F	9265	9654	10044	10594	11223	11769	12396	13175	13969
 Twin Single-Seat, 90° Curve, Mid Height Back ZOP3-MCTS90DM0F	7814	8159	8506	8994	9550	10040	10594	11286	11991
 Twin Single-Seat, 90° Curve, Mid Height Back with Privacy Screen Option ZOP3-MCTS90DM2F	7447	7838	8230	8775	9398	9945	10570	11349	12130

Zola Privacy Option Upcharges	\$ List	\$ List
Moisture Barrier & CAL 133 (per yard)	64	Plus Upgrade - Twin Single-Seat, 90° Curve 516
Seat Power (per power unit)	641	Dual Leg (for Multiple unit configurations) 80
Shelf Power	600	Removable Seat Covers -Twin Single-Seat, 90° Curve 240
Table Power	647	<b>Note:</b> Removable back covers are not available on curved backs

## PRODUCT CODE KEY

Line	Series	Chair Type	Curve Style	Seat Degree	Back Type	Leg Type
ZOP Zola	3 Lounge	MCT Modular Curve Twin	S Small Radius-Single Width	30D	F0 Full Height Back	F Freestanding Unit
		MCTB Modular Curve Twin Plus	D Small Radius-Double Width	45D	F2 Full Height Back with Privacy Screen Option	S Start Unit
				60D	M0 Mid Height Back	C Center Unit
				90D	M2 Mid Height Back with Privacy Screen Options	E End Unit

# ZOLA PRIVACY | TWIN CURVED

DESCRIPTION/MODEL/SPECIES	COM		COL		FABRIC GRADES			LEATHER	
	1	2	3	4	5	6	7	8	9
 Twin Double-Seat, 30° Curve, Full Height Back ZOP3-MCTD30DF0F	6875	7311	7743	8350	9046	9654	10348	11216	12086
 Twin Double-Seat, 30° Curve, Full Height Back with Privacy Screen Option ZOP3-MCTD30DF2F	7820	8256	8688	9296	9991	10598	11293	12163	13029
 Twin Double-Seat, 30° Curve, Mid Height Back ZOP3-MCTD30DM0F	6496	6886	7279	7822	8447	8993	9619	10399	11179
 Twin Double-Seat, 30° Curve, Mid Height Back with Privacy Screen Option ZOP3-MCTD30DM2F	7441	7833	8222	8768	9393	9938	10564	11344	12122



## Zola Privacy Option Upcharges

	\$ List	\$ List
Moisture Barrier & CAL 133 (per yard)	64	Plus Upgrade - Twin Double-Seat, 30° Curve 404
Seat Power (per power unit)	641	Dual Leg (for Multiple unit configurations) 80
Shelf Power	600	Removable Seat Covers -Twin Double-Seat, 30° Curve 186
Table Power	647	<b>Note:</b> Removable back covers are not available on curved backs

## PRODUCT CODE KEY

Line	Series	Chair Type	Curve Style	Seat Degree	Back Type	Leg Type
ZOP Zola	3 Lounge	MCT Modular Curve Twin	S Small Radius- Single Width	30D	F0 Full Height Back	F Freestanding Unit
		MCTB Modular Curve Twin Plus	D Small Radius- Double Width	45D	F2 Full Height Back with Privacy Screen Option	S Start Unit
				60D	M0 Mid Height Back	C Center Unit
				90D	M2 Mid Height Back with Privacy Screen Options	E End Unit

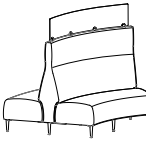
# ZOLA PRIVACY | TWIN CURVED

DESCRIPTION/MODEL/SPECIES	COM		COL	FABRIC GRADES			LEATHER		
	1	2	3	4	5	6	7	8	9
 Twin Double-Seat, 45° Curve, Full Height Back ZOP3-MCTD45DF0F	7754	8198	8645	9269	9983	10606	11320	12211	13105
 Twin Double-Seat, 45° Curve, Full Height Back with Privacy Screen Option ZOP3-MCTD45DF2F	8706	9156	9600	10222	10937	11561	12274	13167	14058
 Twin Double-Seat, 45° Curve, Mid Height Back ZOP3-MCTD45DM0F	7346	7750	8152	8715	9358	9919	10564	11367	12171
 Twin Double-Seat, 45° Curve, Mid Height Back with Privacy Screen Option ZOP3-MCTD45DM2F	8304	8703	9108	9668	10312	10875	11517	12320	13127

## ORDERING NOTES:

The 90° size is not available in a Double-Seat unit, order two 45° degree single units.

## Zola Privacy Option Upcharges



	\$ List	\$ List
Moisture Barrier & CAL 133 (per yard)	64	Plus Upgrade - Twin Double-Seat, 45° Curve 458
Seat Power (per power unit)	641	Dual Leg (for Multiple unit configurations) 80
Shelf Power	600	Removable Seat Covers - Twin Double-Seat, 45° Curve 204
Table Power	647	<b>Note:</b> Removable back covers are not available on curved backs

## PRODUCT CODE KEY

Line	Series	Chair Type	Curve Style	Seat Degree	Back Type	Leg Type
ZOP Zola	3 Lounge	MCT Modular Curve Twin	S Small Radius- Single Width	30D	F0 Full Height Back	F Freestanding Unit
		MCTB Modular Curve Twin Plus	D Small Radius- Double Width	45D	F2 Full Height Back with Privacy Screen Option	S Start Unit
				60D	M0 Mid Height Back	C Center Unit
				90D	M2 Mid Height Back with Privacy Screen Options	E End Unit

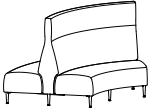
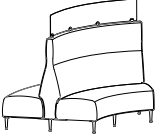
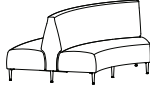

# ZOLA PRIVACY | TWIN CURVED

DESCRIPTION/MODEL/SPECIES	COM		COL	FABRIC GRADES			LEATHER		
	1	2	3	4	5	6	7	8	9
 Twin Double-Seat, 60° Curve, Full Height Back ZOP3-MCTD60DF0F	8458	8912	9363	9996	10721	11353	12079	12983	13887
 Twin Double-Seat, 60° Curve, Full Height Back with Privacy Screen Option ZOP3-MCTD60DF2F	9418	9873	10324	10958	11680	12315	13038	13944	14848
 Twin Double-Seat, 60° Curve, Mid Height Back ZOP3-MCTD60DM0F	7994	8404	8811	9383	10039	10609	11264	12083	12897
 Twin Double-Seat, 60° Curve, Mid Height Back with Privacy Screen Option ZOP3-MCTD60DM2F	8955	9363	9772	10344	10995	11568	12225	13042	13858

## Zola Privacy Option Upcharges

	\$ List		\$ List
Moisture Barrier & CAL 133 (per yard)	64	Plus Upgrade - Twin Double-Seat, 60° Curve	543
Seat Power (per power unit)	641	Dual Leg (for Multiple unit configurations)	80
Shelf Power	600	Removable Seat Covers -Twin Double-Seat, 60° Curve	248
Table Power	647	<b>Note:</b> Removable back covers are not available on curved backs	

## PRODUCT CODE KEY

Line	Series	Chair Type	Curve Style	Seat Degree	Back Type	Leg Type
ZOP Zola	3 Lounge	MCT Modular Curve Twin	S Small Radius- Single Width	30D	F0 Full Height Back	F Freestanding Unit
		MCTB Modular Curve Twin Plus	D Small Radius- Double Width	45D	F2 Full Height Back with Privacy Screen Option	S Start Unit
				60D	M0 Mid Height Back	C Center Unit
				90D	M2 Mid Height Back with Privacy Screen Options	E End Unit

# ZOLA PRIVACY | TWIN SIDE PANELS

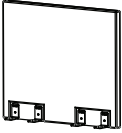
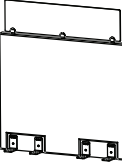
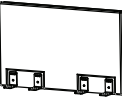
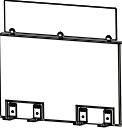
DESCRIPTION/MODEL	COM		COL		FABRIC GRADES			LEATHER		
	1	2	3	4	5	6	7	8	9	
 Twin Side Panel, Full Height No Screen ZOP3-MPTF0U Universal End ZOP3-MPTF0C Center	1428	1559	1691	1955	2218	2483	2745	3010	3536	
	2139	2272	2405	2668	2932	3193	3457	3720	4248	
	<hr/>									
 Twin Side Panel, Full Height with Screen ZOP3-MPTF2U Universal End ZOP3-MPTF2C Center	2006	2138	2271	2533	2798	3061	3324	3589	4114	
	2718	2851	2984	3246	3510	3772	4037	4297	4828	
	<hr/>									
 Twin Side Panel, Med. Height No Screen - ZOP3-MPTM0U Universal End ZOP3-MPTM0C Center	1187	1275	1363	1543	1720	1898	2077	2254	2610	
	1897	1988	2077	2254	2432	2610	2788	2965	3322	
	<hr/>									
 Twin Side Panel, Med. Height with Screen ZOP3-MPTM2U Universal End ZOP3-MPTM2C Center	1767	1855	1944	2122	2301	2479	2657	2833	3188	
	2478	2567	2657	2833	3011	3188	3367	3543	3902	
	<p><b>ORDERING NOTE:</b> Side Panels will only connect to Center seating units. Units with Privacy Screen Option are not available with Removable Back Cover option. See page 207 for dimensions &amp; C.O.M.</p>									

## PRODUCT CODE KEY

Line	Series	Chair Type	Height	Position
ZOP	3	MPT	F0	U
Zola	Lounge	Modular Side Panel Twin	Full Height	Universal (S or E)
			F2	C
			Full Height with Privacy Screen Option	Center /Interim
			M0	
			Mid Height	
			M2	
			Mid Height with Privacy Screen Option	

# ZOLA PRIVACY | TWIN SEMI-PRIVATE SIDE PANELS & MODULAR ARMS

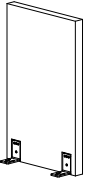
DESCRIPTION/MODEL	COM		COL	FABRIC GRADES			LEATHER				
	1	2	3	4	5	6	7	8	9		
	Twin Semi-Private Side Panel, Single, Full Height										
	ZOP3-MSPTF0U	Universal	1012	1092	1172	1286	1415	1528	1659	1819	1981
	ZOP3-MSPTF0C	Center	1724	1804	1885	1999	2129	2240	2370	2532	2694

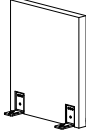
DESCRIPTION/MODEL	COM		COL	FABRIC GRADES			LEATHER				
	1	2	3	4	5	6	7	8	9		
	Twin Semi-Private Side Panel, Single, Mid Height										
	ZOP3-MSPTM0U	Universal	868	919	973	1045	1131	1203	1288	1393	1497
	ZOP3-MSPTM0C	Center	1581	1633	1686	1758	1842	1915	2001	2106	2211

**ORDERING NOTE:** Semi-Private Side Panels will only connect to Center seating units. See page 207 for dimensions and COM.

## PRODUCT CODE KEY

Line	Series	Type	Height	Position
ZOP	3	MSPT	F0	U
Zola	Lounge	Modular Arm Twin	Full Height	Universal (S or E)
			M0	C
			Mid Height	Center /Interim

# ZOLA PRIVACY | TWIN MODULAR ARMS

DESCRIPTION/MODEL	COM		COL	FABRIC GRADES			LEATHER				
	1	2	3	4	5	6	7	8	9		
	Twin Modular Upholstered Arm										
	ZOP3-MATUPHU		1120	1197	1262	1349	1451	1539	1641	1768	1894
	ZOP3-MATUPHC		1846	1909	1974	2062	2164	2253	2354	2481	2608

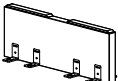
DESCRIPTION/MODEL	COM		COL	FABRIC GRADES			LEATHER				
	1	2	3	4	5	6	7	8	9		
	Twin Modular Upholstered Arm w/Urethane Cap										
	ZOP3-MATUREU		1252	1329	1393	1481	1582	1670	1772	1899	2026
	ZOP3-MATUREC		1979	2041	2106	2193	2295	2384	2485	2612	2739



**ORDERING NOTE:** To specify Solid Surface Arm Caps on Modular Upholstered Arms, please add upcharge below and change UPH in the model number to SSC.

Zola Option Upcharges	Grades			
	A-White	A-Color	B	C
Solid Surface Arm Cap (per arm)	276	288	318	328

## PRODUCT CODE KEY

Line	Series	Type	Arm	Position
ZOP	3	MAT	UPH	U
Zola	Lounge	Modular Arm Twin	Upholstered	Universal (S or E)
			URE	C
			Upholstered Arm w/Urethane Cap	Center /Interim
			SSC	
			Upholstered Arm w/Solid Surface Cap	

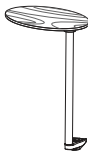
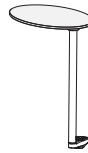
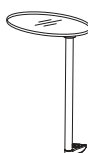
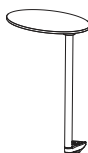
# ZOLA PRIVACY | TABLETS

DESCRIPTION	MODEL	SPECIES	PRICE	WEIGHT	CUBE
	Wood Tablet ZOL3 T1	Beech	514	12	2
		Maple /Cherry	538		
	Tablet with Palette Finish ZOL3 T2	n/a	411	12	2
	Clear Glass Tablet ZOL3 T3	n/a	783	13	2
	Laminate Tablet ZOL3 T4	n/a	532	12	2
	<b>ORDERING NOTES:</b> The laminate tablet comes standard with a polymer edge. Please note Zola Tablets are universally handed and do not need to be specified right or left when ordering.				
	Solid Surface Tablet - Grade A White ZOL3 T5AW	n/a	641	14	2
	Solid Surface Tablet - Grade A Color ZOL3 T5AC	n/a	651	14	2
	Solid Surface Tablet - Grade B ZOL3 T5B	n/a	686	14	2
	Solid Surface Tablet - Grade C ZOL3 T5C	n/a	741	14	2

# ZOLA PRIVACY | INLINE WALLS | FEATURES & OPTIONS



## RECONFIGURABILITY

Inline Walls can be reconfigured within Zola Privacy seating configurations. Inline walls are comprised of 3 module types, a left and a right corner unit plus a center unit and are available in two depths - Inline Wall at 12 inches and Inline Table Wall at 28 inches. Inline Wall corner units and Inline Table Walls must connect to Start, Center or End seating unit.

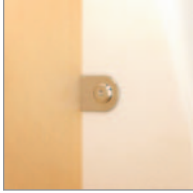

## BACK CONNECTION

Inline Corner Walls and Inline Tables connect to Zola Privacy seating using steel brackets. Seating must be specified as start, center or ends.



## LEGS

The legs offered on Zola Lounge are Silver Metallic or Matte Black and come standard with glides that are adjustable up to 1.25", which provide leveling capability over longer spans. Caster leg is not available.



## MEDIA & POWER

Inline walls can be optioned with Media provisions and Powerdocs.



## RUNOFF TABLES

Run-off tables are used in combination with Inline Walls and provide a fixed occasional height table between two seating units. They feature a single tapered metal leg with adjustable glide.



## LAMINATE OR WOOD OPTIONS

Inline walls are offered in wood and laminate surfaces. They create a straight wall partition between two opposing seating units. Walls are available in Mid and Full Height back styles and are 12" in depth at the base.



## SOLID SURFACE OVERLAY

The Solid Surface top option is priced as an upcharge to existing table price. Zola Solid Surface tables have a 1/2" thickness on top of the existing table, with a 1 mm overhang (soft radius vertical edge). Please see page 336 for color options.

# ZOLA PRIVACY | INLINE WALLS | SAMPLE CONFIGURATIONS

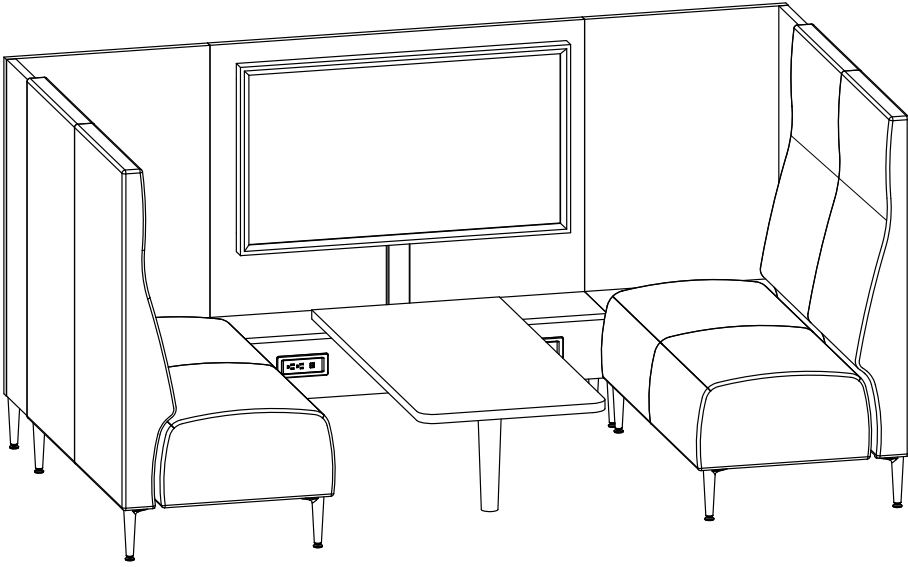

Model	Qty	Price (\$)
ZOP3-M2F0F	2	3029
ZOP3-IWF048MP	1	2404
ZOP3-ICWF0L	1	1697
ZOP3-ICWF0R	1	1697
ZOP3-RO48532416	1	1066
<b>Total</b>		<b>\$12,922</b>

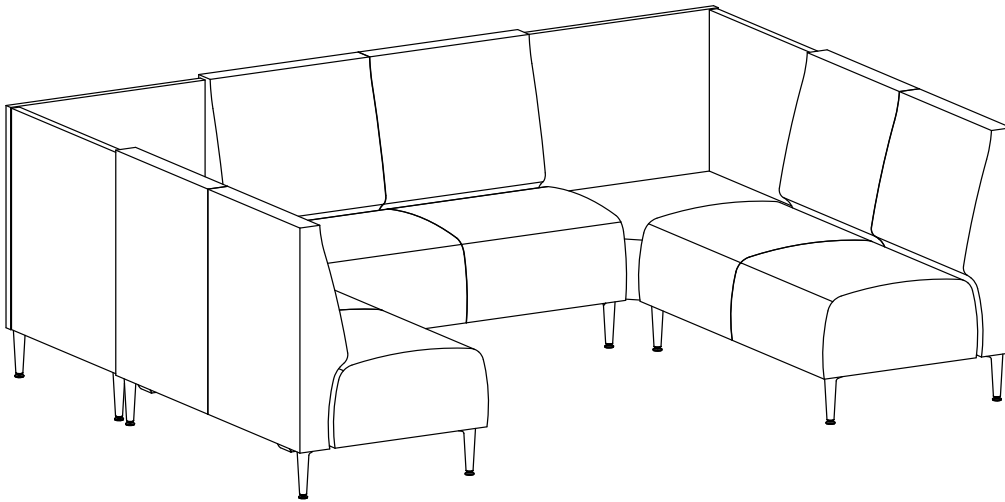

Model	Qty	Price (\$)
ZOP3-M2M0F	3	2595
ZOP3-ICTWM0L	1	1715
ZOP3-ICTWM0R	1	1715
<b>Total</b>		<b>\$11,215</b>

# ZOLA PRIVACY | INLINE WALLS

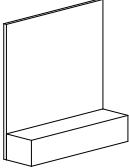
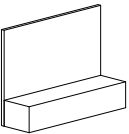
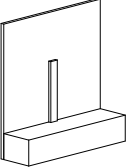
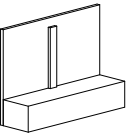
DESCRIPTION/MODEL	THERMOFUSED LAMINATE	HIGH PRESSURE LAMINATE	CHERRY MAPLE BEECH	W	D	H	WEIGHT CUBE		
	Inline Wall, Full Height 42" ZOP3-IWF042N	1172	1985	1673	42	12	50	107	19
	Inline Wall, Full Height 48" ZOP3-IWF048N	1262	2167	1774	48	12	50	121	21.5
	Inline Wall, Full Height 54" ZOP3-IWF054N	1349	2255	1875	54	12	50	135	24
	Inline Wall, Full Height 60" ZOP3-IWF060N	1437	2343	1974	60	12	50	147	26.5
	Inline Wall, Mid Height 42" ZOP3-IWM042N	1095	1683	1588	42	12	37	92	13.5
	Inline Wall, Mid Height 48" ZOP3-IWM048N	1184	1863	1688	48	12	37	102	15.25
	Inline Wall, Mid Height 54" ZOP3-IWM054N	1271	1953	1789	54	12	37	116	17
	Inline Wall, Mid Height 60" ZOP3-IWM060N	1359	2040	1886	60	12	37	126	18.75
	Inline Wall Media, Full Height 42" ZOP3-IWF042M	1318	2131	1820	42	12	50	107	19
	Inline Wall Media, Full Height 48" ZOP3-IWF048M	1407	2313	1921	48	12	50	121	21.5
	Inline Wall Media, Full Height 54" ZOP3-IWF054M	1494	2401	2019	54	12	50	135	24
	Inline Wall Media, Full Height 60" ZOP3-IWF060M	1583	2488	2119	60	12	50	147	26.5
	Inline Wall Media, Mid Height 42" ZOP3-IWM042M	1242	1827	1734	42	12	37	92	13.5
	Inline Wall Media, Mid Height 48" ZOP3-IWM048M	1330	2010	1834	48	12	37	102	15.25
	Inline Wall Media, Mid Height 54" ZOP3-IWM054M	1417	2096	1934	54	12	37	116	17
	Inline Wall Media, Mid Height 60" ZOP3-IWM060M	1506	2186	2033	60	12	37	126	18.75

**ORDERING NOTE:** Inline Walls only connect to Inline Corner Walls.

## PRODUCT CODE KEY

Line	Series	Chair Type	Height	Size	Power/Media
ZOP	3	IW	F0	42	N
Zola	Lounge	Inline Wall	Full Height	42"	None
			M0	48	P
			Mid Height	48"	PowerDoc
				54	M
				54"	Media
				60	MP
				60"	PowerDoc & Media

# ZOLA PRIVACY | INLINE WALLS WITH POWER

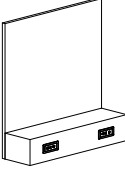
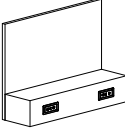
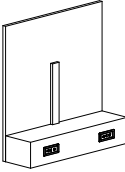
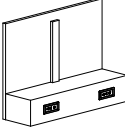
DESCRIPTION/MODEL	THERMOFUSED LAMINATE	HIGH PRESSURE LAMINATE	CHERRY MAPLE BEECH	W	D	H	WEIGHT CUBE		
	Inline Wall w/Power Docs, Full Height 42" ZOP3-IWF042P	2169	2982	2671	42	12	50	150	19
	Inline Wall w/Power Docs, Full Height 48" ZOP3-IWF048P	2257	3163	2770	48	12	50	212	21.5
	Inline Wall w/Power Docs, Full Height 54" ZOP3-IWF054P	2345	3251	2870	54	12	50	135	24
	Inline Wall w/Power Docs, Full Height 60" ZOP3-IWF060P	2433	3340	2970	60	12	50	147	26.5
	Inline Wall w/Power Docs, Mid Height 42" ZOP3-IWM042P	2091	2678	2585	42	12	37	92	13.5
	Inline Wall w/Power Docs, Mid Height 48" ZOP3-IWM048P	2180	2860	2684	48	12	37	102	15.5
	Inline Wall w/Power Docs, Mid Height 54" ZOP3-IWM054P	2268	2948	2785	54	12	37	116	17
	Inline Wall w/Power Docs, Mid Height 60" ZOP3-IWM060P	2356	3036	2883	60	12	37	126	18.75
	Inline Wall Media w/Power Docs, Full Height 42" ZOP3-IWF042MP	2316	3127	2817	42	12	50	150	19
	Inline Wall Media w/Power Docs, Full Height 48" ZOP3-IWF048MP	2404	3310	2917	48	12	50	212	21.5
	Inline Wall Media w/Power Docs, Full Height 54" ZOP3-IWF054MP	2491	3397	3015	54	12	50	135	24
	Inline Wall Media w/Power Docs, Full Height 60" ZOP3-IWF060MP	2580	3486	3116	60	12	50	147	26.5
	Inline Wall Media w/Power Docs, Mid Height 42" ZOP3-IWM042MP	2238	2823	2730	42	12	37	92	13.5
	Inline Wall Media w/Power Docs, Mid Height 48" ZOP3-IWM048MP	2326	3007	2830	48	12	37	102	15.5
	Inline Wall Media w/Power Docs, Mid Height 54" ZOP3-IWM054MP	2413	3093	2929	54	12	37	116	17
	Inline Wall Media w/Power Docs, Mid Height 60" ZOP3-IWM060MP	2503	3182	3030	60	12	37	126	18.75

**ORDERING NOTE:** Inline Walls only connect to Inline Corner Walls.

## PRODUCT CODE KEY

Line	Series	Chair Type	Height	Size	Power/Media
ZOP	3	IW	F0	42	N
Zola	Lounge	Inline Wall	Full Height	42"	None
			M0	48	P
			Mid Height	48"	PowerDoc
				54	M
				54"	Media
				60	MP
				60"	PowerDoc & Media

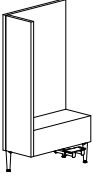

# ZOLA PRIVACY | INLINE CORNER WALLS

DESCRIPTION/MODEL	THERMOFUSED LAMINATE	HIGH PRESSURE LAMINATE	CHERRY MAPLE BEECH	W	D	H	WEIGHT	CUBE
 Inline Corner Wall, Full Height ZOP3-ICWF0L ZOP3-ICWF0R	1697	2388	2045	26.5	12	50	85	14.75
	1697	2388	2045	26.5	12	50	85	14.75

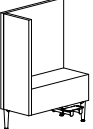
 Inline Corner Wall, Mid Height ZOP3-ICWM0L ZOP3-ICWM0R	1638	2278	1976	26.5	12	37	70	11
	1638	2278	1976	26.5	12	37	70	11

## ZOLA INLINE WALLS SOLID SURFACE OVERLAY UPCHARGES

Option	Grades			
	A-White	A-Color	B	C
ZOP3-IWF042N	427	446	556	662
ZOP3-IWF048N	478	500	622	745
ZOP3-IWF054N	530	555	693	829
ZOP3-IWF060N	555	607	761	913

### ORDERING NOTES:

The Solid Surface top option is priced as an upcharge to existing table price. Please add a "S" to the end of the model number and the upcharge listed below. Zola Solid Surface tables have a 1/2" thickness on top of the existing table, with a 1 mm overhang (soft radius vertical edge). Please see page 336 for color options.

**ORDERING NOTE:** Inline Walls only connect to Inline Corner Walls.

### PRODUCT CODE KEY

Line	Series	Chair Type	Height	Position
ZOP	3	ICW	F0	L
Zola	Lounge	Inline Corner Wall	Full Height	Left
			M0	R
			Mid Height	Right

# ZOLA PRIVACY | INLINE TABLE WALLS

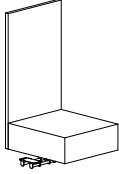
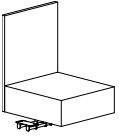
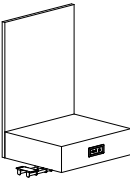
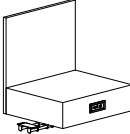
DESCRIPTION/MODEL	THERMOFUSED LAMINATE	HIGH PRESSURE LAMINATE	CHERRY MAPLE BEECH	W	D	H	WEIGHT	CUBE
	Inline Table Wall, Full Height 23" ZOP3-ITWF023N	987	1582	1494	23	25.7	50	100 21
	Inline Table Wall, Full Height 30" ZOP3-ITWF030N	1163	1946	1684	30	25.7	50	125 26.5
	Inline Table Wall, Mid Height 23" ZOP3-ITWM023N	910	1279	1408	23	25.7	37	90 15
	Inline Table Wall, Mid Height 30" ZOP3-ITWM030N	1086	1643	1596	30	25.7	37	115 18.5
	Inline Table Wall w/Power Docs, Full Height 23" ZOP3-ITWF023P	1984	2579	2491	23	25.7	50	100 21
	Inline Table Wall w/Power Docs, Full Height 30" ZOP3-ITWF030P	2160	2943	2680	30	25.7	50	125 26.5
	Inline Table Wall w/Power Docs, Mid Height 23" ZOP3-ITWM023P	1906	2274	2405	23	25.7	37	90 15
	Inline Table Wall w/Power Docs, Mid Height 30" ZOP3-ITWM030P	2083	2639	2592	30	25.7	37	115 18.5

**ORDERING NOTE:** For reverse grain direction on table surfaces use list price and note Reverse Grain on p.o.

## PRODUCT CODE KEY

Line	Series	Chair Type	Height	Size	Power/Media
ZOP	3	ITW	F0	23	N
Zola	Lounge	Inline Table Wall	Full Height	23"	None
			M0	30	P
			Mid Height	30"	Power

# ZOLA PRIVACY | INLINE CORNER TABLE WALLS & INLINE RUN-OFF TABLES

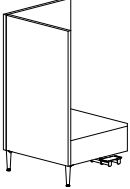
DESCRIPTION/MODEL	THERMOFUSED LAMINATE	HIGH PRESSURE LAMINATE	CHERRY MAPLE BEECH	W	D	H	WEIGHT	CUBE
	Inline Corner Table Wall, Full Height							
	ZOP3-ICTWF0L	1776	2678	2178	28	28	50	140 31
	ZOP3-ICTWF0R	1776	2678	2178	28	28	50	140 31

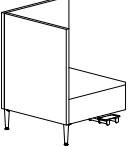
	Inline Corner Table Wall, Mid Height							
	ZOP3-ICTWM0L	1715	2566	2108	28	28	37	127 23
	ZOP3-ICTWM0R	1715	2566	2108	28	28	37	127 23

## ZOLA INLINE TABLE WALLS SOLID SURFACE OVERLAY UPCHARGES

Option	Grades			
	A-White	A-Color	B	C
ZOP3-ITWF023N	483	508	632	756
ZOP3-ITWF030N	605	635	796	957
ZOP3-ITWM023N	483	508	632	756
ZOP3-ITWM030N	605	635	796	957
ZOP3-ITWF023P	483	508	632	756
ZOP3-ITWF030P	605	635	796	957
ZOP3-ITWM023P	483	508	632	756
ZOP3-ITWM030P	605	635	796	957
ZOP3-ICTWF0	607	637	801	961
ZOP3-ICTWM0	607	637	801	961

### ORDERING NOTES:

The Solid Surface top option is priced as an upcharge to existing table price. Please add a "S" to the end of the model number and the upcharge listed below. Zola Solid Surface tables have a 1/2" thickness on top of the existing table, with a 1 mm overhang (soft radius vertical edge). Please see page 336 for color options.





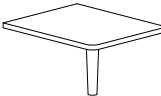

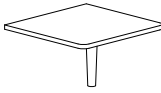



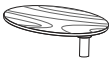
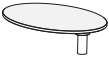

### PRODUCT CODE KEY

Line	Series	Chair Type	Height	Position
ZOP	3	ICTW	F0	L
Zola	Lounge	Inline Corner Table Wall	Full Height	Left
			M0	R
			Mid Height	Right



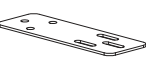
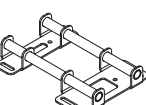

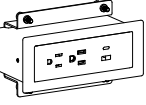
DESCRIPTION/MODEL	THERMOFUSED LAMINATE	HIGH PRESSURE LAMINATE	CHERRY MAPLE BEECH	W	D	H	WEIGHT	CUBE
	Run-off Table for 48" Inline Wall							
	ZOL4-RO48-302416	904	1279	1389	30	24	16	25 3.75
	ZOL4-RO48-372416	954	1380	1455	37	24	16	30 4.5
	ZOL4-RO48-532416	1066	1615	1603	53	24	16	40.5 5.75
	ZOL4-RO48-762416	1231	1953	1818	76	24	16	56 7.5

	Run-off Table for 54" Inline Wall							
	ZOL4-RO54-303016	957	1252	1459	30	30	16	35 4.25
	ZOL4-RO54-373016	1018	1379	1540	37	30	16	41 5.25
	ZOL4-RO54-533016	1163	1671	1728	53	30	16	54 6.75
	ZOL4-RO54-763016	1370	2092	1995	76	30	16	74 8.75

# ZOLA | COLLECTION COMPONENTS

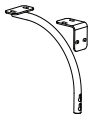
DESCRIPTION/MODEL	PRICE	WEIGHT	CUBE
 Wood Tablet & Mounting Plate Only ZOL3 RT1	Beech 381	5	0.32
	Maple /Cherry 405	5	0.32
 Painted Tablet & Mounting Plate Only ZOL3 RT2	n/a 278	5	0.32
 Clear Glass Tablet & Mounting Plate Only ZOL3 RT3	n/a 651	6	0.32
 Laminate Tablet & Mounting Plate Only ZOL3 RT4	n/a 397	5	0.32
 Solid Surface Tablet & Mounting Plate Only ZOL3 RT5	Grade - A-White 539		
	Grade - A-Color 547		
	Grade - B 577		
	Grade - C 624		
<b>ORDERING NOTES:</b> The Zola replacement tablets on this page include the top with mounting plate only.			
 Leg ZOL3 RLS	58	1	0.125
 Caster Leg ZOL3 RLC	39	0.4	0.125
 Dual leg ZOL3 RDL	100	1	0.125
 Leg Glide (4) ZOL3 RLG	24	0.2	0.01
 Replacement Seat-to-Seat Bracket ZOL3 RLKB2	95	1	0.125
<b>NOTE:</b> Zola Modular Seats are ordered, each seat is automatically supplied with two seat to seat brackets			
 Replacement Table-to-Seat Bracket ZOL3 RLKB1	114	3	0.125
 ZOL3-POWERDOC1 - Undermount	573	3	0.375
Can be field installed to the underside of Seats and Tables as a replacement part or installed on units not previously specified with a Powerdoc. Standard with 2 Power and USB A & C outlets. PowerDoc's have a 10' cord.			
 ZOL3-POWERDOC2	647	3	0.375
Replacement unit only for Seats, Benches or Square/Rectangular tables which were originally ordered with this power option. Standard with 2 Power and USB A & C outlets. PowerDoc's have a 10' cord.			
 Wire Manager Shroud ZOL3 WM10	120	1	0.375
<b>ORDERING NOTES:</b> Comes in a 10' length when ordered. Can be cut to size on site.			

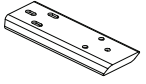
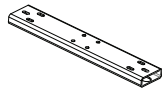
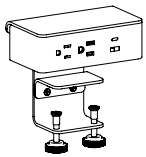
## ZOLA PRIVACY | COMPONENTS

DESCRIPTION/MODEL	PRICE	WEIGHT	CUBE
 Replacement Shelf Support Bracket Kit ( includes 90deg bracket, curved bracket, fasteners) ZOP3-RSSB	67	2	0.32
 Back Alignment Hardware Kit (includes male & female bracket, fasteners) ZOP3-LKBC	58	2	0.32
 Privacy Screen Hardware (includes bracket, fasteners) ZOP3-RSH	74	2	0.32
 Back-to-Seat Linking hardware ZOP3-RLKS	169	3	0.32
 Twin Back-to-Seat Linking Hardware ZOP3-RLKT	187	4	0.32
 ZOP3-POWERDOC3 - Shelves only Replacement unit only for Shelves which were originally ordered with this power option. Standard with 2 Power and USB A & C outlets.	610	3	0.375
 Wire Manager for Inline Media Wall ZOL3 WM	187	1	0.375

# FAERON LOUNGE | ENVIRONMENTAL SUMMARY

## LEED CI CREDITS

HEALTHCARE DISCOUNT APPLIES TO THESE PRODUCTS



MATERIAL CONTENT:

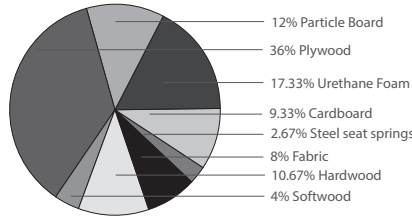

PRE-CONSUMER  
RECYCLED CONTENT = 12.67%

POST-CONSUMER  
RECYCLED CONTENT = 9.40%

Up to 18.93% of this Faeron product is recyclable at the end of its useful life.

	CONTRIBUTES TO	
CREDIT 2.1 - 2.2	Construction Waste Management	1-2 point(s)
CREDIT 3.3	Resource Reuse	1 point
CREDIT 4.1	Recycled Content	1 point
CREDIT 4.5	Low Emitting Materials, Systems & Seating	1 point
CREDIT 5.1	Regional Materials*	1 point
CREDIT 7	Certified Wood (MUST BE REQUESTED)	1 point(s)

\*This credit is only applicable if in total 20% of the combined value of the procurement of construction materials and in the furniture are manufactured within a radius of 500 miles. This credit will apply if the installation of the finished product occurs within 500 miles of Kitchener, Ontario.

## level® CERTIFICATION, AIR EMISSIONS AND FSC® CERTIFICATION



### level® CERTIFICATION

BIFMA's e3 Furniture Sustainability Standard is a voluntary, multi-attribute standard that measures the degree of sustainability of furniture. This standard evaluates product and company environmental attributes and compliance systems in a wide range of elements which include Materials, Energy & Atmosphere, Human & Ecosystem Health and Social Responsibility. Faeron products have earned level®, BIFMA's sustainability certification program for furniture, certification through third-party verification against the e3 standard.

### AIR-EMISSIONS

All Faeron products are supplied with air-emissions certified. Contact customer service for information.



### FSC®

In 2005, Krug received Forest Stewardship Council® (FSC®) Chain-of-Custody certification for our manufacturing facilities. The FSC® Chain-of-Custody tracks certified wood from seedling to final sale. It verifies that the material for our FSC® certified products only come from well-managed, FSC®-certified forests and other controlled sources. FSC® is dedicated to the promotion of responsible forest management worldwide helping to take care of forests for future generations. Faeron and other Krug products can be specified with FSC® Certification. Contact customer service for further information, pricing and lead times.



Architects, designers, and building professionals can specify FSC®-certified products in order to achieve a point from the U.S. Green Building Council's Leadership in Energy and Environmental Design (LEED) Rating System.

# FAERON LOUNGE | DIMENSIONS & COM

## DIMENSIONS & COM REQUIREMENTS

	Overall Width	Overall Depth	Overall Height	Seat Height	Height of Arms from Floor	Width Between Arms	Seat Depth	Shipping Weight	Cube	COM Yardage Entire Unit	COM Yardage Seat Only	COM Yardage Back Only	COM Yardage Arm Only
<b>One-Seat - wood arm</b>													
lounge	27	28.5	31.5	17.8	24	23	21	55	20	4.2	1.3	1.7	1.2
high back	27	28.5	41.5	17.8	24	23	21	59	24	4.8	1.3	2.3	1.2
<b>One-Seat - armless</b>													
lounge	23	28.5	31.5	17.8	-	-	21	52	20	3	1.3	1.7	-
high back	23	28.5	41.5	17.8	-	-	21	55	24	3.6	1.3	2.3	-
<b>One-Seat - upholstered arm</b>													
lounge	28	28.5	31.5	17.8	24	23	21	75	20	5.9	1.3	1.7	2.9
high back	28	28.5	41.5	17.8	24	23	21	79	24	6.5	1.3	2.3	2.9
wingback	32	28.5	42.5	17.8	24	23	21	84	27	7.5	1.3	3.3	2.9
<b>One-Seat wide - wood arm</b>													
lounge	34	28.5	31.5	17.8	24	30	21	64	23	4.4	1.5	1.7	1.2
high back	34	28.5	41.5	17.8	24	30	21	68	27	5	1.5	2.3	1.2
<b>One-Seat wide - armless</b>													
lounge	30	28.5	31.5	17.8	-	-	21	61	23	3.2	1.5	1.7	-
high back	30	28.5	41.5	17.8	-	-	21	65	27	3.8	1.5	2.3	-
<b>One-Seat wide - upholstered arm</b>													
lounge	35	28.5	31.5	17.8	24	30	21	84	23	6.1	1.5	1.7	2.9
high back	35	28.5	41.5	17.8	24	30	21	88	27	6.7	1.5	2.3	2.9
wingback	39	28.5	42.5	17.8	24	30	21	93	30	7.5	1.3	3.3	2.9
<b>Two-seat - wood arm</b>													
lounge	50	28.5	31.5	17.8	24	46	21	88	36	5.5	1.7	2.6	1.2
high back	50	28.5	41.5	17.8	24	46	21	95	43	6.4	1.7	3.5	1.2
<b>Two-seat - armless</b>													
lounge	46	28.5	31.5	17.8	-	-	21	87	36	4.3	1.7	2.6	-
high back	46	28.5	41.5	17.8	-	-	21	94	43	5.2	1.7	3.5	-
<b>Two-seat - upholstered arm</b>													
lounge	51	28.5	31.5	17.8	24	46	21	108	36	7.2	1.7	2.6	2.9
high back	51	28.5	41.5	17.8	24	46	21	115	43	8.1	1.7	3.5	2.9
wingback	55	28.5	42.5	17.8	24	46	21	120	46	9.1	1.7	4.5	2.9
<b>Three-seat - wood arm</b>													
lounge	73	28.5	31.5	17.8	24	69	21	120	52	7.1	2.5	3.4	1.2
high back	73	28.5	41.5	17.8	24	69	21	130	61	8.4	2.5	4.7	1.2
<b>Three-seat - armless</b>													
lounge	69	28.5	31.5	17.8	-	-	21	122	52	5.9	2.5	3.4	-
high back	69	28.5	41.5	17.8	-	-	21	132	61	7.2	2.5	4.7	-
<b>Three-seat - upholstered arm</b>													
lounge	74	28.5	31.5	17.8	24	69	21	140	52	8.8	2.5	3.4	2.9
high back	74	28.5	41.5	17.8	24	69	21	150	61	10.1	2.5	4.7	2.9
wingback	78	28.5	42.5	17.8	24	69	21	155	64	10.3	1.7	5.7	2.9

### ORDERING NOTES:

#### CONTRASTING BACKS, SEATS & CLOSED ARMS

**Combination upholstery** (more than one upholstery cover within the same unit) is an option on all Faeron upholstered products. When combination upholstery is with upholstery of the same grade or COM, an upcharge for dual fabrics is **\$33 list** per unit and **\$64 list** per unit for three fabrics. When graded in combination upholstery is selected, use the highest grade upholstery selected or contact Customer Service for a quote -please provide the fabrics specified and a description of where each fabric is to be applied on the product in order to obtain a quote. Note: Some vinyls, leathers & upholsteries are not suitable for application on Faeron seating. Please refer to page 333 for C.O.M approval process.

#### WEIGHT CAPACITIES

Faeron weight capacities are as follows:

- One -Seat - 500 lbs
- One -Seat - Plus - 750 lbs
- One-Seat Wide - 500 lbs
- One-Seat Wide Plus - 750 lbs
- Two- Seat - 625 lbs
- Two- Seat Plus- 975 lbs
- Three - Seat - 850 lbs
- Three - Seat Plus- 1200 lbs

#### Faeron Option Upcharges

	\$ List		\$ List
CAL 133 & Moisture Barrier (per yard)	64	Solid Surface Arm Cap (per pair) - Gr A White	384
One-Seat Removable Back Covers	152	Solid Surface Arm Cap (per pair) - Gr A Color	397
One-Seat Wide Removable Back Covers	228	Solid Surface Arm Cap (per pair) - Gr B	422
Two-Seat Removable Back Covers	302	Solid Surface Arm Cap (per pair) - Gr C	435
Three-Seat Removable Back Covers	453	Solid Surface Arm (per pair) - Gr A White	677
One-Seat Removable Seat Covers	152	Solid Surface Arm (per pair) - Gr A Color	708
One-Seat Wide Removable Seat Covers	228	Solid Surface Arm (per pair) - Gr B	768
Two-Seat Removable Seat Covers	302	Solid Surface Arm (per pair) - Gr C	810
Three-Seat Removable Seat Covers	453	Urethane Arm Cap (per pair)	152
		Upholstered Lounge Wood Arm Cap (per pair)	193

HEALTHCARE DISCOUNT APPLIES TO THESE PRODUCTS

## FAERON WOOD | LOUNGE FEATURES &amp; OPTIONS

**WOOD ARM**

Faeron Wood Arm Lounge chairs are available with optional Arm Caps in Urethane and Solid Surface. As well as a Solid Surface Arm.

**ARMLESS**

Faeron Armless Lounge seating can be specified with a full wood base providing an enhanced base profile.

**UPHOLSTERED ARM**

Faeron Upholstered arm lounge chairs are available with optional arm caps in Wood, Solid Surface and Urethane (Wingback lounge is not available with Urethane cap).

**ARM PANEL**

Arm Panels are available on Faeron Wood Arm Lounge seating in semi and fully closed styles for optimum design flexibility.

**BEECH WOOD LEGS**

Faeron Lounge legs and bases are solid Beech available in 22 finish selections.

**METAL LEGS**

Faeron Upholstered Arm models are also available with Metal Legs; Silver Metallic or Brushed Nickel finish.

**LOUNGE WALL SAVER**

Faeron Lounge models include a wall saver feature in which the angle of the back and the rear legs are designed to keep the back away from the wall, to prevent wear and damage to both the chair and the wall. Not included for Faeron High Back Lounge or Faeron Wingback Lounge due to back height.

**CLEAN OUT**

All Faeron Lounge seating has a built-in clean out feature: a space at the back of the seat that allows dirt, debris and liquid to fall to the floor for easy clean up and maintenance - designed so that it does not detract from the comfort or appearance of the product.

Faeron Lounge Images | [www.krug.ca](http://www.krug.ca)

**OPTIONS****URETHANE ARM CAP**

The optional Urethane Arm Cap is available on Wood Arm Lounge and Upholstered Arm Lounge and provides enhanced durability and protection for the arms. This is field replaceable if this becomes damaged or degraded and is available in three colors; Black, Grey and Taupe.

**WOOD ARM CAP**

The optional Solid Beech Arm Cap is available on Upholstered Arm and Wingback Lounge. This is field replaceable if this becomes damaged or degraded.

**SOLID SURFACE ARM CAP**

The optional Solid Surface Arm Cap is available on Wood Arm Lounge and Upholstered Arm Lounge and provides enhanced durability, protection and cleanability for the arms. This is field replaceable if this becomes damaged or degraded and is available in 8 standard colors.

**SOLID SURFACE ARM**

The optional Solid Surface Arm is available on Wood Arm Lounge and provides a fully seamless armrest for enhanced durability, protection and cleanability. It is available in 8 standard colors and replaceable as a full side frame if it becomes damaged or degraded.

**COMBINATION UPHOLSTERY**

When combination upholstery (more than one upholstery cover within the same unit) is specified with upholstery of the same grade or COM, an upcharge for dual fabrics is **\$33 list** per unit and **\$64 list** per unit for three fabrics. When graded-in combination upholstery is selected, use the highest grade upholstery selected or contact Customer Service for a quote

**MOISTURE BARRIER & CAL 133**

California Technical Bulletin 133 is a flammability test for seating. Krug offers a compliance method, in combination with non-flammable upholstery covers, that may enable products to meet certification requirements for this test. This process at the same time also provides the products with a Moisture Barrier - a treatment that helps to prevent the passage of liquids and moisture to inside of the upholstered components - thereby conferring sanitary and anti-infection benefits. So when CAL133 is specified, the product also automatically has a Moisture Barrier, and when a Moisture Barrier is specified, the product also features the compliance method and low flammability features of CAL 133. The application of this up-charge and the compliance method does not mean that the specific configuration of product and upholstery cover are tested and officially certified as being CAL133 compliant. If the official certification is required, Krug will provide this (through an independent certified testing laboratory) at a charge of \$917 per item, plus the cost of the product to be tested. Lead time for certification testing is typically 4-8 weeks. Moisture Barrier & CAL 133 is available for an upcharge of **\$64 list** per yard.









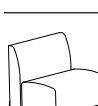

**REMOVABLE AND REPLACEABLE COVERS**

Faeron Lounge Chairs are available with a Removable Seat & Back Covers.

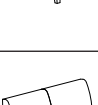
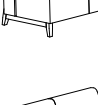

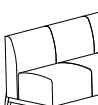
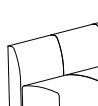
# FAERON WOOD | ARMLESS LOUNGE

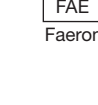
HEALTHCARE DISCOUNT APPLIES TO THESE PRODUCTS







DESCRIPTION/MODEL	Species	COM		COL		FABRIC GRADES			LEATHER		
		1	2	3	4	5	6	7	8	9	
	One-Seat, Armless Lounge, Standard Base										
	FAE3-AL1S Beech	1819	1890	1962	2105	2247	2388	2532	2673	2959	
	One-Seat Plus Armless Lounge, Standard Base										
	FAE3-ALB1S Beech	1886	1959	2030	2172	2315	2459	2601	2743	3029	
	One-Seat, Armless Lounge, Full Wood Base										
	FAE3-AL1F Beech	1982	2055	2124	2268	2410	2553	2695	2838	3122	
	One-Seat Plus, Armless Lounge, Full Wood Base										
	FAE3-ALB1F Beech	2051	2121	2193	2334	2479	2620	2764	2906	3190	
	One-Seat Wide, Armless Lounge, Standard Base										
	FAE3-AL1+S Beech	2056	2154	2250	2444	2638	2831	3027	3220	3607	
	One-Seat Wide Plus, Armless Lounge, Standard Base										
	FAE3-ALB1+S Beech	2131	2227	2324	2517	2713	2906	3099	3293	3682	
	One-Seat Wide, Armless Lounge, Full Wood Base										
	FAE3-AL1+F Beech	2266	2362	2460	2655	2848	3040	3236	3430	3817	
	One-Seat Wide Plus, Armless Lounge, Full Wood Base										
	FAE3-ALB1+F Beech	2340	2436	2533	2726	2921	3115	3308	3503	3891	
	Two-Seat, Armless Lounge, Standard Base										
	FAE3-AL2S Beech	2579	2684	2791	3006	3219	3432	3647	3862	4289	
	Two-Seat Plus, Armless Lounge, Standard Base										
	FAE3-ALB2S Beech	2682	2789	2896	3111	3323	3537	3752	3963	4394	
	Two-Seat, Armless Lounge, Full Wood Base										
	FAE3-AL2F Beech	2873	2980	3087	3299	3514	3728	3941	4156	4584	
	Two-Seat Plus, Armless Lounge, Full Wood Base										
	FAE3-ALB2F Beech	2977	3083	3189	3405	3619	3831	4045	4260	4689	
	Three-Seat, Armless Lounge, Standard Base										
	FAE3-AL3S Beech	3415	3587	3759	4102	4443	4785	5128	5470	6155	
	Three-Seat Plus, Armless Lounge, Standard Base										
	FAE3-ALB3S Beech	3591	3762	3933	4277	4617	4959	5302	5644	6330	
	Three-Seat, Armless Lounge, Full Wood Base										
	FAE3-AL3F Beech	3804	3977	4146	4487	4833	5173	5516	5857	6542	
	Three-Seat Plus, Armless Lounge, Full Wood Base										
	FAE3-ALB3F Beech	3980	4152	4321	4664	5006	5347	5691	6032	6716	

PRODUCT CODE KEY

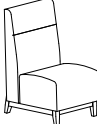
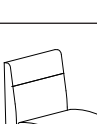
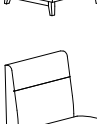
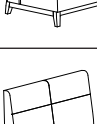
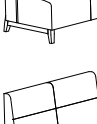
Line	Series	Chair Type	Size	Base
FAE Faeron	3-A Lounge Seating	L Lounge	1 One-Seat	B1 One-Seat Plus
		H High Back Lounge	1+ One-Seat Wide	B1+ One-Seat Wide Plus
			2 Two-Seat	B2 Two-Seat Plus
			3 Three-Seat	B3 Three-Seat Plus
				S Standard Base
				F Full Wood Base

# FAERON WOOD | ARMLESS HIGH BACK LOUNGE

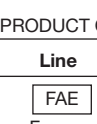

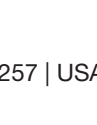



HEALTHCARE DISCOUNT APPLIES TO THESE PRODUCTS

DESCRIPTION/MODEL	Species	COM		COL		FABRIC GRADES			LEATHER	
		1	2	3	4	5	6	7	8	9
 One-Seat, Armless High back Lounge, Standard Base FAE3-AH1S	Beech	2044	2132	2218	2391	2567	2741	2916	3090	3437
 One-Seat Plus, Armless High back Lounge, Standard Base FAE3-AHB1S	Beech	2112	2197	2286	2461	2635	2808	2984	3159	3508
 One-Seat, Armless High back Lounge, Full Wood Base FAE3-AH1F	Beech	2209	2295	2383	2555	2728	2905	3078	3252	3603
 One-Seat Plus, Armless High back Lounge, Full Wood Base FAE3-AHB1F	Beech	2277	2362	2449	2623	2798	2971	3146	3321	3669
 One-Seat Wide, Armless High back Lounge, Standard Base FAE3-AH1+S	Beech	2297	2410	2523	2747	2972	3200	3427	3651	4103
 One-Seat Wide Plus, Armless High back Lounge, Standard Base FAE3-AHB1+S	Beech	2370	2483	2595	2822	3048	3271	3498	3724	4176
 One-Seat Wide, Armless High back Lounge, Full Wood Base FAE3-AH1+F	Beech	2506	2618	2734	2958	3184	3409	3635	3859	4312
 One-Seat Wide Plus, Armless High back Lounge, Full Wood Base FAE3-AHB1+F	Beech	2581	2694	2805	3031	3259	3483	3709	3934	4385
 Two-Seat, Armless High back Lounge, Standard Base FAE3-AH2S	Beech	2744	2869	2991	3237	3483	3728	3974	4217	4710
 Two-Seat Plus, Armless High back Lounge, Standard Base FAE3-AHB2S	Beech	2849	2971	3095	3341	3587	3831	4079	4322	4814
 Two-Seat, Armless High back Lounge, Full Wood Base FAE3-AH2F	Beech	3039	3163	3287	3533	3776	4022	4267	4512	5006
 Two-Seat Plus, Armless High back Lounge, Full Wood Base FAE3-AHB2F	Beech	3144	3267	3389	3635	3881	4128	4372	4617	5109
Three-Seat, Armless High back Lounge, Standard Base FAE3-AH3S	Beech	3648	3851	4055	4460	4866	5272	5677	6082	6894
Three-Seat Plus, Armless High back Lounge, Standard Base FAE3-AHB3S	Beech	3823	4027	4230	4635	5040	5447	5852	6256	7069
Three-Seat, Armless High back Lounge, Full Wood Base FAE3-AH3F	Beech	4038	4239	4443	4846	5255	5660	6064	6470	7283
Three-Seat Plus, Armless High back Lounge, Full Wood Base FAE3-AHB3F	Beech	4212	4416	4617	5023	5428	5834	6241	6646	7457

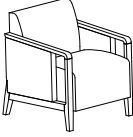
PRODUCT CODE KEY

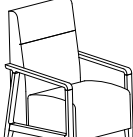
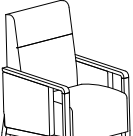
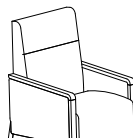
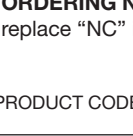
Line	Series	Chair Type	Size		Base
FAE Faeron	3-A Armless Lounge Seating	L Lounge	1 One-Seat	B1 One-Seat Plus	S Standard Base
		H High Back Lounge	1+ One-Seat Wide	B1+ One-Seat Wide Plus	F Full Wood Base
			2 Two-Seat	B2 Two-Seat Plus	
			3 Three-Seat	B3 Three-Seat Plus	

# FAERON WOOD | LOUNGE & HIGH BACK LOUNGE

DESCRIPTION/MODEL	Species	COM		COL		FABRIC GRADES			LEATHER		
		1	2	3	4	5	6	7	8	9	
	One-Seat, Wood Arm Lounge, Open Arm										
	FAE3-WL1ONC Beech	1922	1991	2063	2209	2348	2491	2635	2776	3061	
	One-Seat Plus, Wood Arm Lounge, Open Arm										
	FAE3-WL1BONC Beech	1989	2061	2133	2274	2417	2560	2701	2846	3132	
	One-Seat Wood Arm Lounge, Semi Closed Arm										
	FAE3-WL1SNC Beech	2452	2557	2663	2874	3084	3295	3508	3717	4141	
	One-Seat Plus Wood Arm Lounge, Semi Closed Arm										
	FAE3-WL1BSNC Beech	2520	2628	2732	2943	3156	3366	3577	3787	4208	
	One-Seat Wood Arm Lounge, Closed Arm										
	FAE3-WL1CNC Beech	2472	2579	2683	2894	3105	3316	3529	3739	4160	
	One-Seat Plus Wood Arm Lounge, Closed Arm										
	FAE3-WL1BCNC Beech	2541	2643	2751	2963	3173	3384	3595	3806	4230	
	One-Seat Wood Arm High Back Lounge, Open Arm										
	FAE3-WH1ONC Beech	2146	2234	2321	2495	2669	2844	3016	3190	3539	
	One-Seat Plus Wood Arm High Back Lounge, Open Arm										
	FAE3-WH1BONC Beech	2214	2301	2388	2563	2739	2911	3084	3261	3608	
	One-Seat Wood Arm High Back Lounge, Semi Closed Arm										
	FAE3-WH1SNC Beech	2678	2798	2920	3162	3405	3647	3891	4133	4618	
	One-Seat Plus Wood Arm High Back Lounge, Semi Closed Arm										
	FAE3-WH1BSNC Beech	2744	2867	2988	3232	3473	3715	3959	4203	4686	
	One-Seat Wood Arm High Back Lounge, Closed Arm										
	FAE3-WH1CNC Beech	2696	2818	2940	3184	3427	3668	3910	4154	4638	
	One-Seat Plus Wood Arm High Back Lounge, Closed Arm										
	FAE3-WH1BCNC Beech	2765	2886	3009	3249	3493	3736	3979	4221	4708	

**ORDERING NOTES:** Faeron chairs can be specified with Urethane Arm Caps (UC), Solid Surface Arm Caps (SC) or Solid Surface Arm (SA), replace "NC" in the model number with the **Arm Style** selection below and add the upcharge listed on page 254.

## PRODUCT CODE KEY

Line	Series	Chair Type	Size	Arm Style	Arm Cap
FAE Faeron	3-W Wood Arm Lounge Seating	L Lounge	1 One-Seat	O Open Arm	NC No Cap
		H High Back Lounge	1+ One-Seat Wide	S Semi Closed Arm	UC Urethane Cap
			2 Two-Seat	C Closed Arm	SC Solid Surface Cap
			3 Three-Seat	B3 Three-Seat Plus	SA Solid Surface Arm

# FAERON WOOD | LOUNGE & HIGH BACK LOUNGE

HEALTHCARE DISCOUNT APPLIES TO THESE PRODUCTS

DESCRIPTION/MODEL	Species	COM		COL		FABRIC GRADES			LEATHER		
		1	2	3	4	5	6	7	8	9	
	One-Seat Wide Wood Arm Lounge, Open Wood Arm FAE3-WL1+ONC	Beech	2110	2209	2303	2497	2692	2884	3080	3273	3662
	One-Seat Wide Plus Wood Arm Lounge, Open Arm FAE3-WLB1+ONC	Beech	2185	2280	2378	2570	2765	2959	3156	3346	3736
	One-Seat Wide Wood Arm Lounge, Semi Closed Arm FAE3-WL1+SNC	Beech	2640	2772	2904	3165	3429	3690	3954	4215	4740
	One-Seat Wide Plus Wood Arm Lounge, Semi Closed Arm FAE3-WLB1+SNC	Beech	2715	2847	2978	3239	3501	3765	4027	4289	4814
	One-Seat Wide Wood Arm Lounge, Closed Arm FAE3-WL1+CNC	Beech	2660	2793	2924	3186	3448	3711	3974	4235	4759
	One-Seat Wide Plus Wood Arm Lounge, Closed Arm FAE3-WLB1+CNC	Beech	2736	2866	2996	3261	3521	3785	4047	4310	4835
	One-Seat Wide Wood Arm High Back Lounge, Open Arm FAE3-WH1+ONC	Beech	2352	2463	2577	2803	3028	3252	3479	3706	4156
	One-Seat Wide Plus Wood Arm High Back Lounge, Open Arm FAE3-WHB1+ONC	Beech	2423	2538	2650	2877	3102	3327	3553	3780	4230
	One-Seat Wide Wood Arm High Back Lounge, Semi Closed Arm FAE3-WH1+SNC	Beech	2882	3029	3177	3470	3765	4059	4352	4646	5234
	One-Seat Wide Plus Wood Arm High Back Lounge, Semi Closed Arm FAE3-WHB1+SNC	Beech	2956	3103	3248	3543	3839	4131	4426	4720	5308
	One-Seat Wide Wood Arm High Back Lounge, Closed Arm FAE3-WH1+CNC	Beech	2903	3049	3194	3490	3785	4079	4372	4666	5256
	One-Seat Wide Plus Wood Arm High Back Lounge, Closed Arm FAE3-WHB1+CNC	Beech	2977	3121	3269	3563	3858	4153	4445	4738	5328

**ORDERING NOTES:** Faeron chairs can be specified with Urethane Arm Caps (UC), Solid Surface Arm Caps (SC) or Solid Surface Arm (SA), replace "NC" in the model number with the **Arm Style** selection below and add the upcharge listed on page 254.

PRODUCT CODE KEY

Line	Series	Chair Type	Size	Arm Style	Arm Cap	
FAE Faeron	3-W Wood Arm Lounge Seating	L Lounge	1 One-Seat	B1 One-Seat Plus	O Open Arm	NC No Cap
		H High Back Lounge	1+ One-Seat Wide	B1+ One-Seat Wide Plus	S Semi Closed Arm	UC Urethane Cap
			2 Two-Seat	B2 Two-Seat Plus	C Closed Arm	SC Solid Surface Cap
			3 Three-Seat	B3 Three-Seat Plus		SA Solid Surface Arm

# FAERON WOOD | LOUNGE & HIGH BACK LOUNGE

DESCRIPTION/MODEL	Species	COM		COL	FABRIC GRADES				LEATHER		
		1	2		3	4	5	6	7	8	9
	Two-Seat Wood Arm Lounge, Open Arm										
	FAE3-WL2ONC Beech	2659	2765	2873	3087	3299	3514	3728	3941	4370	
	Two-Seat Plus Wood Arm Lounge, Open Arm										
	FAE3-WLB2ONC Beech	2740	2846	2954	3165	3381	3594	3809	4022	4449	
	Two-Seat Wood Arm Lounge, Semi Closed Arm										
	FAE3-WL2SNC Beech	3189	3330	3472	3756	4037	4318	4602	4885	5448	
	Two-Seat Plus Wood Arm Lounge, Semi Closed Arm										
	FAE3-WLB2SNC Beech	3269	3410	3553	3834	4116	4398	4681	4965	5528	
	Two-Seat Wood Arm Lounge, Closed Arm										
	FAE3-WL2CNC Beech	3209	3352	3491	3773	4058	4339	4620	4903	5469	
	Two-Seat Plus Wood Arm Lounge, Closed Arm										
	FAE3-WLB2CNC Beech	3290	3431	3573	3854	4138	4420	4702	4983	5548	
	Two-Seat Wood Arm High Back Lounge, Open arm										
	FAE3-WH2ONC Beech	2827	2948	3073	3319	3563	3810	4055	4297	4792	
	Two-Seat Plus Wood Arm High back Lounge, Open arm										
	FAE3-WHB2ONC Beech	2906	3029	3153	3398	3643	3890	4133	4379	4870	
	Two-Seat Wood Arm High Back Lounge, Semi Closed Arm										
	FAE3-WH2SNC Beech	3357	3514	3670	3984	4297	4614	4928	5241	5869	
	Two-Seat Plus Wood Arm High Back Lounge, Semi Closed Arm										
	FAE3-WHB2SNC Beech	3437	3594	3752	4065	4379	4693	5008	5320	5948	
	Two-Seat Wood Arm High Back Lounge, Closed Arm										
	FAE3-WH2CNC Beech	3378	3535	3691	4006	4318	4634	4947	5261	5890	
	Two-Seat Plus Wood Arm High Back Lounge, Closed Arm										
	FAE3-WHB2CNC Beech	3457	3614	3771	4086	4398	4712	5028	5341	5970	

**ORDERING NOTES:** Faeron chairs can be specified with Urethane Arm Caps (UC), Solid Surface Arm Caps (SC) or Solid Surface Arm (SA), replace "NC" in the model number with the **Arm Style** selection below and add the upcharge listed on page 254.



## PRODUCT CODE KEY

Line	Series	Chair Type	Size	Arm Style	Arm Cap	
FAE Faeron	3-W Wood Arm Lounge Seating	L Lounge	1 One-Seat	B1 One-Seat Plus	O Open Arm	NC No Cap
		H High Back Lounge	1+ One-Seat Wide	B1+ One-Seat Wide Plus	S Semi Closed Arm	UC Urethane Cap
			2 Two-Seat	B2 Two-Seat Plus	C Closed Arm	SC Solid Surface Cap
			3 Three-Seat	B3 Three-Seat Plus		SA Solid Surface Arm

HEALTHCARE DISCOUNT APPLIES TO THESE PRODUCTS

# FAERON WOOD | LOUNGE & HIGH BACK LOUNGE

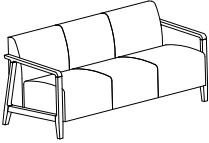
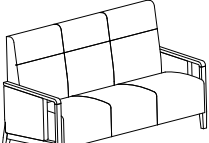
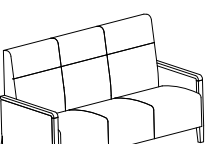
HEALTHCARE DISCOUNT APPLIES TO THESE PRODUCTS





DESCRIPTION/MODEL	Species	COM		COL		FABRIC GRADES			LEATHER	
		1	2	3	4	5	6	7	8	9
	Three-Seat Wood Arm Lounge, Open Arm									
	FAE3-WL3ONC Beech	3417	3588	3760	4103	4444	4786	5128	5471	6156
	Three-Seat Plus Wood Arm Lounge, Open Arm									
	FAE3-WLB3ONC Beech	3557	3728	3899	4242	4584	4924	5269	5611	6293
	Three-Seat Wood Arm Lounge, Semi Closed Arm									
	FAE3-WL3SNC Beech	3949	4154	4360	4769	5181	5590	6002	6412	7235
	Three-Seat Plus Wood Arm Lounge, Semi Closed Arm									
	FAE3-WLB3SNC Beech	4088	4292	4499	4908	5319	5730	6140	6553	7373
	Three-Seat Wood Arm Lounge, Closed Arm									
	FAE3-WL3CNC Beech	3969	4173	4379	4790	5201	5612	6021	6432	7255
	Three-Seat Plus Wood Arm Lounge, Closed Arm									
	FAE3-WLB3CNC Beech	4108	4313	4518	4929	5340	5751	6162	6573	7393
	Three-Seat Wood Arm High Back Lounge, Open Arm									
	FAE3-WH3ONC Beech	3651	3852	4057	4460	4867	5273	5678	6082	6895
	Three-Seat Plus Wood Arm High Back Lounge, Open Arm									
	FAE3-WHB3ONC Beech	3789	3993	4194	4602	5007	5412	5815	6224	7035
	Three-Seat Wood Arm High Back Lounge, Semi Closed Arm									
	FAE3-WH3SNC Beech	4182	4418	4655	5130	5604	6078	6553	7025	7972
	Three-Seat Plus Wood Arm High Back Lounge, Semi Closed Arm									
	FAE3-WHB3SNC Beech	4319	4558	4794	5269	5742	6216	6690	7164	8115
	Three-Seat Wood Arm High Back Lounge, Closed Arm									
	FAE3-WH3CNC Beech	4203	4439	4677	5149	5622	6097	6571	7045	7993
	Three-Seat Plus Wood Arm High Back Lounge, Closed Arm									
	FAE3-WHB3CNC Beech	4340	4579	4815	5288	5764	6237	6710	7184	8132

**ORDERING NOTES:** Faeron chairs can be specified with Urethane Arm Caps (UC), Solid Surface Arm Caps (SC) or Solid Surface Arm (SA), replace "NC" in the model number with the **Arm Style** selection below and add the upcharge listed on page 254.

## PRODUCT CODE KEY

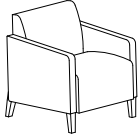
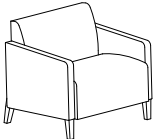
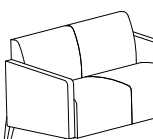
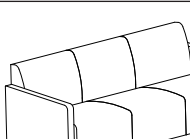
Line	Series	Chair Type	Size	Arm Style	Arm Cap	
FAE Faeron	3-W Wood Arm Lounge Seating	L Lounge	1 One-Seat	B1 One-Seat Plus	O Open Arm	NC No Cap
		H High Back Lounge	1+ One-Seat Wide	B1+ One-Seat Wide Plus	S Semi Closed Arm	UC Urethane Cap
			2 Two-Seat	B2 Two-Seat Plus	C Closed Arm	SC Solid Surface Cap
			3 Three-Seat	B3 Three-Seat Plus		SA Solid Surface Arm

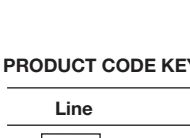
# FAERON UPHOLSTERED | LOUNGE

DESCRIPTION/MODEL	COM		COL		FABRIC GRADES		LEATHER		
	1	2	3	4	5	6	7	8	9
	One-Seat Upholstered Arm Lounge, No Arm Cap, Beech Wood leg								
	FAE3-UL1NCW	2610	2764	2917	3224	3534	3843	4149	4458
	One-Seat Plus Upholstered Arm Lounge, No arm cap, Wood leg								
	FAE3-ULB1NCW	2678	2831	2986	3293	3603	3909	4217	4527
	One-Seat Wide Upholstered Arm Lounge, No arm cap, Wood leg								
	FAE3-UL1+NCW	2798	2978	3159	3516	3876	4236	4593	4953
	One-Seat Wide Plus Upholstered Arm Lounge, No arm cap, Wood leg								
	FAE3-ULB1+NCW	2872	3053	3232	3591	3950	4310	4668	5028
	Two-seat Upholstered Arm Lounge, No arm cap, Wood leg								
	FAE3-UL2NCW	3346	3536	3727	4105	4484	4864	5243	5622
	Two-seat Plus Upholstered Arm Lounge, No arm cap, Wood leg								
	FAE3-ULB2NCW	3428	3617	3806	4185	4564	4944	5323	5703
	Three-seat Upholstered Arm Lounge, No arm cap, Wood leg								
	FAE3-UL3NCW	4105	4360	4614	5121	5630	6136	6644	7152
	Three-seat Plus Upholstered Arm Lounge, No arm cap, Wood leg								
	FAE3-ULB3NCW	4245	4500	4754	5260	5767	6276	6784	7290

HEALTHCARE DISCOUNT APPLIES TO THESE PRODUCTS

**ORDERING NOTES:** Faeron upholstered chairs can be specified with Urethane Arm Caps (UC), Solid Surface Arm Caps (SC), or Wood Arm Caps (WC), replace "NC" in the model number with the **Arm Style** selection below and add the upcharge listed on on page 254. To specify the Metal Leg option below, replace "W" in the above model number with "S" for Silver Metallic or "N" for Brushed Nickel.

## PRODUCT CODE KEY

Line	Series	Chair Type	Size	Arm Cap	Leg Type
FAE Faeron	3-U Upholstered Arm Lounge Seating	L Lounge	1 One-Seat	NC No Cap	W Beech Wood Leg
		H High Back Lounge	1+ One-Seat Wide	UC Urethane Cap	S Silver Metallic Leg
			2 Two-Seat	SC Solid Surface Cap	N Brushed Nickel Leg
			3 Three-Seat	WC Wood Arm Cap	

# FAERON UPHOLSTERED | HIGH BACK LOUNGE

HEALTHCARE DISCOUNT APPLIES TO THESE PRODUCTS

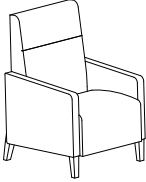
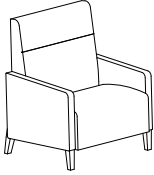
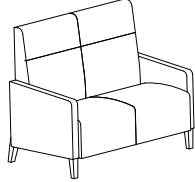
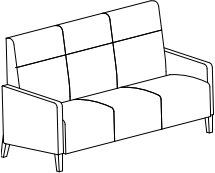
DESCRIPTION/MODEL	COM		COL		FABRIC GRADES		LEATHER		
	1	2	3	4	5	6	7	8	9
 One-Seat Upholstered Arm High Back Lounge, No Arm Cap, Wood leg FAE3-UH1NCW	2833	3004	3173	3514	3852	4193	4532	4873	5552
	One-Seat Plus, Upholstered Arm High Back Lounge, No Arm Cap, Wood leg FAE3-UHB1NCW								
 One-Seat Wide, Upholstered Arm High Back Lounge, No Arm Cap, Wood leg FAE3-UH1+NCW	3039	3235	3430	3820	4213	4603	4994	5387	6166
	One-Seat Wide Plus, Upholstered Arm High Back Lounge, No Arm Cap, Wood leg FAE3-UHB1+NCW								
 Two-seat, Upholstered Arm High Back Lounge, No Arm Cap, Wood leg FAE3-UH2NCW	3515	3720	3927	4337	4748	5159	5569	5980	6804
	Two-seat Plus, Upholstered Arm High Back Lounge, No Arm Cap, Wood leg FAE3-UHB2NCW								
 Three-seat, Upholstered Arm High Back Lounge, No Arm Cap, Wood leg FAE3-UH3NCW	4338	4623	4908	5481	6052	6623	7192	7764	8908
	Three-seat Plus, Upholstered Arm High Back Lounge, No Arm Cap, Wood leg FAE3-UHB3NCW								



**ORDERING NOTES:** Faeron upholstered chairs can be specified with Urethane Arm Caps (UC), Solid Surface Arm Caps (SC), or Wood Arm Caps (WC), replace "NC" in the model number with the **Arm Style** selection below and add the upcharge listed on page 254. To specify the Metal Leg option below, replace "W" in the above model number with "S" for Silver Metallic or "N" for Brushed Nickel.

## PRODUCT CODE KEY

Line	Series	Chair Type	Size	Arm Style	Leg Type	
FAE Faeron	3-U Upholstered Arm Lounge Seating	L Lounge	1 One-Seat	B1 One-Seat Plus	NC No Cap	W Beech Wood Leg
		H High Back Lounge	1+ One-Seat Wide	B1+ One-Seat Wide Plus	UC Urethane Cap	S Silver Metallic
			2 Two-Seat	B2 Two-Seat Plus	SC Solid Surface Cap	N Brushed Nickel
			3 Three-Seat	B3 Three-Seat Plus	WC Wood Arm Cap	

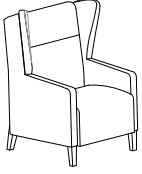
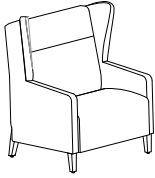
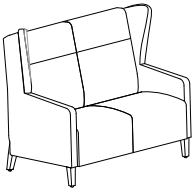
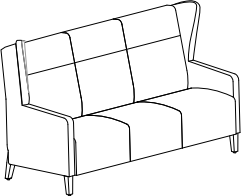
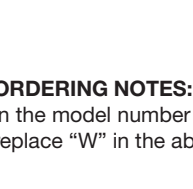
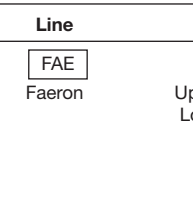

# FAERON UPHOLSTERED | WINGBACK LOUNGE

DESCRIPTION/MODEL	COM		COL		FABRIC GRADES		LEATHER		
	1	2	3	4	5	6	7	8	9
	One-Seat Upholstered Arm Wingback, No Arm Cap, Wood leg								
	FAE3-UW1NCW	3232	3402	3568	3909	4249	4589	4929	5269
	One-Seat Plus Upholstered Arm Wingback, No Arm Cap, Wood leg								
	FAE3-UWB1NCW	3298	3469	3638	3979	4317	4658	4996	5338
	One-Seat Wide Upholstered Arm Wingback, No Arm Cap, Wood leg								
	FAE3-UW1+NCW	3434	3631	3827	4217	4609	5000	5391	5782
	One-Seat Wide Plus Upholstered Arm Wingback, No Arm Cap, Wood leg								
	FAE3-UWB1+NCW	3510	3706	3899	4291	4683	5072	5465	5856
	Two-seat Upholstered Arm Wingback, No Arm Cap, Wood leg								
	FAE3-UW2NCW	3910	4116	4321	4733	5143	5556	5966	6377
	Two-seat Plus Upholstered Arm Wingback, No Arm Cap, Wood leg								
	FAE3-UWB2NCW	3991	4196	4401	4813	5223	5635	6046	6456
	Three-seat Upholstered Arm Wingback, No Arm Cap, Wood leg								
	FAE3-UW3NCW	4735	5021	5306	5876	6448	7019	7591	8160
	Three-seat Plus Upholstered Arm Wingback, No Arm Cap, Wood leg								
	FAE3-UWB3NCW	4874	5160	5444	6016	6586	7158	7730	8300

**ORDERING NOTES:** Faeron upholstered chairs can be specified with Solid Surface Arm Caps (SC) , or Wood Arm Caps (WC), replace “NC” in the model number with the **Arm Style** selection below and add the upcharge listed on page 254. To specify the Metal Leg option below, replace “W” in the above model number with “S” for Silver Metallic or “N” for Brushed Nickel.

## PRODUCT CODE KEY

Line	Series	Chair Type	Size	Arm Cap	Leg Type
FAE Faeron	3-U Upholstered Arm Lounge Seating	W Wingback	1 One-Seat	NC No Cap	W Beech Wood Leg
			1+ One-Seat Wide	WC Wood Arm Cap	S Silver Metallic
			2 Two-Seat	SC Solid Surface Cap	N Brushed Nickel
			3 Three-Seat		
				B1 One-Seat Plus	
				B1+ One-Seat Wide Plus	
				B2 Two-Seat Plus	
				B3 Three-Seat Plus	

# SUTTON | ENVIRONMENTAL SUMMARY

## LEED CI CREDITS



MATERIAL CONTENT:

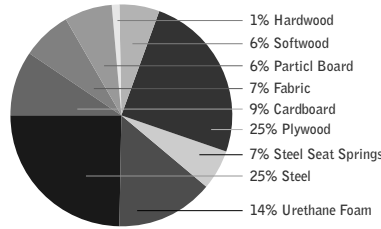

PRE-CONSUMER RECYCLED CONTENT = 8.09%

POST-CONSUMER RECYCLED CONTENT = 15.29%

Up to 23.38% of Sutton product is recyclable at the end of its useful life.

CONTRIBUTES TO

CREDIT 2.1 - 2.2	Construction Waste Management	1-2 point(s)
CREDIT 3.3	Resource Reuse	1 point
CREDIT 4.1	Recycled Content	1 point
CREDIT 4.5	Low Emitting Materials, Systems & Seating	1 point
CREDIT 5.1	Regional Materials*	1 point
CREDIT 7	Certified Wood (MUST BE REQUESTED)	1 point(s)

\*This credit is only applicable if in total 20% of the combined value of the procurement of construction materials and in the furniture are manufactured within a radius of 500 miles. This credit will apply if the installation of the finished product occurs within 500 miles of Kitchener, Ontario.

## level® CERTIFICATION, AIR EMISSIONS AND FSC® CERTIFICATION



**level® CERTIFICATION**

BIFMA's e3 Furniture Sustainability Standard is a voluntary, multi-attribute standard that measures the degree of sustainability of furniture. This standard evaluates product and company environmental attributes and compliance systems in a wide range of elements which include Materials, Energy & Atmosphere, Human & Ecosystem Health and Social Responsibility. Sutton products have earned level®, BIFMA's sustainability certification program for furniture, certification through third-party verification against the e3 standard.



the mark of responsible forest

**AIR EMISSIONS**



All Sutton products are supplied air-emissions certified. Contact customer service for information.

**FSC®**

In 2005, Krug received Forest Stewardship Council® (FSC®) Chain-of-Custody certification for our manufacturing facilities. The FSC® Chain-of-Custody tracks certified wood from seedling to final sale. It verifies that the material for our FSC® certified products only come from well-managed, FSC®-certified forests and other controlled sources. FSC® is dedicated to the promotion of responsible forest management worldwide helping to take care of forests for future generations. Sutton and other Krug products can be specified with FSC® Certification. Contact customer service for further information, pricing and lead times.

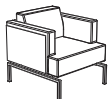

Architects, designers, and building professionals can specify FSC®-certified products in order to achieve a point from the U.S. Green Building Council's Leadership in Energy and Environmental Design (LEED) Rating System.

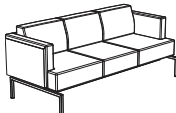
DESCRIPTION/MODEL/FINISHES	COM		COL		FABRIC GRADES			LEATHER		
	1	2	3	4	5	6	7	8	9	
 ONE-SEAT SUT3-1-0-1 Cherry, Oak, Maple, Walnut, Anigre	2085	2273	2493	2829	3038	3268	3545	4233	5080	
	SUT3-1-0-2	2282	2503	2746	3147	3379	3631	3941	4706	5584
	SUT3-1-1-1	2217	2431	2665	3057	3279	3528	3827	4567	5420
	SUT3-1-1-2	2639	2852	3058	3268	3479	3691	3896	4149	5000
 TWO-SEAT SUT3-2-0-1 Cherry, Oak, Maple, Walnut, Anigre	2788	2956	3133	3348	3599	3847	4584	5203	6288	
	SUT3-2-0-2	3101	3289	3484	3727	4001	4282	4809	5786	6902
	SUT3-2-1-1	3011	3192	3382	3618	3885	4155	4664	5617	6703
	SUT3-2-1-2	3429	3644	3865	4131	4399	4665	4932	5279	6358
 THREE-SEAT SUT3-3-0-1 Cherry, Oak, Maple, Walnut, Anigre	3783	3997	4233	4459	4685	4922	5173	6267	7781	
	SUT3-3-0-2	4209	4447	4706	4959	5215	5472	5751	6970	8530
	SUT3-3-1-1	4086	4318	4567	4815	5062	5315	5584	6769	8282
	SUT3-3-1-2	4483	4826	5182	5613	6049	6482	6918	7416	8933

## DIMENSIONS & COM REQUIREMENTS

	Overall Width	Overall Depth	Overall Height	Seat Height	Height of Arms from Floor	Width between Arms	Seat Depth	Shipping Weight	Cube	COM Yardage
SUT3101	27.5	29.5	30.5	16.75	26	20.25	20.25	85	16.75	3.8
SUT3102	27.5	29.5	30.5	16.75	26	20.25	20.25	85	16.75	3.8
SUT3111	27.5	29.5	30.5	16.75	26	20.25	20.25	85	16.75	2.8
SUT3112	27.5	29.5	30.5	16.75	26	20.25	20.25	85	16.75	2.8
SUT3201	47.5	29.5	30.5	16.75	26	40.25	20.25	125	28.5	5.6
SUT3202	47.5	29.5	30.5	16.75	26	40.25	20.25	125	28.5	5.6
SUT3211	47.5	29.5	30.5	16.75	26	40.25	20.25	125	28.5	4.0
SUT3212	47.5	29.5	30.5	16.75	26	40.25	20.25	125	28.5	4.0
SUT3301	67.5	29.5	30.5	16.75	26	60.25	20.25	155	41	7.6
SUT3302	67.5	29.5	30.5	16.75	26	60.25	20.25	155	41	7.6
SUT3311	67.5	29.5	30.5	16.75	26	60.25	20.25	155	41	5.5
SUT3312	67.5	29.5	30.5	16.75	26	60.25	20.25	155	41	5.5

PRODUCT CODE KEY	Line	Series	Seat Count	Arm/Back Style	Base Style
SUT	3	1	0	1	Sutton Soft Seating One-Seat Fully Upholstered Surround Wood Base & Legs
		2	1	2	Two-Seat Wood Surround Metal Base & Legs
		3			Three-Seat

### STANDARD FINISHES

Oak finishes on wood surround versions are applied on Rift Oak. For a complete list of standard wood finishes please see page 14.

### METAL BASE OPTION

Metal base is available in Silver Metallic only. Note: Rift Oak surround can only be specified with a Silver Metallic base.

### REMOVABLE UPHOLSTERED SEAT COVERS

Sutton Lounge Chairs are available with a removable upholstered seat cover at an upcharge of **\$159 list** per one-seater chair, **\$318 list** per two-seater chair and **\$477 list** per three-seater chair.

### MOISTURE BARRIER & CAL 133

Moisture Barrier & CAL 133 is available for an upcharge of **\$64 list** per yard.

# CARLYLE | ENVIRONMENTAL SUMMARY

## LEED CI CREDITS



MATERIAL CONTENT:

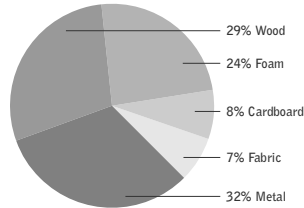

PRE-CONSUMER  
RECYCLED CONTENT = 3.96%

POST-CONSUMER  
RECYCLED CONTENT = 14.38%

Up to 37.5% of Carlyle product is recyclable at the end of its useful life.

### CONTRIBUTES TO

CREDIT 2.1 - 2.2	Construction Waste Management	1-2 point(s)
CREDIT 3.3	Resource Reuse	1 point
CREDIT 4.1	Recycled Content	1 point
CREDIT 4.5	Low Emitting Materials, Systems & Seating	1 point
CREDIT 5.1	Regional Materials*	1 point
CREDIT 7	Certified Wood (MUST BE REQUESTED)	1 point(s)

\*This credit is only applicable if in total 20% of the combined value of the procurement of construction materials and in the furniture are manufactured within a radius of 500 miles. This credit will apply if the installation of the finished product occurs within 500 miles of Kitchener, Ontario.

## level® CERTIFICATION, AIR EMISSIONS AND FSC® CERTIFICATION



### level® CERTIFICATION

BIFMA's e3 Furniture Sustainability Standard is a voluntary, multi-attribute standard that measures the degree of sustainability of furniture. This standard evaluates product and company environmental attributes and compliance systems in a wide range of elements which include Materials, Energy & Atmosphere, Human & Ecosystem Health and Social Responsibility. Carlyle products have earned level®, BIFMA's sustainability certification program for furniture, certification through third-party verification against the e3 standard.

### AIR-EMISSIONS

All Carlyle products are supplied with air-emissions certified. Contact customer service for information.



### FSC®

In 2005, Krug received Forest Stewardship Council® (FSC®) Chain-of-Custody certification for our manufacturing facilities. The FSC® Chain-of-Custody tracks certified wood from seedling to final sale. It verifies that the material for our FSC® certified products only come from well-managed, FSC®-certified forests and other controlled sources. FSC® is dedicated to the promotion of responsible forest management worldwide helping to take care of forests for future generations. Carlyle and other Krug products can be specified with FSC® Certification. Contact customer service for further information, pricing and lead times.



Architects, designers, and building professionals can specify FSC®-certified products in order to achieve a point from the U.S. Green Building Council's Leadership in Energy and Environmental Design (LEED) Rating System.

# CARLYLE | LOUNGE

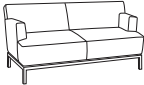
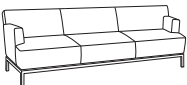
DESCRIPTION/MODEL/FINISHES	COM		COL		FABRIC GRADES			LEATHER		
	1	2	3	4	5	6	7	8	9	
 ONE-SEAT CAR311	Cherry, Maple, Walnut, Anigre	3289	3395	3497	3706	3909	4118	4327	4707	5355
	Silver Metallic	3289	3395	3497	3706	3909	4118	4327	4707	5355
 TWO-SEAT CAR321	Cherry, Maple, Walnut, Anigre	4441	4596	4750	5010	5273	5531	5787	6352	7398
	Silver Metallic	4441	4596	4750	5010	5273	5531	5787	6352	7398
 THREE-SEAT CAR331	Cherry, Maple, Walnut, Anigre	5989	6181	6366	6714	7064	7405	7755	8446	9741
	Silver Metallic	5989	6181	6366	6714	7064	7405	7755	8446	9741

## DIMENSIONS & COM REQUIREMENTS

	Overall Width	Overall Depth	Overall Height	Seat Height	Height of Arms from Floor	Width between Arms	Seat Depth	Shipping Weight	Cube	COM Yardage
<b>CAR311</b>	33	30	32	17.5	26	20	22	60	24	4.5
<b>CAR312</b>	33	30	32	17.5	26	20	22	60	24	4.5
<b>CAR321</b>	59.5	30	32	17.5	26	47	22	94	43	7.25
<b>CAR322</b>	59.5	30	32	17.5	26	47	22	94	43	7.25
<b>CAR331</b>	84	30	32	17.5	26	70.5	22	135	62	9.0
<b>CAR332</b>	84	30	32	17.5	26	70.5	22	135	62	9.0

## ORDERING NOTES

Carlyle Lounge Chairs are available with a removable upholstered seat cover at an upcharge of **\$159 list** per one-seater chair, **\$318 list** per two-seater chair and **\$477 list** per three-seater chair.

PRODUCT CODE KEY		Seat Count	Base Style
Line	Series		
CAR	3	1	1
Carlyle	Soft Seating	One-Seat	Wood Base & Legs
		2	2
		Two-Seat	Metal Base & Legs
		3	
		Three-Seat	

## STANDARD FINISHES

For a complete list of standard wood finishes please see page 335.

## CARLYLE LOUNGE

Carlyle is available in both wood base and Silver Metallic base versions.

## MOISTURE BARRIER & CAL 133

Moisture Barrier & CAL 133 is available for an upcharge of **\$64 list** per yard.

# BRIO | ENVIRONMENTAL SUMMARY

## LEED CI CREDITS



MATERIAL CONTENT:

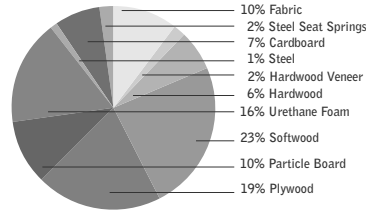

PRE-CONSUMER  
RECYCLED CONTENT = 7.09%

POST-CONSUMER  
RECYCLED CONTENT = 9.43%

Up to 11.34% of Brio product is recyclable at the end of its useful life.

CONTRIBUTES TO		
CREDIT 2.1 - 2.2	Construction Waste Management	1-2 point(s)
CREDIT 3.3	Resource Reuse	1 point
CREDIT 4.1	Recycled Content	1 point
CREDIT 4.5	Low Emitting Materials, Systems & Seating	1 point
CREDIT 5.1	Regional Materials*	1 point
CREDIT 7	Certified Wood (MUST BE REQUESTED)	1 point(s)

\*This credit is only applicable if in total 20% of the combined value of the procurement of construction materials and in the furniture are manufactured within a radius of 500 miles. This credit will apply if the installation of the finished product occurs within 500 miles of Kitchener, Ontario.

## level® CERTIFICATION, AIR EMISSIONS AND FSC® CERTIFICATION



### level® CERTIFICATION

BIFMA's e3 Furniture Sustainability Standard is a voluntary, multi-attribute standard that measures the degree of sustainability of furniture. This standard evaluates product and company environmental attributes and compliance systems in a wide range of elements which include Materials, Energy & Atmosphere, Human & Ecosystem Health and Social Responsibility. Brio products have earned level®, BIFMA's sustainability certification program for furniture, certification through third-party verification against the e3 standard.

### AIR-EMISSIONS

All Brio products are supplied with air-emissions certified. Contact customer service for information.



### FSC®

In 2005, Krug received Forest Stewardship Council® (FSC®) Chain-of-Custody certification for our manufacturing facilities. The FSC® Chain-of-Custody tracks certified wood from seedling to final sale. It verifies that the material for our FSC® certified products only come from well-managed, FSC®-certified forests and other controlled sources. FSC® is dedicated to the promotion of responsible forest management worldwide helping to take care of forests for future generations. Brio and other Krug products can be specified with FSC® Certification. Contact customer service for further information, pricing and lead times.

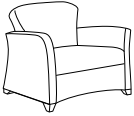
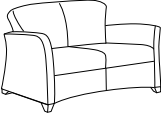
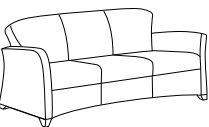

Architects, designers, and building professionals can specify FSC®-certified products in order to achieve a point from the U.S. Green Building Council's Leadership in Energy and Environmental Design (LEED) Rating System.

DESCRIPTION/MODEL	FINISHES	COM		COL			FABRIC GRADES			LEATHER	
		1	2	3	4	5	6	7	8	9	
 ONE-SEAT 4100-1	Cherry, Maple, Walnut, Anigre	2085	2273	2493	2829	3038	3268	3545	4233	5080	
		<hr/>									
 TWO-SEAT 4100-2	Cherry, Maple, Walnut, Anigre	2788	2956	3133	3348	3599	3847	4584	5203	6288	
		<hr/>									
 THREE-SEAT 4100-3	Cherry, Maple, Walnut, Anigre	3783	3997	4233	4459	4685	4922	5173	6267	7781	

**ORDERING NOTES**

Brio Lounge Chairs are available with a removable upholstered seat cover at an upcharge of **\$159 list** per one-seater chair, **\$318 list** per two-seater chair, and **\$477 list** per three-seater chair.

**DIMENSIONS & COM REQUIREMENTS**

	Overall Width	Overall Depth	Overall Height	Seat Height	Height of Arms from Floor	Width between Arms	Seat Depth	Shipping Weight	Cube	COM Yardage
<b>4100-1</b>	31.5	31.5	34	18	26	22.5	20.75	97	22	5.9
<b>4100-2</b>	54	31.5	34	18	26	45	20.75	120	41	7.5
<b>4100-3</b>	76	31.5	34	18	26	67.5	20.75	145	55	10.5

**ORDERING PROCEDURE**

To order please specify the following:

1. Krug product model number
2. Fabric name and number
3. Color name and number

Dimensions are in inches and approximate. Contact Customer Service if dimensions are critical.

**STANDARD FINISHES**

For a complete list of standard wood finishes please see page 335.

**BRIO**

Brio has fixed seat cushions.

**MOISTURE BARRIER & CAL 133**

Moisture Barrier & CAL 133 is available for an upcharge of **\$64 list** per yard.

# SLOANE | LEED CI CREDIT SUMMARY

## LEED CI CREDITS



MATERIAL CONTENT:

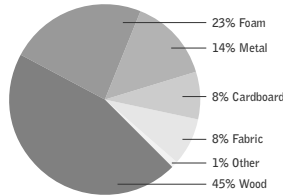

PRE-CONSUMER  
RECYCLED CONTENT = 6.94%

POST-CONSUMER  
RECYCLED CONTENT = 15.22%

Up to 29.22% of Sloane product is recyclable at the end of its useful life.

### CONTRIBUTES TO

CREDIT 2.1 - 2.2	Construction Waste Management	1-2 point(s)
CREDIT 3.3	Resource Reuse	1 point
CREDIT 4.1	Recycled Content	1 point
CREDIT 4.5	Low Emitting Materials, Systems & Seating	1 point
CREDIT 5.1	Regional Materials*	1 point
CREDIT 7	Certified Wood (MUST BE REQUESTED)	1 point(s)

\*This credit is only applicable if in total 20% of the combined value of the procurement of construction materials and in the furniture are manufactured within a radius of 500 miles. This credit will apply if the installation of the finished product occurs within 500 miles of Kitchener, Ontario.

## level® CERTIFICATION, AIR EMISSIONS AND FSC® CERTIFICATION



### level® CERTIFICATION

BIFMA's e3 Furniture Sustainability Standard is a voluntary, multi-attribute standard that measures the degree of sustainability of furniture. This standard evaluates product and company environmental attributes and compliance systems in a wide range of elements which include Materials, Energy & Atmosphere, Human & Ecosystem Health and Social Responsibility. Sloane products have earned level®, BIFMA's sustainability certification program for furniture, certification through third-party verification against the e3 standard.



FSC  
www.fsc.org  
FSC® C021899

the mark of responsible forest®

### AIR EMISSIONS

All Sloane products are supplied air-emissions certified. Contact customer service for information.

### FSC®

In 2005, Krug received Forest Stewardship Council® (FSC®) Chain-of-Custody certification for our manufacturing facilities. The FSC® Chain-of-Custody tracks certified wood from seedling to final sale. It verifies that the material for our FSC® certified products only come from well-managed, FSC®-certified forests and other controlled sources. FSC® is dedicated to the promotion of responsible forest management worldwide helping to take care of forests for future generations. Sloane and other Krug products can be specified with FSC® Certification. Contact customer service for further information, pricing and lead times.





Architects, designers, and building professionals can specify FSC®-certified products in order to achieve a point from the U.S. Green Building Council's Leadership in Energy and Environmental Design (LEED) Rating System.

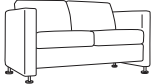

DESCRIPTION/MODEL	COM		COL	FABRIC GRADES			LEATHER		
	1	2	3	4	5	6	7	8	9
 ONE-SEAT SLO3-10 SLO3-11	2639	2852	3058	3268	3479	3691	3896	4149	5000
	2880	3092	3299	3560	3866	3984	4187	4443	5295

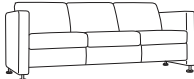
 TWO-SEAT SLO3-20 SLO3-21	3429	3644	3865	4131	4399	4665	4932	5279	6358
	3862	4077	4295	4610	4886	5141	5419	5755	6836

 THREE-SEAT SLO3-30	4483	4826	5182	5613	6049	6482	6918	7416	8933
--	------	------	------	------	------	------	------	------	------

 SLO3-31	4915	5260	5614	6097	6532	6961	7403	7898	9413
---	------	------	------	------	------	------	------	------	------

**DIMENSIONS & COM REQUIREMENTS**

	Overall Width	Overall Depth	Overall Height	Seat Height	Height of Arms from Floor	Width between Arms	Seat Depth	Shipping Weight	Cube	COM Yardage
<b>SLO3-10</b>	32.25	30.5	30.75	17.5	26	22.5	20.25	95	19	5.9
<b>SLO3-11</b>	32.25	30.5	30.75	17.5	26	22.5	20.25	95	19	5.9
<b>SLO3-20</b>	54.75	30.5	30.75	17.5	26	45	20.25	143	31	7.5
<b>SLO3-21</b>	54.75	30.5	30.75	17.5	26	45	20.25	143	31	7.5
<b>SLO3-30</b>	77.25	30.5	30.75	17.5	26	67.5	20.25	190	43	10.5
<b>SLO3-31</b>	77.25	30.5	30.75	17.5	26	67.5	20.25	190	43	10.5

**ORDERING NOTES**

Sloane Lounge Chairs are available with a removable upholstered seat cover at an upcharge of **\$159 list** per one-seater chair, **\$318 list** per two-seater chair and **\$477 list** per three-seater chair.

PRODUCT CODE KEY				SLOANE LEG FINISH
Line	Series	Seat Count	Upholstery Style	Legs are available in metal with a Silver Metallic finish only, as shown.
<input type="text" value="SLO"/>	<input type="text" value="3"/>	<input type="text" value="1"/>	<input type="text" value="0"/>	<b>MOISTURE BARRIER &amp; CAL 133</b> Moisture Barrier & CAL 133 is available for an upcharge of <b>\$64 list</b> per yard.
Sloane	Soft Seating	One-Seat	Standard Upholstery	
		<input type="text" value="2"/> Two-Seat	<input type="text" value="1"/> Top Stitching & Buttons	
		<input type="text" value="3"/> Three-Seat		

# BENCHES

274 Tate  
280 Zola  
290 Carlyle

## LEED CI CREDITS

### MATERIAL CONTENT:

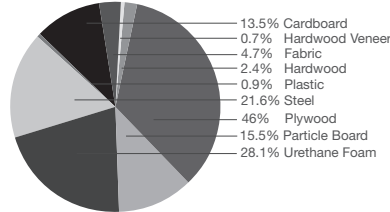

PRE-CONSUMER  
RECYCLED CONTENT = 9.09%

POST-CONSUMER  
RECYCLED CONTENT = 24.26%

Up to 26.97% of this Tate product is recyclable at the end of its useful life.

### CONTRIBUTES TO

CREDIT 2.1 - 2.2	Construction Waste Management	1-2 point(s)
CREDIT 3.3	Resource Reuse	1 point
CREDIT 4.1	Recycled Content	1 point
CREDIT 4.2	Recycled Content	1 point
CREDIT 4.5	Low Emitting Materials, Systems & Seating	1 point
CREDIT 5.1	Regional Materials*	1 point
CREDIT 7	Certified Wood (MUST BE REQUESTED)	1 point(s)

\*This credit is only applicable if in total 20% of the combined value of the procurement of construction materials and in the furniture are manufactured within a radius of 500 miles. This credit will apply if the installation of the finished product occurs within 500 miles of Kitchener, Ontario.

## level® CERTIFICATION, AIR EMISSIONS AND FSC® CERTIFICATION



### level® CERTIFICATION

BIFMA's e3 Furniture Sustainability Standard is a voluntary, multi-attribute standard that measures the degree of sustainability of furniture. This standard evaluates product and company environmental attributes and compliance systems in a wide range of elements which include Materials, Energy & Atmosphere, Human & Ecosystem Health and Social Responsibility. Tate Bench products have earned level®, BIFMA's sustainability certification program for furniture, certification through third-party verification against the e3 standard.



the mark of responsible forest

### AIR EMISSIONS

All Tate Bench products are supplied air-emissions certified. Contact customer service for information.

### FSC®

In 2005, Krug received Forest Stewardship Council® (FSC®) Chain-of-Custody certification for our manufacturing facilities. The FSC® Chain-of-Custody tracks certified wood from seedling to final sale. It verifies that the material for our FSC® certified products only come from well-managed, FSC®-certified forests and other controlled sources. FSC® is dedicated to the promotion of responsible forest management worldwide helping to take care of forests for future generations. Tate and other Krug products can be specified with FSC® Certification. Contact customer service for further information, pricing and lead times.



Architects, designers, and building professionals can specify FSC®-certified products in order to achieve a point from the U.S. Green Building Council's Leadership in Energy and Environmental Design (LEED) Rating System.

# TATE BENCHES | FEATURES & OPTIONS

## STYLE

Tate Bench features three design styles; Fully Upholstered, Gable End and Table End.



Fully Upholstered



Gable End

Tate Bench gable ends are 2" wide x 20" deep x 6" high on standard depth units and 2" wide x 25" deep x 6" high on deep seat units

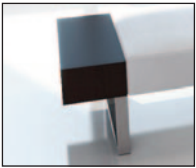

Table End

Tate Bench table ends are 10" wide x 20" deep x 6" high on standard depth units and 10" wide x 25" deep x 6" high on deep seat units.



## LEGS

Tate Bench legs feature polished chrome structural steel legs with non-marring glides.

## REPLACEABLE COMPONENTS

Tate Benches are uniquely designed to allow major components to be field replaced, providing a very cost effective means to significantly extend the life of the product. Gable ends, table ends and legs are field replaceable.

## WEIGHT CAPACITIES

Tate Bench have the following maximum weight ratings:

2 seater - 975 lbs

3 seater - 1,200 lbs

## OPTIONS

### Removable Covers

Optional Removeable covers can be quickly installed on Tate Bench products that were originally ordered with the Removable cover option. Replacement covers can also be installed on Tate Bench products that were not originally ordered with the Removable cover option, with some simple staple removal.

### CAL 133 & Moisture Barrier

California Technical Bulletin 133 is a flammability test for seating. Krug offers a compliance method which, in combination with non-flammable upholstery covers, may enable the products to meet certification requirements for this test. This process at the same time also provides the products with a Moisture Barrier - a treatment that helps to prevent the passage of liquids and moisture to inside of upholstered components - thereby conferring sanitary and anti-infection benefits. So when CAL 133 is specified, the product also automatically has a Moisture Barrier, and when a Moisture Barrier is specified, the product also features the compliance method and low flammability features of CAL 133.

The application of this upcharge and the compliance method does not mean that the specific configuration of product and upholstery cover are tested and officially certified as being CAL 133 compliant. If official certification is required, Krug will provide this (through an independent certified testing laboratory) at a charge of \$917 per item, plus the cost of the product to be tested. Lead time for certification testing is typically 4-8 weeks. Krug assumes no responsibility for the testing of our products in combination with upholstery covers, or for the results of any testing conducted. Some specific configurations of product and upholstery have already been tested. Please contact Customer Service for additional information.

## DIMENSIONS & COM REQUIREMENTS

	Overall Length	Overall Depth	Overall Height	Seat Length	Shipping Weight	Cube	COM Yardage
TAT5-2210	43	21	17	43	48	10.7	1.4
TAT5-2260	43	26	17	43	57	13.2	1.6
TAT5-3210	65	21	17	65	62	15.7	2.0
TAT5-3260	65	26	17	65	74	19.4	2.3
TAT5-2211	47	21	17	43	56	10.7	1.4
TAT5-2261	47	26	17	43	65	13.2	1.6
TAT5-3211	69	21	17	65	70	15.7	2.0
TAT5-3261	69	26	17	65	82	19.4	2.3
TAT5-2212	63	21	17	43	70	14.3	1.4
TAT5-2262	63	26	17	43	83	17.7	1.6
TAT5-3212	84.5	21	17	65	84	19.2	2.0
TAT5-3262	84.5	26	17	65	100	23.8	2.3

## DIMENSIONS:

All dimensions are in inches and approximate and are subject to change without notice. Contact Customer Service if dimensions are critical.

# TATE BENCHES | VENEERS & FINISHES

## WOOD FINISHES

Standard wood finishes are:

SPECIES	FINISH
<b>OAK</b>	Light Oak SilverGrey on Oak Espresso Oak
<b>MAPLE</b>	Clear Maple Wheat Maple
<b>WALNUT</b>	Natural Walnut SilverGrey on Walnut Regular Walnut Dark Walnut

## PALETTE FINISHES

Black  
White  
Sand  
Soft Green  
Steel Blue  
Slate

## VENEERS

Tate Benches veneers are quarter cut, except for White Oak, which is rift cut - both quarter cut and rift cut veneers provide a straight grain appearance. The grain direction of the veneers on vertical faces is horizontal.

## NON-STANDARD VENEER SPECIES

In addition to range of standard wood species, Tate can be made with virtually any commercially available veneers. Please contact customer service for information and pricing on wood species not included in Tate's standard offering.

## NATURAL CHARACTERISTICS OF WOOD

Wood is a natural product with inherent color variations that will never be fully mitigated by the finishing process. Please anticipate variation in colors within a single unit, from piece to piece, and from Krug wood finish samples. If a very close match is required, a sample must be provided with the order and an upcharge will apply. Exact color matches are not possible.

## CUSTOM WOOD FINISHES







Add 10% list to your order for special finishes, minimum upcharge is \$500 list per finish per order. (For example, on all orders up to \$5000 list, an upcharge of \$500 will apply, on orders \$5000 and up add 10% list to your order.)

For orders with special finishes, a sample that is a minimum 3" by 3" must be received with the order. Special finishes may add additional lead time to production schedules. Since wood is a natural product, some variations in grain, color and stain acceptance will occur. In our finishing processes, we try to minimize variations, but some variation between samples and finished goods should be anticipated.

## ENDURAGUARD FINISH

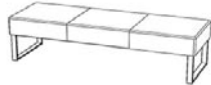
Tate Benches features the Krug Enduraguard finish, a proprietary catalyzed varnish formulation, that has repeatedly shown through independent laboratory testing to be the industry leader in durability and abrasion resistance. The Krug finish looks better longer than competitors and is uniquely suited to the demands of high traffic environments.

# TATE BENCHES | FULLY UPHOLSTERED & GABLE END

DESCRIPTION/MODEL	SPECIES	COM		COL			FABRIC GRADES			LEATHER	
		1	2	3	4	5	6	7	8	9	
 Two-seat, 21", fully upholstered TAT5-2210		992	1042	1088	1152	1228	1294	1370	1463	1558	
 Two-seat, 26", fully upholstered TAT5-2260		1107	1166	1227	1311	1409	1493	1589	1709	1832	
 Three-seat, 21", fully upholstered TAT5-3210		1193	1258	1327	1420	1527	1620	1728	1861	1995	
 Three-seat, 26", fully upholstered TAT5-3260		1315	1395	1478	1589	1717	1832	1959	2119	2281	
 Two-seat, 21", gable end TAT5-2211	Maple, Oak, Laminate	1495	1538	1585	1645	1717	1780	1854	1941	2030	
	Walnut, Palette	1572	1620	1667	1734	1809	1875	1951	2043	2136	
 Two-seat, 26", gable end TAT5-2261	Maple, Oak, Laminate	1622	1678	1736	1817	1908	1989	2080	2195	2310	
	Walnut, Palette	1708	1769	1828	1913	2010	2092	2191	2312	2432	
 Three-seat, 21", gable end TAT5-3211	Maple, Oak, Laminate	1680	1746	1809	1898	1999	2089	2192	2319	2447	
	Walnut, Palette	1771	1837	1905	1998	2106	2198	2307	2441	2576	



## Tate Bench Option Upcharges

	\$ List		\$ List
CAL 133 & Moisture Barrier (per yard)	64	Three-seat, 21" - Removable Seat Covers	97
Two-seat, 21" - Removable Seat Covers	77	Three-seat, 26" - Removable Seat Covers	101
Two-seat, 26" - Removeable Seat Covers	80		

## PRODUCT CODE KEY

Line	Series	Seat Count	Seat Depth	Arm Style
TAT	5	2	21	0
Tate	Bench	Two-Seat	21"	Fully Upholstered
		3	26	1
		Three-Seat	26"	Gable End
				2
				Table End

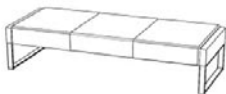
# TATE BENCHES | GABLE END & TABLE END

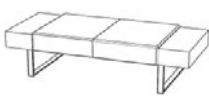
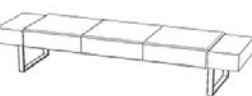
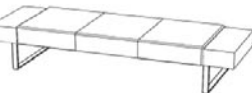
DESCRIPTION/MODEL	SPECIES	COM		COL	FABRIC GRADES			LEATHER			
		1	2	3	4	5	6	7	8	9	
	Three-seat, 26", gable end TAT5-3261	Maple, Oak, Laminate	1832	1907	1984	2090	2212	2319	2443	2594	2746
	Walnut, Palette	1926	2007	2087	2198	2327	2441	2569	2734	2892	
	Two-seat, 21", table end TAT5-2212	Maple, Oak, Laminate	2023	2066	2110	2173	2247	2308	2382	2470	2559
	Walnut, Palette	2131	2174	2221	2287	2364	2431	2505	2597	2692	
	Two-seat, 26", table end TAT5-2262	Maple, Oak, Laminate	2196	2254	2312	2390	2486	2564	2657	2770	2884
	Walnut, Palette	2313	2374	2433	2518	2614	2699	2795	2917	3037	
	Three-seat, 21", table end TAT5-3212	Maple, Oak, Laminate	2210	2274	2337	2427	2529	2618	2718	2848	2972
	Walnut, Palette	2324	2391	2460	2554	2660	2756	2861	2996	3132	
	Three-seat, 26", table end TAT5-3262	Maple, Oak, Laminate	2407	2481	2560	2665	2789	2894	3016	3167	3322
	Walnut, Palette	2532	2612	2694	2805	2934	3047	3175	3339	3497	







### Tate Bench Option Upcharges

	\$ List	\$ List
CAL 133 & Moisture Barrier (per yard)	64	Three-seat, 21" - Removable Seat Covers
Two-seat, 21" - Removable Seat Covers	77	Three-seat, 26" - Removable Seat Covers
Two-seat, 26" - Removable Seat Covers	80	

### PRODUCT CODE KEY

Line	Series	Seat Count	Seat Style	Arm Style
TAT	5	2	21	0
Tate	Bench	Two-Seat	21"	Fully Upholstered
		3	26	1
		Three-Seat	26"	Gable End
				2
				Table End

# TATE BENCHES | REPLACEMENT COMPONENTS

DESCRIPTION/MODEL	COM		COL			FABRIC GRADES			LEATHER			WEIGHT	CUBE
	1	2	3	4	5	6	7	8	9				
 Two-seat, 21" Replacement Seat TAT5-RS221	766	812	861	928	1002	1065	1141	1237	1331	34	4.5		
	832	883	937	1014	1096	1172	1260	1367	1477	43	5.5		
 Three-seat, 21" Replacement Seat TAT5-RS321	961	1031	1096	1193	1298	1393	1440	1634	1769	52	6		
	1045	1121	1201	1307	1431	1538	1663	1817	1970	74	7.3		
 Two-seat, 21" Replacement Seat Covers TAT5-RSC221	302	350	397	460	537	602	678	771	868	5	1.0		
	328	382	434	511	596	670	757	866	973	6	1.2		
 Three-seat, 21" Replacement Seat Covers TAT5-RSC321	391	458	527	620	729	821	929	1063	1198	7	1.5		
	424	501	580	687	809	916	1042	1197	1349	8	1.7		
 Replacement Gable End 21" TAT5-RGE21	Maple, Oak, Laminate	365								4	.30		
	Walnut, Palette	437											
 Replacement Gable End 26" TAT5-RGE26	Maple, Oak, Laminate	409								5	.50		
	Walnut, Palette	515											
 Replacement Table End 21" TAT5-RTE21	Maple, Oak, Laminate	615								11	1.1		
	Walnut, Palette	752											
 Replacement Table End 26" TAT5-RTE26	Maple, Oak, Laminate	672								13	1.3		
	Walnut, Palette	815											
 21" Replacement Legs TAT5-RL21		183								7	1.1		
	26" Replacement Legs TAT5-RL26	199								9	1.5		



## LEED CI CREDITS



MATERIAL CONTENT:

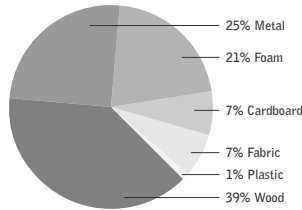

PRE-CONSUMER  
RECYCLED CONTENT = 6.43%

POST-CONSUMER  
RECYCLED CONTENT = 16.25%

Up to 38.93% of this Zola product is recyclable at the end of its useful life.

CONTRIBUTES TO		
CREDIT 2.1 - 2.2	Construction Waste Management	1-2 point(s)
CREDIT 3.3	Resource Reuse	1 point
CREDIT 4.1	Recycled Content	1 point
CREDIT 4.5	Low Emitting Materials, Systems & Seating	1 point
CREDIT 5.1	Regional Materials*	1 point
CREDIT 7	Certified Wood (MUST BE REQUESTED)	1 point(s)

\*This credit is only applicable if in total 20% of the combined value of the procurement of construction materials and in the furniture are manufactured within a radius of 500 miles. This credit will apply if the installation of the finished product occurs within 500 miles of Kitchener, Ontario.

## level® CERTIFICATION, AIR EMISSIONS AND FSC® CERTIFICATION



### level® CERTIFICATION

BIFMA's e3 Furniture Sustainability Standard is a voluntary, multi-attribute standard that measures the degree of sustainability of furniture. This standard evaluates product and company environmental attributes and compliance systems in a wide range of elements which include Materials, Energy & Atmosphere, Human & Ecosystem Health and Social Responsibility. Zola Bench products have earned level®, BIFMA's sustainability certification program for furniture, certification through third-party verification against the e3 standard.



FSC® C021699

The mark of responsible forestry

### AIR EMISSIONS

All Zola Bench products are supplied air emissions-certified. Contact customer service for information.

### FSC®

In 2005, Krug received Forest Stewardship Council® (FSC®) Chain-of-Custody certification for our manufacturing facilities. The FSC® Chain-of-Custody tracks certified wood from seedling to final sale. It verifies that the material for our FSC® certified products only come from well-managed, FSC®-certified forests and other controlled sources. FSC® is dedicated to the promotion of responsible forest management worldwide helping to take care of forests for future generations. Zola and other Krug products can be specified with FSC® Certification. Contact customer service for further information, pricing and lead times.



Architects, designers, and building professionals can specify FSC®-certified products in order to achieve a point from the U.S. Green Building Council's Leadership in Energy and Environmental Design (LEED) Rating System.

## ZOLA | MODULAR & MODULAR PLUS BENCH STANDARD DEPTH

### DIMENSIONS

	Overall Width	Overall Depth	Overall (Seat) Height	Shipping Weight	Cubes
One-Seat	23	22.25	18.5	28	5.2
Two-seat	46	22.25	18.5	48	9.4
Three-seat	69	22.25	18.5	64	14
One-Seat (Plus)	30	22.25	18.5	31	6.1
Two-seat (Plus)	46	22.25	18.5	48	9.4
Three-seat (Plus)	69	22.25	18.5	64	14

### COM YARDAGES

	COM Yardage Bench	COM Yardage 2 Benches	COM Yardage 3 Benches	COM Yardage 4 Benches
One-Seat	1.25	2	2.75	4
Two-seat	1.70	3.5	4.91	6.6
Three-seat	2.5	4.5	7	8.9
One-Seat (Plus)	1.25	2.6	3.98	5.3

To calculate the COM Yardage for more than 4 units, take the largest multiple (4 units) and add the closest remainder. See below for example calculations.

5 Units = Take the yardage for 4 units and add the yardage for 1 unit

7 Units = Take the yardage for 4 units and add the yardage for 3 units

8 Units = Take the yardage for 4 units and multiple by 2

9 Units = Take the yardage for 4 units, multiply by 2, add yardage for 1 unit

10 Units = Take the yardage for 4 units, multiply by 2, add yardage for 2 units

20 Units = Take the yardage for 4 units, multiply by 5

## ZOLA | MODULAR & MODULAR PLUS BENCH FULL DEPTH

### DIMENSIONS

	Overall Width	Overall Depth	Seat Height	Shipping Weight	Cubes
One-Seat	23	27	18.5	33	11.5
Two-seat	46	27	18.5	55	21
Three-seat	69	27	18.5	72	32
One-Seat (Plus)	30	27	18.5	45	16
Two-seat (Plus)	46	27	18.5	57	21
Three-seat (Plus)	69	27	18.5	75	32

### COM YARDAGES

	COM Yardage Bench	COM Yardage 2 Benches	COM Yardage 3 Benches	COM Yardage 4 Benches
One-Seat	1.4	2.2	3.6	4.4
Two-seat	1.85	3.7	5.6	7.4
Three-seat	2.8	5.6	8.4	11.2
One-Seat (Plus)	1.85	3.7	5.6	7.4
Two-seat (Plus)	1.85	3.7	5.6	7.4
Three-seat (Plus)	2.8	5.6	8.4	11.2

To calculate the COM Yardage for more than 4 units, take the largest multiple (4 units) and add the closest remainder. See below for example calculations.

5 Units = Take the yardage for 4 units and add the yardage for 1 unit

7 Units = Take the yardage for 4 units and add the yardage for 3 units

8 Units = Take the yardage for 4 units and multiple by 2

9 Units = Take the yardage for 4 units, multiply by 2, add yardage for 1 unit



10 Units = Take the yardage for 4 units, multiply by 2, add yardage for 2 units

20 Units = Take the yardage for 4 units, multiply by 5

### Upcharge for Removable Upholstery Covers:

Option	\$ List	Option	\$ List
Arms (Right or Left)	77	One-Seat standard depth seat	47
Interim Arm	61	Two-seat standard depth seat	68
One-Seat back	68	Three-seat standard depth seat	85
Two-seat back	97	One-Seat plus standard depth seat	61
Three-seat back	121	One-Seat full depth seat	52
One-Seat plus back	78	Two-seat full depth seat	74
		Three-seat full depth seat	85
		One-Seat plus full depth seat	67

## ZOLA | MODULAR & MODULAR PLUS BENCH STANDARD DEPTH

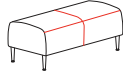
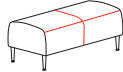
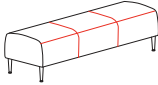
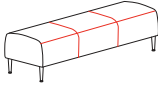
DESCRIPTION/MODEL	COM		COL	FABRIC GRADES			LEATHER			
	1	2	3	4	5	6	7	8	9	
 One-Seat ZOL3 MS1S1	871	916	963	1053	1139	1227	1314	1398	1535	
 One-Seat Plus ZOL3 MSB1S1	1098	1146	1195	1289	1384	1480	1572	1668	1810	
<b>ORDERING NOTES:</b> One-Seat Plus Bench is 30" wide.										
 Two-Seat ZOL3 MS2S1	1218	1272	1330	1447	1566	1685	1803	1922	2118	
 Two-Seat Plus ZOL3 MSB2S1	1297	1359	1422	1540	1662	1778	1897	2017	2214	
<b>ORDERING NOTES:</b> The Two-Seat Plus comes standard with a fifth leg for extra support.										
 Three-Seat ZOL3 MS3S1	1558	1638	1715	1883	2048	2214	2381	2548	2748	
 Three-Seat Plus ZOL3 MSB3S1	1852	1928	2010	2148	2294	2434	2579	2718	2946	
<b>ORDERING NOTES:</b> The Three-Seat Plus comes standard with a fifth leg for extra support.										

## ZOLA | MODULAR & MODULAR PLUS BENCH FULL DEPTH

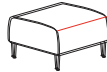
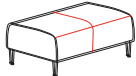
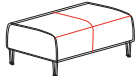
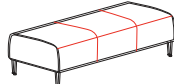
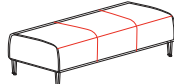
DESCRIPTION/MODEL	COM		COL	FABRIC GRADES			LEATHER			
	1	2	3	4	5	6	7	8	9	
 One-Seat ZOL3 MS1F1	961	1011	1058	1121	1198	1263	1336	1431	1555	
 One-Seat Plus ZOL3 MSB1F1	1158	1222	1284	1371	1467	1557	1657	1778	1905	
<b>ORDERING NOTES:</b> One-Seat Plus Bench is 30" wide.										
 Two-Seat ZOL3 MS2F1	1420	1482	1545	1632	1730	1817	1918	2040	2166	
 Two-Seat Plus ZOL3 MSB2F1	1474	1536	1597	1685	1781	1870	1968	2238	2218	
<b>ORDERING NOTES:</b> The Two-Seat Plus comes standard with a fifth leg for extra support.										
 Three-Seat ZOL3 MS3F1	1921	2016	2108	2236	2388	2522	2671	2859	3047	
 Three-Seat Plus ZOL3 MSB3F1	1988	2085	2176	2310	2460	2591	2742	2928	3117	
<b>ORDERING NOTES:</b> The Three-Seat Plus comes standard with a fifth leg for extra support.										

**ORDERING NOTES:** Zola Bench Seating is available with 4 casters, for an upcharge of **\$107 list** per chair. Please add a '2' at the end of the model number for casters ie; ZOL31112. Zola Bench Seating is available with 2 legs and 2 casters version, for an upcharge of **\$77 list** per chair. Please add a '3' at the end of the model number for leg/caster version ie; ZOL3F1113. Please note, plus versions are not available with caster options.

### PRODUCT CODE KEY

Line	Series	Chair Type	Seat Count	Seat Depth	Leg Type
ZOL Zola	3 Soft Seating	MS Modular	1 One Seat	S Standard Depth	1 Standard Leg & Glide
		MSB Modular Plus	2 Two Seat	F Full Depth	2 Casters
			3 Three Seat		3 2 Legs & 2 Casters

# ZOLA | MODULAR CURVE BENCH

## DIMENSIONS STANDARD DEPTH (INSIDE/OUTSIDE)

	Overall Width	Overall Depth	Seat Height	Seat Depth	Shipping Weight	Cubes
<b>Single seat</b>						
30°	34	24	18.5	22.5	48	18
45°	39	24.5	18.5	22.5	49	19
60°	43.5	25	18.5	22.5	50	22
90°	52	26.5	18.5	22.5	51	26
<b>Double seat</b>						
30°	55.5	25	18.5	22.5	83	32
45°	61	26.5	18.5	22.5	84	33
60°	66.5	28	18.5	22.5	86	39
90°	74	31	18.5	22.5	96	46

## COM YARDAGES

	COM Yardage per Seat	COM Yardage 2 Seats	COM Yardage 3 Seats	COM Yardage 4 Seats
<b>Single seat</b>				
30°	1.8	3.6	5.4	7.2
45°	1.8	3.6	5.4	7.2
60°	1.8	3.6	5.4	7.2
90°	1.8	3.6	5.4	7.2
<b>Double seat</b>				
30°	3.4	6.8	10.2	13.6
45°	3.4	6.8	10.2	13.6
60°	3.4	6.8	10.2	13.6
90°	3.4	6.8	10.2	13.6

## SINGLE SEAT

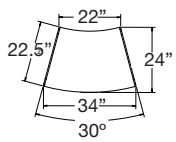

30° Curve

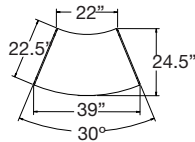

45° Curve

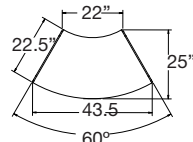

60° Curve

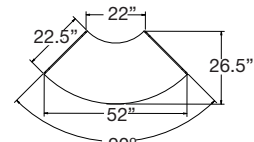

90° Curve

## DOUBLE SEAT

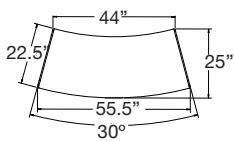

30° Curve

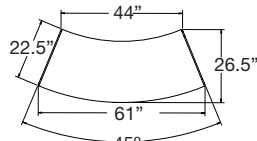

45° Curve

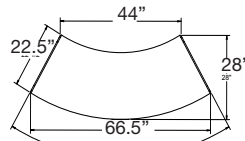

60° Curve

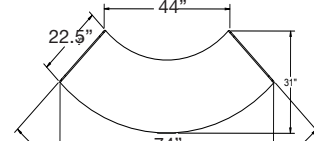

90° Curve

## UPCHARGE FOR REMOVABLE UPHOLSTERY COVERS

Option	\$ List	Option	\$ List
Single-seat curve 30° seat	61	Double-seat curve 30° seat	93
Single-seat curve 45° seat	64	Double-seat curve 45° seat	101
Single-seat curve 60° seat	86	Double-seat curve 60° seat	123
Single-seat curve 90° seat	113	Double-seat curve 90° seat	126

# ZOLA | MODULAR CURVE BENCH

## DIMENSIONS FULL DEPTH (INSIDE/OUTSIDE)

	Overall Width	Overall Depth	Seat Height	Seat Depth	Shipping Weight	Cubes
<b>Single seat</b>						
30°	36	28.5	18.5	27	50	23
45°	42	28.5	18.5	27	54	24
60°	48	29	18.5	27	57	29
90°	59	31	18.5	27	69	34
<b>Double seat</b>						
30°	58	30	18.5	27	90	36
45°	64	31	18.5	27	97.2	40
60°	70	33	18.5	27	102.6	45
90°	81	36	18.5	27	124.2	56

## COM Yardages

	COM Yardage Entire Unit	COM Yardage 2 Entire Units	COM Yardage 3 Entire Units	COM Yardage 4 Entire Units
<b>Single seat</b>				
30°	1.94	3.88	5.82	7.76
45°	1.94	3.88	5.82	7.76
60°	1.94	3.88	5.82	7.76
90°	1.94	3.88	5.82	7.76
<b>Double seat</b>				
30°	3.7	7.4	11.1	14.8
45°	3.7	7.4	11.1	14.8
60°	3.7	7.4	11.1	14.8
90°	3.7	7.4	11.1	14.8

## SINGLE SEAT

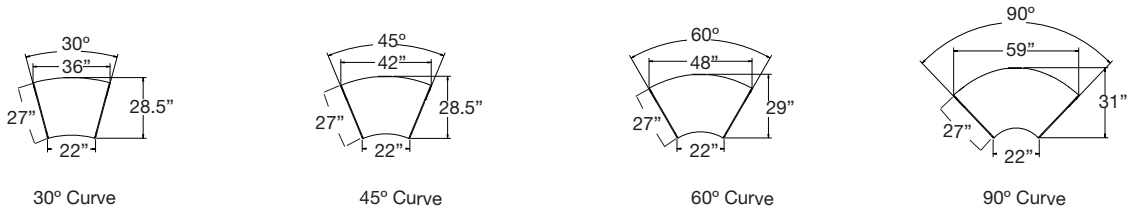



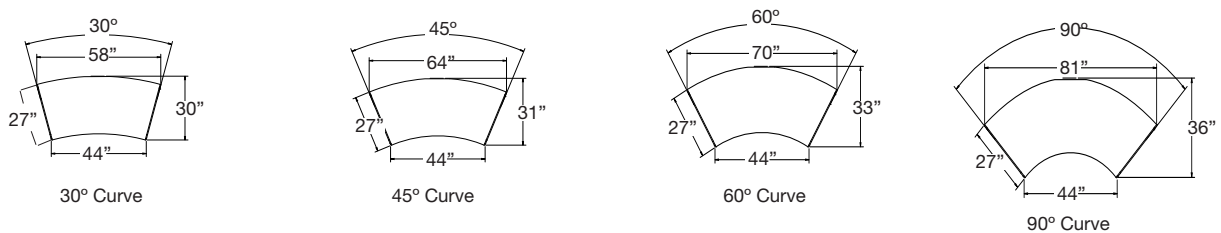



## DOUBLE SEAT

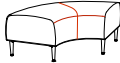

## UPCHARGE FOR REMOVABLE UPHOLSTERY COVERS

Option	\$ List	Option	\$ List
Single-seat curve 30° seat	61	Double-seat curve 30° seat	93
Single-seat curve 45° seat	64	Double-seat curve 45° seat	101
Single-seat curve 60° seat	86	Double-seat curve 60° seat	123
Single-seat curve 90° seat	113	Double-seat curve 90° seat	126

# ZOLA | MODULAR CURVE BENCH

DESCRIPTION/MODEL	COM		COL	FABRIC GRADES			LEATHER		
	1	2	3	4	5	6	7	8	9
 Single-Seat, 30° Curve, Standard Depth ZOL3 MCS30DS1	1251	1361	1478	1634	1813	1970	2149	2378	2602
 Single-Seat, 45° Curve, Standard Depth ZOL3 MCS45DS1	1361	1528	1691	1922	2186	2415	2678	3008	3336
 Single-Seat, 60° Curve, Standard Depth ZOL3 MCS60DS1	1539	1705	1869	2100	2360	2591	2854	3184	3513
 Single-Seat, 90° Curve, Standard Depth ZOL3 MCS90DS1	1776	1956	2136	2390	2681	2934	3222	3587	3949
 Single-Seat, 30° Curve, Full Depth ZOL3 MCS30DF1	1376	1499	1623	1797	1995	2168	2368	2613	2861
 Single-Seat, 45° Curve, Full Depth ZOL3 MCS45DF1	1501	1680	1861	2113	2405	2657	2946	3307	3669
 Single-Seat, 60° Curve, Full Depth ZOL3 MCS60DF1	1693	1875	2056	2308	2596	2851	3138	3501	3864
 Single-Seat, 90° Curve, Full Depth ZOL3 MCS90DF1	1954	2149	2352	2631	2948	3229	3545	3946	4343

**ORDERING NOTES:** Please note when Zola Modular Benches are ordered, each bench is automatically supplied with two seat to seat brackets (ZOL3 RLKB2). All Modular Units, and tables will be shipped KD (knocked down). Modular Curved Benches are offered in two depths. For a flush edge when joining a Modular Curved Bench to Modular seat with back choose the Full Depth.

## PRODUCT CODE KEY

Line	Series	Chair Type	Seat Count	Seat Degree	Seat Depth	Leg Type
ZOL Zola	3 Soft Seating	MC Modular	S Single	30D 30 Degree	S Standard	1 Standard Leg + Glide
		MCB Modular Plus	D Double	45D 45 Degree	F Full	
				60D 60 Degree		
				90D 90 Degree		

# ZOLA | MODULAR CURVE BENCH

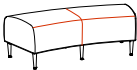
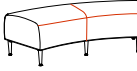
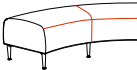
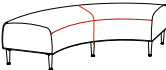
DESCRIPTION/MODEL	COM		COL		FABRIC GRADES			LEATHER		
	1	2	3	4	5	6	7	8	9	
 Double-Seat, 30° Curve, Standard Depth ZOL3 MCD30DS1	2190	2385	2584	2858	3173	3452	3766	4160	4555	
 Double-Seat, 45° Curve, Standard Depth ZOL3 MCD45DS1	2385	2672	2959	3363	3820	4223	4684	5259	5834	
 Double-Seat, 60° Curve, Standard Depth ZOL3 MCD60DS1	2694	2983	3269	3671	4131	4533	4994	5569	6142	
 Double-Seat, 90° Curve, Standard Depth ZOL3 MCD90DS1	3105	3424	3740	4184	4691	5135	5640	6273	6909	

## Upcharge for Removable Upholstery Covers:



Option	\$ List
Double-seat curve 30° seat	93
Double-seat curve 45° seat	101
Double-seat curve 60° seat	123
Double-seat curve 90° seat	127

**ORDERING NOTES:** Please note when Zola Modular Benches are ordered, each bench is automatically supplied with two seat to seat brackets (ZOL3 RLKB2). All Modular Units, and tables will be shipped KD (knocked down). Modular Curved Benches are offered in two depths. For a flush edge when joining a Modular Curved Bench to Modular seat with back choose the Full Depth.

## PRODUCT CODE KEY

Line	Series	Chair Type	Seat Count	Seat Degree	Seat Depth	Leg Type
ZOL Zola	3 Soft Seating	MC Modular	S Single	30D 30 Degree	S Standard	1 Standard Leg + Glide
		MCB Modular Plus	D Double	45D 45 Degree	F Full	
				60D 60 Degree		
				90D 90 Degree		

# ZOLA | MODULAR CURVE BENCH

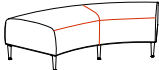
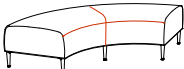
DESCRIPTION/MODEL	COM		COL			FABRIC GRADES			LEATHER	
	1	2	3	4	5	6	7	8	9	
 Double-Seat, 30° Curve, Full Depth ZOL3 MCD30DF1	2516	2742	2969	3287	3648	3966	4331	4784	5236	
 Double-Seat, 45° Curve, Full Depth ZOL3 MCD45DF1	2742	3073	3403	3866	4395	4859	5388	6048	6709	
 Double-Seat, 60° Curve, Full Depth ZOL3 MCD60DF1	3099	3429	3760	4221	4752	5214	5742	6405	7066	
 Double-Seat, 90° Curve, Full Depth ZOL3 MCD90DF1	3573	3935	4297	4812	5393	5904	6486	7215	7945	

### Upcharge for Removable Upholstery Covers:

Option	\$ List
Double-seat curve 30° seat	93
Double-seat curve 45° seat	101
Double-seat curve 60° seat	123
Double-seat curve 90° seat	127









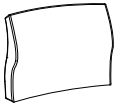

**ORDERING NOTES:** Please note when Zola Modular Benches are ordered, each bench is automatically supplied with two seat to seat brackets (ZOL3 RLKB2). All Modular Units, and tables will be shipped KD (knocked down). Modular Curved Benches are offered in two depths. For a flush edge when joining a Modular Curved Bench to Modular seat with back choose the Full Depth.

### PRODUCT CODE KEY



Line	Series	Chair Type	Seat Count	Seat Degree	Seat Depth	Leg Type
ZOL Zola	3 Soft Seating	MC Modular	S Single	30D 30 Degree	S Standard	1 Standard Leg + Glide
		MCB Modular Plus	D Double	45D 45 Degree	F Full	
				60D 60 Degree		
				90D 90 Degree		



# ZOLA | MODULAR CURVE BENCH - REPLACEMENT COMPONENTS

DESCRIPTION	MODEL	COM		COL			FABRIC GRADES			LEATHER			COM	
		1	2	3	4	5	6	7	8	9	YARDAGE	WEIGHT	CUBE	
	Replacement Back Single-seat Inside Curve													
	ZOL3 RMCBIS30D	1168	1247	1330	1443	1569	1686	1815	1977	2136	1.9	20	8	
	ZOL3 RMCBIS45D	1355	1443	1533	1659	1801	1924	2066	2244	2423	2.6	22	8	
	ZOL3 RMCBIS60D	1647	1772	1893	2064	2257	2431	2628	2870	3113	2.6	23	10	
	ZOL3 RMCBIS90D	1841	1967	2094	2272	2476	2652	2854	3109	3363	2.8	28	11	
	Replacement Back Double-seat Inside Curve													
	ZOL3 RMCBID30D	2042	2185	2324	2524	2747	2947	3172	3456	3739	2.8	38	13	
	ZOL3 RMCBID45D	2369	2524	2681	2898	3147	3367	3617	3929	4239	3	42	13.5	
	ZOL3 RMCBID60D	2884	3099	3313	3610	3954	4252	4595	5022	5448	4.8	43	16	
	ZOL3 RMCBID90D	3220	3444	3665	3975	4331	4641	4995	5440	5884	4.8	52.5	18	
	Replacement Back Single-seat Outside Curve													
	ZOL3 RMCBOS30D	1053	1122	1197	1298	1415	1515	1633	1778	1923	1.7	15	5.0	
	ZOL3 RMCBOS45D	1218	1298	1380	1492	1620	1732	1861	2020	2182	1.7	17	7.0	
	ZOL3 RMCBOS60D	1458	1593	1704	1858	2033	2190	2361	2584	2803	1.7	20	9.0	
	ZOL3 RMCBOS90D	1659	1772	1885	2045	2228	2386	2569	2798	3028	1.7	25	9.0	
	Replacement Back Double-seat Outside Curve													
	ZOL3 RMCBOD30D	1839	1965	2092	2271	2473	2652	2857	3111	3366	3.1	30	9.0	
	ZOL3 RMCBOD45D	2133	2272	2412	2610	2833	3030	3252	3535	3816	3.1	34	11.0	
	ZOL3 RMCBOD60D	2596	2789	2983	3249	3559	3827	4133	4520	4903	3.1	35	14.0	
	ZOL3 RMCBOD90D	2898	3099	3299	3578	3896	4177	4498	4897	5295	3.1	40	14.0	
	Replacement Seat Single-seat Standard Depth Curve													
	ZOL3 RMCSS30DS	1143	1258	1372	1529	1708	1866	2046	2272	2496	1.8	30	11	
	ZOL3 RMCSS45DS	1258	1421	1443	1816	2080	2312	2570	2902	3231	1.8	32	12	
	ZOL3 RMCSS60DS	1437	1598	1765	1993	2255	2487	2747	3077	3408	1.8	34	13	
	ZOL3 RMCSS90DS	1636	1816	1998	2252	2539	2794	3082	3446	3809	1.8	41	16	
	Replacement Seat Double-seat Standard Depth Curve													
	ZOL3 RMCSD30DS	2084	2280	2478	2751	3069	3344	3662	4057	4449	3.4	52.2	19.5	
	ZOL3 RMCSD45DS	2280	2567	2854	3257	3714	4118	4579	5605	5727	3.4	56	21	
	ZOL3 RMCSD60DS	2589	2878	3163	3565	4027	4427	4888	5464	6039	3.4	60	23	
	ZOL3 RMCSD90DS	2966	3283	3602	4042	4551	4994	5502	6136	6767	3.4	72	28	
	Replacement Seat Single-seat Full Depth Curve													
	ZOL3 RMCSS30DF	1270	1393	1518	1691	1890	2063	2263	2507	2757	1.94	36	13.5	
	ZOL3 RMCSS45DF	1394	1573	1755	2010	2298	2552	2839	3202	3563	1.94	39	14.5	
	ZOL3 RMCSS60DF	1589	1771	1951	2202	2492	2744	3035	3397	3759	1.94	41	15.5	
	ZOL3 RMCSS90DF	1813	2012	2211	2491	2807	3090	3405	3804	4205	1.94	49	19	
	Replacement Seat Double-seat Full Depth Curve													
	ZOL3 RMCSD30DF	2410	2637	2863	3182	3543	3862	4223	4678	5131	3.7	63	24	
	ZOL3 RMCSD45DF	2637	2968	3297	3761	4289	4754	5281	5941	6603	3.7	69	25.5	
	ZOL3 RMCSD60DF	2992	3322	3654	4116	4645	5109	5636	6297	6960	3.7	72	27	
	ZOL3 RMCSD90DF	3431	3795	4160	4669	5256	5764	6347	7074	7806	3.7	86	33.5	
	Replacement Seat Cover Single-seat Standard Depth Curve													
	ZOL3 RMCBSCS30DS	223	279	337	416	510	590	680	796	912	1.8	2.5	1	
	ZOL3 RMCBSCS45DS	229	286	344	424	516	597	689	805	917	1.8	3.1	1	
	ZOL3 RMCBSCS60DS	265	321	380	458	552	632	725	840	955	1.8	3.7	1.5	
	ZOL3 RMCBSCS90DS	287	345	404	483	573	655	746	864	978	1.8	4.3	1.5	
	Replacement Seat Cover Double-seat Standard Depth Curve													
	ZOL3 RMCBSCD30DS	388	494	603	757	930	1083	1257	1474	1691	3.4	4.8	1.5	
	ZOL3 RMCBSCD45DS	394	507	614	765	939	1090	1265	1482	1698	3.4	5.9	1.5	
	ZOL3 RMCBSCD60DS	446	556	664	815	988	1140	1314	1533	1748	3.4	7.0	2.5	
	ZOL3 RMCBSCD90DS	464	571	679	833	1008	1161	1333	1551	1768	3.4	8.2	2.5	

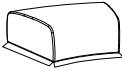
# ZOLA | MODULAR CURVE - REPLACEMENT COMPONENTS

DESCRIPTION	MODEL	COM		COL	FABRIC GRADES			LEATHER			COM		
		1	2	3	4	5	6	7	8	9	YARDAGE	WEIGHT	CUBE
	Replacement Seat Cover Single-seat Full Depth Curve												
	ZOL3 RMCBSCS30DF	246	312	380	470	571	665	768	898	1030	1.94	2.9	1
	ZOL3 RMCBSCS45DF	256	320	386	478	582	672	778	906	1036	1.94	3.6	1
	ZOL3 RMCBSCS60DF	295	359	424	515	620	710	812	943	1073	1.94	4.3	1.5
	ZOL3 RMCBSCS90DF	313	380	444	536	640	730	835	962	1094	1.94	4.9	1.5
	Replacement Seat Cover Double-seat Full Depth Curve												
	ZOL3 RMCBSCD30DF	433	557	680	853	1054	1228	1423	1672	1922	3.7	5.5	1.5
	ZOL3 RMCBSCD45DF	441	565	689	865	1062	1236	1434	1683	1929	3.7	6.8	1.5
	ZOL3 RMCBSCD60DF	493	619	743	915	1116	1289	1487	1735	1984	3.7	8.1	2.5
	ZOL3 RMCBSCD90DF	530	654	778	952	1147	1320	1522	1771	2017	3.7	9.4	2.5

# CARLYLE BENCH | ENVIRONMENTAL SUMMARY

## LEED CI CREDITS



MATERIAL CONTENT:

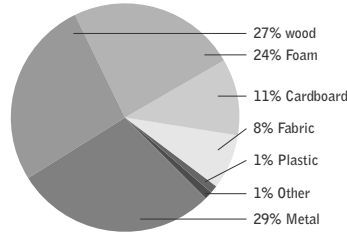

PRE-CONSUMER  
RECYCLED CONTENT = 15%

POST-CONSUMER  
RECYCLED CONTENT = 17.97%

Up to 49.33% of this Carlyle product is recyclable at the end of its useful life.

### CONTRIBUTES TO

CREDIT 2.1 - 2.2	Construction Waste Management	1-2 point(s)
CREDIT 3.3	Resource Reuse	1 point
CREDIT 4.1	Recycled Content	1 point
CREDIT 4.2	Recycled Content	1 point
CREDIT 4.5	Low Emitting Materials, Systems & Seating	1 point
CREDIT 5.1	Regional Materials*	1 point
CREDIT 7	Certified Wood (MUST BE REQUESTED)	1 point(s)

\*This credit is only applicable if in total 20% of the combined value of the procurement of construction materials and in the furniture are manufactured within a radius of 500 miles. This credit will apply if the installation of the finished product occurs within 500 miles of Kitchener, Ontario.

## level® CERTIFICATION, AIR EMISSIONS AND FSC® CERTIFICATION



### level® CERTIFICATION

BIFMA's e3 Furniture Sustainability Standard is a voluntary, multi-attribute standard that measures the degree of sustainability of furniture. This standard evaluates product and company environmental attributes and compliance systems in a wide range of elements which include Materials, Energy & Atmosphere, Human & Ecosystem Health and Social Responsibility. Carlyle products have earned level®, BIFMA's sustainability certification program for furniture, certification through third-party verification against the e3 standard.

### AIR-EMISSIONS

All Carlyle products are supplied with air-emissions certified. Contact customer service for information.



### FSC®

In 2005, Krug received Forest Stewardship Council® (FSC®) Chain-of-Custody certification for our manufacturing facilities. The FSC® Chain-of-Custody tracks certified wood from seedling to final sale. It verifies that the material for our FSC® certified products only come from well-managed, FSC®-certified forests and other controlled sources. FSC® is dedicated to the promotion of responsible forest management worldwide helping to take care of forests for future generations. Carlyle and other Krug products can be specified with FSC® Certification. Contact customer service for further information, pricing and lead times.



Architects, designers, and building professionals can specify FSC®-certified products in order to achieve a point from the U.S. Green Building Council's Leadership in Energy and Environmental Design (LEED) Rating System.

# CARLYLE BENCH

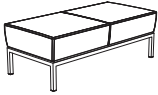
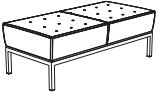
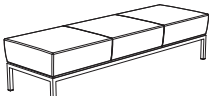
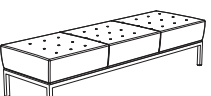
DESCRIPTION/MODEL	COM		COL		FABRIC GRADES			LEATHER	
	1	2	3	4	5	6	7	8	9
 TWO-SEAT CAR5-2-0	1713	1798	1884	1971	2063	2157	2249	2369	2541
 TWO-SEAT - BUTTON DETAILING CAR5-2-1	2209	2294	2381	2465	2559	2649	2743	2861	3037
 THREE-SEAT CAR5-3-0	2253	2377	2493	2612	2734	2852	2972	3117	3503
 THREE-SEAT - BUTTON DETAILING CAR5-3-1	3017	3140	3257	3378	3497	3614	3738	3881	4267

## DIMENSIONS & COM REQUIREMENTS

	Overall Width	Overall Depth	Overall Height	Seat Height	Height of Arms from Floor	Width between Arms	Seat Depth	Shipping Weight	Cube	COM Yardage
<b>CAR5-2-0</b>	54	26.5	17.5	-	-	-	-	75	16	2.4
<b>CAR5-2-1</b>	54	26.5	17.5	-	-	-	-	75	16	2.4
<b>CAR5-3-0</b>	81	26.5	17.5	-	-	-	-	110	25	3.6
<b>CAR5-3-1</b>	81	26.5	17.5	-	-	-	-	110	25	3.6

### PRODUCT CODE KEY

Line	Series	Seat Count	Upholstery Style
CAR	5	2	0
Carlyle	Bench	Two-Seat	Upholstery Standard
		3	1
		Three-Seat	Top Stitching and Buttons

### CARLYLE

Base is available in Silver Metallic only.

### MOISTURE BARRIER & CAL 133

Moisture Barrier & CAL 133 is available for an upcharge of **\$64 list** per yard.

## OCCASIONAL TABLES

293	Chit Chat
296	Avatar
298	Karma
303	Cressida
306	Leyton
308	Faeron Wood
310	Faeron Metal
312	Zola
317	Sutton
319	Virtu
321	Millennium
323	Prado
325	Carlyle

# CHIT CHAT | ENVIRONMENTAL SUMMARY

## LEED CI CREDITS

MATERIAL CONTENT:

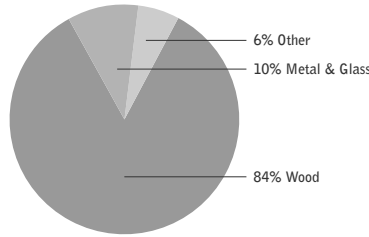

PRE-CONSUMER RECYCLED CONTENT = 81%

POST-CONSUMER RECYCLED CONTENT = 3%

CONTRIBUTES TO

CREDIT 2.1 - 2.2	Construction Waste Management	1-2 point(s)
CREDIT 3.3	Resource Reuse	1 point
CREDIT 4.1	Recycled Content	1 point
CREDIT 4.2	Recycled Content	1 point
CREDIT 4.5	Low Emitting Materials, Systems & Seating	1 point
CREDIT 5.1	Regional Materials*	1 point
CREDIT 7	Certified Wood (MUST BE REQUESTED)	1 point(s)

\*This credit is only applicable if in total 20% of the combined value of the procurement of construction materials and in the furniture are manufactured within a radius of 500 miles. This credit will apply if the installation of the finished product occurs within 500 miles of Kitchener, Ontario.

## level® CERTIFICATION, AIR EMISSIONS AND FSC® CERTIFICATION



### level® CERTIFICATION

BIFMA's e3 Furniture Sustainability Standard is a voluntary, multi-attribute standard that measures the degree of sustainability of furniture. This standard evaluates product and company environmental attributes and compliance systems in a wide range of elements which include Materials, Energy & Atmosphere, Human & Ecosystem Health and Social Responsibility. Chit Chat products have earned level®, BIFMA's sustainability certification program for furniture, certification through third-party verification against the e3 standard.

### AIR-EMISSIONS

All Chit Chat products are supplied with air-emissions certified. Contact customer service for information.



### FSC®

In 2005, Krug received Forest Stewardship Council® (FSC®) Chain-of-Custody certification for our manufacturing facilities. The FSC® Chain-of-Custody tracks certified wood from seedling to final sale. It verifies that the material for our FSC® certified products only come from well-managed, FSC®-certified forests and other controlled sources. FSC® is dedicated to the promotion of responsible forest management worldwide helping to take care of forests for future generations. Chit Chat and other Krug products can be specified with FSC® Certification. Contact customer service for further information, pricing and lead times.



Architects, designers, and building professionals can specify FSC®-certified products in order to achieve a point from the U.S. Green Building Council's Leadership in Energy and Environmental Design (LEED) Rating System.

# CHIT CHAT | PRODUCT FEATURES & OPTIONS

## TOP SHAPE & GRAIN DIRECTION

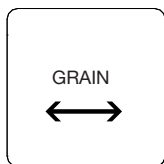

Square

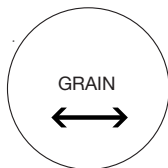

Round

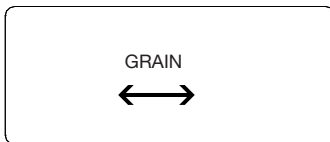

Rectangle

## EDGE PROFILES



Flat Edge - T



Radius Edge - D

Chit Chat Table tops are 1-1/4" thick and available in two edge profiles.  
**Note:** Solid Surface is only available in the D Radius edge profile.

## BASES

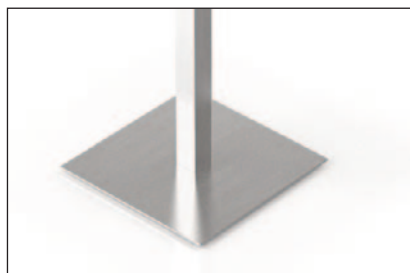

Chit Chat Table bases are available in Brushed Stainless Steel, Matte Black or White finishes with non-marring glides.

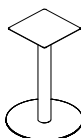

Cylindrical column with disc base

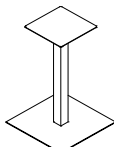

Square column with square base



Brushed Stainless Steel (-13)



Matte Black (-14)



White (-44)

## SOLID SURFACE

The Solid Surface option provides an enhanced durability, protection and cleanability. It is available in 8 standard colors and is replaceable if it becomes damaged or degraded. See individual products for list upcharge chart.

## DIMENSIONS

Model	Width	Depth	Height	Shipping Weight	Cubes
<b>Occasional</b>					
Square Table -Rounded Corners					
7261242416	24	24	16	35	10.25
7261303016	30	30	16	40	15
7261363616	36	36	16	47	20.5
Rectangular Table -Rounded Corners					
7261233016	23	30	16	37	12.5
7261243016	24	30	16	37	12.5
7261463016	45.75	30	16	54	21.75
7261483016	48	30	16	75	22.75
7261693016	68.75	30	16	91	31.5
7261723016	72	30	16	107	32.75
Round Table					
72052416	24D		16	35	10.25
72053016	30D		16	40	15
72053616	36D		16	57	20.5

# CHIT CHAT | OCCASIONAL

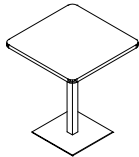
DESCRIPTION/MODEL		Laminate PVC Edge	HPL PVC Edge	Solid Surface top Grade A - White	Solid Surface top Grade A - Color	Solid Surface top Grade B	Solid Surface top Grade C
Square Table, -Rounded Corners  	Square Plate Base						
	7261242416SQ	868	1041	1380	1465	1570	1731
	7261303016SQ	937	1124	1569	1671	1835	2058
	7261363616SQ	1068	1284	2060	2201	2449	2778

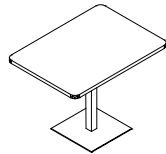
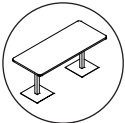
Rectangular Table, -Rounded Corners    	Square Plate Base						
	7261233016SQ	885	1062	1458	1551	1672	1856
	7261243016SQ	885	1062	1458	1551	1672	1856
	7261463016SQ	1386	1663	2377	2522	2778	3114
	7261483016SQ	1416	1699	2458	2609	2878	3231
	7261693016SQ	1535	1841	3157	3370	3741	4231
	7261723016SQ	1570	1884	3274	3501	3890	4404
	Round Disc Base						
	7261233016DB	851	1020	1422	1515	1640	1821
	7261243016DB	851	1020	1422	1515	1640	1821
	7261463016DB	1317	1582	2310	2455	2712	3047
	7261483016DB	1351	1620	2390	2541	2810	3163
	7261693016DB	1465	1758	3089	3304	3672	4163
7261723016DB	1505	1804	3208	3433	3822	4337	

### ORDERING NOTES:

Rectangular Chit Chat Tables 46" (45.75) and longer include two bases. Please note table sizes 23", 46" & 69" (68.75) coordinate with all Zola one, two and three-seat Benches.

Round Table  	Round Disc Base						
	72052416DB	834	1002	1320	1405	1530	1705
	72053016DB	900	1081	1507	1609	1802	2033
	72053616DB	1042	1251	1999	2136	2312	2434

Model		Price		Shipping Weight	Cubes
Square Plate Base  	72541815	344		37	1.1
	72542415	404		58	1.4

### ORDERING NOTES:

A single 18" base can be used with tops up to a maximum of 30 inches.

Round Disc Base  	72141815	309		37	1.1
	72142415	380		58	1.4

### ORDERING NOTES:

A single 18" base can be used with tops up to a maximum of 30 inches.

### ORDERING PROCEDURE

To order please specify the following:

1. Select model number
2. Select top material
3. Select a color for top
4. Select base finish
5. Select edge profile

### BASE FINISH

Round Disc Base, Brushed Stainless- DB-13  
 Square Plate Base, Brushed Stainless- SQ-13  
 Round Disc Base, White- DB-44  
 Square Plate Base, White- SQ-44  
 Round Disc Base, Matte Black- DB-14  
 Square Plate Base, Matte Black- SQ-14

### MATERIALS & FINISHES

For a complete list of Solid Surface colors please see page 336. Solid Surface is only available in the D Radius edge profile.

For a complete list of Laminate colors please see page 336..



LEED CI CREDITS



MATERIAL CONTENT:

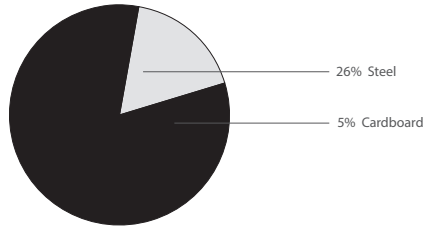

PRE-CONSUMER RECYCLED CONTENT = 48.95%

POST-CONSUMER RECYCLED CONTENT = 20.26%

Up to 61.05% of this Avatar product is recyclable at the end of its useful life.

CONTRIBUTES TO

CREDIT 2.1 - 2.2	Construction Waste Management	1-2 point(s)
CREDIT 3.3	Resource Reuse	1 point
CREDIT 4.1	Recycled Content	1 point
CREDIT 4.2	Recycled Content	1 point
CREDIT 4.5	Low Emitting Materials, Systems & Seating	1 point
CREDIT 5.1	Regional Materials*	1 point
CREDIT 7	Certified Wood (MUST BE REQUESTED)	1 point(s)

\*This credit is only applicable if in total 20% of the combined value of the procurement of construction materials and in the furniture are manufactured within a radius of 500 miles. This credit will apply if the installation of the finished product occurs within 500 miles of Kitchener, Ontario.

level® CERTIFICATION, AIR EMISSIONS AND FSC® CERTIFICATION



level® CERTIFICATION

BIFMA's e3 Furniture Sustainability Standard is a voluntary, multi-attribute standard that measures the degree of sustainability of furniture. This standard evaluates product and company environmental attributes and compliance systems in a wide range of elements which include Materials, Energy & Atmosphere, Human & Ecosystem Health and Social Responsibility. Avatar products have earned level®, BIFMA's sustainability certification program for furniture, certification through third-party verification against the e3 standard.

AIR-EMISSIONS

All Avatar products are supplied with air-emissions certified. Contact customer service for information.







FSC®

In 2005, Krug received Forest Stewardship Council® (FSC®) Chain-of-Custody certification for our manufacturing facilities. The FSC® Chain-of-Custody tracks certified wood from seedling to final sale. It verifies that the material for our FSC® certified products only come from well-managed, FSC®-certified forests and other controlled sources. FSC® is dedicated to the promotion of responsible forest management worldwide helping to take care of forests for future generations. Avatar and other Krug products can be specified with FSC® Certification. Contact customer service for further information, pricing and lead times.



Architects, designers, and building professionals can specify FSC®-certified products in order to achieve a point from the U.S. Green Building Council's Leadership in Energy and Environmental Design (LEED) Rating System.

## AVATAR | TABLES

Description	Model	Rift Oak	W	D	H	WEIGHT	CUBE
	Square						
	AVA4-S181817	1148	18	18	17	24	6.6
	AVA4-S222217	1240	22	22	17	29	9
	Rectangular						
	AVA4-R442217	2011	44	22	17	53	16
	Round						
	AVA4-R18D17	1146	18	18	17	23	6.6
	AVA4-R22D17	1232	22	22	17	27	9
	Elliptical						
	AVA4-E442217	2006	44	22	17	53	16

## AVATAR | VENEERS & FINISHES

### WOOD FINISHES

Standard wood finishes are:

#### Finishes on Rift Oak

Light Oak  
Harvest Oak  
SilverGrey on Oak  
Mahogany Oak  
Medium Cherry on Oak  
Mellow Oak  
Walnut on Oak  
Espresso on Oak

### VENEERS

Avatar veneers are rift cut White Oak, which provides a straight grain appearance.

#### NON-STANDARD VENEER SPECIES

In addition to range of standard wood species, Avatar can be made with virtually any commercially available veneers. Please contact customer service for information and pricing on wood species not included in Avatar's standard offering.

#### NATURAL CHARACTERISTICS OF WOOD

Wood is a natural product with inherent color variations that will never be fully mitigated by the finishing process. Please anticipate variation in colors within a single unit, from piece to piece, and from Krug wood finish samples. If a very close match is required, a sample must be provided with the order and an upcharge will apply. Exact color matches are not possible.

#### CUSTOM WOOD FINISHES

Add 10% list to your order for special finishes, minimum upcharge is \$500 list per finish per order. (For example, on all orders up to \$5000 list, an upcharge of \$500 will apply, on orders \$5000 and up add 10% list to your order.)

For orders with special finishes, a sample that is a minimum 3" by 3" must be received with the order. Special finishes may add additional lead time to production schedules. Since wood is a natural product, some variations in grain, color and stain acceptance will occur. In our finishing processes, we try to minimize variations, but some variation between samples and finished goods should be anticipated.

#### FINISH

Avatar features the Krug's finish, a proprietary catalyzed varnish formulation, that has repeatedly shown through independent laboratory testing to be the industry leader in durability and abrasion resistance. The Krug finish looks better longer than competitors and is uniquely suited to the demands of high traffic environments.

## LEED CI CREDITS



### MATERIAL CONTENT:

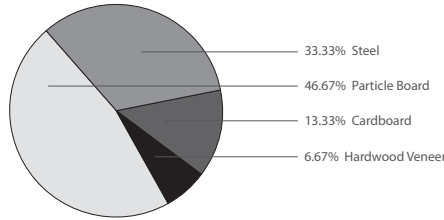

PRE-CONSUMER  
RECYCLED CONTENT = 29.17%

POST-CONSUMER  
RECYCLED CONTENT = 42.67%

Up to 46.67% of this Karma product is recyclable at the end of its useful life.

### CONTRIBUTES TO

CREDIT 2.1 - 2.2	Construction Waste Management	1-2 point(s)
CREDIT 3.3	Resource Reuse	1 point
CREDIT 4.1	Recycled Content	1 point
CREDIT 4.2	Recycled Content	1 point
CREDIT 4.5	Low Emitting Materials, Systems & Seating	1 point
CREDIT 5.1	Regional Materials*	1 point
CREDIT 7	Certified Wood (MUST BE REQUESTED)	1 point(s)

\*This credit is only applicable if in total 20% of the combined value of the procurement of construction materials and in the furniture are manufactured within a radius of 500 miles. This credit will apply if the installation of the finished product occurs within 500 miles of Kitchener, Ontario.

## level® CERTIFICATION, AIR EMISSIONS AND FSC® CERTIFICATION



### level® CERTIFICATION

BIFMA's e3 Furniture Sustainability Standard is a voluntary, multi-attribute standard that measures the degree of sustainability of furniture. This standard evaluates product and company environmental attributes and compliance systems in a wide range of elements which include Materials, Energy & Atmosphere, Human & Ecosystem Health and Social Responsibility. Karma products have earned level®, BIFMA's sustainability certification program for furniture, certification through third-party verification against the e3 standard.



The mark of responsible forestry

### AIR EMISSIONS

All Karma products are supplied air-emissions certified. Contact customer service for information.

### FSC®

In 2005, Krug received Forest Stewardship Council® (FSC®) Chain-of-Custody certification for our manufacturing facilities. The FSC® Chain-of-Custody tracks certified wood from seedling to final sale. It verifies that the material for our FSC® certified products only come from well-managed, FSC®-certified forests and other controlled sources. FSC® is dedicated to the promotion of responsible forest management worldwide helping to take care of forests for future generations. Karma and other Krug products can be specified with FSC® Certification. Contact customer service for further information, pricing and lead times.



Architects, designers, and building professionals can specify FSC®-certified products in order to achieve a point from the US Green Building Council's Leadership in Energy and Environmental Design (LEED) Rating System.

## KARMA | FREE STANDING TABLES

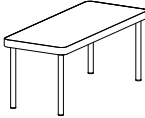
Description	Model	Beech/ Palette	Laminate top w/Wood Edge	Laminate top w/ Polymer Edge	W	D	H	Weight	Cube	
	Square & Rectangular Tables, Matte Black or Silver Metallic legs									
	KAR4C 18-18-18	746	904	601	17.5	17.5	17.5	15	2.6	
	KAR4C 22-18-18	783	929	618	22	17.5	17.5	16.5	2.6	
	KAR4C 42-18-18	1177	1458	1042	42	17.5	17.5	24.5	4.6	
	KAR4C 18-18-21	763	915	618	17.5	17.5	21	17	3	
	KAR4C 22-18-21	799	942	632	22	17.5	21	18.5	3	
	KAR4C 42-18-21	1193	1474	1056	42	17.5	21	26.5	4.6	
	Square & Rectangular Tables, Polished Chrome legs									
	KAR4C 18-18-18	882	1036	735	17.5	17.5	17.5	15	2.6	
	KAR4C 22-18-18	917	1062	751	22	17.5	17.5	16.5	2.6	
	KAR4C 42-18-18	1310	1195	1173	42	17.5	17.5	24.5	4.6	
	KAR4C 18-18-21	912	1064	765	17.5	17.5	21	17	3	
KAR4C 22-18-21	949	1092	781	22	17.5	21	16.5	2.6		
KAR4C 42-18-21	1341	1401	1203	42	17.5	21	24.5	4.6		
<b>ORDERING NOTE:</b> For leg finish add to the end of the model number; B for Matte Black, S for Silver Metallic and C for Polished Chrome										

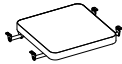
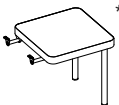

	Round Tables, Matte Black or Silver Metallic legs									
	KAR4C 24D-18	927	1265	725	24	-	17.5	19	3.5	
	KAR4C 36D-18	1267	1425	796	36	-	17.5	31	7.3	
	KAR4C 24D-21	940	1281	740	24	-	21	21	3.5	
	KAR4C 36D-21	1282	1440	810	36	-	21	33	7.3	
	Round Tables, Polished Chrome legs									
	KAR4C 24D-18	1061	1398	857	24	-	17.5	19	3.5	
	KAR4C 36D-18	1439	1597	968	36	-	17.5	31	7.3	
	KAR4C 24D-21	1089	1429	889	24	-	21	21	3.5	
	KAR4C 36D-21	1467	1629	999	36	-	21	33	7.3	
	<b>ORDERING NOTE:</b> For leg finish add to the end of the model number; B for Matte Black, S for Silver Metallic and C for Polished Chrome									

## KARMA | LINKING TABLES

Description	Model	Beech/ Palette	Laminate top w/Wood Edge	Laminate top w/ PVC Edge	W	D	H	Weight	Cube	
	Square Straight Linking Table, Matte Black or Silver Metallic, Left or Right handed (Same direction seating)									
	KAR4C-LKII-18-18	722	877	576	17.5	17.5	-	15	2.5	
	Square Straight Linking Table, Matte Black or Silver Metallic, Left handed as seated (Opposed seating)									
	KAR4C-LKIL-18-18	722	877	576	17.5	17.5	-	15	2.5	
	Square Straight Linking Table, Matte Black or Silver Metallic, Right handed as seated (Opposed seating)									
	KAR4C-LKIR-18-18	722	877	576	17.5	17.5	-	15	2.5	
	Square Straight Linking Table, Polished Chrome, Left or Right handed (Same direction seating)									
	KAR4C-LKII-18-18	882	1036	735	17.5	17.5	-	15	2.5	
	Square Straight Linking Table, Polished Chrome, Left handed as seated (Opposed seating)									
	KAR4C-LKIL-18-18	882	1036	735	17.5	17.5	-	15	2.5	
	Square Straight Linking Table, Polished Chrome, Right handed as seated (Opposed seating)									
	KAR4C-LKIR-18-18	882	1036	735	17.5	17.5	-	15	2.5	
	Square Straight Linking End Table, Matte Black or Silver Metallic legs, Left handed as seated									
	KAR4C-LKEL-18-18*	732	886	586	17.5	17.5	17.5	15	2.5	
	Square Straight Linking End Table, Matte Black or Silver Metallic legs, Right handed as seated									
	KAR4C-LKER-18-18	732	886	586	17.5	17.5	17.5	15	2.5	
	Square Straight Linking End Table, Polished Chrome legs, Left handed as seated									
	KAR4C-LKEL-18-18*	895	1052	751	17.5	17.5	17.5	15	2.5	
Square Straight Linking End Table, Polished Chrome legs, Right handed as seated										
KAR4C-LKER-18-18	895	1052	751	17.5	17.5	17.5	15	2.5		

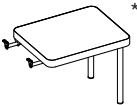

**ORDERING NOTES:** A drawing showing the configuration of the multiple seating and tables is required with each purchase order. See page 302 for suggested configurations.

# KARMA | LINKING TABLES

Description	Model	Beech/ Palette	Laminate top w/Wood Edge	Laminate top w/ PVC Edge	W	D	H	Weight	Cube
	Rectangular Straight Linking Table, Matte Black or Silver Metallic, Left or Right handed (Same direction seating)								
	KAR4C-LKII-22-18	761	905	591	22	17.5	-	16.5	2.8
	Rectangular Straight Linking Table, Matte Black or Silver Metallic, Left handed as seated (Opposed seating)								
	KAR4C-LKIL-22-18	761	905	591	22	17.5	-	16.5	2.8
	Rectangular Straight Linking Table, Matte Black or Silver Metallic, Right handed as seated (Opposed seating)								
	KAR4C-LKIR-22-18	761	905	591	22	17.5	-	16.5	2.8
	Rectangular Straight Linking Table, Polished Chrome, Left or Right handed (Same direction seating)								
KAR4C-LKII-22-18	919	1063	751	22	17.5	-	16.5	2.8	
Rectangular Straight Linking Table, Polished Chrome, Left handed as seated (Opposed seating)									
KAR4C-LKIL-22-18	919	1063	751	22	17.5	-	16.5	2.8	
Rectangular Straight Linking Table, Polished Chrome, Right handed as seated (Opposed seating)									
KAR4C-LKIR-22-18	919	1063	751	22	17.5	-	16.5	2.8	
	Rectangular Straight Linking End Table, Matte Black or Silver Metallic, Left handed as seated (Opposed seating)								
	KAR4C-LKEL-22-18*	768	913	601	22	17.5	17.5	16.5	2.8
	Rectangular Straight Linking End Table, Matte Black or Silver Metallic, Right handed as seated (Opposed seating)								
	KAR4C-LKER-22-18	768	913	601	22	17.5	17.5	16.5	2.8
	Rectangular Straight Linking End Table, Polished Chrome, Left handed as seated (Opposed seating)								
KAR4C-LKEL-22-18*	932	1074	765	22	17.5	17.5	16.5	2.8	
Rectangular Straight Linking End Table, Polished Chrome, Right handed as seated (Opposed seating)									
KAR4C-LKER-22-18	932	1074	765	22	17.5	17.5	16.5	2.8	
	Curvilinear Connector Table 45°, Matte Black or Silver Metallic, Left or Right handed (Same direction, <b>inward</b> seating)								
	KAR4C-LKCI-RF45	1039	1514	824	28	24	-	19	4.2
	Curvilinear Connector Table 45°, Matte Black or Silver Metallic, Left or Right handed (Same direction, <b>outward</b> seating)								
	KAR4C-LKCO-RF45	1039	1514	824	28	24	-	19	4.2
	Curvilinear Connector Table 45°, Matte Black or Silver Metallic, Left handed as seated ( <b>Opposed</b> seating)								
	KAR4C-LKCL-RF45	1039	1514	824	28	24	-	19	4.2
	Curvilinear Connector Table 45°, Matte Black or Silver Metallic, Right handed as seated ( <b>Opposed</b> seating)								
	KAR4C-LKCR-RF45	1039	1514	824	28	24	-	19	4.2
	Curvilinear Connector Table 45°, Polished Chrome, Left or Right handed (Same direction, <b>inward</b> seating)								
	KAR4C-LKCI-RF45	1198	1533	984	28	24	-	19	4.2
	Curvilinear Connector Table 45°, Polished Chrome, Left or Right handed (Same direction, <b>outward</b> seating)								
KAR4C-LKCO-RF45	1198	1533	984	28	24	-	19	4.2	
Curvilinear Connector Table 45°, Polished Chrome, Left handed as seated ( <b>Opposed</b> seating)									
KAR4C-LKCL-RF45	1198	1533	984	28	24	-	19	4.2	
Curvilinear Connector Table 45°, Polished Chrome, Right handed as seated ( <b>Opposed</b> seating)									
KAR4C-LKCR-RF45	1198	1533	984	28	24	-	19	4.2	
	Curvilinear Connector Table 45° Matte Black or Silver Metallic, with Flat edge, Left or Right handed (Same direction, <b>inward</b> seating)								
	KAR4C-LKCI-RR45	1073	1559	865	28	24	-	19	4.2
	Curvilinear Connector Table 45° Matte Black or Silver Metallic, with Flat edge, Left or Right handed (Same direction, <b>outward</b> seating)								
	KAR4C-LKCO-RR45	1073	1559	865	28	24	-	19	4.2
	Curvilinear Connector Table 45° Matte Black or Silver Metallic, with Flat edge, Left handed as seated ( <b>Opposed</b> seating)								
	KAR4C-LKCL-RR45	1073	1559	865	28	24	-	19	4.2
	Curvilinear Connector Table 45° Matte Black or Silver Metallic, with Flat edge, Right handed as seated ( <b>Opposed</b> seating)								
	KAR4C-LKCR-RR45	1073	1559	865	28	24	-	19	4.2
	Curvilinear Connector Table 45° Polished Chrome, with Flat edge, Left or Right handed (Same direction, <b>inward</b> seating)								
	KAR4C-LKCI-RR45	1232	1717	1022	28	24	-	19	4.2
	Curvilinear Connector Table 45° Polished Chrome, with Flat edge, Left or Right handed (Same direction, <b>outward</b> seating)								
KAR4C-LKCO-RR45	1232	1717	1022	28	24	-	19	4.2	
Curvilinear Connector Table 45° Polished Chrome, with Flat edge, Left handed as seated ( <b>Opposed</b> seating)									
KAR4C-LKCL-RR45	1232	1717	1022	28	24	-	19	4.2	
Curvilinear Connector Table 45° Polished Chrome, with Flat edge, Right handed as seated ( <b>Opposed</b> seating)									
KAR4C-LKCR-RR45	1232	1717	1022	28	24	-	19	4.2	







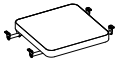

**ORDERING NOTES:** A drawing showing the configuration of the multiple seating and tables is required with each purchase order. See page 302 for suggested configurations.

# KARMA | LINKING TABLES

Description	Model	Beech/ Palette	Laminate top w/Wood Edge	Laminate top w/ PVC Edge	W	D	H	Weight	Cube
	Curvilinear Connector Table 90°, Matte Black or Silver Metallic, Left or Right handed (Same direction, <b>inward</b> seating)								
	KAR4C-LKCI-RR90	1351	1959	1084	38	24	-	22	5.5
	Curvilinear Connector Table 90°, Matte Black or Silver Metallic, Left or Right handed (Same direction, <b>outward</b> seating)								
	KAR4C-LKCO-RR90	1351	1959	1084	38	24	-	22	5.5
	Curvilinear Connector Table 90°, Matte Black or Silver Metallic, Left handed as seated ( <b>Opposed</b> seating)								
	KAR4C-LKCL-RR90	1351	1959	1084	38	24	-	22	5.5
	Curvilinear Connector Table 90°, Matte Black or Silver Metallic, Right handed as seated ( <b>Opposed</b> seating)								
	KAR4C-LKCR-RR90	1351	1959	1084	38	24	-	22	5.5
	Curvilinear Connector Table 90°, Polished Chrome, Left or Right handed (Same direction, <b>inward</b> seating)								
	KAR4C-LKCI-RR90	1510	2118	1243	38	24	-	22	5.5
Curvilinear Connector Table 90°, Polished Chrome, Left or Right handed (Same direction, <b>outward</b> seating)									
KAR4C-LKCO-RR90	1510	2118	1243	38	24	-	22	5.5	
Curvilinear Connector Table 90°, Polished Chrome, Left handed as seated ( <b>Opposed</b> seating)									
KAR4C-LKCL-RR90	1510	2118	1243	38	24	-	22	5.5	
Curvilinear Connector Table 90°, Polished Chrome, Right handed as seated ( <b>Opposed</b> seating)									
KAR4C-LKCR-RR90	1510	2118	1243	38	24	-	22	5.5	
	Curvilinear Connector Table 90° with Matte Black or Silver Metallic, Flat edge, Left or Right handed (Same direction, <b>inward</b> seating)								
	KAR4C-LKCI-RF90	1273	2018	1117	38	24	-	22	5.5
	Curvilinear Connector Table 90°, Matte Black or Silver Metallic, with Flat edge, Left or Right handed (Same direction, <b>outward</b> seating)								
	KAR4C-LKCO-RF90	1273	2018	1117	38	24	-	22	5.5
	Curvilinear Connector Table 90°, Matte Black or Silver Metallic, with Flat edge, Left handed as seated ( <b>Opposed</b> seating)								
	KAR4C-LKCL-RF90	1273	2018	1117	38	24	-	22	5.5
	Curvilinear Connector Table 90°, Matte Black or Silver Metallic, with Flat edge, Right handed as seated ( <b>Opposed</b> seating)								
	KAR4C-LKCR-RF90	1273	2018	1117	38	24	-	22	5.5
	Curvilinear Connector Table 90° Polished Chrome, with Flat edge, Left or Right handed (Same direction, <b>inward</b> seating)								
	KAR4C-LKCI-RF90	1552	2174	1275	38	24	-	22	5.5
Curvilinear Connector Table 90° Polished Chrome, with Flat edge, Left or Right handed (Same direction, <b>outward</b> seating)									
KAR4C-LKCO-RF90	1552	2174	1275	38	24	-	22	5.5	
Curvilinear Connector Table 90° Polished Chrome, with Flat edge, Left handed as seated ( <b>Opposed</b> seating)									
KAR4C-LKCL-RF90	1552	2174	1275	38	24	-	22	5.5	
Curvilinear Connector Table 90° Polished Chrome, with Flat edge, Right handed as seated ( <b>Opposed</b> seating)									
KAR4C-LKCR-RF90	1552	2174	1275	38	24	-	22	5.5	
	Rectilinear Corner Connector Table 90° Matte Black or Silver Metallic, with Flat edge, Left or Right handed (Same direction, <b>inward</b> seating)								
	KAR4C-LKCI-SF90	1512	2192	1212	30	30	-	26	5.5
	Rectilinear Connector Table 90° Matte Black or Silver Metallic, with Flat edge, Left or Right handed (Same direction, <b>outward</b> seating)								
	KAR4C-LKCO-SF90	1512	2192	1212	30	30	-	26	5.5
	Rectilinear Connector Table 90°, Matte Black or Silver Metallic, with Flat edge Left handed as seated ( <b>Opposed</b> seating)								
	KAR4C-LKCL-SF90	1512	2192	1212	30	30	-	26	5.5
	Rectilinear Connector Table 90° Matte Black or Silver Metallic, with Flat edge, Right handed as seated ( <b>Opposed</b> seating)								
	KAR4C-LKCR-SF90	1512	2192	1212	30	30	-	26	5.5
	Rectilinear Corner Connector Table 90° Polished Chrome, with Flat edge, Left or Right handed (Same direction, <b>inward</b> seating)								
	KAR4C-LKCI-SF90	1735	2415	1437	30	30	-	26	5.5
Rectilinear Connector Table 90° Polished Chrome, with Flat edge, Left or Right handed (Same direction, <b>outward</b> seating)									
KAR4C-LKCO-SF90	1735	2415	1437	30	30	-	26	5.5	
Rectilinear Connector Table 90°, Polished Chrome, with Flat edge Left handed as seated ( <b>Opposed</b> seating)									
KAR4C-LKCL-SF90	1735	2415	1437	30	30	-	26	5.5	
Rectilinear Connector Table 90° Polished Chrome, with Flat edge, Right handed as seated ( <b>Opposed</b> seating)									
KAR4C-LKCR-SF90	1735	2415	1437	30	30	-	26	5.5	

**ORDERING NOTES:** A drawing showing the configuration of the multiple seating and tables is required with each purchase order. See page 302 for suggested configurations.

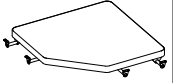
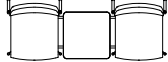
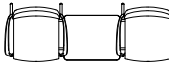
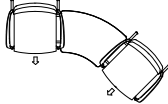
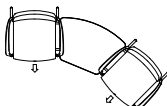
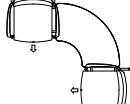
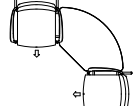
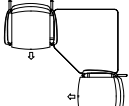
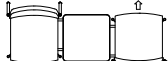
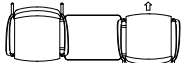
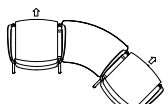
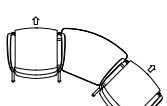
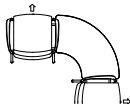
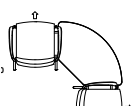
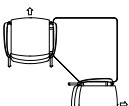
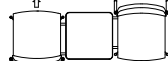
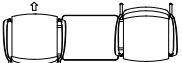
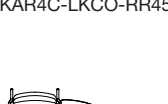
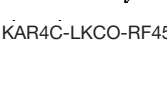
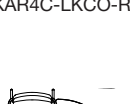
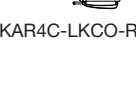
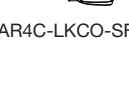
# KARMA | LINKING TABLES CONFIGURATIONS

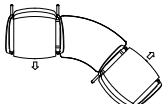
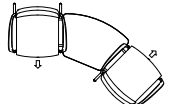
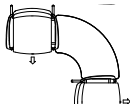
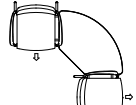
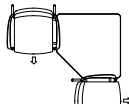
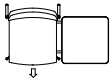
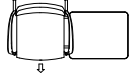
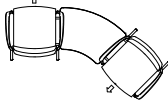
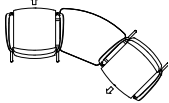
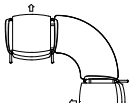
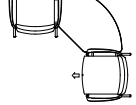
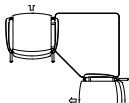
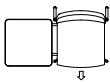
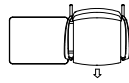
Straight Linking Square Table	Straight Linking Rectangular Table	Linked Table - Corner/Radius 45	Linked Table - Corner/Flat 45	Linked Table - Corner/Radius 90	Linked Table - Corner/Flat 90	Linked Table - Corner Square/ Flat 90
						
 KAR4C-LKII-18-18	 KAR4C-LKII-22-18	 KAR4C-LKCI-RR45	 KAR4C-LKCI-RF45	 KAR4C-LKCI-RR90	 KAR4C-LKCI-RF90	 KAR4C-LKCI-SF90
 KAR4C-LKIL-18-18	 KAR4C-LKIL-22-18	 KAR4C-LKCO-RR45	 KAR4C-LKCO-RF45	 KAR4C-LKCO-RR90	 KAR4C-LKCO-RF90	 KAR4C-LKCO-SF90
 KAR4C-LKIR-18-18	 KAR4C-LKIR-22-18	 KAR4C-LKCO-RR45	 KAR4C-LKCO-RF45	 KAR4C-LKCO-RR90	 KAR4C-LKCO-RF90	 KAR4C-LKCO-SF90
 Linked Table - End Square	 Linked Table - End Rectangular	 KAR4C-LKCL-RR45	 KAR4C-LKCL-RF45	 KAR4C-LKCL-RR90	 KAR4C-LKCL-RF90	 KAR4C-LKCL-SF90
 KAR4C-LKEL-18-18	 KAR4C-LKEL-22-18	 KAR4C-LKCR-RR45	 KAR4C-LKCR-RF45	 KAR4C-LKCR-RR90	 KAR4C-LKCR-RF90	 KAR4C-LKCR-SF90
 KAR4C-LKER-18-18	 KAR4C-LKER-22-18					

**ORDERING NOTES:** A drawing showing the configuration of the multiple seating and tables is required with each purchase order.

# CRESSIDA | ENVIRONMENTAL SUMMARY

## LEED CI CREDITS



MATERIAL CONTENT:

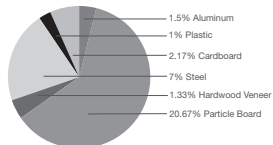

PRE-CONSUMER RECYCLED CONTENT - 36.34%

POST-CONSUMER RECYCLED CONTENT - 26.4%

Up to 31.25% of this Cressida product is recyclable at the end of its useful life.



MATERIAL CONTENT:

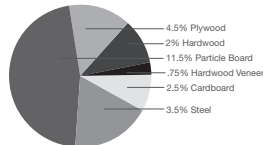

PRE-CONSUMER RECYCLED CONTENT - 30.77%

POST-CONSUMER RECYCLED CONTENT - 25.68%

Up to 27.88% of this Cressida product is recyclable at the end of its useful life.

CONTRIBUTES TO

CREDIT 2.1 - 2.2	Construction Waste Management	1-2 point(s)
CREDIT 3.3	Resource Reuse	1 point
CREDIT 4.1	Recycled Content	1 point
CREDIT 4.2	Recycled Content	1 point
CREDIT 4.5	Low Emitting Materials, Systems & Seating	1 point
CREDIT 5.1	Regional Materials*	1 point
CREDIT 7	Certified Wood (MUST BE REQUESTED)	1 point(s)

\*This credit is only applicable if in total 20% of the combined value of the procurement of construction materials and in the furniture are manufactured within a radius of 500 miles. This credit will apply if the installation of the finished product occurs within 500 miles of Kitchener, Ontario.

## level® CERTIFICATION, AIR EMISSIONS AND FSC® CERTIFICATION



### level® CERTIFICATION

BIFMA's e3 Furniture Sustainability Standard is a voluntary, multi-attribute standard that measures the degree of sustainability of furniture. This standard evaluates product and company environmental attributes and compliance systems in a wide range of elements which include Materials, Energy & Atmosphere, Human & Ecosystem Health and Social Responsibility. Cressida products have earned level®, BIFMA's sustainability certification program for furniture, certification through third-party verification against the e3 standard.

### AIR-EMISSIONS

All Cressida products are supplied with air-emissions certified. Contact customer service for information.



### FSC®

In 2005, Krug received Forest Stewardship Council® (FSC®) Chain-of-Custody certification for our manufacturing facilities. The FSC® Chain-of-Custody tracks certified wood from seedling to final sale. It verifies that the material for our FSC® certified products only come from well-managed, FSC®-certified forests and other controlled sources. FSC® is dedicated to the promotion of responsible forest management worldwide helping to take care of forests for future generations. Cressida and other Krug products can be specified with FSC® Certification. Contact customer service for further information, pricing and lead times.



Architects, designers, and building professionals can specify FSC®-certified products in order to achieve a point from the U.S. Green Building Council's Leadership in Energy and Environmental Design (LEED) Rating System.



# CRESSIDA | TABLE FEATURES

## ANTI-MICROBIAL FINISH

Cressida wood surfaces include an anti-microbial finish that inhibits the growth of some molds and mildews. Surfaces coated in this finish support the reduction of fungal growth, and spores from germs, microbes and bacteria

## STANDARD FINISHES

For a complete list of standard wood finishes, please see page 335. Cressida tables are available in 22 standard finishes.

## LAMINATE

Cressida Box-style tables are available in laminate with wood side or laminate side. See page 336 for laminate information.

## SOLID SURFACE

Cressida Box-style & Slab-style tables are available with 1/2" solid surface tops. Cressida Light-style tables are available with full solid surface tops, 1" thick. Please contact customer service for a quote.

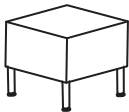
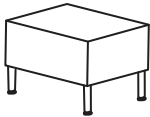
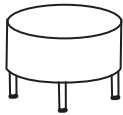
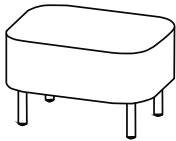
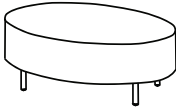
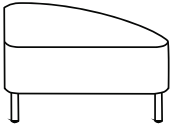

## CRESSIDA | BOX-STYLE TABLES

DESCRIPTION	MODEL	BEECH PALETTE LAMINATE	MAPLE	LAMINATE TOP W/BEECH SIDES	LAMINATE TOP W/ MAPLE SIDES	W	D	H	WEIGHT	CUBE
	Square Tables									
	CRE4A 181816	1179	1227	1224	1271	18	18	15.75	24	3
	CRE4A 242416	1458	1515	1508	1567	24	24	15.75	34	5
	Rectangular Tables									
	CRE4A 241816	1295	1347	1338	1393	24	18	15.75	28	4
	CRE4A 482416	2085	2167	2158	2241	48	24	15.75	56	10
	Round Tables									
	CRE4A 18D16	973	1012	1003	1044	18	-	15.75	16	3
	CRE4A 24D16	1187	1236	1338	1393	24	-	15.75	23	5
	CRE4A 30D16	2079	2163	2272	2361	30	-	15.75	34	8
	Rectangular Round Corner									
	CRE4 B181816	1265	1315	1311	1361	18	18	15.75	21	3
	CRE4 B241816	1425	1483	1485	1545	24	18	15.75	25	4
	CRE4 B242416	1583	1644	1686	1752	24	24	15.75	30	5
	CRE4 B482416	2299	2390	2461	2559	48	24	15.75	51	10
	Oval Tables									
	CRE4A E241816	1312	1363	1443	1501	24	18	15.75	23	4
	CRE4A E322416	1620	1686	1753	1825	32	24	15.75	34	7
	CRE4A E482916	2058	2139	2201	2287	48	29	15.75	56	12
	Triangular Round Corner									
	CRE4B T1618-45	1187	1236	1205	1253	16	18	15.75	18	2.5
	CRE4B T2124-45	1359	1415	1411	1465	21	24	15.75	23	4.5
	CRE4B T2529-45	1666	1732	1760	1833	25	29	15.75	28	7
	CRE4B T2818-90	1477	1534	1534	1594	28	18	15.75	24	3
	CRE4B T3624-90	1758	1832	1841	1915	36	24	15.75	30	7.5
	CRE4B T4429-90	2114	2198	2135	2220	44	29	15.75	36	11

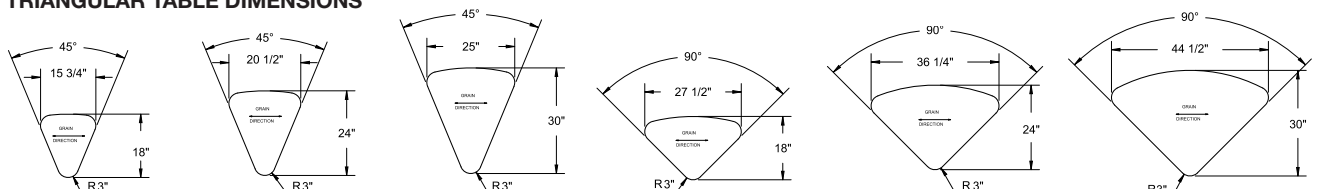
## TRIANGULAR TABLE DIMENSIONS



# CRESSIDA | LIGHT-STYLE TABLES

DESCRIPTION	MODEL	BEECH PALETTE LAMINATE	MAPLE	LAMINATE TOP W/BEECH SIDES	LAMINATE TOP W/ MAPLE SIDES	W	D	H	WEIGHT	CUBE
	Square Tables									
	CRE4D 222216	589	613	672	699	22	22	16	32	5
	CRE4D 222221	601	626	687	714	22	22	21	34	7
	CRE4D 422216	832	865	997	1036	42	22	16	55	9
	Soft Square Tables									
	CRE4D 181816S	533	555	596	620	18	18	16	22	3
	CRE4D 242416S	591	615	688	715	24	24	16	33	5
	CRE4D 363616S	845	878	1014	1054	36	36	16	65	12
	CRE4D 181821S	543	565	610	633	18	18	21	25	4
	CRE4D 242421S	603	628	699	729	24	24	21	35	5

LEED CI CREDITS

MATERIAL CONTENT:

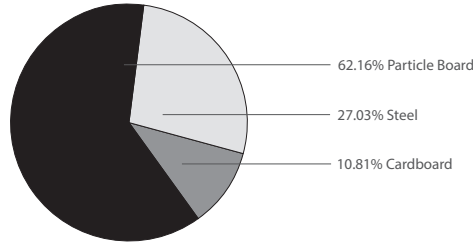

PRE-CONSUMER RECYCLED CONTENT = 34.73%

POST-CONSUMER RECYCLED CONTENT = 15.68%

Up to 62.16% of this Leyton product is recyclable at the end of its useful life.

CONTRIBUTES TO

CREDIT 2.1 - 2.2	Construction Waste Management	1-2 point(s)
CREDIT 3.3	Resource Reuse	1 point
CREDIT 4.1	Recycled Content	1 point
CREDIT 4.2	Recycled Content	1 point
CREDIT 4.5	Low Emitting Materials, Systems & Seating	1 point
CREDIT 5.1	Regional Materials*	1 point
CREDIT 7	Certified Wood (MUST BE REQUESTED)	1 point(s)

\*This credit is only applicable if in total 20% of the combined value of the procurement of construction materials and in the furniture are manufactured within a radius of 500 miles. This credit will apply if the installation of the finished product occurs within 500 miles of Kitchener, Ontario.

level® CERTIFICATION, AIR EMISSIONS AND FSC® CERTIFICATION



level® CERTIFICATION

BIFMA's e3 Furniture Sustainability Standard is a voluntary, multi-attribute standard that measures the degree of sustainability of furniture. This standard evaluates product and company environmental attributes and compliance systems in a wide range of elements which include Materials, Energy & Atmosphere, Human & Ecosystem Health and Social Responsibility. Leyton products have earned level®, BIFMA's sustainability certification program for furniture, certification through third-party verification against the e3 standard.

AIR EMISSIONS

All Leyton products are supplied air-emissions certified. Contact customer service for information and upcharges.



the mark of responsible forestry

FSC®

In 2005, Krug received Forest Stewardship Council® (FSC®) Chain-of-Custody certification for our manufacturing facilities. The FSC® Chain-of-Custody tracks certified wood from seedling to final sale. It verifies that the material for our FSC® certified products only come from well-managed, FSC®-certified forests and other controlled sources. FSC® is dedicated to the promotion of responsible forest management worldwide helping to take care of forests for future generations. Leyton and other Krug products can be specified with FSC® Certification. Contact customer service for further information, pricing and lead times.



In addition, architects, designers, and building professionals can specify FSC®-certified products in order to achieve a point from the US. Green Building Council's Leadership in Energy and Environmental Design (LEED) Rating System.

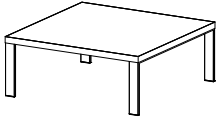
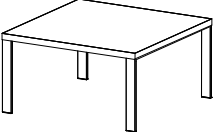
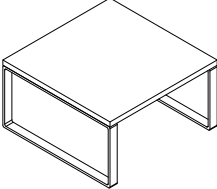

# LEYTON | TABLES

DESCRIPTION/MODEL	Maple, Oak Walnut Palette Laminate	Cherry Anigre Sycamore (5 UNIT MIN.)	Solid Surface top Grade A - White	Solid Surface top Grade A - Color	Solid Surface top Grade B	Solid Surface top Grade C	
	LEY4122412	584	648	824	869	958	1019
	LEY4182412	611	695	940	1002	1120	1202
	LEY4242412	641	744	1062	1137	1288	1390
	LEY4302412	670	794	1173	1265	1440	1563
	LEY4362412	699	842	1317	1422	1633	1778
	LEY4422412	851	1015	1438	1559	1801	1966
	LEY4183012	666	765	1053	1122	1266	1361
	LEY4243012	701	832	1183	1271	1449	1570
	LEY4303012	743	890	1309	1414	1624	1769
	LEY4363012	781	953	1462	1587	1836	2009
LEY4423012	922	1117	1613	1756	2041	2238	
	LEY4182416	626	710	946	1005	1124	1207
	LEY4242416	656	760	1065	1141	1291	1395
	LEY4302416	687	809	1179	1268	1446	1568
	LEY4362416	715	854	1320	1428	1639	1781
	LEY4422416	868	1030	1443	1565	1804	1970
	LEY4183016	680	781	1081	1151	1291	1390
	LEY4243016	716	845	1209	1297	1478	1598
	LEY4303016	759	906	1334	1440	1651	1796
	LEY4363016	795	963	1488	1613	1863	2034
	LEY4423016	937	1134	1641	1781	2068	2264
	LEY4-SB122412	622	683	850	893	978	1036
	LEY4-SB182412	647	727	961	1020	1132	1210
	LEY4-SB242412	676	774	1077	1148	1292	1389
	LEY4-SB302412	704	822	1183	1270	1437	1554
	LEY4-SB362412	731	867	1320	1420	1621	1759
	LEY4-SB422412	876	1032	1435	1550	1781	1938
	LEY4-SB183012	700	794	1068	1134	1271	1362
	LEY4-SB243012	733	858	1192	1276	1445	1561
	LEY4-SB303012	773	913	1312	1412	1612	1750
	LEY4-SB363012	809	973	1458	1577	1814	1979
LEY4-SB423012	944	1129	1602	1738	2009	2197	

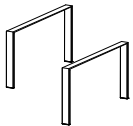
Please note Cherry, Anigre and Sycamore species require a minimum quantity order of 5 tables (any combination of sizes) per species.

DESCRIPTION/MODEL	Price	Weight	Cubes
	Replacement Table Legs (pair)	238	
	LEY4R2412	246	8
	LEY4R2416	276	10
	LEY4R3012	305	10
	LEY4R3016		12
	Replacement Glides - Lounge & Table (set of four)		
	LEY3RG	18	1
	LEY3-POWERDOC - Undermount	573	3

## DIMENSIONS

Model	W	D	H	Shipping Weight	Cubes	Model	W	D	H	Shipping Weight	Cubes
LEY4122412	12	24	12	17.5	.7	LEY4182416	18	24	16	27	1.4
LEY4182412	18	24	12	22	1.1	LEY4242416	24	24	16	33	1.8
LEY4242412	24	24	12	28	1.4	LEY4302416	30	24	16	39	2.2
LEY4302412	30	24	12	32	1.8	LEY4362416	36	24	16	45	2.7
LEY4362412	36	24	12	37	2.2	LEY4422416	42	24	16	51	3.1
LEY4422412	42	24	12	41.5	2.5	LEY4183016	18	30	16	28	1.4
LEY4183012	18	30	12	23	1.1	LEY4243016	24	30	16	34	1.8
LEY4243012	24	30	12	28	1.4	LEY4303016	30	30	16	40	2.2
LEY4303012	30	30	12	33	1.8	LEY4363016	36	30	16	46	2.7
LEY4363012	36	30	12	37.5	2.2	LEY4423016	42	30	16	52	3.1
LEY4423012	42	30	12	42.5	2.5						

## LEED CI CREDITS

### MATERIAL CONTENT:

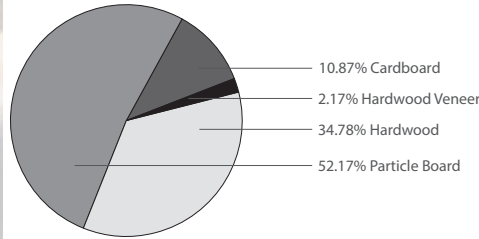

PRE-CONSUMER  
RECYCLED CONTENT = 54.89%

POST-CONSUMER  
RECYCLED CONTENT = 10.33%

Up to 10.87% of this Faeron product is recyclable at the end of its useful life.

### CONTRIBUTES TO

CREDIT 2.1 - 2.2	Construction Waste Management	1-2 point(s)
CREDIT 3.3	Resource Reuse	1 point
CREDIT 4.1	Recycled Content	1 point
CREDIT 4.2	Recycled Content	1 point
CREDIT 4.5	Low Emitting Materials, Systems & Seating	1 point
CREDIT 5.1	Regional Materials*	1 point
CREDIT 7	Certified Wood (MUST BE REQUESTED)	1 point(s)

\*This credit is only applicable if in total 20% of the combined value of the procurement of construction materials and in the furniture are manufactured within a radius of 500 miles. This credit will apply if the installation of the finished product occurs within 500 miles of Kitchener, Ontario.

## level® CERTIFICATION, AIR EMISSIONS AND FSC® CERTIFICATION



### level® CERTIFICATION

BIFMA's e3 Furniture Sustainability Standard is a voluntary, multi-attribute standard that measures the degree of sustainability of furniture. This standard evaluates product and company environmental attributes and compliance systems in a wide range of elements which include Materials, Energy & Atmosphere, Human & Ecosystem Health and Social Responsibility. Faeron products have earned level®, BIFMA's sustainability certification program for furniture, certification through third-party verification against the e3 standard.

### AIR-EMISSIONS

All Faeron products are supplied with air-emissions certified. Contact customer service for information.



### FSC®

In 2005, Krug received Forest Stewardship Council® (FSC®) Chain-of-Custody certification for our manufacturing facilities. The FSC® Chain-of-Custody tracks certified wood from seedling to final sale. It verifies that the material for our FSC® certified products only come from well-managed, FSC®-certified forests and other controlled sources. FSC® is dedicated to the promotion of responsible forest management worldwide helping to take care of forests for future generations. Faeron and other Krug products can be specified with FSC® Certification. Contact customer service for further information, pricing and lead times.



Architects, designers, and building professionals can specify FSC®-certified products in order to achieve a point from the U.S. Green Building Council's Leadership in Energy and Environmental Design (LEED) Rating System.

HEALTHCARE DISCOUNT APPLIES TO THESE PRODUCTS

# FAERON WOOD | FREE STANDING TABLES

## WOOD SPECIES

Solid Beech frames, and edges.  
Veneer tops.



## LAMINATE AND POLYMER EDGE

Faeron tables are available in laminates with wood or laminates with Polymer edge.  
See page 336 for color selection.

## STANDARD FINISHES

For a complete list of standard wood finishes, please see page 331. Faeron tables are available in 22 standard finishes.

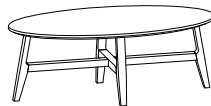
HEALTHCARE DISCOUNT APPLIES TO THESE PRODUCTS

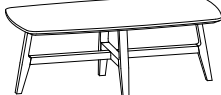
DESCRIPTION/MODEL	Beech	Laminate with Polymer Edge	Solid Surface top Grade A - White	Solid Surface top Grade A - Color	Solid Surface top Grade B	Solid Surface top Grade C
<b>Round Tables</b>						
 FAE4-22D-21	1246	928	1833	1960	2070	2271
FAE4-30D-16	1402	1038	2131	2279	2479	2769
FAE4-44D-16	2574	1880	3762	4024	4391	4915
<b>Elliptical</b>						
 FAE4-E44-22-16	1603	1169	2359	2524	2748	3077
<b>Square Tables</b>						
 FAE4-22-22-21	1232	916	1748	1870	1989	2191
FAE4-30-30-16	1429	1060	2147	2298	2538	2867
FAE4-44-44-16	2628	1918	3839	4108	4480	5016
<b>Rectangular Table</b>						
 FAE4-44-22-16	1622	1184	2369	2536	2765	3096

## DIMENSIONS

Model	Width	Depth	Height	Shipping Weight	Cubes
<b>Round Tables</b>					
FAE4-22D-21	22" Diameter		21	22	8
FAE4-30D-16	30" Diameter		16	35	11
FAE4-44D-16	40" Diameter		16	45	14
<b>Elliptical</b>					
FAE4-E44-22-16	44	22	16	65	21
<b>Square Tables</b>					
FAE4-22-22-21	22	22	21	34	8
FAE4-30-30-16	30	30	16	42	11
FAE4-44-44-16	44	44	16	47	12
<b>Rectangular Table</b>					
FAE4-44-22-16	44	22	16	55	12

## LEED CI CREDITS



MATERIAL CONTENT:

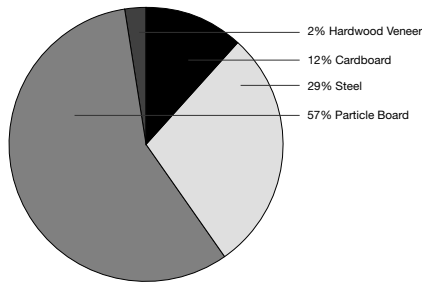

PRE-CONSUMER RECYCLED CONTENT = 67.26%

POST-CONSUMER RECYCLED CONTENT = 17.02%

Up to 40.48% of this Faeron Metal product is recyclable at the end of its useful life.

CONTRIBUTES TO

CREDIT 2.1 - 2.2	Construction Waste Management	1-2 point(s)
CREDIT 3.3	Resource Reuse	1 point
CREDIT 4.1	Recycled Content	1 point
CREDIT 4.2	Recycled Content	1 point
CREDIT 4.5	Low Emitting Materials, Systems & Seating	1 point
CREDIT 5.1	Regional Materials*	1 point
CREDIT 7	Certified Wood (MUST BE REQUESTED)	1 point(s)

\*This credit is only applicable if in total 20% of the combined value of the procurement of construction materials and in the furniture are manufactured within a radius of 500 miles. This credit will apply if the installation of the finished product occurs within 500 miles of Kitchener, Ontario.

## level® CERTIFICATION, AIR EMISSIONS AND FSC® CERTIFICATION



**level® CERTIFICATION**

BIFMA's e3 Furniture Sustainability Standard is a voluntary, multi-attribute standard that measures the degree of sustainability of furniture. This standard evaluates product and company environmental attributes and compliance systems in a wide range of elements which include Materials, Energy & Atmosphere, Human & Ecosystem Health and Social Responsibility. Faeron products have earned level®, BIFMA's sustainability certification program for furniture, certification through third-party verification against the e3 standard.

**AIR-EMISSIONS**

All Faeron products are supplied with air-emissions certified. Contact customer service for information.



**FSC®**

In 2005, Krug received Forest Stewardship Council® (FSC®) Chain-of-Custody certification for our manufacturing facilities. The FSC® Chain-of-Custody tracks certified wood from seedling to final sale. It verifies that the material for our FSC® certified products only come from well-managed, FSC®-certified forests and other controlled sources. FSC® is dedicated to the promotion of responsible forest management worldwide helping to take care of forests for future generations. Faeron and other Krug products can be specified with FSC® Certification. Contact customer service for further information, pricing and lead times.



Architects, designers, and building professionals can specify FSC®-certified products in order to achieve a point from the U.S. Green Building Council's Leadership in Energy and Environmental Design (LEED) Rating System.

HEALTHCARE DISCOUNT APPLIES TO THESE PRODUCTS

# FAERON METAL | FREE STANDING TABLES

## FRAME FINISH

Faeron Metal table frames are available in Krug Silver Metallic or Brushed Nickel.

## METAL FINISH OPTIONS

Silver Metallic frames are available with an anti-microbial finish for an upcharge of **\$64 list** per arm frame pair or table. Additional Frame Finishes, which include anti-microbial finish, are available for an upcharge of **\$64 list** per



arm frame pair or table. Available colors are: White, Parchment, Sand, Taupe, Warm Grey, Cool Grey or Black. For all metal finishes other than Silver Metallic Standard, there is a minimum order quantity of 30 units per color. Upcharges for order quantities less than 30 units per color or custom metal finishes, please contact Customer Service to obtain a quote.

## STANDARD FINISHES

For a complete list of standard wood finishes, please see page 335. Faeron tables are available in 22 standard finishes.

## LAMINATE AND POLYMER EDGE

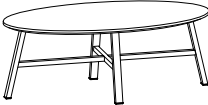
Faeron tables are available in laminates with wood or laminates with Polymer edge. See page 336 for color selection.

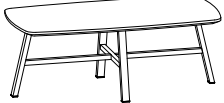
DESCRIPTION/MODEL	Beech	Laminate with Polymer Edge	Solid Surface top Grade A - White	Solid Surface top Grade A - Color	Solid Surface top Grade B	Solid Surface top Grade C
<b>Round Tables, Silver Metallic Frame</b>						
 FAE4-M22D-21S	1132	810	1716	1845	1956	2157
FAE4-M30D-16S	1223	859	1953	2100	2298	2592
FAE4-M44D-16S	2302	1609	3490	3753	4117	4643
<b>Round Tables, Brushed Nickel Frame</b>						
FAE4-M22D-21N	1294	974	1879	2007	2117	2318
FAE4-M30D-16N	1386	1021	2113	2263	2461	2754
FAE4-M44D-16N	2659	1965	3846	4110	4473	5000
<b>Elliptical, Silver Metallic Frame</b>						
 FAE4-ME44-22-16S	1374	939	2130	2295	2520	2848
<b>Elliptical, Brushed Nickel Frame</b>						
FAE4-ME44-22-16N	1697	1265	2452	2616	2844	3172
<b>Square Tables, Silver Metallic Frame</b>						
 FAE4-M22-22-21S	1118	803	1634	1755	1872	2076
FAE4-M30-30-16S	1249	882	1967	2119	2359	2688
FAE4-M44-44-16S	2356	1645	3565	3836	4207	4743
<b>Square Tables, Brushed Nickel Frame</b>						
FAE4-M22-22-21N	1282	962	1795	1918	2035	2238
FAE4-M30-30-16N	1412	1042	2131	2281	2522	2849
FAE4-M44-44-16N	2713	2003	3922	4192	4564	5099
<b>Rectangular Table, Silver Metallic Frame</b>						
 FAE4-M44-22-16S	1393	955	2140	2306	2535	2867
<b>Rectangular Table, Brushed Nickel Frame</b>						
FAE4-M44-22-16N	1716	1279	2463	2630	2859	3190

## DIMENSIONS

Model	Width	Depth	Height	Shipping Weight	Cubes
<b>Round Tables</b>					
FAE4-M22D-21	22" Diameter		21	30	8
FAE4-M30D-16	30" Diameter		16	42	11
FAE4-M44D-16	44" Diameter		16	72	21
<b>Elliptical</b>					
FAE4-ME44-22-16	44	22	16	42	12
<b>Square Tables</b>					
FAE4-M22-22-21	22	22	21	32	8
FAE4-M30-30-16	30	30	16	47	11
FAE4-M44-44-16	44	44	16	83	21
<b>Rectangular Table</b>					
FAE4-M44-22-16	44	22	16	47	12



## LEED CI CREDITS



MATERIAL CONTENT:

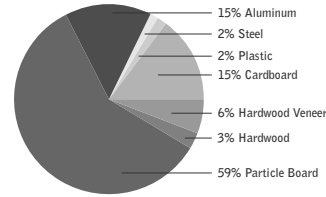

PRE-CONSUMER  
RECYCLED CONTENT = 58.82%

POST-CONSUMER  
RECYCLED CONTENT = 17.25%

Up to 29.41% of this Zola product is recyclable at the end of its useful life.

### CONTRIBUTES TO

CREDIT 2.1 - 2.2	Construction Waste Management	1-2 point(s)
CREDIT 3.3	Resource Reuse	1 point
CREDIT 4.1	Recycled Content	1 point
CREDIT 4.2	Recycled Content	1 point
CREDIT 4.5	Low Emitting Materials, Systems & Seating	1 point
CREDIT 5.1	Regional Materials*	1 point
CREDIT 7	Certified Wood (MUST BE REQUESTED)	1 point(s)

\*This credit is only applicable if in total 20% of the combined value of the procurement of construction materials and in the furniture are manufactured within a radius of 500 miles. This credit will apply if the installation of the finished product occurs within 500 miles of Kitchener, Ontario.

## level® CERTIFICATION, AIR EMISSIONS AND FSC® CERTIFICATION



### level® CERTIFICATION

BIFMA's e3 Furniture Sustainability Standard is a voluntary, multi-attribute standard that measures the degree of sustainability of furniture. This standard evaluates product and company environmental attributes and compliance systems in a wide range of elements which include Materials, Energy & Atmosphere, Human & Ecosystem Health and Social Responsibility. Zola products have earned level®, BIFMA's sustainability certification program for furniture, certification through third-party verification against the e3 standard.



FSC  
www.fsc.org  
FSC® C021699

The mark of responsible forestry

### AIR EMISSIONS

All Zola products are supplied air emissions-certified. Contact customer service for information.

### FSC®

In 2005, Krug received Forest Stewardship Council® (FSC®) Chain-of-Custody certification for our manufacturing facilities. The FSC® Chain-of-Custody tracks certified wood from seedling to final sale. It verifies that the material for our FSC® certified products only come from well-managed, FSC®-certified forests and other controlled sources. FSC® is dedicated to the promotion of responsible forest management worldwide helping to take care of forests for future generations. Jordan and other Krug products can be specified with FSC® Certification. Contact customer service for further information, pricing and lead times.



Architects, designers, and building professionals can specify FSC®-certified products in order to achieve a point from the U.S. Green Building Council's Leadership in Energy and Environmental Design (LEED) Rating System.

# ZOLA | TABLES FEATURES

## TABLES MATERIALS OPTION

Tables are available in veneer, plastic laminate, and Palette finishes - and an optional solid surface top. Tables feature leveling glides on every leg.

## SOLID SURFACE TOPS

The Solid Surface Top option features Solid Surface material:

composed of minerals, acrylic resins and colors, it is a non-porous, scratch and dent-resistant material that does not stain, and does not allow microbes and bacteria to penetrate the surface. Color is throughout the material, so surface scratches are not as visible.

## POWER OPTION

The flush-mounted Power unit provides dual power/USB A & C outlets for multiple devices. It can be located on the front face of Middle or End Tables (not available on curvilinear models) To specify, clearly mark on the order and add **\$647 list**.

## UNDER-MOUNT POWER OPTION

The Under-mount Power unit provides dual power/USB A & C outlets for multiple devices. It can be located below tables. See page 251 for pricing.

# ZOLA | MODULAR LINKING TABLES

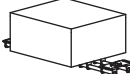
DESCRIPTION	MODEL	BEECH PALETTE LAMINATE	MAPLE CHERRY	LAMINATE TOP W/BEECH SIDES	LAMINATE TOP W/ MAPLE/CHERRY SIDES	W	D	H	WEIGHT	CUBE
	Middle Linking Modular Table									
	ZOL4 LKM12	988	1036	1088	1140	12	16	-	22	2.8
	ZOL4 LKM18	1044	1098	1147	1209	18	16	-	24	4.5
	ZOL4 LKM24	1074	1155	1181	1270	24	16	-	29	5.7

**ORDERING NOTE:** Middle Linking Modular Table ships with 2 KB1 brackets.

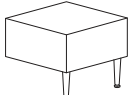
	Rectangular End Table Square Corner									
	ZOL4 LKE12	1053	1108	1158	1218	12	16	14.75	19	2.8
	ZOL4 LKE18	1098	1155	1209	1270	18	16	14.75	23	4.5
	ZOL4 LKE24	1146	1202	1263	1323	24	16	14.75	28	5.7

**ORDERING NOTE:** End Linking Modular Table ships with 1 KB1 bracket.

	End Table Rounded Corner									
	ZOL4 ECLKH12	1199	1246	1232	1284	12	12	14.75	18	2.5
	ZOL4 ECLKH18	1295	1347	1342	1395	18	12	14.75	24	3

**ORDERING NOTE:** End Linking Modular Table ships with 1 KB1 bracket.

	Curvilinear 30° Table									
	ZOL4 LKC30	1019	1074	1122	1181	16	16.5	-	15	2.3



	Curvilinear 45° Table									
	ZOL4 LKC45	1098	1155	1209	1270	16	17	-	17	2.9

**ORDERING NOTES:** Middle Linking Tables are automatically supplied with two ZOL3 RLKB1 (table to seat bracket) brackets for fastening to benches. End tables are automatically supplied with one ZOL3 RLKB1 (table to seat bracket) bracket for fastening to benches. When fastening two linking tables (ZOL4 LKC90X2) together, mounting hardware will be provided when ordered, that will include one leg per table (to a maximum of two legs), which will be mounted on the adjoining seam. Please note in model ZOL4 LKH12, the "12" corresponds to the length of the table.

Zola Solid Surface Upcharges	Grades			
	A-White	A-Color	B	C
ZOL4-LKM12	218	229	260	295
ZOL4-LKM18	269	286	332	383
ZOL4-LKM24	381	406	522	621
ZOL4-LKE12	218	229	260	295
ZOL4-LKE18	269	286	332	383
ZOL4-LKE24	381	406	522	621
ZOL4-ECLKH12	218	229	260	295
ZOL4-ECLKH18	269	286	332	383
ZOL4-LKC30	246	260	299	340
ZOL4-LKC45	308	328	384	446

The Solid Surface top option is priced as an upcharge to existing table price. Please add a "S" to the end of the model number and then add the upcharge listed under Solid Surface ie: ZOL4 18D15S. Zola Solid Surface tables have a 1/2" thickness on top of the existing table, with a 1 mm overhang (soft radius vertical edge).

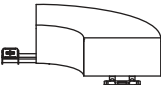
# ZOLA | MODULAR LINKING TABLES

DESCRIPTION	MODEL	BEECH PALETTE LAMINATE	MAPLE CHERRY	LAMINATE TOP W/BEECH SIDES	LAMINATE TOP W/ MAPLE/CHERRY SIDES	W	D	H	WEIGHT	CUBE
	Curvilinear 60° Table ZOL4 LKC60	1146	1209	1263	1332	16	17.5	-	20	3.7
	Curvilinear 90° Table ZOL4 LKC90	1283	1354	1411	1487	16	19	-	24	5.4
	Curvilinear 90°x2 Table ZOL4 LKC90X2	2548	2625	2802	2886	16	19	-	55	10
	Curvilinear Table ZOL4 LKH12	1116	1170	1228	1288	16	19	14.75	18	2.3

**ORDERING NOTES:** Middle Linking Tables are automatically supplied with two ZOL3 RLKB1 (table to seat bracket) brackets for fastening to benches. End tables are automatically supplied with one ZOL3 RLKB1 (table to seat bracket) bracket for fastening to benches. When fastening two linking tables (ZOL4 LKC90X2) together, mounting hardware will be provided when ordered, that will include one leg per table (to a maximum of two legs), which will be mounted on the adjoining seam. Zola Middle tables have the ability to be easily reconfigured, as they are universal and non-handed. They can be moved to a reverse position in almost any configuration to provide a high level of flexibility when specifying.

Zola Solid Surface Upcharges	Grades			
	A-White	A-Color	B	C
ZOL4-LKC60	379	402	473	559
ZOL4-LKC90	562	596	719	857
ZOL4-LKC90X2	894	933	1141	1378
ZOL4-LKH12	218	229	260	295

The Solid Surface top option is priced as an upcharge to existing table price. Please add a "S" to the end of the model number and then add the upcharge listed under Solid Surface ie: ZOL4 18D15S. Zola Solid Surface tables have a 1/2" thickness on top of the existing table, with a 1 mm overhang (soft radius vertical edge).

## CURVILINEAR TABLE DIMENSIONS

ZOL4 LKC30

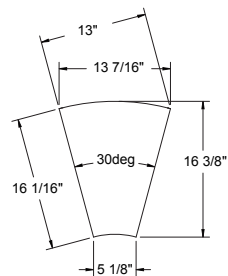

ZOL4 LKC60

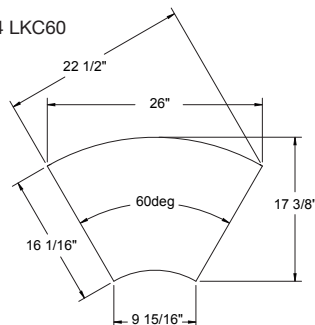

ZOL4 LKC45

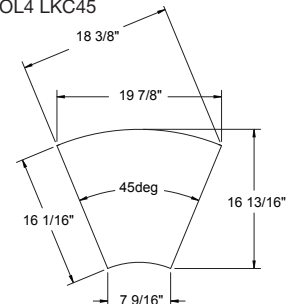

ZOL4 LKC90

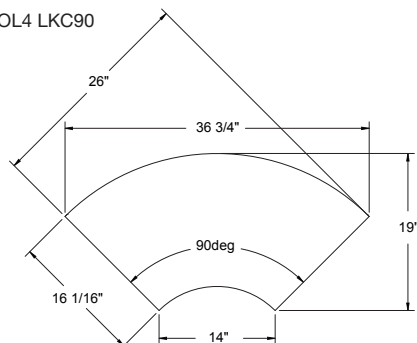

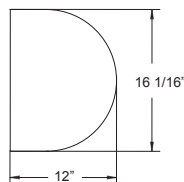

ZOL4 LKH12

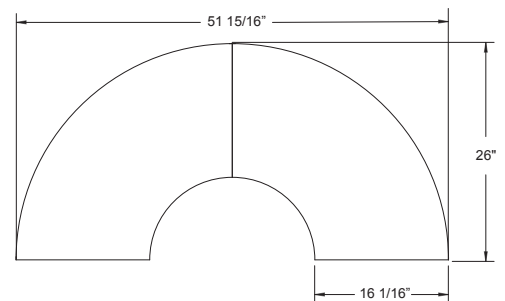

ZOL4 LKC90X2

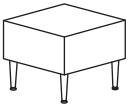
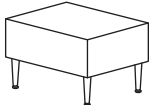
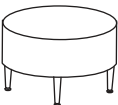

# ZOLA | FREESTANDING TABLES

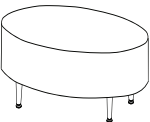
DESCRIPTION	MODEL	BEECH PALETTE LAMINATE	MAPLE CHERRY	LAMINATE TOP W/BEECH SIDES	LAMINATE TOP W/ MAPLE/CHERRY SIDES	W	D	H	WEIGHT	CUBE
	Square Tables									
	ZOL4 181815	1098	1155	1209	1270	18	18	14.75	24	3
	ZOL4 242415	1187	1251	1305	1374	24	24	14.75	34	5
	Rectangular Tables									
	ZOL4 241815	1139	1203	1253	1327	24	18	14.75	28	4
	ZOL4 482415	1359	1443	1495	1587	48	24	14.75	56	10
	Round Tables									
	ZOL4 18D15	1170	1244	1288	1367	18	-	14.75	16	3
	ZOL4 24D15	1251	1318	1374	1452	24	-	14.75	23	5
	ZOL4 30D15	1391	1474	1530	1619	30	-	14.75	34	8
	Square Table - Round Corners									
	ZOL4 EC181815	1275	1328	1320	1376	18	18	14.75	21	3
	ZOL4 EC241815	1434	1492	1493	1555	24	18	14.75	25	4
	ZOL4 EC242415	1578	1639	1686	1752	24	24	14.75	30	5
	ZOL4 EC482415	2264	2354	2408	2504	48	24	14.75	51	10
	Ellipse Table									
	ZOL4 E241815	1327	1378	1499	1559	24	18	14.75	22	4
	ZOL4 E322415	1610	1673	1788	1858	32	24	14.75	32	7
	ZOL4 E482915	2016	2096	2254	2345	48	29	14.75	53	12

Zola Solid Surface Upcharges	Grades			
	A-White	A-Color	B	C
ZOL4 1818	287	301	352	409
ZOL4 2424	460	469	560	662
ZOL4 2418	343	364	433	510
ZOL4 4824	771	791	970	1170
ZOL4 18D	274	290	339	396
ZOL4 24D	410	443	533	633
ZOL4 30D	658	716	942	1136
ZOL4 EC1818	287	301	352	409
ZOL4 EC2418	343	364	433	510
ZOL4 EC2424	460	469	560	662
ZOL4 EC4824	771	791	970	1170
ZOL4 E2418	343	364	433	510
ZOL4 E3224	543	581	699	834
ZOL4 E4829	908	949	1164	1405

The Solid Surface top option is priced as an upcharge to existing table price. Please add a "S" to the end of the model number and then add the upcharge listed under Solid Surface ie: ZOL4 18D15S. Zola Solid Surface tables have a 1/2" thickness on top of the existing table, with a 1 mm overhang (soft radius vertical edge).

# ZOLA | FREESTANDING TABLES

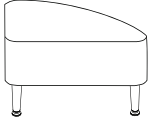
DESCRIPTION	MODEL	BEECH PALETTE LAMINATE	MAPLE CHERRY	LAMINATE TOP W/BEECH SIDES	LAMINATE TOP W/ MAPLE/CHERRY SIDES	W	D	H	WEIGHT	CUBE	
	Triangular Tables - Rounded Corners										
	ZOL4 CR45D1815	1192	1240	1207	1257	15.75	18	14.75	17	2.5	
	ZOL4 CR45D2415	1354	1408	1404	1459	20.5	24	14.75	22	4.5	
	ZOL4 CR45D2915	1639	1705	1734	1803	25	29	14.75	27	7	
	ZOL4 CR90D1815	1465	1526	1529	1585	17.5	18	14.75	23	3	
	ZOL4 CR90D2415	1730	1801	1813	1885	36.25	24	14.75	29	7.5	
	ZOL4 CR90D2915	2066	2148	2109	2194	44.5	29	14.75	35	11	

Zola Solid Surface Upcharges	Grades			
	A-White	A-Color	B	C
ZOL4 CR45D18	270	286	333	386
ZOL4 CR45D24	403	432	512	602
ZOL4 CR45D29	542	573	687	815
ZOL4 CR90D18	339	371	441	518
ZOL4 CR90D24	576	613	740	885
ZOL4 CR90D29	815	846	1033	1242

The Solid Surface top option is priced as an upcharge to existing table price. Please add a "S" to the end of the model number and then add the upcharge listed under Solid Surface ie: ZOL4 18D15S. Zola Solid Surface tables have a 1/2" thickness on top of the existing table, with a 1 mm overhang (soft radius vertical edge).

## TRIANGULAR TABLE DIMENSIONS

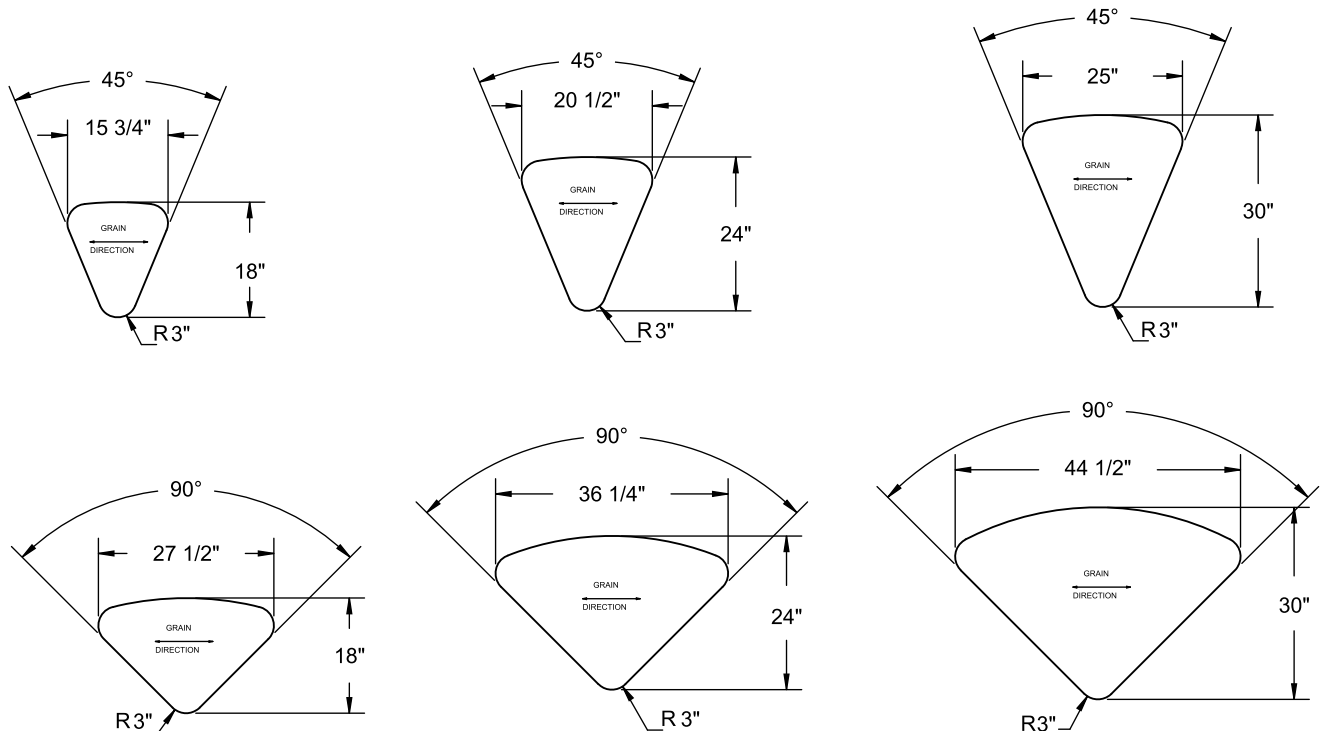

# SUTTON | ENVIRONMENTAL SUMMARY

## LEED CI CREDITS

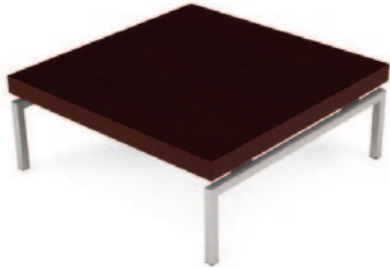

MATERIAL CONTENT:

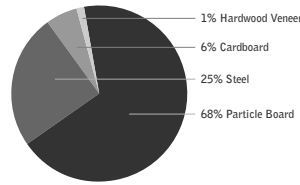

PRE-CONSUMER  
RECYCLED CONTENT = 75.72%

POST-CONSUMER  
RECYCLED CONTENT = 10.43%

Up to 5.80% of this Sutton product is recyclable at the end of its useful life.

### CONTRIBUTES TO

CREDIT	CONTRIBUTES TO	POINTS
CREDIT 2.1 - 2.2	Construction Waste Management	1-2 point(s)
CREDIT 3.3	Resource Reuse	1 point
CREDIT 4.1	Recycled Content	1 point
CREDIT 4.2	Recycled Content	1 point
CREDIT 4.5	Low Emitting Materials, Systems & Seating	1 point
CREDIT 5.1	Regional Materials*	1 point
CREDIT 7	Certified Wood (MUST BE REQUESTED)	1 point(s)

\*This credit is only applicable if in total 20% of the combined value of the procurement of construction materials and in the furniture are manufactured within a radius of 500 miles. This credit will apply if the installation of the finished product occurs within 500 miles of Kitchener, Ontario.

## level® CERTIFICATION, AIR EMISSIONS AND FSC® CERTIFICATION



### level® CERTIFICATION

BIFMA's e3 Furniture Sustainability Standard is a voluntary, multi-attribute standard that measures the degree of sustainability of furniture. This standard evaluates product and company environmental attributes and compliance systems in a wide range of elements which include Materials, Energy & Atmosphere, Human & Ecosystem Health and Social Responsibility. Sutton products have earned level®, BIFMA's sustainability certification program for furniture, certification through third-party verification against the e3 standard.



the mark of responsible forest

### AIR EMISSIONS

All Sutton products are supplied air-emissions certified. Contact customer service for information.

### FSC®

In 2005, Krug received Forest Stewardship Council® (FSC®) Chain-of-Custody certification for our manufacturing facilities. The FSC® Chain-of-Custody tracks certified wood from seedling to final sale. It verifies that the material for our FSC® certified products only come from well-managed, FSC®-certified forests and other controlled sources. FSC® is dedicated to the promotion of responsible forest management worldwide helping to take care of forests for future generations. Sutton and other Krug products can be specified with FSC® Certification. Contact customer service for further information, pricing and lead times.



Architects, designers, and building professionals can specify FSC®-certified products in order to achieve a point from the U.S. Green Building Council's Leadership in Energy and Environmental Design (LEED) Rating System.

# SUTTON | OCCASIONAL TABLES

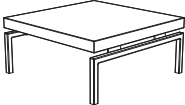
DESCRIPTION/MODEL	LAMINATE	FINISHES		DIMENSIONS			SHIPPING WEIGHT	CUBIC FEET
		OAK, CHERRY, MAPLE WALNUT, MEDIUM ANIGRE		W	D	H		
	SUTTON SQUARE							
	SUT4-24-24-16	992	1106	24	24	16	48	8
	SUT4-24-24-21	1039	1155	24	24	21	49	10
	SUT4-30-30-11	1117	1240	30	30	11	65	7
	SUT4-30-30-16	1139	1266	30	30	16	69	11
	SUT4-48-24-16	1285	1429	48	24	16	83	14
	SUT4-48-24-21	1316	1463	48	24	21	84	18
	SUT4-48-30-11	1378	1530	48	30	11	96	11
	SUT4-48-30-16	1409	1565	48	30	16	98	15

**ORDERING PROCEDURE**

To order please specify the following:

1. Select model number
2. Select a finish or laminate for the table

**STANDARD FINISHES**

Sutton is available in Maple, Cherry, Oak, Walnut and Medium Anigre finishes. Oak finishes are available on Rift Oak veneer. For a complete list of standard wood finishes please see page 335.

**STANDARD WOOD SPECIES**

Standard wood species available: Cherry, Maple, Rift Oak.

**LAMINATE**

Sutton is available in laminate. Please seep pricing above. Please see page 336 for laminate selection. Laminate is not available on *KrugExpress*.

**BASES**

Bases are available in Silver Metallic only.

# VIRTU TABLES | ENVIRONMENTAL SUMMARY

## LEED CERTIFICATION



MATERIAL CONTENT:

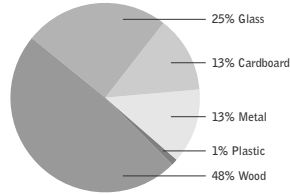

PRE-CONSUMER  
RECYCLED CONTENT = 67.31%

POST-CONSUMER  
RECYCLED CONTENT = 12.15%

Up to 45.80% of this Virtu product is recyclable at the end of its useful life.

### CONTRIBUTES TO

CREDIT 2.1 - 2.2	Construction Waste Management	1-2 point(s)
CREDIT 3.3	Resource Reuse	1 point
CREDIT 4.1	Recycled Content	1 point
CREDIT 4.2	Recycled Content	1 point
CREDIT 4.5	Low Emitting Materials, Systems & Seating	1 point
CREDIT 5.1	Regional Materials*	1 point
CREDIT 7	Certified Wood (MUST BE REQUESTED)	1 point(s)

\*This credit is only applicable if in total 20% of the combined value of the procurement of construction materials and in the furniture are manufactured within a radius of 500 miles. This credit will apply if the installation of the finished product occurs within 500 miles of Kitchener, Ontario.

## level® CERTIFICATION, AIR EMISSIONS AND FSC® CERTIFICATION



### level® CERTIFICATION

BIFMA's e3 Furniture Sustainability Standard is a voluntary, multi-attribute standard that measures the degree of sustainability of furniture. This standard evaluates product and company environmental attributes and compliance systems in a wide range of elements which include Materials, Energy & Atmosphere, Human & Ecosystem Health and Social Responsibility. Virtu products have earned level®, BIFMA's sustainability certification program for furniture, certification through third-party verification against the e3 standard.

### AIR EMISSIONS

All Virtu products are supplied air-emissions certified. Contact customer service for information.



the mark of responsible forest

### FSC®

In 2005, Krug received Forest Stewardship Council® (FSC®) Chain-of-Custody certification for our manufacturing facilities. The FSC® Chain-of-Custody tracks certified wood from seedling to final sale. It verifies that the material for our FSC® certified products only come from well-managed, FSC®-certified forests and other controlled sources. FSC® is dedicated to the promotion of responsible forest management worldwide helping to take care of forests for future generations. Virtu and other Krug products can be specified with FSC® Certification. Contact customer service for further information, pricing and lead times.

Architects, designers, and building professionals can specify FSC®-certified products in order to achieve a point from the US. Green Building Council's Leadership in Energy and Environmental Design (LEED) Rating System.



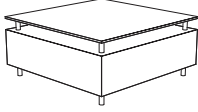

# VIRTU | OCCASIONAL TABLES

DESCRIPTION/MODEL	Oak, Cherry, Maple STYLE 1			Dimensions			Shipping Weight	Cubic Feet
	W	D	H					
	Square - Frosted Glass Top							
	VIR4-18-18-21-1	1588		18	18	21	40	8
	VIR4-24-24-16-1	1693		24	24	16	52	13
	VIR4-24-24-21-1	1884		24	24	21	52	13
	VIR4-30-30-21-1	2286		30	30	21	63	19
	VIR4-36-36-16-1	2718		36	36	16	85	27
	VIR4-42-42-16-1	2971		42	42	16	95	21
VIR4-48-24-16-1	3239		48	24	16	78	25	

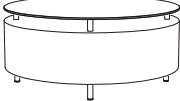
DESCRIPTION/MODEL	Oak, Cherry, Maple			Dimensions			Shipping Weight	Cubic Feet
	W	D	H					
	Round - Frosted Glass Top							
	VIR4-24D-16-1	1837		24	-	16	52	13
	VIR4-36D-16-1	3251		36	-	16	85	27
	VIR4-24D-21-1	2118		24	-	21	52	13

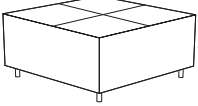
DESCRIPTION/MODEL	Oak, Cherry, Maple			Dimensions			Shipping Weight	Cubic Feet	
	STYLE 1	STYLE 2	LAMINATE	W	D	H			
	Square - Wood Top								
	VIR4-18-18-21-0	1284	1376	1384	18	18	21	40	8
	VIR4-24-24-16-0	1345	1416	1468	24	24	16	52	13
	VIR4-24-24-21-0	1440	1539	1565	24	24	16	52	13
	VIR4-30-30-21-0	1706	1823	1818	30	30	21	63	19
	VIR4-36-36-16-0	2007	2134	2166	36	36	16	85	27
	VIR4-42-42-16-0	2926	3068	3082	42	42	16	95	21
VIR4-48-24-16-0	2685	2874	2767	48	24	16	78	25	

**ORDERING NOTES**

A Style (1 or 2) must be selected and noted clearly on Purchase Order.

DESCRIPTION/MODEL	Oak, Cherry, Maple			Dimensions			Shipping Weight	Cubic Feet	
	STYLE 1	STYLE 2	LAMINATE	W	D	H			
	Round - Wood Top								
	VIR4-24D-16-0	960	1030	1108	24	-	16	52	13
	VIR4-36D-16-0	1834	1960	2087	36	-	16	85	27
	VIR4-24D-21-0	1244	1331	1391	24	-	21	52	13

**ORDERING NOTES**

A Style (1 or 2) must be selected and noted clearly on Purchase Order.

**ORDERING PROCEDURE**

To order please specify the following:

1. Select model number
2. Select a finish for the table
3. Select Style 1 or Style 2

**CODE DESCRIPTION**

STYLE 1 - Book matched veneer top  
 STYLE 2 - Reverse diamond patterned veneer top ( recommended in a clear or light finish only)

**STANDARD FINISHES**

Virtu is available in Maple, Cherry, Oak, Walnut and Medium Anigre finishes. Oak finishes are available on Rift Oak veneer. For a complete list of standard wood finishes please see page 335.

**STANDARD WOOD SPECIES**

Standard wood species available: Cherry, Maple, Rift Oak.

**METAL DETAILING**

Metal detailing is available in Silver Metallic only.

**GLASS**

Glass is available in frosted only. Glass tempered and 8mm thick. Floats on clear rubber bumpers.

# MILLENNIUM | ENVIRONMENTAL SUMMARY

## LEED CERTIFICATION



MATERIAL CONTENT:

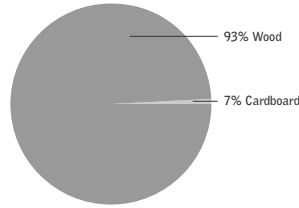

PRE-CONSUMER  
RECYCLED CONTENT = 6.43%

POST-CONSUMER  
RECYCLED CONTENT = 16.25%

Up to 38.93% of this Millennium product is recyclable at the end of its useful life.

		CONTRIBUTES TO
CREDIT 2.1 - 2.2	Construction Waste Management	1-2 point(s)
CREDIT 3.3	Resource Reuse	1 point
CREDIT 4.1	Recycled Content	1 point
CREDIT 4.5	Low Emitting Materials, Systems & Seating	1 point
CREDIT 5.1	Regional Materials*	1 point
CREDIT 7	Certified Wood (MUST BE REQUESTED)	1 point(s)

\*This credit is only applicable if in total 20% of the combined value of the procurement of construction materials and in the furniture are manufactured within a radius of 500 miles. This credit will apply if the installation of the finished product occurs within 500 miles of Kitchener, Ontario.

## level® CERTIFICATION, AIR EMISSIONS AND FSC® CERTIFICATION



### level® CERTIFICATION

BIFMA's e3 Furniture Sustainability Standard is a voluntary, multi-attribute standard that measures the degree of sustainability of furniture. This standard evaluates product and company environmental attributes and compliance systems in a wide range of elements which include Materials, Energy & Atmosphere, Human & Ecosystem Health and Social Responsibility. Millennium products have earned level®, BIFMA's sustainability certification program for furniture, certification through third-party verification against the e3 standard.

### AIR-EMISSIONS

All Millennium products are supplied with air-emissions certified. Contact customer service for information.





### FSC®

In 2005, Krug received Forest Stewardship Council® (FSC®) Chain-of-Custody certification for our manufacturing facilities. The FSC® Chain-of-Custody tracks certified wood from seedling to final sale. It verifies that the material for our FSC® certified products only come from well-managed, FSC®-certified forests and other controlled sources. FSC® is dedicated to the promotion of responsible forest management worldwide helping to take care of forests for future generations. Millennium and other Krug products can be specified with FSC® Certification. Contact customer service for further information, pricing and lead times.

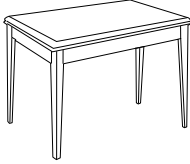

Architects, designers, and building professionals can specify FSC®-certified products in order to achieve a point from the U.S. Green Building Council's Leadership in Energy and Environmental Design (LEED) Rating System.

# MILLENNIUM | OCCASIONAL TABLES

DESCRIPTION/MODEL	FINISHES		DIMENSIONS			SHIPPING WEIGHT	CUBIC FEET	
	OAK	CHERRY, MAPLE WALNUT, MEDIUM ANIGRE	L	W	H			
	MILLENNIUM SQUARE, AND RECTANGLE							
	6800-18-18-21	730	838	18	18	21	19	5
	6800-18-18-29	767	886	18	18	29	23	9
	6800-24-18-21	804	931	24	18	21	20	6
	6800-24-24-21	834	954	24	24	21	23	8
	6800-26-26-21	869	984	26	26	21	26	9
	6800-30-30-16	961	1093	30	30	16	34	8
	6800-48-18-16	1048	1215	48	18	16	36	9
6800-48-18-29	1266	1425	48	18	29	46	15	
	MILLENNIUM ROUND							
	6800-24Dia.	1205	1386	24 Dia.		21	27	8
	6800-30Dia.	1273	1446	30 Dia.		16	38	8
	6800-36Dia.	1380	1555	36 Dia.		16	42	12

## MILLENNIUM EDGE DETAIL PROFILES

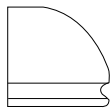

SEVILLE

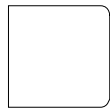

TORRENS

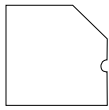

VALEN

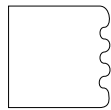

MADRID

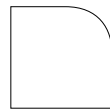

BARCELONA

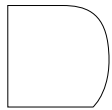

ZAMORA



WILLIAMSBURG

An edge detail profile must be selected for Millennium occasional tables.

## ORDERING NOTES

Optional laminate inlay available at a 10% upcharge. Please contact Customer Service for more information. Laminate is not available on *KrugExpress*.

## ORDERING PROCEDURE

To order please specify the following:

1. Select model number
2. Select a finish for the table
3. Select and edge detail profile

Dimensions are in inches and approximate. Contact Customer Service if dimensions are critical.

## STANDARD FINISHES

Millennium tables are available in Maple, Cherry, Oak, Walnut and Medium Anigre finishes, please see page 335.

## STANDARD WOOD SPECIES

Standard wood species available: Oak, Cherry & Maple.

## BIRDSEYE MAPLE

Bookmatched Birdseye Maple Veneer is available on Millennium occasional tables at an upcharge of **\$76 list** per square foot. Birdseye Maple is recommended in a clear finish only.

# PRADO | ENVIRONMENTAL SUMMARY

## LEED CI CREDITS



MATERIAL CONTENT:

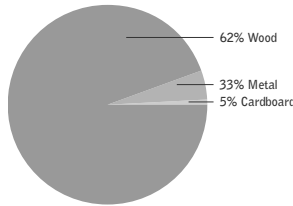

PRE-CONSUMER  
RECYCLED CONTENT = 60%

POST-CONSUMER  
RECYCLED CONTENT = 15%

Up to 88.5% of this Prado product is recyclable at the end of its useful life.

	CONTRIBUTES TO	
CREDIT 2.1 - 2.2	Construction Waste Management	1-2 point(s)
CREDIT 3.3	Resource Reuse	1 point
CREDIT 4.1	Recycled Content	1 point
CREDIT 4.2	Recycled Content	1 point
CREDIT 4.5	Low Emitting Materials, Systems & Seating	1 point
CREDIT 5.1	Regional Materials*	1 point
CREDIT 7	Certified Wood (MUST BE REQUESTED)	1 point(s)

\*This credit is only applicable if in total 20% of the combined value of the procurement of construction materials and in the furniture are manufactured within a radius of 500 miles. This credit will apply if the installation of the finished product occurs within 500 miles of Kitchener, Ontario.

## level® CERTIFICATION, AIR EMISSIONS AND FSC® CERTIFICATION



### level® CERTIFICATION

BIFMA's e3 Furniture Sustainability Standard is a voluntary, multi-attribute standard that measures the degree of sustainability of furniture. This standard evaluates product and company environmental attributes and compliance systems in a wide range of elements which include Materials, Energy & Atmosphere, Human & Ecosystem Health and Social Responsibility. Prado products have earned level®, BIFMA's sustainability certification program for furniture, certification through third-party verification against the e3 standard.



### AIR EMISSIONS

All Prado products are supplied air-emissions certified. Contact customer service for information.

### FSC®

In 2005, Krug received Forest Stewardship Council® (FSC®) Chain-of-Custody certification for our manufacturing facilities. The FSC® Chain-of-Custody tracks certified wood from seedling to final sale. It verifies that the material for our FSC® certified products only come from well-managed, FSC®-certified forests and other controlled sources. FSC® is dedicated to the promotion of responsible forest management worldwide helping to take care of forests for future generations. Prado and other Krug products can be specified with FSC® Certification. Contact customer service for further information, pricing and lead times.



Architects, designers, and building professionals can specify FSC®-certified products in order to achieve a point from the U.S. Green Building Council's Leadership in Energy and Environmental Design (LEED) Rating System.

# PRADO | OCCASIONAL TABLES

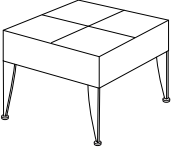
DESCRIPTION/MODEL	FINISHES			DIMENSIONS			SHIPPING WEIGHT	CUBIC FEET	
	CHERRY, MAPLE, WALNUT, MEDIUM ANIGRE			L	W	H			
	STYLE 1	STYLE 2	LAMINATE						
	PRADO SQUARE AND RECTANGULAR								
	5610-18-18-16	1332	1433	1332	18	18	16	40	3
	5610-18-18-21	1345	1452	1345	18	18	21	42	4
	5610-18-24-16	1378	1482	1378	18	24	16	47	4
	5610-18-24-21	1402	1504	1402	18	24	21	49	5
	5610-24-24-16	1430	1538	1430	24	24	16	53	5
	5610-24-24-21	1456	1565	1456	24	24	21	55	7
	5610-30-30-16	1483	1620	1483	30	30	16	69	8
	5610-30-30-21	1534	1647	1534	30	30	21	72	11
	5610-36-36-16	1569	1686	1569	36	36	16	88	14
	5610-36-36-21	1593	1714	1593	36	36	21	90	15
	5610-48-24-16	1613	1738	1613	48	24	16	102	11
	5610-48-24-21	1641	1767	1641	48	24	21	108	14

### ORDERING NOTES

A Style (1 or 2) must be selected and noted clearly on Purchase Order.

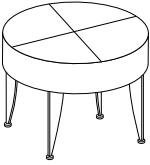
	PRADO ROUND							
	5611-18D-16	1494	1607	1494	18 Dia. -	16	35	3
	5611-18D-21	1534	1647	1534	18 Dia. -	21	37	4
	5611-24D-16	1587	1702	1587	24 Dia. -	16	46	5
	5611-24D-21	1613	1734	1613	24 Dia. -	21	49	7
	5611-30D-16	1716	1844	1716	30 Dia. -	16	59	11
	5611-30D-21	1765	1894	1765	30 Dia. -	21	63	12
	5611-36D-16	2020	2174	2020	36 Dia. -	16	74	12
5611-36D-21	2085	2241	2085	36 Dia. -	21	79	15	

### ORDERING NOTES

A Style (1 or 2) must be selected and noted clearly on Purchase Order.

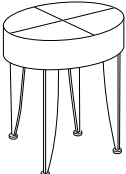
	PRADO OVAL								
	5612-18-24-16	1999	2145	1999	18	24	16	47	5
	5612-18-24-21	2107	2263	2107	18	24	21	49	6
	5612-42-24-16	2418	2606	2418	42	24	16	102	9
5612-42-24-21	2541	2735	2541	42	24	21	104	14	

### ORDERING NOTES

Prado comes with Silver Metallic legs. Legs with special finishes are available at 10% list upcharge and minimum order quantity of 25 units. Extra lead time is required. Please contact Customer Service for more information.

### ORDERING PROCEDURE

To order please specify the following:

1. Select model number
2. Select Style 1 or Style 2
3. Select a finish for the table

Dimensions are in inches and approximate. Contact Customer Service if dimensions are critical.

### CODE DESCRIPTION

STYLE 1 - Book matched veneer top  
 STYLE 2 - Reverse diamond patterned veneer top ( recommended in a clear or light finish only)

### STANDARD FINISHES

Prado is available in Cherry, Maple, Walnut and Medium Anigre finishes. For a complete list of standard wood finishes please see page 335.

### STANDARD WOOD SPECIES

Standard wood species available: Cherry & Maple.

### METAL DETAILING

Prado comes with Silver Metallic legs. Legs with special finishes are available at 10% list upcharge and minimum order quantity of 25 units. Extra lead time is required. Please contact Customer Service for more information.

# CARLYLE TABLE | ENVIRONMENTAL SUMMARY

## LEED CI CREDITS



MATERIAL CONTENT:

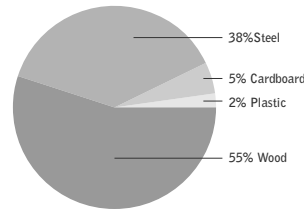

PRE-CONSUMER  
RECYCLED CONTENT = 50%

POST-CONSUMER  
RECYCLED CONTENT = 15%

Up to 49.33% of this Carlyle product is recyclable at the end of its useful life.

### CONTRIBUTES TO

CREDIT 2.1 - 2.2	Construction Waste Management	1-2 point(s)
CREDIT 3.3	Resource Reuse	1 point
CREDIT 4.1	Recycled Content	1 point
CREDIT 4.2	Recycled Content	1 point
CREDIT 4.5	Low Emitting Materials, Systems & Seating	1 point
CREDIT 5.1	Regional Materials*	1 point
CREDIT 7	Certified Wood (MUST BE REQUESTED)	1 point(s)

\*This credit is only applicable if in total 20% of the combined value of the procurement of construction materials and in the furniture are manufactured within a radius of 500 miles. This credit will apply if the installation of the finished product occurs within 500 miles of Kitchener, Ontario.

## level® CERTIFICATION, AIR EMISSIONS AND FSC® CERTIFICATION



### level® CERTIFICATION

BIFMA's e3 Furniture Sustainability Standard is a voluntary, multi-attribute standard that measures the degree of sustainability of furniture. This standard evaluates product and company environmental attributes and compliance systems in a wide range of elements which include Materials, Energy & Atmosphere, Human & Ecosystem Health and Social Responsibility. Carlyle products have earned level®, BIFMA's sustainability certification program for furniture, certification through third-party verification against the e3 standard.

### AIR-EMISSIONS

All Carlyle products are supplied with air-emissions certified. Contact customer service for information.



### FSC®

In 2005, Krug received Forest Stewardship Council® (FSC®) Chain-of-Custody certification for our manufacturing facilities. The FSC® Chain-of-Custody tracks certified wood from seedling to final sale. It verifies that the material for our FSC® certified products only come from well-managed, FSC®-certified forests and other controlled sources. FSC® is dedicated to the promotion of responsible forest management worldwide helping to take care of forests for future generations. Carlyle and other Krug products can be specified with FSC® Certification. Contact customer service for further information, pricing and lead times.



Architects, designers, and building professionals can specify FSC®-certified products in order to achieve a point from the U.S. Green Building Council's Leadership in Energy and Environmental Design (LEED) Rating System.

# CARLYLE | OCCASIONAL TABLES

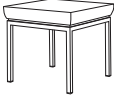
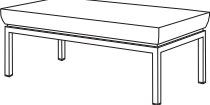
DESCRIPTION/MODEL	FINISHES		W	D	H	SHIPPING WEIGHT	CUBIC FEET
	CHERRY, MAPLE	WALNUT, MEDIUM ANIGRE					
	CAR4-18-18-24	1191	18	18	24	30	5.5
	CAR4-24-24-22	1283	24	24	22	32	9
	CAR4-42-21-16	1598	42	21	16	65	9.9

## ORDERING PROCEDURE

To order please specify the following:

1. Select model number
2. Select a finish for the wood frame

Dimensions are in inches and approximate. Contact Customer Service if dimensions are critical.

## STANDARD FINISHES

Carlyle is available in Cherry, Maple, Walnut and Medium Anigre finishes. For a complete list of standard wood finishes please see page 335.

## STANDARD WOOD SPECIES

Standard wood species available: Cherry & Maple.

## METAL DETAILING

The legs on the Carlyle series feature a Silver Metallic finish.

# GENERAL INFORMATION

## Terms and Conditions

Net 30 days on approved credit. A late payment charge of 1% per month will be applied on overdue invoices. This charge will be pro-rated to the number of days past 30 days that the invoice is overdue. All applicable sales taxes are extra. Distribution of this price list does not in itself constitute an offer to sell. Orders can be received only from authorized Krug dealers. Acceptance of any order and terms of sale may be established at the discretion of Krug. Deposits are required on orders received from new accounts as well as on large or special orders. Krug reserves the right to discontinue designs, or to change designs, construction, prices, or materials without notice.

## Contact Information

Phone: 1.888.578.KRUG (5784) | Fax: 1.519.748.5177

Purchase Order Fax: 1.888.236.4783

Purchase Order E-mail: orders@krug.ca

Web: www.krug.ca E-mail: solutions@krug.ca

## Customer Service Hours

Please note customer service hours are:

8:30 am to 5:00 pm est

## Customer Satisfaction

It is the primary goal of Krug and our staff to ensure the complete satisfaction of our customers with our products and performance. If a problem arises with a Krug product after the expiration of the limited warranty period, Krug will exercise its best efforts to achieve the satisfaction of the customer in a manner that is fair to all concerned.

## Order Acknowledgments

Each order will be acknowledged via e-mail or fax. This acknowledgment is the final agreement between Krug and the customer, superseding all previous communications regarding the purchase order. Where there is a discrepancy on a purchase order between a product code and a description, Krug will make every effort to resolve the discrepancy, but will be ruled by the product code ordered. Please check all acknowledgments for accuracy, and advise Krug of any discrepancies with a purchase order.

## Order Cancellation

Krug reserves the right to not accept or allow cancellation of orders. All products are manufactured on a custom-made, make-to-order basis, and the purchasing, engineering and production of orders begins shortly after order placement - and the customer purchase order is a contract that authorizes Krug to manufacture the products. Acceptance of order cancellation (or partial cancellation) is solely at the discretion of Krug, and is dependent on the extent to which engineering, purchasing and manufacturing has been initiated by the time cancellation is requested. No order cancellations (partial or otherwise) are allowable more than 4 weeks from date of order placement (as order production is unable to be terminated by that point), and full payment of the acknowledged order value is required for any orders cancelled after 4 weeks. Cancellations may be allowable in less than 4 weeks after order placement, depending on the extent to which manufacturing has been initiated. An acceptance of order cancellation requires that the purchaser agrees to make payment for all costs incurred to the point of acceptance of cancellation. Cancellation charges include all costs for purchase of dedicated material and components, engineering costs for non-standard products, and all costs for manufacturing completed to that point, as well as a \$367 net charge for processing of the original order and for processing of cancellation invoicing.

## Pricing

Krug endeavors to ensure that all prices in this price list reflect accurately our current prices. However, errors do occur and will be rectified through notices to the field. Krug reserves the right to acknowledge pricing that may be different from the price list.

## Storage Charges

Krug reserves the right to assess a nominal storage charge if a customer does not accept shipment of an order within a week of the ship date.

## Warranty

Krug warrants the construction and the finish of all our products to be free from defects in materials and workmanship for a period of 10 years from the date of purchase. This warranty is applicable to products in use by their original purchaser. This warranty does not apply to components not manufactured by Krug including textiles, which are subject to the specific warranties of those manufacturers, if any. Textiles (fabric, leather, vinyl, or any other covering material) suppliers do not guarantee their products for durability and color fastness, and nor does Krug. Casters, mechanical and electrical components have a warranty of five years from the date of purchase. The Krug warranty does not apply to COM-specified materials, damage caused by a carrier other than Krug, or variation in wood finishes due to natural wood color variation. Krug cannot be held responsible for variations in fabric dye lots from order to order. All fabric is carefully inspected when it is received, but a degree of variation in color should be expected. Repairs or replacement of any defect covered under this warranty by Krug will be made, at our option and method, at no charge to the original purchaser during the warranty period. Krug's judgement is final and binding with respect to the nature or cause of defects or damage, and the necessity or manner of repair or replacement.

This warranty does not apply to defects or damage resulting from:

- normal wear and tear occurring with the use of the product
- negligence, misuse, excessive use, alteration, improper cleaning or repair
- substitution or use of incorrect or unauthorized components or material
- handling or installation that is incorrect, or that causes damage or defect
- damage incurred by a freight carrier other than Krug
- wearing of finishes and fabrics, and normal variations in materials (including dye lot variations)
- properties of natural materials, including wood and leather
- exposure to environments with uncontrolled temperature and humidity (products must be transported, stored and used in climate-controlled conditions)

## Blanket Wrapping

Krug will blanket wrap larger seating orders at customer's request. Please indicate on your purchase order and contact Customer Service.

## Export Packaging

Krug is pleased to provide the option for export packaging on all our products, to provide additional protection from damage. For shipments overseas, a quote for export packaging can be provided, based on the products to be ordered and the delivery destination - please contact Customer Service or Bids & Specification Support for more information and a quotation. KRUG is not responsible for shipment damage occurring on overseas shipments

Export Packaging is STRONGLY RECOMMENDED for:

- (A) all shipments outside of the lower 48 states and Canada.
- (B) all shipments that will be held in storage for an extended period prior to installation.

**Important:** Please note that Krug will not be responsible for damage claims on product shipped or stored in the above conditions but where export packaging has not been utilized.

## Dimensions

Dimensions are in inches and approximate, and subject to change without notice. Contact Customer Service if dimensions are critical.

## Installation Support

For assistance please contact Technical Support at 1-888-578-5784 x216 or e-mail installationhelp@krug.ca and you will be directed to the appropriate installation support person.



## Freight Terms and Conditions

1. All product is shipped FOB the Krug factory. Freight is either pre-paid to the destination or not pre-paid, depending on established customer specific freight terms.

2. Docks at the selected delivery location must be equipped to handle a 53' trailer. If a dock is inadequate for delivery by Krug, Krug will re-deliver to another local location and any additional costs will be charged to the customer.

3. For all deliveries, it is understood that Krug or its agent is making a dock delivery only (equipped to handle a 53' trailer), and any further work of truck unloading, delivery beyond the dock, installation, and removal of packaging is not authorized or paid for by Krug.

4. Drop shipments to the installation site, and timed deliveries, are available on larger shipments (full truckloads or slightly less) at no additional charge. Drop shipments or timed deliveries for smaller shipments may not be available, or if available will require a surcharge. Deliveries on an after hours basis, or on weekends, or any other special requirements, may be subject to a surcharge. Location and contact information, and the requested time of delivery, is required at least one week prior to the acknowledged shipment date. If this information is not provided one week in advance, or if the location or time of the drop shipment is changed less than one week in advance, a surcharge may be applied, and/or the drop shipment may not be scheduled. For deliveries requested Monday to Thursday after 5:00 pm, please apply a surcharge of \$262/shipment. For deliveries requested Monday to Friday before 7:00 am, please apply a surcharge of \$262/shipment. For deliveries requested Friday (after 3:00 pm) or weekends, please apply a surcharge of \$525/shipment. (local times).

5. For all deliveries - whether to the Customer location or drop shipment - any circumstances that result in the delay of our carrier (including unsuitable receiving facilities, or facilities not open or available), service charges will be applied at the rate of \$125/hour. Where re-delivery is necessary because of these circumstances, the full cost of re-delivery will be charged. If Less Than Truck Load is delivering, one hour is allocated to unload. Any additional time required to unload after the first hour is \$125/hour. If a Truck Load is delivering the order, three hours is allocated to unload. Any additional time required to unload is \$125/hour. Direct deliveries to site for large orders are possible, (must exceed \$60,000 net), and accommodate 48 - 53' trailers. Krug is responsible for delivery to the approved delivery address. If an address change is required, this must be authorized by Krug 5 business days prior to ship date. Any additional delivery costs incurred after this time will be charged to the customer.

## Product Strength and Durability Testing

All management seating meets or exceeds the testing requirements of ANSI/BIFMA X5.1-2011. All lounge seating meets or exceeds the testing requirements of FNAE-80-214A. Specific test results and documentation are available on request.



## Damaged Shipments

All Krug product is well engineered, carefully inspected, and expertly loaded onto our trucks at our Distribution Center. If you receive any damaged freight, we ask that you do not refuse the shipment. Krug is not responsible for damage to goods that occurs in transit or storage. It is the purchaser and/or receiver's responsibility to examine the goods upon receipt and to notify Krug of any damages, overages or shortages. Any discrepancies should be noted on the Bill of Lading. The delivering carrier will not accept responsibility for shortages or damages if signed "clear". Notification of concealed damage claims must be made to Krug Distribution within 5 days of delivery, along with digital pictures if available. All product and packaging must be available for inspection. Krug liability ceases after 5 business days and Krug will not be responsible for concealed damages if shipments are left unopened. Krug is not responsible for the condition of product that is stored or installed in an environment where temperature and humidity are not controlled.

## Field Product Report Authorization

Krug's written authorization, in the form of an FPR number, must be obtained prior to incurring charges of any kind if Krug is expected to pay these charges. This includes authorization for field repairs and replacements, installation and delivery charges. Krug reserves the right to have its representative inspect product related to any request for such authorizations, prior to that authorization being provided. Deductions from invoices paid for any charges to Krug, without prior written authorization in the form of an FPR, will not be accepted. Digital photographs may be required to complete the FPR process.

## Returns

No merchandise may be returned without Krug's prior written consent. In the event of an authorized return, a Field Product Report (FPR) number will be issued, and a restocking charge will apply. Return transportation charges must be prepaid. Unauthorized returns will not be accepted and will be returned freight collect. All merchandise being returned must be properly packaged in its original or comparable replacement packaging to ensure protection of the product during handling and transportation. Returns on orders duplicated by the customer must be received in their original packaging to be accepted. Product being returned where Krug has authorized its liability for replacement or repair will be thoroughly inspected on its return, and the results compared to the reason for the return stated on the FPR. Any discrepancies, such as additional damage, signs of usage, missing parts, etc., will result in an adjustment to the amount of credit issued.

## Custom Capabilities

Over 15% of our orders involve some type of custom work, and we invite our customers to make use of our extensive capabilities.

These include:

- 1) Dimensional customization of standard size products
- 2) Custom finishes
- 3) For larger orders, completely custom-designed products, as well as non-standard wood species can be specified.

Custom orders may require additional production lead times. Contact Engineering at the e-mail address [engquotes@krug.ca](mailto:engquotes@krug.ca).

## Care and Maintenance Leather

Leather is a natural product and requires very little care during use. Most stains can be removed with a clean dry cloth. For stubborn spots and stains, use a mild non-detergent cleaner, rinse well and let air dry naturally. Do not use saddle soap, cleaning solvents, furniture polish, oils, varnish, abrasive cleaners, soaps or ammonia waters.

## Fabric Upholstery

Professional upholstery cleaning is recommended.

## Flammability Standards for Krug Fabric Program

- Passes State of California Technical Bulletin CAL 117-2013

# KRUG TEXTILES - UPHOLSTERY FABRICS



## Krug Textiles - Stocked Fabric Program

### Grade 1

#### ARLO

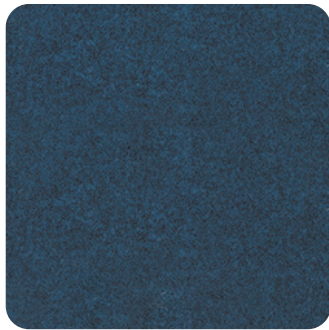

308 MIDNIGHT



306 PETROL



908 CHARCOAL



93 SEAL



601 PEARL



84 NUTMEG



62 OATMEAL



90 LIMESTONE

#### FRANKLIN



47 CAMEL



3009 MIDNIGHT

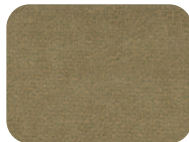

67 FAWN



97 CINDER



94 METAL



909 BLACK



9004 CHARCOAL



308 PETROL



108 ORCHID

#### COMRADE

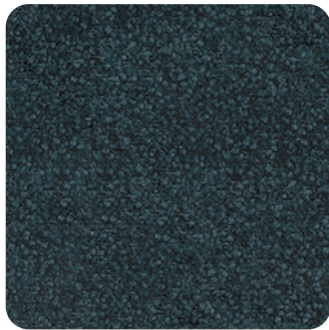

309 MIDNIGHT



84 TEAK



63 LINEN

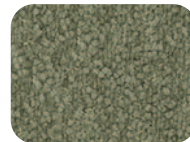

24 ALPINE



905 IRON



601 SNOW



57 MARIGOLD

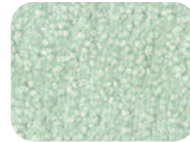

31 DUCK EGG

#### FELICITY



601 IVORY



305 SKY



603 TAUPE



93 COAL



405 HENNA



64 PUTTY



62 FAWN



36 BLUEBERRY

Krug Textiles - Stocked Fabric Program

Grade 2

**GRADDY**



25 CAPER



31 SKY



604 FLAX



901 CHAR

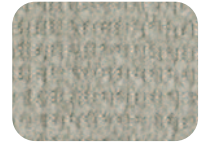

93 GRAY

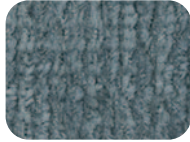

34 SLATE



84 TEAK



98 NICKLE

**YATES**



84 BIRCH



44 CLAY



87 TAUPE

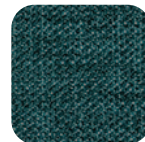

25 JUNIPER

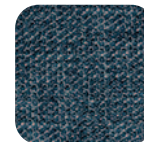

305 INDIGO



109 CRANBERRY



803 TOAST

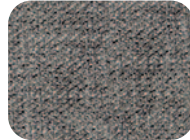

92 ZINC

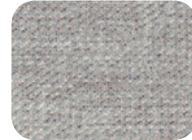

91 SILVER



908 CHARCOAL

**MCCOY**



608 TUNDRA



601 CREME



908 CHARCOAL



62 COPPER



108 CORDOVAN



32 ROBIN'S EGG



94 MERCURY



84 BARK

**ORIS**



908 DOMINO



604 BARK

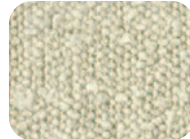

601 CREAM

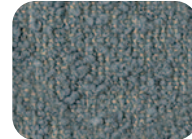

306 DELFT

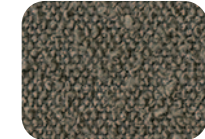

902 ZINC



305 MIDNIGHT

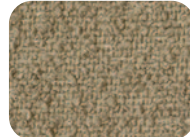

64 PUTTY

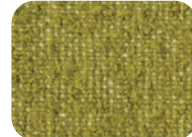

205 CHARTREUSE

# KRUG TEXTILES - UPHOLSTERY FABRICS



## Krug Textiles - Stocked Fabric Program

### Grade 3

#### MORITZ

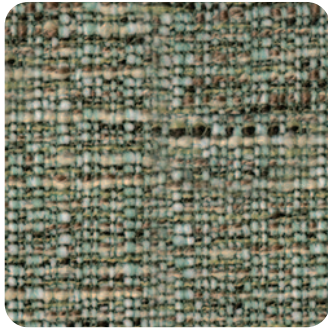

205 SPEARMINT

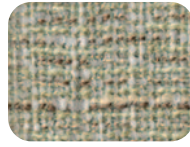

61 OYSTER

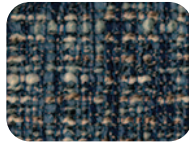

306 CADET

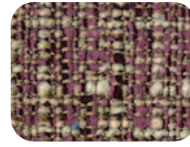

104 MULBERRY

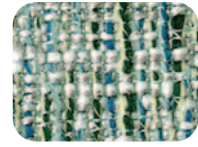

31 AEGEAN

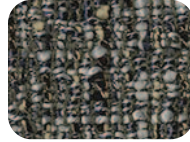

9008 CHARCOAL



82 CLAY



304 CAPRI

#### LORENZO

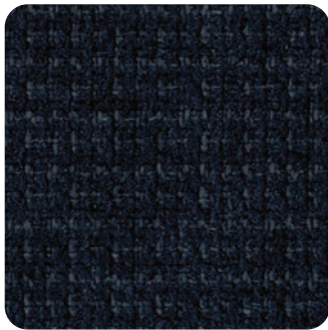

306 INDIGO



24 ALPINE



64 LINEN



91 FLANNEL

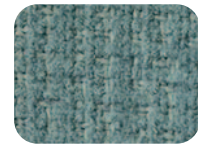

32 MIST

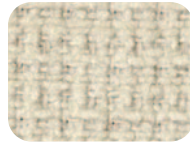

601 CREAM

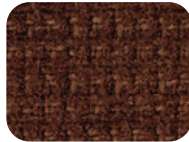

106 HENNA



604 STUCCO

#### BISCOTTI



302 CAPRI



45 SPICE



61 DESERT



91 GRANITE

#### INTRIGUE



601 OYSTER



27 OLIVE



4003 OCHRE



908 CHARCOAL



3009 MIDNIGHT



805 PECAN



608 STUCCO



605 STRAW

**Krug Textiles - Faux Leather Program - Grade 2**



**Krug Textiles - Leather Program - Grade 8**

Please contact Customer Service for specific information on leathers, available colors and lead times.

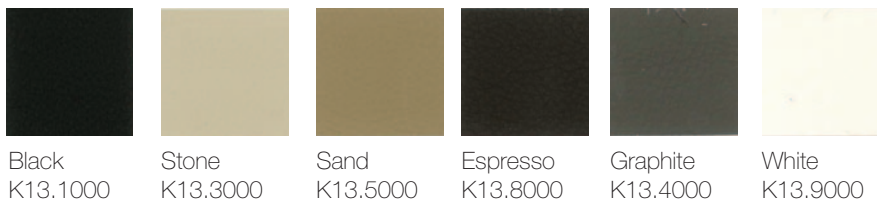

**Krug Textiles - Cut fabric NET price per yard**

Grade 1	\$22
Grade 2	\$34
Grade 3	\$46

**LATEX FREE**

Krug products are made with latex-free materials to prevent the allergic reaction that latex causes in some people.

# CUSTOMER'S OWN MATERIAL - C.O.M.

## Customer's Own Material (COM/COL)

COM/COL must be received three weeks prior to the acknowledged ship date. Orders with COM/COL not received by the required deadline will be delayed. A description of the upholstery cover, including supplier name, pattern name, upholstery cover name and color number must be included with the purchase order.

COM/COL testing requires 3 business days and samples are to be directed to Customer Service. The customer has the option of providing the sample COM/COL before, at time of order, or once the sample COM/COL is received. If the customer does not send a sample for approval in advance of sending actual material, Krug will not be responsible for the cost of any upholstery cover or other material that it determines to be unsuitable for the product or our process.

When the COM/COL upholstery cover is received at Krug, it must be clearly identified with the upholstery cover name and color, and tagged with name of the Krug customer and purchase order number. Krug will inspect all COM/COL upholstery covers when received to determine if it will be suitable for upholstery. Where Krug feels that the upholstery cover or leather specified will compromise the quality or integrity of our products, customers will be contacted to direct these concerns. Further, Krug reserves the right to refuse to accept and use any COM upholstery covers or leathers that will compromise our products in any way that is unacceptable to Krug. Krug cannot assume responsibility for the durability or tailoring quality of customer's own material.

Yardage specified in this price guide is approximate. In the case of multiple product orders, multiply the number of items by the COM yardage specified to determine upholstery cover required, unless otherwise indicated. Additional yardage may be needed if the material is less than 54" wide, or patterned or striped and requires matching. All COMs are cut "up the roll" unless otherwise stated by the customer. All striped upholstery covers will be applied vertically unless otherwise stated by the customer and after approval by Krug. Krug will not be responsible for directional or positional problems with its application of COM material, unless it has been provided with explicit instructions by the customer. Special instructions should be sent to Krug Customer Service, including a sample (or photocopy) of the upholstery cover. Krug is not responsible for instructions sent with the upholstery cover rolls, or for the method of upholstery if no instructions have been provided.

Price increases and freight charges to COM/COL acquired on the customer's behalf will be passed onto the customer.

## Application of Directional Upholstery cover

Some COM upholstery covers will be considered directional by Krug even though they are not considered directional by the supplier. All COMs are automatically cut "up the roll" unless otherwise stated by the customer (please see below).



Standard-Cut  
"up the roll"



Non-Standard-Cut  
across the roll "railroad"

## COM/COL Shipping Procedures

For seating COM/COL upholstery covers, please send upholstery covers to:

Krug Inc.  
111 Ahrens Street  
Kitchener, Ontario  
Canada N2H 4C2

**Attention: RECEIVER**

COM/COL orders cannot be scheduled into production until the upholstery cover has arrived and inspection is complete.

All packages must be clearly marked

**"For Customs Clearance by Willson International Custom Brokers".**

According to the North American Free Trade Agreement (NAFTA), goods shipped between the United States and Canada can qualify for exemption from all duties, or for a reduction in duties, if the goods can be proven to originate in either the United States, Canada or Mexico.

Canada Customs requires that a NAFTA Certificate of Origin and a Commercial Invoice be completed and sent with the upholstery cover shipment. The Commercial Invoice must clearly state the description of the upholstery cover, the selling price, the make-up or content, and the purchaser. The absence of these two documents will delay the shipments at the U.S./Canada border, thereby potentially delaying the customer order. If the total value of the shipment is less than \$1200 U.S., Customs will accept a Low Value Statement of Origin in place of the NAFTA Certificate of Origin. The Low Value Statement must be signed by a representative of the exporting company. This statement may either be included on the commercial invoice or attached to the invoice. Krug is happy to answer any questions or concerns about COM/COL shipping procedures and the required documents.

## CAL 133 & Moisture Barrier

California Technical Bulletin 133 is a flammability test for seating. Krug offers a compliance method which, in combination with non-flammable upholstery covers, may enable the products to meet certification requirements for this test. This process at the same time also provides the products with a Moisture Barrier - a treatment that helps to prevent the passage of liquids and moisture to inside of upholstered components - thereby conferring sanitary and anti-infection benefits. So when CAL 133 is specified, the product also automatically has a Moisture Barrier, and when a Moisture Barrier is specified, the product also features the compliance method and low flammability features of CAL 133.

The application of this upcharge and the compliance method does not mean that the specific configuration of product and upholstery cover are tested and officially certified as being CAL 133 compliant. If official certification is required, Krug will provide this (through an independent certified testing laboratory) at a charge of \$917 per item, plus the cost of the product to be tested. Lead time for certification testing is typically 4-8 weeks. Krug assumes no responsibility for the testing of our products in combination with upholstery covers, or for the results of any testing conducted. Some specific configurations of product and upholstery have already been tested. Please contact Customer Service for additional information.

## C.O.L. Yardage

To calculate C.O.L. yardage required, please use the following conversions based on COM yardage: Leather must be ordered in square footage.

- 17 square feet in a yard
- Approx. 3 yards in a hide
- Approx. 51 square feet in a hide
- Please use grade 3 pricing for COL

## Upholstery Cover Yardage Calculation

To calculate yardage required for COM and other non-standard upholstery cover orders, please contact Krug Customer Service at 1.888.578.5784. Unless otherwise stated, upholstery cover rolls are assumed to be a minimum 54" wide. Please use the guide below to calculate the percentage of extra upholstery cover required to cover large repeats. The repeat is calculated by adding both the vertical and horizontal measurements together and then referring to the chart below for extra yardage required.

		2"-14"	15"-19"	20"-27"	28"-36"
FABRIC	Plain	Repeat	Repeat	Repeat	Repeat
54	0%	10%	15%	20%	25%
53-50	16%	20%	25%	30%	35%
48	16%	25%	30%	35%	40%
45	40%	50%	55%	60%	65%
36	50%	60%	65%	70%	75%

# GRADED-IN UPHOLSTERY PROGRAMS

Krug has partnered with several textile brands to grade in their offerings, designed to provide a wide range of upholstery selections for our seating products.

Upholstery pricing and availability is subject to change without notice. We grade this upholstery according to the pricing of the fabric suppliers - when their pricing changes, the Krug grade may change.

When placing an order, a Krug customer must specify the complete upholstery number, along with the appropriate Krug model number and finish. Krug will supply the complete product at the prices listed. Orders specifying graded-in upholstery cannot be cancelled once the upholstery has been ordered.

## Upholstery Grades

To determine the price of a product for graded-in upholstery, use the reference lists located on Krug's website under - Products - Textiles, to view the upholstery grade (1-9). Krug is not responsible for the discontinuation of this upholstery. Please contact Customer Service for information on upholstery not listed.

When two upholstery selections are specified for use on seating, the higher grade upholstery price will apply to the order.

High Performance upholstery; Polyurethane, Vinyl or Crypton, is particularly suitable for healthcare and other intensive-use environments.

## Upholstery Samples

If you require additional samples or memos for presentation, please contact fabric supplier directly.

## Flammability Standards

- Tunnel Test Surface Ratings Class A rating
- Class 1 UFAC
- Passes State of California Technical Bulletin CAL 117-2013

Please contact fabric supplier directly for further flammability information pertaining to specific upholstery.

## Special Conditions

Acknowledgments will give the estimated delivery date of the finished product. Some upholstery is imported, and availability may affect estimated delivery time. For large projects, please contact fabric supplier directly for availability of yardage.

# KRUG EXPRESS PROGRAM

## PROGRAM DETAILS

*KrugExpress* orders are ready to ship by the date acknowledged. Delivery and shipping schedules may result in actual shipping of orders at a later date. Statutory holidays and scheduled factory vacations may add to acknowledged lead times of *KrugExpress* orders. Unless otherwise specified on the order, the customer's standard method of shipping Krug products will be utilized.

Available factory capacity for *KrugExpress* is filled by orders received on a "first come, first serve" basis. If the normal *KrugExpress* lead time is not available for your order because available capacity has been filled, you will be immediately advised of the earliest available ready-to-ship date. Please consult your Customer Service representative in advance if you wish to confirm the specific lead time availability for a *KrugExpress* order.

Orders must be received by midnight of a given day for that day to be considered the official day the order is received. Order lead times are acknowledged from the date the order is received, but not including the date the order is received.

*KrugExpress* orders must be "clean" when received in order to be considered officially received on a given day, and lead times will be acknowledged from the date orders are determined to be "clean".

Changes to *KrugExpress* orders are not allowed under any circumstances.

Orders for product on *KrugExpress* must clearly state: "*KrugExpress*".

COM and graded-in upholstery is available on Krug Express. Orders are scheduled on Krug Express, and given the best available date, when the upholstery is received at Krug. Some conditions apply.

## SEATING & OCCASIONAL TABLES PROGRAM

Orders for seating products on the *KrugExpress* program may be subject to quantity maximums. Please contact Krug Customer Service for more information.

Quantity maximums are dependent upon available capacity, in order to insure that we ship all orders on time. Please note that the CAL 133 option is not available on *KrugExpress*.

Only standard wood finishes are available for *KrugExpress* orders. Laminates are not available on *KrugExpress*.

*Krug Express* includes all Krug seating and occasional tables as well as Krug conference and casegood products to complement this seating offering.

# WOOD FINISHES

## WOOD FINISHES

Standard wood finishes are:

### Finishes on Beech

Appalachian Cherry  
American Cherry  
Imperial Cherry  
Light Cherry  
Medium Cherry  
Natural Cherry  
Sable Cherry  
Standard Cherry  
Light Oak  
Harvest Oak  
Mahogany  
Mellow Oak  
Espresso  
Cordovan Walnut  
Natural Walnut  
Regular Walnut  
SilverGrey on Walnut  
Dark Walnut  
Clear Beech  
Medium Anigre

### Finishes on Maple

Clear Maple  
Honey Maple  
Wheat Maple

## PALETTE

Palette finishes available for applicable products.

Black  
White  
Soft Green  
Steel Blue  
Slate

## WOOD FINISHES TO MATCH STANDARD LAMINATES

Willow on Beech  
Copper on Beech  
Shiraz Cherry on Beech  
Park Avenue Walnut on Beech  
Chocolate on Beech  
Nutmeg on Beech  
Portobello on Beech  
Ash on Beech  
Dune on Maple

## NATURAL CHARACTERISTICS OF WOOD

Wood is a natural product with inherent color variations that will never be fully mitigated by the finishing process. Please anticipate variation in colors within a single unit, from piece to piece, and from Krug wood finish samples. If a very close match is required, a sample must be provided with the order and an upcharge will apply. Exact color matches are not possible.

### Custom Wood Finishes

Add 10% list to your order for special finishes, minimum upcharge is \$600 list per finish per order. (For example, on all orders up to \$6000 list, an upcharge of \$600 will apply, on orders \$6000 and up add 10% list to your order.)

Special finish upcharges on seating products are calculated on a grade 1 value. For orders with special finishes, a sample that is a minimum 3" by 3" must be received with the order. Special finishes may add additional lead time to production schedules. Since wood is a natural product, some variations in grain, color and stain acceptance will occur. In our finishing processes, we try to minimize variations, but some variation between samples and finished goods should be anticipated.

### Dual Finishes

Add 10% list per item if specifying dual finish.

### Standard Wood Finishes

No upcharge will be applied when specifying a finish available as standard on one species onto maple seating and occasional tables. Clear finishes are not available on other species since they are a clear finish on top of the natural veneer color.



# LAMINATE PROGRAM

## LAMINATES

Krug's in-stock Laminates are available in 17 different laminate selections. Please note that 4 of the colors (Gingerbread, Portobello, Ash and Willow) have textured finishes and may not be appropriate for use in patient areas due to infection control concerns. Minimum order quantities and extended lead times may apply for exotic laminate colors, please check with customer service. Polymer Edge will be selected to match the worksurface. Krug's previous laminate in-stock program will be phased out as in-stock supply depletes. Please contact customer service for availability.

### IN-STOCK LAMINATES

Wood Grain Laminates	High Pressure Laminate Supplier	Textured Wood Grain Laminates	High Pressure Laminate Supplier
Champagne	Tafisa T492CR	Gingerbread	Tafisa T556UR
Hardrock Maple	Formica 86992-58	Portobello	Tafisa T557UR
Dune	Tafisa T491CR	Ash	Tafisa T535AT
Copper	Tafisa T521CR	Willow	Tafisa T543AT
Shiraz Cherry	Tafisa T472CR	<b>Solid Laminates</b>	
Park Avenue Walnut	Wilsonart 7984-38	Designer White	Wilsonart D354-60
Chocolate	Tafisa T498CR	Platinum	Tafisa T202CR
Nutmeg	Tafisa T477CR	Earth	Tafisa T767CR
Dark Walnut	Tafisa T469CR	Charcoal	Tafisa T228CR

### PHASE OUT LAMINATES

Almond - Black- Shadows - Edgewood Sycamore - Gunstock Walnut

### Non-Stocked Laminates

For specific lead time and application questions, please contact Krug Customer Service for your requirement. Upcharges will be applicable for non-stocked laminates, depending on their cost. Non-stock laminates may require a minimum order quantity, please contact customer service. Stocked polymer edges only can be specified for use with non-stocked laminates or tops will be self-edged.

## SOLID SURFACE PROGRAM

The Solid Surface option provides an enhanced durability, protection and cleanability. It is available in 8 standard colors and is replaceable if it becomes damaged or degraded. See individual products for list upcharge chart.

### GROUP GRADE A - WHITE



Glacier White



Cameo White

### GROUP GRADE A - COLOR

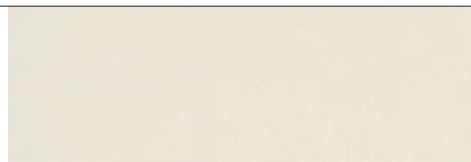

Bisque

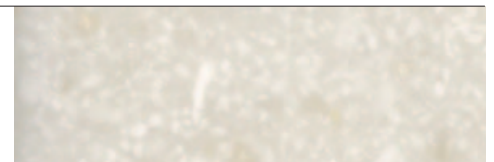

Linen

### GROUP GRADE B

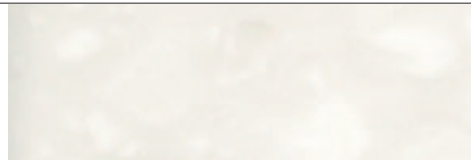

Antarctica

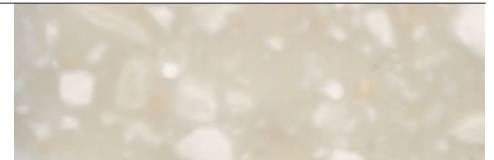

Savannah

### GROUP GRADE C

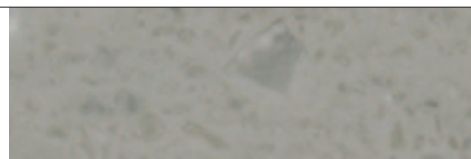

Dove

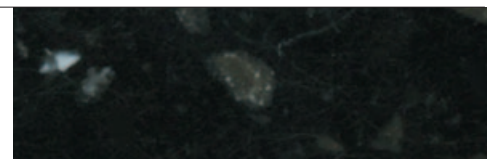

Deep Night Sky

# BASE STYLES

Base Styles	Description
<b>Black Nylon</b>	5 blade glass reinforced molded nylon base with 2 1/4" hooded dual wheel casters.
<b>Polished Aluminum</b>	5 blade polished cast aluminum base with 2 1/4" dual wheel casters (upcharge of \$115 applies.)
<b>Seat Slider</b>	Seat slider mechanism featuring a 2" range of adjustment front to back when seated. The lever to activate this feature is located under the seat of the user's left side and is activated by a simple twist of the knob.
<b>Wood</b>	5 blade steel bar stock base with finished wood caps and 2" black hooded dual wheel casters.
<b>Chrome</b>	5 blade polished chrome base with 2 1/4" dual wheel casters.
<b>Jury Bases</b>	Jury Bases assembly consists of a black 9" diameter conical/cast base for permanently mounting a chair to the floor. Into the base is inserted a black pneumatic gas cylinder with self returning action from rotation, and self returning height feature when exiting the chair. Allows for full 360 degree rotation. Limited degrees of rotation are not available.

Jury Bases

Pan Am  
Pan1-M11J



Bank of England  
177-J



Dorso  
D0S1-H2011J



Cadence  
CAD1-HW12J



C5  
C5E1MB41AJ



Aqua  
AQU1M33J





# krug



All products are air emissions certified and are available as FSC® certified

[solutions@krug.ca](mailto:solutions@krug.ca) | [www.krug.ca](http://www.krug.ca) | 1.888.578.KRUG