

**STRATFORD**  
Price and Specification Guide  
**CANADA**



Effective, January 1, 2025

**krug**

Advancing Design Through Innovation

# STRATFORD | TABLE OF CONTENTS

578	Environmental Summary
579	General Product Specification
580	Finishes
580	Edge Detail Profile
581	Profiles & Overhang
584	Drawer Pulls & Lock
585	Grommets
586	Laminate Worksurfaces
587	Non-Standard Product Guidelines for Pricing
588	Desk Specification
588	Credenza Specification
589	Overhead & Hutch Specification
590	Installation
591	Sample Configuration
592	Desks
596	Returns
598	Linking Units
598	Corner Units
599	Credenzas
603	Overheads
604	Hutches
607	Keyboard Tray & Cable Management
608	Modular Components
618	Bookcases
619	Storage
623	Reception

# STRATFORD CASEGOODS | ENVIRONMENTAL SUMMARY

## LEED CERTIFICATION



MATERIAL CONTENT:

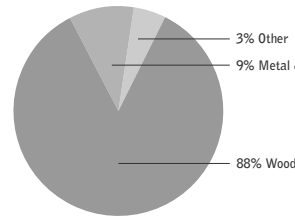

PRE-CONSUMER RECYCLED CONTENT - 77%  
 POST-CONSUMER RECYCLED CONTENT - 2.5%

		CONTRIBUTES TO
Credit 2.1 - 2.2	Construction Waste Management	1-
Credit 3.3	Resource Reuse	1 point
Credit 4.1	Recycled Content	1 point
Credit 4.2	Recycled Content	1 point
Credit 4.5	Low Emitting Materials, (MUST BE REQUESTED ) Composite Wood & Laminate Adhesives	1 point
Credit 5.1	Regional Materials*	1 point
Credit 6	Rapidly Renewable Materials (MUST BE REQUESTED )	1 point
Credit 7	Certified Wood (MUST BE REQUESTED )	1 point

\*This credit is only applicable if in total 20% of the combined value of the procurement of construction materials and in the furniture are manufactured within a radius of 500 miles. This credit will apply if the installation of the finished product occurs within 500 miles of Kitchener, Ontario.

### level® CERTIFICATION



BIFMA's e3 Furniture Sustainability Standard is a voluntary, multi-attribute standard that measures the degree of sustainability of furniture. This standard evaluates product and company environmental attributes and compliance systems in a wide range of elements which include Materials, Energy & Atmosphere, Human & Ecosystem Health and Social Responsibility. Stratford products have earned level®, BIFMA's sustainability certification program for furniture, certification through third-party verification against the e3 standard. All Stratford products can be supplied with level® certification. In order to accomplish this, the product must also be ordered with the air-emissions-certification option. Contact customer service for information and upcharges.

### AIR-EMISSIONS

All Stratford products can be supplied with air-emissions-certified materials. Contact customer service for information and upcharges.



FSC®  
 www.fsc.org  
 FSC® C021699

the mark of responsible forest

### FSC®

FSC® In 2005, Krug received Forest Stewardship Council® (FSC®) Chain-of-Custody certification for our manufacturing facilities. The FSC® Chain-of-Custody tracks certified wood from seedling to final sale. It verifies that the material for our FSC® certified products only come from well-managed, FSC®-certified forests and other controlled sources. FSC® is dedicated to the promotion of responsible forest management worldwide helping to take care of forests for future generations. Stratford and other Krug products can be specified with FSC® Certification. Contact customer service for further information, pricing and lead times.



In addition, architects, designers, and building professionals can specify FSC®-certified products in order to achieve a point from the U.S. Green Building Council's Leadership in Energy and Environmental Design (LEED) Rating System.

# STRATFORD | GENERAL PRODUCT SPECIFICATIONS

## WORKSURFACES

Tops are made of 1 1/4" - 42 lbs. per cubic foot density particle board core with face and back veneers. All edges have 1 1/8" wide 1" thick solid Cherry or Walnut headers.

## DRAWER FRONTS AND DOORS

48 lbs. per cubic foot density Medium Density Fiberboard with face and back veneer.

## GABLES

Gables are 3/4" or 1 1/8" thick - 45 lbs. per cubic foot density particleboard core, 3 ply. Edges are banded with veneer. Bottom edges of 1 1/8" gables are banded with polyvinyl chloride edge banding.

## VENEER

External face veneers are flat sliced Black Walnut or Cherry bookmatched and of uniform color and grain pattern.

## SOLIDS

All solids used shall be American Black Walnut or Cherry kiln-dried by the manufacturer to a 6% moisture content

## FINISH

All surfaces to be finished are well sanded before applying finish materials. The procedure begins with the application of a base color via a Non-Grain Raising stain. Next a wash coat is applied to seal the NGR stain and ensure an even colored finish. The a filler coat is applied and hand wiped to fill the open pores in the wood surface and further enhance the depth color. A sealer is applied and scuff sanded to prepare the surfaces for the top coat (finish). The final procedure is to apply a coat of 52° sheen catalyzed varnish to protect the surfaces and add luster.

## LOCKS

Locks are standard on all pedestals and storage unit lateral file drawers.  
Locks are optional on door fronts and must be specified at time of order.  
Locks are not available on glass doors.

## DRAWERS

Box drawers have ball bearing movement, full extension slides with urethane cushioned stops and hold-in catch. Box drawers have a load bearing capacity of 100 lbs. per drawer. File drawers have progressive action ball bearing full-extension slides with urethane cushioned stops and hold-in catch. File drawers have a load bearing capacity of 100 lbs. per drawer. Lateral file drawers have full-extension slides with over-travel ball movement slides with urethane cushioned stops. Lateral file drawers have a load bearing capacity of 150 lbs. per drawer. All drawer slides allow for easy removal of the drawers. All drawer interiors are birch veneer. All file drawers are equipped for letter and legal filing. All desks with the center drawer option include a matching pencil tray in the center drawer. All standard desks with 2 box 1 file pedestals are specified without a center drawer option include one matching pencil tray.

## BASE MOLDING

The base moldings are made of profiled solid Black Walnut or Cherry.

## GLIDES

Glides are provided for every case and allow for 1 1/2" of adjustment.

## HINGES

Doors have European style hinges with a 95° opening.

## PULLS

Three pull options are available, please specify at time of order.

## TESTING INFORMATION

Stratford desks, credenzas, hutches, link units, and returns meet or exceed the testing requirements of ANSI/BIFMA X5.5-2014 and/or X5.9 - 2012.



**WOOD FINISHES**

Standard wood finishes are:

<b>SPECIES</b>	<b>FINISH</b>
Cherry	Light Cherry
	Natural Cherry
	American Cherry
	Medium Cherry
	Standard Cherry
	Imperial Cherry
	Appalachian Cherry
Sable Cherry	
Walnut	Natural Walnut
	Regular Walnut
	Mahogany on Walnut
	Dark Walnut
	Cordovan Walnut

**NATURAL CHARACTERISTICS OF WOOD**

Wood is a natural product with inherent color variations that will never be fully mitigated by the finishing process. Please anticipate variation in colors within a single unit, from piece to piece, and from Krug wood finish samples. If a very close match is required, a sample must be provided with the order and an upcharge will apply. Exact color matches are not possible.

**CUSTOM WOOD FINISHES**

Add 10% list to your order for special finishes, minimum upcharge is \$600 list per finish per order. (For example, on all orders up to \$6000 list, an upcharge of \$600 will apply, on orders \$6000 and up add 10% list to your order.)

For orders with special finishes, a sample that is a minimum 3” by 3” must be received with the order. Special finishes may add additional lead time to production schedules.

Since wood is a natural product, some variations in grain, color, and stain acceptance will occur. In our finishing processes, we try to minimize variations, but some variation between samples and finished goods should be anticipated.

**DUAL FINISH**

Add 10% net per item if specifying dual finish.

**WOOD FINISHES TO MATCH STANDARD LAMINATES**

- Copper on Cherry
- Shiraz Cherry
- Park Avenue Walnut
- Chocolate on Walnut
- Nutmeg on Walnut
- Dark Walnut

**STRATFORD | EDGE PROFILES**



**PROFILE - STANDARD**

The standard edge detail is included on the following Stratford products:

- desks
- linking units
- credenzas
- returns
- corner units
- 30” high and 57” high bookcases
- modular TP and TPR tops
- 30” high freestanding storage
- occasional tables
- conference tables



**PROFILE - INVERTED**

The inverted edge detail is included on the following Stratford products:

- hutches
- wall mounted overheads
- 71” high bookcase
- modular TPI tops
- 71” high and 84” high freestanding storage
- visual boards

# STRATFORD | PROFILES & OVERHANGS

Please use the following summary of products to determine the profile direction and overhang dimensions for all Stratford products.

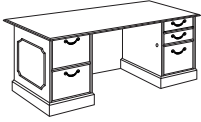

## DESKS 30" DEEP

Profile Location: profile on all four sides  
 Profile Direction: standard  
 Overhang: left 1 1/2"  
 right 1 1/2"  
 user 3/4"  
 guest 1 1/2"

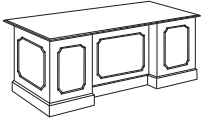

Picture Frame: on end panels, modesty panel and pedestal backs

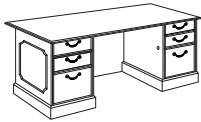

## DESKS 36" DEEP

Profile Location: profile on all four sides  
 Profile Direction: standard  
 Overhang: left 1 1/2"  
 right 1 1/2"  
 user 3/4"  
 guest 7 1/2"

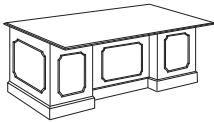

Picture Frame: on end panels, modesty panel and pedestal backs



## TABLE DESKS

Profile Location: profile on all four sides  
 Profile Direction: standard  
 Overhang: left 1 1/2"  
 right 1 1/2"  
 user 3/4"  
 guest 1 1/2"

Picture Frame: none

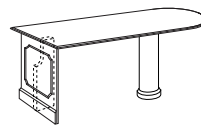

## BULLET AND P DESKS

Profile Location: profile on all sides  
 Profile Direction: standard  
 Overhang: end panel 1 1/2"  
 Picture Frame: on end panel

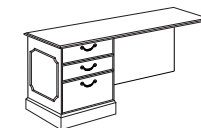

## RETURNS

Profile Location: profile on all four sides, coved  
 Profile Direction: standard  
 Overhang: end panel 1 1/2"  
 user 3/4"  
 guest 1 1/2"

Picture Frame: on end panel, modesty panel and pedestal back

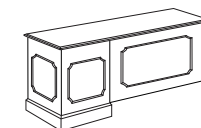

# STRATFORD | PROFILES & OVERHANGS

Please use the following summary of products to determine the profile direction and overhang dimensions for all Stratford products.

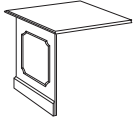

## LINK UNITS AND LINK TOPS

Profile Location: profile on guest and user sides, cover on connecting ends  
Profile Direction: standard  
Overhang: guest 1 1/2"  
Picture Frame: on modesty panel

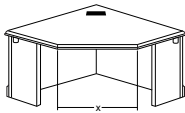

## CORNER UNITS

Profile Location: profile on outside and user sides, covered on connecting ends  
Profile Direction: standard  
Overhang: guest 1 1/2"  
Picture Frame: on both outside panels

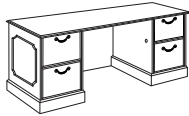

## CREDENZAS

Profile Location: profile on left, right and user side, flush on back edge  
Profile Direction: standard  
Overhang: left 1 1/2"  
right 1 1/2"  
user 3/4"  
back 1/8"  
Picture Frame: on left and right panels



## OVERHEADS

Profile Location: inverted profile left, right, and user side, flush on back edge  
Profile Direction: inverted  
Overhang: left 1"  
right 1"  
user 3/4"  
back flush

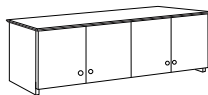

Picture Frame: none

Please specify if flush sides are necessary for the purpose of ganging overheads at time of order. Upcharge for this option is **\$228 list**.

# STRATFORD | PROFILES & OVERHANGS

Please use the following summary of products to determine the profile direction and overhang dimensions for all Stratford products.

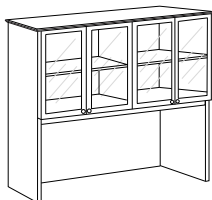

## HUTCHES

Profile Location: inverted profile on left, right, and user side, flush on back edge  
 Profile Direction: inverted  
 Overhang: left 1"  
 right 1"  
 user 3/4"  
 back flush

Picture Frame: none

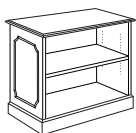
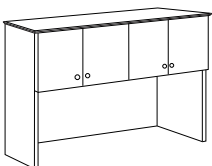

## BOOKCASES AND FREESTANDING STORAGE (30" HIGH ONLY)

Profile Location: profile on left, right, and user side, flush on back edge  
 Profile Direction: standard  
 Overhang: left 1 1/2"  
 right 1 1/2"  
 user 3/4" (if unit has doors or drawers)  
 1 1/2" (if unit is open)  
 back flush

Picture Frame: on left and right panels

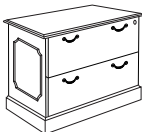

Bookcases have non-shown wood backs, finished color.

Freestanding and modular storage have non-shown wood veneer, finished and top coated backs.

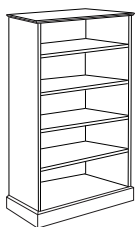

## BOOKCASES AND FREESTANDING STORAGE (57", 71" AND 84" HIGH)

Profile Location: profile on left, right, and user side, flush on back edge  
 Profile Direction: inverted  
 Overhang: left 1"  
 right 1"  
 user 3/4" (if unit has doors or drawers)  
 1 1/2" (if unit is open)  
 back flush

Picture Frame: none

Bookcases have non-shown wood backs, finished color.

Freestanding and modular storage have non-shown wood veneer, finished and top coated backs.

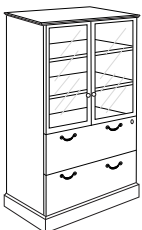



# STRATFORD | DRAWER PULLS & LOCKS

Stratford traditional series offers a choice of three pull combinations as described below.

Please indicate a pull designation for every Stratford product on your order. There is no default selection and orders will not be processed until a pull selection is received.

## DEVON

Drawers are furnished with an arced Devon bail finished in antiqued brass and mounted with rosettes. Bookcase doors and hutch doors are provided with an antiqued brushed brass knob.



## CANTERBURY

Drawers are furnished with a Canterbury bail finished in antiqued brass and mounted with rosettes. Bookcase doors and hutch doors are provided with an antiqued brushed brass knob.



## AVON

All drawers, bookcase doors and hutch doors are provided with an antiqued brushed brass knob.



## LOCKS

Locks are provided as a standard features on all pedestal drawers, including those in desks, credenzas and freestanding or modular storage units. All lock plugs have an antiqued brass finish.

Optional locks are available on bookcase, hutch and overhead doors at an upcharge of **\$152 list per set** of (2) doors. Please specify at time of order. If a hutch or overhead has an uneven amount of doors the single lock required is also **\$152**.

## LOCK LOCATIONS

**Desk Pedestals:** Lock plugs are located in the kneespace of all desks, with the exception of desks with the center drawer option where the central locking system lock plug is located on the center of the drawer front.

**Hutches and Overheads:** Lock plugs are located on the lower inside corner of the doors.

**Bookcase Doors:** Lock plugs are located on the top inside corner of the door.

Suites can be keyed alike at no upcharge, please specify on your purchase order.

# STRATFORD | GROMMETS

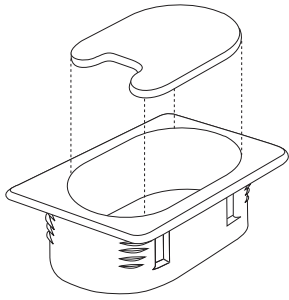

## GROMMETS

All products may be specified with either one black grommet or one brass grommet in a standard position at no upcharge. A **\$152 list upcharge** will apply to additional grommets in standard positions and for grommets in non-standard positions a **\$152 list upcharge** will apply.

The grommet position must be indicated for each case on the purchase order.

Standard Grommet  
Black, rectangular, 4 1/8" x 2 11/16"

Antiqued Brass Grommet  
2 5/8" x 1 1/2"

Grommets can also be field installed with power drill, 2 1/4 hole saw and rasp or saber saw. Template for drilling is available.

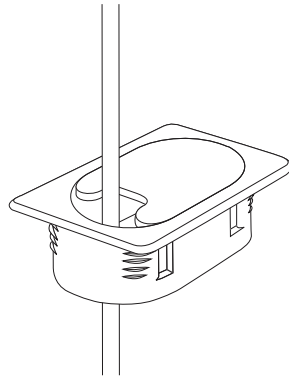

## STANDARD GROMMET POSITIONS

### Desks

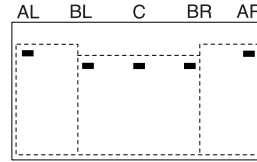
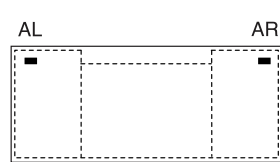

### 30" and 36" Deep Desks:

Position Code:  
AL - left corner  
BL - left end beside pedestal gable  
C - center  
BR - right end beside pedestal gable  
AR - right corner

### 42" Deep Desks:

Position Code:  
AL - left corner  
BL - left end beside pedestal gable  
C - center  
BR - right end beside pedestal gable  
AR - right corner

### Curvilinear Tops

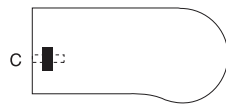

Position Code:  
C - center

This key applies to all bullet and P shaped tops. The support panel is notched out to accommodate cable management and also allows the installation of a pop-up power grommet.

### Linking Units, Credenzas & Returns

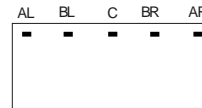

Grommets cannot be located over pedestals on 20" or 24" units

**NOTE:** 'BL' and 'BR' are only available on 42" or longer.

# STRATFORD | GROMMETS & LAMINATE WORKSURFACES

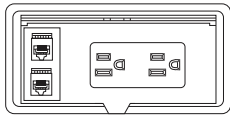

mounted in a hutch back panel

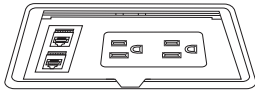

used as a surface grommet

## POWER / DATA / VOICE GROMMET

This unit is supplied in the wired hutches or can be ordered a surface mount power/data/voice option as a 98PDVM.

Black, rectangular with recessed cover.  
Includes two power outlets, one voice port, and one data port.

**POWER DETAILS:**  
two Simplex outlets  
15 Amp, 10 ft. cord

**COMMUNICATION DETAILS:**  
one RJ11 phone line coupler  
one RJ45 data coupler

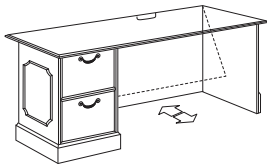

## WIRE MANAGEMENT CUT-OUT AND HINGED MODESTY PANELS

Returns, link units and credenzas with fixed modesty panels can be specified with an 8" x 1 1/2" wire management cut-out. All hinged modesty panels feature a cut-out as a standard.

The discreet cut-out allows for clean and easy access to power, data and communication sources.

# STRATFORD | LAMINATE WORKSURFACES

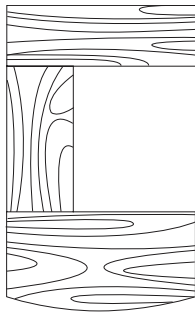

## LAMINATE WORKSURFACES

Laminate worksurfaces are available at an upcharge of 10% (a higher upcharge may apply to specially priced plastic laminates).

Where there are wood profile edges on worksurface tops, they will remain as wood profiles on laminate tops.

Where there are flush edges, as in the backs of link units, there will be laminate self edges. Please reference the illustration.

Krug will order and procure laminates. Purchase orders with a plastic laminate option must include laminate name.

When specifying laminate worksurfaces, the grain direction is such that the grain pattern runs the length of each surface, as shown in the diagram on the left.

Please contact Krug Customer Service for questions pertaining to laminate grain direction.

# STRATFORD | NON-STANDARD PRODUCT GUIDELINES FOR PRICING

## PRICING METHOD

Custom widths: Apply the price of the same unit in the price list that is one standard size larger than the desired case size (but same depth).  
For example: The required custom dimension is 74" x 24". The first standard size above this is 78" x 24", so in this case, you would apply the price of the 78" x 24" unit.

Custom depths: Apply the price for the same unit one size deeper (but same width).  
For example: The required custom dimension is 72" x 26". The first standard size above this is 72" x 30", so in this case, you would apply the price of the 72" x 30" unit.

Custom width & depths: Apply the price for the same unit both one size wider and one size deeper.  
For example: The required custom dimension is 74" x 26". The first standard size above this is 84" x 30", so in this case, you would apply the price of the 84" x 30" unit.

Custom height of desk height cases: Add 18%. (31-32" HI)

## OTHER PRICING METHODS

cases where tops are flush left/right or both, <b>add:</b>	\$120 list
Grommets in non-standard positions, <b>add:</b>	\$152 list
To remove hutch or overhead doors, <b>deduct:</b>	4% list
convert 5-hi hutch to 6-hi hutch, <b>add:</b>	20% list
Bookcases with optional pull out printer shelf at standard shelf height, <b>add:</b>	\$238 list
Bookcases with optional vent in back (includes 2 vents and 1 grommet), <b>add:</b>	\$302 list
storage units flush, <b>add:</b>	\$199 list
2 lateral file and 3 or 4 closed shelves - convert to half open, half closed shelves, <b>add:</b>	15% list
2 lateral file and 3 or 4 closed shelves - convert to half open, half wardrobe, <b>add:</b>	15% list
To remove storage doors for open shelves, <b>deduct:</b>	4% list

## EXCEPTIONS TO THE PRICING METHODS ABOVE

Sizes larger than the largest shown Price List.  
Non-standard extension on drawer slides.  
Non-standard drawer depths in standard depth pedestals.  
Glass door - any style.  
Glass - face mounted modesty panels.  
Perforated modesty panels.  
Cases with curvilinear tops where the radius becomes non-standard.  
A/V cabinets.  
Any case with flipper doors.

Please contact Specials Coordinator or Krug Customer Service at 1.888.578.KRUG if you require assistance.

**PLEASE NOTE:** Cases with non-standard features do not apply to the rules above.  
Contact Krug Customer Service if you require assistance.

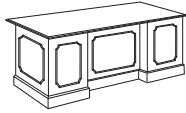

**Breakfront Modesty Panel**

All single pedestal and double pedestal desks have a breakfront modesty panel on the guest side of the desk. The dimension of recess is 4 1/2”.

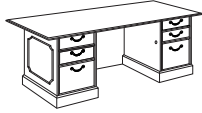

**Oversized Top Option**

The oversized top option increases the overhang on the left and right sides of desks to 4 1/2” on each end, the guest and user side overhang remain unchanged.



**Center Drawer Option**

Desks specified with the optional locking center drawer include the following features:

- center drawer lined with burgundy felt and a pencil tray.
- a pull out dictation slide in each pedestal
- a central locking system activated by a single lock located on the center drawer front

Recent modifications:

- dictation slides are flush with drawer fronts and feature molding detail
- center drawer extends to underside of top with the lock on the drawer front

**Chassis Dimensions**

Please use the reference chart below to determine chassis dimensions, top dimensions, and overhang dimensions for all desk sizes:

Desk	Chassis dimension	Left overhang	Right overhang	Guest overhang	User overhang
60” x 30”	57” x 27”	1 1/2”	1 1/2”	1 1/2”	3/4”
66” x 30”	63” x 27”	1 1/2”	1 1/2”	1 1/2”	3/4”
66” x 36”	63” x 27”	1 1/2”	1 1/2”	7 1/2”	3/4”
72” x 36” (oversized top)	63” x 27”	4 1/2”	4 1/2”	7 1/2”	3/4”
72” x 36”	69” x 27”	1 1/2”	1 1/2”	7 1/2”	3/4”
78” x 36” (oversized top)	69” x 27”	4 1/2”	4 1/2”	7 1/2”	3/4”
78”x 42”	75” x 33”	1 1/2”	1 1/2”	7 1/2”	3/4”
84” x 42” (oversized top)	75” x 33”	4 1/2”	4 1/2”	7 1/2”	3/4”
84” x 42”	81” x 33”	1 1/2”	1 1/2”	7 1/2”	3/4”

Dimensions have been rounded to the nearest 1/4”, please contact Customer Service for exact measurements.

**STRATFORD | CREDENZAS**

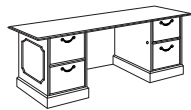

**Oversized Top Option**

The oversized top option increases the overhang on the left and right sides of credenzas to 4 1/2” on each side, the guest and user side overhang remain unchanged. When using a hutch and credenza combination, we do not recommend specifying a hutch greater in size than the standard chassis size of the credenza. The left/right extensions on the oversized top should not be used for the support of a hutch.

**Chassis Dimensions**

Please use the reference chart below to determine chassis dimensions, top dimensions, and overhang dimensions for all desk sizes:

	Credenza dimension	Chassis overhang	Left overhang	Right overhang	Guest User overhang
66” x 20”	63” x 18 1/4”	1 1/2”	1 1/2”	3/4”	1/8”
72” x 20” (oversized top)	63” x 18 1/4”	4 1/2”	4 1/2”	3/4”	1/8”
66” x 24”	63” x 22 1/4”	1 1/2”	1 1/2”	3/4”	1/8”
72” x 24” (oversized top)	63” x 22 1/4”	4 1/2”	4 1/2”	3/4”	1/8”
72” x 20”	69” x 18 1/4”	1 1/2”	1 1/2”	3/4”	1/8”
78” x 20” (oversized top)	69” x 18 1/4”	4 1/2”	4 1/2”	3/4”	1/8”
72” x 24”	69” x 22 1/4”	1 1/2”	1 1/2”	3/4”	1/8”
78” x 24” (oversized top)	69” x 22 1/4”	4 1/2”	4 1/2”	3/4”	1/8”
78” x 20”	75” x 18 1/4”	1 1/2”	1 1/2”	3/4”	1/8”
84” x 20” (oversized top)	75” x 18 1/4”	4 1/2”	4 1/2”	3/4”	1/8”
78” x 24”	75” x 22 1/4”	1 1/2”	1 1/2”	3/4”	1/8”
84” x 24” (oversized top)	75” x 22 1/4”	4 1/2”	4 1/2”	3/4”	1/8”
84” x 20”	81” x 18 1/4”	1 1/2”	1 1/2”	3/4”	1/8”
84” x 24”	81” x 18 1/4”	1 1/2”	1 1/2”	3/4”	1/8”

Dimensions have been rounded to the nearest 1/4”, please contact Customer Service for exact measurements.

# STRATFORD | OVERHEADS & HUTCHES

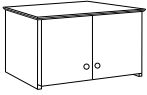

## OVERHEADS

Overheads include tasklights that are factory installed and require no field adjustment. Tasklights are mounted beneath the cabinet and hidden from view. Cords run down the right hand side of the tasklight to the worksurface where they can be routed behind the worksurface top. The use of a wall mounted tackboard conceals the cord from view.

Tackboards must be ordered separately and can be specified in any fabric grade (1-9). Wall mounted tackboards for overheads are supplied with all necessary hardware for installation.

Locks are optional on overheads and can be specified at time of order for an upcharge of **\$152 list per set** of (2) doors.

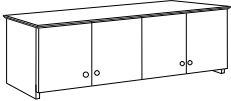

## HUTCHES

Hutches include tasklights that are factory installed and require no field adjustment. Tasklights are mounted beneath the cabinet and hidden from view.

A tackboard in grade 1 fabric is included with most hutches, see the hutch product section for specific products. Upcharges for higher graded fabrics are listed on page 603. Tackboard fabric selections should be supplied with the order information, fabric options are listed on page 4 of this price guide.

Tackboards for hutches are installed at the factory and require no additional set up on site.

## POWER/DATA/VOICE GROMMET

Access to power and data is made simple by using a hutch with a power/data/voice module built right into the tackboard. The module is fully installed at the factory but can be removed to connect data links on site. It features a flip door that retracts into the case of the unit when open.

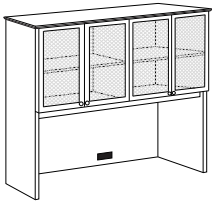

## INSTALLATION

Hutch and overhead installation instructions are included with every case, but basic installation instructions can be found in this guide on page 586. All required mounting hardware is included with all hutches.

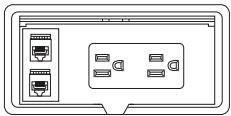

## CONNECTING WORKSURFACES

It is important that the product is in its final position and the primary worksurface is leveled before connecting other joining pieces.

Detailed installation instructions are included with each unit, or available from Krug Customer Service.

Units are connected with mending plates under worksurfaces, and linking brackets on modesty and end panels. Locate connections and attach the mending plate under the worksurface. Level pieces if necessary by adjusting the glides to achieve flush and firm joints before completing installation of all hardware.

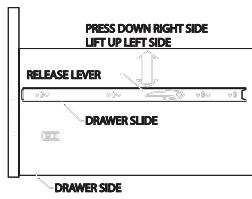

## DRAWER REMOVAL

To remove pedestal drawers, open to the extended position, press down on the right side nylon release lever and pull the drawers up on left side lever at the same time. Continue pulling the drawer out of the case.

## GLIDE ADJUSTMENTS

Raise one corner of the unit at a time and adjust the glide to the desired height by turning the glide in the hole. Make sure unit is level after adjusting the glides.

Please note that the maximum adjustment range of the glides is 1/2".

When moving units after glides have been inserted, dial the glides to the lowest position to prevent damage to the case.

## BOOKCASE OR HUTCH DOOR ADJUSTMENT

Hinges on all hutch and bookcase doors are designed to be adjusted for depth, horizontal and vertical adjustment by means of screws into the hinge mounting plates.

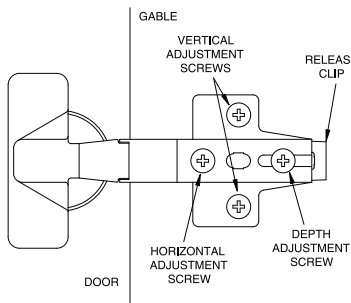

To remove a door, pull the release clip away from the case, disconnecting the hinges.

## OVERHEAD INSTALLATION

The wall mounted overhead storage units must be installed on wall studs. The first step for installation is to locate the studs in the wall where the overhead is to be mounted. Measure the stud center line location and use this measurement to mark the hole locations on the mounting rail and the overhead back. Drill clearance holes at the hole locations. Hole requirements will depend on the fasteners chosen by the installer. 2 1/2" x #10 wood screws are adequate if going into wood studs. If studs cannot be accessed, then appropriate drywall plugs or butterfly bolts should be used. We recommend 2 fasteners per stud.

Fasten the mounting rail to the wall ensuring that it is level. Hang the overhead on the mounting rail and then fasten it to the wall. This prevents accidental removal and also allows for some leveling adjustment.

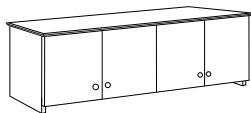

# STRATFORD | SAMPLE CONFIGURATIONS

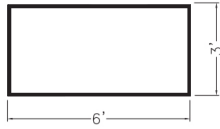
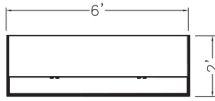
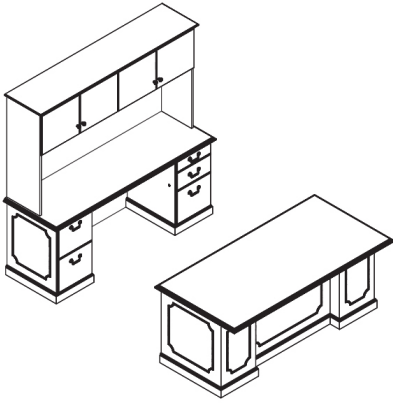

	Model	Cherry Walnut
Desk	98D72364LORF	4906
Hutch	98HT721640	5080
Credenza	98C72244LDRF	5420
<b>TOTAL</b>		<b>15406</b>

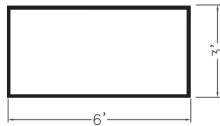
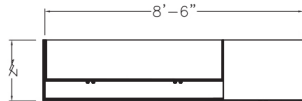
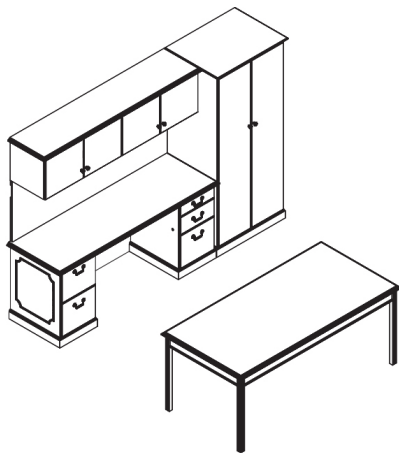

	Model	Cherry Walnut
Desk	98TD7236	4844
Overhead	98OH7216	2823
Tackboard	98TBOH72	509
Credenza	98C72244LDRF	5420
Flush Left option		120
Storage	98WR30247101	4834
<b>TOTAL</b>		<b>18550</b>

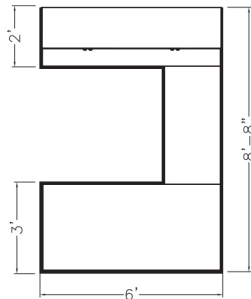
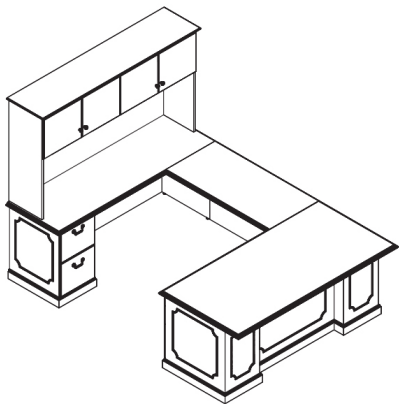

	Model	Cherry Walnut
Desk	98D72364LORF	4906
Link Unit	98LU4224H	1935
Hutch	98HT721640	5080
Credenza	98C72244LDR0	5038
<b>TOTAL</b>		<b>16959</b>

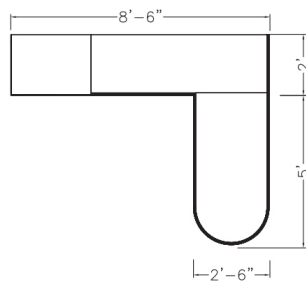
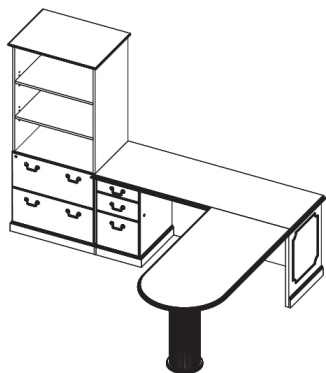

	Model	Cherry Walnut
Return	98BR6030	2138
Credenza	98C7220LFR0	4720
Flush Right option		120
Storage	98ST30207103	5568
<b>TOTAL</b>		<b>12546</b>

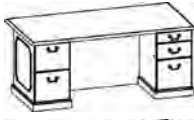
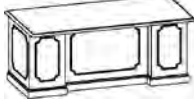

# STRATFORD | DESKS

Description	Model	Cherry Walnut		W	D	H	KW	Shipping	
		Weight	Cubic Feet						
 Double Pedestal Desk	98D60304LDRD	6304		59.75	29.75	30.5	25.5	273	42
	98D60304LDRF	6304		59.75	29.75	30.5	25.5	273	42
	98D60304LFRD	6304		59.75	29.75	30.5	25.5	273	42
	98D60304LFRF	6304		59.75	29.75	30.5	25.5	273	42
	98D66304LDRD	6337		65.75	29.75	30.5	31.5	280	46
	98D66304LDRF	6337		65.75	29.75	30.5	31.5	280	46
	98D66304LFRD	6337		65.75	29.75	30.5	31.5	280	46
	98D66304LFRF	6337		65.75	29.75	30.5	31.5	280	46
	98D66364LDRD	6370		65.75	35.75	30.5	31.5	295	55
	98D66364LDRF	6370		65.75	35.75	30.5	31.5	295	55
 guest side of a 36" deep desk**	98D66364LFRD	6370		65.75	35.75	30.5	31.5	295	55
	98D66364LFRF	6370		65.75	35.75	30.5	31.5	295	55
	98D72364LDRD	6463		71.75	35.75	30.5	37.5	310	60
	98D72364LDRF*	6463		71.75	35.75	30.5	37.5	310	60
	98D72364LFRD	6463		71.75	35.75	30.5	37.5	310	60
	98D72364LFRF	6463		71.75	35.75	30.5	37.5	310	60
	98D78424LDRD	6609		77.75	41.75	30.5	43.5	327	72
	98D78424LDRF	6609		77.75	41.75	30.5	43.5	327	72
	98D78424LFRD	6609		77.75	41.75	30.5	43.5	327	72
	98D78424LFRF	6609		77.75	41.75	30.5	43.5	327	72
98D84424LDRD	6758		83.75	41.75	30.5	49.5	337	78	
98D84424LDRF	6758		83.75	41.75	30.5	49.5	337	78	
98D84424LFRD	6758		83.75	41.75	30.5	49.5	337	78	
98D84424LFRF	6758		83.75	41.75	30.5	49.5	337	78	

**ORDERING NOTES:**

Laminate worksurfaces are available at a 10% upcharge. 30" deep Stratford desks have a 1-1/2" overhang on the guest side. 36" deep Stratford desks have a 7 1/2" overhang on the guest side. See page 578 for more information on the desks overhang and chassis dimensions. A burled walnut top option is available at a 20% upcharge.

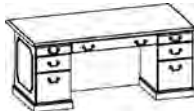
 Double Pedestal Desk with Center Drawer Option	98D60304LFCDRF	6696		59.75	29.75	30.5	25.5	303	42
	98D66304LFCDRF	6696		65.75	29.75	30.5	31.5	310	46
	98D66364LFCDRF	6696		65.75	35.75	30.5	31.5	325	55
	98D72364LFCDRF*	6696		71.75	35.75	30.5	37.5	340	60
	98D78424LFCDRF	6696		77.75	41.75	30.5	43.5	357	72
	98D84424LFCDRF	6696		83.75	41.75	30.5	49.5	367	78

**ORDERING NOTES:**

The center drawer option includes:

- a felt-lined drawer with pencil tray
- two pull-out dictation slides on the user side of the desk.
- a central locking system activating center drawer and both pedestals with a single lock located on the left pedestal inside gable.

Laminate worksurfaces are available at a 10% upcharge. A burled walnut top option is available at a 20% upcharge.

**DIMENSION KEY**

W — width  
 D — depth  
 H — height of worksurface  
 KW— kneehole width

Dimensions are in inches and approximate. Contact Customer Service if dimensions are critical.

\*See page 5 for KrugExpress program.

**CODE DESCRIPTION**

0 - no pedestal  
 4 - full height pedestals  
 D - 2 file drawer  
 F - 2 box, 1 file drawe  
 L - left hand support position  
 R - right hand support position  
 CD - center drawer  
 OT - oversized top option  
 BT - bow top option  
 CC - corner credenza

**STANDARD FINISHES**

For a complete list of standard wood finishes please see page 577.

**WIRING GROMMET**

One rectangular black or one antique brass grommet in a standard position is optional at no charge. Please note grommet choice clearly on order form. Additional grommets are available at an upcharge of **\$152 list**.

# STRATFORD | DESKS

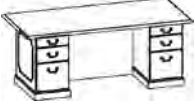
Description	Model	Cherry Walnut	W	D	H	Shipping Weight	Cubic Feet
	OT98D66364	330	71.75	35.75	-	15	-
	OT98D72364*	330	77.75	35.75	-	15	-
	OT98D78424	330	83.75	41.75	-	15	-

### ORDERING NOTES:

The oversized top option is only available on stand-alone double pedestal desks and cannot be used in conjunction with any other run-off or connecting worksurfaces. Specifying the oversized top option increases the top width, increasing the left and right overhang measurement to 4-1/2". The guest side remains 7-1/2" (as is standard for 36" and 42" deep desks). Laminate worksurfaces are available at a 10% upcharge.

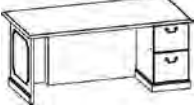
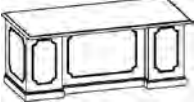
Single Pedestal Desk								
  	98D60304LDR0	4347	59.75	29.75	30.5	40.5	215	42
	98D60304LFR0	4347	59.75	29.75	30.5	40.5	215	42
	98D60304LORD	4347	59.75	29.75	30.5	40.5	215	42
	98D60304LORF	4347	59.75	29.75	30.5	40.5	215	42
	98D66304LDR0	4381	65.75	29.75	30.5	46.5	222	46
	98D66304LFR0	4381	65.75	29.75	30.5	46.5	222	46
	98D66304LORD	4381	65.75	29.75	30.5	46.5	222	46
	98D66304LORF	4381	65.75	29.75	30.5	46.5	222	46
	98D66364LDR0	4407	65.75	35.75	30.5	46.5	237	55
	98D66364LFR0	4407	65.75	35.75	30.5	46.5	237	55
	98D66364LORD	4407	65.75	35.75	30.5	46.5	237	55
	98D66364LORF	4407	65.75	35.75	30.5	46.5	237	55
	98D72364LDR0	4906	71.75	35.75	30.5	52.5	252	60
	98D72364LFR0	4906	71.75	35.75	30.5	52.5	252	60
	98D72364LORD*	4906	71.75	35.75	30.5	52.5	252	60
	98D72364LORF	4906	71.75	35.75	30.5	52.5	252	60
	98D78424LDR0	5392	77.75	41.75	30.5	58.5	269	72
	98D78424LFR0	5392	77.75	41.75	30.5	58.5	269	72
98D78424LORD	5392	77.75	41.75	30.5	58.5	269	72	
98D78424LORF	5392	77.75	41.75	30.5	58.5	269	72	
98D84424LDR0	5890	83.75	41.75	30.5	64.5	279	78	
98D84424LFR0	5890	83.75	41.75	30.5	64.5	279	78	
98D84424LORD	5890	83.75	41.75	30.5	64.5	279	78	
98D84424LORF	5890	83.75	41.75	30.5	64.5	279	78	

guest side of a 36"  
deep desk\*\*

### ORDERING NOTES:

The oversized top option is only available on stand-alone double pedestal desks and cannot be used in conjunction with any other run-off or connecting worksurfaces. Specifying the oversized top option increases the top width, increasing the left and right overhang measurement to 4-1/2". The guest side remains 7-1/2" (as is standard for 36" and 42" deep desks). Laminate worksurfaces are available at a 10% upcharge.

### ORDERING PROCEDURES

To order, please specify the following:

- 1) Krug product model number
- 2) Wood species and finish, see page 577
- 4) Pull style and finish, see page 581
- 5) Grommet location and style if applicable

\* Indicates model illustrated by line drawing

### CODE DESCRIPTION

0 - no pedestal  
 4 - full height pedestals  
 D - 2 file drawer  
 F - 2 box, 1 file drawer  
 L - left hand support position  
 R - right hand support position  
 CD - center drawer  
 OT - oversized top option  
 BT - bow top option  
 CC - corner credenza

### STANDARD FINISHES

For a complete list of standard wood finishes please see page 577.

# STRATFORD | DESKS

Description	Model	Cherry		W	D	H	KW	Shipping	
		Walnut						Weight	Cubic Feet
	98D66304LOCDRF	4680		65.75	29.75	30.5	46.5	252	46
	98D66304LFCDR0	4680		65.75	29.75	30.5	46.5	252	46
	98D66364LOCDRF	4728		65.75	35.75	30.5	46.5	267	55
	98D66364LFCDR0	4728		65.75	35.75	30.5	46.5	267	55
	98D72364LOCDRF*	5245		71.75	35.75	30.5	52.5	282	60
	98D72364LFCDR0	5245		71.75	35.75	30.5	52.5	282	60
	98D78424LOCDRF	5767		77.75	41.75	30.5	58.5	299	72
	98D78424LFCDR0	5767		77.75	41.75	30.5	58.5	299	72
	98D84424LOCDRF	6286		83.75	41.75	30.5	64.5	309	78
	98D84424LFCDR0	6286		83.75	41.75	30.5	64.5	309	78

guest side of a 36" deep desk\*\*

### ORDERING NOTES:

The center drawer option includes:

- a felt-lined drawer with pencil tray
- a central locking system activating center drawer and pedestal with a single lock located on the inside pedestal gable.
- pull-out dictation slide on the user side of the desk.

The space left between the pencil drawer and the open end of the desk allows for a 24" run off. Laminate worksurfaces are available at a 10% upcharge. A burled walnut top option is available at a 20% upcharge.

Description	Model	Cherry		W	D	H	KW	Shipping	
		Walnut						Weight	Cubic Feet
	98S6636LOR0*	2936		65.75	35.75	30.5	60.5	121	55
	98S7236LOR0	3261		71.75	35.75	30.5	66.5	137	60
	98S7836LOR0	3618		77.75	35.75	30.5	72.5	153	64

Description	Model	Cherry		W	D	H	KW	Shipping	
		Walnut						Weight	Cubic Feet
	98D6636BT	669		-	-	-	-	-	-
	98D7236BT*	722		-	-	-	-	-	-
	98D7842BT	740		-	-	-	-	-	-
	98D8442BT	749		-	-	-	-	-	-

### ORDERING NOTES:

The bow top option is available on all the desk sizes listed above. Please add "BT" to the model number of the desk and add the upcharge shown above. The bowtop option tapers the overhang back on the left and right sides, the depth of the overhang at the widest point is 7 1/2". Laminate worksurfaces are available at a 10% upcharge.

### DIMENSION KEY

W — width  
D — depth  
H — height of worksurface  
KW— kneehole width

Dimensions are in inches and approximate. Contact Customer Service if dimensions are critical.

\*See page 5 for KrugExpress program.

### CODE DESCRIPTION

0 - no pedestal  
4 - full height pedestals  
D - 2 file drawer  
F - 2 box, 1 file drawer  
L - left hand support position  
R - right hand support position  
CD - center drawer  
OT - oversized top option  
BT - bow top option  
CC - corner credenza

### STANDARD FINISHES

For a complete list of standard wood finishes please see page 577.

### WIRING GROMMET

One rectangular black or one antique brass grommet in a standard position is optional at no charge. Please note grommet choice clearly on order form. Additional grommets are available at an upcharge of **\$152 list**.

# STRATFORD | DESKS

Description	Model	Cherry Walnut	W	D	H	KW	Shipping Weight	Cubic Feet
Queen Ann Table Desk	98TDQ7236	5327	83.75	35.75	30.5	65.75	150	60



**ORDERING NOTES:**

Optional lock: Please add **\$152 list** and specify lock option in the product description. This item is NOT available on KrugExpress. Laminate worksurfaces are available at a 10% upcharge. Please note that pedestals can not be used with table desks.

Table Desk	Model		W	D	H	KW	Shipping Weight	Cubic Feet
	98TD7236*	4844	71.75	35.75	30.5	66.5	131	12
	98TD7842	5380	77.75	41.75	30.5	72.5	148	14



**ORDERING NOTES:**

Table desk includes a felt-liner center drawer with pencil tray. To add lock, please specify lock option and add **\$143 list**. The lock plug is located above the center drawer in the rail. The table desk is shipped knocked down. This table desk is NOT available on KrugExpress. Laminate worksurfaces are available at a 10% upcharge.

Bullet Desk, Post Leg	Model		W	D	H	KW	Shipping Weight
	98BD6030	3074	59.75	29.75	30.5	140	36
	98BD6630	3134	65.75	29.75	30.5	154	40
	98BD7230	3194	71.75	29.75	30.5	170	47
	98BD6636	3165	65.75	35.75	30.5	184	43
	98BD7236*	3261	71.75	35.75	30.5	200	51

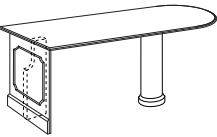

"P" Desk, Post Leg	Model		W	D	H	KW	Shipping Weight	Cubic Feet
	98PD7230L	4008	71.75	35.75	30.5		189	43
	98PD7230R	4008	71.75	35.75	30.5		189	43
	98PD7236L	4093	71.75	41.75	30.5		205	51
	98PD7236R*	4093	71.75	41.75	30.5		205	51
	98PD7830L	4170	77.75	35.75	30.5		219	47
	98PD7830R	4170	77.75	35.75	30.5		219	47
	98PD7836R	4247	77.75	41.75	30.5		233	56
	98PD7836R	4247	77.75	41.75	30.5		233	56
	98PD8430L	4377	83.75	35.75	30.5		247	50
	98PD8430R	4377	83.75	35.75	30.5		247	50
	98PD8436L	4487	83.75	41.75	30.5		260	60
	98PD8436R	4487	83.75	41.75	30.5		260	60

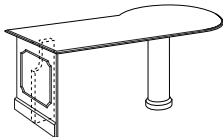

**ORDERING NOTES:**

"P" desk/return legs are 10.5 in diameter. Laminate worksurfaces are available at a 10% upcharge.

**ORDERING PROCEDURES**

To order, please specify the following:

- 1) Krug product model number
- 2) Wood species and finish, see page 577
- 4) Pull style and finish, see page 581
- 5) Grommet location and style if applicable

\* Indicates model illustrated by line drawing

**CODE DESCRIPTION**

- 0 - no pedestal
- 4 - full height pedestals
- D - 2 file drawer
- F - 2 box, 1 file drawer
- L - left hand support position
- R - right hand support position
- CD - center drawer
- OT - oversized top option
- BT - bow top option
- CC - corner credenza

**STANDARD FINISHES**

For a complete list of standard wood finishes please see page 577.

**LOCKS**

Locks are standard on all lateral file drawers. Optional locks on bookcase doors are available at a **\$152 list** upcharge. Please specify at time of order.

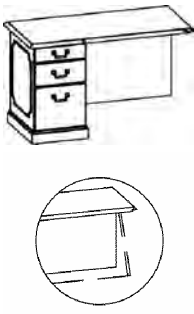
Description	Model	Cherry Walnut	W	D	H	KW	Shipping Weight	Cubic Feet
	98RH4220L4D	3798	41.75	20.5	30.5	23	114	22
	98RH4220L4F	3798	41.75	20.5	30.5	23	114	22
	98RH4220R4D	3798	41.75	20.5	30.5	23	114	22
	98RH4220R4F	3798	41.75	20.5	30.5	23	118	22
	98RH4224L4D	3852	41.75	23.75	30.5	23	118	26
	98RH4224L4F	3852	41.75	23.75	30.5	23	114	26
	98RH4224R4D	3852	41.75	23.75	30.5	23	114	26
	98RH4224R4F	3852	41.75	23.75	30.5	23	114	26
	98RH4820L4D	3886	47.75	20.5	30.5	27	118	25
	98RH4820L4F	3886	47.75	20.5	30.5	27	118	25
	98RH4820R4D	3886	47.75	20.5	30.5	27	118	25
	98RH4820R4F	3886	47.75	20.5	30.5	27	122	25
	98RH4824L4D	3903	47.75	23.75	30.5	27	122	29
	98RH4824L4F*	3903	47.75	23.75	30.5	27	118	29
	98RH4824R4D	3903	47.75	23.75	30.5	27	118	29
	98RH4824R4F	3903	47.75	23.75	30.5	27	118	29
	98RH5420L4D	3935	53.75	20.5	30.5	35	122	28
	98RH5420L4F	3935	53.75	20.5	30.5	35	122	28
	98RH5420R4D	3935	53.75	20.5	30.5	35	122	28
	98RH5420R4F	3935	53.75	20.5	30.5	35	126	28
	98RH5424L4D	3982	53.75	23.75	30.5	35	126	32
	98RH5424L4F	3982	53.75	23.75	30.5	35	122	32
	98RH5424R4D	3982	53.75	23.75	30.5	35	122	32
	98RH5424R4F	3982	53.75	23.75	30.5	35	122	32
	98RH6020L4D	4066	59.75	20.5	30.5	41	126	31
	98RH6020L4F	4066	59.75	20.5	30.5	41	126	31
	98RH6020R4D	4066	59.75	20.5	30.5	41	126	31
	98RH6020R4F	4066	59.75	20.5	30.5	41	130	31
	98RH6024L4D	4141	59.75	23.75	30.5	41	130	36
	98RH6024L4F	4141	59.75	23.75	30.5	41	126	36
	98RH6024R4D	4141	59.75	23.75	30.5	41	126	36
	98RH6024R4F	4141	59.75	23.75	30.5	41	126	36
98RH6620L4D	4347	65.75	20.5	30.5	47	130	33	
98RH6620L4F	4347	65.75	20.5	30.5	47	130	33	
98RH6620R4D	4347	65.75	20.5	30.5	47	130	33	
98RH6620R4F	4347	65.75	20.5	30.5	47	165	33	
98RH6624L4D	4396	65.75	23.75	30.5	47	165	39	
98RH6624L4F	4396	65.75	23.75	30.5	47	130	39	
98RH6624R4D	4396	65.75	23.75	30.5	47	130	39	
98RH6624R4F	4396	65.75	23.75	30.5	47	130	39	

**ORDERING NOTES:**

Modesty panels on returns are raised above the base mounding. Laminate worksurfaces are available at a 10% upcharge. For wire management cut out option on modesty panel add **\$194 list upcharge**. For hinged modesty panel upcharge insert Y after the C in the model number. e.g. 98CY7224LORF

**DIMENSION KEY**

W — width  
 D — depth  
 H — height of worksurface  
 KW— kneehole width

Dimensions are in inches and approximate.  
 Contact Customer Service if dimensions are critical.

\*See page 5 for KrugExpress program.

**CODE DESCRIPTION**

0 - no pedestal  
 4 - full height pedestals  
 D - 2 file drawer  
 F - 2 box, 1 file drawer  
 L - left hand support position  
 R - right hand support position  
 CD - center drawer  
 OT - oversized top option  
 BT - bow top option  
 CC - corner credenza

**STANDARD FINISHES**

For a complete list of standard wood finishes please see page 577.

**WIRING GROMMET**

One rectangular black or one antique brass grommet in a standard position is optional at no charge. Please note grommet choice clearly on order form. Additional grommets are available at an upcharge of **\$152 list**.

# STRATFORD | RETURNS

Description	Model	Cherry		W	D	H	KW	Shipping Weight	Cubic Feet
		Walnut							
 Single Pedestal Return, Continued	98RH7220L4D	4458		71.75	20.5	30.5	53	165	36
	98RH7220L4F*	4458		71.75	20.5	30.5	53	165	36
	98RH7220R4D	4458		71.75	20.5	30.5	53	165	36
	98RH7220R4F	4458		71.75	20.5	30.5	53	170	36
	98RH7224L4D	4540		71.75	23.75	30.5	53	170	42
	98RH7224L4F	4540		71.75	23.75	30.5	53	165	42
	98RH7224R4D	4540		71.75	23.75	30.5	53	165	42
	98RH7224R4F	4540		71.75	23.75	30.5	53	165	42

### ORDERING NOTES:

Modesty panels on returns are raised above the base mounding. Laminate worksurfaces are available at a 10% upcharge. For wire management cut out option on modesty panel add **\$194 list** upcharge. For hinged modesty panel upcharge insert Y after the C in the model number. e.g. 98CY7224LORF

Return Shells	Model	Cherry		W	D	H	KW	Shipping Weight	Cubic Feet
		Walnut							
	98RH4224L0*	2293		41.75	23.75	30.5	39.25	68	26
	98RH4224R0	2293		41.75	23.75	30.5	39.25	68	26
	98RH4824L0	2321		47.75	23.75	30.5	45.25	72	29
	98RH4824R0	2321		47.75	23.75	30.5	45.25	72	29

Bullet Return, Post Leg	Model	Cherry		W	D	H	KW	Shipping Weight	Cubic Feet
		Walnut							
	98BR6030	2138		59.75	29.75	30.5		66	3
	98BR6630	2166		65.75	29.75	30.5		81	4
	98BR6636	2194		65.75	35.75	30.5		101	4
	98BR7230	2238		71.75	29.75	30.5		106	4
	98BR7236*	2307		71.75	35.75	30.5		116	5

### ORDERING NOTES:

Bullet desk/return legs are 10.5 in diameter. Bullet desks are available in 72" lengths only for KrugExpress. Laminate worksurfaces are available at a 10% upcharge.

"P" Return, Post Leg	Model	Cherry		W	D	H	KW	Shipping Weight	Cubic Feet
		Walnut							
	98PR7230L	3420		71.75	35.75	30.5		112	43
	98PR7230R	3420		71.75	35.75	30.5		112	43
	98PR7236L	3567		71.75	41.75	30.5		128	51
	98PR7236R*	3567		71.75	41.75	30.5		128	51
	98PR7836L	3646		77.75	41.75	30.5		128	47
	98PR8430L	3646		83.75	35.75	30.5		128	47
	98PR8430R	3770		83.75	35.75	30.5		128	56
	98PR8436L	3770		83.75	41.75	30.5		128	56
	98PR8436R	3874		83.75	41.75	30.5		128	50
	98PR7836R	3874		77.75	41.75	30.5		128	50
	98PR7830L	3985		77.75	35.75	30.5		142	60
	98PR7830R	3985		77.75	35.75	30.5		142	60

### ORDERING PROCEDURES

To order, please specify the following:

- 1) Krug product model number
- 2) Wood species and finish, see page 577
- 4) Pull style and finish, see page 581
- 5) Grommet location and style if applicable

\* Indicates model illustrated by line drawing

### CODE DESCRIPTION

- 0 - no pedestal
- 4 - full height pedestals
- D - 2 file drawer
- F - 2 box, 1 file drawer
- L - left hand support position
- R - right hand support position
- CD - center drawer
- OT - oversized top option
- BT - bow top option
- CC - corner credenza

### STANDARD FINISHES

For a complete list of standard wood finishes please see page 577.

### WIRING GROMMET

One rectangular black or one antique brass grommet in a standard position is optional at no charge. Please note grommet choice clearly on order form. Additional grommets are available at an upcharge of **\$152 list**.

# STRATFORD | LINKING UNITS & CORNER UNITS

Description	Model	Cherry Walnut	W	D	H	KW	Shipping Weight	Cubic Feet
	98LU3620H	1792	34.75	19.75	30.5		15	3
	98LU3624H	1846	34.75	23.75	30.5		16	3
	98LU4220H	1871	38.75	19.75	30.5		20	4
	98LU4224H*	1935	38.75	23.75	30.5		24	4
	98LU4820H	1974	44.75	19.75	30.5		29	4
	98LU4824H	2016	44.75	23.75	30.5		36	4

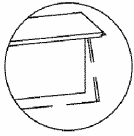

### ORDERING NOTES:

Please note on order if picture frame molding is required on hinged modesty panel. Laminate worksurfaces are available at a 10% upcharge.

For wire management cut out option on modesty panel add **\$194 list upcharge**.

For hinged modesty panel upcharge add 10% and insert Y after the LU in the model number. e.g. 98LUY4224H

Description	Model	Cherry Walnut	W	D	H	KW	Shipping Weight	Cubic Feet
	98LT3620H	887	34.75	19.75	1.25		15	2
	98LT3624H	898	34.75	23.75	1.25		16	2
	98LT4220H	922	38.75	19.75	1.25		20	2
	98LT4224H*	953	38.75	23.75	1.25		24	2
	98LT4820H	973	44.75	19.75	1.25		29	2
	98LT4824H	992	44.75	23.75	1.25		36	3

### ORDERING NOTES:

Laminate worksurfaces are available at a 10% upcharge.

Description	Model	Cherry Walnut	W	D	H	KW	Shipping Weight	Cubic Feet
	98CU363620	3507	35.75	35.75	30.5	22.5	106	33
	98CU363624*	3507	35.75	35.75	30.5	17	106	33
	98CU424224	3852	41.75	41.75	30.5	25.5	131	41

### ORDERING NOTES:

Laminate worksurfaces are available at a 10% upcharge. The x dimension on the 98CU363624 corner unit does not allow for an undersurface mounted keyboard or pencil drawer. Please specify a 98KBAC2110 with an extended mechanism if keyboard is required. See page 604.

### DIMENSION KEY

W – width  
D – depth  
H – height of worksurface  
KW – kneehole width

Dimensions are in inches and approximate.  
Contact Customer Service if dimensions are critical.

\*See page 5 for KrugExpress program.

### CODE DESCRIPTION

4 - full height pedestals  
D - 2 file drawer  
F - 2 box, 1 file drawer  
L - left hand support position  
R - right hand support position  
CU - corner unit  
LT - linking top  
Lu - linking unit

### STANDARD FINISHES

For a complete list of standard wood finishes please see page 577.

### WIRING GROMMET

One rectangular black or one antique brass grommet in a standard position is optional at no charge. Please note grommet choice clearly on order form. Additional grommets are available at an upcharge of **\$152 list**.

# STRATFORD | CREDENZAS

Description	Model	Cherry Walnut	W	D	H	Shipping Weight	Cubic Feet
 Credenza Shells	98S6624LOR0*	2835	65.75	23.75	30.5	121	32
	98S7224LOR0	3092	71.75	23.75	30.5	137	35
	98S7824LOR0	3360	77.75	23.75	30.5	153	38

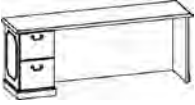
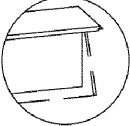
Description	Model	Cherry Walnut	W	D	H	Shipping Weight	Cubic Feet	
  Single Pedestal Credenza	98C66204LDR0	4959	65.75	19.75	30.5	46.5	163	33
	98C66204LFR0	4959	65.75	19.75	30.5	46.5	163	33
	98C66204LOR0	4959	65.75	19.75	30.5	46.5	163	33
	98C66204LORF	4959	65.75	19.75	30.5	46.5	163	33
	98C66244LDR0	4961	65.75	23.75	30.5	46.5	171	38
	98C66244LFR0	4961	65.75	23.75	30.5	46.5	171	38
	98C66244LOR0	4961	65.75	23.75	30.5	46.5	171	38
	98C66244LORF	4961	65.75	23.75	30.5	46.5	171	38
	98C72204LDR0	5002	71.75	19.75	30.5	52.5	179	36
	98C72204LFR0	5002	71.75	19.75	30.5	52.5	179	36
	98C72204LOR0	5002	71.75	19.75	30.5	52.5	179	36
	98C72204LORF	5002	71.75	19.75	30.5	52.5	179	36
	98C72244LDR0	5038	71.75	23.75	30.5	52.5	187	41
	98C72244LFR0	5038	71.75	23.75	30.5	52.5	187	41
	98C72244LOR0	5038	71.75	23.75	30.5	52.5	187	41
	98C72244LORF	5038	71.75	23.75	30.5	52.5	187	41
	98C78204LDR0*	5016	77.75	19.75	30.5	58.5	195	38
	98C78204LFR0	5016	77.75	19.75	30.5	58.5	195	38
	98C78204LOR0	5016	77.75	19.75	30.5	58.5	195	38
	98C78204LORF	5016	77.75	19.75	30.5	58.5	195	38
	98C78244LDR0	5016	77.75	23.75	30.5	58.5	203	44
	98C78244LFR0	5016	77.75	23.75	30.5	58.5	203	44
	98C78244LOR0	5016	77.75	23.75	30.5	58.5	203	44
	98C78244LORF	5016	77.75	23.75	30.5	58.5	203	44
	98C84204LDR0	5043	83.75	19.75	30.5	64.5	211	41
	98C84204LFR0	5043	83.75	19.75	30.5	64.5	211	41
	98C84204LOR0	5043	83.75	19.75	30.5	64.5	211	41
	98C84204LORF	5043	83.75	19.75	30.5	64.5	211	41
98C84244LDR0	5065	83.75	23.75	30.5	64.5	219	48	
98C84244LFR0	5065	83.75	23.75	30.5	64.5	219	48	
98C84244LOR0	5065	83.75	23.75	30.5	64.5	219	48	
98C84244LORF	5065	83.75	23.75	30.5	64.5	219	48	

### ORDERING NOTES:

Please note on order if picture frame molding is required on hinged modesty panel. Laminate worksurfaces are available at a 10% upcharge. For wire management cut out option on modesty panel add **\$194 list** upcharge. For hinged modesty panel add a 10% upcharge and insert Y after the C in the model number. e.g. 98CY72244LORF

### ORDERING PROCEDURES

To order, please specify the following:

- 1) Krug product model number
- 2) Wood species and finish, see page 577
- 4) Pull style and finish, see page 581
- 5) Grommet location and style if applicable

\* Indicates model illustrated by line drawing

### CODE DESCRIPTION

0 - no pedestal  
 4 - full height pedestals  
 D - 2 file drawer  
 F - 2 box, 1 file drawer  
 L - left hand support position  
 R - right hand support position  
 CD - center drawer  
 OT - oversized top option  
 BT - bow top option  
 CC - corner credenza

### STANDARD FINISHES

For a complete list of standard wood finishes please see page 577.

### WIRING GROMMET

One rectangular black or one antique brass grommet in a standard position is optional at no charge. Please note grommet choice clearly on order form. Additional grommets are available at an upcharge of **\$152 list**.

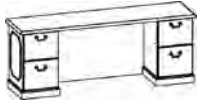
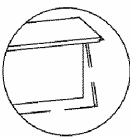

# STRATFORD | CREDENZAS

Description	Model	Cherry Walnut	W	D	H	KW	Shipping Weight	Cubic Feet
Double Pedestal Credenza	98C66204LDRD	5327	65.75	19.75	30.5	31.5	198	33
	98C66204LDRF	5327	65.75	19.75	30.5	31.5	198	33
	98C66204LFRD	5327	65.75	19.75	30.5	31.5	198	33
	98C66204LFRF	5327	65.75	19.75	30.5	31.5	198	33
	98C66244LDRD	5338	65.75	23.75	30.5	31.5	211	38
	98C66244LDRF	5338	65.75	23.75	30.5	31.5	211	38
	98C66244LFRD	5338	65.75	23.75	30.5	31.5	211	38
	98C66244LFRF	5338	65.75	23.75	30.5	31.5	211	38
	98C72204LDRD	5384	71.75	19.75	30.5	37.5	214	36
	98C72204LDRF	5384	71.75	19.75	30.5	37.5	214	36
	98C72204LFRD	5384	71.75	19.75	30.5	37.5	214	36
	98C72204LFRF	5384	71.75	19.75	30.5	37.5	214	36
	98C72244LDRD	5420	71.75	23.75	30.5	37.5	227	41
	98C72244LDRF	5420	71.75	23.75	30.5	37.5	227	41
	98C72244LFRD	5420	71.75	23.75	30.5	37.5	227	41
	98C72244LFRF	5420	71.75	23.75	30.5	37.5	227	41
	98C78204LDRD*	5470	77.75	19.75	30.5	43.5	230	38
	98C78204LDRF	5470	77.75	19.75	30.5	43.5	230	38
	98C78204LFRD	5470	77.75	19.75	30.5	43.5	230	38
	98C78204LFRF	5470	77.75	19.75	30.5	43.5	230	38
	98C78244LDRD	5518	77.75	23.75	30.5	43.5	243	44
	98C78244LDRF	5518	77.75	23.75	30.5	43.5	243	44
	98C78244LFRD	5518	77.75	23.75	30.5	43.5	243	44
	98C78244LFRF	5518	77.75	23.75	30.5	43.5	243	44
	98C84204LDRD	5527	83.75	19.75	30.5	49.5	246	41
	98C84204LDRF	5527	83.75	19.75	30.5	49.5	246	41
	98C84204LFRD	5527	83.75	19.75	30.5	49.5	246	41
	98C84204LFRF	5527	83.75	19.75	30.5	49.5	246	41
	98C84244LDRD	5541	83.75	23.75	30.5	49.5	259	48
	98C84244LDRF	5541	83.75	23.75	30.5	49.5	259	48
	98C84244LFRD	5541	83.75	23.75	30.5	49.5	259	48
	98C84244LFRF	5541	83.75	23.75	30.5	49.5	259	48

## ORDERING NOTES:

Please note on order if picture frame molding is required on hinged modesty panel. Laminate worksurfaces are available at a 10% upcharge.

For wire management cut out option on modesty panel add **\$194 list upcharge**.

For hinged modesty panel add a 10% upcharge and insert Y after the C in the model number. e.g. 98CY7224LFRF

### DIMENSION KEY

W — width  
D — depth  
H — height of worksurface  
KW— kneehole width

Dimensions are in inches and approximate.  
Contact Customer Service if dimensions are critical.

\*See page 5 for KrugExpress program.

### CODE DESCRIPTION

0 - no pedestal  
4 - full height pedestals  
D - 2 file drawer  
F - 2 box, 1 file drawer  
L - left hand support position  
R - right hand support position  
CD - center drawer  
OT - oversized top option  
BT - bow top option  
CC - corner credenza

### STANDARD FINISHES

For a complete list of standard wood finishes please see page 577.

### WIRING GROMMET

One rectangular black or one antique brass grommet in a standard position is optional at no charge. Please note grommet choice clearly on order form. Additional grommets are available at an upcharge of **\$152 list**.

# STRATFORD | CREDENZAS

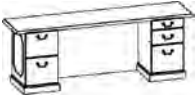
Description	Model	Cherry			W	D	H	Shipping Weight	Cubic Feet
		Walnut							
	OT98C6620	330			71.75	19.75	-	15	-
	OT98C6624	330			71.75	23.75	-	15	-
	OT98C7220	330			77.75	19.75	-	15	-
	OT98C7224	330			77.75	23.75	-	15	-
	OT98C7820*	330			83.75	19.75	-	15	-
	OT98C7824	330			83.75	23.75	-	15	-

### ORDERING NOTES:

In the 20" deep knee hole credenzas and/or shells the pencil drawer cannot be used. The oversized top option is only available on stand-alone double pedestal credenzas and cannot be used in conjunction with any other run-off connecting worksurfaces. Specifying the oversized top option increases the top width, increasing the left and right overhang measurement to 4 1/2". The front and rear overhang remains unchanged. Laminate worksurfaces are available at a 10% upcharge.

Description	Model	Cherry			W	D	H	Shipping Weight	Cubic Feet	
		Walnut								
	98C6620LBR0	4529			65.75	19.75	30.5	25.75	204	33
	98C6620LFR0	4529			65.75	19.75	30.5	25.75	212	33
	98C6620LORB	4529			65.75	19.75	30.5	25.75	204	33
	98C6620LORF	4529			65.75	19.75	30.5	25.75	212	33
	98C6624LBR0	4617			65.75	23.75	30.5	25.75	211	38
	98C6624LFR0	4617			65.75	23.75	30.5	25.75	227	38
	98C6624LORB	4617			65.75	23.75	30.5	25.75	211	38
	98C6624LORF	4617			65.75	23.75	30.5	25.75	227	38
	98C7220LBR0	4720			71.75	19.75	30.5	31.75	228	36
	98C7220LFR0	4720			71.75	19.75	30.5	31.75	236	36
	98C7220LORB	4720			71.75	19.75	30.5	31.75	228	36
	98C7220LORF	4720			71.75	19.75	30.5	31.75	236	36
	98C7224LBR0	4823			71.75	23.75	30.5	31.75	235	41
	98C7224LFR0	4823			71.75	23.75	30.5	31.75	243	41
	98C7224LORB	4823			71.75	23.75	30.5	31.75	235	41
	98C7224LORF	4823			71.75	23.75	30.5	31.75	243	41
	98C8420LBR0	4958			83.75	19.75	30.5	43.75	256	41
	98C8420LFR0	4958			83.75	19.75	30.5	43.75	268	41
	98C8420LORB	4958			83.75	19.75	30.5	43.75	256	41
	98C8420LORF	4958			83.75	19.75	30.5	43.75	268	41
	98C8424LBR0	5063			83.75	23.75	30.5	43.75	267	48
	98C8424LFR0	5063			83.75	23.75	30.5	43.75	275	48
	98C8424LORB	5063			83.75	23.75	30.5	43.75	267	48
	98C8424LORF*	5063			83.75	23.75	30.5	43.75	275	48

### ORDERING NOTES:

Please note on order if picture frame molding is required on hinged modesty panel. Laminate worksurfaces are available at a 10% upcharge. Bookcase pedestals include one adjustable shelf. For hinged modesty panel add a 10% upcharge and insert Y after the C in the model number. e.g. 98CY7224LORF

### ORDERING PROCEDURES

To order, please specify the following:

- 1) Krug product model number
- 2) Wood species and finish, see page 577
- 4) Pull style and finish, see page 581
- 5) Grommet location and style if applicable

\* Indicates model illustrated by line drawing

### CODE DESCRIPTION

- 0 - no pedestal
- 4 - full height pedestals
- D - 2 file drawer
- F - 2 box, 1 file drawer
- L - left hand support position
- R - right hand support position
- CD - center drawer
- OT - oversized top option
- BT - bow top option
- CC - corner credenza

### STANDARD FINISHES

For a complete list of standard wood finishes please see page 577.

### WIRING GROMMET

One rectangular black or one antique brass grommet in a standard position is optional at no charge. Please note grommet choice clearly on order form. Additional grommets are available at an upcharge of **\$152 list**.

# STRATFORD | CREDENZAS

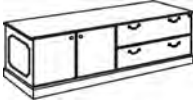
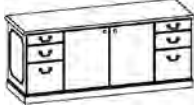
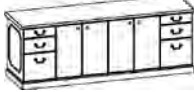
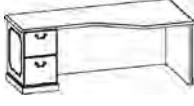
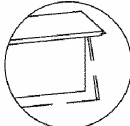
Description	Model	Cherry Walnut	W	D	H	KW	Shipping Weight	Cubic Feet
	98C6320LFRF	6505	62.5	19.75	30.5		304	27
	98C6324LFRF	6536	62.5	23.75	30.5		316	27
	98C7220LBRF	6649	71.75	19.75	30.5		320	29
	98C7220LFRB	6649	71.75	19.75	30.5		320	29
	98C7224LBRF*	6778	71.75	23.75	30.5		331	35
	98C7224LFRB	6772	71.75	23.75	30.5		331	35
	98C7520LFRF	7438	74.5	19.75	30.5		334	37
	98C7524LFRF	7507	74.5	23.75	30.5		347	37
<hr/>								
 	98C66204FBCF	6112	65.75	19.75	30.5	25.75	250	33
	98C66204DBCD	6112	65.75	19.75	30.5	25.75	246	33
	98C66244FBCF	6213	65.75	23.75	30.5	25.75	263	38
	98C66244DBCD	6213	65.75	23.75	30.5	25.75	259	38
	98C72204FBCF	6400	71.75	19.75	30.5	25.75	266	36
	98C72204DBCD	6400	71.75	19.75	30.5	25.75	262	36
	98C72244FBCF*	6581	71.75	23.75	30.5	25.75	279	41
	98C72244DBCD	6581	71.75	23.75	30.5	25.75	275	41
	98C84204FBCF	6769	83.75	19.75	30.5	31.75	298	41
	98C84204DBCD	6769	83.75	19.75	30.5	31.75	294	41
	98C84244FBCF**	6954	83.75	23.75	30.5	31.75	311	48
	98C84244DBCD	6954	83.75	23.75	30.5	31.75	307	48
	<hr/>							
 	98CC6624L4D	4257	65.75	35.75	30.5	37.5	184	55
	98CC6624R4D	4257	65.75	35.75	30.5	20.5	184	55
	98CC6624L4F	4257	65.75	35.75	30.5	20.5	184	55
	98CC6624R4F	4257	65.75	35.75	30.5	20.5	184	55
	98CC7224L4D*	4357	71.75	35.75	30.5	20.5	202	60
	98CC7224R4D	4357	71.75	35.75	30.5	20.5	202	60
	98CC7224L4F	4357	71.75	35.75	30.5	20.5	202	60
	98CC7224R4F	4357	71.75	35.75	30.5	20.5	202	60
	98CC7824L4D	4406	77.75	35.75	30.5	20.5	210	64
	98CC7824R4D	4406	77.75	35.75	30.5	20.5	210	64
	98CC7824L4F	4406	77.75	35.75	30.5	20.5	210	64
	98CC7824R4F	4406	77.75	35.75	30.5	20.5	210	64
	98CC8424L4D	4455	83.75	35.75	30.5	20.5	218	69
	98CC8424R4D	4455	83.75	35.75	30.5	20.5	218	69
	98CC8424L4F	4455	83.75	35.75	30.5	20.5	218	69
	98CC8424R4F	4455	83.75	35.75	30.5	20.5	218	69

### ORDERING NOTES:

Corner credenzas allow for a 24" deep unit at the connecting end. Laminate worksurfaces are available at a 10% upcharge. For wire management cut out option on modesty panel add **\$194 list** upcharge. For hinged modesty panel add a 10% upcharge and insert Y after the C in the model number. e.g. 98CY7224LORF

### DIMENSION KEY

W — width  
D — depth  
H — height of worksurface  
KW— kneehole width

Dimensions are in inches and approximate.  
Contact Customer Service if dimensions are critical.

\*See page 5 for KrugExpress program.

### CODE DESCRIPTION

0 - no pedestal  
4 - full height pedestals  
D - 2 file drawer  
F - 2 box, 1 file drawer  
L - left hand support position  
R - right hand support position  
CD - center drawer  
OT - oversized top option  
BT - bow top option  
CC - corner credenza

### STANDARD FINISHES

For a complete list of standard wood finishes please see page 577.

### WIRING GROMMET

One rectangular black or one antique brass grommet in a standard position is optional at no charge. Please note grommet choice clearly on order form. Additional grommets are available at an upcharge of **\$152 list**.

# STRATFORD | OVERHEADS

Description	Model	Cherry		W	D	H	Doors	Shipping Weight	Cubic Feet
		Walnut							
Overheads with Wood Doors	98OH3616*	1974		35.75	16	16	2	53	8
	98OH4216	2098		41.75	16	16	2	57	9
	98OH4816	2180		47.75	16	16	3	77	10
	98OH5416	2359		53.75	16	16	4	81	11
	98OH6016	2542		59.75	16	16	4	88	12
	98OH6616**	2682		65.75	16	16	4	94	13
	98OH7216	2823		71.75	16	16	4	99	14



\*

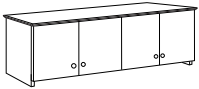

\*\*

## Tackboards Grades

Description	Model	1	2	3	4	5	6	7	8	9	W	H	COM	WT
Tackboards for use with Overheads	98TBOH36	322	352	384	436	567	689	812	941	1223	34	26	1.5	11
	98TBOH42	336	364	392	443	573	695	820	948	1229	41.75	26	1.5	12
	98TBOH48	371	460	485	606	729	834	960	1106	1387	47.75	26	1.75	13
	98TBOH54	382	501	546	697	815	935	1074	1215	1494	55.75	26	1.75	14
	98TBOH60	420	561	590	737	879	1045	1206	1376	1654	61.75	26	2	15
	98TBOH66	463	627	619	857	1031	1227	1393	1590	1887	67.75	26	2	16
	98TBOH72	509	777	808	1071	1317	1333	1533	1749	2030	74.75	26	2.25	19



### ORDERING PROCEDURES

To order, please specify the following:

- 1) Krug product model number
- 2) Wood species and finish, see page 577
- 4) Pull style and finish, see page 581
- 5) Grommet location and style if applicable

\* Indicates model illustrated by line drawing

### CODE DESCRIPTION

OH - overhead unit  
 W - includes power/data/voice grommet  
 G - includes glass doors  
 Z - includes grill doors  
 PM - paper manager  
 TBOH- tackboard for overhead

### STANDARD FINISHES

For a complete list of standard wood finishes please see page 577.

### OVERHEADS

All overheads include installed tasklights and mounting hardware. Contact customer service for information about flush units. Tackboards must be ordered separately.

# STRATFORD | HUTCHES

Description	Model	Cherry Walnut	W	D	H	KW	Shipping Weight	Cubic Feet
5-Hi Hutch with Wood Doors	98HT601640	3958	59.75	16	40	23.5	150	26
	98HT661640*	4327	65.75	16	40	23.5	162	28
	98HT721640	5080	71.75	16	40	23.5	174	31
	98HT781640	5387	77.75	16	40	23.5	186	33
	98HT841640	5686	83.75	16	40	23.5	200	36



6-Hi Hutch with Wood Doors	98HT601653	4813	59.75	16	53	23.5	200	34
	98HT661653*	5344	65.75	16	53	23.5	212	37
	98HT721653	6117	71.75	16	53	23.5	224	41
	98HT781653	6581	77.75	16	53	23.5	236	44
	98HT841653	7051	83.75	16	53	23.5	250	47

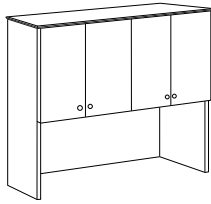

### ORDERING NOTES:

Hutches are inset 1-1/2" on each side when sitting on the worksurface. Locks are available on wood door hutches and overheads at **\$152 list** per set of (2) doors.

6-Hi Hutch with Glass Doors	98HT601653G	5098	59.75	16	53	23.5	117	34
	98HT661653G*	5661	65.75	16	53	23.5	126	37
	98HT721653G	6482	71.75	16	53	23.5	135	41
	98HT781653G	6981	77.75	16	53	23.5	146	44
	98HT841653G	7472	83.75	16	53	23.5	154	47

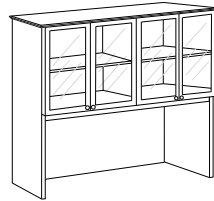

### ORDERING NOTES:

All shelves in glass door hutches are 1/4" thick glass. Hutches are inset 1-1/2" on each side when sitting on the worksurface.

6-Hi Hutch with Grill Doors	98HT601653Z	5800	59.75	16	53	23.5	150	34
	98HT661653Z*	6334	65.75	16	53	23.5	162	37
	98HT721653Z	7108	71.75	16	53	23.5	174	41
	98HT781653Z	7570	77.75	16	53	23.5	186	44
	98HT841653Z	8040	83.75	16	53	23.5	200	47



### ORDERING NOTES:

All shelves in grill door hutches are 1/4" thick glass. This Hutch includes a factory installed tasklight and a tackboard in Grade 1 fabric. Grill doors are NOT available on KrugExpress. Hutches are inset 1-1/2" on each side when sitting on the worksurface.

### DIMENSION KEY

W — width  
D — depth  
H — height of worksurface  
KW — kneehole width

Dimensions are in inches and approximate. Contact Customer Service if dimensions are critical.

\*See page 5 for KrugExpress program.

### CODE DESCRIPTION

OH - overhead unit  
W - includes power/data/voice grommet  
G - includes glass doors  
Z - includes grill doors  
PM - paper manager  
TBOH- tackboard for overhead

### STANDARD FINISHES

For a complete list of standard wood finishes please see page 577.

### HUTCHES

Hutches include tasklights and a tackboard in grade 1 fabric. See page 603 for upcharges for grades 2-9.

# STRATFORD | HUTCHES

Description	Model	Cherry Walnut			W	D	H	Shipping Weight	Cubic Feet
6-Hi Full Height Hutch with Clear Glass Doors	98HT60165301G	5609			59.75	16	53	200	34
	98HT66165301G*	6227			65.75	16	53	212	37
	98HT72165301G	7130			71.75	16	53	224	41
	98HT78165301G	7675			77.75	16	53	232	44
	98HT84165301G	8220			83.75	16	53	250	47

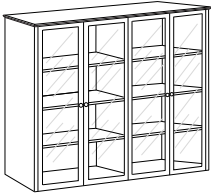

**ORDERING NOTES:**

All shelves in glass door hutches are 1/4" thick glass. Hutches are inset 1-1/2" on each side when sitting on the worksurface.

6-Hi Full Height Hutch with Grill Doors	98HT60165301Z	6578			59.75	16	53	190	34
	98HT66165301Z*	6965			65.75	16	53	202	37
	98HT72165301Z	7818			71.75	16	53	212	41
	98HT78165301Z	8329			77.75	16	53	222	44
	98HT84165301Z	8839			83.75	16	53	240	47

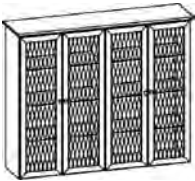

**ORDERING NOTES:**

All shelves in grill door hutches are 1/4" thick glass. Grill doors are NOT available on KrugExpress. Hutches are inset 1-1/2" on each side when sitting on the worksurface.

Paper Managers	98PM18132001	1911			16.5	13	19.5	15	4
----------------	--------------	------	--	--	------	----	------	----	---



**ORDERING PROCEDURES**

To order, please specify the following:

- 1) Krug product model number
- 2) Wood species and finish, see page 577
- 4) Pull style and finish, see page 581
- 5) Grommet location and style if applicable

\* Indicates model illustrated by line drawing

**CODE DESCRIPTION**

OH - overhead unit  
 W - includes power/data/voice grommet  
 G - includes glass doors  
 Z - includes grill doors  
 PM - paper manager  
 TBOH- tackboard for overhead

**STANDARD FINISHES**

For a complete list of standard wood finishes please see page 577.

**HUTCHES**

Hutches include tasklights and a tackboard in grade 1 fabric. See page 603 for upcharges for grades 2-9.

## Hutch tackboard upgrade chart

Use this chart to find the upcharge for tackboard fabrics graded 2-9 and add it to the cost of the hutch. Fabric grades can be referenced on page 4.

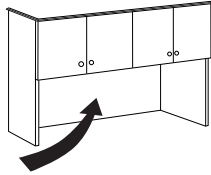

	FABRIC GRADES									COM
	2	3	4	5	6	7	8	9		
65" hutch tackboard	148	313	455	610	753	900	1048	1372	2	
71" hutch tackboard	163	354	517	688	856	1021	1183	1506	2.25	
78" hutch tackboard	196	420	619	830	1027	1223	1422	1748	2.5	
84" hutch tackboard	235	495	779	1029	1284	1501	1613	1940	2.5	
91" hutch tackboard	278	573	848	1124	1396	1501	1946	2274	2.75	
Pot light option for Hutches	Pot Light	539	Per hutch (includes two lights)							

### ORDERING NOTES :

The factory installed pot light option is available on any glass door or grill door hutch. The two lights are mounted through the hutch top and activated by a switch located on the light inside the case. Please add the upcharge shown above to hutch price and specify pot light option on your order. This item is not available on KrugExpress.

On single piece hutches, the yardage requirement for two tackboards is the same as for one tackboard. Please keep this in mind when ordering more than one tackboard. For example, if the number of tackboards required is 7 and the COM requirement for 1 tackboard is 1.5 yards, the calculation for COM yardage is as follows: 4.5 yards are required for 6 tackboards + 1.5 yards for the 7th tackboard for a total of 6 yards. In the case of an even number of tackboards, divide the number of tackboards required by 2 and multiply that number by the COM requirement on the chart. The fabric must be at least 54" wide in order to qualify for this procedure. If the fabric is less than 54" wide, the COM yardage listed on the chart is the amount required for each tackboard.

### COM yardage Calculation Chart of Tackboards

Quantity of Tackboards Required (example: 60")	Number of yards Required per Tackboard (example: 60")	Number of yards Required in Total (example: 60")
one	2 yards	2
two	2 yards	2
three	2 yards	4
four	2 yards	4
fiv	2 yards	6
six	2 yards	6
seven	2 yards	8
eight	2 yards	8
nine	2 yards	10
ten	2 yards	10

#### DIMENSION KEY

W — width  
 D — depth  
 H — height of worksurface  
 KW— kneehole width

Dimensions are in inches and approximate.  
 Contact Customer Service if dimensions are critical.

\*See page 5 for KrugExpress program.

#### CODE DESCRIPTION

PM — paper manager

# STRATFORD | KEYBOARDS & PENCIL DRAWERS

Description	Model	Cherry Walnut	W	D	H	Shipping Weight	Cubic Feet
Articulating Keyboard Tray with Palm Rest and Mouse Tray/Extended Mechanism	98KBAMT1912	741	-	-	-	20	2

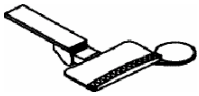

**ORDERING NOTES:**

This unit comes with a lever free arm keyboard support. This unit is a granite color.

Pencil Drawer	98PD2116	630	-	-	-	2	1
---------------	----------	-----	---	---	---	---	---



Wire Management Cover	98WM72	157	-	-	-	3	7
-----------------------	--------	-----	---	---	---	---	---



Velcro Wire Management	98WM4	33	-	-	-	1	1
------------------------	-------	----	---	---	---	---	---

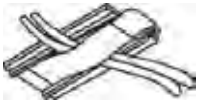

Power Data Module	98PDVM	252	-	-	-	1	1
-------------------	--------	-----	---	---	---	---	---



**ORDERING NOTES:**

This grommet is only available in black.

**ORDERING PROCEDURES**

To order, please specify the following:

- 1) Krug product model number
- 2) Wood species and finish, see page 577
- 4) Pull style and finish, see page 581
- 5) Grommet location and style if applicable

\* Indicates model illustrated by line drawing

**CODE DESCRIPTION**

PD - pencil drawer  
 WM - wire management  
 PDVM - power/data/voice grommet

**STANDARD FINISHES**

For a complete list of standard wood finishes please see page 577.

**BRASS FINISH**

Standard grommets and pop-up grommets are available in black or brass finishes.

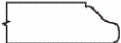

# STRATFORD | MODULAR COMPONENTS

Description	Model	Cherry		W	D	H	Shipping Weight	Cubic Feet
		Walnut						
Tops for 2-Hi Modular Storage  	98TP6020	1260		59.75	19.75	29.25	45	2
	98TP6024	1332		59.75	23.75	1.25	52	2
	98TP6320	1358		62.75	19.75	1.25	48	2
	98TP6324	1377		62.75	23.75	1.25	51	3
	98TP6620*	1395		65.75	19.75	1.25	53	3
	98TP6624	1460		65.75	23.75	1.25	61	3
	98TP6920	1483		68.75	19.75	1.25	57	3
	98TP6924	1510		68.75	23.75	1.25	61	3
	98TP7220	1527		71.75	19.75	1.25	63	3
	98TP7224	1582		71.75	23.75	1.25	65	3
	98TP7520	1593		74.75	19.75	1.25	67	3
	98TP7524	1631		74.75	23.75	1.25	70	3
	98TP7820	1644		77.75	19.75	1.25	71	3
	98TP7824	1704		77.75	23.75	1.25	73	3
	98TP8420	1756		83.75	19.75	1.25	76	3
	98TP8424	1810		83.75	23.75	1.25	78	4
	98TP9020	1861		89.75	19.75	1.25	81	3
	98TP9024	1913		89.75	23.75	1.25	86	4
	98TP9220	1928		91.75	19.75	1.25	85	3
	98TP9224	1956		91.75	23.75	1.25	89	4
98TP9620	1964		95.75	19.75	1.25	88	4	
98TP9624	2020		95.75	23.75	1.25	92	4	

### ORDERING NOTES:

A half gable is required on any open span greater than 48" that does not have a modesty panel. Standard 98TP tops have profile on the ee sides. They are designed to be flush on the back edge

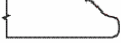
Description	Model	Cherry		W	D	H	Shipping Weight	Cubic Feet
		Walnut						
Tops with one Coved End  	98TPR6020L	1260		59.75	19.75	1.25	45	2
	98TPR6020R	1260		59.75	19.75	1.25	45	2
	98TPR6024L	1332		59.75	23.75	1.25	52	3
	98TPR6024R	1332		59.75	23.75	1.25	52	3
	98TPR6620L	1395		65.75	19.75	1.25	53	3
	98TPR6620R*	1395		65.75	19.75	1.25	53	3
	98TPR6624L	1460		65.75	23.75	1.25	61	3
	98TPR6624R	1460		65.75	23.75	1.25	61	3
	98TPR7220L	1527		71.75	19.75	1.25	63	3
	98TPR7220R	1527		71.75	19.75	1.25	63	3
	98TPR7224L	1582		71.75	23.75	1.25	65	3
	98TPR7224R	1582		71.75	23.75	1.25	65	3

### ORDERING NOTES:

A half gable is required on any open span greater than 48" that does not have a modesty panel. Standard 98TP tops have profile on the ee sides. They are designed to be flush on the back edge

#### DIMENSION KEY

W — width  
D — depth  
H — height of worksurface  
KW— kneehole width

Dimensions are in inches and approximate.  
Contact Customer Service if dimensions are critical.

\*See page 5 for KrugExpress program.

#### CODE DESCRIPTION

TP - modular top with standard profile  
TPR - modular top for run-offs with one coved connecting end  
TPI - modular top with inverted profile  
ST - freestanding storage  
STM - modular storage  
WRM - modular wardrobe  
G - includes glass doors  
D - 2 file drawer  
F - 2 box, 1 file drawer

#### OPEN SPANS

It is not recommended that modular units be combined together to create open spans greater than 60".

#### STORAGE

Freestanding storage has finished, profiled tops and base molding on three sides. Modular storage does not have finished tops (they must be ordered separately) and base molding is only across the front.

# STRATFORD | MODULAR COMPONENTS

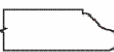
Description	Model	Cherry Walnut	W	D	H	Shipping Weight	Cubic Feet
Tops with one Coved End, Continued	98TPR7820L	1644	77.75	19.75	1.25	71	3
	98TPR7820R	1644	77.75	19.75	1.25	71	3
	98TPR7824L	1704	77.75	23.75	1.25	73	3
	98TPR7824R	1704	77.75	23.75	1.25	73	3
	98TPR8420L	1756	83.75	19.75	1.25	76	3
	98TPR8420R	1756	83.75	19.75	1.25	76	3
	98TPR8424L*	1810	83.75	23.75	1.25	78	4
	98TPR8424R	1810	83.75	23.75	1.25	78	4
	98TPR9020L	1861	89.75	19.75	1.25	81	3
	98TPR9020R	1861	89.75	19.75	1.25	86	3
	98TPR9024L	1913	89.75	23.75	1.25	86	4
	98TPR9024R	1913	89.75	23.75	1.25	86	4
	98TPR9620L	1964	95.75	19.75	1.25	88	4
	98TPR9620R	1964	95.75	19.75	1.25	88	4
	98TPR9624L	2020	95.75	23.75	1.25	92	4
	98TPR9624R	2020	95.75	23.75	1.25	92	4

### ORDERING NOTES:

A half gable is required on any open span greater than 48" that does not have a modesty panel. Standard 98TP tops have profile on the e sides. They are designed to be flush on the back edge

Modular Pedestal	Model	Cherry Walnut	W	D	H	Shipping Weight	Cubic Feet
	98P1620304D**	1960	15.75	19.75	29.25	68	6
	98P1624304D	2110	15.75	23.75	29.25	73	8
	98P1620304F*	2105	15.75	19.75	29.25	70	6
	98P1624304F	2253	15.75	23.75	29.25	75	8

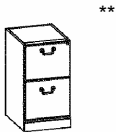

### ORDERING NOTES:

Modular storage units do not have finished tops and are intended to be combined with 98TP tops. Modular storage unit backs are finished. It is not recommended that modular units be combined together to create open spans greater than 60".

### ORDERING PROCEDURES

To order, please specify the following:

- 1) Krug product model number
- 2) Wood species and finish, see page 577
- 4) Pull style and finish, see page 581
- 5) Grommet location and style if applicable

\* Indicates model illustrated by line drawing

### CODE DESCRIPTION

TP - modular top with standard profile  
 TPR - modular top for run-offs with one coved connecting end  
 TPI - modular top with inverted profile  
 ST - freestanding storage  
 STM - modular storage  
 WRM - modular wardrobe  
 G - includes glass doors  
 D - 2 file drawer  
 F - 2 box, 1 file drawer

### STANDARD FINISHES

For a complete list of standard wood finishes please see page 577.

### STORAGE

Freestanding storage has finished, profiled tops and base molding on three sides. Modular storage does not have finished tops (they must be ordered separately) and base molding is only across the front.

# STRATFORD | MODULAR COMPONENTS

Description	Model	Cherry Walnut				Shipping Weight	Cubic Feet
			W	D	H		
Modular Bookcase	98STM30203011	2242	29.75	19.75	29.25	105	13
Pedestal	98STM36203011	2387	35.75	19.75	29.25	109	15
	98STM30243011*	2312	29.75	19.75	29.25	113	15
	98STM36243011	2464	35.75	19.75	29.25	117	18

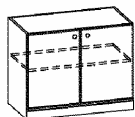

### ORDERING NOTES:

Modular storage units do not have finished tops and are intended to be combined with 98TP tops. Modular storage unit backs are finished. Locks may be added to the bookcase doors at a **\$152 list upcharge**.

Modular Lateral File	98STM30203001	2680	29.75	19.75	29.25	113	13
Pedestal	98STM36203001	2829	35.75	19.75	29.25	117	15
	98STM30243001*	2756	29.75	19.75	29.25	121	15
	98STM36243001	2910	35.75	19.75	29.25	129	18



### ORDERING NOTES:

Modular storage units do not have finished tops and are intended to be combined with 98TP tops. Modular storage unit backs are finished.

Half Gable	98HG2710	476	10	27	27	11	1
	98HG2716	540	16	27	27	16	1

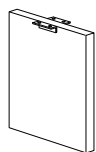

### ORDERING NOTES:

This unit should be ordered to center-support open spans greater than 60". Use 98HG2710 with 20" & 24" deep cases and 98HG2716 with 30" deep cases.

Modular End Panel	98LB2030L	885	12	19.75	29.25	35	2
Support	98LB2430L*	929	12	23.75	29.25	37	2
	98LB2030R	885	12	19.75	29.25	35	2
	98LB2430R	929	12	23.75	29.25	37	2



Modular Hinged Modesty	98MPY72	895	37.5	-	30.5	42	3
Panel	98MPY78*	931	43.5	-	30.5	50	3
	98MPY84	960	49.5	-	30.5	60	3

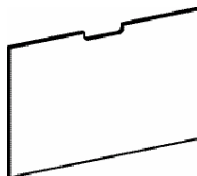

### DIMENSION KEY

W — width  
D — depth  
H — height of worksurface  
KW— kneehole width

Dimensions are in inches and approximate. Contact Customer Service if dimensions are critical.

\*See page 5 for KrugExpress program.

### CODE DESCRIPTION

TP - modular top with standard profile  
TPR - modular top for run-offs with one coved connecting end  
TPI - modular top with inverted profile  
ST - freestanding storage  
STM - modular storage  
WRM - modular wardrobe  
G - includes glass doors  
D - 2 file drawer  
F - 2 box, 1 file drawer

### STANDARD FINISHES

For a complete list of standard wood finishes please see page 577.

### STORAGE

Freestanding storage has finished, profiled tops and base molding on three sides. Modular storage does not have finished tops (they must be ordered separately) and base molding is only across the front.

# STRATFORD | MODULAR COMPONENTS

## Ordering modular storage with 98TP tops

30" high modular storage units are created by combining 98TP modular tops and modular bases. The top profile on a 98TP matches that of all other 30" high Stratford products including desks and credenzas. For example:

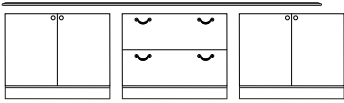

One 98TP-9224 modular top.  
Two 98STM-302430-11 modular bookcase pedestals.  
One 98STM-302430-01 modular lateral file pedestal

The modular components can be used together to create a variety of custom storage.

## Ordering modular storage with 98TPR tops

30" high modular run-off units are created by combining 98TPR modular tops and modular bases. For example:

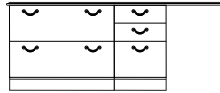

One 98TPR-6624 modular top.  
One 98STM-302430-01 modular lateral file pedestal. One 98P-162430-4F modular B/B/F pedestal.

The modular components can be used together to create a variety of custom run-off units.

## Modular Top and Storage Flush Combinations

Use this guide of recommendations to create flush units with modular tops and storage

TOP SIZE	PEDESTAL COMBINATIONS THAT FIT FLUSH	LEFT/RIGHT OVERHANG
----------	--------------------------------------	---------------------

### 2-hi modular storage

98TP-63	(2) 30" wide pedestals	1 1/2"
98TP-69	(1) 30" wide pedestal and (1) 36" wide	1 1/2"
98TP-75	pedestal (2) 36" wide pedestals	1 1/2"
98TP-92	(3) 30" wide pedestals	1 1/2"

## ORDERING PROCEDURES

To order, please specify the following:

- 1) Krug product model number
- 2) Wood species and finish, see page 577
- 4) Pull style and finish, see page 581
- 5) Grommet location and style if applicable

\* Indicates model illustrated by line drawing

# STRATFORD | MODULAR COMPONENTS

Description	Model	Cherry Walnut	W	D	H	Shipping Weight	Cubic Feet
Top for 2-Hi Modular Bookcases	98TP7516	1275	74.75	16	1.25	55	2

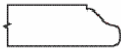

2-Hi Modular Bookcase	98BCM361630	1689	35.75	16	29.25	91	12
-----------------------	-------------	------	-------	----	-------	----	----



**ORDERING NOTES:**  
Modular bookcases do not have finished tops and are intended to be combined with 98TP tops.

Ordering modular bookcases with 98TP tops  
30" high modular bookcases can be created by combining modular tops and bookcase units.



One 98TP-7516 modular top.  
Two 98BCM-3616-30 modular bookcases.

The modular components can be used together to create custom storage.

**DIMENSION KEY**

W — width  
D — depth  
H — height of worksurface  
KW— kneehole width

Dimensions are in inches and approximate.  
Contact Customer Service if dimensions are critical.  
\*See page 5 for KrugExpress program.

**CODE DESCRIPTION**

G - includes glass doors  
BC - bookcase  
BCM- modular bookcase  
TPI- modular bookcase top

**STANDARD FINISHES**

For a complete list of standard wood finishes please see page 577.

# STRATFORD | MODULAR COMPONENTS

Description	Model	Cherry Walnut				Shipping Weight	Cubic Feet
			W	D	H		
3-Hi Modular Bookcase Tops 	98TPI6216-3HI	1266	59.75	15.75	1.25	43	3
	98TPI7416-3HI	1275	72.75	15.75	1.25	51	3
	98TPI9216-3HI*	1284	89.75	15.75	1.25	79	4
	98TPI9716-3HI	1295	95.75	15.75	1.25	92	4

3-Hi Modular Bookcase Tops	98PRM301640	1867	29.5	15.75	39.25	120	22
	98PRM361640	1913	35.75	15.75	39.25	135	26

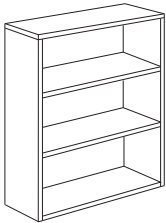

3-Hi Modular Closed Bookcase Pier, No Base	98PRM30164011	2242	29.5	15.75	39.25	135	22
	98PRM36164011	2324	35.75	15.75	39.25	150	26

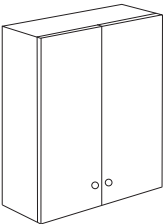

## ORDERING PROCEDURES

To order, please specify the following:

- 1) Krug product model number
- 2) Wood species and finish, see page 577
- 4) Pull style and finish, see page 581
- 5) Grommet location and style if applicable

\* Indicates model illustrated by line drawing

## CODE DESCRIPTION

0 - no pedestal  
 4 - full height pedestals  
 D - 2 file drawer  
 F - 2 box, 1 file drawer  
 L - left hand support position  
 R - right hand support position  
 CD - center drawer  
 OT - oversized top option  
 BT - bow top option  
 CC - corner credenza

## STANDARD FINISHES

For a complete list of standard wood finishes please see page 577.

## STORAGE

Freestanding storage has finished, profiled tops and base molding on three sides. Modular storage does not have finished tops (they must be ordered separately) and base molding is only across the front.

# STRATFORD | MODULAR COMPONENTS

Description	Model	Cherry Walnut		W	D	H	Shipping Weight	Cubic Feet
Top for 5-Hi Modular Bookcases	98TPI7416	1275		73.75	16	1.25	55	2



**ORDERING NOTES:**

This bookcase has a 1" overhang on the left and right sides. There is no overhang on the back edge. Profile of 98TPI tops are inverted.

5-Hi Modular Bookcase	98BCM361671	2321		35.75	16	69.75	158	27
-----------------------	-------------	------	--	-------	----	-------	-----	----



**ORDERING NOTES:**

Modular bookcases do not have finished tops and are intended to be combined with 98TP tops.

Ordering modular bookcases with 98TPI tops

71" high modular bookcases can be created by combining modular tops and bookcase units.

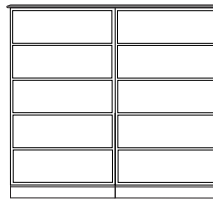
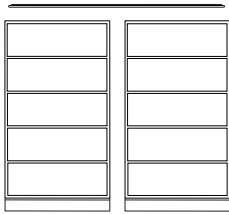

One 98TPI-7416 modular top.  
Two 98BCM-3616-71 modular bookcases.

The modular components can be used together to create custom storage.

**DIMENSION KEY**

W — width  
D — depth  
H — height of worksurface  
KW — kneehole width

Dimensions are in inches and approximate. Contact Customer Service if dimensions are critical.

\*See page 5 for KrugExpress program.

**CODE DESCRIPTION**

G - includes glass doors  
BC - bookcase  
BCM- modular bookcase  
TPI- modular bookcase top

**STANDARD FINISHES**

For a complete list of standard wood finishes please see page 577.

**WIRING GROMMET**

One rectangular grommet in a standard position is optional at no charge. Additional rectangular grommets are available at an upcharge of **\$152 ist.**

# STRATFORD | MODULAR COMPONENTS

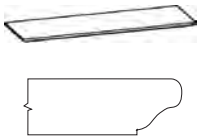
Description	Model	Cherry Walnut	W	D	H	Shipping Weight	Cubic Feet
	98TPI6220	1260	61.75	19.75	1.25	45	2
	98TPI6224	1332	61.75	23.75	1.25	52	2
	98TPI6820	1395	67.75	19.75	1.25	53	3
	98TPI6824	1460	67.75	23.75	1.25	61	3
	98TPI7420*	1527	73.75	19.75	1.25	63	3
	98TPI7424	1582	73.75	23.75	1.25	65	3
	98TPI9220	1861	91.75	19.75	1.25	71	3
	98TPI9224	1913	91.75	23.75	1.25	73	3

### ORDERING NOTES:

Profile of 98TPI tops are inverted.

### Ordering modular storage with 98TPI tops

71 high modular storage units are created by combining 98TPI modular tops and modular bases.

The top profile on a 98TPI matches that of all other 71 high Stratford products including hutches and freestanding storage. For example:



One 98TPI-7424 modular top.  
One 98STM-362471-04G modular storage. One 98STM-362471-04 modular storage.

The modular components can be used together to create a variety of custom storage.

### Modular Top and Storage Flush Combinations

Use this guide of recommendations to create flush units with modular tops and storage.

TOP SIZE	PEDESTAL COMBINATIONS THAT FIT FLUSH	LEFT/RIGHT OVERHANG
5-hi modular storage		
98TPI-62	(2) 30 wide pedestals	1
98TPI-68	(2) 30 wide pedestals and (1) 36 wide pedestal	1
98TPI-74	(2) 36 wide pedestals	1
98TPI-92	(3) 30 wide pedestals	1

### Pot light option for modular storage

#### Upcharge

**689**

The factory installed pot light option is available on any glass door or grill door modular storage unit at an upcharge of **\$689**.

The light is mounted through the top of the storage unit and the modular top and activated by a switch located on the light inside the case.

Please add the upcharge shown to storage price and specify pot light option on your order.

A drawing showing assembled configuration of all modular storage must be provided when ordering the pot light option to accurately determine grommet locations.

### ORDERING PROCEDURES

To order, please specify the following:

- 1) Krug product model number
- 2) Wood species and finish, see page 577
- 4) Pull style and finish, see page 581
- 5) Grommet location and style if applicable

\* Indicates model illustrated by line drawing

### CODE DESCRIPTION

TP - modular top with standard profile  
TPR - modular top for run-offs with one coved connecting end  
TPI - modular top with inverted profile  
ST - freestanding storage  
STM - modular storage  
WRM - modular wardrobe  
G - includes glass doors  
D - 2 file drawer  
F - 2 box, 1 file drawer

### STANDARD FINISHES

For a complete list of standard wood finishes please see page 577.

### STORAGE

Freestanding storage has finished, profiled tops and base molding on three sides. Modular storage does not have finished tops (they must be ordered separately) and base molding is only across the front.



# STRATFORD | MODULAR COMPONENTS

Description	Model	Cherry		W	D	H	Shipping Weight	Cubic Feet
		Walnut						
2 Lateral Files, 3 Open Shelves	98STM30207103	4842		29.75	19.75	70.5	198	28
	98STM36207103	4962		35.75	19.75	70.5	208	34
	98STM30247103*	4904		29.75	23.75	70.5	208	34
	98STM36247103	5028		35.75	23.75	70.5	218	40

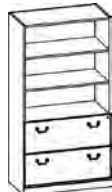

**ORDERING NOTES:**

Modular storage units do not have finished tops and are intended to be combined with 98TP tops. Modular storage unit backs are finished

2 Lateral File, 3 Closed Shelves	98STM30207104	5419		29.75	19.75	70.5	206	28
	98STM36207104	5544		35.75	19.75	70.5	216	34
	98STM30247104*	5477		29.75	23.75	70.5	216	34
	98STM36247104	5608		35.75	23.75	70.5	226	40



**ORDERING NOTES:**

Modular storage units do not have finished tops and are intended to be combined with 98TP tops. Modular storage unit backs are finished

2 Lateral Files, 3 Closed Clear Glass Doors	98STM30207104G	5717		29.75	19.75	70.5	216	28
	98STM36207104G	5839		35.75	19.75	70.5	226	34
	98STM30247104G*	5771		29.75	23.75	70.5	226	34
	98STM36247104G	5904		35.75	23.75	70.5	236	40

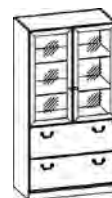

**ORDERING NOTES:**

All shelves in glass door bookcases are 1/4" thick glass. Modular pedestals do not have finished tops and are intended to be combined with 98TP tops. Modular pedestal backs are finished. This item is NOT available on KrugExpress.

**DIMENSION KEY**

W — width  
D — depth  
H — height of worksurface  
KW— kneehole width

Dimensions are in inches and approximate. Contact Customer Service if dimensions are critical.

\*See page 5 for KrugExpress program.

**CODE DESCRIPTION**

TP - modular top with standard profile  
TPR - modular top for run-offs with one coved connecting end  
TPI - modular top with inverted profile  
ST - freestanding storage  
STM - modular storage  
WRM - modular wardrobe  
G - includes glass doors  
D - 2 file drawer  
F - 2 box, 1 file drawer

**STANDARD FINISHES**

For a complete list of standard wood finishes please see page 577.

**STORAGE**

Freestanding storage has finished, profiled tops and base molding on three sides. Modular storage does not have finished tops (they must be ordered separately) and base molding is only across the front.

# STRATFORD | MODULAR COMPONENTS

Description	Model	Cherry		W	D	H	Shipping Weight	Cubic Feet
		Walnut						
2 Lateral Files, 3 Closed Grill Doors	98STM30207104Z	6708		29.75	19.75	70.5	206	28
	98STM36207104Z	6831		35.75	19.75	70.5	216	34
	98STM30247104Z*	6763		29.75	23.75	70.5	216	34
	98STM36247104Z	6894		35.75	23.75	70.5	226	40

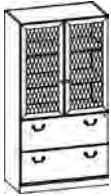

**ORDERING NOTES:**

All shelves in glass door bookcases are 1/4" thick glass. Modular pedestals do not have finished tops and are intended to be combined with 98TP tops. Modular pedestal backs are finished. This item is NOT available on KrugExpress.

5 Closed Shelves	98STM30207111	4537		29.75	19.75	70.5	225	28
	98STM30247111	4521		29.75	19.75	70.5	235	34
	98STM36207111*	4586		35.75	23.75	70.5	245	34
	98STM36247111	4645		35.75	23.75	70.5	255	40



**ORDERING NOTES:**

Modular storage units do not have finished tops and are intended to be combined with 98TP tops. Modular storage unit backs are finished

5 Closed Shelves Left, Closed Wardrobe Right	98WRM30247101	4206		29.75	19.75	70.5	225	34
	98WRM36247101*	4372		35.75	23.75	70.5	245	40

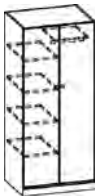

**ORDERING NOTES:**

Modular storage units do not have finished tops and are intended to be combined with 98TP tops. Modular storage unit backs are finished

**ORDERING PROCEDURES**

To order, please specify the following:

- 1) Krug product model number
- 2) Wood species and finish, see page 577
- 4) Pull style and finish, see page 581
- 5) Grommet location and style if applicable

\* Indicates model illustrated by line drawing

**CODE DESCRIPTION**

TP - modular top with standard profile  
 TPR - modular top for run-offs with one coved connecting end  
 TPI - modular top with inverted profile  
 ST - freestanding storage  
 STM - modular storage  
 WRM - modular wardrobe  
 G - includes glass doors  
 D - 2 file drawer  
 F - 2 box, 1 file drawer

**STANDARD FINISHES**

For a complete list of standard wood finishes please see page 577.

**STORAGE**

Freestanding storage has finished, profiled tops and base molding on three sides. Modular storage does not have finished tops (they must be ordered separately) and base molding is only across the front.

# STRATFORD | BOOKCASES

Description	Model	Cherry Walnut	W	D	H	Shipping Weight	Cubic Feet
2-Hi Open	98BC361630	2106	35.75	16	30.5	91	12



**ORDERING NOTES:**

This 30.25" high bookcase has a 1-1/2" overhang on the left and right sides. There is no overhang on the back edge.

2-Hi with Clear Glass Doors	98BC36163011G	2230	35.75	16	30.5	101	12
-----------------------------	---------------	------	-------	----	------	-----	----



**ORDERING NOTES:**

This 30.25" high bookcase has a 1-1/2" overhang on the left and right sides. There is no overhang on the back edge. The glass shelf is 1/4" thick and adjustable. This item is NOT available on KrugExpress.

Open Bookcase	98BC361657	2672	35.75	16	57	115	22
	98BC361671*	2894	35.75	16	70.5	166	27



**ORDERING NOTES:**

This bookcase has a 1" overhang on the left and right sides. There is no overhang on the back edge.

Computer Stand	98TH3624	2956	35.75	23.75	30.5	61	22
	98TH4824*	3249	47.75	23.75	30.5	82	28



**ORDERING NOTES:**

The computer stand includes a grommet in the back panel.

**DIMENSION KEY**

W — width  
 D — depth  
 H — height of worksurface  
 KW— kneehole width

Dimensions are in inches and approximate. Contact Customer Service if dimensions are critical.

\*See page 5 for KrugExpress program.

**CODE DESCRIPTION**

G - includes glass doors  
 BC - bookcase  
 BCM- modular bookcase  
 TPI- modular bookcase top

**STANDARD FINISHES**

For a complete list of standard wood finishes please see page 577.

**WIRING GROMMET**

One rectangular black or one antique brass grommet in a standard position is optional at no charge. Please note grommet choice clearly on order form. Additional grommets are available at an upcharge of **\$152 list**.

# STRATFORD | FREESTANDING STORAGE

Description	Model	Cherry Walnut	W	D	H	Shipping Weight	Cubic Feet
2 Lateral Files	98ST30203001*	3812	29.75	19.75	30.5	140	13
	98ST36203001	3718	35.75	19.75	30.5	145	15
	98ST30243001	3867	29.75	19.75	30.5	145	15
	98ST36243001	3867	35.75	19.75	30.5	150	18



2 Closed Shelves	98ST30203011*	2807	29.75	19.75	30.5	100	13
	98ST36203011	2898	35.75	19.75	30.5	130	15
	98ST30243011	2853	29.75	19.75	30.5	130	15
	98ST36243011	2954	35.75	19.75	30.5	135	18

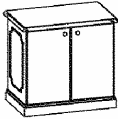

### ORDERING NOTES:

Locks may be added to bookcase or wardrobe doors at a **\$152 list** upcharge.

4 Lateral Files	98ST30205701*	5232	29.75	19.75	57	186	28
	98ST36205701	5232	35.75	19.75	57	211	34
	98ST30245701	5359	29.75	23.75	57	211	34
	98ST36245701	5691	35.75	23.75	57	236	40

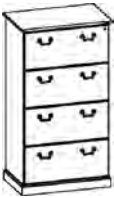

2 Lateral Files, 3 Open Shelves	98ST30207103*	5568	29.75	19.75	70.5	220	28
	98ST36207103	5708	35.75	19.75	70.5	230	34
	98ST30247103	5708	29.75	23.75	70.5	230	34
	98ST36247103	5784	35.75	23.75	70.5	240	40



### ORDERING PROCEDURES

To order, please specify the following:

- 1) Krug product model number
- 2) Wood species and finish, see page 577
- 4) Pull style and finish, see page 581
- 5) Grommet location and style if applicable

\* Indicates model illustrated by line drawing

### CODE DESCRIPTION

TP - modular top with standard profile  
 TPR - modular top for run-offs with one coved connecting end  
 TPI - modular top with inverted profile  
 ST - freestanding storage  
 STM - modular storage  
 WRM - modular wardrobe  
 G - includes glass doors  
 D - 2 file drawer  
 F - 2 box, 1 file drawer

### STANDARD FINISHES

For a complete list of standard wood finishes please see page 577.

### STORAGE

Freestanding storage has finished, profiled tops and base molding on three sides. Modular storage does not have finished tops (they must be ordered separately) and base molding is only across the front.

# STRATFORD | FREESTANDING STORAGE

Description	Model	Cherry Walnut	W	D	H	Shipping Weight	Cubic Feet
2 Lateral File, 3 Closed Shelves	98ST30207104*	6233	29.75	19.75	70.5	240	28
	98ST36207104	6375	35.75	19.75	70.5	250	34
	98ST30247104	6297	29.75	23.75	70.5	250	34
	98ST36247104	6297	35.75	23.75	70.5	260	40

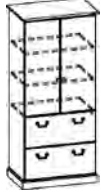

**ORDERING NOTES:**

Locks are available on all wood doors at **\$152 list per lock**. 24",30" & 36" wardrobes require 2 locks.

2 Lateral Files, 3 Closed Clear Glass Doors	98ST30207104G*	6529	29.75	19.75	70.5	250	28
	98ST36207104G	6671	35.75	19.75	70.5	260	34
	98ST30247104G	6596	29.75	23.75	70.5	260	34
	98ST36247104G	6747	35.75	23.75	70.5	270	40



**ORDERING NOTES:**

All shelves in glass door bookcases are 1/4" thick glass. This item is NOT available on KrugExpress.

2 Lateral Files, 3 Closed Grill Doors	98ST30207104Z*	7222	29.75	19.75	70.5	240	28
	98ST36207104Z	7365	35.75	19.75	70.5	250	34
	98ST30247104Z	7288	29.75	23.75	70.5	250	34
	98ST36247104Z	7288	35.75	23.75	70.5	260	40

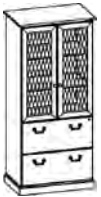

**ORDERING NOTES:**

All shelves in glass door bookcases are 1/4" thick glass. This item is NOT available on KrugExpress.

**DIMENSION KEY**

W — width  
D — depth  
H — height of worksurface  
KW— kneehole width

Dimensions are in inches and approximate.  
Contact Customer Service if dimensions are critical.

\*See page 5 for KrugExpress program.

**CODE DESCRIPTION**

TP - modular top with standard profile  
TPR - modular top for run-offs with one coved connecting end  
TPI - modular top with inverted profile  
ST - freestanding storage  
STM - modular storage  
WRM - modular wardrobe  
G - includes glass doors  
D - 2 file drawer  
F - 2 box, 1 file drawer



**STANDARD FINISHES**

For a complete list of standard wood finishes please see page 577.

**STORAGE**

Freestanding storage has finished, profiled tops and base molding on three sides. Modular storage does not have finished tops (they must be ordered separately) and base molding is only across the front.

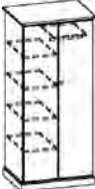
# STRATFORD | FREESTANDING STORAGE

Description	Model	Cherry Walnut	W	D	H	Shipping Weight	Cubic Feet
 5 Closed Shelves	98ST30207111	5134	29.75	19.75	70.5	230	28
	98ST36207111	5275	35.75	19.75	70.5	240	34
	98ST30247111*	5199	29.75	23.75	70.5	240	34
	98ST36247111	5343	35.75	23.75	70.5	250	40
 5 Closed Shelves, Closed Wardrobe	98WR30247101*	4834	29.75	23.75	70.5	245	34
	98WR36247101	5028	35.75	23.75	70.5	265	40
	98WR30247103	4834					
	98WR36247103	5028					
 2 Lateral Files, 4 Open Shelves	98ST30208403	6375	29.75	19.75	83.5	260	33
	98ST36208403	6439	35.75	19.75	83.5	270	40
	98ST30248403*	6466	29.75	23.75	83.5	270	40
	98ST36248403	6536	35.75	23.75	83.5	290	47
 2 Lateral File, 4 Closed Shelves	98ST30208404	6615	29.75	19.75	83.5	285	33
	98ST36208404	6674	35.75	19.75	83.5	295	40
	98ST30248404*	6708	29.75	23.75	83.5	295	40
	98ST36248404	6781	35.75	23.75	83.5	315	47

### ORDERING NOTES:

Locks are available on all wood doors at **\$152 list** per lock. 24", 30" & 36" wardrobes require 2 locks.

### ORDERING PROCEDURES

To order, please specify the following:

- 1) Krug product model number
- 2) Wood species and finish, see page 577
- 4) Pull style and finish, see page 581
- 5) Grommet location and style if applicable

\* Indicates model illustrated by line drawing

### CODE DESCRIPTION

TP - modular top with standard profile  
 TPR - modular top for run-offs with one coved connecting end  
 TPI - modular top with inverted profile  
 ST - freestanding storage  
 STM - modular storage  
 WRM - modular wardrobe  
 G - includes glass doors  
 D - 2 file drawer  
 F - 2 box, 1 file drawer

### STANDARD FINISHES

For a complete list of standard wood finishes please see page 577.

### STORAGE

Freestanding storage has finished, profiled tops and base molding on three sides. Modular storage does not have finished tops (they must be ordered separately) and base molding is only across the front.

# STRATFORD | FREESTANDING STORAGE

Description	Model	Cherry Walnut	W	D	H	Shipping Weight	Cubic Feet
2 Lateral Files, 4 Closed Clear Glass Doors	98ST30208404G	6913	29.75	19.75	83.5	295	33
	98ST36208404G	6974	35.75	19.75	83.5	205	40
	98ST30248404G*	6999	29.75	23.75	83.5	205	40
	98ST36248404G	7078	35.75	23.75	83.5	325	47



**ORDERING NOTES:**

All shelves in glass door bookcases are 1/4" thick glass. This item is NOT available on KrugExpress.

2 Lateral Files, 4 Closed Grill Doors	98ST30208404Z	7605	29.75	19.75	83.5	285	33
	98ST36208404Z	7662	35.75	19.75	83.5	295	40
	98ST30248404Z*	7696	29.75	23.75	83.5	295	40
	98ST36248404Z	7766	35.75	23.75	83.5	315	47

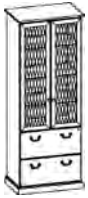

**ORDERING NOTES:**

All shelves in glass door bookcases are 1/4" thick glass. This item is NOT available on KrugExpress.

6 Closed Shelves	98ST30208411	5646	29.75	19.75	83.5	250	33
	98ST36208411	5805	35.75	19.75	83.5	260	40
	98ST30248411*	5721	29.75	23.75	83.5	260	40
	98ST36248411	5874	35.75	23.75	83.5	270	47



**ORDERING NOTES:**

Locks are available on all wood doors at **\$152 list** per lock. 24", 30" & 36" wardrobes require 2 locks.

Mobile Pedestals	98MP1620294D*	2263	15.75	20	29	78	6
	98MP1620294F**	2405	15.75	20	29	80	6



**DIMENSION KEY**

W — width  
D — depth  
H — height of worksurface  
KW— kneehole width

Dimensions are in inches and approximate. Contact Customer Service if dimensions are critical.

\*See page 5 for KrugExpress program.

**CODE DESCRIPTION**

TP - modular top with standard profile  
TPR - modular top for run-offs with one coved connecting end  
TPI - modular top with inverted profile  
ST - freestanding storage  
STM - modular storage  
WRM - modular wardrobe  
G - includes glass doors  
D - 2 file drawer  
F - 2 box, 1 file drawer

**STANDARD FINISHES**

For a complete list of standard wood finishes please see page 577.

**STORAGE**

Freestanding storage has finished, profiled tops and base molding on three sides. Modular storage does not have finished tops (they must be ordered separately) and base molding is only across the front.

# STRATFORD | RECEPTION

Description	Model	Cherry Walnut				Shipping Weight	Cubic Feet
			W	D	H		
Gallery Reception Desk	98GD72304LFR0	7368	73.5	30.5	43	325	66
	98GD72304LORF	7368	73.5	30.5	43	325	66

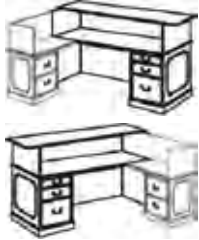

**ORDERING NOTES:**

Laminate worksurfaces are available at a 10% upcharge. 30" deep Stratford desks have a 1-1/2" overhang on the guest side. 36" deep Stratford desks have a 7 1/2" overhang on the guest side. See page 578 for more information on the desks overhang and chassis dimensions. A burled walnut top option is available at a 20% upcharge.

Reception Return	98GRH4824L4D	3804	47.75	23.75	41.75	28.5	250	38
	98GRH4824R4D	3804	47.75	23.75	41.75	28.5	250	38

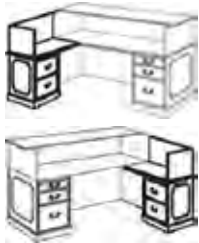

**ORDERING NOTES:**

Laminate worksurfaces are available at a 10% upcharge. 30" deep Stratford desks have a 1-1/2" overhang on the guest side. 36" deep Stratford desks have a 7 1/2" overhang on the guest side. See page 578 for more information on the desks overhang and chassis dimensions. A burled walnut top option is available at a 20% upcharge.

Gallery Reception Linking Units	98GLU4224H	2053	41.75	23.75	41.75		105	34
---------------------------------	------------	------	-------	-------	-------	--	-----	----



**ORDERING NOTES:**

Linking unit is used to connect Gallery Desk and Credenza to form a 'U' station.

Reception Credenzas	98GC7224L4D	6284	71.75	23.75	41.75		320	57
	98GC7224L4F	6284	71.75	23.75	41.75		320	57
	98GC7224R4D	6284	71.75	23.75	41.75		320	57
	98GC7224R4F	6284	71.75	23.75	41.75		320	57
	98GC7824L4D	6954	77.75	23.75	41.75		355	60
	98GC7824L4F*	6954	77.75	23.75	41.75		355	60
	98GC7824R4D	6954	77.75	23.75	41.75		355	60
	98GC7824R4F	6954	77.75	23.75	41.75		355	60

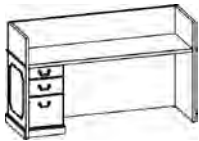

Transaction Top	98GRT66	1452	66.75	12	1.25		48	2
-----------------	---------	------	-------	----	------	--	----	---



**ORDERING NOTES:**

Laminate worksurfaces are available at a 10% upcharge. 30" deep Stratford desks have a 1-1/2" overhang on the guest side. 36" deep Stratford desks have a 7 1/2" overhang on the guest side. See page 578 for more information on the desks overhang and chassis dimensions. A burled walnut top option is available at a 20% upcharge.

**ORDERING PROCEDURES**

To order, please specify the following:

- 1) Krug product model number
- 2) Wood species and finish, see page 577
- 4) Pull style and finish, see page 581
- 5) Grommet location and style if applicable

\* Indicates model illustrated by line drawing

**CODE DESCRIPTION**

- 0 - no pedestal
- 4 - full height pedestals
- D - 2 file drawer
- F - 2 box, 1 file drawer
- L - left hand support position
- R - right hand support position
- CD - center drawer
- OT - oversized top option
- BT - bow top option
- CC - corner credenza

**STANDARD FINISHES**

For a complete list of standard wood finishes please see page 577.

**WIRING GROMMET**

One rectangular black or one antique brass grommet in a standard position is optional at no charge. Please note grommet choice clearly on order form. Additional grommets are available at an upcharge of **\$152 list**.



# GENERAL INFORMATION

## Terms and Conditions

Net 30 days on approved credit. A late payment charge of 1% per month will be applied on overdue invoices. This charge will be pro-rated to the number of days past 30 days that the invoice is overdue. All applicable sales taxes are extra. Distribution of this price list does not in itself constitute an offer to sell. Orders can be received only from authorized Krug dealers. Acceptance of any order and terms of sale may be established at the discretion of Krug. Deposits are required on orders received from new accounts as well as on large or special orders. Krug reserves the right to discontinue designs, or to change designs, construction, prices, or materials without notice.

## Contact Information

Phone: 1.888.578.KRUG (5784) | Fax: 1.519.748.5177

Purchase Order Fax: 1.888.236.4783

Purchase Order E-mail: orders@krug.ca

Web: www.krug.ca E-mail: solutions@krug.ca

## Customer Service Hours

Please note customer service hours are:

8:30 am to 5:00 pm est

## Customer Satisfaction

It is the primary goal of Krug and our staff to ensure the complete satisfaction of our customers with our products and performance. If a problem arises with a Krug product after the expiration of the limited warranty period, Krug will exercise its best efforts to achieve the satisfaction of the customer in a manner that is fair to all concerned.

## Order Acknowledgments

Each order will be acknowledged via e-mail or fax. This acknowledgment is the final agreement between Krug and the customer, superseding all previous communications regarding the purchase order. Where there is a discrepancy on a purchase order between a product code and a description, Krug will make every effort to resolve the discrepancy, but will be ruled by the product code ordered. Please check all acknowledgments for accuracy, and advise Krug of any discrepancies with a purchase order.

## Order Cancellation

Krug reserves the right to not accept or allow cancellation of orders. All products are manufactured on a custom-made, make-to-order basis, and the purchasing, engineering and production of orders begins shortly after order placement - and the customer purchase order is a contract that authorizes Krug to manufacture the products. Acceptance of order cancellation (or partial cancellation) is solely at the discretion of Krug, and is dependent on the extent to which engineering, purchasing and manufacturing has been initiated by the time cancellation is requested. No order cancellations (partial or otherwise) are allowable more than 4 weeks from date of order placement (as order production is unable to be terminated by that point), and full payment of the acknowledged order value is required for any orders cancelled after 4 weeks. Cancellations may be allowable in less than 4 weeks after order placement, depending on the extent to which manufacturing has been initiated. An acceptance of order cancellation requires that the purchaser agrees to make payment for all costs incurred to the point of acceptance of cancellation. Cancellation charges include all costs for purchase of dedicated material and components, engineering costs for non-standard products, and all costs for manufacturing completed to that point, as well as a \$350 net charge for processing of the original order and for processing of cancellation invoicing.

## Pricing

Krug endeavors to ensure that all prices in this price list reflect accurately our current prices. However, errors do occur and will be rectified through notices to the field. Krug reserves the right to acknowledge pricing that may be different from the price list.

## Warranty

Krug warrants the construction and the finish of all our products to be free from defects in materials and workmanship for a period of 10 years from the date of purchase. This warranty is applicable to products in use by their original purchaser. This warranty does not apply to components not manufactured by Krug including textiles, which are subject to the specific warranties of those manufacturers,

if any. Textiles (fabric, leather, vinyl, or any other covering material) suppliers do not guarantee their products for durability and color fastness, and nor does Krug. Casters, mechanical and electrical components have a warranty of five years from the date of purchase. The Krug warranty does not apply to COM-specified materials, damage caused by a carrier other than Krug, or variation in wood finishes due to natural wood color variation. Krug cannot be held responsible for variations in fabric dye lots from order to order. All fabric is carefully inspected when it is received, but a degree of variation in color should be expected. Repairs or replacement of any defect covered under this warranty by Krug will be made, at our option and method, at no charge to the original purchaser during the warranty period. Krug's judgement is final and binding with respect to the nature or cause of defects or damage, and the necessity or manner of repair or replacement.

This warranty does not apply to defects or damage resulting from:

- normal wear and tear occurring with the use of the product
- negligence, misuse, excessive use, alteration, improper cleaning or repair
- substitution or use of incorrect or unauthorized components or material
- handling or installation that is incorrect, or that causes damage or defect
- damage incurred by a freight carrier other than Krug
- wearing of finishes and fabrics, and normal variations in material (including dye lot variations)
- properties of natural materials, including wood and leather
- exposure to environments with uncontrolled temperature and humidity (products must be transported, stored and used in climate-controlled conditions)

Note, specific warranties for components and materials not manufactured by Krug:

### Height Adjustable Mechanism Warranty

Krug warrants to the original consumer purchaser its Height Adjustable Mechanism that it will be free from defects in material and workmanship. This limited warranty covers material and manufacturing defects, which cause a non-conformance in the function of a table base and is limited to the following products and warranty term determined from their dates of purchase:

- a) Electronic components such as control boxes, hand switches and motors – two (2) years
- b) Mechanical components such as crank drives, spindles – five (5) years
- c) Structural components such as J-channels, feet and top supports – ten (10) years

The start of the warranty period is the documented date of your purchase of the product. The warranty herein is made to and for the benefit of the original consumer purchaser of the product and is non-transferable. If you discover a defect in material or workmanship during the warranty period, and Krug agrees that the defect exists, Krug will, at its option, repair or replace the Product at no charge to you, provided it is returned during the warranty period. In the unlikely event that your product should require repair or replacement during the warranty period, please contact Krug to obtain warranty service. The warranty period on replacement products is the remainder of the warranty on the original product or 30 days, whichever is longer.

## Testing

All Krug Conference products meet or exceed the testing requirements of ANSI/BIFMA X5.5-2014 or X5.9-2012.



## Dimensions

Dimensions are in inches and approximate, and subject to change without notice. Contact Customer Service if dimensions are critical.

## Installation Support

For assistance please contact Technical Support at 1-888-578-5784 x216 or e-mail installationhelp@krug.ca and you will be directed to the appropriate installation support person.

## Storage Charges

Krug reserves the right to assess a nominal storage charge if a customer does not accept shipment of an order within a week of the ship date.

## Export Packaging

Krug is pleased to provide the option for export packaging on all our products, to provide additional protection from damage. For shipments overseas, a quote for export packaging can be provided, based on the products to be ordered and the delivery destination - please contact Customer Service or Bids & Specification Support for more information and a quotation. KRUG is not responsible for shipment damage occurring on overseas shipments

Export Packaging is **STRONGLY RECOMMENDED** for:

- (A) all shipments outside of the lower 48 states and Canada
  - (B) all shipments that will be held in storage for an extended period prior to installation. Important: Please note that Krug will not be responsible for damage claims on product shipped or stored in the above conditions where export packaging has not been utilized.
- Please contact Customer Service for specifications or any other assistance regarding export packaging.

## Freight Terms and Conditions

1. All product is shipped FOB the Krug factory. Freight is either pre-paid to the destination or not pre-paid, depending on established customer specific freight terms.
2. Docks at the selected delivery location must be equipped to handle a 53' trailer. If a dock is inadequate for delivery by Krug, Krug will re-deliver to another local location and any additional costs will be charged to the customer.
3. For all deliveries, it is understood that Krug or its agent is making a dock delivery only (equipped to handle a 53' trailer), and any further work of truck unloading, delivery beyond the dock, installation, and removal of packaging is not authorized or paid for by Krug.
4. Drop shipments to the installation site, and timed deliveries, are available on larger shipments (full truckloads or slightly less) at no additional charge. Drop shipments or timed deliveries for smaller shipments may not be available, or if available will require a surcharge. Deliveries on an after hours basis, or on weekends, or any other special requirements, may be subject to a surcharge. Location and contact information, and the requested time of delivery, is required at least one week prior to the acknowledged shipment date. If this information is not provided one week in advance, or if the location or time of the drop shipment is changed less than one week in advance, a surcharge may be applied, and/or the drop shipment may not be scheduled.
5. For all deliveries - whether to the Customer location or drop shipment - any circumstances that result in the delay of our carrier (including unsuitable receiving facilities, or facilities not open or available), service charges will be applied at the rate of \$75/hour. Where re-delivery is necessary because of these circumstances, the full cost of re-delivery will be charged. If Less Than Truck Load is delivering, one hour is allocated to unload. Any additional time required to unload after the first hour is \$75/hour. If a Truck Load is delivering the order, three hours is allocated to unload. Any additional time required to unload is \$75/hour. Direct deliveries to site for net orders are possible, must exceed \$60,000 net, and accommodate 48-53' trailers. Krug is responsible for delivery to the approved delivery address. If an address change is required, this must be authorized by Krug 5 business days prior to ship date. Any additional delivery costs incurred after this time will be charged to the customer. Additional costs for partial shipment of orders are the responsibility of the customer, and will be added to invoices. This includes any part shipment costs due to delays from textile suppliers. Additional costs for partial order shipments will normally not be assessed if there is a delay caused by Krug.

## Damaged Shipments

All Krug product is well engineered, carefully inspected, and expertly loaded onto our trucks at our Distribution Center. If you receive any damaged freight, we ask that you do not refuse the shipment. Krug is not responsible for damage to goods that occurs in transit or storage. It is the purchaser and/or receiver's responsibility to examine the goods upon receipt and to notify Krug of any damages, overages or shortages. Any discrepancies should be noted on the Bill of Lading. The delivering carrier will not accept responsibility for shortages or damages if signed "clear". Notification of concealed damage claims must be made to Krug Distribution within 5 days of delivery, along with digital pictures if available. All product and

packaging must be available for inspection. Krug liability ceases after 5 business days and Krug will not be responsible for concealed damages if shipments are left unopened. Krug is not responsible for the condition of product that is stored or installed in an environment where temperature and humidity are not controlled.

## Field Product Report Authorization

Krug's written authorization, in the form of an FPR number, must be obtained prior to incurring charges of any kind if Krug is expected to pay these charges. This includes authorization for returns, field repairs and replacements, post field repairs, installation and delivery charges. Krug reserves the right to have its representative inspect product related to any request for such authorizations, prior to that authorization being provided. Deductions from invoices paid for any charges to Krug, without prior written authorization in the form of an FPR, will not be accepted. Digital photographs may be required to complete the FPR process.

## Care and Maintenance

**Wood Finishes** - Although Krug's extensive finishing process ensures a durable finish on all our products, there are several steps that can be taken to protect and prolong the life and beauty of the finish. Protect the top by placing felt pads on the bottom of any accessories and mechanical equipment. Rubber and oil will permanently mark surfaces. Use a desk pad to prevent possible damage and imprinting caused by writing instruments and sharp objects. Dust only with a clean, dry cloth, going with the grain. Clean any marks with a damp cloth, using a small quantity of mild soap or detergent. Do not use any wax-based polish, spray or silicone. Eventually, a film will build up and discolor the top. Do not place your furniture in a position of permanent exposure to direct sunlight.

**Plastic Laminates** - Clean plastic laminates with mild soap and warm water. Do not use steel wool, hot water, or any abrasive cleaning product.

## Custom Capabilities

Over 15% of our orders involve some type of custom work, and we invite our customers to make use of our extensive capabilities. These include:

- 1) Dimensional customization of standard size products
  - 2) Custom wood finishes
  - 3) For larger orders, completely custom-designed products, as well as non-standard wood species can be specified.
- Custom orders may require additional production lead times. Contact Customer Service for more information.

## Krug Panel Fabric Program

Tackboards can be upholstered in COM material supplied by the customer, and in a selection of stocked tackboard fabrics supplied by Momentum. The Momentum Panel fabrics are available on Krug Express. They are 100% polyester. For additional information and color selections, please refer to our Panel Fabrics card and Krug's website. [www.krug.ca](http://www.krug.ca) The Momentum panel fabrics pass ASTM-E84-87 Fire Codes. If memo samples are required please call Momentum at 1-800-366-6839.

## Program Details

*KrugExpress* orders are ready to ship by the date acknowledged. Delivery and shipping schedules may result in actual shipping of orders at a later date. Statutory holidays and scheduled factory vacations may add to acknowledged lead times of *KrugExpress* orders. Unless otherwise specified on the order, the customer's standard method of shipping Krug products will be utilized. Available factory capacity for *KrugExpress* is filled by orders received on a "first come, first serve" basis. If the normal *KrugExpress* lead time is not available for your order because available capacity has been filled, you will be immediately advised of the earliest available ready-to-ship date. Please consult your Customer Service representative in advance if you wish to confirm the specific lead time availability for a *KrugExpress* order. Orders must be received by midnight of a given day for that day to be considered the official day the order is received. Order lead times are acknowledged from the date the order is received, but not including the date the order is received. *KrugExpress* orders must be "clean" when received in order to be considered officially received on a given day, and lead times will be acknowledged from the date orders are determined to be "clean". Changes to *KrugExpress* orders are not allowed under any circumstances. Orders for product on *KrugExpress* must clearly state: "*KrugExpress*".



**Krug Textiles - Leather Program**

**Grade 8**

Black	K13.1000	Graphite	K13.4000
Stone	K13.3000	Espresso	K13.8000
Sand	K13.5000	White	K13.9000

Please contact Customer Service for specific information on leathers, available colors and lead times.

**Krug Textiles - Faux Leather Program**

**Grade 2**

White	Taupe	Bisque	Wine	Sprig	Lagoon
Cream	Mocha	Chocolate	Garnet	Chinchilla	Pacific Blue
Parchment	Tan	Black	Rust	Steel	Navy
Sandstone	Chestnut	Earth	Citron	Grey	Plum
Vanilla		Brick			

**GRADED-IN UPHOLSTERY PROGRAMS**

Krug has partnered with several textile brands to grade in their offerings, designed to provide a wide range of upholstery selections for our seating products.

Upholstery pricing and availability is subject to change without notice. We grade this upholstery according to the pricing of the fabric suppliers - when their pricing changes, the Krug grade may change. When placing an order, a Krug customer must specify the complete upholstery number, along with the appropriate Krug model number and finish. Krug will supply the complete product at the prices listed. Orders specifying graded-in upholstery cannot be cancelled once the upholstery has been ordered.

**Upholstery Grades**

To determine the price of a product for graded-in upholstery, use the reference lists located on Krug’s website under - Products - Textiles, to view the upholstery grade (1-9). Krug is not responsible for the discontinuation of this upholstery. Please contact Customer Service for information on upholstery not listed.

When two upholstery selections are specified for use on seating, the higher grade upholstery price will apply to the order.

High Performance upholstery; Polyurethane, Vinyl or Crypton, is particularly suitable for healthcare and other intensive-use environments.

**Upholstery Samples**

If you require additional samples or memos for presentation, please contact fabric supplier directly.

**Flammability Standards**

- Tunnel Test Surface Ratings Class A rating
- Class 1 UFAC
- Passes State of California Technical Bulletin CAL 117-2013

Please contact fabric supplier directly for further flammability information pertaining to specific upholstery.

**Special Conditions**

Acknowledgements will give the estimated delivery date of the finished product. Some upholstery is imported, and availability may affect estimated delivery time. For large projects, please contact fabric supplier directly for availability of yardage.

**TACKBOARD FABRICS**

**KRUG PANEL FABRIC PROGRAM**

Tackboards can be upholstered in COM material supplied by the customer, and in a selection of stocked tackboard fabrics supplied by Momentum. The in-stock Momentum fabrics are priced at Grade 1 and are available on Krug Express. They are 100% polyester. For additional information and color selections, please refer to our Panel Fabrics card and Krug’s website. www.krug.ca If memo samples are required please call Momentum at 1-800-366-6839. The Momentum panel fabrics pass ASTM-E84-87 Fire Codes.

**PROGRAM DETAILS**

KrugExpress orders are ready to ship by the date acknowledged. Delivery and shipping schedules may result in actual shipping of orders at a later date. Statutory holidays and scheduled factory vacations may add to acknowledged lead times of KrugExpress orders. Unless otherwise specified on the order, the customer’s standard method of shipping Krug products will be utilized. Available factory capacity for KrugExpress is filled by orders received on a “first come, first serve” basis. If the normal KrugExpress lead time is not available for your order because available capacity has been filled, you will be immediately advised of the earliest available ready-to-ship date. Please consult your Customer Service representative in advance if you wish to confirm the specific lead time availability for a KrugExpress order. Orders must be received by midnight of a given day for that day to be considered the official day the order is received. Order lead times are acknowledged from the date the order is received, but not including the date the order is received. KrugExpress orders must be “clean” when received in order to be considered officially received on a given day, and lead times will be acknowledged from the date orders are determined to be “clean”. Changes to KrugExpress orders are not allowed under any

**KRUGEXPRESS**

circumstances. Orders for product on KrugExpress must clearly state: “KrugExpress”. \*Some conditions apply. Please note PALETTE finishes are not available on KrugExpress.

**CASEGOODS PROGRAM**

Orders for casegood products on the KrugExpress program may be subject to quantity maximums. Please contact Krug Customer Service for more information. Quantity maximums are dependent upon available capacity, in order to insure that we ship all orders on time. Only actual casegood pieces and conference tables tops and bases are considered “units”. Items such as tasklights, tackboards, keyboard trays and drawers, electrical and wire management components, etc., are not considered under the quantity restrictions. For example, a typical office configuration that includes a desk, linking unit, credenza and hutch/overhead, equals a total of four units for the purposes of the quantity maximum. Only Krug In-stock panel fabric is available on the KrugExpress program. Only standard wood finishes are available for KrugExpress orders. Grommets can be specified in standard positions only. KrugExpress also includes all Krug seating and occasional tables as well as Krug conference products to complement this casegoods offering.

# CUSTOMER'S OWN MATERIAL - C.O.M.

## Customer's Own Material (COM)

**COM must be received three weeks prior to the acknowledged ship date. Orders with COM not received by the required deadline will be delayed.**

A description of the fabric, including supplier name, fabric name and color number must be included with the purchase order. When the COM fabric is received at Krug, it must be clearly identified with the fabric name and color, and tagged with name of the Krug customer and purchase order number. Krug will inspect all COM fabric when received to determine if it will be suitable for upholstery. Where Krug feels that the fabric or leather specified will compromise the quality or integrity of our products, customers will be contacted to direct these concerns. Further, Krug reserves the right to refuse to accept and use any COM fabrics or leathers that will compromise our products in any way that is unacceptable to Krug. Krug cannot assume responsibility for the durability or tailoring quality of customer's own material.

Yardage specified in this price guide is approximate. In the case of multiple product orders, multiply the number of items by the COM yardage specified to determine fabric required, unless otherwise indicated. Additional yardage may be needed if the material is less than 54" wide, or patterned or striped and requires matching. As fabric is applied horizontally, non-directional fabrics are recommended. COM fabrics are applied as they come off the roll unless otherwise specified. All striped fabrics will be applied vertically unless otherwise stated by the customer and after approval by Krug. It is the customer's responsibility to advise Krug if the upholstery is to be applied otherwise, and to advise Krug of any special upholstery instructions. Special instructions should be sent to Krug Customer Service, including a sample (or photocopy) of the fabric. Krug is not responsible for instructions sent with the fabric rolls, or for the method of upholstery if no instructions have been provided. COM fabrics for tackboards may be specified in either Maharam or Momentum panel fabrics. Krug is not responsible for determining if a fabric is not ideal for tackboard application.

Please contact Maharam at 1-800-645-3943 or Momentum at

## COM Shipping Procedures

**For tackboard COM fabrics, please send fabrics to:**

**Krug Inc.**

**111 Ahrens Street**

**Kitchener, Ontario**

**Canada N2H 4C2**

**Attention: RECEIVER**

All packages must be clearly marked "For Customs Clearance by Willson International Custom Brokers". According to the North American Free Trade Agreement (NAFTA), goods shipped between the United States and Canada can qualify for exemption from all duties, or for a reduction in duties, if the goods can be proven to originate in either the United States, Canada or Mexico.

Canada Customs requires that a NAFTA Certificate of Origin and Commercial Invoice be completed and sent with the fabric shipment. The Commercial Invoice must clearly state the description of the fabric, the selling price, the make-up or content, and the purchaser. The absence of these two documents will delay the shipments at the U.S./Canada border, thereby potentially delaying the customer order. If the total value of the shipment is less than \$1200 U.S., Customs will accept a Low Value Statement of Origin in place of the NAFTA Certificate of Origin. The Low Value Statement must be signed by a representative of the exporting company. This statement may either be included on the commercial invoice or attached to the invoice.

Krug is happy to answer any questions or concerns about COM shipping procedures and the required documents. Please contact our Customs Specialist at 1.888.578.5784.

# LAMINATES

## LAMINATES

Krug's in-stock Laminates are available in 17 different laminate selections. Please note that 4 of the colors (Gingerbread, Portobello, Ash and Willow) have textured finishes and may not be appropriate for use in patient areas due to infection control concerns. Minimum order quantities and extended lead times may apply for exotic laminate colors, please check with customer service. Polymer Edge will be selected to match the worksurface. Krug's previous laminate in-stock program will be phased out as in-stock supply depletes. Please contact customer service for availability.

## IN-STOCK LAMINATES

Wood Grain Laminates	High Pressure Laminate Supplier	Textured Wood Grain Laminates	High Pressure Laminate Supplier
Champagne	Tafisa T492CR	Gingerbread	Tafisa T556UR
Hardrock Maple	Formica 86992-58	Portobello	Tafisa T557UR
Dune	Tafisa T491CR	Ash	Tafisa T535AT
Copper	Tafisa T521CR	Willow	Tafisa T543AT
Shiraz Cherry	Tafisa T472CR		
Park Avenue Walnut	Wilsonart 7984-38	<b>Solid Laminates</b>	
Chocolate	Tafisa T498CR	Designer White	Wilsonart D354-60
Nutmeg	Tafisa T477CR	Platinum	Tafisa T202CR
Dark Walnut	Tafisa T469CR	Earth	Tafisa T767CR
		Charcoal	Tafisa T228CR

## PHASE OUT LAMINATES

Almond - Black- Shadows - Edgewood Sycamore - Gunstock Walnut  
Non-Stocked Laminates

For specific lead time and application questions, please contact Krug Customer Service for your requirement. Upcharges will be applicable for non-stocked laminates, depending on their cost. Non-stock laminates may require a minimum order quantity, please contact customer service. Stocked polymer edges only can be specified for use with non-stocked laminates or tops will be self-edged.



The mark of responsible forestry

All products are air emissions certified and are available as FSC® certified

# krug