

STRATFORD
Price and Specification Guide
USA



Effective, January 1, 2025

krug

Advancing Design Through Innovation

STRATFORD | TABLE OF CONTENTS

| | |
|-----|---------------------------------------------|
| 578 | Environmental Summary |
| 579 | General Product Specification |
| 580 | Finishes |
| 580 | Edge Detail Profile |
| 581 | Profiles & Overhang |
| 584 | Drawer Pulls & Lock |
| 585 | Grommets |
| 586 | Laminate Worksurfaces |
| 587 | Non-Standard Product Guidelines for Pricing |
| 588 | Desk Specification |
| 588 | Credenza Specification |
| 589 | Overhead & Hutch Specification |
| 590 | Installation |
| 591 | Sample Configuration |
| 592 | Desks |
| 596 | Returns |
| 598 | Linking Units |
| 598 | Corner Units |
| 599 | Credenzas |
| 603 | Overheads |
| 604 | Hutches |
| 607 | Keyboard Tray & Cable Management |
| 608 | Modular Components |
| 618 | Bookcases |
| 619 | Storage |
| 623 | Reception |

STRATFORD CASEGOODS | ENVIRONMENTAL SUMMARY

LEED CERTIFICATION



MATERIAL CONTENT:

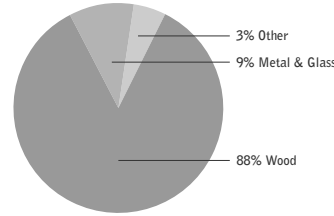

PRE-CONSUMER RECYCLED CONTENT - 77%

POST-CONSUMER RECYCLED CONTENT - 2.5%

| | | CONTRIBUTES TO |
|------------------|-------------------------------------------------------------------------------------|----------------|
| Credit 2.1 - 2.2 | Construction Waste Management | 1- |
| Credit 3.3 | Resource Reuse | 1 point |
| Credit 4.1 | Recycled Content | 1 point |
| Credit 4.2 | Recycled Content | 1 point |
| Credit 4.5 | Low Emitting Materials, (MUST BE REQUESTED) Composite Wood & Laminate Adhesives | 1 point |
| Credit 5.1 | Regional Materials* | 1 point |
| Credit 6 | Rapidly Renewable Materials (MUST BE REQUESTED) | 1 point |
| Credit 7 | Certified Wood (MUST BE REQUESTED) | 1 point |

*This credit is only applicable if in total 20% of the combined value of the procurement of construction materials and in the furniture are manufactured within a radius of 500 miles. This credit will apply if the installation of the finished product occurs within 500 miles of Kitchener, Ontario.

level® CERTIFICATION



BIFMA's e3 Furniture Sustainability Standard is a voluntary, multi-attribute standard that measures the degree of sustainability of furniture. This standard evaluates product and company environmental attributes and compliance systems in a wide range of elements which include Materials, Energy & Atmosphere, Human & Ecosystem Health and Social Responsibility. Stratford products have earned level®, BIFMA's sustainability certification program for furniture, certification through third-party verification against the e3 standard. All Stratford products can be supplied with level® certification. In order to accomplish this, the product must also be ordered with the air-emissions-certification option. Contact customer service for information and upcharges.

AIR-EMISSIONS

All Stratford products can be supplied with air-emissions-certified materials. Contact customer service for information and upcharges.



FSC®
www.fsc.org
FSC® C021699

the mark of responsible forest

FSC®

FSC® In 2005, Krug received Forest Stewardship Council® (FSC®) Chain-of-Custody certification for our manufacturing facilities. The FSC® Chain-of-Custody tracks certified wood from seedling to final sale. It verifies that the material for our FSC® certified products only come from well-managed, FSC®-certified forests and other controlled sources. FSC® is dedicated to the promotion of responsible forest management worldwide helping to take care of forests for future generations. Stratford and other Krug products can be specified with FSC® Certification. Contact customer service for further information, pricing and lead times.

In addition, architects, designers, and building professionals can specify FSC®-certified products in order to achieve a point from the US. Green Building Council's Leadership in Energy and Environmental Design (LEED) Rating System.



STRATFORD | GENERAL PRODUCT SPECIFICATIONS

WORKSURFACES

Tops are made of 1 1/4" - 42 lbs. per cubic foot density particle board core with face and back veneers. All edges have 1 1/8" wide 1" thick solid Cherry or Walnut headers.

DRAWER FRONTS AND DOORS

48 lbs. per cubic foot density Medium Density Fiberboard with face and back veneer.

GABLES

Gables are 3/4" or 1 1/8" thick - 45 lbs. per cubic foot density particleboard core, 3 ply. Edges are banded with veneer. Bottom edges of 1 1/8" gables are banded with polyvinyl chloride edge banding.

VENEER

External face veneers are flat sliced Black Walnut or Cherry bookmatched and of uniform color and grain pattern.

SOLIDS

All solids used shall be American Black Walnut or Cherry kiln-dried by the manufacturer to a 6% moisture content

FINISH

All surfaces to be finished are well sanded before applying finish materials. The procedure begins with the application of a base color via a Non-Grain Raising stain. Next a wash coat is applied to seal the NGR stain and ensure an even colored finish. The a filler coat is applied and hand wiped to fill the open pores in the wood surface and further enhance the depth color. A sealer is applied and scuff sanded to prepare the surfaces for the top coat (finish). The final procedure is to apply a coat of 52° sheen catalyzed varnish to protect the surfaces and add luster.

LOCKS

Locks are standard on all pedestals and storage unit lateral file drawers.
Locks are optional on door fronts and must be specified at time of order.
Locks are not available on glass doors.

DRAWERS

Box drawers have ball bearing movement, full extension slides with urethane cushioned stops and hold-in catch. Box drawers have a load bearing capacity of 100 lbs. per drawer. File drawers have progressive action ball bearing full-extension slides with urethane cushioned stops and hold-in catch. File drawers have a load bearing capacity of 100 lbs. per drawer. Lateral file drawers have full-extension slides with over-travel ball movement slides with urethane cushioned stops. Lateral file drawers have a load bearing capacity of 150 lbs. per drawer. All drawer slides allow for easy removal of the drawers. All drawer interiors are birch veneer. All file drawers are equipped for letter and legal filing. All desks with the center drawer option include a matching pencil tray in the center drawer. All standard desks with 2 box 1 file pedestals are specified without a center drawer option include one matching pencil tray.

BASE MOLDING

The base moldings are made of profiled solid Black Walnut or Cherry.

GLIDES

Glides are provided for every case and allow for 1 1/2" of adjustment.

HINGES

Doors have European style hinges with a 95° opening.

PULLS

Three pull options are available, please specify at time of order.

TESTING INFORMATION

Stratford desks, credenzas, hutches, link units, and returns meet or exceed the testing requirements of ANSI/BIFMA X5.5-2014 and/or X5.9 - 2012.



WOOD FINISHES

Standard wood finishes are:

| SPECIES | FINISH |
|----------------|--------------------|
| Cherry | Light Cherry |
| | Natural Cherry |
| | American Cherry |
| | Medium Cherry |
| | Standard Cherry |
| | Imperial Cherry |
| | Appalachian Cherry |
| Sable Cherry | |
| Walnut | Natural Walnut |
| | Regular Walnut |
| | Mahogany on Walnut |
| | Dark Walnut |
| | Cordovan Walnut |

NATURAL CHARACTERISTICS OF WOOD

Wood is a natural product with inherent color variations that will never be fully mitigated by the finishing process. Please anticipate variation in colors within a single unit, from piece to piece, and from Krug wood finish samples. If a very close match is required, a sample must be provided with the order and an upcharge will apply. Exact color matches are not possible.

CUSTOM WOOD FINISHES

Add 10% list to your order for special finishes, minimum upcharge is \$600 list per finish per order. (For example, on all orders up to \$6000 list, an upcharge of \$600 will apply, on orders \$6000 and up add 10% list to your order.)

For orders with special finishes, a sample that is a minimum 3” by 3” must be received with the order. Special finishes may add additional lead time to production schedules.

Since wood is a natural product, some variations in grain, color, and stain acceptance will occur. In our finishing processes, we try to minimize variations, but some variation between samples and finished goods should be anticipated.

DUAL FINISH

Add 10% net per item if specifying dual finish.

WOOD FINISHES TO MATCH STANDARD LAMINATES

- Copper on Cherry
- Shiraz Cherry
- Park Avenue Walnut
- Chocolate on Walnut
- Nutmeg on Walnut
- Dark Walnut

STRATFORD | EDGE PROFILES



PROFILE - STANDARD

The standard edge detail is included on the following Stratford products:

- desks
- linking units
- credenzas
- returns
- corner units
- 30” high and 57” high bookcases
- modular TP and TPR tops
- 30” high freestanding storage
- occasional tables
- conference tables



PROFILE - INVERTED

The inverted edge detail is included on the following Stratford products:

- hutches
- wall mounted overheads
- 71” high bookcase
- modular TPI tops
- 71” high and 84” high freestanding storage
- visual boards

STRATFORD | PROFILES & OVERHANGS

Please use the following summary of products to determine the profile direction and overhang dimensions for all Stratford products.

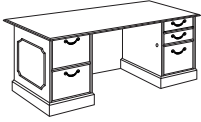

DESKS 30" DEEP

Profile Location: profile on all four sides
 Profile Direction: standard
 Overhang: left 1 1/2"
 right 1 1/2"
 user 3/4"
 guest 1 1/2"
 Picture Frame: on end panels, modesty panel and pedestal backs

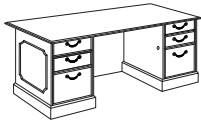
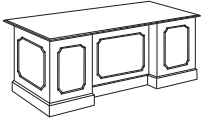

DESKS 36" DEEP

Profile Location: profile on all four sides
 Profile Direction: standard
 Overhang: left 1 1/2"
 right 1 1/2"
 user 3/4"
 guest 7 1/2"
 Picture Frame: on end panels, modesty panel and pedestal backs

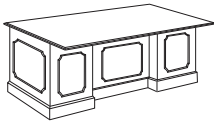
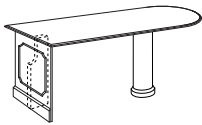

TABLE DESKS

Profile Location: profile on all four sides
 Profile Direction: standard
 Overhang: left 1 1/2"
 right 1 1/2"
 user 3/4"
 guest 1 1/2"
 Picture Frame: none



BULLET AND P DESKS

Profile Location: profile on all sides
 Profile Direction: standard
 Overhang: end panel 1 1/2"
 Picture Frame: on end panel

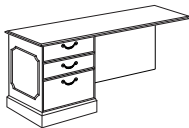

RETURNS

Profile Location: profile on all four sides, coved
 Profile Direction: standard
 Overhang: end panel 1 1/2"
 user 3/4"
 guest 1 1/2"
 Picture Frame: on end panel, modesty panel and pedestal back

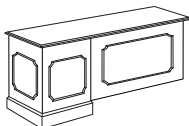

STRATFORD | PROFILES & OVERHANGS

Please use the following summary of products to determine the profile direction and overhang dimensions for all Stratford products.

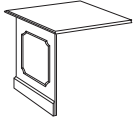

LINK UNITS AND LINK TOPS

Profile Location: profile on guest and user sides, cover on connecting ends
Profile Direction: standard
Overhang: guest 1 1/2"
Picture Frame: on modesty panel

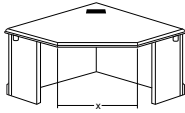

CORNER UNITS

Profile Location: profile on outside and user sides, covered on connecting ends
Profile Direction: standard
Overhang: guest 1 1/2"
Picture Frame: on both outside panels

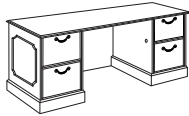

CREDENZAS

Profile Location: profile on left, right and user side, flush on back edge
Profile Direction: standard
Overhang: left 1 1/2"
right 1 1/2"
user 3/4"
back 1/8"
Picture Frame: on left and right panels



OVERHEADS

Profile Location: inverted profile left, right, and user side, flush on back edge
Profile Direction: inverted
Overhang: left 1"
right 1"
user 3/4"
back flush
Picture Frame: none

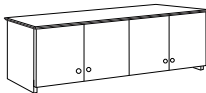

Please specify if flush sides are necessary for the purpose of ganging overheads at time of order. Upcharge for this option is **\$228 list**.

STRATFORD | PROFILES & OVERHANGS

Please use the following summary of products to determine the profile direction and overhang dimensions for all Stratford products.

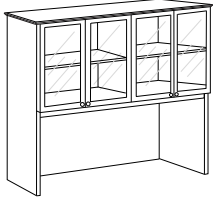

HUTCHES

Profile Location: inverted profile on left, right, and user side, flush on back edge
 Profile Direction: inverted
 Overhang: left 1"
 right 1"
 user 3/4"
 back flush
 Picture Frame: none

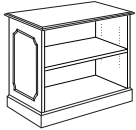

BOOKCASES AND FREESTANDING STORAGE (30" HIGH ONLY)

Profile Location: profile on left, right, and user side, flush on back edge
 Profile Direction: standard
 Overhang: left 1 1/2"
 right 1 1/2"
 user 3/4" (if unit has doors or drawers)
 1 1/2" (if unit is open)
 back flush
 Picture Frame: on left and right panels

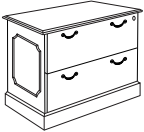

Bookcases have non-shown wood backs, finished color.
 Freestanding and modular storage have non-shown wood veneer, finished and top coated backs.

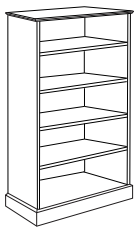

BOOKCASES AND FREESTANDING STORAGE (57", 71" AND 84" HIGH)

Profile Location: profile on left, right, and user side, flush on back edge
 Profile Direction: inverted
 Overhang: left 1"
 right 1"
 user 3/4" (if unit has doors or drawers)
 1 1/2" (if unit is open)
 back flush
 Picture Frame: none

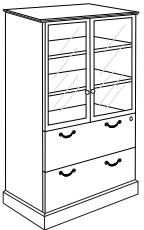

Bookcases have non-shown wood backs, finished color.
 Freestanding and modular storage have non-shown wood veneer, finished and top coated backs.

STRATFORD | DRAWER PULLS & LOCKS

Stratford traditional series offers a choice of three pull combinations as described below.

Please indicate a pull designation for every Stratford product on your order. There is no default selection and orders will not be processed until a pull selection is received.

DEVON

Drawers are furnished with an arced Devon bail finished in antiqued brass and mounted with rosettes. Bookcase doors and hutch doors are provided with an antiqued brushed brass knob.



CANTERBURY

Drawers are furnished with a Canterbury bail finished in antiqued brass and mounted with rosettes. Bookcase doors and hutch doors are provided with an antiqued brushed brass knob.



AVON

All drawers, bookcase doors and hutch doors are provided with an antiqued brushed brass knob.



LOCKS

Locks are provided as a standard features on all pedestal drawers, including those in desks, credenzas and freestanding or modular storage units. All lock plugs have an antiqued brass finish.

Optional locks are available on bookcase, hutch and overhead doors at an upcharge of **\$152 list per set** of (2) doors. Please specify at time of order. If a hutch or overhead has an uneven amount of doors the single lock required is also **\$152**.

LOCK LOCATIONS

Desk Pedestals: Lock plugs are located in the kneespace of all desks, with the exception of desks with the center drawer option where the central locking system lock plug is located on the center of the drawer front.

Hutches and Overheads: Lock plugs are located on the lower inside corner of the doors.

Bookcase Doors: Lock plugs are located on the top inside corner of the door.

Suites can be keyed alike at no upcharge, please specify on your purchase order.

STRATFORD | GROMMETS

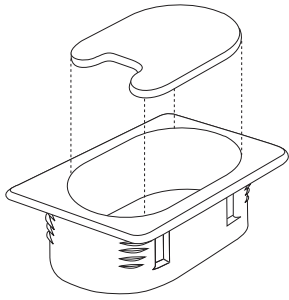

GROMMETS

All products may be specified with either one black grommet or one brass grommet in a standard position at no upcharge. A **\$152 list upcharge** will apply to additional grommets in standard positions and for grommets in non-standard positions a **\$152 list upcharge** will apply.

The grommet position must be indicated for each case on the purchase order.

Standard Grommet
Black, rectangular, 4 1/8" x 2 11/16"

Antiqued Brass Grommet
2 5/8" x 1 1/2"

Grommets can also be field installed with power drill, 2 1/4 hole saw and rasp or saber saw. Template for drilling is available.

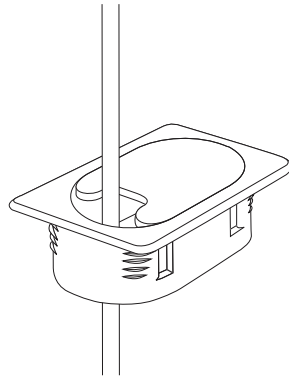

STANDARD GROMMET POSITIONS

Desks

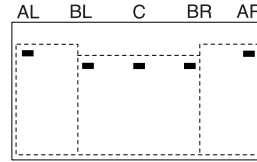
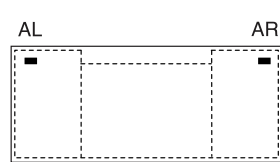

30" and 36" Deep Desks:

Position Code:
AL - left corner
BL - left end beside pedestal gable
C - center
BR - right end beside pedestal gable
AR - right corner

42" Deep Desks:

Position Code:
AL - left corner
BL - left end beside pedestal gable
C - center
BR - right end beside pedestal gable
AR - right corner

Curvilinear Tops

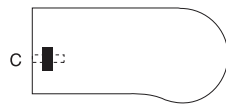

Position Code:
C - center

This key applies to all bullet and P shaped tops. The support panel is notched out to accommodate cable management and also allows the installation of a pop-up power grommet.

Linking Units, Credenzas & Returns

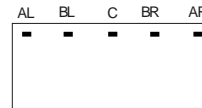

Grommets cannot be located over pedestals on 20" or 24" units

NOTE: 'BL' and 'BR' are only available on 42" or longer.

STRATFORD | GROMMETS & LAMINATE WORKSURFACES

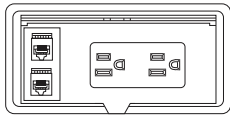

mounted in a hutch back panel

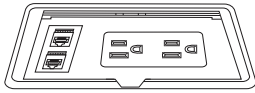

used as a surface grommet

POWER / DATA / VOICE GROMMET

This unit is supplied in the wired hutches or can be ordered a surface mount power/data/voice option as a 98PDVM.

Black, rectangular with recessed cover.
Includes two power outlets, one voice port, and one data port.

POWER DETAILS:
two Simplex outlets
15 Amp, 10 ft. cord

COMMUNICATION DETAILS:
one RJ11 phone line coupler
one RJ45 data coupler

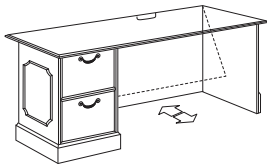

WIRE MANAGEMENT CUT-OUT AND HINGED MODESTY PANELS

Returns, link units and credenzas with fixed modesty panels can be specified with an 8" x 1 1/2" wire management cut-out. All hinged modesty panels feature a cut-out as a standard.

The discreet cut-out allows for clean and easy access to power, data and communication sources.

STRATFORD | LAMINATE WORKSURFACES

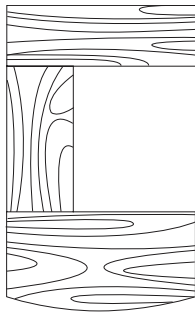

LAMINATE WORKSURFACES

Laminate worksurfaces are available at an upcharge of 10% (a higher upcharge may apply to specially priced plastic laminates).

Where there are wood profile edges on worksurface tops, they will remain as wood profiles on laminate tops.

Where there are flush edges, as in the backs of link units, there will be laminate self edges. Please reference the illustration.

Krug will order and procure laminates. Purchase orders with a plastic laminate option must include laminate name.

When specifying laminate worksurfaces, the grain direction is such that the grain pattern runs the length of each surface, as shown in the diagram on the left.

Please contact Krug Customer Service for questions pertaining to laminate grain direction.

STRATFORD | NON-STANDARD PRODUCT GUIDELINES FOR PRICING

PRICING METHOD

Custom widths: Apply the price of the same unit in the price list that is one standard size larger than the desired case size (but same depth).
For example: The required custom dimension is 74" x 24". The first standard size above this is 78" x 24", so in this case, you would apply the price of the 78" x 24" unit.

Custom depths: Apply the price for the same unit one size deeper (but same width).
For example: The required custom dimension is 72" x 26". The first standard size above this is 72" x 30", so in this case, you would apply the price of the 72" x 30" unit.

Custom width & depths: Apply the price for the same unit both one size wider and one size deeper.
For example: The required custom dimension is 74" x 26". The first standard size above this is 84" x 30", so in this case, you would apply the price of the 84" x 30" unit.

Custom height of desk height cases: Add 18%. (31-32" HI)

OTHER PRICING METHODS

| | |
|---------------------------------------------------------------------------------------------------|------------|
| cases where tops are flush left/right or both, add: | \$120 list |
| Grommets in non-standard positions, add: | \$152 list |
| To remove hutch or overhead doors, deduct: | 4% list |
| convert 5-hi hutch to 6-hi hutch, add: | 20% list |
| Bookcases with optional pull out printer shelf at standard shelf height, add: | \$238 list |
| Bookcases with optional vent in back (includes 2 vents and 1 grommet), add: | \$320 list |
| storage units flush, add: | \$199 list |
| 2 lateral file and 3 or 4 closed shelves - convert to half open, half closed shelves, add: | 15% list |
| 2 lateral file and 3 or 4 closed shelves - convert to half open, half wardrobe, add: | 15% list |
| To remove storage doors for open shelves, deduct: | 4% list |

EXCEPTIONS TO THE PRICING METHODS ABOVE

- Sizes larger than the largest shown Price List.
- Non-standard extension on drawer slides.
- Non-standard drawer depths in standard depth pedestals.
- Glass door - any style.
- Glass - face mounted modesty panels.
- Perforated modesty panels.
- Cases with curvilinear tops where the radius becomes non-standard.
- A/V cabinets.
- Any case with flipper doors.

Please contact Specials Coordinator or Krug Customer Service at 1.888.578.KRUG if you require assistance.

PLEASE NOTE: Cases with non-standard features do not apply to the rules above.
Contact Krug Customer Service if you require assistance.

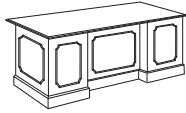

Breakfront Modesty Panel

All single pedestal and double pedestal desks have a breakfront modesty panel on the guest side of the desk. The dimension of recess is 4 1/2”.

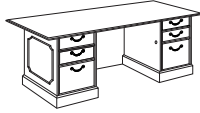

Oversized Top Option

The oversized top option increases the overhang on the left and right sides of desks to 4 1/2” on each end, the guest and user side overhang remain unchanged.



Center Drawer Option

Desks specified with the optional locking center drawer include the following features:

- center drawer lined with burgundy felt and a pencil tray.
- a pull out dictation slide in each pedestal
- a central locking system activated by a single lock located on the center drawer front

Recent modifications:

- dictation slides are flush with drawer fronts and feature molding detail
- center drawer extends to underside of top with the lock on the drawer front

Chassis Dimensions

Please use the reference chart below to determine chassis dimensions, top dimensions, and overhang dimensions for all desk sizes:

| Desk | Chassis dimension | Left overhang | Right overhang | Guest overhang | User overhang |
|---------------------------|-------------------|---------------|----------------|----------------|---------------|
| 60” x 30” | 57” x 27” | 1 1/2” | 1 1/2” | 1 1/2” | 3/4” |
| 66” x 30” | 63” x 27” | 1 1/2” | 1 1/2” | 1 1/2” | 3/4” |
| 66” x 36” | 63” x 27” | 1 1/2” | 1 1/2” | 7 1/2” | 3/4” |
| 72” x 36” (oversized top) | 63” x 27” | 4 1/2” | 4 1/2” | 7 1/2” | 3/4” |
| 72” x 36” | 69” x 27” | 1 1/2” | 1 1/2” | 7 1/2” | 3/4” |
| 78” x 36” (oversized top) | 69” x 27” | 4 1/2” | 4 1/2” | 7 1/2” | 3/4” |
| 78” x 42” | 75” x 33” | 1 1/2” | 1 1/2” | 7 1/2” | 3/4” |
| 84” x 42” (oversized top) | 75” x 33” | 4 1/2” | 4 1/2” | 7 1/2” | 3/4” |
| 84” x 42” | 81” x 33” | 1 1/2” | 1 1/2” | 7 1/2” | 3/4” |

Dimensions have been rounded to the nearest 1/4”, please contact Customer Service for exact measurements.

STRATFORD | CREDENZAS

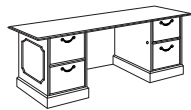

Oversized Top Option

The oversized top option increases the overhang on the left and right sides of credenzas to 4 1/2” on each side, the guest and user side overhang remain unchanged. When using a hutch and credenza combination, we do not recommend specifying a hutch greater in size than the standard chassis size of the credenza. The left/right extensions on the oversized top should not be used for the support of a hutch.

Chassis Dimensions

Please use the reference chart below to determine chassis dimensions, top dimensions, and overhang dimensions for all desk sizes:

| | Credenza dimension | Chassis overhang | Left overhang | Right overhang | Guest User overhang |
|---------------------------|--------------------|------------------|---------------|----------------|---------------------|
| 66” x 20” | 63” x 18 1/4” | 1 1/2” | 1 1/2” | 3/4” | 1/8” |
| 72” x 20” (oversized top) | 63” x 18 1/4” | 4 1/2” | 4 1/2” | 3/4” | 1/8” |
| 66” x 24” | 63” x 22 1/4” | 1 1/2” | 1 1/2” | 3/4” | 1/8” |
| 72” x 24” (oversized top) | 63” x 22 1/4” | 4 1/2” | 4 1/2” | 3/4” | 1/8” |
| 72” x 20” | 69” x 18 1/4” | 1 1/2” | 1 1/2” | 3/4” | 1/8” |
| 78” x 20” (oversized top) | 69” x 18 1/4” | 4 1/2” | 4 1/2” | 3/4” | 1/8” |
| 72” x 24” | 69” x 22 1/4” | 1 1/2” | 1 1/2” | 3/4” | 1/8” |
| 78” x 24” (oversized top) | 69” x 22 1/4” | 4 1/2” | 4 1/2” | 3/4” | 1/8” |
| 78” x 20” | 75” x 18 1/4” | 1 1/2” | 1 1/2” | 3/4” | 1/8” |
| 84” x 20” (oversized top) | 75” x 18 1/4” | 4 1/2” | 4 1/2” | 3/4” | 1/8” |
| 78” x 24” | 75” x 22 1/4” | 1 1/2” | 1 1/2” | 3/4” | 1/8” |
| 84” x 24” (oversized top) | 75” x 22 1/4” | 4 1/2” | 4 1/2” | 3/4” | 1/8” |
| 84” x 20” | 81” x 18 1/4” | 1 1/2” | 1 1/2” | 3/4” | 1/8” |
| 84” x 24” | 81” x 18 1/4” | 1 1/2” | 1 1/2” | 3/4” | 1/8” |

Dimensions have been rounded to the nearest 1/4”, please contact Customer Service for exact measurements.

STRATFORD | OVERHEADS & HUTCHES

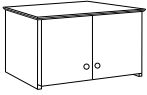

OVERHEADS

Overheads include tasklights that are factory installed and require no field adjustment. Tasklights are mounted beneath the cabinet and hidden from view. Cords run down the right hand side of the tasklight to the worksurface where they can be routed behind the worksurface top. The use of a wall mounted tackboard conceals the cord from view.

Tackboards must be ordered separately and can be specified in any fabric grade (1-9). Wall mounted tackboards for overheads are supplied with all necessary hardware for installation.

Locks are optional on overheads and can be specified at time of order for an upcharge of **\$152 list per set** of (2) doors.

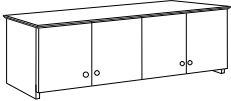

HUTCHES

Hutches include tasklights that are factory installed and require no field adjustment. Tasklights are mounted beneath the cabinet and hidden from view.

A tackboard in grade 1 fabric is included with most hutches, see the hutch product section for specific products. Upcharges for higher graded fabrics are listed on page 603. Tackboard fabric selections should be supplied with the order information, fabric options are listed on page 4 of this price guide.

Tackboards for hutches are installed at the factory and require no additional set up on site.

POWER/DATA/VOICE GROMMET

Access to power and data is made simple by using a hutch with a power/data/voice module built right into the tackboard. The module is fully installed at the factory but can be removed to connect data links on site. It features a flip door that retracts into the case of the unit when open.

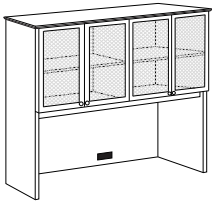

INSTALLATION

Hutch and overhead installation instructions are included with every case, but basic installation instructions can be found in this guide on page 586. All required mounting hardware is included with all hutches.

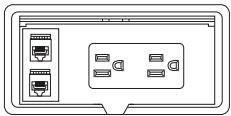

CONNECTING WORKSURFACES

It is important that the product is in its final position and the primary work surface is leveled before connecting other joining pieces.

Detailed installation instructions are included with each unit, or available from Krug Customer Service.

Units are connected with mending plates under work surfaces, and linking brackets on modesty and end panels. Locate connections and attach the mending plate under the work surface. Level pieces if necessary by adjusting the glides to achieve flush and firm joints before completing installation of all hardware.

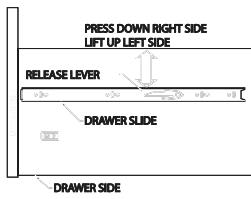

DRAWER REMOVAL

To remove pedestal drawers, open to the extended position, press down on the right side nylon release lever and pull the drawers up on left side lever at the same time. Continue pulling the drawer out of the case.

GLIDE ADJUSTMENTS

Raise one corner of the unit at a time and adjust the glide to the desired height by turning the glide in the hole. Make sure unit is level after adjusting the glides.

Please note that the maximum adjustment range of the glides is 1/2".

When moving units after glides have been inserted, dial the glides to the lowest position to prevent damage to the case.

BOOKCASE OR HUTCH DOOR ADJUSTMENT

Hinges on all hutch and bookcase doors are designed to be adjusted for depth, horizontal and vertical adjustment by means of screws into the hinge mounting plates.

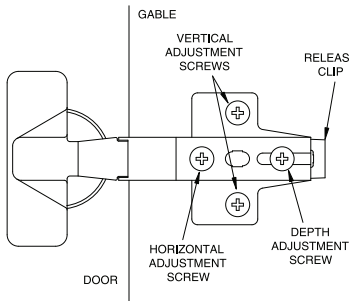

To remove a door, pull the release clip away from the case, disconnecting the hinges.

OVERHEAD INSTALLATION

The wall mounted overhead storage units must be installed on wall studs. The first step for installation is to locate the studs in the wall where the overhead is to be mounted. Measure the stud center line location and use this measurement to mark the hole locations on the mounting rail and the overhead back. Drill clearance holes at the hole locations. Hole requirements will depend on the fasteners chosen by the installer. 2 1/2" x #10 wood screws are adequate if going into wood studs. If studs cannot be accessed, then appropriate drywall plugs or butterfly bolts should be used. We recommend 2 fasteners per stud.

Fasten the mounting rail to the wall ensuring that it is level. Hang the overhead on the mounting rail and then fasten it to the wall. This prevents accidental removal and also allows for some leveling adjustment.

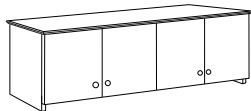

STRATFORD | SAMPLE CONFIGURATIONS

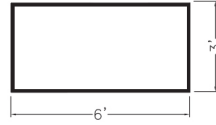
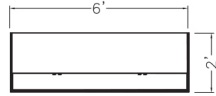
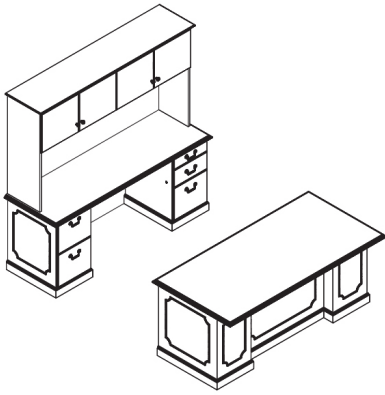

| | Model | Cherry Walnut |
|--------------|--------------|---------------|
| Desk | 98D72364LORF | 4587 |
| Hutch | 98HT721640 | 4748 |
| Credenza | 98C72244LDRF | 5065 |
| TOTAL | | 14,400 |

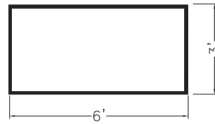
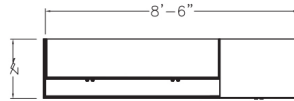
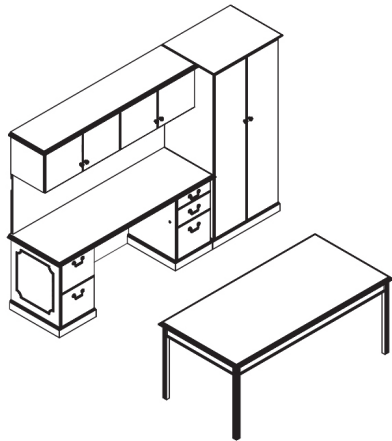

| | Model | Cherry Walnut |
|--------------------|---------------------|---------------|
| Desk | 98TD7236 | 4540 |
| Overhead | 98OH7216 | 2638 |
| Tackboard | 98TBOH72 | 476 |
| Credenza | 98C72244LDRF | 5065 |
| Flush Left Storage | option 98WR30247101 | 120 |
| TOTAL | | 17,354 |

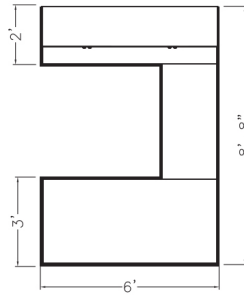
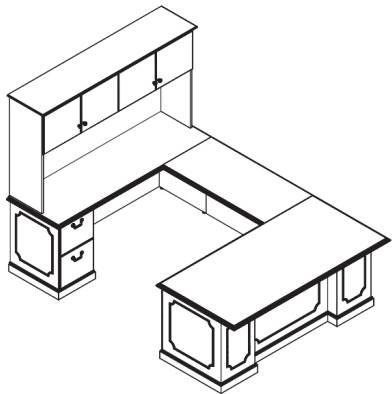

| | Model | Cherry Walnut |
|--------------|--------------|---------------|
| Desk | 98D72364LORF | 4587 |
| Link Unit | 98LU4224H | 1809 |
| Hutch | 98HT721640 | 4748 |
| Credenza | 98C72244LDR0 | 4710 |
| TOTAL | | 15,854 |

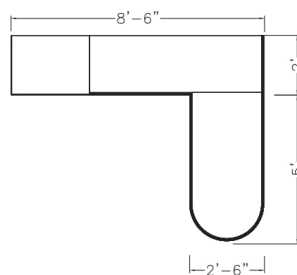
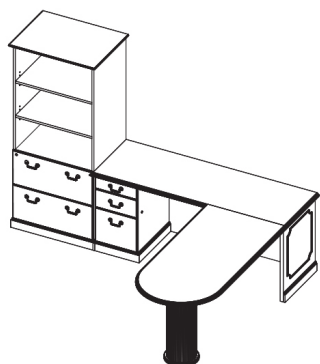

| | Model | Cherry Walnut |
|---------------------|---------------------|---------------|
| Return | 98BR6030 | 1998 |
| Credenza | 98C7220LFR0 | 4414 |
| Flush Right Storage | option 98ST30207103 | 120 |
| TOTAL | | 11,736 |

STRATFORD | DESKS

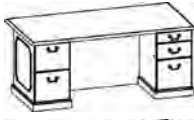
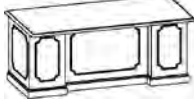
| Description | Model | Cherry | | W | D | H | KW | Shipping | |
|----------------------------------------------------------------------------------------------------------------------|---------------|--------|-------|-------|-------|------|------|----------|------------|
| | | Walnut | | | | | | Weight | Cubic Feet |
|  Double Pedestal Desk | 98D60304LDRD | 5891 | | 59.75 | 29.75 | 30.5 | 25.5 | 273 | 42 |
| | 98D60304LDRF | 5891 | | 59.75 | 29.75 | 30.5 | 25.5 | 273 | 42 |
| | 98D60304LFRD | 5891 | | 59.75 | 29.75 | 30.5 | 25.5 | 273 | 42 |
| | 98D60304LFRF | 5891 | | 59.75 | 29.75 | 30.5 | 25.5 | 273 | 42 |
| | 98D66304LDRD | 5924 | | 65.75 | 29.75 | 30.5 | 31.5 | 280 | 46 |
| | 98D66304LDRF | 5924 | | 65.75 | 29.75 | 30.5 | 31.5 | 280 | 46 |
| | 98D66304LFRD | 5924 | | 65.75 | 29.75 | 30.5 | 31.5 | 280 | 46 |
| | 98D66304LFRF | 5924 | | 65.75 | 29.75 | 30.5 | 31.5 | 280 | 46 |
| | 98D66364LDRD | 5954 | | 65.75 | 35.75 | 30.5 | 31.5 | 295 | 55 |
| | 98D66364LDRF | 5954 | | 65.75 | 35.75 | 30.5 | 31.5 | 295 | 55 |
|  guest side of a 36" deep desk** | 98D66364LFRD | 5954 | | 65.75 | 35.75 | 30.5 | 31.5 | 295 | 55 |
| | 98D66364LFRF | 5954 | | 65.75 | 35.75 | 30.5 | 31.5 | 295 | 55 |
| | 98D72364LDRD | 6039 | | 71.75 | 35.75 | 30.5 | 37.5 | 310 | 60 |
| | 98D72364LDRF* | 6039 | | 71.75 | 35.75 | 30.5 | 37.5 | 310 | 60 |
| | 98D72364LFRD | 6039 | | 71.75 | 35.75 | 30.5 | 37.5 | 310 | 60 |
| | 98D72364LFRF | 6039 | | 71.75 | 35.75 | 30.5 | 37.5 | 310 | 60 |
| | 98D78424LDRD | 6179 | | 77.75 | 41.75 | 30.5 | 43.5 | 327 | 72 |
| | 98D78424LDRF | 6179 | | 77.75 | 41.75 | 30.5 | 43.5 | 327 | 72 |
| | 98D78424LFRD | 6179 | | 77.75 | 41.75 | 30.5 | 43.5 | 327 | 72 |
| | 98D78424LFRF | 6179 | | 77.75 | 41.75 | 30.5 | 43.5 | 327 | 72 |
| 98D84424LDRD | 6316 | | 83.75 | 41.75 | 30.5 | 49.5 | 337 | 78 | |
| 98D84424LDRF | 6316 | | 83.75 | 41.75 | 30.5 | 49.5 | 337 | 78 | |
| 98D84424LFRD | 6316 | | 83.75 | 41.75 | 30.5 | 49.5 | 337 | 78 | |
| 98D84424LFRF | 6316 | | 83.75 | 41.75 | 30.5 | 49.5 | 337 | 78 | |

ORDERING NOTES:

Laminate worksurfaces are available at a 10% upcharge. 30" deep Stratford desks have a 1-1/2" overhang on the guest side. 36" deep Stratford desks have a 7 1/2" overhang on the guest side. See page 578 for more information on the desks overhang and chassis dimensions. A burled walnut top option is available at a 20% upcharge.

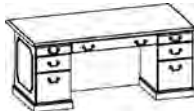
| | | | | | | | | | |
|---------------------------------------------------------------------------------------------------------------------------------------|-----------------|------|--|-------|-------|------|------|-----|----|
|  Double Pedestal Desk with Center Drawer Option | 98D60304LFCDRF | 6258 | | 59.75 | 29.75 | 30.5 | 25.5 | 303 | 42 |
| | 98D66304LFCDRF | 6313 | | 65.75 | 29.75 | 30.5 | 31.5 | 310 | 46 |
| | 98D66364LFCDRF | 6358 | | 65.75 | 35.75 | 30.5 | 31.5 | 325 | 55 |
| | 98D72364LFCDRF* | 6465 | | 71.75 | 35.75 | 30.5 | 37.5 | 340 | 60 |
| | 98D78424LFCDRF | 6621 | | 77.75 | 41.75 | 30.5 | 43.5 | 357 | 72 |
| | 98D84424LFCDRF | 6779 | | 83.75 | 41.75 | 30.5 | 49.5 | 367 | 78 |

ORDERING NOTES:

The center drawer option includes:

- a felt-lined drawer with pencil tray
- two pull-out dictation slides on the user side of the desk.
- a central locking system activating center drawer and both pedestals with a single lock located on the left pedestal inside gable.

Laminate worksurfaces are available at a 10% upcharge. A burled walnut top option is available at a 20% upcharge.

DIMENSION KEY

W — width
 D — depth
 H — height of worksurface
 KW— kneehole width

Dimensions are in inches and approximate. Contact Customer Service if dimensions are critical.

*See page 5 for KrugExpress program.

CODE DESCRIPTION

0 - no pedestal
 4 - full height pedestals
 D - 2 file drawer
 F - 2 box, 1 file drawe
 L - left hand support position
 R - right hand support position
 CD - center drawer
 OT - oversized top option
 BT - bow top option
 CC - corner credenza

STANDARD FINISHES

For a complete list of standard wood finishes please see page 577.

WIRING GROMMET

One rectangular black or one antique brass grommet in a standard position is optional at no charge. Please note grommet choice clearly on order form. Additional grommets are available at an upcharge of **\$152 list**.

STRATFORD | DESKS

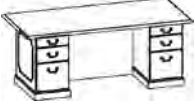
| Description | Model | Cherry Walnut | W | D | H | Shipping Weight | Cubic Feet |
|----------------------------------------------------------------------------------|-------------|---------------|-------|-------|---|-----------------|------------|
|  | OT98D66364 | 308 | 71.75 | 35.75 | - | 15 | - |
| | OT98D72364* | 308 | 77.75 | 35.75 | - | 15 | - |
| | OT98D78424 | 308 | 83.75 | 41.75 | - | 15 | - |

ORDERING NOTES:

The oversized top option is only available on stand-alone double pedestal desks and cannot be used in conjunction with any other run-off or connecting worksurfaces. Specifying the oversized top option increases the top width, increasing the left and right overhang measurement to 4-1/2". The guest side remains 7-1/2" (as is standard for 36" and 42" deep desks). Laminate worksurfaces are available at a 10% upcharge.

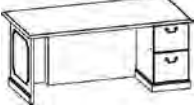
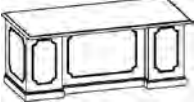
| Description | Model | Cherry Walnut | W | D | H | Shipping Weight | Cubic Feet | |
|----------------------------------------------------------------------------------------------------------------------------------------------------------------------|---------------|---------------|-------|-------|------|-----------------|------------|----|
|   | 98D60304LDR0 | 4063 | 59.75 | 29.75 | 30.5 | 40.5 | 215 | 42 |
| | 98D60304LFR0 | 4063 | 59.75 | 29.75 | 30.5 | 40.5 | 215 | 42 |
| | 98D60304LORD | 4063 | 59.75 | 29.75 | 30.5 | 40.5 | 215 | 42 |
| | 98D60304LORF | 4063 | 59.75 | 29.75 | 30.5 | 40.5 | 215 | 42 |
| | 98D66304LDR0 | 4095 | 65.75 | 29.75 | 30.5 | 46.5 | 222 | 46 |
| | 98D66304LFR0 | 4095 | 65.75 | 29.75 | 30.5 | 46.5 | 222 | 46 |
| | 98D66304LORD | 4095 | 65.75 | 29.75 | 30.5 | 46.5 | 222 | 46 |
| | 98D66304LORF | 4095 | 65.75 | 29.75 | 30.5 | 46.5 | 222 | 46 |
| | 98D66364LDR0 | 4119 | 65.75 | 35.75 | 30.5 | 46.5 | 237 | 55 |
| | 98D66364LFR0 | 4119 | 65.75 | 35.75 | 30.5 | 46.5 | 237 | 55 |
| | 98D66364LORD | 4119 | 65.75 | 35.75 | 30.5 | 46.5 | 237 | 55 |
| | 98D66364LORF | 4119 | 65.75 | 35.75 | 30.5 | 46.5 | 237 | 55 |
| | 98D72364LDR0 | 4587 | 71.75 | 35.75 | 30.5 | 52.5 | 252 | 60 |
| | 98D72364LFR0 | 4587 | 71.75 | 35.75 | 30.5 | 52.5 | 252 | 60 |
| | 98D72364LORD* | 4587 | 71.75 | 35.75 | 30.5 | 52.5 | 252 | 60 |
| | 98D72364LORF | 4587 | 71.75 | 35.75 | 30.5 | 52.5 | 252 | 60 |
| | 98D78424LDR0 | 5038 | 77.75 | 41.75 | 30.5 | 58.5 | 269 | 72 |
| | 98D78424LFR0 | 5038 | 77.75 | 41.75 | 30.5 | 58.5 | 269 | 72 |
| | 98D78424LORD | 5038 | 77.75 | 41.75 | 30.5 | 58.5 | 269 | 72 |
| | 98D78424LORF | 5038 | 77.75 | 41.75 | 30.5 | 58.5 | 269 | 72 |
| 98D84424LDR0 | 5504 | 83.75 | 41.75 | 30.5 | 64.5 | 279 | 78 | |
| 98D84424LFR0 | 5504 | 83.75 | 41.75 | 30.5 | 64.5 | 279 | 78 | |
| 98D84424LORD | 5504 | 83.75 | 41.75 | 30.5 | 64.5 | 279 | 78 | |
| 98D84424LORF | 5504 | 83.75 | 41.75 | 30.5 | 64.5 | 279 | 78 | |

guest side of a 36" deep desk**

ORDERING NOTES:

The oversized top option is only available on stand-alone double pedestal desks and cannot be used in conjunction with any other run-off or connecting worksurfaces. Specifying the oversized top option increases the top width, increasing the left and right overhang measurement to 4-1/2". The guest side remains 7-1/2" (as is standard for 36" and 42" deep desks). Laminate worksurfaces are available at a 10% upcharge.

ORDERING PROCEDURES

To order, please specify the following:

- 1) Krug product model number
- 2) Wood species and finish, see page 577
- 4) Pull style and finish, see page 581
- 5) Grommet location and style if applicable

* Indicates model illustrated by line drawing

CODE DESCRIPTION

- 0 - no pedestal
- 4 - full height pedestals
- D - 2 file drawer
- F - 2 box, 1 file drawer
- L - left hand support position
- R - right hand support position
- CD - center drawer
- OT - oversized top option
- BT - bow top option
- CC - corner credenza

STANDARD FINISHES

For a complete list of standard wood finishes please see page 577.

STRATFORD | DESKS

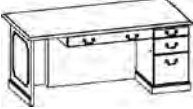
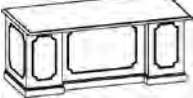
| Description | Model | Cherry | | W | D | H | KW | Shipping | | Cubic |
|------------------------------------------------------------------------------------------------------------------------------------------------------------------------|------------------------------------------------|----------------|-------|-------|-------|------|------|----------|------|-------|
| | | Walnut | | | | | | Weight | Feet | |
|   | Single Pedestal Desk with Center Drawer Option | 98D66304LOCDRF | 4372 | 65.75 | 29.75 | 30.5 | 46.5 | 252 | 46 | |
| | 98D66304LFCDR0 | 4372 | 65.75 | 29.75 | 30.5 | 46.5 | 252 | 46 | | |
| | 98D66364LOCDRF | 4418 | 65.75 | 35.75 | 30.5 | 46.5 | 267 | 55 | | |
| | 98D66364LFCDR0 | 4418 | 65.75 | 35.75 | 30.5 | 46.5 | 267 | 55 | | |
| | 98D72364LOCDRF* | 4903 | 71.75 | 35.75 | 30.5 | 52.5 | 282 | 60 | | |
| | 98D72364LFCDR0 | 4903 | 71.75 | 35.75 | 30.5 | 52.5 | 282 | 60 | | |
| | 98D78424LOCDRF | 5391 | 77.75 | 41.75 | 30.5 | 58.5 | 299 | 72 | | |
| | 98D78424LFCDR0 | 5391 | 77.75 | 41.75 | 30.5 | 58.5 | 299 | 72 | | |
| | 98D84424LOCDRF | 5873 | 83.75 | 41.75 | 30.5 | 64.5 | 309 | 78 | | |
| | 98D84424LFCDR0 | 5873 | 83.75 | 41.75 | 30.5 | 64.5 | 309 | 78 | | |

ORDERING NOTES:

guest side of a 36" deep desk**

The center drawer option includes:

- a felt-lined drawer with pencil tray
- a central locking system activating center drawer and pedestal with a single lock located on the inside pedestal gable.
- pull-out dictation slide on the user side of the desk.

The space left between the pencil drawer and the open end of the desk allows for a 24" run off. Laminate worksurfaces are available at a 10% upcharge. A burled walnut top option is available at a 20% upcharge.

| Description | Model | Cherry | | W | D | H | KW | Shipping | | Cubic |
|------------------------------------------------------------------------------------|-------------|--------------|-------|-------|-------|------|------|----------|------|-------|
| | | Walnut | | | | | | Weight | Feet | |
|  | Desk Shells | 98S6636LOR0* | 2744 | 65.75 | 35.75 | 30.5 | 60.5 | 121 | 55 | |
| | 98S7236LOR0 | 3047 | 71.75 | 35.75 | 30.5 | 66.5 | 137 | 60 | | |
| | 98S7836LOR0 | 3382 | 77.75 | 35.75 | 30.5 | 72.5 | 153 | 64 | | |

| Description | Model | Cherry | | W | D | H | KW | Shipping | | Cubic |
|-------------------------------------------------------------------------------------|----------------|------------|-----|---|---|---|----|----------|------|-------|
| | | Walnut | | | | | | Weight | Feet | |
|  | Bow Top Option | 98D6636BT | 626 | - | - | - | - | - | - | |
| | Upcharge | 98D7236BT* | 674 | - | - | - | - | - | - | |
| | 98D7842BT | 693 | - | - | - | - | - | - | - | |
| | 98D8442BT | 701 | - | - | - | - | - | - | - | |

ORDERING NOTES:

The bow top option is available on all the desk sizes listed above. Please add "BT" to the model number of the desk and add the upcharge shown above. The bowtop option tapers the overhang back on the left and right sides, the depth of the overhang at the widest point is 7 1/2". Laminate worksurfaces are available at a 10% upcharge.

DIMENSION KEY

W — width
D — depth
H — height of worksurface
KW— kneehole width

Dimensions are in inches and approximate. Contact Customer Service if dimensions are critical.

*See page 5 for KrugExpress program.

CODE DESCRIPTION

0 - no pedestal
4 - full height pedestals
D - 2 file drawer
F - 2 box, 1 file drawer
L - left hand support position
R - right hand support position
CD - center drawer
OT - oversized top option
BT - bow top option
CC - corner credenza

STANDARD FINISHES

For a complete list of standard wood finishes please see page 577.

WIRING GROMMET

One rectangular black or one antique brass grommet in a standard position is optional at no charge. Please note grommet choice clearly on order form. Additional grommets are available at an upcharge of **\$152 list**.

STRATFORD | DESKS

| Description | Model | Cherry | | W | D | H | KW | Shipping Weight | Cubic Feet |
|----------------------|-----------|--------|--|-------|-------|------|-------|-----------------|------------|
| | | Walnut | | | | | | | |
| Queen Ann Table Desk | 98TDQ7236 | 4978 | | 83.75 | 35.75 | 30.5 | 65.75 | 150 | 60 |



ORDERING NOTES:

Optional lock: Please add **\$152 list** and specify lock option in the product description. This item is NOT available on KrugExpress. Laminate worksurfaces are available at a 10% upcharge. Please note that pedestals can not be used with table desks.

| | | | | | | | | | |
|------------|-----------|------|--|-------|-------|------|------|-----|----|
| Table Desk | 98TD7236* | 4529 | | 71.75 | 35.75 | 30.5 | 66.5 | 131 | 12 |
| | 98TD7842 | 5028 | | 77.75 | 41.75 | 30.5 | 72.5 | 148 | 14 |



ORDERING NOTES:

Table desk includes a felt-liner center drawer with pencil tray. To add lock, please specify lock option and add **\$143 list**. The lock plug is located above the center drawer in the rail. The table desk is shipped knocked down. This table desk is NOT available on KrugExpress. Laminate worksurfaces are available at a 10% upcharge.

| | | | | | | | | | |
|-----------------------|-----------|------|--|-------|-------|------|-----|----|--|
| Bullet Desk, Post Leg | 98BD6030 | 2874 | | 59.75 | 29.75 | 30.5 | 140 | 36 | |
| | 98BD6630 | 2928 | | 65.75 | 29.75 | 30.5 | 154 | 40 | |
| | 98BD7230 | 2986 | | 71.75 | 29.75 | 30.5 | 170 | 47 | |
| | 98BD6636 | 2959 | | 65.75 | 35.75 | 30.5 | 184 | 43 | |
| | 98BD7236* | 3047 | | 71.75 | 35.75 | 30.5 | 200 | 51 | |

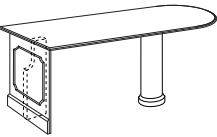

| | | | | | | | | | |
|--------------------|------------|------|--|-------|-------|------|--|-----|----|
| "P" Desk, Post Leg | 98PD7230L | 3745 | | 71.75 | 35.75 | 30.5 | | 189 | 43 |
| | 98PD7230R | 3745 | | 71.75 | 35.75 | 30.5 | | 189 | 43 |
| | 98PD7236L | 3825 | | 71.75 | 41.75 | 30.5 | | 205 | 51 |
| | 98PD7236R* | 3825 | | 71.75 | 41.75 | 30.5 | | 205 | 51 |
| | 98PD7830L | 3896 | | 77.75 | 35.75 | 30.5 | | 219 | 47 |
| | 98PD7830R | 3896 | | 77.75 | 35.75 | 30.5 | | 219 | 47 |
| | 98PD7836R | 3969 | | 77.75 | 41.75 | 30.5 | | 233 | 56 |
| | 98PD7836R | 3969 | | 77.75 | 41.75 | 30.5 | | 233 | 56 |
| | 98PD8430L | 4089 | | 83.75 | 35.75 | 30.5 | | 247 | 50 |
| | 98PD8430R | 4089 | | 83.75 | 35.75 | 30.5 | | 247 | 50 |
| | 98PD8436L | 4193 | | 83.75 | 41.75 | 30.5 | | 260 | 60 |
| | 98PD8436R | 4193 | | 83.75 | 41.75 | 30.5 | | 260 | 60 |

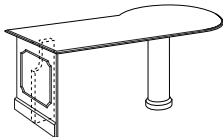

ORDERING NOTES:

"P" desk/return legs are 10.5 in diameter. Laminate worksurfaces are available at a 10% upcharge.

ORDERING PROCEDURES

To order, please specify the following:

- 1) Krug product model number
- 2) Wood species and finish, see page 577
- 4) Pull style and finish, see page 581
- 5) Grommet location and style if applicable

* Indicates model illustrated by line drawing

CODE DESCRIPTION

- 0 - no pedestal
- 4 - full height pedestals
- D - 2 file drawer
- F - 2 box, 1 file drawer
- L - left hand support position
- R - right hand support position
- CD - center drawer
- OT - oversized top option
- BT - bow top option
- CC - corner credenza

STANDARD FINISHES

For a complete list of standard wood finishes please see page 577.

LOCKS

Locks are standard on all lateral file drawers. Optional locks on bookcase doors are available at a **\$152 list** upcharge. Please specify at time of order.

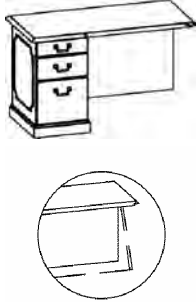
| Description | Model | Cherry Walnut | W | D | H | KW | Shipping Weight | Cubic Feet |
|-----------------------------------------------------------------------------------|--------------|---------------|-------|-------|------|-----|-----------------|------------|
|  | 98RH4220L4D | 3553 | 41.75 | 20.5 | 30.5 | 23 | 114 | 22 |
| | 98RH4220L4F | 3553 | 41.75 | 20.5 | 30.5 | 23 | 114 | 22 |
| | 98RH4220R4D | 3553 | 41.75 | 20.5 | 30.5 | 23 | 114 | 22 |
| | 98RH4220R4F | 3553 | 41.75 | 20.5 | 30.5 | 23 | 118 | 22 |
| | 98RH4224L4D | 3602 | 41.75 | 23.75 | 30.5 | 23 | 118 | 26 |
| | 98RH4224L4F | 3602 | 41.75 | 23.75 | 30.5 | 23 | 114 | 26 |
| | 98RH4224R4D | 3602 | 41.75 | 23.75 | 30.5 | 23 | 114 | 26 |
| | 98RH4224R4F | 3602 | 41.75 | 23.75 | 30.5 | 23 | 114 | 26 |
| | 98RH4820L4D | 3633 | 47.75 | 20.5 | 30.5 | 27 | 118 | 25 |
| | 98RH4820L4F | 3633 | 47.75 | 20.5 | 30.5 | 27 | 118 | 25 |
| | 98RH4820R4D | 3633 | 47.75 | 20.5 | 30.5 | 27 | 118 | 25 |
| | 98RH4820R4F | 3633 | 47.75 | 20.5 | 30.5 | 27 | 122 | 25 |
| | 98RH4824L4D | 3647 | 47.75 | 23.75 | 30.5 | 27 | 122 | 29 |
| | 98RH4824L4F* | 3647 | 47.75 | 23.75 | 30.5 | 27 | 118 | 29 |
| | 98RH4824R4D | 3647 | 47.75 | 23.75 | 30.5 | 27 | 118 | 29 |
| | 98RH4824R4F | 3647 | 47.75 | 23.75 | 30.5 | 27 | 118 | 29 |
| | 98RH5420L4D | 3679 | 53.75 | 20.5 | 30.5 | 35 | 122 | 28 |
| | 98RH5420L4F | 3679 | 53.75 | 20.5 | 30.5 | 35 | 122 | 28 |
| | 98RH5420R4D | 3679 | 53.75 | 20.5 | 30.5 | 35 | 122 | 28 |
| | 98RH5420R4F | 3679 | 53.75 | 20.5 | 30.5 | 35 | 126 | 28 |
| | 98RH5424L4D | 3720 | 53.75 | 23.75 | 30.5 | 35 | 126 | 32 |
| | 98RH5424L4F | 3720 | 53.75 | 23.75 | 30.5 | 35 | 122 | 32 |
| | 98RH5424R4D | 3720 | 53.75 | 23.75 | 30.5 | 35 | 122 | 32 |
| | 98RH5424R4F | 3720 | 53.75 | 23.75 | 30.5 | 35 | 122 | 32 |
| | 98RH6020L4D | 3798 | 59.75 | 20.5 | 30.5 | 41 | 126 | 31 |
| | 98RH6020L4F | 3798 | 59.75 | 20.5 | 30.5 | 41 | 126 | 31 |
| | 98RH6020R4D | 3798 | 59.75 | 20.5 | 30.5 | 41 | 126 | 31 |
| | 98RH6020R4F | 3798 | 59.75 | 20.5 | 30.5 | 41 | 130 | 31 |
| | 98RH6024L4D | 3870 | 59.75 | 23.75 | 30.5 | 41 | 130 | 36 |
| | 98RH6024L4F | 3870 | 59.75 | 23.75 | 30.5 | 41 | 126 | 36 |
| | 98RH6024R4D | 3870 | 59.75 | 23.75 | 30.5 | 41 | 126 | 36 |
| | 98RH6024R4F | 3870 | 59.75 | 23.75 | 30.5 | 41 | 126 | 36 |
| | 98RH6620L4D | 4063 | 65.75 | 20.5 | 30.5 | 47 | 130 | 33 |
| 98RH6620L4F | 4063 | 65.75 | 20.5 | 30.5 | 47 | 130 | 33 | |
| 98RH6620R4D | 4063 | 65.75 | 20.5 | 30.5 | 47 | 130 | 33 | |
| 98RH6620R4F | 4063 | 65.75 | 20.5 | 30.5 | 47 | 165 | 33 | |
| 98RH6624L4D | 4108 | 65.75 | 23.75 | 30.5 | 47 | 165 | 39 | |
| 98RH6624L4F | 4108 | 65.75 | 23.75 | 30.5 | 47 | 130 | 39 | |
| 98RH6624R4D | 4108 | 65.75 | 23.75 | 30.5 | 47 | 130 | 39 | |
| 98RH6624R4F | 4108 | 65.75 | 23.75 | 30.5 | 47 | 130 | 39 | |

ORDERING NOTES:

Modesty panels on returns are raised above the base mounding. Laminate worksurfaces are available at a 10% upcharge. For wire management cut out option on modesty panel add **\$194 list upcharge**. For hinged modesty panel upcharge insert Y after the C in the model number. e.g. 98CY7224LORF

DIMENSION KEY

W — width
 D — depth
 H — height of worksurface
 KW— kneehole width

Dimensions are in inches and approximate.
 Contact Customer Service if dimensions are critical.

*See page 5 for KrugExpress program.

CODE DESCRIPTION

0 - no pedestal
 4 - full height pedestals
 D - 2 file drawer
 F - 2 box, 1 file drawer
 L - left hand support position
 R - right hand support position
 CD - center drawer
 OT - oversized top option
 BT - bow top option
 CC - corner credenza

STANDARD FINISHES

For a complete list of standard wood finishes please see page 577.

WIRING GROMMET

One rectangular black or one antique brass grommet in a standard position is optional at no charge. Please note grommet choice clearly on order form. Additional grommets are available at an upcharge of **\$152 list**.

STRATFORD | RETURNS

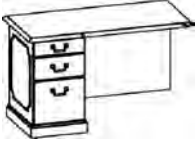
| Description | Model | Cherry | | W | D | H | KW | Shipping Weight | Cubic Feet |
|--------------------------------------------------------------------------------------------------------------------|--------------|--------|--|-------|-------|------|----|-----------------|------------|
| | | Walnut | | | | | | | |
|  Single Pedestal Return, Continued | 98RH7220L4D | 4168 | | 71.75 | 20.5 | 30.5 | 53 | 165 | 36 |
| | 98RH7220L4F* | 4168 | | 71.75 | 20.5 | 30.5 | 53 | 165 | 36 |
| | 98RH7220R4D | 4168 | | 71.75 | 20.5 | 30.5 | 53 | 165 | 36 |
| | 98RH7220R4F | 4168 | | 71.75 | 20.5 | 30.5 | 53 | 170 | 36 |
| | 98RH7224L4D | 4244 | | 71.75 | 23.75 | 30.5 | 53 | 170 | 42 |
| | 98RH7224L4F | 4244 | | 71.75 | 23.75 | 30.5 | 53 | 165 | 42 |
| | 98RH7224R4D | 4244 | | 71.75 | 23.75 | 30.5 | 53 | 165 | 42 |
| | 98RH7224R4F | 4244 | | 71.75 | 23.75 | 30.5 | 53 | 165 | 42 |

ORDERING NOTES:

Modesty panels on returns are raised above the base mounding. Laminate worksurfaces are available at a 10% upcharge. For wire management cut out option on modesty panel add **\$194 list** upcharge. For hinged modesty panel upcharge insert Y after the C in the model number. e.g. 98CY7224LORF

| Return Shells | Model | Cherry | | W | D | H | KW | Shipping Weight | Cubic Feet |
|----------------------------------------------------------------------------------|-------------|--------|--|-------|-------|------|-------|-----------------|------------|
| | | Walnut | | | | | | | |
|  | 98RH4224L0* | 2140 | | 41.75 | 23.75 | 30.5 | 39.25 | 68 | 26 |
| | 98RH4224R0 | 2140 | | 41.75 | 23.75 | 30.5 | 39.25 | 68 | 26 |
| | 98RH4824L0 | 2168 | | 47.75 | 23.75 | 30.5 | 45.25 | 72 | 29 |
| | 98RH4824R0 | 2168 | | 47.75 | 23.75 | 30.5 | 45.25 | 72 | 29 |

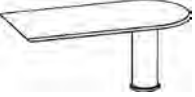
| Bullet Return, Post Leg | Model | Cherry | | W | D | H | KW | Shipping Weight | Cubic Feet |
|------------------------------------------------------------------------------------|-----------|--------|--|-------|-------|------|----|-----------------|------------|
| | | Walnut | | | | | | | |
|  | 98BR6030 | 1998 | | 59.75 | 29.75 | 30.5 | | 66 | 3 |
| | 98BR6630 | 2024 | | 65.75 | 29.75 | 30.5 | | 81 | 4 |
| | 98BR6636 | 2053 | | 65.75 | 35.75 | 30.5 | | 101 | 4 |
| | 98BR7230 | 2089 | | 71.75 | 29.75 | 30.5 | | 106 | 4 |
| | 98BR7236* | 2158 | | 71.75 | 35.75 | 30.5 | | 116 | 5 |

ORDERING NOTES:

Bullet desk/return legs are 10.5 in diameter. Bullet desks are available in 72" lengths only for KrugExpress. Laminate worksurfaces are available at a 10% upcharge.

| "P" Return, Post Leg | Model | Cherry | | W | D | H | KW | Shipping Weight | Cubic Feet |
|------------------------------------------------------------------------------------|------------|--------|--|-------|-------|------|----|-----------------|------------|
| | | Walnut | | | | | | | |
|  | 98PR7230L | 3195 | | 71.75 | 35.75 | 30.5 | | 112 | 43 |
| | 98PR7230R | 3195 | | 71.75 | 35.75 | 30.5 | | 112 | 43 |
| | 98PR7236L | 3336 | | 71.75 | 41.75 | 30.5 | | 128 | 51 |
| | 98PR7236R* | 3336 | | 71.75 | 41.75 | 30.5 | | 128 | 51 |
| | 98PR7836L | 3408 | | 77.75 | 41.75 | 30.5 | | 128 | 47 |
| | 98PR8430L | 3408 | | 83.75 | 35.75 | 30.5 | | 128 | 47 |
| | 98PR8430R | 3522 | | 83.75 | 35.75 | 30.5 | | 128 | 56 |
| | 98PR8436L | 3522 | | 83.75 | 41.75 | 30.5 | | 128 | 56 |
| | 98PR8436R | 3620 | | 83.75 | 41.75 | 30.5 | | 128 | 50 |
| | 98PR7836R | 3620 | | 77.75 | 41.75 | 30.5 | | 128 | 50 |
| | 98PR7830L | 3723 | | 77.75 | 35.75 | 30.5 | | 142 | 60 |
| | 98PR7830R | 3723 | | 77.75 | 35.75 | 30.5 | | 142 | 60 |

ORDERING PROCEDURES

To order, please specify the following:

- 1) Krug product model number
- 2) Wood species and finish, see page 577
- 4) Pull style and finish, see page 581
- 5) Grommet location and style if applicable

* Indicates model illustrated by line drawing

CODE DESCRIPTION

- 0 - no pedestal
- 4 - full height pedestals
- D - 2 file drawer
- F - 2 box, 1 file drawer
- L - left hand support position
- R - right hand support position
- CD - center drawer
- OT - oversized top option
- BT - bow top option
- CC - corner credenza

STANDARD FINISHES

For a complete list of standard wood finishes please see page 577.

WIRING GROMMET

One rectangular black or one antique brass grommet in a standard position is optional at no charge. Please note grommet choice clearly on order form. Additional grommets are available at an upcharge of **\$152 list**.

STRATFORD | LINKING UNITS & CORNER UNITS

| Description | Model | Cherry Walnut | W | D | H | KW | Shipping Weight | Cubic Feet |
|-----------------------------------------------------------------------------------|------------|------------------|-------|-------|------|----|--------------------|---------------|
|  | 98LU3620H | 1673 | 34.75 | 19.75 | 30.5 | | 15 | 3 |
| | 98LU3624H | 1728 | 34.75 | 23.75 | 30.5 | | 16 | 3 |
| | 98LU4220H | 1749 | 38.75 | 19.75 | 30.5 | | 20 | 4 |
| | 98LU4224H* | 1809 | 38.75 | 23.75 | 30.5 | | 24 | 4 |
| | 98LU4820H | 1844 | 44.75 | 19.75 | 30.5 | | 29 | 4 |
| | 98LU4824H | 1883 | 44.75 | 23.75 | 30.5 | | 36 | 4 |

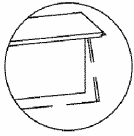

ORDERING NOTES:

Please note on order if picture frame molding is required on hinged modesty panel. Laminate worksurfaces are available at a 10% upcharge.

For wire management cut out option on modesty panel add **\$94 list upcharge**.

For hinged modesty panel upcharge add 10% and insert Y after the LU in the model number. e.g. 98LUY4224H

| Description | Model | Cherry Walnut | W | D | H | KW | Shipping Weight | Cubic Feet |
|-----------------------------------------------------------------------------------|------------|------------------|-------|-------|------|----|--------------------|---------------|
|  | 98LT3620H | 830 | 34.75 | 19.75 | 1.25 | | 15 | 2 |
| | 98LT3624H | 840 | 34.75 | 23.75 | 1.25 | | 16 | 2 |
| | 98LT4220H | 864 | 38.75 | 19.75 | 1.25 | | 20 | 2 |
| | 98LT4224H* | 889 | 38.75 | 23.75 | 1.25 | | 24 | 2 |
| | 98LT4820H | 909 | 44.75 | 19.75 | 1.25 | | 29 | 2 |
| | 98LT4824H | 929 | 44.75 | 23.75 | 1.25 | | 36 | 3 |

ORDERING NOTES:

Laminate worksurfaces are available at a 10% upcharge.

| Description | Model | Cherry Walnut | W | D | H | KW | Shipping Weight | Cubic Feet |
|-------------------------------------------------------------------------------------|-------------|------------------|-------|-------|------|------|--------------------|---------------|
|  | 98CU363620 | 3277 | 35.75 | 35.75 | 30.5 | 22.5 | 106 | 33 |
| | 98CU363624* | 3277 | 35.75 | 35.75 | 30.5 | 17 | 106 | 33 |
| | 98CU424224 | 3602 | 41.75 | 41.75 | 30.5 | 25.5 | 131 | 41 |

ORDERING NOTES:

Laminate worksurfaces are available at a 10% upcharge. The x dimension on the 98CU363624 corner unit does not allow for an undersurface mounted keyboard or pencil drawer. Please specify a 98KBAC2110 with an extended mechanism if keyboard is required. See page 604.

DIMENSION KEY

W – width
D – depth
H – height of worksurface
KW – kneehole width

Dimensions are in inches and approximate.
Contact Customer Service if dimensions are critical.

*See page 5 for KrugExpress program.

CODE DESCRIPTION

4 - full height pedestals
D - 2 file drawer
F - 2 box, 1 file drawer
L - left hand support position
R - right hand support position
CU - corner unit
LT - linking top
Lu - linking unit

STANDARD FINISHES

For a complete list of standard wood finishes please see page 577.

WIRING GROMMET

One rectangular black or one antique brass grommet in a standard position is optional at no charge. Please note grommet choice clearly on order form. Additional grommets are available at an upcharge of **\$152 list**.

STRATFORD | CREDENZAS

| Description | Model | Cherry Walnut | W | D | H | Shipping Weight | Cubic Feet |
|--------------------------------------------------------------------------------------------------|--------------|---------------|-------|-------|------|-----------------|------------|
|  Credenza Shells | 98S6624LOR0* | 2650 | 65.75 | 23.75 | 30.5 | 121 | 32 |
| | 98S7224LOR0 | 2890 | 71.75 | 23.75 | 30.5 | 137 | 35 |
| | 98S7824LOR0 | 3141 | 77.75 | 23.75 | 30.5 | 153 | 38 |

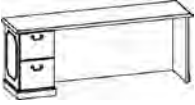
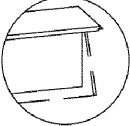
| Description | Model | Cherry Walnut | W | D | H | Shipping Weight | Cubic Feet | |
|------------------------------------------------------------------------------------------------------------------------------------------------------------------------------------------------|---------------|---------------|-------|-------|------|-----------------|------------|----|
|   Single Pedestal Credenza | 98C66204LDR0 | 4636 | 65.75 | 19.75 | 30.5 | 46.5 | 163 | 33 |
| | 98C66204LFR0 | 4636 | 65.75 | 19.75 | 30.5 | 46.5 | 163 | 33 |
| | 98C66204LORD | 4636 | 65.75 | 19.75 | 30.5 | 46.5 | 163 | 33 |
| | 98C66204LORF | 4636 | 65.75 | 19.75 | 30.5 | 46.5 | 163 | 33 |
| | 98C66244LDR0 | 4637 | 65.75 | 23.75 | 30.5 | 46.5 | 171 | 38 |
| | 98C66244LFR0 | 4637 | 65.75 | 23.75 | 30.5 | 46.5 | 171 | 38 |
| | 98C66244LORD | 4637 | 65.75 | 23.75 | 30.5 | 46.5 | 171 | 38 |
| | 98C66244LORF | 4637 | 65.75 | 23.75 | 30.5 | 46.5 | 171 | 38 |
| | 98C72204LDR0 | 4675 | 71.75 | 19.75 | 30.5 | 52.5 | 179 | 36 |
| | 98C72204LFR0 | 4675 | 71.75 | 19.75 | 30.5 | 52.5 | 179 | 36 |
| | 98C72204LORD | 4675 | 71.75 | 19.75 | 30.5 | 52.5 | 179 | 36 |
| | 98C72204LORF | 4675 | 71.75 | 19.75 | 30.5 | 52.5 | 179 | 36 |
| | 98C72244LDR0 | 4710 | 71.75 | 23.75 | 30.5 | 52.5 | 187 | 41 |
| | 98C72244LFR0 | 4710 | 71.75 | 23.75 | 30.5 | 52.5 | 187 | 41 |
| | 98C72244LORD | 4710 | 71.75 | 23.75 | 30.5 | 52.5 | 187 | 41 |
| | 98C72244LORF | 4710 | 71.75 | 23.75 | 30.5 | 52.5 | 187 | 41 |
| | 98C78204LDR0* | 4689 | 77.75 | 19.75 | 30.5 | 58.5 | 195 | 38 |
| | 98C78204LFR0 | 4689 | 77.75 | 19.75 | 30.5 | 58.5 | 195 | 38 |
| | 98C78204LORD | 4689 | 77.75 | 19.75 | 30.5 | 58.5 | 195 | 38 |
| | 98C78204LORF | 4689 | 77.75 | 19.75 | 30.5 | 58.5 | 195 | 38 |
| | 98C78244LDR0 | 4689 | 77.75 | 23.75 | 30.5 | 58.5 | 203 | 44 |
| | 98C78244LFR0 | 4689 | 77.75 | 23.75 | 30.5 | 58.5 | 203 | 44 |
| | 98C78244LORD | 4689 | 77.75 | 23.75 | 30.5 | 58.5 | 203 | 44 |
| | 98C78244LORF | 4689 | 77.75 | 23.75 | 30.5 | 58.5 | 203 | 44 |
| | 98C84204LDR0 | 4713 | 83.75 | 19.75 | 30.5 | 64.5 | 211 | 41 |
| | 98C84204LFR0 | 4713 | 83.75 | 19.75 | 30.5 | 64.5 | 211 | 41 |
| | 98C84204LORD | 4713 | 83.75 | 19.75 | 30.5 | 64.5 | 211 | 41 |
| | 98C84204LORF | 4713 | 83.75 | 19.75 | 30.5 | 64.5 | 211 | 41 |
| 98C84244LDR0 | 4735 | 83.75 | 23.75 | 30.5 | 64.5 | 219 | 48 | |
| 98C84244LFR0 | 4735 | 83.75 | 23.75 | 30.5 | 64.5 | 219 | 48 | |
| 98C84244LORD | 4735 | 83.75 | 23.75 | 30.5 | 64.5 | 219 | 48 | |
| 98C84244LORF | 4735 | 83.75 | 23.75 | 30.5 | 64.5 | 219 | 48 | |

ORDERING NOTES:

Please note on order if picture frame molding is required on hinged modesty panel. Laminate worksurfaces are available at a 10% upcharge. For wire management cut out option on modesty panel add **\$194 list** upcharge. For hinged modesty panel add a 10% upcharge and insert Y after the C in the model number. e.g. 98CY72244LORF

ORDERING PROCEDURES

To order, please specify the following:

- 1) Krug product model number
- 2) Wood species and finish, see page 577
- 4) Pull style and finish, see page 581
- 5) Grommet location and style if applicable

* Indicates model illustrated by line drawing

CODE DESCRIPTION

0 - no pedestal
 4 - full height pedestals
 D - 2 file drawer
 F - 2 box, 1 file drawer
 L - left hand support position
 R - right hand support position
 CD - center drawer
 OT - oversized top option
 BT - bow top option
 CC - corner credenza

STANDARD FINISHES

For a complete list of standard wood finishes please see page 577.

WIRING GROMMET

One rectangular black or one antique brass grommet in a standard position is optional at no charge. Please note grommet choice clearly on order form. Additional grommets are available at an upcharge of **\$152 list**.

STRATFORD | CREDENZAS

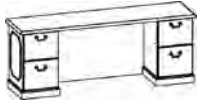
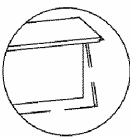
| Description | Model | Cherry Walnut | W | D | H | KW | Shipping Weight | Cubic Feet |
|-----------------------------------------------------------------------------------|---------------|---------------|-------|-------|------|------|-----------------|------------|
| Double Pedestal Credenza | 98C66204LDRD | 4978 | 65.75 | 19.75 | 30.5 | 31.5 | 198 | 33 |
| | 98C66204LDRF | 4978 | 65.75 | 19.75 | 30.5 | 31.5 | 198 | 33 |
|  | 98C66204LFRD | 4978 | 65.75 | 19.75 | 30.5 | 31.5 | 198 | 33 |
| | 98C66204LFRF | 4978 | 65.75 | 19.75 | 30.5 | 31.5 | 198 | 33 |
|  | 98C66244LDRD | 4988 | 65.75 | 23.75 | 30.5 | 31.5 | 211 | 38 |
| | 98C66244LDRF | 4988 | 65.75 | 23.75 | 30.5 | 31.5 | 211 | 38 |
| | 98C66244LFRD | 4988 | 65.75 | 23.75 | 30.5 | 31.5 | 211 | 38 |
| | 98C66244LFRF | 4988 | 65.75 | 23.75 | 30.5 | 31.5 | 211 | 38 |
| | 98C72204LDRD | 5031 | 71.75 | 19.75 | 30.5 | 37.5 | 214 | 36 |
| | 98C72204LDRF | 5031 | 71.75 | 19.75 | 30.5 | 37.5 | 214 | 36 |
| | 98C72204LFRD | 5031 | 71.75 | 19.75 | 30.5 | 37.5 | 214 | 36 |
| | 98C72204LFRF | 5031 | 71.75 | 19.75 | 30.5 | 37.5 | 214 | 36 |
| | 98C72244LDRD | 5065 | 71.75 | 23.75 | 30.5 | 37.5 | 227 | 41 |
| | 98C72244LDRF | 5065 | 71.75 | 23.75 | 30.5 | 37.5 | 227 | 41 |
| | 98C72244LFRD | 5065 | 71.75 | 23.75 | 30.5 | 37.5 | 227 | 41 |
| | 98C72244LFRF | 5065 | 71.75 | 23.75 | 30.5 | 37.5 | 227 | 41 |
| | 98C78204LDRD* | 5111 | 77.75 | 19.75 | 30.5 | 43.5 | 230 | 38 |
| | 98C78204LDRF | 5111 | 77.75 | 19.75 | 30.5 | 43.5 | 230 | 38 |
| | 98C78204LFRD | 5111 | 77.75 | 19.75 | 30.5 | 43.5 | 230 | 38 |
| | 98C78204LFRF | 5111 | 77.75 | 19.75 | 30.5 | 43.5 | 230 | 38 |
| | 98C78244LDRD | 5157 | 77.75 | 23.75 | 30.5 | 43.5 | 243 | 44 |
| | 98C78244LDRF | 5157 | 77.75 | 23.75 | 30.5 | 43.5 | 243 | 44 |
| | 98C78244LFRD | 5157 | 77.75 | 23.75 | 30.5 | 43.5 | 243 | 44 |
| | 98C78244LFRF | 5157 | 77.75 | 23.75 | 30.5 | 43.5 | 243 | 44 |
| | 98C84204LDRD | 5166 | 83.75 | 19.75 | 30.5 | 49.5 | 246 | 41 |
| | 98C84204LDRF | 5166 | 83.75 | 19.75 | 30.5 | 49.5 | 246 | 41 |
| | 98C84204LFRD | 5166 | 83.75 | 19.75 | 30.5 | 49.5 | 246 | 41 |
| | 98C84204LFRF | 5166 | 83.75 | 19.75 | 30.5 | 49.5 | 246 | 41 |
| | 98C84244LDRD | 5179 | 83.75 | 23.75 | 30.5 | 49.5 | 259 | 48 |
| | 98C84244LDRF | 5179 | 83.75 | 23.75 | 30.5 | 49.5 | 259 | 48 |
| | 98C84244LFRD | 5179 | 83.75 | 23.75 | 30.5 | 49.5 | 259 | 48 |
| | 98C84244LFRF | 5179 | 83.75 | 23.75 | 30.5 | 49.5 | 259 | 48 |

ORDERING NOTES:

Please note on order if picture frame molding is required on hinged modesty panel. Laminate worksurfaces are available at a 10% upcharge.

For wire management cut out option on modesty panel add **\$194 list upcharge**.

For hinged modesty panel add a 10% upcharge and insert Y after the C in the model number. e.g. 98CY7224LFRF

DIMENSION KEY

W — width
D — depth
H — height of worksurface
KW— kneehole width

Dimensions are in inches and approximate.
Contact Customer Service if dimensions are critical.

*See page 5 for KrugExpress program.

CODE DESCRIPTION

0 - no pedestal
4 - full height pedestals
D - 2 file drawer
F - 2 box, 1 file drawer
L - left hand support position
R - right hand support position
CD - center drawer
OT - oversized top option
BT - bow top option
CC - corner credenza

STANDARD FINISHES

For a complete list of standard wood finishes please see page 577.

WIRING GROMMET

One rectangular black or one antique brass grommet in a standard position is optional at no charge. Please note grommet choice clearly on order form. Additional grommets are available at an upcharge of **\$152 list**.

CASEGOODS | USA | 603

STRATFORD | CREDENZAS

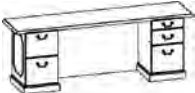
| Description | Model | Cherry | | W | D | H | Shipping Weight | Cubic Feet |
|----------------------------------------------------------------------------------|------------|--------|--|-------|-------|---|-----------------|------------|
| | | Walnut | | | | | | |
|  | OT98C6620 | 308 | | 71.75 | 19.75 | - | 15 | - |
| | OT98C6624 | 308 | | 71.75 | 23.75 | - | 15 | - |
| | OT98C7220 | 308 | | 77.75 | 19.75 | - | 15 | - |
| | OT98C7224 | 308 | | 77.75 | 23.75 | - | 15 | - |
| | OT98C7820* | 308 | | 83.75 | 19.75 | - | 15 | - |
| | OT98C7824 | 308 | | 83.75 | 23.75 | - | 15 | - |

ORDERING NOTES:

In the 20" deep knee hole credenzas and/or shells the pencil drawer cannot be used. The oversized top option is only available on stand-alone double pedestal credenzas and cannot be used in conjunction with any other run-off connecting worksurfaces. Specifying the oversized top option increases the top width, increasing the left and right overhang measurement to 4 1/2". The front and rear overhang remains unchanged. Laminate worksurfaces are available at a 10% upcharge.

| Description | Model | | Cherry | | W | D | H | Shipping Weight | Cubic Feet |
|-----------------------------------------------------------------------------------|--------------|------|--------|-------|-------|------|-------|-----------------|------------|
| | | | Walnut | | | | | | |
|  | 98C6620LBR0 | 4233 | | 65.75 | 19.75 | 30.5 | 25.75 | 204 | 33 |
| | 98C6620LFR0 | 4233 | | 65.75 | 19.75 | 30.5 | 25.75 | 212 | 33 |
| | 98C6620LORB | 4233 | | 65.75 | 19.75 | 30.5 | 25.75 | 204 | 33 |
| | 98C6620LORF | 4233 | | 65.75 | 19.75 | 30.5 | 25.75 | 212 | 33 |
| | 98C6624LBR0 | 4316 | | 65.75 | 23.75 | 30.5 | 25.75 | 211 | 38 |
| | 98C6624LFR0 | 4316 | | 65.75 | 23.75 | 30.5 | 25.75 | 227 | 38 |
| | 98C6624LORB | 4316 | | 65.75 | 23.75 | 30.5 | 25.75 | 211 | 38 |
| | 98C6624LORF | 4316 | | 65.75 | 23.75 | 30.5 | 25.75 | 227 | 38 |
| | 98C7220LBR0 | 4414 | | 71.75 | 19.75 | 30.5 | 31.75 | 228 | 36 |
| | 98C7220LFR0 | 4414 | | 71.75 | 19.75 | 30.5 | 31.75 | 236 | 36 |
| | 98C7220LORB | 4414 | | 71.75 | 19.75 | 30.5 | 31.75 | 228 | 36 |
| | 98C7220LORF | 4414 | | 71.75 | 19.75 | 30.5 | 31.75 | 236 | 36 |
| | 98C7224LBR0 | 4509 | | 71.75 | 23.75 | 30.5 | 31.75 | 235 | 41 |
| | 98C7224LFR0 | 4509 | | 71.75 | 23.75 | 30.5 | 31.75 | 243 | 41 |
| | 98C7224LORB | 4509 | | 71.75 | 23.75 | 30.5 | 31.75 | 235 | 41 |
| | 98C7224LORF | 4509 | | 71.75 | 23.75 | 30.5 | 31.75 | 243 | 41 |
| | 98C8420LBR0 | 4635 | | 83.75 | 19.75 | 30.5 | 43.75 | 256 | 41 |
| | 98C8420LFR0 | 4635 | | 83.75 | 19.75 | 30.5 | 43.75 | 268 | 41 |
| | 98C8420LORB | 4635 | | 83.75 | 19.75 | 30.5 | 43.75 | 256 | 41 |
| | 98C8420LORF | 4635 | | 83.75 | 19.75 | 30.5 | 43.75 | 268 | 41 |
| | 98C8424LBR0 | 4732 | | 83.75 | 23.75 | 30.5 | 43.75 | 267 | 48 |
| | 98C8424LFR0 | 4732 | | 83.75 | 23.75 | 30.5 | 43.75 | 275 | 48 |
| | 98C8424LORB | 4732 | | 83.75 | 23.75 | 30.5 | 43.75 | 267 | 48 |
| | 98C8424LORF* | 4732 | | 83.75 | 23.75 | 30.5 | 43.75 | 275 | 48 |

ORDERING NOTES:

Please note on order if picture frame molding is required on hinged modesty panel. Laminate worksurfaces are available at a 10% upcharge. Bookcase pedestals include one adjustable shelf. For hinged modesty panel add a 10% upcharge and insert Y after the C in the model number. e.g. 98CY7224LORF

ORDERING PROCEDURES

To order, please specify the following:

- 1) Krug product model number
- 2) Wood species and finish, see page 577
- 4) Pull style and finish, see page 581
- 5) Grommet location and style if applicable

* Indicates model illustrated by line drawing

CODE DESCRIPTION

- 0 - no pedestal
- 4 - full height pedestals
- D - 2 file drawer
- F - 2 box, 1 file drawer
- L - left hand support position
- R - right hand support position
- CD - center drawer
- OT - oversized top option
- BT - bow top option
- CC - corner credenza

STANDARD FINISHES

For a complete list of standard wood finishes please see page 577.

WIRING GROMMET

One rectangular black or one antique brass grommet in a standard position is optional at no charge. Please note grommet choice clearly on order form. Additional grommets are available at an upcharge of **\$152 list**.

STRATFORD | CREDENZAS

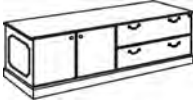
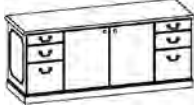
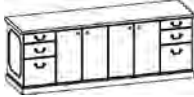
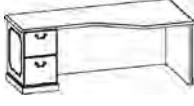
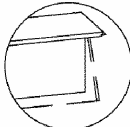
| Description | Model | Cherry Walnut | W | D | H | KW | Shipping Weight | Cubic Feet |
|---------------------------------------------------------------------------------------------------------------------------------------------------------------------------|----------------|---------------|-------|-------|------|-------|-----------------|------------|
|  | 98C6320LFRF | 6079 | 62.5 | 19.75 | 30.5 | | 304 | 27 |
| | 98C6324LFRF | 6108 | 62.5 | 23.75 | 30.5 | | 316 | 27 |
| | 98C7220LBRF | 6214 | 71.75 | 19.75 | 30.5 | | 320 | 29 |
| | 98C7220LFRB | 6214 | 71.75 | 19.75 | 30.5 | | 320 | 29 |
| | 98C7224LBRF* | 6334 | 71.75 | 23.75 | 30.5 | | 331 | 35 |
| | 98C7224LFRB | 6334 | 71.75 | 23.75 | 30.5 | | 331 | 35 |
| | 98C7520LFRF | 6953 | 74.5 | 19.75 | 30.5 | | 334 | 37 |
| | 98C7524LFRF | 7016 | 74.5 | 23.75 | 30.5 | | 347 | 37 |
|   | 98C66204FBCF | 5713 | 65.75 | 19.75 | 30.5 | 25.75 | 250 | 33 |
| | 98C66204DBCD | 5713 | 65.75 | 19.75 | 30.5 | 25.75 | 246 | 33 |
| | 98C66244FBCF | 5807 | 65.75 | 23.75 | 30.5 | 25.75 | 263 | 38 |
| | 98C66244DBCD | 5807 | 65.75 | 23.75 | 30.5 | 25.75 | 259 | 38 |
| | 98C72204FBCF | 5980 | 71.75 | 19.75 | 30.5 | 25.75 | 266 | 36 |
| | 98C72204DBCD | 5980 | 71.75 | 19.75 | 30.5 | 25.75 | 262 | 36 |
| | 98C72244FBCF* | 6153 | 71.75 | 23.75 | 30.5 | 25.75 | 279 | 41 |
| | 98C72244DBCD | 6153 | 71.75 | 23.75 | 30.5 | 25.75 | 275 | 41 |
| | 98C84204FBCF | 6328 | 83.75 | 19.75 | 30.5 | 31.75 | 298 | 41 |
| | 98C84204DBCD | 6328 | 83.75 | 19.75 | 30.5 | 31.75 | 294 | 41 |
| | 98C84244FBCF** | 6498 | 83.75 | 23.75 | 30.5 | 31.75 | 311 | 48 |
| | 98C84244DBCD | 6498 | 83.75 | 23.75 | 30.5 | 31.75 | 307 | 48 |
|   | 98CC6624L4D | 3978 | 65.75 | 35.75 | 30.5 | 37.5 | 184 | 55 |
| | 98CC6624R4D | 3978 | 65.75 | 35.75 | 30.5 | 20.5 | 184 | 55 |
| | 98CC6624L4F | 3978 | 65.75 | 35.75 | 30.5 | 20.5 | 184 | 55 |
| | 98CC6624R4F | 3978 | 65.75 | 35.75 | 30.5 | 20.5 | 184 | 55 |
| | 98CC7224L4D* | 4071 | 71.75 | 35.75 | 30.5 | 20.5 | 202 | 60 |
| | 98CC7224R4D | 4071 | 71.75 | 35.75 | 30.5 | 20.5 | 202 | 60 |
| | 98CC7224L4F | 4071 | 71.75 | 35.75 | 30.5 | 20.5 | 202 | 60 |
| | 98CC7224R4F | 4071 | 71.75 | 35.75 | 30.5 | 20.5 | 202 | 60 |
| | 98CC7824L4D | 4118 | 77.75 | 35.75 | 30.5 | 20.5 | 210 | 64 |
| | 98CC7824R4D | 4118 | 77.75 | 35.75 | 30.5 | 20.5 | 210 | 64 |
| | 98CC7824L4F | 4118 | 77.75 | 35.75 | 30.5 | 20.5 | 210 | 64 |
| | 98CC7824R4F | 4118 | 77.75 | 35.75 | 30.5 | 20.5 | 210 | 64 |
| | 98CC8424L4D | 4162 | 83.75 | 35.75 | 30.5 | 20.5 | 218 | 69 |
| | 98CC8424R4D | 4162 | 83.75 | 35.75 | 30.5 | 20.5 | 218 | 69 |
| | 98CC8424L4F | 4162 | 83.75 | 35.75 | 30.5 | 20.5 | 218 | 69 |
| | 98CC8424R4F | 4162 | 83.75 | 35.75 | 30.5 | 20.5 | 218 | 69 |

ORDERING NOTES:

Corner credenzas allow for a 24" deep unit at the connecting end. Laminate worksurfaces are available at a 10% upcharge. For wire management cut out option on modesty panel add **\$194 list** upcharge. For hinged modesty panel add a 10% upcharge and insert Y after the C in the model number. e.g. 98CY7224LORF

DIMENSION KEY

W — width
D — depth
H — height of worksurface
KW— kneehole width

Dimensions are in inches and approximate.
Contact Customer Service if dimensions are critical.

*See page 5 for KrugExpress program.

CODE DESCRIPTION

0 - no pedestal
4 - full height pedestals
D - 2 file drawer
F - 2 box, 1 file drawer
L - left hand support position
R - right hand support position
CD - center drawer
OT - oversized top option
BT - bow top option
CC - corner credenza

STANDARD FINISHES

For a complete list of standard wood finishes please see page 577.

WIRING GROMMET

One rectangular black or one antique brass grommet in a standard position is optional at no charge. Please note grommet choice clearly on order form. Additional grommets are available at an upcharge of **\$152 list**.

STRATFORD | OVERHEADS

| Description | Model | Cherry Walnut | W | D | H | Doors | Shipping Weight | Cubic Feet |
|------------------------------------------------------------------------------------------------------------------------|------------|------------------|-------|----|----|-------|--------------------|---------------|
| Overheads with Wood Doors  * | 98OH3616* | 1844 | 35.75 | 16 | 16 | 2 | 53 | 8 |
| | 98OH4216 | 1960 | 41.75 | 16 | 16 | 2 | 57 | 9 |
| | 98OH4816 | 2037 | 47.75 | 16 | 16 | 3 | 77 | 10 |
| | 98OH5416 | 2205 | 53.75 | 16 | 16 | 4 | 81 | 11 |
| | 98OH6016 | 2377 | 59.75 | 16 | 16 | 4 | 88 | 12 |
| | 98OH6616** | 2506 | 65.75 | 16 | 16 | 4 | 94 | 13 |
| | 98OH7216 | 2638 | 71.75 | 16 | 16 | 4 | 99 | 14 |

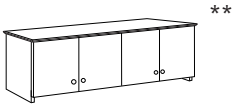

Tackboards Grades

| Description | Model | 1 | 2 | 3 | 4 | 5 | 6 | 7 | 8 | 9 | W | H | COM WT |
|--------------------------------------------------------------------------------------------------------------------------------|----------|-----|-----|-----|------|------|------|------|------|------|-------|----|---------|
| Tackboards for use with Overheads  | 98TBOH36 | 302 | 330 | 359 | 408 | 537 | 656 | 779 | 904 | 1179 | 34 | 26 | 1.5 11 |
| | 98TBOH42 | 313 | 339 | 368 | 412 | 537 | 651 | 766 | 886 | 1149 | 41.75 | 26 | 1.5 12 |
| | 98TBOH48 | 346 | 431 | 453 | 567 | 679 | 780 | 898 | 1033 | 1297 | 47.75 | 26 | 1.75 13 |
| | TBOH54 | 358 | 468 | 512 | 652 | 763 | 873 | 1006 | 1137 | 1396 | 55.75 | 26 | 1.75 14 |
| | TBOH60 | 391 | 522 | 552 | 688 | 822 | 978 | 1127 | 1285 | 1547 | 61.75 | 26 | 2 15 |
| | TBOH66 | 433 | 586 | 580 | 805 | 962 | 1149 | 1305 | 1487 | 1767 | 67.75 | 26 | 2 16 |
| | TBOH72 | 476 | 725 | 756 | 1002 | 1231 | 1245 | 1431 | 1636 | 1896 | 74.75 | 26 | 2.25 19 |

ORDERING PROCEDURES

To order, please specify the following:

- 1) Krug product model number
- 2) Wood species and finish, see page 577
- 4) Pull style and finish, see page 581
- 5) Grommet location and style if applicable

* Indicates model illustrated by line drawing

CODE DESCRIPTION

OH - overhead unit
W - includes power/data/voice grommet
G - includes glass doors
Z - includes grill doors
PM - paper manager
TBOH- tackboard for overhead

STANDARD FINISHES

For a complete list of standard wood finishes please see page 577.

OVERHEADS

All overheads include installed tasklights and mounting hardware. Contact customer service for information about flush units. Tackboards must be ordered separately.

STRATFORD | HUTCHES

| Description | Model | Cherry Walnut | | W | D | H | KW | Shipping Weight | Cubic Feet |
|-----------------------------------------------------------------------------------------------------------------|-------------|---------------|--|-------|----|----|------|-----------------|------------|
| | | | | | | | | | |
| 5-Hi Hutch with Wood Doors  | 98HT601640 | 3698 | | 59.75 | 16 | 40 | 23.5 | 150 | 26 |
| | 98HT661640* | 4044 | | 65.75 | 16 | 40 | 23.5 | 162 | 28 |
| | 98HT721640 | 4748 | | 71.75 | 16 | 40 | 23.5 | 174 | 31 |
| | 98HT781640 | 5033 | | 77.75 | 16 | 40 | 23.5 | 186 | 33 |
| | 98HT841640 | 5316 | | 83.75 | 16 | 40 | 23.5 | 200 | 36 |

| | | | | | | | | | |
|-----------------------------------------------------------------------------------------------------------------|-------------|------|--|-------|----|----|------|-----|----|
| 6-Hi Hutch with Wood Doors  | 98HT601653 | 4498 | | 59.75 | 16 | 53 | 23.5 | 200 | 34 |
| | 98HT661653* | 4994 | | 65.75 | 16 | 53 | 23.5 | 212 | 37 |
| | 98HT721653 | 5718 | | 71.75 | 16 | 53 | 23.5 | 224 | 41 |
| | 98HT781653 | 6153 | | 77.75 | 16 | 53 | 23.5 | 236 | 44 |
| | 98HT841653 | 6590 | | 83.75 | 16 | 53 | 23.5 | 250 | 47 |

ORDERING NOTES:

Hutches are inset 1-1/2" on each side when sitting on the worksurface. Locks are available on wood door hutches and overheads at **\$152 list** per set of (2) doors.

| | | | | | | | | | |
|-------------------------------------------------------------------------------------------------------------------|--------------|------|--|-------|----|----|------|-----|----|
| 6-Hi Hutch with Glass Doors  | 98HT601653G | 4764 | | 59.75 | 16 | 53 | 23.5 | 117 | 34 |
| | 98HT661653G* | 5292 | | 65.75 | 16 | 53 | 23.5 | 126 | 37 |
| | 98HT721653G | 6057 | | 71.75 | 16 | 53 | 23.5 | 135 | 41 |
| | 98HT781653G | 6522 | | 77.75 | 16 | 53 | 23.5 | 146 | 44 |
| | 98HT841653G | 6983 | | 83.75 | 16 | 53 | 23.5 | 154 | 47 |

ORDERING NOTES:

All shelves in glass door hutches are 1/4" thick glass. Hutches are inset 1-1/2" on each side when sitting on the worksurface.

| | | | | | | | | | |
|--------------------------------------------------------------------------------------------------------------------|--------------|------|--|-------|----|----|------|-----|----|
| 6-Hi Hutch with Grill Doors  | 98HT601653Z | 5421 | | 59.75 | 16 | 53 | 23.5 | 150 | 34 |
| | 98HT661653Z* | 5919 | | 65.75 | 16 | 53 | 23.5 | 162 | 37 |
| | 98HT721653Z | 6644 | | 71.75 | 16 | 53 | 23.5 | 174 | 41 |
| | 98HT781653Z | 7074 | | 77.75 | 16 | 53 | 23.5 | 186 | 44 |
| | 98HT841653Z | 7513 | | 83.75 | 16 | 53 | 23.5 | 200 | 47 |

ORDERING NOTES:

All shelves in grill door hutches are 1/4" thick glass. This Hutch includes a factory installed tasklight and a tackboard in Grade 1 fabric. Grill doors are NOT available on KrugExpress. Hutches are inset 1-1/2" on each side when sitting on the worksurface.

DIMENSION KEY

W — width
 D — depth
 H — height of worksurface
 KW — kneehole width

Dimensions are in inches and approximate. Contact Customer Service if dimensions are critical.

*See page 5 for KrugExpress program.

CODE DESCRIPTION

OH - overhead unit
 W - includes power/data/voice grommet
 G - includes glass doors
 Z - includes grill doors
 PM - paper manager
 TBOH- tackboard for overhead

STANDARD FINISHES

For a complete list of standard wood finishes please see page 577.

HUTCHES

Hutches include tasklights and a tackboard in grade 1 fabric. See page 603 for upcharges for grades 2-9.

STRATFORD | HUTCHES

| Description | Model | Cherry Walnut | | | | Shipping Weight | Cubic Feet |
|--------------------------------------------------|----------------|------------------|-------|----|----|--------------------|---------------|
| | | | W | D | H | | |
| 6-Hi Full Height Hutch with Clear Glass Doors | 98HT60165301G | 5242 | 59.75 | 16 | 53 | 200 | 34 |
| | 98HT66165301G* | 5821 | 65.75 | 16 | 53 | 212 | 37 |
| | 98HT72165301G | 6663 | 71.75 | 16 | 53 | 224 | 41 |
| | 98HT78165301G | 7174 | 77.75 | 16 | 53 | 232 | 44 |
| | 98HT84165301G | 7682 | 83.75 | 16 | 53 | 250 | 47 |

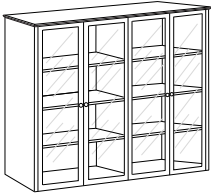

ORDERING NOTES:

All shelves in glass door hutches are 1/4" thick glass. Hutches are inset 1-1/2" on each side when sitting on the worksurface.

| | | | | | | | |
|--------------------------------------------|----------------|------|-------|----|----|-----|----|
| 6-Hi Full Height Hutch with Grill Doors | 98HT60165301Z | 6146 | 59.75 | 16 | 53 | 190 | 34 |
| | 98HT66165301Z* | 6510 | 65.75 | 16 | 53 | 202 | 37 |
| | 98HT72165301Z | 7305 | 71.75 | 16 | 53 | 212 | 41 |
| | 98HT78165301Z | 7785 | 77.75 | 16 | 53 | 222 | 44 |
| | 98HT84165301Z | 8262 | 83.75 | 16 | 53 | 240 | 47 |

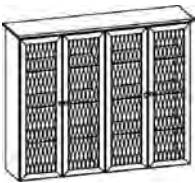

ORDERING NOTES:

All shelves in grill door hutches are 1/4" thick glass. Grill doors are NOT available on KrugExpress. Hutches are inset 1-1/2" on each side when sitting on the worksurface.

| | | | | | | | |
|----------------|--------------|------|------|----|------|----|---|
| Paper Managers | 98PM18132001 | 1786 | 16.5 | 13 | 19.5 | 15 | 4 |
|----------------|--------------|------|------|----|------|----|---|



ORDERING PROCEDURES

To order, please specify the following:

- 1) Krug product model number
- 2) Wood species and finish, see page 577
- 4) Pull style and finish, see page 581
- 5) Grommet location and style if applicable

* Indicates model illustrated by line drawing

CODE DESCRIPTION

OH - overhead unit
 W - includes power/data/voice grommet
 G - includes glass doors
 Z - includes grill doors
 PM - paper manager
 TBOH- tackboard for overhead

STANDARD FINISHES

For a complete list of standard wood finishes please see page 577.

HUTCHES

Hutches include tasklights and a tackboard in grade 1 fabric. See page 603 for upcharges for grades 2-9.

Hutch tackboard upgrade chart

Use this chart to find the upcharge for tackboard fabrics graded 2-9 and add it to the cost of the hutch. Fabric grades can be referenced on page 4.

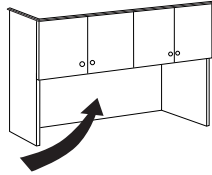

| | FABRIC GRADES | | | | | | | | | COM |
|------------------------------|---------------|---------------------------------|-----|------|------|------|------|------|------|-----|
| | 2 | 3 | 4 | 5 | 6 | 7 | 8 | 9 | | |
| 65" hutch tackboard | 137 | 294 | 426 | 568 | 705 | 842 | 981 | 1282 | 2 | |
| 71" hutch tackboard | 154 | 333 | 485 | 643 | 803 | 955 | 1107 | 1332 | 2.25 | |
| 78" hutch tackboard | 183 | 391 | 580 | 777 | 957 | 1141 | 1279 | 1634 | 2.5 | |
| 84" hutch tackboard | 220 | 464 | 729 | 959 | 1199 | 1403 | 1508 | 1813 | 2.5 | |
| 91" hutch tackboard | 259 | 537 | 794 | 1053 | 1306 | 1402 | 1818 | 2126 | 2.75 | |
| Pot light option for Hutches | 567 | Per hutch (includes two lights) | | | | | | | | |

ORDERING NOTES :

The factory installed pot light option is available on any glass door or grill door hutch. The two lights are mounted through the hutch top and activated by a switch located on the light inside the case. Please add the upcharge shown above to hutch price and specify pot light option on your order. This item is not available on KrugExpress.

On single piece hutches, the yardage requirement for two tackboards is the same as for one tackboard. Please keep this in mind when ordering more than one tackboard. For example, if the number of tackboards required is 7 and the COM requirement for 1 tackboard is 1.5 yards, the calculation for COM yardage is as follows: 4.5 yards are required for 6 tackboards + 1.5 yards for the 7th tackboard for a total of 6 yards. In the case of an even number of tackboards, divide the number of tackboards required by 2 and multiply that number by the COM requirement on the chart. The fabric must be at least 54" wide in order to qualify for this procedure. If the fabric is less than 54" wide, the COM yardage listed on the chart is the amount required for each tackboard.

COM yardage Calculation Chart of Tackboards

| Quantity of Tackboards Required (example: 60") | Number of yards Required per Tackboard (example: 60") | Number of yards Required in Total (example: 60") |
|------------------------------------------------|-------------------------------------------------------|--------------------------------------------------|
| one | 2 yards | 2 |
| two | 2 yards | 2 |
| three | 2 yards | 4 |
| four | 2 yards | 4 |
| fiv | 2 yards | 6 |
| six | 2 yards | 6 |
| seven | 2 yards | 8 |
| eight | 2 yards | 8 |
| nine | 2 yards | 10 |
| ten | 2 yards | 10 |

DIMENSION KEY

W — width
 D — depth
 H — height of worksurface
 KW— kneehole width

Dimensions are in inches and approximate.
 Contact Customer Service if dimensions are critical.

*See page 5 for KrugExpress program.

CODE DESCRIPTION

PM — paper manager

STRATFORD | KEYBOARDS & PENCIL DRAWERS

| Description | Model | Cherry Walnut | W | D | H | Shipping Weight | Cubic Feet |
|-----------------------------------------------------------------------------|-------------|---------------|---|---|---|-----------------|------------|
| Articulating Keyboard Tray with Palm Rest and Mouse Tray/Extended Mechanism | 98KBAMT1912 | 694 | - | - | - | 20 | 2 |



ORDERING NOTES:

This unit comes with a lever free arm keyboard support. This unit is a granite color.

| | | | | | | | |
|---------------|----------|-----|---|---|---|---|---|
| Pencil Drawer | 98PD2116 | 589 | - | - | - | 2 | 1 |
|---------------|----------|-----|---|---|---|---|---|



| | | | | | | | |
|-----------------------|--------|-----|---|---|---|---|---|
| Wire Management Cover | 98WM72 | 157 | - | - | - | 3 | 7 |
|-----------------------|--------|-----|---|---|---|---|---|



| | | | | | | | |
|------------------------|-------|----|---|---|---|---|---|
| Velcro Wire Management | 98WM4 | 33 | - | - | - | 1 | 1 |
|------------------------|-------|----|---|---|---|---|---|



| | | | | | | | |
|-------------------|--------|-----|---|---|---|---|---|
| Power Data Module | 98PDVM | 252 | - | - | - | 1 | 1 |
|-------------------|--------|-----|---|---|---|---|---|



ORDERING NOTES:

This grommet is only available in black.

ORDERING PROCEDURES

To order, please specify the following:

- 1) Krug product model number
- 2) Wood species and finish, see page 577
- 4) Pull style and finish, see page 581
- 5) Grommet location and style if applicable

* Indicates model illustrated by line drawing

CODE DESCRIPTION

PD - pencil drawer
 WM - wire management
 PDVM - power/data/voice grommet

STANDARD FINISHES

For a complete list of standard wood finishes please see page 577.

BRASS FINISH

Standard grommets and pop-up grommets are available in black or brass finishes.

STRATFORD | MODULAR COMPONENTS

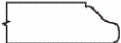
| Description | Model | Cherry | | W | D | H | Shipping Weight | Cubic Feet |
|------------------------------------------------------------------------------------------------------------------------------------------------------------------------|-------------------------------|-----------|-------|-------|-------|-------|-----------------|------------|
| | | Walnut | | | | | | |
|   | Tops for 2-Hi Modular Storage | 98TP6020 | 1178 | 59.75 | 19.75 | 29.25 | 45 | 2 |
| | | 98TP6024 | 1244 | 59.75 | 23.75 | 1.25 | 52 | 2 |
| | | 98TP6320 | 1270 | 62.75 | 19.75 | 1.25 | 48 | 2 |
| | | 98TP6324 | 1286 | 62.75 | 23.75 | 1.25 | 51 | 3 |
| | | 98TP6620* | 1305 | 65.75 | 19.75 | 1.25 | 53 | 3 |
| | | 98TP6624 | 1363 | 65.75 | 23.75 | 1.25 | 61 | 3 |
| | | 98TP6920 | 1386 | 68.75 | 19.75 | 1.25 | 57 | 3 |
| | | 98TP6924 | 1412 | 68.75 | 23.75 | 1.25 | 61 | 3 |
| | | 98TP7220 | 1425 | 71.75 | 19.75 | 1.25 | 63 | 3 |
| | | 98TP7224 | 1479 | 71.75 | 23.75 | 1.25 | 65 | 3 |
| | | 98TP7520 | 1488 | 74.75 | 19.75 | 1.25 | 67 | 3 |
| | | 98TP7524 | 1524 | 74.75 | 23.75 | 1.25 | 70 | 3 |
| | | 98TP7820 | 1537 | 77.75 | 19.75 | 1.25 | 71 | 3 |
| | | 98TP7824 | 1592 | 77.75 | 23.75 | 1.25 | 73 | 3 |
| | | 98TP8420 | 1642 | 83.75 | 19.75 | 1.25 | 76 | 3 |
| | | 98TP8424 | 1691 | 83.75 | 23.75 | 1.25 | 78 | 4 |
| | | 98TP9020 | 1741 | 89.75 | 19.75 | 1.25 | 81 | 3 |
| | | 98TP9024 | 1789 | 89.75 | 23.75 | 1.25 | 86 | 4 |
| | | 98TP9220 | 1803 | 91.75 | 19.75 | 1.25 | 85 | 3 |
| | | 98TP9224 | 1828 | 91.75 | 23.75 | 1.25 | 89 | 4 |
| | 98TP9620 | 1835 | 95.75 | 19.75 | 1.25 | 88 | 4 | |
| | 98TP9624 | 1887 | 95.75 | 23.75 | 1.25 | 92 | 4 | |

ORDERING NOTES:

A half gable is required on any open span greater than 48" that does not have a modesty panel. Standard 98TP tops have profile on the ee sides. They are designed to be flush on the back edge

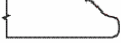
| Description | Model | Cherry | | W | D | H | Shipping Weight | Cubic Feet |
|----------------------------------------------------------------------------------------------------------------------------------------------------------------------------|-------------------------|-------------|------|-------|-------|------|-----------------|------------|
| | | Walnut | | | | | | |
|   | Tops with one Coved End | 98TPR6020L | 1178 | 59.75 | 19.75 | 1.25 | 45 | 2 |
| | | 98TPR6020R | 1178 | 59.75 | 19.75 | 1.25 | 45 | 2 |
| | | 98TPR6024L | 1244 | 59.75 | 23.75 | 1.25 | 52 | 3 |
| | | 98TPR6024R | 1244 | 59.75 | 23.75 | 1.25 | 52 | 3 |
| | | 98TPR6620L | 1305 | 65.75 | 19.75 | 1.25 | 53 | 3 |
| | | 98TPR6620R* | 1305 | 65.75 | 19.75 | 1.25 | 53 | 3 |
| | | 98TPR6624L | 1363 | 65.75 | 23.75 | 1.25 | 61 | 3 |
| | | 98TPR6624R | 1363 | 65.75 | 23.75 | 1.25 | 61 | 3 |
| | | 98TPR7220L | 1425 | 71.75 | 19.75 | 1.25 | 63 | 3 |
| | | 98TPR7220R | 1425 | 71.75 | 19.75 | 1.25 | 63 | 3 |
| | | 98TPR7224L | 1479 | 71.75 | 23.75 | 1.25 | 65 | 3 |
| | | 98TPR7224R | 1479 | 71.75 | 23.75 | 1.25 | 65 | 3 |

ORDERING NOTES:

A half gable is required on any open span greater than 48" that does not have a modesty panel. Standard 98TP tops have profile on the ee sides. They are designed to be flush on the back edge

DIMENSION KEY

W — width
D — depth
H — height of worksurface
KW— kneehole width

Dimensions are in inches and approximate. Contact Customer Service if dimensions are critical.

*See page 5 for KrugExpress program.

CODE DESCRIPTION

TP - modular top with standard profile
TPR - modular top for run-offs with one coved connecting end
TPI - modular top with inverted profile
ST - freestanding storage
STM - modular storage
WRM - modular wardrobe
G - includes glass doors
D - 2 file drawer
F - 2 box, 1 file drawer



OPEN SPANS

It is not recommended that modular units be combined together to create open spans greater than 60".

STORAGE

Freestanding storage has finished, profiled tops and base molding on three sides. Modular storage does not have finished tops (they must be ordered separately) and base molding is only across the front.

STRATFORD | MODULAR COMPONENTS

| Description | Model | Cherry Walnut | W | D | H | Shipping Weight | Cubic Feet |
|-----------------------------------------------------------------------------------|-------------|------------------|-------|-------|------|--------------------|---------------|
| Tops with one Coved End, Continued | 98TPR7820L | 1537 | 77.75 | 19.75 | 1.25 | 71 | 3 |
|  | 98TPR7820R | 1537 | 77.75 | 19.75 | 1.25 | 71 | 3 |
| | 98TPR7824L | 1592 | 77.75 | 23.75 | 1.25 | 73 | 3 |
| | 98TPR7824R | 1592 | 77.75 | 23.75 | 1.25 | 73 | 3 |
|  | 98TPR8420L | 1642 | 83.75 | 19.75 | 1.25 | 76 | 3 |
| | 98TPR8420R | 1642 | 83.75 | 19.75 | 1.25 | 76 | 3 |
| | 98TPR8424L* | 1691 | 83.75 | 23.75 | 1.25 | 78 | 4 |
| | 98TPR8424R | 1691 | 83.75 | 23.75 | 1.25 | 78 | 4 |
| | 98TPR9020L | 1741 | 89.75 | 19.75 | 1.25 | 81 | 3 |
| | 98TPR9020R | 1741 | 89.75 | 19.75 | 1.25 | 86 | 3 |
| | 98TPR9024L | 1789 | 89.75 | 23.75 | 1.25 | 86 | 4 |
| | 98TPR9024R | 1789 | 89.75 | 23.75 | 1.25 | 86 | 4 |
| | 98TPR9620L | 1835 | 95.75 | 19.75 | 1.25 | 88 | 4 |
| | 98TPR9620R | 1835 | 95.75 | 19.75 | 1.25 | 88 | 4 |
| | 98TPR9624L | 1887 | 95.75 | 23.75 | 1.25 | 92 | 4 |
| | 98TPR9624R | 1887 | 95.75 | 23.75 | 1.25 | 92 | 4 |

ORDERING NOTES:

A half gable is required on any open span greater than 48" that does not have a modesty panel. Standard 98TP tops have profile on the e sides. They are designed to be flush on the back edge

| Modular Pedestal | Model | | W | D | H | Shipping Weight | Cubic Feet |
|------------------------------------------------------------------------------------|---------------|------|-------|-------|-------|--------------------|---------------|
| | 98P1620304D** | 1834 | 15.75 | 19.75 | 29.25 | 68 | 6 |
| | 98P1624304D | 1974 | 15.75 | 23.75 | 29.25 | 73 | 8 |
|  | 98P1620304F* | 1966 | 15.75 | 19.75 | 29.25 | 70 | 6 |
| | 98P1624304F | 2106 | 15.75 | 23.75 | 29.25 | 75 | 8 |

ORDERING NOTES:

Modular storage units do not have finished tops and are intended to be combined with 98TP tops. Modular storage unit backs are finished. It is not recommended that modular units be combined together to create open spans greater than 60".

ORDERING PROCEDURES

To order, please specify the following:

- 1) Krug product model number
- 2) Wood species and finish, see page 577
- 4) Pull style and finish, see page 581
- 5) Grommet location and style if applicable

* Indicates model illustrated by line drawing

CODE DESCRIPTION

TP - modular top with standard profile
 TPR - modular top for run-offs with one coved connecting end
 TPI - modular top with inverted profile
 ST - freestanding storage
 STM - modular storage
 WRM - modular wardrobe
 G - includes glass doors
 D - 2 file drawer
 F - 2 box, 1 file drawer

STANDARD FINISHES

For a complete list of standard wood finishes please see page 577.

STORAGE

Freestanding storage has finished, profiled tops and base molding on three sides. Modular storage does not have finished tops (they must be ordered separately) and base molding is only across the front.

STRATFORD | MODULAR COMPONENTS

| Description | Model | Cherry | | W | D | H | Shipping Weight | Cubic Feet |
|------------------|----------------|--------|--|-------|-------|-------|-----------------|------------|
| | | Walnut | | | | | | |
| Modular Bookcase | 98STM30203011 | 2096 | | 29.75 | 19.75 | 29.25 | 105 | 13 |
| Pedestal | 98STM36203011 | 2232 | | 35.75 | 19.75 | 29.25 | 109 | 15 |
| | 98STM30243011* | 2163 | | 29.75 | 19.75 | 29.25 | 113 | 15 |
| | 98STM36243011 | 2304 | | 35.75 | 19.75 | 29.25 | 117 | 18 |

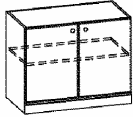

ORDERING NOTES:

Modular storage units do not have finished tops and are intended to be combined with 98TP tops. Modular storage unit backs are finished. Locks may be added to the bookcase doors at a **\$152 list upcharge**.

| | | | | | | | | |
|----------------------|----------------|------|--|-------|-------|-------|-----|----|
| Modular Lateral File | 98STM30203001 | 2504 | | 29.75 | 19.75 | 29.25 | 113 | 13 |
| Pedestal | 98STM36203001 | 2642 | | 35.75 | 19.75 | 29.25 | 117 | 15 |
| | 98STM30243001* | 2576 | | 29.75 | 19.75 | 29.25 | 121 | 15 |
| | 98STM36243001 | 2718 | | 35.75 | 19.75 | 29.25 | 129 | 18 |



ORDERING NOTES:

Modular storage units do not have finished tops and are intended to be combined with 98TP tops. Modular storage unit backs are finished.

| | | | | | | | | |
|------------|----------|-----|--|----|----|----|----|---|
| Half Gable | 98HG2710 | 443 | | 10 | 27 | 27 | 11 | 1 |
| | 98HG2716 | 507 | | 16 | 27 | 27 | 16 | 1 |

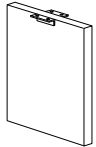

ORDERING NOTES:

This unit should be ordered to center-support open spans greater than 60". Use 98HG2710 with 20" & 24" deep cases and 98HG2716 with 30" deep cases.

| | | | | | | | | |
|---------------------------|------------|-----|--|----|-------|-------|----|---|
| Modular End Panel Support | 98LB2030L | 827 | | 12 | 19.75 | 29.25 | 35 | 2 |
| | 98LB2430L* | 869 | | 12 | 23.75 | 29.25 | 37 | 2 |
| | 98LB2030R | 827 | | 12 | 19.75 | 29.25 | 35 | 2 |
| | 98LB2430R | 869 | | 12 | 23.75 | 29.25 | 37 | 2 |

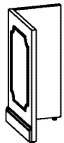

| | | | | | | | | |
|------------------------------|----------|-----|--|------|---|------|----|---|
| Modular Hinged Modesty Panel | 98MPY72 | 837 | | 37.5 | - | 30.5 | 42 | 3 |
| | 98MPY78* | 871 | | 43.5 | - | 30.5 | 50 | 3 |
| | 98MPY84 | 898 | | 49.5 | - | 30.5 | 60 | 3 |

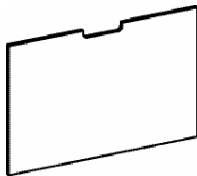

DIMENSION KEY

W — width
D — depth
H — height of worksurface
KW— kneehole width

Dimensions are in inches and approximate. Contact Customer Service if dimensions are critical.

*See page 5 for KrugExpress program.

CODE DESCRIPTION

TP - modular top with standard profile
TPR - modular top for run-offs with one coved connecting end
TPI - modular top with inverted profile
ST - freestanding storage
STM - modular storage
WRM - modular wardrobe
G - includes glass doors
D - 2 file drawer
F - 2 box, 1 file drawer

STANDARD FINISHES

For a complete list of standard wood finishes please see page 577.

STORAGE

Freestanding storage has finished, profiled tops and base molding on three sides. Modular storage does not have finished tops (they must be ordered separately) and base molding is only across the front.

STRATFORD | MODULAR COMPONENTS

Ordering modular storage with 98TP tops

30" high modular storage units are created by combining 98TP modular tops and modular bases. The top profile on a 98TP matches that of all other 30" high Stratford products including desks and credenzas. For example:

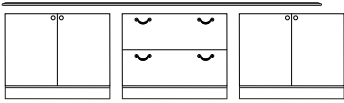

One 98TP-9224 modular top.
Two 98STM-302430-11 modular bookcase pedestals.
One 98STM-302430-01 modular lateral file pedestal

The modular components can be used together to create a variety of custom storage.

Ordering modular storage with 98TPR tops

30" high modular run-off units are created by combining 98TPR modular tops and modular bases. For example:



One 98TPR-6624 modular top.
One 98STM-302430-01 modular lateral file pedestal. One 98P-162430-4F modular B/B/F pedestal.

The modular components can be used together to create a variety of custom run-off units.

Modular Top and Storage Flush Combinations

Use this guide of recommendations to create flush units with modular tops and storage

| TOP SIZE | PEDESTAL COMBINATIONS THAT FIT FLUSH | LEFT/RIGHT OVERHANG |
|----------|--------------------------------------|---------------------|
|----------|--------------------------------------|---------------------|

2-hi modular storage

| | | |
|---------|----------------------------------------|--------|
| 98TP-63 | (2) 30" wide pedestals | 1 1/2" |
| 98TP-69 | (1) 30" wide pedestal and (1) 36" wide | 1 1/2" |
| 98TP-75 | pedestal (2) 36" wide pedestals | 1 1/2" |
| 98TP-92 | (3) 30" wide pedestals | 1 1/2" |

ORDERING PROCEDURES

To order, please specify the following:

- 1) Krug product model number
- 2) Wood species and finish, see page 577
- 4) Pull style and finish, see page 581
- 5) Grommet location and style if applicable

* Indicates model illustrated by line drawing

STRATFORD | MODULAR COMPONENTS

| Description | Model | Cherry Walnut | W | D | H | Shipping Weight | Cubic Feet |
|--------------------------------|----------|------------------|-------|----|------|--------------------|---------------|
| Top for 2-Hi Modular Bookcases | 98TP7516 | 1193 | 74.75 | 16 | 1.25 | 55 | 2 |

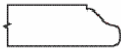

| | | | | | | | |
|-----------------------|-------------|------|-------|----|-------|----|----|
| 2-Hi Modular Bookcase | 98BCM361630 | 1579 | 35.75 | 16 | 29.25 | 91 | 12 |
|-----------------------|-------------|------|-------|----|-------|----|----|



ORDERING NOTES:
Modular bookcases do not have finished tops and are intended to be combined with 98TP tops.

Ordering modular bookcases with 98TP tops
30" high modular bookcases can be created by combining modular tops and bookcase units.



One 98TP-7516 modular top.
Two 98BCM-3616-30 modular bookcases.

The modular components can be used together to create custom storage.

DIMENSION KEY

W — width
D — depth
H — height of worksurface
KW— kneehole width

Dimensions are in inches and approximate.
Contact Customer Service if dimensions are critical.

*See page 5 for KrugExpress program.

CODE DESCRIPTION

G - includes glass doors
BC - bookcase
BCM- modular bookcase
TPI- modular bookcase top

STANDARD FINISHES

For a complete list of standard wood finishes please see page 577.

STRATFORD | MODULAR COMPONENTS

| Description | Model | Cherry Walnut | | | | Shipping Weight | Cubic Feet |
|-------------------------------------------------------------------------------------------------------------------|----------------|------------------|-------|-------|------|--------------------|---------------|
| | | | W | D | H | | |
| 3-Hi Modular Bookcase Tops  | 98TPI6216-3HI | 1181 | 59.75 | 15.75 | 1.25 | 43 | 3 |
| | 98TPI7416-3HI | 1193 | 72.75 | 15.75 | 1.25 | 51 | 3 |
| | 98TPI9216-3HI* | 1199 | 89.75 | 15.75 | 1.25 | 79 | 4 |
| | 98TPI9716-3HI | 1210 | 95.75 | 15.75 | 1.25 | 92 | 4 |

| | | | | | | | |
|-------------------------------|-------------|------|-------|-------|-------|-----|----|
| 3-Hi Modular Bookcase Tops | 98PRM301640 | 1746 | 29.5 | 15.75 | 39.25 | 120 | 22 |
| | 98PRM361640 | 1789 | 35.75 | 15.75 | 39.25 | 135 | 26 |

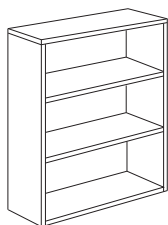

| | | | | | | | |
|-----------------------------------------------|---------------|------|-------|-------|-------|-----|----|
| 3-Hi Modular Closed Bookcase Pier, No Base | 98PRM30164011 | 2096 | 29.5 | 15.75 | 39.25 | 135 | 22 |
| | 98PRM36164011 | 2172 | 35.75 | 15.75 | 39.25 | 150 | 26 |

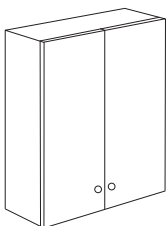

ORDERING PROCEDURES

To order, please specify the following:

- 1) Krug product model number
- 2) Wood species and finish, see page 577
- 4) Pull style and finish, see page 581
- 5) Grommet location and style if applicable

* Indicates model illustrated by line drawing

CODE DESCRIPTION

0 - no pedestal
 4 - full height pedestals
 D - 2 file drawer
 F - 2 box, 1 file drawer
 L - left hand support position
 R - right hand support position
 CD - center drawer
 OT - oversized top option
 BT - bow top option
 CC - corner credenza

STANDARD FINISHES

For a complete list of standard wood finishes please see page 577.

STORAGE

Freestanding storage has finished, profiled tops and base molding on three sides. Modular storage does not have finished tops (they must be ordered separately) and base molding is only across the front.

STRATFORD | MODULAR COMPONENTS

| Description | Model | Cherry Walnut | | W | D | H | Shipping Weight | Cubic Feet |
|--------------------------------|-----------|---------------|--|-------|----|------|-----------------|------------|
| | | | | | | | | |
| Top for 5-Hi Modular Bookcases | 98TPI7416 | 1193 | | 73.75 | 16 | 1.25 | 55 | 2 |



ORDERING NOTES:

This bookcase has a 1" overhang on the left and right sides. There is no overhang on the back edge. Profile of 98TPI tops are inverted.

| | | | | | | | | |
|-----------------------|-------------|------|--|-------|----|-------|-----|----|
| 5-Hi Modular Bookcase | 98BCM361671 | 2168 | | 35.75 | 16 | 69.75 | 158 | 27 |
|-----------------------|-------------|------|--|-------|----|-------|-----|----|



ORDERING NOTES:

Modular bookcases do not have finished tops and are intended to be combined with 98TP tops.

Ordering modular bookcases with 98TPI tops

71" high modular bookcases can be created by combining modular tops and bookcase units.

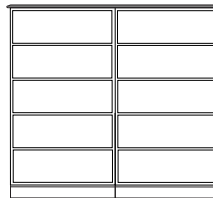
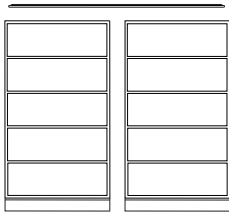

One 98TPI-7416 modular top.
Two 98BCM-3616-71 modular bookcases.

The modular components can be used together to create custom storage.

DIMENSION KEY

W — width
D — depth
H — height of worksurface
KW— kneehole width

Dimensions are in inches and approximate. Contact Customer Service if dimensions are critical.

*See page 5 for KrugExpress program.

CODE DESCRIPTION

G - includes glass doors
BC - bookcase
BCM- modular bookcase
TPI- modular bookcase top

STANDARD FINISHES

For a complete list of standard wood finishes please see page 577.

WIRING GROMMET

One rectangular grommet in a standard position is optional at no charge. Additional rectangular grommets are available at an upcharge of **\$152 list**.

STRATFORD | MODULAR COMPONENTS

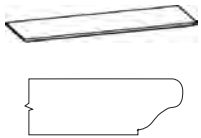
| Description | Model | Cherry | | W | D | H | Shipping Weight | Cubic Feet |
|----------------------------------------------------------------------------------|------------|--------|--|-------|-------|------|-----------------|------------|
| | | Walnut | | | | | | |
|  | 98TPI6220 | 1178 | | 61.75 | 19.75 | 1.25 | 45 | 2 |
| | 98TPI6224 | 1244 | | 61.75 | 23.75 | 1.25 | 52 | 2 |
| | 98TPI6820 | 1305 | | 67.75 | 19.75 | 1.25 | 53 | 3 |
| | 98TPI6824 | 1363 | | 67.75 | 23.75 | 1.25 | 61 | 3 |
| | 98TPI7420* | 1425 | | 73.75 | 19.75 | 1.25 | 63 | 3 |
| | 98TPI7424 | 1479 | | 73.75 | 23.75 | 1.25 | 65 | 3 |
| | 98TPI9220 | 1741 | | 91.75 | 19.75 | 1.25 | 71 | 3 |
| | 98TPI9224 | 1789 | | 91.75 | 23.75 | 1.25 | 73 | 3 |

ORDERING NOTES:

Profile of 98TPI tops are inverted.

Ordering modular storage with 98TPI tops

71 high modular storage units are created by combining 98TPI modular tops and modular bases.

The top profile on a 98TPI matches that of all other 71 high Stratford products including hutches and freestanding storage. For example:



One 98TPI-7424 modular top.
One 98STM-362471-04G modular storage. One 98STM-362471-04 modular storage.

The modular components can be used together to create a variety of custom storage.

Modular Top and Storage Flush Combinations

Use this guide of recommendations to create flush units with modular tops and storage.

| TOP SIZE | PEDESTAL COMBINATIONS THAT FIT FLUSH | LEFT/RIGHT OVERHANG |
|----------------------|------------------------------------------------|---------------------|
| 5-hi modular storage | | |
| 98TPI-62 | (2) 30 wide pedestals | 1 |
| 98TPI-68 | (2) 30 wide pedestals and (1) 36 wide pedestal | 1 |
| 98TPI-74 | (2) 36 wide pedestals | 1 |
| 98TPI-92 | (3) 30 wide pedestals | 1 |

Pot light option for modular storage

Upcharge 689

The factory installed pot light option is available on any glass door or grill door modular storage unit at an upcharge of **\$689**.

The light is mounted through the top of the storage unit and the modular top and activated by a switch located on the light inside the case.

Please add the upcharge shown to storage price and specify pot light option on your order.

A drawing showing assembled configuration of all modular storage must be provided when ordering the pot light option to accurately determine grommet locations.

ORDERING PROCEDURES

To order, please specify the following:

- 1) Krug product model number
- 2) Wood species and finish, see page 577
- 4) Pull style and finish, see page 581
- 5) Grommet location and style if applicable

* Indicates model illustrated by line drawing

CODE DESCRIPTION

TP - modular top with standard profile
 TPR - modular top for run-offs with one coved connecting end
 TPI - modular top with inverted profile
 ST - freestanding storage
 STM - modular storage
 WRM - modular wardrobe
 G - includes glass doors
 D - 2 file drawer
 F - 2 box, 1 file drawer

STANDARD FINISHES

For a complete list of standard wood finishes please see page 577.

STORAGE

Freestanding storage has finished, profiled tops and base molding on three sides. Modular storage does not have finished tops (they must be ordered separately) and base molding is only across the front.

STRATFORD | MODULAR COMPONENTS

| Description | Model | Cherry Walnut | | W | D | H | Shipping Weight | Cubic Feet |
|---------------------------------|----------------|---------------|--|-------|-------|------|-----------------|------------|
| | | | | | | | | |
| 2 Lateral Files, 3 Open Shelves | 98STM30207103 | 4527 | | 29.75 | 19.75 | 70.5 | 198 | 28 |
| | 98STM36207103 | 4638 | | 35.75 | 19.75 | 70.5 | 208 | 34 |
| | 98STM30247103* | 4584 | | 29.75 | 23.75 | 70.5 | 208 | 34 |
| | 98STM36247103 | 4698 | | 35.75 | 23.75 | 70.5 | 218 | 40 |

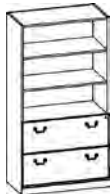

ORDERING NOTES:

Modular storage units do not have finished tops and are intended to be combined with 98TP tops. Modular storage unit backs are finished

| | | | | | | | | |
|----------------------------------|----------------|------|--|-------|-------|------|-----|----|
| 2 Lateral File, 3 Closed Shelves | 98STM30207104 | 5064 | | 29.75 | 19.75 | 70.5 | 206 | 28 |
| | 98STM36207104 | 5181 | | 35.75 | 19.75 | 70.5 | 216 | 34 |
| | 98STM30247104* | 5117 | | 29.75 | 23.75 | 70.5 | 216 | 34 |
| | 98STM36247104 | 5241 | | 35.75 | 23.75 | 70.5 | 226 | 40 |



ORDERING NOTES:

Modular storage units do not have finished tops and are intended to be combined with 98TP tops. Modular storage unit backs are finished

| | | | | | | | | |
|---------------------------------------------|-----------------|------|--|-------|-------|------|-----|----|
| 2 Lateral Files, 3 Closed Clear Glass Doors | 98STM30207104G | 5343 | | 29.75 | 19.75 | 70.5 | 216 | 28 |
| | 98STM36207104G | 5457 | | 35.75 | 19.75 | 70.5 | 226 | 34 |
| | 98STM30247104G* | 5394 | | 29.75 | 23.75 | 70.5 | 226 | 34 |
| | 98STM36247104G | 5518 | | 35.75 | 23.75 | 70.5 | 236 | 40 |

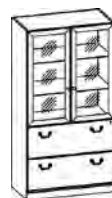

ORDERING NOTES:

All shelves in glass door bookcases are 1/4" thick glass. Modular pedestals do not have finished tops and are intended to be combined with 98TP tops. Modular pedestal backs are finished. This item is NOT available on KrugExpress.

DIMENSION KEY

W — width
D — depth
H — height of worksurface
KW— kneehole width

Dimensions are in inches and approximate. Contact Customer Service if dimensions are critical.

*See page 5 for KrugExpress program.

CODE DESCRIPTION

TP - modular top with standard profile
TPR - modular top for run-offs with one coved connecting end
TPI - modular top with inverted profile
ST - freestanding storage
STM - modular storage
WRM - modular wardrobe
G - includes glass doors
D - 2 file drawer
F - 2 box, 1 file drawer

STANDARD FINISHES

For a complete list of standard wood finishes please see page 577.

STORAGE

Freestanding storage has finished, profiled tops and base molding on three sides. Modular storage does not have finished tops (they must be ordered separately) and base molding is only across the front.

STRATFORD | MODULAR COMPONENTS

| Description | Model | Cherry | | W | D | H | Shipping Weight | Cubic Feet |
|---------------------------------------|-----------------|--------|--|-------|-------|------|-----------------|------------|
| | | Walnut | | | | | | |
| 2 Lateral Files, 3 Closed Grill Doors | 98STM30207104Z | 6268 | | 29.75 | 19.75 | 70.5 | 206 | 28 |
| | 98STM36207104Z | 6385 | | 35.75 | 19.75 | 70.5 | 216 | 34 |
| | 98STM30247104Z* | 6319 | | 29.75 | 23.75 | 70.5 | 216 | 34 |
| | 98STM36247104Z | 6441 | | 35.75 | 23.75 | 70.5 | 226 | 40 |

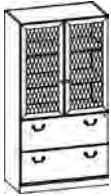

ORDERING NOTES:

All shelves in glass door bookcases are 1/4" thick glass. Modular pedestals do not have finished tops and are intended to be combined with 98TP tops. Modular pedestal backs are finished. This item is NOT available on KrugExpress.

| | | | | | | | | |
|------------------|----------------|------|--|-------|-------|------|-----|----|
| 5 Closed Shelves | 98STM30207111 | 4242 | | 29.75 | 19.75 | 70.5 | 225 | 28 |
| | 98STM30247111 | 4224 | | 29.75 | 19.75 | 70.5 | 235 | 34 |
| | 98STM36207111* | 4287 | | 35.75 | 23.75 | 70.5 | 245 | 34 |
| | 98STM36247111 | 4341 | | 35.75 | 23.75 | 70.5 | 255 | 40 |



ORDERING NOTES:

Modular storage units do not have finished tops and are intended to be combined with 98TP tops. Modular storage unit backs are finished

| | | | | | | | | |
|----------------------------------------------|----------------|------|--|-------|-------|------|-----|----|
| 5 Closed Shelves Left, Closed Wardrobe Right | 98WRM30247101 | 3931 | | 29.75 | 19.75 | 70.5 | 225 | 34 |
| | 98WRM36247101* | 4086 | | 35.75 | 23.75 | 70.5 | 245 | 40 |

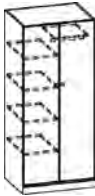

ORDERING NOTES:

Modular storage units do not have finished tops and are intended to be combined with 98TP tops. Modular storage unit backs are finished

ORDERING PROCEDURES

To order, please specify the following:

- 1) Krug product model number
- 2) Wood species and finish, see page 577
- 4) Pull style and finish, see page 581
- 5) Grommet location and style if applicable

* Indicates model illustrated by line drawing

CODE DESCRIPTION

TP - modular top with standard profile
 TPR - modular top for run-offs with one coved connecting end
 TPI - modular top with inverted profile
 ST - freestanding storage
 STM - modular storage
 WRM - modular wardrobe
 G - includes glass doors
 D - 2 file drawer
 F - 2 box, 1 file drawer

STANDARD FINISHES

For a complete list of standard wood finishes please see page 577.

STORAGE

Freestanding storage has finished, profiled tops and base molding on three sides. Modular storage does not have finished tops (they must be ordered separately) and base molding is only across the front.

STRATFORD | BOOKCASES

| Description | Model | Cherry Walnut | W | D | H | Shipping Weight | Cubic Feet |
|-------------|------------|---------------|-------|----|------|-----------------|------------|
| 2-Hi Open | 98BC361630 | 1967 | 35.75 | 16 | 30.5 | 91 | 12 |

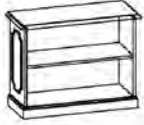

ORDERING NOTES:

This 30.25" high bookcase has a 1-1/2" overhang on the left and right sides. There is no overhang on the back edge.

| | | | | | | | |
|-----------------------------|---------------|------|-------|----|------|-----|----|
| 2-Hi with Clear Glass Doors | 98BC36163011G | 2085 | 35.75 | 16 | 30.5 | 101 | 12 |
|-----------------------------|---------------|------|-------|----|------|-----|----|



ORDERING NOTES:

This 30.25" high bookcase has a 1-1/2" overhang on the left and right sides. There is no overhang on the back edge. The glass shelf is 1/4" thick and adjustable. This item is NOT available on KrugExpress.

| | | | | | | | |
|---------------|-------------|------|-------|----|------|-----|----|
| Open Bookcase | 98BC361657 | 2497 | 35.75 | 16 | 57 | 115 | 22 |
| | 98BC361671* | 2707 | 35.75 | 16 | 70.5 | 166 | 27 |



ORDERING NOTES:

This bookcase has a 1" overhang on the left and right sides. There is no overhang on the back edge.

| | | | | | | | |
|----------------|-----------|------|-------|-------|------|----|----|
| Computer Stand | 98TH3624 | 2763 | 35.75 | 23.75 | 30.5 | 61 | 22 |
| | 98TH4824* | 3038 | 47.75 | 23.75 | 30.5 | 82 | 28 |

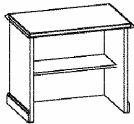

ORDERING NOTES:

The computer stand includes a grommet in the back panel.

DIMENSION KEY

W — width
D — depth
H — height of worksurface
KW— kneehole width

Dimensions are in inches and approximate. Contact Customer Service if dimensions are critical.

*See page 5 for KrugExpress program.

CODE DESCRIPTION

G - includes glass doors
BC - bookcase
BCM- modular bookcase
TPI- modular bookcase top

STANDARD FINISHES

For a complete list of standard wood finishes please see page 577.

WIRING GROMMET

One rectangular black or one antique brass grommet in a standard position is optional at no charge. Please note grommet choice clearly on order form. Additional grommets are available at an upcharge of **\$152 list**.

STRATFORD | FREESTANDING STORAGE

| Description | Model | Cherry Walnut | W | D | H | Shipping Weight | Cubic Feet |
|-----------------|---------------|---------------|-------|-------|------|-----------------|------------|
| 2 Lateral Files | 98ST30203001* | 3433 | 29.75 | 19.75 | 30.5 | 140 | 13 |
| | 98ST36203001 | 3562 | 35.75 | 19.75 | 30.5 | 145 | 15 |
| | 98ST30243001 | 3476 | 29.75 | 19.75 | 30.5 | 145 | 15 |
| | 98ST36243001 | 3614 | 35.75 | 19.75 | 30.5 | 150 | 18 |



| | | | | | | | |
|------------------|---------------|------|-------|-------|------|-----|----|
| 2 Closed Shelves | 98ST30203011* | 2625 | 29.75 | 19.75 | 30.5 | 100 | 13 |
| | 98ST36203011 | 2710 | 35.75 | 19.75 | 30.5 | 130 | 15 |
| | 98ST30243011 | 2668 | 29.75 | 19.75 | 30.5 | 130 | 15 |
| | 98ST36243011 | 2760 | 35.75 | 19.75 | 30.5 | 135 | 18 |

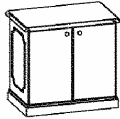

ORDERING NOTES:

Locks may be added to bookcase or wardrobe doors at a **\$152 list** upcharge.

| | | | | | | | |
|-----------------|---------------|------|-------|-------|----|-----|----|
| 4 Lateral Files | 98ST30205701* | 4889 | 29.75 | 19.75 | 57 | 186 | 28 |
| | 98ST36205701 | 5205 | 35.75 | 19.75 | 57 | 211 | 34 |
| | 98ST30245701 | 5007 | 29.75 | 23.75 | 57 | 211 | 34 |
| | 98ST36245701 | 5318 | 35.75 | 23.75 | 57 | 236 | 40 |

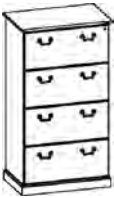

| | | | | | | | |
|---------------------------------|---------------|------|-------|-------|------|-----|----|
| 2 Lateral Files, 3 Open Shelves | 98ST30207103* | 5204 | 29.75 | 19.75 | 70.5 | 220 | 28 |
| | 98ST36207103 | 5336 | 35.75 | 19.75 | 70.5 | 230 | 34 |
| | 98ST30247103 | 5272 | 29.75 | 23.75 | 70.5 | 230 | 34 |
| | 98ST36247103 | 5406 | 35.75 | 23.75 | 70.5 | 240 | 40 |



ORDERING PROCEDURES

To order, please specify the following:

- 1) Krug product model number
- 2) Wood species and finish, see page 577
- 4) Pull style and finish, see page 581
- 5) Grommet location and style if applicable

* Indicates model illustrated by line drawing

CODE DESCRIPTION

TP - modular top with standard profile
 TPR - modular top for run-offs with one coved connecting end
 TPI - modular top with inverted profile
 ST - freestanding storage
 STM - modular storage
 WRM - modular wardrobe
 G - includes glass doors
 D - 2 file drawer
 F - 2 box, 1 file drawer

STANDARD FINISHES

For a complete list of standard wood finishes please see page 577.

STORAGE

Freestanding storage has finished, profiled tops and base molding on three sides. Modular storage does not have finished tops (they must be ordered separately) and base molding is only across the front.

STRATFORD | FREESTANDING STORAGE

| Description | Model | Cherry Walnut | W | D | H | Shipping Weight | Cubic Feet |
|----------------------------------|---------------|------------------|-------|-------|------|--------------------|---------------|
| 2 Lateral File, 3 Closed Shelves | 98ST30207104* | 5827 | 29.75 | 19.75 | 70.5 | 240 | 28 |
| | 98ST36207104 | 5959 | 35.75 | 19.75 | 70.5 | 250 | 34 |
| | 98ST30247104 | 5888 | 29.75 | 23.75 | 70.5 | 250 | 34 |
| | 98ST36247104 | 6029 | 35.75 | 23.75 | 70.5 | 260 | 40 |

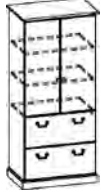

ORDERING NOTES:

Locks are available on all wood doors at **\$152 list per lock**. 24",30" & 36" wardrobes require 2 locks.

| | | | | | | | |
|---------------------------------------------|----------------|------|-------|-------|------|-----|----|
| 2 Lateral Files, 3 Closed Clear Glass Doors | 98ST30207104G* | 6103 | 29.75 | 19.75 | 70.5 | 250 | 28 |
| | 98ST36207104G | 6235 | 35.75 | 19.75 | 70.5 | 260 | 34 |
| | 98ST30247104G | 6163 | 29.75 | 23.75 | 70.5 | 260 | 34 |
| | 98ST36247104G | 6306 | 35.75 | 23.75 | 70.5 | 270 | 40 |



ORDERING NOTES:

All shelves in glass door bookcases are 1/4" thick glass. This item is NOT available on KrugExpress.

| | | | | | | | |
|---------------------------------------|----------------|------|-------|-------|------|-----|----|
| 2 Lateral Files, 3 Closed Grill Doors | 98ST30207104Z* | 6750 | 29.75 | 19.75 | 70.5 | 240 | 28 |
| | 98ST36207104Z | 6884 | 35.75 | 19.75 | 70.5 | 250 | 34 |
| | 98ST30247104Z | 6809 | 29.75 | 23.75 | 70.5 | 250 | 34 |
| | 98ST36247104Z | 6953 | 35.75 | 23.75 | 70.5 | 260 | 40 |

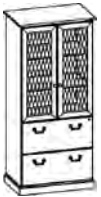

ORDERING NOTES:

All shelves in glass door bookcases are 1/4" thick glass. This item is NOT available on KrugExpress.

DIMENSION KEY

W — width
D — depth
H — height of worksurface
KW— kneehole width

Dimensions are in inches and approximate. Contact Customer Service if dimensions are critical.

*See page 5 for KrugExpress program.

CODE DESCRIPTION

TP - modular top with standard profile
TPR - modular top for run-offs with one coved connecting end
TPI - modular top with inverted profile
ST - freestanding storage
STM - modular storage
WRM - modular wardrobe
G - includes glass doors
D - 2 file drawer
F - 2 box, 1 file drawer



STANDARD FINISHES

For a complete list of standard wood finishes please see page 577.

STORAGE

Freestanding storage has finished, profiled tops and base molding on three sides. Modular storage does not have finished tops (they must be ordered separately) and base molding is only across the front.

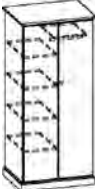
STRATFORD | FREESTANDING STORAGE

| Description | Model | Cherry Walnut | W | D | H | Shipping Weight | Cubic Feet |
|---------------------------------------------------------------------------------------------------------------------------|---------------|---------------|-------|-------|------|-----------------|------------|
|  5 Closed Shelves | 98ST30207111 | 4796 | 29.75 | 19.75 | 70.5 | 230 | 28 |
| | 98ST36207111 | 4929 | 35.75 | 19.75 | 70.5 | 240 | 34 |
| | 98ST30247111* | 4860 | 29.75 | 23.75 | 70.5 | 240 | 34 |
| | 98ST36247111 | 4993 | 35.75 | 23.75 | 70.5 | 250 | 40 |
|  5 Closed Shelves, Closed Wardrobe | 98WR30247101* | 4515 | 29.75 | 23.75 | 70.5 | 245 | 34 |
| | 98WR36247101 | 4698 | 35.75 | 23.75 | 70.5 | 265 | 40 |
| | 98WR30247103 | 4515 | | | | | |
| | 98WR36247103 | 4698 | | | | | |
|  2 Lateral Files, 4 Open Shelves | 98ST30208403 | 5959 | 29.75 | 19.75 | 83.5 | 260 | 33 |
| | 98ST36208403 | 6017 | 35.75 | 19.75 | 83.5 | 270 | 40 |
| | 98ST30248403* | 6044 | 29.75 | 23.75 | 83.5 | 270 | 40 |
| | 98ST36248403 | 6108 | 35.75 | 23.75 | 83.5 | 290 | 47 |
|  2 Lateral File, 4 Closed Shelves | 98ST30208404 | 6183 | 29.75 | 19.75 | 83.5 | 285 | 33 |
| | 98ST36208404 | 6237 | 35.75 | 19.75 | 83.5 | 295 | 40 |
| | 98ST30248404* | 6268 | 29.75 | 23.75 | 83.5 | 295 | 40 |
| | 98ST36248404 | 6337 | 35.75 | 23.75 | 83.5 | 315 | 47 |

ORDERING NOTES:

Locks are available on all wood doors at **\$152 list** per lock. 24", 30" & 36" wardrobes require 2 locks.

ORDERING PROCEDURES

To order, please specify the following:

- 1) Krug product model number
- 2) Wood species and finish, see page 577
- 4) Pull style and finish, see page 581
- 5) Grommet location and style if applicable

* Indicates model illustrated by line drawing

CODE DESCRIPTION

TP - modular top with standard profile
 TPR - modular top for run-offs with one coved connecting end
 TPI - modular top with inverted profile
 ST - freestanding storage
 STM - modular storage
 WRM - modular wardrobe
 G - includes glass doors
 D - 2 file drawer
 F - 2 box, 1 file drawer

STANDARD FINISHES

For a complete list of standard wood finishes please see page 577.

STORAGE

Freestanding storage has finished, profiled tops and base molding on three sides. Modular storage does not have finished tops (they must be ordered separately) and base molding is only across the front.

STRATFORD | FREESTANDING STORAGE

| Description | Model | Cherry Walnut | W | D | H | Shipping Weight | Cubic Feet |
|---------------------------------------------|----------------|---------------|-------|-------|------|-----------------|------------|
| 2 Lateral Files, 4 Closed Clear Glass Doors | 98ST30208404G | 6463 | 29.75 | 19.75 | 83.5 | 295 | 33 |
| | 98ST36208404G | 6519 | 35.75 | 19.75 | 83.5 | 205 | 40 |
| | 98ST30248404G* | 6542 | 29.75 | 23.75 | 83.5 | 205 | 40 |
| | 98ST36248404G | 6612 | 35.75 | 23.75 | 83.5 | 325 | 47 |



ORDERING NOTES:

All shelves in glass door bookcases are 1/4" thick glass. This item is NOT available on KrugExpress.

| | | | | | | | |
|---------------------------------------|----------------|------|-------|-------|------|-----|----|
| 2 Lateral Files, 4 Closed Grill Doors | 98ST30208404Z | 7107 | 29.75 | 19.75 | 83.5 | 285 | 33 |
| | 98ST36208404Z | 7162 | 35.75 | 19.75 | 83.5 | 295 | 40 |
| | 98ST30248404Z* | 7191 | 29.75 | 23.75 | 83.5 | 295 | 40 |
| | 98ST36248404Z | 7260 | 35.75 | 23.75 | 83.5 | 315 | 47 |

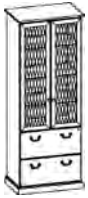

ORDERING NOTES:

All shelves in glass door bookcases are 1/4" thick glass. This item is NOT available on KrugExpress.

| | | | | | | | |
|------------------|---------------|------|-------|-------|------|-----|----|
| 6 Closed Shelves | 98ST30208411 | 867 | 29.75 | 19.75 | 83.5 | 250 | 33 |
| | 98ST36208411 | 5424 | 35.75 | 19.75 | 83.5 | 260 | 40 |
| | 98ST30248411* | 5347 | 29.75 | 23.75 | 83.5 | 260 | 40 |
| | 98ST36248411 | 5493 | 35.75 | 23.75 | 83.5 | 270 | 47 |



ORDERING NOTES:

Locks are available on all wood doors at **\$152 list** per lock. 24", 30" & 36" wardrobes require 2 locks.

| | | | | | | | |
|------------------|----------------|------|-------|----|----|----|---|
| Mobile Pedestals | 98MP1620294D* | 2113 | 15.75 | 20 | 29 | 78 | 6 |
| | 98MP1620294F** | 2244 | 15.75 | 20 | 29 | 80 | 6 |



DIMENSION KEY

W — width
D — depth
H — height of worksurface
KW— kneehole width

Dimensions are in inches and approximate. Contact Customer Service if dimensions are critical.

*See page 5 for KrugExpress program.

CODE DESCRIPTION

TP - modular top with standard profile
TPR - modular top for run-offs with one coved connecting end
TPI - modular top with inverted profile
ST - freestanding storage
STM - modular storage
WRM - modular wardrobe
G - includes glass doors
D - 2 file drawer
F - 2 box, 1 file drawer

STANDARD FINISHES

For a complete list of standard wood finishes please see page 577.

STORAGE

Freestanding storage has finished, profiled tops and base molding on three sides. Modular storage does not have finished tops (they must be ordered separately) and base molding is only across the front.

STRATFORD | RECEPTION

| Description | Model | Cherry Walnut | | | | Shipping Weight | Cubic Feet |
|------------------------|---------------|------------------|------|------|----|--------------------|---------------|
| | | | W | D | H | | |
| Gallery Reception Desk | 98GD72304LFR0 | 6886 | 73.5 | 30.5 | 43 | 325 | 66 |
| | 98GD72304LORF | 6886 | 73.5 | 30.5 | 43 | 325 | 66 |

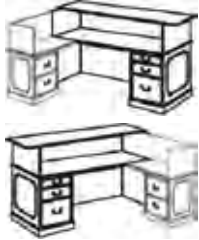

ORDERING NOTES:

Laminate worksurfaces are available at a 10% upcharge. 30" deep Stratford desks have a 1-1/2" overhang on the guest side. 36" deep Stratford desks have a 7 1/2" overhang on the guest side. See page 578 for more information on the desks overhang and chassis dimensions. A burled walnut top option is available at a 20% upcharge.

| | | | | | | | | |
|------------------|--------------|------|-------|-------|-------|------|-----|----|
| Reception Return | 98GRH4824L4D | 3555 | 47.75 | 23.75 | 41.75 | 28.5 | 250 | 38 |
| | 98GRH4824R4D | 3555 | 47.75 | 23.75 | 41.75 | 28.5 | 250 | 38 |

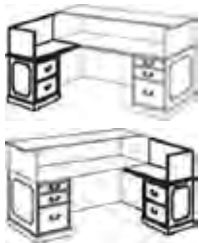

ORDERING NOTES:

Laminate worksurfaces are available at a 10% upcharge. 30" deep Stratford desks have a 1-1/2" overhang on the guest side. 36" deep Stratford desks have a 7 1/2" overhang on the guest side. See page 578 for more information on the desks overhang and chassis dimensions. A burled walnut top option is available at a 20% upcharge.

| | | | | | | | | |
|---------------------------------|------------|------|-------|-------|-------|--|-----|----|
| Gallery Reception Linking Units | 98GLU4224H | 1915 | 41.75 | 23.75 | 41.75 | | 105 | 34 |
|---------------------------------|------------|------|-------|-------|-------|--|-----|----|



ORDERING NOTES:

Linking unit is used to connect Gallery Desk and Credenza to form a 'U' station.

| | | | | | | | | |
|---------------------|--------------|------|-------|-------|-------|--|-----|----|
| Reception Credenzas | 98GC7224L4D | 5870 | 71.75 | 23.75 | 41.75 | | 320 | 57 |
| | 98GC7224L4F | 5870 | 71.75 | 23.75 | 41.75 | | 320 | 57 |
| | 98GC7224R4D | 5870 | 71.75 | 23.75 | 41.75 | | 320 | 57 |
| | 98GC7224R4F | 5870 | 71.75 | 23.75 | 41.75 | | 320 | 57 |
| | 98GC7824L4D | 6498 | 77.75 | 23.75 | 41.75 | | 355 | 60 |
| | 98GC7824L4F* | 6498 | 77.75 | 23.75 | 41.75 | | 355 | 60 |
| | 98GC7824R4D | 6498 | 77.75 | 23.75 | 41.75 | | 355 | 60 |
| | 98GC7824R4F | 6498 | 77.75 | 23.75 | 41.75 | | 355 | 60 |

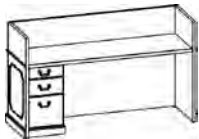

| | | | | | | | | |
|-----------------|---------|------|-------|----|------|--|----|---|
| Transaction Top | 98GRT66 | 1357 | 66.75 | 12 | 1.25 | | 48 | 2 |
|-----------------|---------|------|-------|----|------|--|----|---|



ORDERING NOTES

Laminate worksurfaces are available at a 10% upcharge. 30" deep Stratford desks have a 1-1/2" overhang on the guest side. 36" deep Stratford desks have a 7 1/2" overhang on the guest side. See page 578 for more information on the desks overhang and chassis dimensions. A burled walnut top option is available at a 20% upcharge.

ORDERING PROCEDURES

To order, please specify the following:

- 1) Krug product model number
- 2) Wood species and finish, see page 577
- 4) Pull style and finish, see page 581
- 5) Grommet location and style if applicable

* Indicates model illustrated by line drawing

CODE DESCRIPTION

- 0 - no pedestal
- 4 - full height pedestals
- D - 2 file drawer
- F - 2 box, 1 file drawer
- L - left hand support position
- R - right hand support position
- CD - center drawer
- OT - oversized top option
- BT - bow top option
- CC - corner credenza

STANDARD FINISHES

For a complete list of standard wood finishes please see page 577.

WIRING GROMMET

One rectangular black or one antique brass grommet in a standard position is optional at no charge. Please note grommet choice clearly on order form. Additional grommets are available at an upcharge of **\$152 list**.

Terms and Conditions

Net 30 days on approved credit. A late payment charge of 1% per month will be applied on overdue invoices. This charge will be pro-rated to the number of days past 30 days that the invoice is overdue. All applicable sales taxes are extra. Distribution of this price list does not in itself constitute an offer to sell. Orders can be received only from authorized Krug dealers. Acceptance of any order and terms of sale may be established at the discretion of Krug. Deposits are required on orders received from new accounts as well as on large or special orders. Krug reserves the right to discontinue designs, or to change designs, construction, prices, or materials without notice.

Contact Information

Phone: 1.888.578.KRUG (5784) | Fax: 1.519.748.5177

Purchase Order Fax: 1.888.236.4783

Purchase Order E-mail: orders@krug.ca

Web: www.krug.ca E-mail: solutions@krug.ca

Customer Service Hours

Please note customer service hours are:

8:30 am to 5:00 pm est

Customer Satisfaction

It is the primary goal of Krug and our staff to ensure the complete satisfaction of our customers with our products and performance. If a problem arises with a Krug product after the expiration of the limited warranty period, Krug will exercise its best efforts to achieve the satisfaction of the customer in a manner that is fair to all concerned.

Order Acknowledgments

Each order will be acknowledged via e-mail or fax. This acknowledgment is the final agreement between Krug and the customer, superseding all previous communications regarding the purchase order. Where there is a discrepancy on a purchase order between a product code and a description, Krug will make every effort to resolve the discrepancy, but will be ruled by the product code ordered. Please check all acknowledgments for accuracy, and advise Krug of any discrepancies with a purchase order.

Order Cancellation

Krug reserves the right to not accept or allow cancellation of orders. All products are manufactured on a custom-made, make-to-order basis, and the purchasing, engineering and production of orders begins shortly after order placement - and the customer purchase order is a contract that authorizes Krug to manufacture the products. Acceptance of order cancellation (or partial cancellation) is solely at the discretion of Krug, and is dependent on the extent to which engineering, purchasing and manufacturing has been initiated by the time cancellation is requested. No order cancellations (partial or otherwise) are allowable more than 4 weeks from date of order placement (as order production is unable to be terminated by that point), and full payment of the acknowledged order value is required for any orders cancelled after 4 weeks. Cancellations may be allowable in less than 4 weeks after order placement, depending on the extent to which manufacturing has been initiated. An acceptance of order cancellation requires that the purchaser agrees to make payment for all costs incurred to the point of acceptance of cancellation. Cancellation charges include all costs for purchase of dedicated material and components, engineering costs for non-standard products, and all costs for manufacturing completed to that point, as well as a \$350 net charge for processing of the original order and for processing of cancellation invoicing.

Pricing

Krug endeavors to ensure that all prices in this price list reflect accurately our current prices. However, errors do occur and will be rectified through notices to the field. Krug reserves the right to acknowledge pricing that may be different from the price list.

Warranty

Krug warrants the construction and the finish of all our products to be free from defects in materials and workmanship for a period of 10 years from the date of purchase. This warranty is applicable to products in use by their original purchaser. This warranty does not apply to components not manufactured by Krug including textiles, which are subject to the specific warranties of those manufacturers,

if any. Textiles (fabric, leather, vinyl, or any other covering material) suppliers do not guarantee their products for durability and color fastness, and nor does Krug. Casters, mechanical and electrical components have a warranty of five years from the date of purchase. The Krug warranty does not apply to COM-specified materials, damage caused by a carrier other than Krug, or variation in wood finishes due to natural wood color variation. Krug cannot be held responsible for variations in fabric dye lots from order to order. All fabric is carefully inspected when it is received, but a degree of variation in color should be expected. Repairs or replacement of any defect covered under this warranty by Krug will be made, at our option and method, at no charge to the original purchaser during the warranty period. Krug's judgement is final and binding with respect to the nature or cause of defects or damage, and the necessity or manner of repair or replacement.

This warranty does not apply to defects or damage resulting from:

- normal wear and tear occurring with the use of the product
- negligence, misuse, excessive use, alteration, improper cleaning or repair
- substitution or use of incorrect or unauthorized components or material
- handling or installation that is incorrect, or that causes damage or defect
- damage incurred by a freight carrier other than Krug
- wearing of finishes and fabrics, and normal variations in material (including dye lot variations)
- properties of natural materials, including wood and leather
- exposure to environments with uncontrolled temperature and humidity (products must be transported, stored and used in climate-controlled conditions)

Note, specific warranties for components and materials not manufactured by Krug:

Height Adjustable Mechanism Warranty

Krug warrants to the original consumer purchaser its Height Adjustable Mechanism that it will be free from defects in material and workmanship. This limited warranty covers material and manufacturing defects, which cause a non-conformance in the function of a table base and is limited to the following products and warranty term determined from their dates of purchase:

- a) Electronic components such as control boxes, hand switches and motors – two (2) years
- b) Mechanical components such as crank drives, spindles – five (5) years
- c) Structural components such as J-channels, feet and top supports – ten (10) years

The start of the warranty period is the documented date of your purchase of the product. The warranty herein is made to and for the benefit of the original consumer purchaser of the product and is non-transferable. If you discover a defect in material or workmanship during the warranty period, and Krug agrees that the defect exists, Krug will, at its option, repair or replace the Product at no charge to you, provided it is returned during the warranty period. In the unlikely event that your product should require repair or replacement during the warranty period, please contact Krug to obtain warranty service. The warranty period on replacement products is the remainder of the warranty on the original product or 30 days, whichever is longer.

Testing

All Krug Conference products meet or exceed the testing requirements of ANSI/BIFMA X5.5-2014 or X5.9-2012.



Dimensions

Dimensions are in inches and approximate, and subject to change without notice. Contact Customer Service if dimensions are critical.

Installation Support

For assistance please contact Technical Support at 1-888-578-5784 x216 or e-mail installationhelp@krug.ca and you will be directed to the appropriate installation support person.

Storage Charges

Krug reserves the right to assess a nominal storage charge if a customer does not accept shipment of an order within a week of the ship date.

Export Packaging

Krug is pleased to provide the option for export packaging on all our products, to provide additional protection from damage. For shipments overseas, a quote for export packaging can be provided, based on the products to be ordered and the delivery destination - please contact Customer Service or Bids & Specification Support for more information and a quotation. KRUG is not responsible for shipment damage occurring on overseas shipments

Export Packaging is **STRONGLY RECOMMENDED** for:

- (A) all shipments outside of the lower 48 states and Canada
 - (B) all shipments that will be held in storage for an extended period prior to installation. Important: Please note that Krug will not be responsible for damage claims on product shipped or stored in the above conditions where export packaging has not been utilized.
- Please contact Customer Service for specifications or any other assistance regarding export packaging.

Freight Terms and Conditions

1. All product is shipped FOB the Krug factory. Freight is either pre-paid to the destination or not pre-paid, depending on established customer specific freight terms.
2. Docks at the selected delivery location must be equipped to handle a 53' trailer. If a dock is inadequate for delivery by Krug, Krug will re-deliver to another local location and any additional costs will be charged to the customer.
3. For all deliveries, it is understood that Krug or its agent is making a dock delivery only (equipped to handle a 53' trailer), and any further work of truck unloading, delivery beyond the dock, installation, and removal of packaging is not authorized or paid for by Krug.
4. Drop shipments to the installation site, and timed deliveries, are available on larger shipments (full truckloads or slightly less) at no additional charge. Drop shipments or timed deliveries for smaller shipments may not be available, or if available will require a surcharge. Deliveries on an after hours basis, or on weekends, or any other special requirements, may be subject to a surcharge. Location and contact information, and the requested time of delivery, is required at least one week prior to the acknowledged shipment date. If this information is not provided one week in advance, or if the location or time of the drop shipment is changed less than one week in advance, a surcharge may be applied, and/or the drop shipment may not be scheduled.
5. For all deliveries - whether to the Customer location or drop shipment - any circumstances that result in the delay of our carrier (including unsuitable receiving facilities, or facilities not open or available), service charges will be applied at the rate of \$75/hour. Where re-delivery is necessary because of these circumstances, the full cost of re-delivery will be charged. If Less Than Truck Load is delivering, one hour is allocated to unload. Any additional time required to unload after the first hour is \$75/hour. If a Truck Load is delivering the order, three hours is allocated to unload. Any additional time required to unload is \$75/hour. Direct deliveries to site for net orders are possible, must exceed \$60,000 net, and accommodate 48-53' trailers. Krug is responsible for delivery to the approved delivery address. If an address change is required, this must be authorized by Krug 5 business days prior to ship date. Any additional delivery costs incurred after this time will be charged to the customer. Additional costs for partial shipment of orders are the responsibility of the customer, and will be added to invoices. This includes any part shipment costs due to delays from textile suppliers. Additional costs for partial order shipments will normally not be assessed if there is a delay caused by Krug.

Damaged Shipments

All Krug product is well engineered, carefully inspected, and expertly loaded onto our trucks at our Distribution Center. If you receive any damaged freight, we ask that you do not refuse the shipment. Krug is not responsible for damage to goods that occurs in transit or storage. It is the purchaser and/or receiver's responsibility to examine the goods upon receipt and to notify Krug of any damages, overages or shortages. Any discrepancies should be noted on the Bill of Lading. The delivering carrier will not accept responsibility for shortages or damages if signed "clear". Notification of concealed damage claims must be made to Krug Distribution within 5 days of delivery, along with digital pictures if available. All product and

packaging must be available for inspection. Krug liability ceases after 5 business days and Krug will not be responsible for concealed damages if shipments are left unopened. Krug is not responsible for the condition of product that is stored or installed in an environment where temperature and humidity are not controlled.

Field Product Report Authorization

Krug's written authorization, in the form of an FPR number, must be obtained prior to incurring charges of any kind if Krug is expected to pay these charges. This includes authorization for returns, field repairs and replacements, post field repairs, installation and delivery charges. Krug reserves the right to have its representative inspect product related to any request for such authorizations, prior to that authorization being provided. Deductions from invoices paid for any charges to Krug, without prior written authorization in the form of an FPR, will not be accepted. Digital photographs may be required to complete the FPR process.

Care and Maintenance

Wood Finishes - Although Krug's extensive finishing process ensures a durable finish on all our products, there are several steps that can be taken to protect and prolong the life and beauty of the finish. Protect the top by placing felt pads on the bottom of any accessories and mechanical equipment. Rubber and oil will permanently mark surfaces. Use a desk pad to prevent possible damage and imprinting caused by writing instruments and sharp objects. Dust only with a clean, dry cloth, going with the grain. Clean any marks with a damp cloth, using a small quantity of mild soap or detergent. Do not use any wax-based polish, spray or silicone. Eventually, a film will build up and discolor the top. Do not place your furniture in a position of permanent exposure to direct sunlight.

Plastic Laminates - Clean plastic laminates with mild soap and warm water. Do not use steel wool, hot water, or any abrasive cleaning product.

Custom Capabilities

Over 15% of our orders involve some type of custom work, and we invite our customers to make use of our extensive capabilities. These include:

- 1) Dimensional customization of standard size products
- 2) Custom wood finishes
- 3) For larger orders, completely custom-designed products, as well as non-standard wood species can be specified.

Custom orders may require additional production lead times.

Contact Customer Service for more information.

Krug Panel Fabric Program

Tackboards can be upholstered in COM material supplied by the customer, and in a selection of stocked tackboard fabrics supplied by Momentum. The Momentum Panel fabrics are available on Krug Express. They are 100% polyester. For additional information and color selections, please refer to our Panel Fabrics card and Krug's website. www.krug.ca The Momentum panel fabrics pass ASTM-E84-87 Fire Codes. If memo samples are required please call Momentum at 1-800-366-6839.

Program Details

KrugExpress orders are ready to ship by the date acknowledged. Delivery and shipping schedules may result in actual shipping of orders at a later date. Statutory holidays and scheduled factory vacations may add to acknowledged lead times of *KrugExpress* orders. Unless otherwise specified on the order, the customer's standard method of shipping Krug products will be utilized. Available factory capacity for *KrugExpress* is filled by orders received on a "first come, first serve" basis. If the normal *KrugExpress* lead time is not available for your order because available capacity has been filled, you will be immediately advised of the earliest available ready-to-ship date. Please consult your Customer Service representative in advance if you wish to confirm the specific lead time availability for a *KrugExpress* order. Orders must be received by midnight of a given day for that day to be considered the official day the order is received. Order lead times are acknowledged from the date the order is received, but not including the date the order is received. *KrugExpress* orders must be "clean" when received in order to be considered officially received on a given day, and lead times will be acknowledged from the date orders are determined to be "clean". Changes to *KrugExpress* orders are not allowed under any circumstances. Orders for product on *KrugExpress* must clearly state: "*KrugExpress*".



Krug Textiles - Leather Program

Grade 8

| | | | |
|-------|----------|----------|----------|
| Black | K13.1000 | Graphite | K13.4000 |
| Stone | K13.3000 | Espresso | K13.8000 |
| Sand | K13.5000 | White | K13.9000 |

Please contact Customer Service for specific information on leathers, available colors and lead times.

Krug Textiles - Faux Leather Program

Grade 2

| | | | | | |
|-----------|----------|-----------|--------|------------|--------------|
| White | Taupe | Bisque | Wine | Sprig | Lagoon |
| Cream | Mocha | Chocolate | Garnet | Chinchilla | Pacific Blue |
| Parchment | Tan | Black | Rust | Steel | Navy |
| Sandstone | Chestnut | Earth | Citron | Grey | Plum |
| Vanilla | | Brick | | | |

GRADED-IN UPHOLSTERY PROGRAMS

Krug has partnered with several textile brands to grade in their offerings, designed to provide a wide range of upholstery selections for our seating products.

Upholstery pricing and availability is subject to change without notice. We grade this upholstery according to the pricing of the fabric suppliers - when their pricing changes, the Krug grade may change. When placing an order, a Krug customer must specify the complete upholstery number, along with the appropriate Krug model number and finish. Krug will supply the complete product at the prices listed. Orders specifying graded-in upholstery cannot be cancelled once the upholstery has been ordered.

Upholstery Grades

To determine the price of a product for graded-in upholstery, use the reference lists located on Krug’s website under - Products - Textiles, to view the upholstery grade (1-9). Krug is not responsible for the discontinuation of this upholstery. Please contact Customer Service for information on upholstery not listed.

When two upholstery selections are specified for use on seating, the higher grade upholstery price will apply to the order.

High Performance upholstery; Polyurethane, Vinyl or Crypton, is particularly suitable for healthcare and other intensive-use environments.

Upholstery Samples

If you require additional samples or memos for presentation, please contact fabric supplier directly.

Flammability Standards

- Tunnel Test Surface Ratings Class A rating
- Class 1 UFAC
- Passes State of California Technical Bulletin CAL 117-2013

Please contact fabric supplier directly for further flammability information pertaining to specific upholstery.

Special Conditions

Acknowledgements will give the estimated delivery date of the finished product. Some upholstery is imported, and availability may affect estimated delivery time. For large projects, please contact fabric supplier directly for availability of yardage.

TACKBOARD FABRICS

KRUG PANEL FABRIC PROGRAM

Tackboards can be upholstered in COM material supplied by the customer, and in a selection of stocked tackboard fabrics supplied by Momentum. The in-stock Momentum fabrics are priced at Grade 1 and are available on Krug Express. They are 100% polyester. For additional information and color selections, please refer to our Panel Fabrics card and Krug’s website. www.krug.ca If memo samples are required please call Momentum at 1-800-366-6839. The Momentum panel fabrics pass ASTM-E84-87 Fire Codes.

PROGRAM DETAILS

KrugExpress orders are ready to ship by the date acknowledged. Delivery and shipping schedules may result in actual shipping of orders at a later date. Statutory holidays and scheduled factory vacations may add to acknowledged lead times of KrugExpress orders. Unless otherwise specified on the order, the customer’s standard method of shipping Krug products will be utilized. Available factory capacity for KrugExpress is filled by orders received on a “first come, first serve” basis. If the normal KrugExpress lead time is not available for your order because available capacity has been filled, you will be immediately advised of the earliest available ready-to-ship date. Please consult your Customer Service representative in advance if you wish to confirm the specific lead time availability for a KrugExpress order. Orders must be received by midnight of a given day for that day to be considered the official day the order is received. Order lead times are acknowledged from the date the order is received, but not including the date the order is received. KrugExpress orders must be “clean” when received in order to be considered officially received on a given day, and lead times will be acknowledged from the date orders are determined to be “clean”. Changes to KrugExpress orders are not allowed under any

circumstances. Orders for product on KrugExpress must clearly state: “KrugExpress”. *Some conditions apply. Please note PALETTE finishes are not available on KrugExpress.

CASEGOODS PROGRAM

Orders for casegood products on the KrugExpress program may be subject to quantity maximums. Please contact Krug Customer Service for more information. Quantity maximums are dependent upon available capacity, in order to insure that we ship all orders on time. Only actual casegood pieces and conference tables tops and bases are considered “units”. Items such as tasklights, tackboards, keyboard trays and drawers, electrical and wire management components, etc., are not considered under the quantity restrictions. For example, a typical office configuration that includes a desk, linking unit, credenza and hutch/overhead, equals a total of four units for the purposes of the quantity maximum. Only Krug In-stock panel fabric is available on the KrugExpress program. Only standard wood finishes are available for KrugExpress orders. Grommets can be specified in standard positions only. KrugExpress also includes all Krug seating and occasional tables as well as Krug conference products to complement this casegoods offering.

CASEGOODS | USA | 629

CUSTOMER'S OWN MATERIAL - C.O.M.

Customer's Own Material (COM)

COM must be received three weeks prior to the acknowledged ship date. Orders with COM not received by the required deadline will be delayed.

A description of the fabric, including supplier name, fabric name and color number must be included with the purchase order. When the COM fabric is received at Krug, it must be clearly identified with the fabric name and color, and tagged with name of the Krug customer and purchase order number. Krug will inspect all COM fabric when received to determine if it will be suitable for upholstery. Where Krug feels that the fabric or leather specified will compromise the quality or integrity of our products, customers will be contacted to direct these concerns. Further, Krug reserves the right to refuse to accept and use any COM fabrics or leathers that will compromise our products in any way that is unacceptable to Krug. Krug cannot assume responsibility for the durability or tailoring quality of customer's own material.

Yardage specified in this price guide is approximate. In the case of multiple product orders, multiply the number of items by the COM yardage specified to determine fabric required, unless otherwise indicated. Additional yardage may be needed if the material is less than 54" wide, or patterned or striped and requires matching. As fabric is applied horizontally, non-directional fabrics are recommended. COM fabrics are applied as they come off the roll unless otherwise specified. All striped fabrics will be applied vertically unless otherwise stated by the customer and after approval by Krug. It is the customer's responsibility to advise Krug if the upholstery is to be applied otherwise, and to advise Krug of any special upholstery instructions. Special instructions should be sent to Krug Customer Service, including a sample (or photocopy) of the fabric. Krug is not responsible for instructions sent with the fabric rolls, or for the method of upholstery if no instructions have been provided. COM fabrics for tackboards may be specified in either Maharam or Momentum panel fabrics. Krug is not responsible for determining if a fabric is not ideal for tackboard application.

Please contact Maharam at 1-800-645-3943 or Momentum at

COM Shipping Procedures

For tackboard COM fabrics, please send fabrics to:

Krug Inc.

111 Ahrens Street

Kitchener, Ontario

Canada N2H 4C2

Attention: RECEIVER

All packages must be clearly marked "For Customs Clearance by Willson International Custom Brokers". According to the North American Free Trade Agreement (NAFTA), goods shipped between the United States and Canada can qualify for exemption from all duties, or for a reduction in duties, if the goods can be proven to originate in either the United States, Canada or Mexico.

Canada Customs requires that a NAFTA Certificate of Origin and Commercial Invoice be completed and sent with the fabric shipment. The Commercial Invoice must clearly state the description of the fabric, the selling price, the make-up or content, and the purchaser. The absence of these two documents will delay the shipments at the U.S./Canada border, thereby potentially delaying the customer order. If the total value of the shipment is less than \$1200 U.S., Customs will accept a Low Value Statement of Origin in place of the NAFTA Certificate of Origin. The Low Value Statement must be signed by a representative of the exporting company. This statement may either be included on the commercial invoice or attached to the invoice.

Krug is happy to answer any questions or concerns about COM shipping procedures and the required documents. Please contact our Customs Specialist at 1.888.578.5784.

LAMINATES

LAMINATES

Krug's in-stock Laminates are available in 17 different laminate selections. Please note that 4 of the colors (Gingerbread, Portobello, Ash and Willow) have textured finishes and may not be appropriate for use in patient areas due to infection control concerns. Minimum order quantities and extended lead times may apply for exotic laminate colors, please check with customer service. Polymer Edge will be selected to match the worksurface. Krug's previous laminate in-stock program will be phased out as in-stock supply depletes. Please contact customer service for availability.

IN-STOCK LAMINATES

| Wood Grain Laminates | High Pressure Laminate Supplier | Textured Wood Grain Laminates | High Pressure Laminate Supplier |
|----------------------|---------------------------------|-------------------------------|---------------------------------|
| Champagne | Tafisa T492CR | Gingerbread | Tafisa T556UR |
| Hardrock Maple | Formica 86992-58 | Portobello | Tafisa T557UR |
| Dune | Tafisa T491CR | Ash | Tafisa T535AT |
| Copper | Tafisa T521CR | Willow | Tafisa T543AT |
| Shiraz Cherry | Tafisa T472CR | | |
| Park Avenue Walnut | Wilsonart 7984-38 | Solid Laminates | |
| Chocolate | Tafisa T498CR | Designer White | Wilsonart D354-60 |
| Nutmeg | Tafisa T477CR | Platinum | Tafisa T202CR |
| Dark Walnut | Tafisa T469CR | Earth | Tafisa T767CR |
| | | Charcoal | Tafisa T228CR |

PHASE OUT LAMINATES

Almond - Black- Shadows - Edgewood Sycamore - Gunstock Walnut

Non-Stocked Laminates

For specific lead time and application questions, please contact Krug Customer Service for your requirement. Upcharges will be applicable for non-stocked laminates, depending on their cost. Non-stock laminates may require a minimum order quantity, please contact customer service. Stocked polymer edges only can be specified for use with non-stocked laminates or tops will be self-edged.



The mark of responsible forestry

All products are air emissions certified and are available as FSC® certified

krug