

VIRTU CONFERENCE
Price and Specification Guide
USA



krug

Advancing Design Through Innovation

VIRTU | TABLE OF CONTENTS

VIRTU | CONFERENCE TABLES

- 3 Environmental Summary
- 4 Introduction & Overview
- 6 Features & Options
- 10 Sample Layouts
- 12 Rectangular Table Specifications
- 16 Arced Rectangle Table Specifications
- 20 Racetrack Table Specifications
- 24 Boat Table Specifications
- 28 Oval Table Specifications
- 32 Verso Table Specifications
- 34 Visio Table Specifications
- 38 Open Visio Table Specifications
- 42 Delta & Arched Square Table Specifications
- 44 Round & Square Table Specifications
- 46 Power & Communication Planning

CONNEXUS™ TABLETOP CONNECTIVITY SOLUTION

- 53 Connexus™
- 55 Preconfigured Standard Modules
- 57 Preconfigured Large Modules
- 58 Custom Connexus™
- 60 Port Options
- 64 Connexus™ Location Charts
- 76 Floor Monument Locations
- 94 Conference Table Ordering Chart Sample

95 VIRTU MEDIA CABINETS

- 119 Installation Instructions

GENERAL INFORMATION

- 131 Terms & Conditions
- 131 Warranty
- 132 *KrugExpress* Program
- 133 Wood Finishes
- 133 Laminate Program

LEED CERTIFICATION



MATERIAL CONTENT:

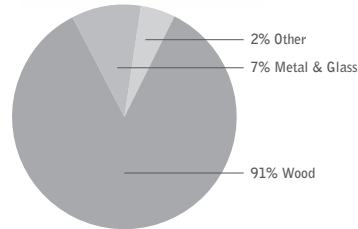

PRE-CONSUMER RECYCLED CONTENT - 73%
POST-CONSUMER RECYCLED CONTENT - 2.5%

Credit	Description	CONTRIBUTES To
Credit 2.1 - 2.2	Construction Waste Management	1-2 point(s)
Credit 3.3	Resource Reuse	1 point
Credit 4.1	Recycled Content	1 point
Credit 4.2	Recycled Content	1 point
Credit 4.5	Low Emitting Materials, (MUST BE REQUESTED) Composite Wood & Laminate Adhesives	1 point
Credit 5.1	Regional Materials*	1 point
Credit 6	Rapidly Renewable Materials (MUST BE REQUESTED)	1 point
Credit 7	Certified Wood (MUST BE REQUESTED)	1 point

*This credit is only applicable if in total 20% of the combined value of the procurement of construction materials and in the furniture are manufactured within a radius of 500 miles. This credit will apply if the installation of the finished product occurs within 500 miles of Kitchener, Ontario.



level® CERTIFICATION

BIFMA's e3 Furniture Sustainability Standard is a voluntary, multi-attribute standard that measures the degree of sustainability of furniture. This standard evaluates product and company environmental attributes and compliance systems in a wide range of elements which include Materials, Energy & Atmosphere, Human & Ecosystem Health and Social Responsibility. Virtu products have earned level®, BIFMA's sustainability certification program for furniture, certification through third-party verification against the e3 standard. All Virtu products can be supplied with level® certification. In order to accomplish this, the product must also be ordered with the air-emissions-certification option. Contact customer service for information and upcharges.



FSC
www.fsc.org
FSC® C021699

the mark of responsible forest

AIR-EMISSIONS

All Virtu products can be supplied with air-emissions-certified materials. Contact customer service for information and upcharges.

FSC®

FSC® In 2005, Krug received Forest Stewardship Council® (FSC®) Chain-of-Custody certification for our manufacturing facilities. The FSC® Chain-of-Custody tracks certified wood from seedling to final sale. It verifies that the material for our FSC® certified products only come from well-managed, FSC®-certified forests and other controlled sources. FSC® is dedicated to the promotion of responsible forest management worldwide helping to take care of forests for future generations. Virtu and other Krug products can be specified with FSC® Certification. Contact customer service for further information, pricing and lead times..



In addition, architects, designers, and building professionals can specify FSC®-certified products in order to achieve a point from the U.S. Green Building Council's Leadership in Energy and Environmental Design (LEED) Rating System.

VIRTU | INTRODUCTION AND OVERVIEW

FUELING CREATIVITY

As much as anything, the development of VIRTU reflects the growing importance of meeting space in virtually all organizations. Facilitating interaction and collaboration between people, and creating environments where relationships can be established and built, is both the challenge and the opportunity of office design.

This was the inspiration for creating VIRTU Conferencing – a collaborative process itself, between Hatch Design and Krug’s in-house design team. Spending countless hours in meeting rooms was a pretty good way to develop a conferencing product – lots of firsthand knowledge was involved. But we also talked to facility managers, designers and architects about what their needs were, and what was lacking among available products. We talked to dealers and installers about what goes wrong when meeting rooms are ordered and installed, and to electricians about how we could create an interface with technology that would not become outdated by the constant advances in this area.

Most of all, VIRTU is about design that helps organizations reach their potential. In the words of principal designer John Edwards, “VIRTU has many attributes, but our primary goal was to create meeting rooms that would truly stimulate people. Many of the unique elements of VIRTU – such as the Verso Table, the Connexus™ module, the shapes and angles, the combinations of materials – are meant to allow a space to facilitate the creative process. Furnishings that can do this deliver tremendous value.”

To this point, higher-end conference rooms have usually required the client or the designer to find a custom millwork house to make furniture. This can offer some advantages, but also some disadvantages: high cost, long lead times, the challenges of matching finishes and materials to other furniture, and perhaps most of all, the extensive work involved with designing custom furniture in the first place.

VIRTU changes all of that. All of these issues are turned into solutions. VIRTU is the most extensive product offering of its kind. Krug’s industry-leading production system provides a huge array of options within this line, allowing for the specific needs and wants of each project to be addressed. But addressed with a product range that is already designed, engineered, and is manufactured with a process that takes a few days, rather than weeks. And when all is said and done, VIRTU provides the best value available today.

THE VERSO TABLE – PATENTED FOR PRESENTATIONS!

The Verso table offers a unique range of conferencing options in a single table. First, its tapered shape - like the Visio and Open Visio tables in VIRTU – provides a great solution for videoconferencing. Second, the Verso table incorporates leading-edge thinking on how to make the best in-person presentations. This thinking says that from the audience’s perspective, the presenter should always be positioned to the left of the visuals at the front of the room. The Verso table is designed to orient the presenter and the audience in this correct positioning.

Third, Verso is designed to work well for meetings where participants are all seated at the table. Many videoconferencing tables, with a separation in the middle, do not work particularly well for sit-down meetings. The Verso table’s effective accommodation of all three meeting room scenarios makes it the most versatile conference table on the market. And if there is one thing that is usually required of meeting rooms, it is the ability to accommodate many different uses.

OPTIONS, OPTIONS, AND MORE OPTIONS

Speaking of versatility – VIRTU Conferencing Tables offers a huge selection:

- 12 table top shapes, each in a large range of sizes.
- 4 edge profile options.
- 7 table base styles, each with built-in wire management.
- 4 wood species: Maple, Cherry, Walnut and Anigre.
- 15 wood finishes
- a large array of Connexus™ configurations, and the option to order as a Blank module and configure on-site.
- Connexus™ modules that can be specified in a range of locations on table tops, to provide the desirable location for, and quantity of, power interfaces.

VIRTU features numerous complimentary pieces, including Media Cabinets, Display Cabinets, Lecterns, Visual Boards, Buffets, Credenzas, Storage Cabinets, Bookcases, and Mobile Media and Server Carts.

VIRTU AND VIDEOCONFERENCING

VIRTU has been designed to accommodate all the latest in videoconference applications, and can be reconfigured with off-the-shelf components as needs and office technology change. The following are the fundamental principles of videoconferencing that were incorporated into the thinking of creating VIRTU – which we feel successfully supports a multitude of videoconferencing environments.

VIDEOCONFERENCING DEFINED

Videoconferencing is the use of audio, video and data communications to enable groups to interact without being in the same geographic location. Many companies have found they cannot afford the down time and considerable cost of mobilizing their staff for face-to-face meetings. To optimize the videoconferencing experience, the right environment must be created to support both the participants and the technology.

VISUAL COMPONENTS

Cameras that are used to convey images are very sensitive to movement. When too much motion is captured, it creates a backlog of images. These images are then compressed which causes the system to drop frames and/or compromise the spatial resolution in an effort to keep up with the participants. This leads to a disjointed broadcast and pixilated images.

To prevent this disruption several things can be done. First, ensure that the camera is situated on a flat, stable surface. Next, eliminate all extraneous motion. This means everything from clocks to people walking in the background. The only backdrop to videoconferencing should be a blank wall of neutral color.

Since eye contact is an important part of the videoconferencing experience it is vital that the camera not be placed too far away from the participants. In a group setting the technology being used today mandates that users not be more than 10 feet from the camera. This fact will limit the size of the room being used for group meetings: a 12 or 13 foot long room allows for optimal visuals and provides enough room for six or seven participants to be seated around a conference table. Furthermore, sitting too close to the source will lead to a fisheye effect and a distorted image.

All participants should be visible to the camera, so a traditional seating arrangement (rectangular, straight line) will not work. To ensure that all group members are included in the telecast, a table that staggers the sight line of the camera is suggested. The ideal shape has one end narrower than the other and is long enough to place the person seated at the back no more than 10 feet from the camera. To help simulate a more natural face-to-face meeting, it is typical to employ the use of two monitors in a videoconferencing room. The use of two monitors allows the participants to view not only those positioned off-site, but themselves. By placing these monitors side by side a focal point is created that keeps the group's attention.

To have all the participants focused on one point in the room is key. This allows for the camera to capture the faces of the assembled group. Face time is essential in videoconferencing so the speaker can be easily identified. Aside from simulating a natural "physical" environment it also keeps the pace of the conversation moving forward and eliminates the need for disruptive introductions throughout the conference.

The room's focal point should be the storage unit positioned at the head of the conference table. This unit should be able to house one or two monitors side by side and have a shelf above for the camera and speakers. To support these components, a PC is usually dedicated to the room to coordinate and document the meetings. Therefore, a well-ventilated storage unit that is high enough to position the camera correctly is as important as the technology itself.

To prevent poor visual tones the surroundings of the participants should be darker than they are. Darker finishes on the table and other furnishings will allow the camera to be more effective; walls should be neutral. Fluorescent lighting creates hot spots, so use incandescent lighting whenever possible. Furthermore, glare and reflections from windows and glass frames throw the image off. The room should have dark blinds for all windows; glass surfaces (dry erase boards, framed pictures) should be situated on side walls rather than the background.

AUDIO COMPONENTS

The audio portion of videoconferencing is comprised of two physical components: the microphone and speakers. The microphone picks up the voices of the participants and should be placed an equal distance from all group members to prevent a dominant voice from overwhelming the meeting. Tabletop microphones are the most common and can be easily moved to accommodate the number of participants in each meeting. Some form of surface wire management should be in place to facilitate the installation and removal of the microphone.

To eliminate sound distortion and echo, the conference room should have soft furnishings such as: upholstered seating, carpeting and ceiling tiles. Plastic and mesh chairs reduce acoustical quality and range. Acoustical panels are also suggested for rooms in constant use. The location of the room is also important. The ideal room is not located near a main thoroughfare where people will often stop and chat, creating unnecessary background noise. Moreover, all air ducts should be well insulated to avoid "white noise."

TECHNOLOGY SUPPORT FURNITURE

The table in use should adapt to the requirements of each conference by including tabletop access to power and data. These "ports" allow conference participants to position a microphone, telephone or laptop on the table without stringing wires from the table to the wall. This helps keep the focus on the meeting, allows information to be shared more readily, and protects wires from both feet and chair casters. Also, with plug and play ability, the room can be reconfigured to fit the requirements of each meeting and its participants.

The tabletop interface should provide power and data outlets beneath a removable, protective cover; this will prevent any spilled liquids or cleanser from entering the wiring cavity. The cover should provide enough room for the wires to enter the cavity below without force or threading. The interface itself should be placed at an angle to allow an ease of use and prevent data wires from crimping and denigrating their capacity to deliver information.

The faceplates that cover the interface should be universal and reconfigurable to adapt to frequent technology and network upgrades. The interface should be accessible from below so that the back panel and electrical module itself can be switched out as easily as the faceplates. Access to the bases through removable panels should allow for the easy management of wiring to the interface itself or the module into which it is wired. This not only keeps the wires hidden from view, but also protects wiring from exterior elements. Bases can provide an opening to the floor where wires can be routed to the underside of the table. A table leg with a channeling insert can make the same connection.

Any storage unit housing monitors, cameras, speakers and computers must have a wire management system in place. This should include oversized grommets leading from one level to another and ventilation to the back to promote air circulation and release the heat generated by electronics. The grommets should be easily accessible so that retrofits, upgrades and maintenance can take place on a regular basis. Access to the wall behind the housing is also advisable so that faceplates in the wall can be reached without moving the entire unit.

VIRTU | FEATURES & OPTIONS

METAL FINISH OPTIONS

Metal components of VIRTU are available in a Satin Aluminum finish. This encompasses all metal hardware with the exception of glass door frames, and Connexus™ Faceplate components which are only available in Satin Aluminum finish. Please specify Metal Finish Option on purchase order.

PULLS

Pulls are located on all drawer fronts and all wood or glass storage and display doors. Pulls are shipped installed on the interior of doors to prevent any damage.

SOLIDS

All Conference top edges, except Fino, have 1 3/8" wide laminated solid Maple or Cherry headers. Fino edges are 5/16" wide. Edges on casegoods are 5/16" wide as well. Where Anigre is the veneer species chosen, edges are of solid Maple. All solids used are Maple or Cherry, kiln dried by Krug to a 6% moisture content.

VENEER

Veneers are #1 grade flat sliced Anigre, Maple, Cherry or Walnut and of uniform color and grain pattern.

FINISH

All finished surfaces are well sanded before applying finishing materials. The procedure begins by applying a base color via an NGR stain. A wash coat follows to further enhance the color. Next is the glazing process, which provides the 3rd color step and fills the pores of the wood. A sealer coat is then applied, twice to the horizontal worksurfaces to enhance the finish. The product is then scuff sanded to prepare for the top coat. The top coat is a catalyzed varnish that when dry has a sheen value of 32°. Krug's catalyzed varnish has been tested to be one of the industry's most durable and long lasting. Custom finishes are available at an upcharge of 10% list per unit.

GABLES

Gables are 3/4" thick – 45 lbs per cubic foot density particleboard core, 3 ply. Edges are banded with veneer.

GLASS SURFACES

All vertical and horizontal glass surfaces are tempered and frosted. For proper cleaning of all glass surfaces, Windex™ brand cleaning solution is recommended. Horizontal tempered and frosted glass surfaces are 10 mm thick.

HALOGEN LIGHTING

Halogen lighting is optional in both Small and Large Display Cabinets with glass shelving. The standard is one light per unit at a price of **\$555 list**.

LOCKS

Locks are optional on a selection of cabinets and must be specified at time of order. Locks are only available on wood doors at **\$152 list** per lock mechanism.

LEVELING LEG

Standard on all cabinets is a unique leveling leg – a metal casing moves up to allow for access to a glide, then neatly drops into place around the glide, concealing it from view. The glide can be adjusted 5/8".

GLIDES

Adjustable glides are installed on conference table bases at factory and allow for 5/8" of adjustment.

CASTERS

Locking casters are standard on the Server and Media Carts. Casters may be specified as an option on Dual Media Cabinets and on Small Media Cabinets at a price of **\$208 list** per unit.

LAMINATES

Laminate worksurfaces are available at an upcharge of 10%. Specialty laminates may be priced higher.

HINGES

All hinges on VIRTU cases are European style chrome with 3-way adjustment and quick release. Openings on all doors are 95 degrees, with the exception of upper doors on Media Cabinets and Visual Boards, which feature an opening of 165 degrees (upper pocket doors on Media Cabinets open to 95 degrees). Synch doors are mounted on ball bearing slides and open to a 38" expanse. Bi-fold doors on Dual Media Cabinets are mounted on interior control arms which allow the doors to open in a 165 degree controlled arc. The small access door on the back of the Mobile Media Cart features a touch latch with a free swing hinge.

TESTING INFORMATION

All product has been tested in accordance with ANSI/BIFMA X5.5-2014 or X5.9-2012.

TABLE TOP STYLES

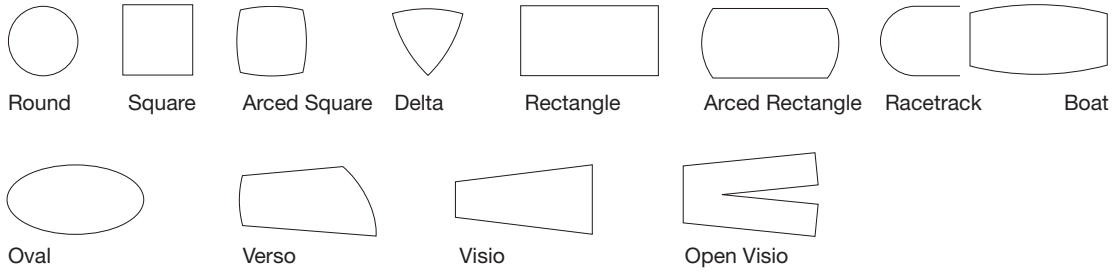

Verso, Visio and Open Visio tops feature unique shapes that are ideal for presentations and videoconferencing. Presenters are easily seen and heard by those seated, and television monitors are unobstructed to the audience as well. The typical camera location, centered over the monitor at the front of the room, can easily scan all of the participants seated down the length of the table.

SEATING CAPABILITIES

Estimated seating capacity for each table top size can be found in the Conference Top section. To establish seating capacities, an outside chair dimension of 24" has been used, plus an allowance of 5" between chairs, for a total of 29". This is an approximation and based on seating with 5 prong bases. When using chairs with different specifications be sure to adjust the approximate seating capacity accordingly. Since not all manufacturers use this same seating formula, when a seating capacity is in question, please contact Krug Customer Service to review the specific seating that is being used with Krug Conference product.

EDGE PROFILES – CONFERENCE TOPS

VIRTU conference product offers 12 table tops in Anigre, Maple, Cherry and Walnut, with 4 distinct edge profiles, with a top thickness of 1 1/2". Please specify an edge profile for all VIRTU conference tops. Please note that the edge width (measurement from end of table veneer to the end of table edge) on Vita, Vero and Lineo is 1 3/8". Fino edge width is 3/8".



Edge Profiles – Caseworks

VIRTU casework worksurfaces feature the Fino profile at 1 1/8" thickness.



BASE STYLES

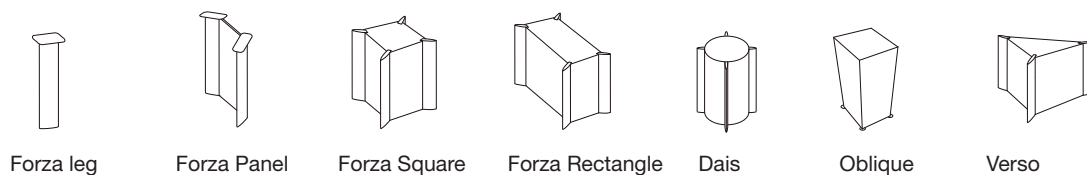

Seven base styles allow for numerous conference table configurations. The five enclosed bases allow for total concealment of wiring when floor monuments are located underneath. These bases also provide plenty of leg room around the perimeter of conference tables. Enclosed bases include 72 lbs. of ballast inside of the bases to provide enhanced table stability. Forza Panel and Forza Leg bases give users an abundance of space underneath the middle of the table, as these bases are positioned near to the table ends. Wood elements on bases will be finished in the same finish as the top if no finish is specified. Metal elements are available in Satin Aluminum finish. All bases are shipped separately and require assembly to the selected top.

VIRTU | FEATURES & OPTIONS

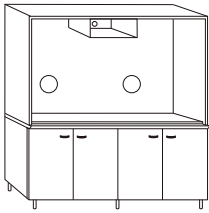

MEDIA CABINETS

- Media Cabinets are available in three sizes.
- Dual Media Cabinets accommodate two televisions up to 35" in width.
- Large cabinets accommodate televisions up to 35" in width. Small cabinets up to 27" in width.
- Cabinets may be specified with wood veneer doors or with frosted glass in aluminum frames.
- Large cabinets feature synchronized upper doors, pocket doors or hinged doors that open 170 degrees.
- Optional wood or glass doors.
- All horizontal levels of the cabinet interior are accessible through grommets in the rear of each shelf - additional holes are located in the case back for wall entry of power and cables.
- Locks are optional on wood doors only.
- Unique leveling glides adjust to uneven floors without exposing the glide.
- Optional Rollout Equipment Rack and Cable Carrier in the lower portion of the cabinet is available with the Large model at **\$3188 list**.
- Dual Media Cabinets and Small Media Cabinets are available with heavy duty locking casters at a price of **\$208 list** per unit.
- Upper shelf accommodates videoconferencing camera.

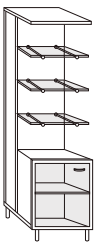
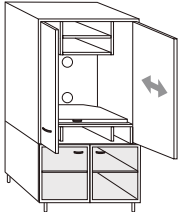

DISPLAY CABINETS

- Available as single or double widths.
- Some units come equipped with wardrobes located behind the front display cabinets.
- Wardrobes on 21" wide Display Cabinets are equipped with 3 coat hooks.
- Wardrobes on 42" wide Display Cabinets are equipped with a hanger bar.
- All wardrobes have a rubber floor mat.
- Available with open glass or wood veneer shelf options.
- Available with wood veneer doors or glass doors.
- Interior wood shelves are height adjustable in increments of 1 1/4".
- Glass shelved units feature a halogen light at a price of **\$582**.
- Glass shelves are 7.8" deep. Wood shelves are 11.8" deep.
- Open shelves are glass.
- Closed shelves are wood veneer.
- Locks are optional on wood doors only.
- Unique leveling glides adjust to uneven floors without exposing the glide.
- Single and double wardrobe units are available.
- Glass shelves are shipped wrapped in foam and secured to the front of the case.

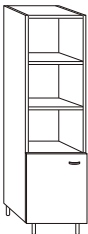

STORAGE CABINETS

- Available in single and double widths.
- Locks are optional on wood doors only.
- Available with wood veneer doors or glass doors.
- Shelves are height adjustable in increments of 1 1/4".
- Unique leveling glides adjust to uneven floors without exposing the glide.

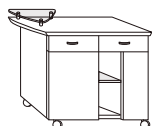

SERVER CARTS

- A unique raised glass platform and rear overhang provide a guest "serving" area.
- The cart is mounted on heavy-duty locking casters.
- The top surface overhang and underside finger groove facilitate movement of the cart.
- The cart features a stainless steel refuse container and black felt cutlery insert.
- Glass shelves are shipped wrapped in foam and placed securely in the case.

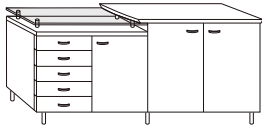

CREDENZAS AND BUFFETS

- 3 styles of cabinet tops are available: wood top, glass top and glass and wood combination.
- Doors are available in glass and wood veneer.
- Storage sections feature one wooden shelf which is height adjustable in increments of 1 1/4".
- Unique leveling glides adjust without exposing the glide.
- Buffets with wood drawers feature a black felt cutlery insert.
- Buffet may be specified with optional Mini Refrigerator on 24" deep Buffets at a price of **\$2638 list**.
- Mini refrigerator features volume of 1.1 cu. ft., 2 inner door racks, automatic defrost, and lock.
- Credenzas and Buffets with partial glass tops are shipped with glass installed.
- Credenzas and Buffets with full glass tops are shipped unattached with glass wrapped in foam.

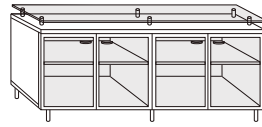

MOBILE MEDIA CARTS

- The primary cart surface can accommodate a keyboard or laptop, which in turn can be connected to a TV or monitor on upper surface.
- The top surface overhang and underside finger groove facilitate movement of the cart.
- A built-in power bar and cable slot in the upper column provide ready access to power.
- The unit is oriented to provide the correct position for the presenter.
- The cart may be specified with one or two equipment shelves on the top of the unit.
- Media Carts will generally accommodate monitors up to 27" in size.

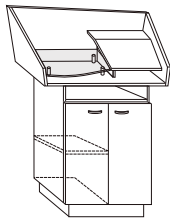

LECTERNS

- Glass shelf version has a wood upper flat shelf which provides a place for pens, pencils or a glass of water, and optional reference light at a price of **\$465 list**. It will also accommodate a user-specified microphone.
- Angled wood shelf has a bottom lip to hold papers in place. The shelf lifts to reveal an optional power and data interface point – an Altinex box at a price of **\$1336 list**.
- Glass shelf provides more surface area for equipment such as a laptop. A presenter's open laptop is not visible to the seated audience.
- Wires from the interface point, (or user supplied cables) are routed down through grommets holes to the back of the unit - to facilitate routing and access to these cables, a hinged back access door opens to reveal a cableway and optional power bar at a price of **\$208 list**.
- Full width shelf version is available.
- Lecterns are available with front hinged doors or open shelves.
- Mobile versions are available.
- Glass shelf is shipped installed.

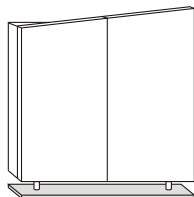
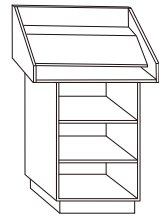

VISUAL BOARDS

- Includes white board for use with four dry erase markers.
- Includes upholstered tackboard or optional cork surface on inside face of doors (except glass door version).
- Flip chart and four dry erase markers (except glass door version).
- Optional pull-down projector screen is available at a price of **\$278 list**.
- Inclined top model features lower glass shelf.

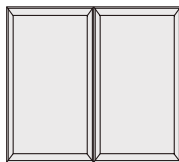

VIRTU | CONFERENCE ROOM SAMPLE LAYOUTS

OPEN VISIO

This table is available with seating capacities ranging from 9 to 15. The example shows the table in relation to the Dual Media Cabinet and Display Cabinets (with wardrobes). This Media Cabinet accommodates two 35" monitors side by side and other audio/visual equipment for videoconferencing or other presentation requirements. The table bases are Forza Leg bases. Connexus™ modules are indicated in standard locations.

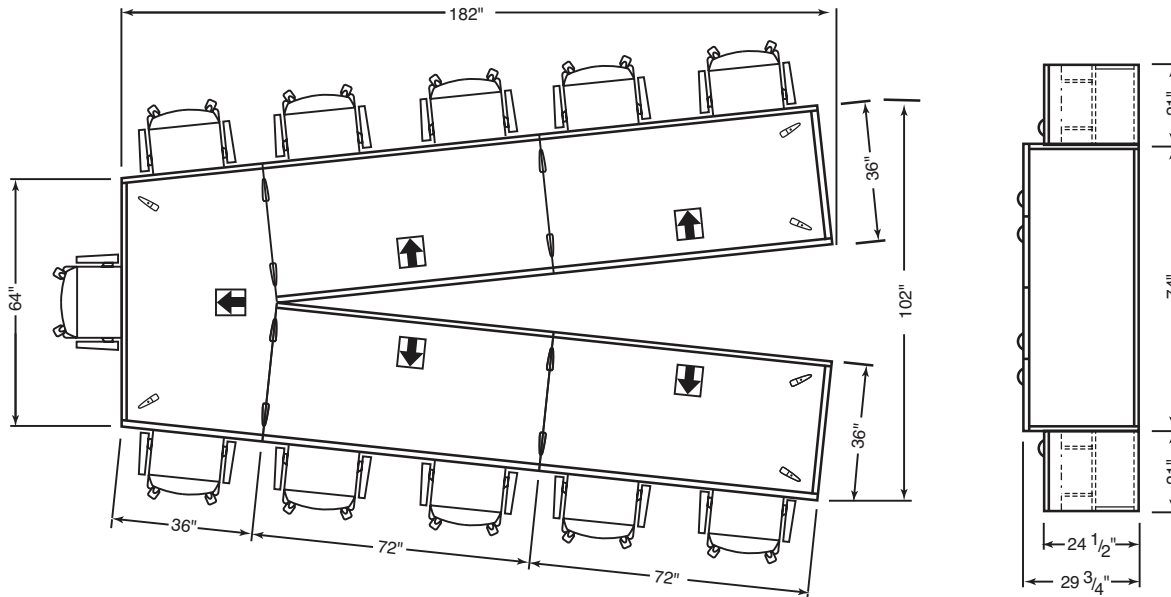

	Model Number	Cherry/Maple/Walnut	Anigre
1 Open Visio Top	6260-182-102-64	22300	24190
14 Forza Leg Bases	6238-29		
5 Connexus™ - Aluminum	62CON	6252	6252
1 Dual Media Cabinet	62MC-75307614	12286	13256
1 Display Cabinet	62DC-21247672L	4104	4721
1 Display Cabinet	62DC-21247672R	4104	4721
TOTAL (totals do not include seating)		74059	78154

VIRTU | CONFERENCE ROOM SAMPLE LAYOUTS

VERSO

This table is available with seating capacities ranging from 9 to 14. The example shows the table in relation to a Large Media Cabinet and Double Display Cabinets (with wardrobes) and Lectern. This Media Cabinet accommodates a 35" monitor and other audio/visual equipment for video-conferencing or other presentation requirements. The table bases are Forza Square and Verso bases. Connexus™ modules are indicated in standard locations.

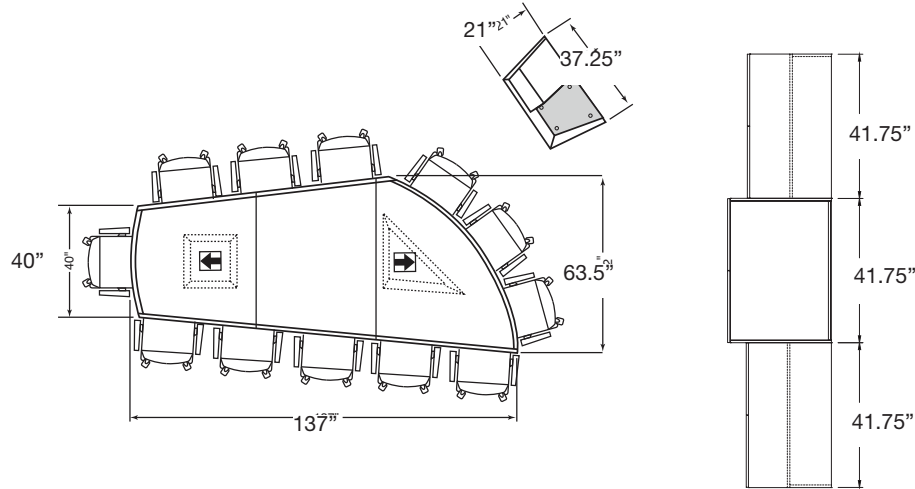

Model Number

1 Verso Top 6258-137-63-40
 1 Forza Square Base 6234-14-14-29
 1 Verso Base 6231-18-19-29

2 Connexus™ - Aluminum 62CON
 1 Large Media Cabinet 62MC-42308514A
 1 Double Display Cabinet 62DC-42247671L
 1 Double Display Cabinet 62DC-42247671R
 1 Lectern 62LN-37225011

Cherry/Maple/Walnut

14836

2138
7864
5777
5777
6519

Anigre

16950

2138
9042
6642
6642
7493

TOTAL

(totals do not include seating)

45052

51048

ARCED RECTANGLE

This table is available with seating capacities ranging from 6 to 20. The example shows the table in relation to the Dual Media Cabinet. This Media Cabinet accommodates two 32" monitors side by side and other audio/visual equipment for videoconferencing or other presentation requirements. The table bases are Dais bases. Connexus™ modules are indicated in standard locations.

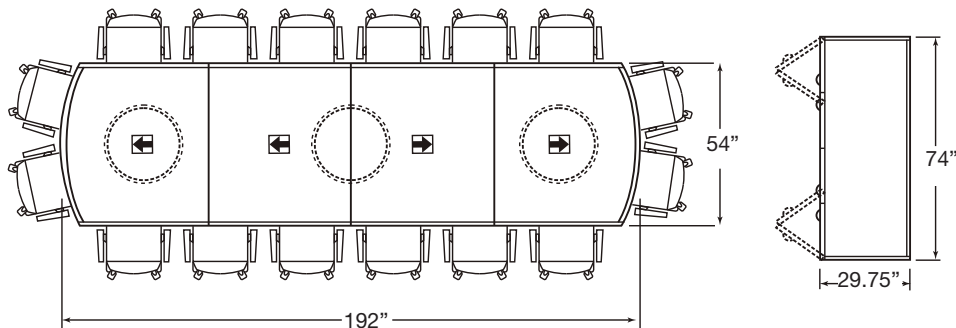

1 Arced Rectangle Top
 3 Dais Bases

Model Number
 6256-192-54
 6230-24D-29

Cherry/Maple/Walnut

15122

4274
12286

Anigre

17399

4274
13256

TOTAL

(totals do not include seating)

44506

47754

VIRTU | CONFERENCE TABLE SPECIFICATIONS

Description	Top Size	Approximate Seating	No. of Sections	Shipping Weight	Cubic Feet
Conference Table Top – Rectangle 6251	72-36	6	1	100	10.7
	84-42	6	1	140	15
	96-42	8	2	180	16.8
	96-48	8	2	200	18.8
	120-48	10	3	240	24.2
	120-54	10	3	265	26.5
	144-54	12	3	310	28.2
	168-54	12	4	355	36.8
	192-54	14	4	400	41.2
	216-60	16	5	490	53.2
	240-60	18	5	560	58
	264-60	20	6	630	64.8
	288-60	22	6	700	69.6



Conference tables up to and including 168" in length are available on the KrugExpress quick ship program.

Description	Base Size	W	D	H	Shipping Weight	Cubic Feet
Forza Leg Base 6238	29	6	n/a	28	15	0.9



Forza Square 6234	14-14-29	14	14	28	177	6.5
-------------------	----------	----	----	----	-----	-----

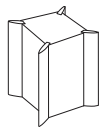

Forza Panel Base 6232	24-29	24	n/a	28	54	5.5
	30-29	30	n/a	28	56	6.4



Forza Rectangle Base 6233	13-30-29	13	30	28	126	10.8
---------------------------	----------	----	----	----	-----	------

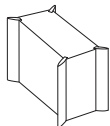

DIMENSION KEY

L – length
W – width
H – height

Model numbers represent nominal dimensions only. Contact Customer Service if dimensions are critical.

SPECIAL FEATURES

Conference tops are designed to accommodate microphones, which can be field installed. Please contact Customer Service for more information on where they can be positioned. Custom table sizes are available. Please contact Customer Service or your local Krug representative.



“Base Size” represents wood dimensions and does not include metal accents. Please contact Customer Service if dimensions are critical.

Bookmatched Birdseye Maple veneer is available on VIRTU Conference Table Tops at an upcharge of **\$76 list** per square foot.

Conference tops may be ordered with a reduced number of sections at an upcharge. Please contact Customer Service or your local Krug representative for details.

VIRTU | CONFERENCE TABLE PRICING AND MODEL NUMBERS

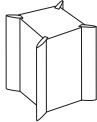
Shown below are model numbers and pricing for VIRTU conference tops and bases. The pricing is the combined price of the top and the base(s) that are cross-referenced in the chart. Please note that some bases are not available on all tops. Only the top and base combinations listed are available. When ordering, please specify the model number of the top, the model number(s) of the base(s), followed by their combined price. See bottom page for Conference Table Ordering Procedure.

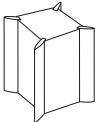
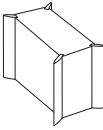
Rectangle Table Top 6251	GROUP 1				GROUP 2					
	FORZA LEG 6238	FORZA SQUARE 6234	PRICE FOR TOP AND BASE(S)	PRICE FOR TOP AND BASE(S)	FORZA PANEL 6232	FORZA SQUARE 6234	FORZA RECT. 6233	PRICE FOR TOP AND BASE(S)	PRICE FOR TOP AND BASE(S)	
										
MODEL #	6238-29	6234-14-14-29	MAPLE/ CHERRY/ WALNUT	ANIGRE	6232-24-29	6232-30-29	6234-14-14-29	6233-13-30-29	MAPLE/ CHERRY/ WALNUT	ANIGRE
	QTY	QTY			QTY	QTY	QTY	QTY		
6251-72 - 36	4		4571	5110	2				5287	6079
6251-84 - 42	4		5603	6292	2				6315	7262
6251-96 - 42	4		6039	6794	2				6753	7763
6251-96 - 48	4		6477	7303	2				7192	8268
6251-120 - 48	4	+ 1	8815	9997	2		+ 1		9534	11044
6251-120 - 54	4	+ 1	9389	10657		2	+ 1		10171	11701
6251-144 - 54	4	+ 1	10440	11866		2	+ 1		11604	13348
6251-168 - 54	4	+ 2	13306	15159		2	+ 1		13272	15263
6251-192 - 54	4	+ 2	14211	16201		2	+ 2		15762	18128
6251-216 - 60	4	+ 3	16971	19384		2	+ 2		17325	19922
6251-240 - 60	4	+ 3	18348	20967		2	+ 2		18704	21512
6251-264 - 60	4	+ 4	20921	23933		2	+ 2		20076	23090
6251-288 - 60	4	+ 4	22311	25525		2	+ 3		23050	26506

ORDERING PROCEDURE

Please specify the following:

1. Select Table Top shape, size, model number and wood species.
2. Select Table Base(s), size, model number, quantity and wood species.
3. Obtain Table Price by cross-referencing selected top with selected base(s). The prices listed are the combined total of the top and base(s).
4. Select Connexus™ Module(s) and a Location Code for either a Glass or Satin Aluminum module.
Add pricing for the selected Connexus™ Module(s) to the table price.
5. Select Monument Location(s) and provide monument location code(s) on purchase order.
6. Select a Wood Finish
7. Select an Edge Profile.

Model numbers represent nominal dimensions only (in inches). Contact Customer Service if dimensions are critical.

VIRTU | CONFERENCE TABLE SPECIFICATIONS

Description	Top Size	Approximate Seating	No. of Sections	Shipping Weight	Cubic Feet
Conference Table Top – Rectangle 6251	84-42	6	1	140	15
	96-42	8	2	180	16.8
	96-48	8	2	200	18.8
	120-48	10	3	240	24.2
	120-54	10	3	265	26.5
	144-54	12	3	310	28.2
	168-54	12	4	355	36.8
	192-54	14	4	400	41.2
	216-60	16	5	490	53.2
	240-60	18	5	560	58
	264-60	20	6	630	64.8
	288-60	22	6	700	69.6



Conference tables up to and including 168" in length are available on the KrugExpress quick ship program.

Description	Base Size	W	D	H	Shipping Weight	Cubic Feet
Forza Square Base 6234	14-14-29	14	14	28	177	6.5
	20-20-29	20	20	28	199	10.9
	26-26-29	26	26	28	225	17.6

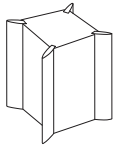

Dais Base 6230	18D-29	18 dia.	n/a	28	149	6.5
	24D-29	24 dia.	n/a	28	171	10.9
	30D-29	30 dia.	n/a	28	196	17.6

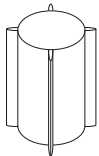

Oblique Base 6237	18-18-29	18	18	28	149	6.5
	24-24-29	24	24	28	171	10.9
	30-30-29	30	30	28	196	17.6

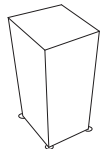

DIMENSION KEY

L – length
W – width
H – height

Model numbers represent nominal dimensions only. Contact Customer Service if dimensions are critical.

SPECIAL FEATURES

Conference tops are designed to accommodate microphones, which can be field installed. Please contact Customer Service for more information on where they can be positioned. Custom table sizes are available. Please contact Customer Service or your local Krug representative.

“Base Size” represents wood dimensions and does not include metal accents. Please contact Customer Service if dimensions are critical.

Bookmatched Birdseye Maple veneer is available on VIRTU Conference Table Tops at an upcharge of **\$76 list per square foot**.

Conference tops may be ordered with a reduced number of sections at an upcharge. Please contact Customer Service or your local Krug representative for details.

VIRTU | CONFERENCE TABLE PRICING AND MODEL NUMBERS

Shown below are model numbers and pricing for VIRTU conference tops and bases. The pricing is the combined price of the top and the base(s) that are cross-referenced in the chart. Please note that some bases are not available on all tops. Only the top and base combinations listed are available. When ordering, please specify the model number of the top, the model number(s) of the base(s), followed by their combined price. See bottom page for Conference Table Ordering Procedure.

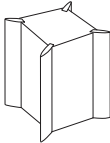
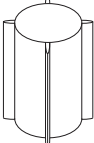
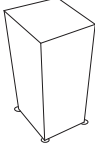
Rectangle Table Top 6251	GROUP 3					GROUP 4					GROUP 5				
	FORZA SQUARE 6234 			PRICE FOR TOP AND BASE(S)	PRICE FOR TOP AND BASE(S)	DAIS 6230 			PRICE FOR TOP AND BASE(S)	PRICE FOR TOP AND BASE(S)	OBLIQUE 6237 			PRICE FOR TOP AND BASE(S)	PRICE FOR TOP AND BASE(S)
	MODEL #	6234-14- 14-29 QTY	6234-20- 20-29 QTY	6234-26- 26-29 QTY	MAPLE/ CHERRY/ WALNUT	ANIGRE	6230- 18D-29 QTY	6230- 24D-29 QTY	6230- 30D29 QTY	MAPLE/ CHERRY/ WALNUT	ANIGRE	6237-18- 18-29 QTY	6237-24- 24-29 QTY	6237-30- 30-29 QTY	MAPLE/ CHERRY/ WALNUT
6251-72 - 36	2			5989	6895				6072	6982				6939	7974
6251-84 - 42	2			7016	8077	2			7104	8167	2			7374	8478
6251-96 - 42	2			7452	8579	2			7537	8667	2			7818	8985
6251-96 - 48	2			7893	9086	2			7974	9174	2			8955	10299
6251-120-48	2			9036	10399	2			9118	10486	2			9610	11048
6251-120-54		2		9793	11246		2		9772	11240		2		10659	12254
6251-144-54		2		10841	12455		2		10821	12447		2		12322	15548
6251-168-54		3		13797	15850		3		13768	15839		3		13230	16588
6251-192-54		3		14701	16890		3		14672	16879		3		16112	18533
6251-216-60			3	16506	18686			3	16356	18812			3	18734	21544
6251-240-60			4	19260	22144			4	19057	21921			4	20105	23124
6251-264-60			4	20631	23725			4	20431	23502			4	21494	24719
6251-288-60			4	22017	25319			4	21816	25096			4		

ORDERING PROCEDURE

Please specify the following:

1. Select Table Top shape, size, model number and wood species.
2. Select Table Base(s), size, model number, quantity and wood species.
3. Obtain Table Price by cross-referencing selected top with selected base(s). The prices listed are the combined total of the top and base(s).
4. Select Connexus™ Module(s) and a Location Code for either a Glass or Satin Aluminum module.
Add pricing for the selected Connexus™ Module(s) to the table price.
5. Select Monument Location(s) and provide monument location code(s) on purchase order.
6. Select a Wood Finish
7. Select an Edge Profile.

Model numbers represent nominal dimensions only (in inches). Contact Customer Service if dimensions are critical.

VIRTU | CONFERENCE TABLE SPECIFICATIONS

Description	Top Size	Approximate Seating	No. of Sections	Shipping Weight	Cubic Feet
Conference Table Top – Arced Rectangle	72-36	6	1	100	10.7
6256	84-42	6	1	140	15
	96-42	8	2	180	16.8
	96-48	8	2	200	18.8
	120-48	10	3	240	24.2
	120-54	10	3	265	26.5
	144-54	12	3	310	28.2
	168-54	12	4	355	36.8
	192-54	14	4	400	41.2
	216-60	16	5	490	53.2
	240-60	18	5	560	58
	264-60	20	6	630	64.8
	288-60	22	6	700	69.6

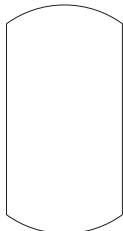

Conference tables up to and including 168" in length are available on the KrugExpress quick ship program.

Description	Base Size	W	D	H	Shipping Weight	Cubic Feet
Forza Leg Base 6238	29	6	n/a	28	15	0.9



Forza Square 6234	14-14-29	14	14	28	177	6.5
-------------------	----------	----	----	----	-----	-----

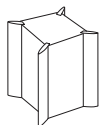

Forza Panel Base 6232	24-29	24	n/a	28	54	5.5
	30-29	30	n/a	28	56	6.4



Forza Rectangle Base 6233	13-30-29	13	30	28	126	10.8
---------------------------	----------	----	----	----	-----	------

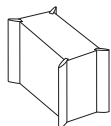

DIMENSION KEY

L – length
W – width
H – height

Model numbers represent nominal dimensions only. Contact Customer Service if dimensions are critical.

SPECIAL FEATURES

Conference tops are designed to accommodate microphones, which can be field installed. Please contact Customer Service for more information on where they can be positioned. Custom table sizes are available. Please contact Customer Service or your local Krug representative.



“Base Size” represents wood dimensions and does not include metal accents. Please contact Customer Service if dimensions are critical.

Bookmatched Birdseye Maple veneer is available on VIRTU Conference Table Tops at an upcharge of **\$76 list per square foot**.

Conference tops may be ordered with a reduced number of sections at an upcharge. Please contact Customer Service or your local Krug representative for details.

VIRTU | CONFERENCE TABLE PRICING AND MODEL NUMBERS

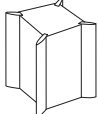
Shown below are model numbers and pricing for VIRTU conference tops and bases. The pricing is the combined price of the top and the base(s) that are cross-referenced in the chart. Please note that some bases are not available on all tops. Only the top and base combinations listed are available. When ordering, please specify the model number of the top, the model number(s) of the base(s), followed by their combined price. See bottom page for Conference Table Ordering Procedure.

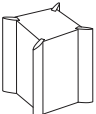
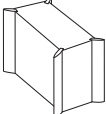
Arced Rectangle Table Top 6256	GROUP 1				GROUP 2						
	FORZA LEG 6238	FORZA SQUARE 6234	PRICE FOR TOP AND BASE(S)	PRICE FOR TOP AND BASE(S)	FORZA PANEL 6232	FORZA SQUARE 6234	FORZA RECT. 6233	PRICE FOR TOP AND BASE(S)	PRICE FOR TOP AND BASE(S)		
											
MODEL #	6238-29	6234-14-14-29	MAPLE/CHERRY/WALNUT	ANIGRE	6232-24-29	6232-30-29	6234-14-14-29	6233-13-30-29	MAPLE/CHERRY/WALNUT	ANIGRE	
	QTY	QTY			QTY	QTY	QTY	QTY			
6256-72 - 36	4		4722	5285	2				5436	6252	
6256-84 - 42	4		5793	6518	2				6508	7482	
6256-96 - 42	4		6247	7040	2				6965	8010	
6256-96 - 48	4		6709	7567	2				7421	8535	
6256-120 - 48	4	+	9095	10315	2		+	1	9809	11284	
6256-120 - 54	4	+	9691	11007		2	+	1	10470	12048	
6256-144 - 54	4	+	10783	12260		2		+	1	11954	13743
6256-168 - 54	4	+	13718	15638		2		+	1	13684	15734
6256-192 - 54	4	+	14661	16720		2		+	2	16214	18649
6256-216 - 60	4	+	17488	19975		2		+	2	17841	20519
6256-240 - 60	4	+	18923	21631		2		+	2	19278	22171
6256-264 - 60	4	+	21553	24658		2		+	2	20709	23810
6256-288 - 60	4	+	22998	26319		2		+	3	23739	27300

ORDERING PROCEDURE

Please specify the following:

1. Select Table Top shape, size, model number and wood species.
2. Select Table Base(s), size, model number, quantity and wood species.
3. Obtain Table Price by cross-referencing selected top with selected base(s). The prices listed are the combined total of the top and base(s).
4. Select Connexus™ Module(s) and a Location Code for either a Glass or Satin Aluminum module. Add pricing for the selected Connexus™ Module(s) to the table price.
5. Select Monument Location(s) and provide monument location code(s) on purchase order.
6. Select a Wood Finish
7. Select an Edge Profile.

Model numbers represent nominal dimensions only (in inches). Contact Customer Service if dimensions are critical.

VIRTU | CONFERENCE TABLE SPECIFICATIONS

Description	Top Size	Approximate Seating	No. of Sections	Shipping Weight	Cubic Feet
Conference Table Top – Arced Rectangle 6256	84-42	6	1	140	15
	96-42	8	2	180	16.8
	96-48	8	2	200	18.8
	120-48	10	3	240	24.2
	120-54	10	3	265	26.5
	144-54	12	3	310	28.2
	168-54	12	4	355	36.8
	192-54	14	4	400	41.2
	216-60	16	5	490	53.2
	240-60	18	5	560	58
	264-60	20	6	630	64.8
	288-60	22	6	700	69.6

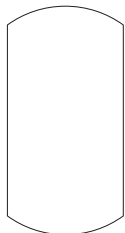

Description	Base Size	W	D	H	Shipping Weight	Cubic Feet
Forza Square Base 6234	14-14-29	14	14	28	177	6.5
	20-20-29	20	20	28	199	10.9
	26-26-29	26	26	28	225	17.6

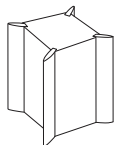

Dais Base 6230	18D-29	18 dia.	n/a	28	149	6.5
	24D-29	24 dia.	n/a	28	171	10.9
	30D-29	30 dia.	n/a	28	196	17.6

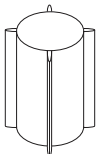

Oblique Base 6237	18-18-29	18	18	28	149	6.5
	24-24-29	24	24	28	171	10.9
	30-30-29	30	30	28	196	17.6



DIMENSION KEY

L – length
W – width
H – height

Model numbers represent nominal dimensions only. Contact Customer Service if dimensions are critical.

SPECIAL FEATURES

Conference tops are designed to accommodate microphones, which can be field installed. Please contact Customer Service for more information on where they can be positioned. Custom table sizes are available. Please contact Customer Service or your local Krug representative.

“Base Size” represents wood dimensions and does not include metal accents. Please contact Customer Service if dimensions are critical.

Bookmatched Birdseye Maple veneer is available on VIRTU Conference Table Tops at an upcharge of **\$76 list per square foot**.

Conference tops may be ordered with a reduced number of sections at an upcharge. Please contact Customer Service or your local Krug representative for details.

VIRTU | CONFERENCE TABLE PRICING AND MODEL NUMBERS

Shown below are model numbers and pricing for VIRTU conference tops and bases. The pricing is the combined price of the top and the base(s) that are cross-referenced in the chart. Please note that some bases are not available on all tops. Only the top and base combinations listed are available. When ordering, please specify the model number of the top, the model number(s) of the base(s), followed by their combined price. See bottom page for Conference Table Ordering Procedure.

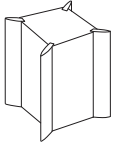
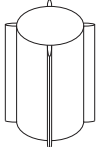
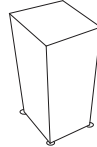
Arced Rectangle Table Top 6256	GROUP 3					GROUP 4					GROUP 5				
	FORZA SQUARE 6234			PRICE FOR TOP AND BASE(S)	PRICE FOR TOP AND BASE(S)	DAIS 6230			PRICE FOR TOP AND BASE(S)	PRICE FOR TOP AND BASE(S)	OBLIQUE 6237			PRICE FOR TOP AND BASE(S)	PRICE FOR TOP AND BASE(S)
															
MODEL #	6234-14-14-29	6234-20-20-29	6234-26-26-29	MAPLE/CHERRY/WALNUT	ANIGRE	6230-18D-29	6230-24D-29	6230-30D29	MAPLE/CHERRY/WALNUT	ANIGRE	6237-18-18-29	6237-24-24-29	6237-30-30-29	MAPLE/CHERRY/WALNUT	ANIGRE
	QTY	QTY	QTY			QTY	QTY	QTY			QTY	QTY	QTY		
6256-72-36	2			6139	7069	2			6221	7155					
6256-84 - 42	2			7211	8300	2			7293	8387	2			7131	8198
6256-96 - 42	2			7660	8826	2			7749	8912	2			7587	8724
6256-96 - 48	2			8121	9349	2			8206	9438	2			8045	9249
6256-120-48	2			9310	10717	2			9394	10805	2			9232	10616
6256-120-54		2		10090	11594		2		10070	11586		2		9909	11392
6256-144-54		2		11186	12850		2		11164	12842		2		11008	12647
6256-168-54		3		14213	16325		3		14182	16313		3		13938	16024
6256-192-54		3		15152	17410		3		15122	17399		3		14884	17111
6256-216-60			3	17019	19573			3	16870	19409			3	16629	19123
6256-240-60			4	19834	22806			4	19632	22585			4	19309	22207
6256-264-60			4	21262	24450			4	21063	24224			4	20739	23849
6256-288-60			4	22706	26111			4	22505	25889			4	22184	25511

ORDERING PROCEDURE

Please specify the following:

1. Select Table Top shape, size, model number and wood species.
2. Select Table Base(s), size, model number, quantity and wood species.
3. Obtain Table Price by cross-referencing selected top with selected base(s). The prices listed are the combined total of the top and base(s).
4. Select Connexus™ Module(s) and a Location Code for either a Glass or Satin Aluminum module.
Add pricing for the selected Connexus™ Module(s) to the table price.
5. Select Monument Location(s) and provide monument location code(s) on purchase order.
6. Select a Wood Finish
7. Select an Edge Profile.

Model numbers represent nominal dimensions only (in inches). Contact Customer Service if dimensions are critical.

VIRTU | CONFERENCE TABLE SPECIFICATIONS

Description	Top Size	Approximate Seating	No. of Sections	Shipping Weight	Cubic Feet
Conference Table Top – Racetrack 6252	72-36	6	1	100	10.7
	84-42	6	1	140	15
	96-42	8	2	180	16.8
	96-48	8	2	200	18.8
	120-48	10	3	240	24.2
	120-54	10	3	265	26.5
	144-54	12	3	310	28.2
	168-54	12	4	355	36.8
	192-54	14	4	400	41.2
	216-60	16	5	490	53.2
	240-60	18	5	560	58
	264-60	20	6	630	64.8
	288-60	22	6	700	69.6

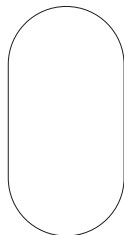

Conference tables up to and including 168" in length are available on the KrugExpress quick ship program.

Description	Base Size	W	D	H	Shipping Weight	Cubic Feet
Forza Leg Base 6238	29	6	n/a	28	15	0.9



Forza Square 6234	14-14-29	14	14	28	177	6.5
-------------------	----------	----	----	----	-----	-----

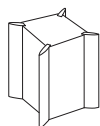

Forza Panel Base 6232	24-29	24	n/a	28	54	5.5
	30-29	30	n/a	28	56	6.4



Forza Rectangle Base 6233	13-30-29	13	30	28	126	10.8
---------------------------	----------	----	----	----	-----	------

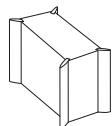

DIMENSION KEY

L – length
W – width
H – height

Model numbers represent nominal dimensions only. Contact Customer Service if dimensions are critical.

SPECIAL FEATURES

Conference tops are designed to accommodate microphones, which can be field installed. Please contact Customer Service for more information on where they can be positioned. Custom table sizes are available. Please contact Customer Service or your local Krug representative.



“Base Size” represents wood dimensions and does not include metal accents. Please contact Customer Service if dimensions are critical.

Bookmatched Birdseye Maple veneer is available on VIRTU Conference Table Tops at an upcharge of **\$76 list per square foot**.

Conference tops may be ordered with a reduced number of sections at an upcharge. Please contact Customer Service or your local Krug representative for details.

VIRTU | CONFERENCE TABLE PRICING AND MODEL NUMBERS

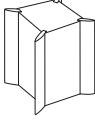
Shown below are model numbers and pricing for VIRTU conference tops and bases. The pricing is the combined price of the top and the base(s) that are cross-referenced in the chart. Please note that some bases are not available on all tops. Only the top and base combinations listed are available. When ordering, please specify the model number of the top, the model number(s) of the base(s), followed by their combined price. See bottom page for Conference Table Ordering Procedure.

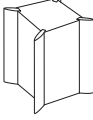
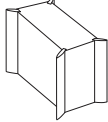
	GROUP 1				GROUP 2							
	FORZA LEG 6238 	FORZA SQUARE 6234 	PRICE FOR TOP AND BASE(S)	PRICE FOR TOP AND BASE(S)	FORZA PANEL 6232 	FORZA SQUARE 6234 	FORZA RECT. 6233 	PRICE FOR TOP AND BASE(S)	PRICE FOR TOP AND BASE(S)			
Racetrack Table Top 6252	6238-29	6234-14-14-29	MAPLE/ CHERRY/ WALNUT	ANIGRE	6232-24-29	6232-30-29	6234-14-14-29	6233-13-30-29	MAPLE/ CHERRY/ WALNUT	ANIGRE		
	QTY	QTY			QTY	QTY	QTY	QTY				
6252-72 - 36	4		5263	6126	2				6170	7095		
6252-84 - 42	4		5757	6474	2				6474	7443		
6252-96 - 42	4		6060	6821	2				6777	7789		
6252-96 - 48	4		6472	7294	2				7189	8263		
6252-120 - 48	4	+	1	9217	10453	2		+	1	9931	11422	
6252-120 - 54	4	+	1	9718	11033		2	+	1	10495	12076	
6252-144 - 54	4	+	1	10606	12057		2		+	1	11770	13538
6252-168 - 54	4	+	2	13508	15398		2		+	1	13478	15498
6252-192 - 54	4	+	2	14429	16452		2		+	2	15978	18377
6252-216 - 60	4	+	3	17630	20141		2		+	2	17983	20683
6252-240 - 60	4	+	3	19073	21799		2		+	2	19420	22341
6252-264 - 60	4	+	4	21725	24852		2		+	2	20877	24012
6252-288 - 60	4	+	4	22849	26145		2		+	3	23590	27125

ORDERING PROCEDURE

Please specify the following:

1. Select Table Top shape, size, model number and wood species.
2. Select Table Base(s), size, model number, quantity and wood species.
3. Obtain Table Price by cross-referencing selected top with selected base(s). The prices listed are the combined total of the top and base(s).
4. Select Connexus™ Module(s) and a Location Code for either a Glass or Satin Aluminum module.
Add pricing for the selected Connexus™ Module(s) to the table price.
5. Select Monument Location(s) and provide monument location code(s) on purchase order.
6. Select a Wood Finish
7. Select an Edge Profile.

Model numbers represent nominal dimensions only (in inches). Contact Customer Service if dimensions are critical.

VIRTU | CONFERENCE TABLE SPECIFICATIONS

Description	Top Size	Approximate Seating	No. of Sections	Shipping Weight	Cubic Feet
Conference Table Top – Racetrack 6252	84-42	6	1	140	15
	96-42	8	2	180	16.8
	96-48	8	2	200	18.8
	120-48	10	3	240	24.2
	120-54	10	3	265	26.5
	144-54	12	3	310	28.2
	168-54	12	4	355	36.8
	192-54	14	4	400	41.2
	216-60	16	5	490	53.2
	240-60	18	5	560	58
	264-60	20	6	630	64.8
	288-60	22	6	700	69.6

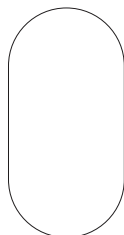

Conference tables up to and including 168" in length are available on the KrugExpress quick ship program.

Description	Base Size	W	D	H	Shipping Weight	Cubic Feet
Forza Square Base 6234	14-14-29	14	14	28	177	6.5
	20-20-29	20	20	28	199	10.9
	26-26-29	26	26	28	225	17.6

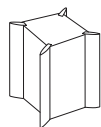

Dais Base 6230	18D-29	18 dia.	n/a	28	149	6.5
	24D-29	24 dia.	n/a	28	171	10.9
	30D-29	30 dia.	n/a	28	196	17.6

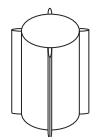

DIMENSION KEY

L — length
W — width
H — height

Model numbers represent nominal dimensions only. Contact Customer Service if dimensions are critical.

SPECIAL FEATURES

Conference tops are designed to accommodate microphones, which can be field installed. Please contact Customer Service for more information on where they can be positioned. Custom table sizes are available. Please contact Customer Service or your local Krug representative.

“Base Size” represents wood dimensions and does not include metal accents. Please contact Customer Service if dimensions are critical.

Bookmatched Birdseye Maple veneer is available on VIRTU Conference Table Tops at an upcharge of **\$76 list per square foot**.

Conference tops may be ordered with a reduced number of sections at an upcharge. Please contact Customer Service or your local Krug representative for details.

VIRTU | CONFERENCE TABLE PRICING AND MODEL NUMBERS

Shown below are model numbers and pricing for VIRTU conference tops and bases. The pricing is the combined price of the top and the base(s) that are cross-referenced in the chart. Please note that some bases are not available on all tops. Only the top and base combinations listed are available. When ordering, please specify the model number of the top, the model number(s) of the base(s), followed by their combined price. See bottom page for Conference Table Ordering Procedure.

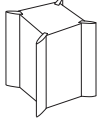
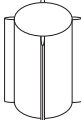
Racetrack Table Top 6252	GROUP 3					GROUP 4				
	FORZA SQUARE 6234			PRICE FOR TOP AND BASE(S)	PRICE FOR TOP AND BASE(S)	DAIS 6230			PRICE FOR TOP AND BASE(S)	PRICE FOR TOP AND BASE(S)
										
MODEL #	6234-14- 14-29	6234-20- 20-29	6234-26- 26-29	MAPLE/ CHERRY/ WALNUT	ANIGRE	6230- 18d-29	6230- 24d-29	6230- 30d-29	MAPLE/ CHERRY/ WALNUT	ANIGRE
	QTY	QTY	QTY			QTY	QTY	QTY		
6252-72 - 36	2			6871	7910	2			6959	7998
6252-84 - 42	2			7174	8260	2			7259	8345
6252-96 - 42	2			7476	8607	2			7560	8696
6252-96 - 48	2			7888	9080	2			7971	9168
6252-120-48	2			9432	10851	2			9515	10943
6252-120-54		2		10115	11625		2		10096	11618
6252-144-54		2		11009	12644		2		10987	12639
6252-168-54		3		14001	16086		3		13972	16071
6252-192-54		3		14919	17141		3		14893	17130
6252-216-60			3	17164	19738			3	17015	19572
6252-240-60			4	19982	22976			4	19782	22750
6252-264-60			4	21433	24644			4	21234	24420
6252-288-60			4	22557	25938			4	22356	25714

ORDERING PROCEDURE

Please specify the following:

1. Select Table Top shape, size, model number and wood species.
2. Select Table Base(s), size, model number, quantity and wood species.
3. Obtain Table Price by cross-referencing selected top with selected base(s). The prices listed are the combined total of the top and base(s).
4. Select Connexus™ Module(s) and a Location Code for either a Glass or Satin Aluminum module.
Add pricing for the selected Connexus™ Module(s) to the table price.
5. Select Monument Location(s) and provide monument location code(s) on purchase order.
6. Select a Wood Finish
7. Select an Edge Profile.

Model numbers represent nominal dimensions only (in inches). Contact Customer Service if dimensions are critical.

VIRTU | CONFERENCE TABLE SPECIFICATIONS

Description	Top Size	Approximate Seating	No. of Sections	Shipping Weight	Cubic Feet
Conference Table Top – Boat 6254	96-48-42	8	2	185	18.8
	120-48-42	10	3	255	24.2
	144-48-42	12	3	300	28.2
	168-48-42	12	4	345	36.8
	192-54-48	14	4	390	41.2
	216-54-48	16	5	480	47.1
	240-54-48	18	5	550	51.5
	264-60-48	20	6	620	64.8
	288-60-48	22	6	690	69.6

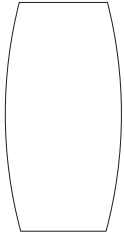

Conference tables up to and including 168" in length are available on the KrugExpress quick ship program.

Description	Base Size	W	D	H	Shipping Weight	Cubic Feet
Forza Leg Base 6238	29	6	n/a	28	15	0.9



Forza Square 6234	14-14-29	14	14	28	177	6.5
-------------------	----------	----	----	----	-----	-----

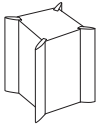

Forza Panel Base 6232	24-29	24	n/a	28	54	5.5
	30-29	30	n/a	28	56	6.4



Forza Rectangle Base 6233	13-30-29	13	30	28	126	10.8
---------------------------	----------	----	----	----	-----	------

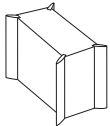

DIMENSION KEY

L – length
W – width
H – height

Model numbers represent nominal dimensions only. Contact Customer Service if dimensions are critical.

SPECIAL FEATURES

Conference tops are designed to accommodate microphones, which can be field installed. Please contact Customer Service for more information on where they can be positioned. Custom table sizes are available. Please contact Customer Service or your local Krug representative.



“Base Size” represents wood dimensions and does not include metal accents. Please contact Customer Service if dimensions are critical.

Bookmatched Birdseye Maple veneer is available on VIRTU Conference Table Tops at an upcharge of **\$76 list per square foot**.

Conference tops may be ordered with a reduced number of sections at an upcharge. Please contact Customer Service or your local Krug representative for details.

VIRTU | CONFERENCE TABLE PRICING AND MODEL NUMBERS

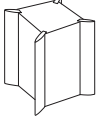
Shown below are model numbers and pricing for VIRTU conference tops and bases. The pricing is the combined price of the top and the base(s) that are cross-referenced in the chart. Please note that some bases are not available on all tops. Only the top and base combinations listed are available. When ordering, please specify the model number of the top, the model number(s) of the base(s), followed by their combined price. See bottom page for Conference Table Ordering Procedure.

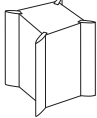
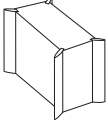
Boat Table Top 6254	GROUP 1				GROUP 2					
	FORZA LEG 6238	FORZA SQUARE 6234	PRICE FOR TOP AND BASE(S)	PRICE FOR TOP AND BASE(S)	FORZA PANEL 6232	FORZA SQUARE 6234	FORZA RECT. 6233	PRICE FOR TOP AND BASE(S)	PRICE FOR TOP AND BASE(S)	
										
MODEL #	6238-29	6234-14-14-29	MAPLE/ CHERRY/ WALNUT	ANIGRE	6232-24-29	6232-30-29	6234-14-14-29	6233-13-30-29	MAPLE/ CHERRY/ WALNUT	ANIGRE
	QTY	QTY			QTY	QTY	QTY	QTY		
6254-96-48-42	4		6750	7615	2				7464	8583
6254-120-48-42	4	+ 1	10096	11471	2		+ 1		10811	12440
6254-144-48-42	4	+ 1	11033	12541	2			+ 1	12134	13953
6254-168-48-42	4	+ 2	14017	15981	2			+ 1	13921	16008
6254-192-54-48	4	+ 2	14977	17085	2			+ 2	16467	18936
6254-216-54-48	4	+ 3	18283	20889	2			+ 2	18568	21354
6254-240-54-48	4	+ 3	19795	22630	2			+ 2	20087	23095
6254-264-60-48	4	+ 4	22521	25770	2			+ 2	21611	24851
6254-288-60-48	4	+ 4	23703	27134	2			+ 3	24381	28036

ORDERING PROCEDURE

Please specify the following:

1. Select Table Top shape, size, model number and wood species.
2. Select Table Base(s), size, model number, quantity and wood species.
3. Obtain Table Price by cross-referencing selected top with selected base(s). The prices listed are the combined total of the top and base(s).
4. Select Connexus™ Module(s) and a Location Code for either a Glass or Satin Aluminum module.
Add pricing for the selected Connexus™ Module(s) to the table price.
5. Select Monument Location(s) and provide monument location code(s) on purchase order.
6. Select a Wood Finish
7. Select an Edge Profile.

Model numbers represent nominal dimensions only (in inches). Contact Customer Service if dimensions are critical.

VIRTU | CONFERENCE TABLE SPECIFICATIONS

Description	Top Size	Approximate Seating	No. of Sections	Shipping Weight	Cubic Feet
Conference Table Top – Boat 6254	96-48-42	8	2	185	18.8
	120-48-42	10	3	255	24.2
	144-48-42	12	3	300	28.2
	168-48-42	12	4	345	36.8
	192-54-48	14	4	390	41.2
	216-54-48	16	5	480	47.1
	240-54-48	18	5	550	51.5
	264-60-48	20	6	620	64.8
	288-60-48	22	6	690	69.6

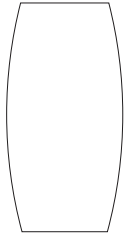

Conference tables up to and including 168" in length are available on the KrugExpress quick ship program.

Description	Base Size	W	D	H	Shipping Weight	Cubic Feet
Forza Square Base 6234	14-14-29	14	14	28	177	6.5
	20-20-29	20	20	28	199	10.9
	26-26-29	26	26	28	225	17.6

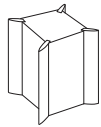

Description	Base Size	W	D	H	Shipping Weight	Cubic Feet
Dais Base 6230	18D-29	18 dia.	n/a	28	149	6.5
	24D-29	24 dia.	n/a	28	171	10.9
	30D-29	30 dia.	n/a	28	196	17.6



Description	Base Size	W	D	H	Shipping Weight	Cubic Feet
Oblique Base 6237	18-18-29	18	18	28	149	6.5
	24-24-29	24	24	28	171	10.9
	30-30-29	30	30	28	196	17.6

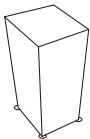

DIMENSION KEY

L – length
W – width
H – height

Model numbers represent nominal dimensions only. Contact Customer Service if dimensions are critical.

SPECIAL FEATURES

Conference tops are designed to accommodate microphones, which can be field installed. Please contact Customer Service for more information on where they can be positioned. Custom table sizes are available. Please contact Customer Service or your local Krug representative.

“Base Size” represents wood dimensions and does not include metal accents. Please contact Customer Service if dimensions are critical.

Bookmatched Birdseye Maple veneer is available on VIRTU Conference Table Tops at an upcharge of **\$76 list per square foot**.

Conference tops may be ordered with a reduced number of sections at an upcharge. Please contact Customer Service or your local Krug representative for details.

VIRTU | CONFERENCE TABLE PRICING AND MODEL NUMBERS

Shown below are model numbers and pricing for VIRTU conference tops and bases. The pricing is the combined price of the top and the base(s) that are cross-referenced in the chart. Please note that some bases are not available on all tops. Only the top and base combinations listed are available. When ordering, please specify the model number of the top, the model number(s) of the base(s), followed by their combined price. See bottom page for Conference Table Ordering Procedure.

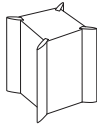
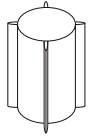
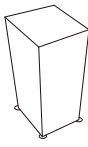
Boat Table Top 6254	GROUP 3					GROUP 4					GROUP 5				
	FORZA SQUARE 6234			PRICE FOR TOP AND BASE(S)	PRICE FOR TOP AND BASE(S)	DAIS 6230			PRICE FOR TOP AND BASE(S)	PRICE FOR TOP AND BASE(S)	OBLIQUE 6237			PRICE FOR TOP AND BASE(S)	PRICE FOR TOP AND BASE(S)
															
MODEL #	6234-14-14-29	6234-20-20-29	6234-26-26-29	MAPLE/ CHERRY/ WALNUT	ANIGRE	6230-18d-29	6230-24d-29	6230-30d-29	MAPLE/ CHERRY/ WALNUT	ANIGRE	6237-18-18-29	6237-24-24-29	6237-30-30-29	MAPLE/ CHERRY/ WALNUT	ANIGRE
	QTY	QTY	QTY			QTY	QTY	QTY			QTY	QTY	QTY		
6254-96-48-42	2			8162	9400	2			8250	9486	2			8085	9297
6254-120-48-42	3			10314	11871	2			10399	11957	2			10236	11768
6254-144-48-42	3			12447	14326	3			12573	14460	3			12336	14176
6254-168-48-42	3			14235	16383	3			14359	16516	3			14118	16233
6254-192-54-48	2	+	1	15286	17582	2	+	1	15361	17667	2	+	1	15116	17383
6254-216-54-48	2	+	1	17389	20001	2	+	1	17463	20088	2	+	1	17221	19801
6254-240-54-48	2	+	2	20197	23222	2	+	2	20260	23302	2	+	2	19939	22924
6254-264-60-48	2	+	2	21883	25174	2	+	2	21868	25149	2	+	2	21544	24773
6254-288-60-48	2	+	2	23072	26535	2	+	2	23052	26512	2	+	2	22730	26137

ORDERING PROCEDURE

Please specify the following:

1. Select Table Top shape, size, model number and wood species.
2. Select Table Base(s), size, model number, quantity and wood species.
3. Obtain Table Price by cross-referencing selected top with selected base(s). The prices listed are the combined total of the top and base(s).
4. Select Connexus™ Module(s) and a Location Code for either a Glass or Satin Aluminum module.
Add pricing for the selected Connexus™ Module(s) to the table price.
5. Select Monument Location(s) and provide monument location code(s) on purchase order.
6. Select a Wood Finish
7. Select an Edge Profile.

Model numbers represent nominal dimensions only (in inches). Contact Customer Service if dimensions are critical.

VIRTU | CONFERENCE TABLE SPECIFICATIONS

Description	Top Size	Approximate Seating	No. of Sections	Shipping Weight	Cubic Feet
Conference Table Top – Oval	96-48	8	2	165	18.8
6259	120-54	10	3	240	30.9
	144-60	12	3	290	34.8

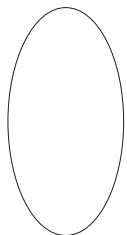

Conference tables up to and including 168" in length are available on the KrugExpress quick ship program.

Description	Base Size	W	D	H	Shipping Weight	Cubic Feet
Forza Leg Base	29	6	n/a	28	15	0.9
6238						



Forza Square	14-14-29	14	14	28	177	6.5
6234						

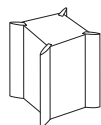

Forza Panel Base	24-29	24	n/a	28	54	5.5
6232	30-29	30	n/a	28	56	6.4



Forza Rectangle Base	13-30-29	13	30	28	126	10.8
6233						

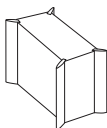

DIMENSION KEY

L – length
W – width
H – height

Model numbers represent nominal dimensions only. Contact Customer Service if dimensions are critical.

SPECIAL FEATURES

Conference tops are designed to accommodate microphones, which can be field installed. Please contact Customer Service for more information on where they can be positioned. Custom table sizes are available. Please contact Customer Service or your local Krug representative.



“Base Size” represents wood dimensions and does not include metal accents. Please contact Customer Service if dimensions are critical.

Bookmatched Birdseye Maple veneer is available on VIRTU Conference Table Tops at an upcharge of **\$76 list per square foot**.

Conference tops may be ordered with a reduced number of sections at an upcharge. Please contact Customer Service or your local Krug representative for details.

VIRTU | CONFERENCE TABLE PRICING AND MODEL NUMBERS

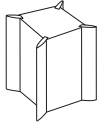
Shown below are model numbers and pricing for VIRTU conference tops and bases. The pricing is the combined price of the top and the base(s) that are cross-referenced in the chart. Please note that some bases are not available on all tops. Only the top and base combinations listed are available. When ordering, please specify the model number of the top, the model number(s) of the base(s), followed by their combined price. See bottom page for Conference Table Ordering Procedure.

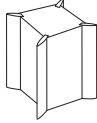
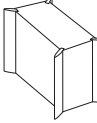
	GROUP 1				GROUP 2					
	FORZA LEG 6238 	FORZA SQUARE 6234 	PRICE FOR TOP AND BASE(S)	PRICE FOR TOP AND BASE(S)	FORZA PANEL 6232 	FORZA SQUARE 6234 	FORZA RECT. 6233 	PRICE FOR TOP AND BASE(S)	PRICE FOR TOP AND BASE(S)	
Oval Table Top 6259										
MODEL #	6238-29	6234-14-14-29	MAPLE/ CHERRY/ WALNUT	ANIGRE	6232-24-29	6232-30-29	6234-14-14-29	6233-13-30-29	MAPLE/ CHERRY/ WALNUT	ANIGRE
	QTY	QTY			QTY	QTY	QTY	QTY		
6259-96-48	4		7228	8162	2				7943	9131
6259-120-54	4 +	1	10761	12228		2 +	1		11537	13274
6259-144-60	4 +	1**	12157	12398		2		+ 1	12937	14879

** REQUIRES RECTANGLE BASE

ORDERING PROCEDURE

Please specify the following:

1. Select Table Top shape, size, model number and wood species.
2. Select Table Base(s), size, model number, quantity and wood species.
3. Obtain Table Price by cross-referencing selected top with selected base(s). The prices listed are the combined total of the top and base(s).
4. Select Connexus™ Module(s) and a Location Code for either a Glass or Satin Aluminum module.
Add pricing for the selected Connexus™ Module(s) to the table price.
5. Select Monument Location(s) and provide monument location code(s) on purchase order.
6. Select a Wood Finish
7. Select an Edge Profile.

Model numbers represent nominal dimensions only (in inches). Contact Customer Service if dimensions are critical.

VIRTU | CONFERENCE TABLE SPECIFICATIONS

Description	Top Size	Approximate Seating	No. of Sections	Shipping Weight	Cubic Feet
Conference	96-48	8	2	165	18.8
Table Top – Oval	120-54	10	3	240	30.9
6259	144-60	12	3	290	34.8

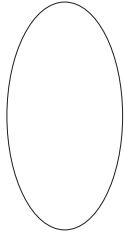

Conference tables up to and including 168" in length are available on the KrugExpress quick ship program.

Description	Base Size	W	D	H	Shipping Weight	Cubic Feet
Dais Base	18D-29	18 dia.	n/a	28	149	6.5
6230	24D-29	24 dia.	n/a	28	171	10.9
	30D-29	30 dia.	n/a	28	196	17.6

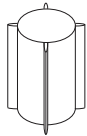

DIMENSION KEY

L – length
W – width
H – height

Model numbers represent nominal dimensions only. Contact Customer Service if dimensions are critical.

SPECIAL FEATURES

Conference tops are designed to accommodate microphones, which can be field installed. Please contact Customer Service for more information on where they can be positioned. Custom table sizes are available. Please contact Customer Service or your local Krug representative.

“Base Size” represents wood dimensions and does not include metal accents. Please contact Customer Service if dimensions are critical.

Bookmatched Birdseye Maple veneer is available on VIRTU Conference Table Tops at an upcharge of **\$76 list per square foot**.

Conference tops may be ordered with a reduced number of sections at an upcharge. Please contact Customer Service or your local Krug representative for details.

VIRTU | CONFERENCE TABLE PRICING AND MODEL NUMBERS

Shown below are model numbers and pricing for VIRTU conference tops and bases. The pricing is the combined price of the top and the base(s) that are cross-referenced in the chart. Please note that some bases are not available on all tops. Only the top and base combinations listed are available. When ordering, please specify the model number of the top, the model number(s) of the base(s), followed by their combined price. See bottom page for Conference Table Ordering Procedure.

GROUP 3

Oval Table Top 6259	DAIS 6230			PRICE FOR TOP AND BASE(S)	PRICE FOR TOP AND BASE(S)
	6230- 18D-29	6230- 24D-29	6230- 30D-29	MAPLE/ CHERRY/ WALNUT	ANIGRE
6259-96-48	2			8728	10040
6259-120-54		2		11138	12815
6259-144-60	2	+	1	13394	15401

ORDERING PROCEDURE

Please specify the following:

1. Select Table Top shape, size, model number and wood species.
2. Select Table Base(s), size, model number, quantity and wood species.
3. Obtain Table Price by cross-referencing selected top with selected base(s). The prices listed are the combined total of the top and base(s).
4. Select Connexus™ Module(s) and a Location Code for either a Glass or Satin Aluminum module.
Add pricing for the selected Connexus™ Module(s) to the table price.
5. Select Monument Location(s) and provide monument location code(s) on purchase order.
6. Select a Wood Finish
7. Select an Edge Profile.

Model numbers represent nominal dimensions only (in inches). Contact Customer Service if dimensions are critical.

VIRTU | CONFERENCE TABLE SPECIFICATIONS

Description	Top Size	Approximate Seating	X	No. of Sections	Shipping Weight	Cubic Feet
Conference	107-57-40	9	73	2	230	28.8
Table Top –	137-63-40	12	78	3	310	35.5
Verso	144-48-42	14	83	4	390	44.3

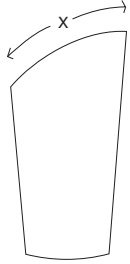

Conference tables up to and including 168" in length are available on the KrugExpress quick ship program.

Description	Base Size	W	D	H	Shipping Weight	Cubic Feet
Forza Square Base 6234	14-14-29	14	14	28	177	6.5
	20-20-29	20	20	28	199	10.9
	26-26-29	26	26	28	225	17.6

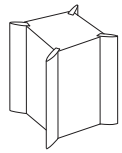

Verso Base 6231	18-19-29	18	19	28	178	13.5
	23-24-29	23	24	28	192	22.1

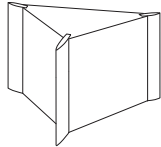

Forza Leg Base 6238	29	6	n/a	28	15	0.9
------------------------	----	---	-----	----	----	-----



DIMENSION KEY

L – length
W – width
H – height

Model numbers represent nominal dimensions only. Contact Customer Service if dimensions are critical.

SPECIAL FEATURES

Conference tops are designed to accommodate microphones, which can be field installed. Please contact Customer Service for more information on where they can be positioned. Custom table sizes are available. Please contact Customer Service or your local Krug representative.

“Base Size” represents wood dimensions and does not include metal accents. Please contact Customer Service if dimensions are critical.

Bookmatched Birdseye Maple veneer is available on VIRTU Conference Table Tops at an upcharge of **\$76 list per square foot**.

Conference tops may be ordered with a reduced number of sections at an upcharge. Please contact Customer Service or your local Krug representative for details.

VIRTU | CONFERENCE TABLE PRICING AND MODEL NUMBERS

Shown below are model numbers and pricing for VIRTU conference tops and bases. The pricing is the combined price of the top and the base(s) that are cross-referenced in the chart. Please note that some bases are not available on all tops. Only the top and base combinations listed are available. When ordering, please specify the model number of the top, the model number(s) of the base(s), followed by their combined price. See bottom page for Conference Table Ordering Procedure.

GROUP 1

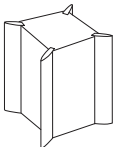
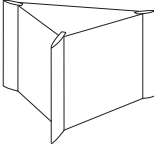
Verso Table Top 6258	FORZA SQUARE 6234 			VERSO 6231 		PRICE FOR TOP AND BASE(S)	PRICE FOR TOP AND BASE(S)
	6234-14-14-29	6234-20-20-29	6234-26-26-29	6231-18-19-296231-23-24-29			
MODEL #	QTY	QTY	QTY	QTY	QTY	MAPLE/ CHERRY/ WALNUT	ANIGRE
6258-107-57-40	1		+	1		11508	13230
6258-137-63-40	1		+	1		14836	16950
6258-167-70-40	1	1	+		1	17085	19632

GROUP 2

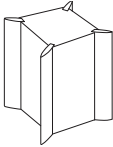
Verso Table Top 6258	FORZA LEG 6238 		FORZA SQUARE 6234 		PRICE FOR TOP	PRICE FOR TOP
	6238-29		6234-14-14-29			
MODEL #	QTY		QTY		MAPLE/ CHERRY/ WALNUT	ANIGRE
6258-107-57-40	4				10070	11520
6258-137-63-40	4	+	1		14581	16633
6258-167-70-40	4	+	2		16806	19185

ORDERING PROCEDURE

Please specify the following:

1. Select Table Top shape, size, model number and wood species.
2. Select Table Base(s), size, model number, quantity and wood species.
3. Obtain Table Price by cross-referencing selected top with selected base(s). The prices listed are the combined total of the top and base(s).
4. Select Connexus™ Module(s) and a Location Code for either a Glass or Satin Aluminum module.
Add pricing for the selected Connexus™ Module(s) to the table price.
5. Select Monument Location(s) and provide monument location code(s) on purchase order.
6. Select a Wood Finish
7. Select an Edge Profile.

Model numbers represent nominal dimensions only (in inches). Contact Customer Service if dimensions are critical.

VIRTU | CONFERENCE TABLE SPECIFICATIONS

Description	Top Size	Approximate Seating	No. of Sections	Shipping Weight	Cubic Feet
Conference	120-60-42	11	3	265	30.3
Table Top – Visio	144-60-42	13	3	310	31.3
6257	168-66-42	15	4	355	40.8
	192-69-42	17	4	400	43.8
	216-73-42	19	5	445	53.3
	240-76-42	21	5	490	58.6

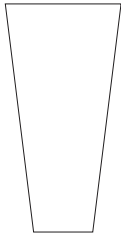

Conference tables up to and including 168" in length are available on the KrugExpress quick ship program.

Description	Base Size	W	D	H	Shipping Weight	Cubic Feet
Forza Leg Base	29	6	n/a	28	15	0.9

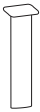

Forza Square	14-14-29	14	14	28	177	6.5
--------------	----------	----	----	----	-----	-----

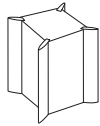

Forza Panel Base	24-29	24	n/a	28	54	5.5
	30-29	30	n/a	28	56	6.4
	34-29	34	n/a	28	58	7.5
	41-29	41	n/a	28	63	9.1
	48-29	48	n/a	28	68	10.7



Forza Rectangle Base	13-30-29	13	30	28	126	10.8
----------------------	----------	----	----	----	-----	------

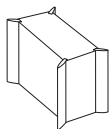

DIMENSION KEY

L – length
W – width
H – height

Model numbers represent nominal dimensions only. Contact Customer Service if dimensions are critical.

SPECIAL FEATURES

Conference tops are designed to accommodate microphones, which can be field installed. Please contact Customer Service for more information on where they can be positioned. Custom table sizes are available. Please contact Customer Service or your local Krug representative.



“Base Size” represents wood dimensions and does not include metal accents. Please contact Customer Service if dimensions are critical.

Bookmatched Birdseye Maple veneer is available on VIRTU Conference Table Tops at an upcharge of **\$76 list per square foot**.

Conference tops may be ordered with a reduced number of sections at an upcharge. Please contact Customer Service or your local Krug representative for details.

VIRTU | CONFERENCE TABLE PRICING AND MODEL NUMBERS

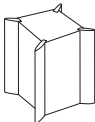
Shown below are model numbers and pricing for VIRTU conference tops and bases. The pricing is the combined price of the top and the base(s) that are cross-referenced in the chart. Please note that some bases are not available on all tops. Only the top and base combinations listed are available. When ordering, please specify the model number of the top, the model number(s) of the base(s), followed by their combined price. See bottom page for Conference Table Ordering Procedure.

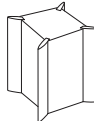
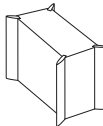
	GROUP 1				GROUP 2								
	FORZA LEG 6238 	FORZA SQUARE 6234 	PRICE FOR TOP AND BASE(S)	PRICE FOR TOP AND BASE(S)	FORZA PANEL 6232 	FORZA SQUARE 6234 	FORZA RECT. 6233 	PRICE FOR TOP AND BASE(S)	PRICE FOR TOP AND BASE(S)				
Visio Table Top 6257													
MODEL #	6238-29	6234-14-14-29	MAPLE/CHERRY/WALNUT	ANIGRE	6232-24-29	6232-30-29	6232-34-29	6232-41-29	6232-48-29	6234-14-14-29	6233-13-30-29	MAPLE/CHERRY/WALNUT	ANIGRE
	QTY	QTY			QTY	QTY	QTY	QTY	QTY	QTY	QTY		
6257-120-60-42	4 +	1	10873	12361	1	1				+ 1		11624	13368
6257-144-60-42	4 +	1**	14357	16364	1		1			+ 1		15154	17413
6257-168-66-42	4 +	2	16083	18357	1			1		+ 1		16114	18511
6257-192-69-42	4 +	2	17098	19522	1			1		+ 2		18715	21498
6257-216-72-42	4 +	3	19388	22169	1				1	+ 2		19858	22825
6257-240-76-42	4 +	3	20580	21135	1				1	+ 2		21048	24190

**Requires rectangle base

ORDERING PROCEDURE

Please specify the following:

1. Select Table Top shape, size, model number and wood species.
2. Select Table Base(s), size, model number, quantity and wood species.
3. Obtain Table Price by cross-referencing selected top with selected base(s). The prices listed are the combined total of the top and base(s).
4. Select Connexus™ Module(s) and a Location Code for either a Glass or Satin Aluminum module. Add pricing for the selected Connexus™ Module(s) to the table price.
5. Select Monument Location(s) and provide monument location code(s) on purchase order.
6. Select a Wood Finish
7. Select an Edge Profile.

Model numbers represent nominal dimensions only (in inches). Contact Customer Service if dimensions are critical.

VIRTU | CONFERENCE TABLE SPECIFICATIONS

Description	Top Size	Approximate Seating	No. of Sections	Shipping Weight	Cubic Feet
Conference Table Top – Visio 6257	120-60-42	11	3	265	30.3
	144-60-42	13	3	310	31.3
	168-66-42	15	4	355	40.8
	192-69-42	17	4	400	43.8
	216-73-42	19	5	445	53.3
	240-76-42	21	5	490	58.6

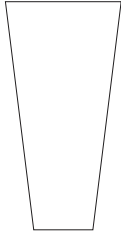

Conference tables up to and including 168" in length are available on the KrugExpress quick ship program.

Description	Base Size	W	D	H	Shipping Weight	Cubic Feet
Forza Square Base 6234	14-14-29	14	14	28	177	6.5
	20-20-29	20	20	28	199	10.9
	26-26-29	26	26	28	225	17.6

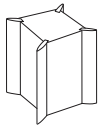

Description	Base Size	W	D	H	Shipping Weight	Cubic Feet
Dais Base 6230	18D-29	18 dia.	n/a	28	149	6.5
	24D-29	24 dia.	n/a	28	171	10.9
	30D-29	30 dia.	n/a	28	196	17.6

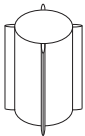

Description	Base Size	W	D	H	Shipping Weight	Cubic Feet
Oblique Base 6237	18-18-29	18	18	28	149	6.5
	24-24-29	24	24	28	171	10.9
	30-30-29	30	30	28	196	17.6

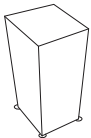

DIMENSION KEY

L – length
W – width
H – height

Model numbers represent nominal dimensions only. Contact Customer Service if dimensions are critical.

SPECIAL FEATURES

Conference tops are designed to accommodate microphones, which can be field installed. Please contact Customer Service for more information on where they can be positioned. Custom table sizes are available. Please contact Customer Service or your local Krug representative.

“Base Size” represents wood dimensions and does not include metal accents. Please contact Customer Service if dimensions are critical.

Bookmatched Birdseye Maple veneer is available on VIRTU Conference Table Tops at an upcharge of **\$76 list per square foot**.

Conference tops may be ordered with a reduced number of sections at an upcharge. Please contact Customer Service or your local Krug representative for details.

VIRTU | CONFERENCE TABLE PRICING AND MODEL NUMBERS

Shown below are model numbers and pricing for VIRTU conference tops and bases. The pricing is the combined price of the top and the base(s) that are cross-referenced in the chart. Please note that some bases are not available on all tops. Only the top and base combinations listed are available. When ordering, please specify the model number of the top, the model number(s) of the base(s), followed by their combined price. See bottom page for Conference Table Ordering Procedure.

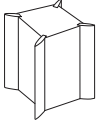
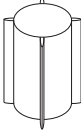
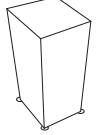
Visio Table Top 6257	GROUP 3					GROUP 4					GROUP 5				
	FORZA SQUARE 6234			PRICE FOR TOP AND BASE(S)	PRICE FOR TOP AND BASE(S)	DAIS 6230			PRICE FOR TOP AND BASE(S)	PRICE FOR TOP AND BASE(S)	OBLIQUE 6237			PRICE FOR TOP AND BASE(S)	PRICE FOR TOP AND BASE(S)
															
MODEL #	6234-14- 14-29	6234-20- 20-29	6234-26- 26-29	MAPLE/ CHERRY/ WALNUT	ANIGRE	6230- 18d-29	6230- 24d-29	6230- 30d-29	MAPLE/ CHERRY/ WALNUT	ANIGRE	6237-18- 18-29	6237-24- 24-29	6237-30- 30-29	MAPLE/ CHERRY/ WALNUT	ANIGRE
	QTY	QTY	QTY			QTY	QTY	QTY			QTY	QTY	QTY		
6257-120-60-42	1	+	1			1	+	1			1	+	1		
				10354	11908				10383	11941				10235	11766
6257-144-60-42	1		+	1		1		+	1		1		+	1	
				13296	15295				13288	15283				13136	15109
6257-168-66-42	1	+	1	+	1	1	+	1	+	1	1	+	1	+	1
				15337	17635				15321	17622				15094	17360
6257-192-69-42	1	+	1	+	1	1	+	1	+	1	1	+	1	+	1
				16278	18716				16259	18702				16036	18438
6257-216-72-42	1	+	1	+	1	1	+	1	+	1	1	+	1	+	1
				17288	19882				17273	19870				17048	19607
6257-240-76-42	1	+	1	+	2	1	+	1	+	2	1	+	1	+	2
				19662	22605				19598	22540				19301	22190

ORDERING PROCEDURE

Please specify the following:

1. Select Table Top shape, size, model number and wood species.
2. Select Table Base(s), size, model number, quantity and wood species.
3. Obtain Table Price by cross-referencing selected top with selected base(s). The prices listed are the combined total of the top and base(s).
4. Select Connexus™ Module(s) and a Location Code for either a Glass or Satin Aluminum module.
Add pricing for the selected Connexus™ Module(s) to the table price.
5. Select Monument Location(s) and provide monument location code(s) on purchase order.
6. Select a Wood Finish
7. Select an Edge Profile.

Model numbers represent nominal dimensions only (in inches). Contact Customer Service if dimensions are critical.

VIRTU | CONFERENCE TABLE SPECIFICATIONS

Description	Top Size	Approximate Seating	No. of Sections	Shipping Weight	Cubic Feet
Conference Table Top –	134-80-52	9	3	282	37.7
Open Visio	134-92-64	9	3	317	40.3
with partial	158-85-52	11	5	350	44.9
modesty panel*	158-96-64	11	5	395	47.5
6260	182-90-52	11	5	404	50.9
	182-102-64	11	5	459	53.5
	218-97-52	15	7	486	63.3
	218-109-64	15	7	551	65.9
	254-105-52	15	7	567	72.3
	254-117-64	15	7	629	74.9

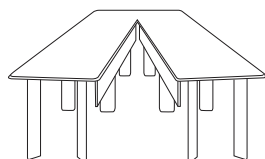
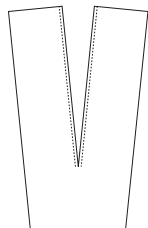

Open Visio Conference tops feature a combination of three, five or seven pieces to make up the table surface:

6260-134-80-52 features 2 tops at 30 x 96" and 1 end top at 52 x 36"

6260-134-92-64 features 2 tops at 36 x 96" and 1 end top at 64 x 36"

6260-158-85-52 features 4 tops at 30 x 60" and 1 end top at 52 x 36"

6260-158-96-64 features 4 tops at 36 x 60" and 1 end top at 64 x 36"

6260-182-90-52 features 4 tops at 30 x 72" and 1 end top at 52 x 36"

6260-182-102-64 features 4 tops at 36 x 72" and 1 end top at 64 x 36"

6260-218-97-52 features 6 tops at 30 x 60" and 1 end top at 52 x 36"

6260-218-109-64 features 6 tops at 36 x 60" and 1 end top at 64 x 36"

6260-254-105-52 features 6 tops at 30 x 72" and 1 end top at 52 x 36"

6260-254-117-64 features 6 tops at 36 x 72" and 1 end top at 64 x 36"

***Wood modesty panel on Open Visio table is 8 3/4" in height and 3/4" thick.**

Conference tables up to and including 168" in length are available on the KrugExpress quick ship program.

Description	Base Size	W	D	H	Shipping Weight	Cubic Feet
Forza Leg Base 6238	29	6	n/a	28	15	0.9



DIMENSION KEY

L – length
W – width
H – height

Model numbers represent nominal dimensions only. Contact Customer Service if dimensions are critical.

SPECIAL FEATURES

Conference tops are designed to accommodate microphones, which can be field installed. Please contact Customer Service for more information on where they can be positioned. Custom table sizes are available. Please contact Customer Service or your local Krug representative.

"Base Size" represents wood dimensions and does not include metal accents. Please contact Customer Service if dimensions are critical.

Bookmatched Birdseye Maple veneer is available on VIRTU Conference Table Tops at an upcharge of **\$76 list per square foot**.

Conference tops may be ordered with a reduced number of sections at an upcharge. Please contact Customer Service or your local Krug representative for details.

VIRTU | CONFERENCE TABLE PRICING AND MODEL NUMBERS

Shown below are model numbers and pricing for VIRTU conference tops and bases. The pricing is the combined price of the top and the base(s) that are cross-referenced in the chart. Please note that some bases are not available on all tops. Only the top and base combinations listed are available. When ordering, please specify the model number of the top, the model number(s) of the base(s), followed by their combined price. See bottom page for Conference Table Ordering Procedure.

GROUP 1

Open Visio Table Top (partial modesty) 6260	FORZA LEG 6238	PRICE FOR TOP AND BASE(S)	PRICE FOR TOP AND BASE(S)
			
MODEL #	6238-29	MAPLE/ CHERRY/ WALNUT	ANIGRE
	QTY		
6260-134-80-52	10	16671	19030
6260-134-92-64	10	17102	19472
6260-158-85-52	14	18950	21323
6260-158-96-64	14	19357	21745
6260-182-90-52	14	20589	23163
6260-182-102-64	14	22300	24190
6260-218-97-52	18	24793	26827
6260-218-109-64	18	26425	28675
6260-254-105-52	18	28625	31043
6260-254-117-64	18	30558	33172

ORDERING PROCEDURE

Please specify the following:

1. Select Table Top shape, size, model number and wood species.
2. Select Table Base(s), size, model number, quantity and wood species.
3. Obtain Table Price by cross-referencing selected top with selected base(s). The prices listed are the combined total of the top and base(s).
4. Select Connexus™ Module(s) and a Location Code for either a Glass or Satin Aluminum module.
Add pricing for the selected Connexus™ Module(s) to the table price.
5. Select Monument Location(s) and provide monument location code(s) on purchase order.
6. Select a Wood Finish
7. Select an Edge Profile.

Model numbers represent nominal dimensions only (in inches). Contact Customer Service if dimensions are critical.

VIRTU | CONFERENCE TABLE SPECIFICATIONS

Description	Top Size	Approximate Seating	No. of Sections	Shipping Weight	Cubic Feet
Conference Table Top –	134-80-52	9	3	342	37.7
Open Visio	134-92-64	9	3	377	40.3
with full height	158-85-52	11	5	470	44.9
modesty panel	158-96-64	11	5	515	47.5
6262	182-90-52*	11	5	524	50.9
	182-102-64	11	5	579	53.5
	218-97-52	15	7	665	63.3
	218-109-64	15	7	731	65.9
	254-105-52	15	7	747	72.3
	254-117-64	15	7	809	74.9

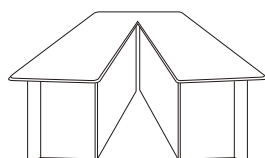
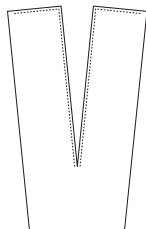

Open Visio Conference tops feature a combination of three, five or seven pieces to make up the table surface:

6262-134-80-52 features 2 tops at 30 x 96" and 1 end top at 52 x 36"

6262-134-92-64 features 2 tops at 36 x 96" and 1 end top at 64 x 36"

6262-158-85-52 features 4 tops at 30 x 60" and 1 end top at 52 x 36"

6262-158-96-64 features 4 tops at 36 x 60" and 1 end top at 64 x 36"

6262-182-90-52 features 4 tops at 30 x 72" and 1 end top at 52 x 36"

6262-182-102-64 features 4 tops at 36 x 72" and 1 end top at 64 x 36"

6262-218-97-52 features 6 tops at 30 x 60" and 1 end top at 52 x 36"

6262-218-109-64 features 6 tops at 36 x 60" and 1 end top at 64 x 36"

6262-254-105-52 features 6 tops at 30 x 72" and 1 end top at 52 x 36"

6262-254-117-64 features 6 tops at 36 x 72" and 1 end top at 64 x 36"

***wood modesty panel on Open Visio table is 28" in height and 3/4" thick.**

Conference tables up to and including 168" in length are available on the KrugExpress quick ship program.

Description	Base Size	W	D	H	Shipping Weight	Cubic Feet
Forza Leg Base 6238	29	6	n/a	28	15	0.9



DIMENSION KEY

L – length

W – width

H – height

Model numbers represent nominal dimensions only. Contact Customer Service if dimensions are critical.

SPECIAL FEATURES

Conference tops are designed to accommodate microphones, which can be field installed. Please contact Customer Service for more information on where they can be positioned.

Custom table sizes are available. Please contact Customer Service or your local Krug representative.

"Base Size" represents wood dimensions and does not include metal accents. Please contact Customer Service if dimensions are critical.

Bookmatched Birdseye Maple veneer is available on VIRTU Conference Table Tops at an upcharge of **\$76 list per square foot**.

Conference tops may be ordered with a reduced number of sections at an upcharge. Please contact Customer Service or your local Krug representative for details.

VIRTU | CONFERENCE TABLE PRICING AND MODEL NUMBERS

Shown below are model numbers and pricing for VIRTU conference tops and bases. The pricing is the combined price of the top and the base(s) that are cross-referenced in the chart. Please note that some bases are not available on all tops. Only the top and base combinations listed are available. When ordering, please specify the model number of the top, the model number(s) of the base(s), followed by their combined price. See bottom page for Conference Table Ordering Procedure.

GROUP 1			
Open Visio Table Top (full modesty) 6262	FORZA LEG 6238	PRICE FOR TOP AND BASE(S)	PRICE FOR TOP AND BASE(S)
			
MODEL #	6238-29	MAPLE/ CHERRY/ WALNUT	ANIGRE
	QTY		
6262-134-80-52	6	18671	21313
6262-134-92-64	6	19152	21810
6262-158-85-52	8	21223	23883
6262-158-96-64	8	21680	24352
6262-182-90-52	8	23059	25942
6262-182-102-64	8	24978	27093
6262-218-97-52	10	27770	30051
6262-218-109-64	10	29594	32115
6262-254-105-52	10	32060	34769
6262-254-117-64	10	34222	37150

ORDERING PROCEDURE

Please specify the following:

1. Select Table Top shape, size, model number and wood species.
2. Select Table Base(s), size, model number, quantity and wood species.
3. Obtain Table Price by cross-referencing selected top with selected base(s). The prices listed are the combined total of the top and base(s).
4. Select Connexus™ Module(s) and a Location Code for either a Glass or Satin Aluminum module.
Add pricing for the selected Connexus™ Module(s) to the table price.
5. Select Monument Location(s) and provide monument location code(s) on purchase order.
6. Select a Wood Finish
7. Select an Edge Profile.

Model numbers represent nominal dimensions only (in inches). Contact Customer Service if dimensions are critical.

VIRTU | CONFERENCE TABLE SPECIFICATIONS

Description	Top Size	Approximate Seating	No. of Sections	Shipping Weight	Cubic Feet
Conference	36D	3	1	48	5.8
Table Top – Delta	42D	3	1	54	7.5
6253	48D	3	1	74	9.4
	54D	3	1	100	14.4
	60D	3	1	134	14.4

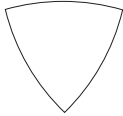

Conference tables up to and including 168" in length are available on the KrugExpress quick ship program.

Conference	36-36	4	1	50	5.8
Table Top – Arced Square	42-42	4	1	56	7.5
6256	48-48	4	1	82	9.4
	54-54	4	1	100	14.4
	60-60	4	1	132	14.4

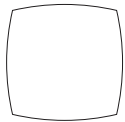

Description	Base Size	W	D	H	Shipping Weight	Cubic Feet
Forza Leg Base	29	6	n/a	28	15	0.9
6238						



Dais Base	18D -29	18 Dia	n/a	28	149	6.5
6230	24D -29	24 Dia	n/a	28	171	10.9
	30D -29	30 Dia	n/a	28	196	17.6

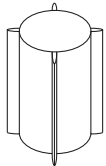

Forza Square Base	14-14-29	14	14	28	177	6.5
6234	20-20-29	20	20	28	199	10.9
	26-26-29	26	26	28	225	17.6

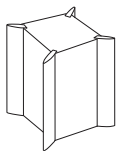

DIMENSION KEY

L – length
W – width
H – height

Model numbers represent nominal dimensions only. Contact Customer Service if dimensions are critical.

SPECIAL FEATURES

Conference tops are designed to accommodate microphones, which can be field installed. Please contact Customer Service for more information on where they can be positioned. Custom table sizes are available. Please contact Customer Service or your local Krug representative.

“Base Size” represents wood dimensions and does not include metal accents. Please contact Customer Service if dimensions are critical.

Bookmatched Birdseye Maple veneer is available on VIRTU Conference Table Tops at an upcharge of **\$76 list per square foot**.

Conference tops may be ordered with a reduced number of sections at an upcharge. Please contact Customer Service or your local Krug representative for details.

VIRTU | CONFERENCE TABLE PRICING AND MODEL NUMBERS

Shown below are model numbers and pricing for VIRTU conference tops and bases. The pricing is the combined price of the top and the base(s) that are cross-referenced in the chart. Please note that some bases are not available on all tops. Only the top and base combinations listed are available. When ordering, please specify the model number of the top, the model number(s) of the base(s), followed by their combined price. See bottom page for Conference Table Ordering Procedure.

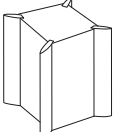
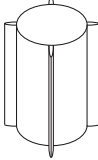
GROUP 1				GROUP 2				GROUP 3					
FORZA LEG 6238 		PRICE FOR TOP AND BASE(S)	PRICE FOR TOP AND BASE(S)	FORZA SQUARE 6234 			PRICE FOR TOP AND BASE(S)	PRICE FOR TOP AND BASE(S)	DAIS 6230 			PRICE FOR TOP AND BASE(S)	PRICE FOR TOP AND BASE(S)
MODEL #	6238-29	MAPLE/ CHERRY/ WALNUT	ANIGRE	6234-14 14-29	6234-20 20-29	6234-26 26-29	MAPLE/ CHERRY/ WALNUT	ANIGRE	6230-18D-29	6230-24D-29	6230-30D-29	MAPLE/ CHERRY/ WALNUT	ANIGRE
	QTY			QTY	QTY	QTY			QTY	QTY	QTY		
Delta Table Top 6253													
6253-36									1			3886	4486
6253-42	3	3699	4142						1			4203	4834
6253-48	3	3958	4441						1			4460	5132
6253-54	3	5009	5649							1		5554	6389
6253-60	3	6060	6859								1	6646	7644
Arced Square Table Top 6256													
6256-36-36	4	3516	3891	1			3733	4293	1			3772	4337
6256-42-42	4	3814	4238	1			4028	4454	1			4070	4679
6256-48-48	4	4179	4658	1			4393	5057	1			4436	5103
6256-54-54	4	4339	4844		1		4646	5340		1		4637	5337
6256-60-60	4	5896	6633			1	6288	7228			1	6235	7173

ORDERING PROCEDURE

Please specify the following:

1. Select Table Top shape, size, model number and wood species.
2. Select Table Base(s), size, model number, quantity and wood species.
3. Obtain Table Price by cross-referencing selected top with selected base(s). The prices listed are the combined total of the top and base(s).
4. Select Connexus™ Module(s) and a Location Code for either a Glass or Satin Aluminum module.
Add pricing for the selected Connexus™ Module(s) to the table price.
5. Select Monument Location(s) and provide monument location code(s) on purchase order.
6. Select a Wood Finish
7. Select an Edge Profile.

Model numbers represent nominal dimensions only (in inches). Contact Customer Service if dimensions are critical.

VIRTU | CONFERENCE TABLE SPECIFICATIONS

Description	Top Size	Approximate Seating	No. of Sections	Shipping Weight	Cubic Feet
Conference Table Top – Round 6255	36D	3	1	48	5.8
	42D	3	1	54	7.5
	48D	3	1	74	9.4
	54D	3	1	100	14.4
	60D	3	1	134	14.4

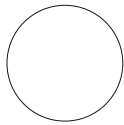

Conference tables up to and including 168" in length are available on the KrugExpress quick ship program.

Description	Top Size	Approximate Seating	No. of Sections	Shipping Weight	Cubic Feet
Conference Table Top – Square 6251	36-36	4	1	50	5.8
	42-42	4	1	56	7.5
	48-48	4	1	82	9.4
	54-54	4	1	100	14.4
	60-60	4	1	132	14.4

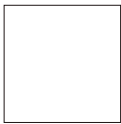

Description	Base Size	W	D	H	Shipping Weight	Cubic Feet
Forza Leg Base 6238	29	6	n/a	28	15	0.9



Description	Base Size	W	D	H	Shipping Weight	Cubic Feet
Dais Base 6230	18D -29	18 Dia	n/a	28	149	6.5
	24D -29	24 Dia	n/a	28	171	10.9
	30D -29	30 Dia	n/a	28	196	17.6

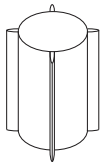

Description	Base Size	W	D	H	Shipping Weight	Cubic Feet
Forza Square Base 6234	14-14-29	14	14	28	177	6.5
	20-20-29	20	20	28	199	10.9
	26-26-29	26	26	28	225	17.6

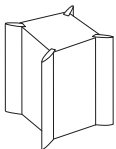

DIMENSION KEY

L – length
W – width
H – height

Model numbers represent nominal dimensions only. Contact Customer Service if dimensions are critical.

SPECIAL FEATURES

Conference tops are designed to accommodate microphones, which can be field installed. Please contact Customer Service for more information on where they can be positioned. Custom table sizes are available. Please contact Customer Service or your local Krug representative.

“Base Size” represents wood dimensions and does not include metal accents. Please contact Customer Service if dimensions are critical.

Bookmatched Birdseye Maple veneer is available on VIRTU Conference Table Tops at an upcharge of **\$76 list per square foot**.

Conference tops may be ordered with a reduced number of sections at an upcharge. Please contact Customer Service or your local Krug representative for details.

VIRTU | CONFERENCE TABLE PRICING AND MODEL NUMBERS

Shown below are model numbers and pricing for VIRTU conference tops and bases. The pricing is the combined price of the top and the base(s) that are cross-referenced in the chart. Please note that some bases are not available on all tops. Only the top and base combinations listed are available. When ordering, please specify the model number of the top, the model number(s) of the base(s), followed by their combined price. See bottom page for Conference Table Ordering Procedure.

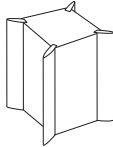
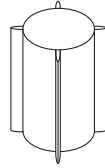
GROUP 1				GROUP 2					GROUP 3				
	FORZA LEG 6238 	PRICE FOR TOP AND BASE(S)	PRICE FOR TOP AND BASE(S)	FORZA SQUARE 6234 			PRICE FOR TOP AND BASE(S)	PRICE FOR TOP AND BASE(S)	DAIS 6230 			PRICE FOR TOP AND BASE(S)	PRICE FOR TOP AND BASE(S)
MODEL #	6238-29	MAPLE/ CHERRY/ WALNUT	ANIGRE	6234-14 14-29	6234-20 20-29	6234-26 26-29	MAPLE/ CHERRY/ WALNUT	ANIGRE	6230- 18D-29	6230- 24D-29	6230- 30D-29	MAPLE/ CHERRY/ WALNUT	ANIGRE
	QTY			QTY	QTY	QTY			QTY	QTY	QTY		
Round Table Top 6255													
6255-36 dia.	3	3163	3528						1			3666	4215
6255-42 dia.	3	3580	4007	1			4042	4655	1			4085	4698
6255-48 dia.	4	4074	4536	1			4291	4939	1			4334	4984
6255-54 dia.	4	5085	5702		1		5391	6196		1		5384	6188
6255-60 dia.	4	6096	6859			1	6482	7452			1	6432	7398
Square Table Top 6251													
6251-36-36	4	3414	3780	1			3631	4179	1			3671	4223
6251-42-42	4	3699	4107	1			3917	4507	1			3958	4553
6251-48-48	4	4053	4511	1			4267	4911	1			4310	4953
6251-54-54	4	4205	4690		1		4512	5183		1		4504	6188
6251-60-60	4	5704	6410			1	6482	7004			1	6042	7398

ORDERING PROCEDURE

Please specify the following:

1. Select Table Top shape, size, model number and wood species.
2. Select Table Base(s), size, model number, quantity and wood species.
3. Obtain Table Price by cross-referencing selected top with selected base(s). The prices listed are the combined total of the top and base(s).
4. Select Connexus™ Module(s) and a Location Code for either a Glass or Satin Aluminum module.
Add pricing for the selected Connexus™ Module(s) to the table price.
5. Select Monument Location(s) and provide monument location code(s) on purchase order.
6. Select a Wood Finish
7. Select an Edge Profile.

Model numbers represent nominal dimensions only (in inches). Contact Customer Service if dimensions are critical.

VIRTU | POWER & COMMUNICATION PLANNING

OBJECTIVE

We have designed this section to help you determine the appropriate power and communications options for your specific application. This section is divided into two parts with the following objectives:

1. Provide detailed information on Connexus™, VIRTU's tabletop power and data module: what it is, its abilities and its applications.
2. Provide a description and specifications of VIRTU's wire management capabilities.

CONNEXUS™

Using technology and furniture together can be a challenge, and at worst can ruin a meeting or presentation. VIRTU is totally designed around the interface with office technology and equipment. The Connexus™ power module in table tops provides an unlimited range of connectivity. Going way beyond electrical, Connexus™ offers connections for voice, data, multimedia presentations, network and internet connections, and much more. Connexus™ can be specified in any number of locations in a table, and features a substantial cavity for easy access and wire storage.

But the greatest innovation of patent-pending Connexus™ is that it utilizes industry-standard receptacle outlets for this multitude of connection options. This provides huge advantages over the more limited interface found in other products. VIRTU offers 11 standard configurations for Connexus™, which will address almost any user need. And Connexus™ can also be ordered as a Blank module, and configured by electricians on-site with off-the-shelf receptacles and wiring to a user's specific needs. This feature makes VIRTU exceptionally suited to customers where local codes require on-site configuring and installation of all electrical components.

There's more. Connexus™ can be reconfigured on-site, with the same components used by electricians everywhere, and can be purchased wherever electrical components are sold. Likewise, Connexus™ faceplates are standard Decora style, which are also readily available. VIRTU is designed to allow this reconfiguration of wiring without having to take tables apart and re-install. VIRTU is the conferencing product that best addresses the inevitability of changing office technology, and the need for interfaces to change and evolve with it. This unique design philosophy means that VIRTU will never be outmoded or outdated by changing user needs.

CONNEXUS™

Connexus™ is Krug's proprietary tabletop power and data module. When opened, it presents power and data outlets on a convenient angle to the user and provides storage for wiring.

The faceplate of Connexus™ can be either Glass or Aluminum, and sits flush with the tabletop. It is designed to allow wiring to pass through the surface cover in both the open and closed positions. The faceplate opens to a 100° angle from the table top.

Connexus™ utilizes standard receptacle outlets, which can be field converted and reconfigured at any time. Connexus™ comes with receptacles pre-wired, with a wide selection of power, data and presentation system outlets, or alternatively can be purchased as Blank modules that can be hard-wired on site by the user and reconfigured easily when this is desired. To facilitate this process, the Enclosure Box of each Connexus™ module is easily removable.

* All duplex outlets are contained within a metal box that is attached to the Partition Plate. If additional outlets need to be added in the future, these boxes need to be ordered from Krug to expand the enclosure. This modification should be done by a qualified electrician.

The labeled drawing shown below illustrates the way a Connexus™ module is shipped to the user. The Partition Plate is mounted on-site to the under side of the top and the Enclosure Box over top to conceal the module.

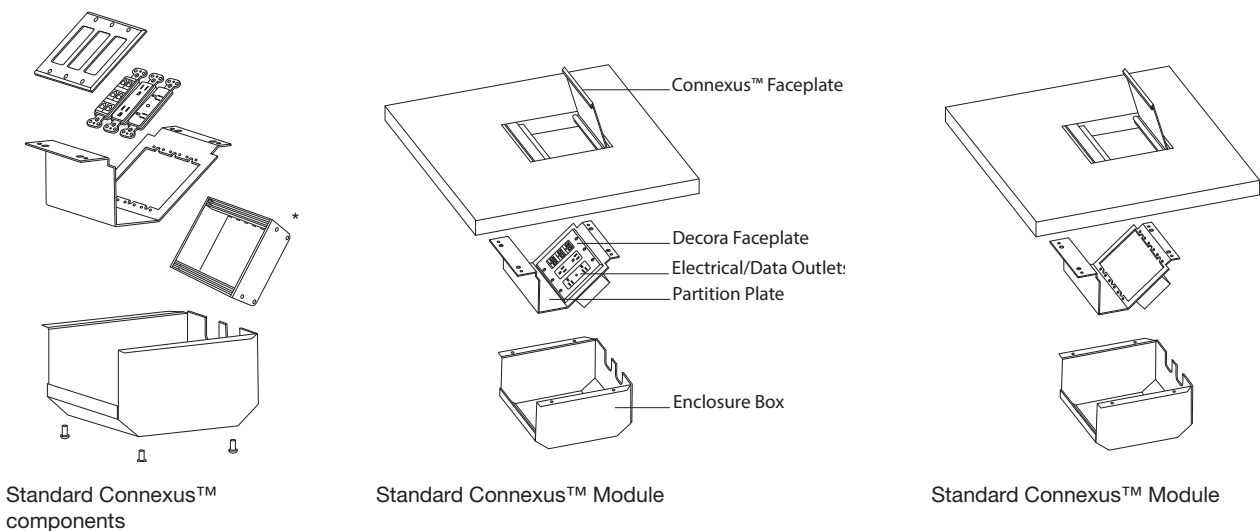

VIRTU | POWER & COMMUNICATION PLANNING

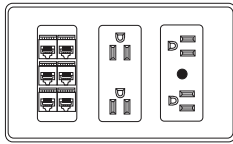

Standard

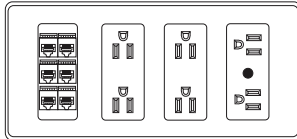

Large

Connexus™ modules may be specified in **Standard** or **Large** sizes. Standard modules are available in 6 configurations. Large modules are available in 5 configurations. As an alternative, **Blank** Connexus™ modules may be purchased for future use by the customer.

CONNEXUS™ PORT OPTIONS :

- RJ11 port** - Connection for Telephone/Modem
- RJ45 port** - Category 6 Connection for Network Connector
- AC Power** - Power Input
- RCA ports** - Female RCA type pass-through (left – black, right – red) cable connectors from stereo source to audio system
- BNC port** - High quality pass-through connector from broadcast video or computer video to display monitor
- Stereo Mini Video pass-through port** - 3.5mm Mini pass-through connector from computer sound card to amplified sound system
- 15 PIN HD** - Female RCA type pass-through cable connector for video signal from VCR or video camera source to video display or VCR
- DB-9 (Serial)** - VGA type 15 pin pass-through connector from computer video to video display monitor
- Pass-through data connector from computer to switcher control for lights, blinds, projector screens, etc.

Please note: RJ11, RJ45 and Stereo Mini are not shipped pre-wired. A telephone IT or AV specialist should perform these connections.

Connexus™ modules in **Standard** configurations are 6 1/8" x 7 3/8".

Connexus™ modules in **Large** configurations are 8 1/4" x 7 3/8".

Depth on Standard and Large modules is 4.5".

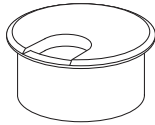

As an alternative to Connexus™, a 60mm diameter round grommet, in a Satin Aluminum finish may be specified at a list price of **\$156** per grommet.

CONNEXUS™ PLANNING

Connexus™ modules are wired independently of each other to maximize the amount of electrical devices serviced. All Connexus™ modules may sustain individual loads of 15 amps, or 12 amps of continuous load. Each Connexus™ module will require a single isolated circuit to maximize its service capabilities. Connexus™ modules are not daisy-chained together, thereby preserving the system's optimum performance. As an example, if four Connexus™ modules were specified, it will be necessary to provide two duplex outlets with a total of four circuits. Each Connexus™ module can then be plugged into each supplied outlet.

Connexus™ components are UL and CSA US approved and manufactured in accordance to the National Electrical Code.

Hardwiring Connexus™ modules on-site should be performed by a licensed electrician.

It is important to note that each Connexus™ module is rated for 15 amps and each should be connected to a single isolated circuit. Although each Connexus™ module is rated for 15 amps, please note that the National Electric Code restricts the amount of any known continuous load to 12 amps.

For maximum power utilization, it is recommended that each Connexus™ module be plugged directly into a single isolated circuit.

Below we have included a list of typical office equipment and their appropriate amp ratings to assist in planning your electrical requirements.

Typical Amp requirements of office equipment, when drawing full power.

GENERAL EQUIPMENT	AMP RATING	ELECTRONIC EQUIPMENT	AMP RATING
AC adapter	.05	Desktop printer	1.2 – 5
Adding machine	.05	Laptop	1.5 – 3.5
Answering machine	.08	Modems	.15
Calculator	.25	VDTs and PCs	.08 – 4.8
Clock	.03	Video projector	.67 – 3.47
Coffee pot	10		
Fan	1.0		
Microwave	8 – 12		
Pencil sharpener	.25		
Polycom Conference Phone	.23		
Radio	.05		
Slide projector	2 – 6		
Space heater, 1000 watts	8.6		
Space heater, 1500 watts	13		
Transcriber	.15		

VIRTU | POWER & COMMUNICATION PLANNING

ELECTRICAL CORD LENGTHS

Connexus™ modules come with pre-determined electrical cord lengths that are suited to the size and configuration of each table (6', 16', 25'). Each will plug into a standard floor monument power source. However, in situations where a table length exceeds our maximum cord length, a second power entry is necessary to avoid daisy-chaining of electrical power. To determine when a second power entry is required follow these steps:

1. Select your Connexus™ locations.
2. Select your Floor Monument Location(s) if they do not already exist in the room.
3. If the number of Connexus™ modules exceed three consecutive positions left or right of the power entry, then an additional power entry will be required.

Note: Connexus™ modules in pairs count as one position.

* Open Visio tables require 2 power sources, one per wing, or a single power source located at the apex of the two tables.

Example 1

If the designated **Floor Monument location** for the table scenario shown below is **1L**, the user would be able to power-up any or all of the following **Connexus™ locations: AL, BL, and CL.**

Example 2

If the designated **Floor Monument location** for the table scenario shown below is **2R**, the user would be able to power-up any or all of the following **Connexus™ locations: CL, CR, BR and AR.**

Monument Location Scenario

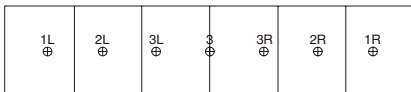

Connexus™ Location Scenario

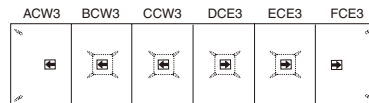

HARDWIRING ON SITE

For hardwiring on-site by electricians, please use the following schematic:

- 1 Power Supply Cord
- 2 Strain Relief
- 3 Fork Terminals
- 4 Duplex Receptacles
- 5 Outlets with Circuit Breaker Assembly
- 6 Handy Box

TWO GANG BOX

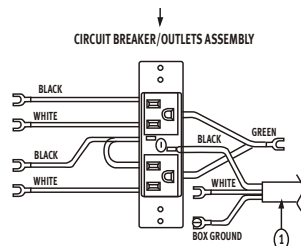
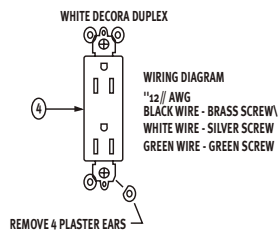
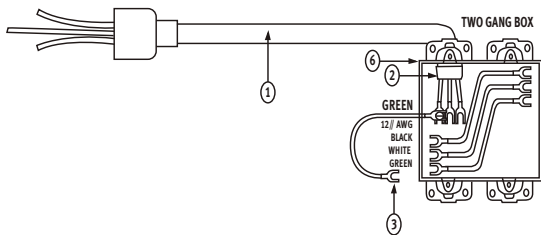

WIRE MANAGEMENT

Wires are channeled behind the Forza Leg and Forza Panel bases, and concealed by design by a black PVC insert that runs the entire length of the base. The insert is 27" long and the channel opening is approximately 1.5" x 1.25" wide.

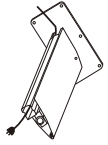

Wires are channeled through the center of Dais, Forza Rectangle, Forza Square, Oblique and Verso bases to floor monuments.

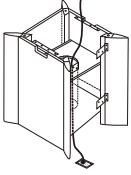

In the situation where the power source is outside of the table base, it will be necessary to pass the power supply cord underneath and into the table base. VIRTU bases are equipped with removable panels which makes access to the interior quick and easy. The Dais base (shown left) is the only exception. Dais bases are equipped with a small removable access panel, but may require a mouse-hole cut in the field.

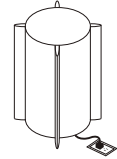

All VIRTU conference tables except open Visio are designed to accommodate wiring channeled underneath the table top and into bases. A flexible PVC wire management channel is provided with all multi-section tables at no charge, and mounted on-site. It features dual channels to allow separation of fibre optic cables. Open Visio tables use the wire management cover. All VIRTU bases have access holes to allow this wiring to pass into or out of the bases. The channel is flexible and allows for wiring to be easily inserted or removed at the sides.

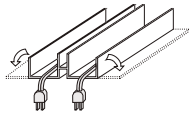

When power is being routed through Forza Leg or Forza Panel bases, velcro wire management straps are attached to the underside of the top to manage wiring from Connexus™ modules to the floor monument. The velcro straps are supplied at no charge.

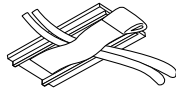

A metal cord spooler is standard on all bases with interior cavities and provided at no charge. The spooler provides for tidy wire management when there is an excessive amount of cord length.

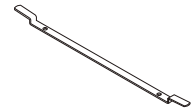

VIRTU | POWER & COMMUNICATION PLANNING

WIRE MANAGEMENT - BASES

All VIRTU table bases feature wire management capabilities for routing wires between floor monuments and Connexus™ modules. Bases with interior cavities have openings in the top and a 5" recessed bottom panel which provides full access for wiring and cord plugs to the floor. Access doors are also provided on these bases to facilitate easy access to the interior. Forza Leg and Forza Panel bases use a black PVC insert to channel wires from the table top to the floor. Please see the chart below for specifications. All bases are 29" in height. Please note that all bases with interior cavities are weighted with 72 lbs. of ballast to ensure table stability.

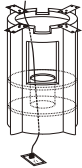
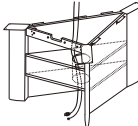
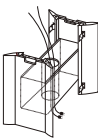
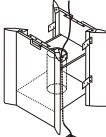
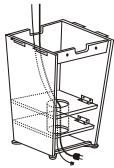
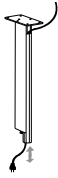
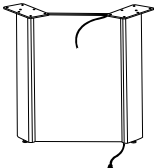
Base Type	Base Size	Door Opening Dimensions	Interior Access Cavity Dimensions
Dais Base 	18" Dia.	11.8" x 11.4"	17.25 Dia. x 14.5"
	24" Dia.	16" x 11.4"	23.25 Dia. x 14.5"
	30" Dia.	20.3" x 11.4"	29.25 Dia. x 14.5"
	Note: Cylindrical wire cavity for this base is 12" in diameter.		
Verso Base 	18" x 19"	17.75" x 27.9"	17.75 x 18 x 12"
	23" x 24"	22.5" x 27.9"	22.5 x 22.5 x 12"
Note: Used only with Verso table top. Note: Cylindrical wire cavity for this base is 6" in diameter.			
Forza Rectangle Base 	13" x 30"	24.1" x 27.9"	28.5 x 8.25 x 8.5"
Note: Cylindrical wire cavity for this base is 6" in diameter.			
Forza Square Base 	14" x 14"	10.25" x 27.9"	13 x 11.5 x 13"
	20" x 20"	16.25" x 27.9"	19 x 17.5 x 13"
	26" x 26"	22.25" x 27.9"	25 x 23.5 x 13"
	Note: Cylindrical wire cavity for this base is 6" in diameter.		
Oblique Base 	18" x 18"	17.6" x 27.6"	14.75 x 14.25 x 17.5"
	24" x 24"	23.5" x 27.6"	20.75 x 20.25 x 17.5"
	30" x 30"	29.5" x 27.6"	26.75 x 26.25 x 17.5"
Note: Cylindrical wire cavity for this base is 6" in diameter.			
Forza Leg Base 	Uses Black PVC Insert to channel wires. Insert is 27" in length. Channel opening is 1.5" x 1.25" wide.		
Forza Panel Base 	24"		
	30"		
	34"		
	41"		
	48"		
Uses Black PVC Insert to channel wires. Insert is 27" in length. Channel opening is 1.5" x 1.25" wide.			

SAMPLE CONFIGURATIONS

The following diagrams are samples of wire channeling for specific VIRTU table top and base configurations.

EXAMPLE #1 - ARCED RECTANGLE TOP WITH DAIS BASES

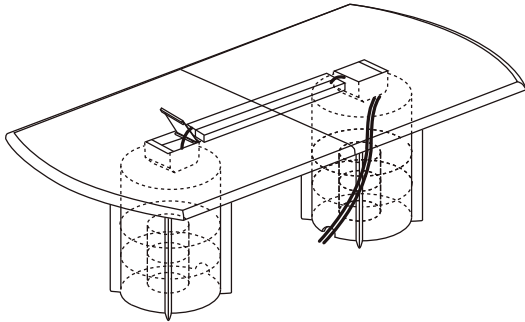

Also applicable for Forza Rectangle, Forza Square, and Oblique Bases.

EXAMPLE #4 - VERSO TOP WITH VERSO BASE AND FORZA SQUARE BASE

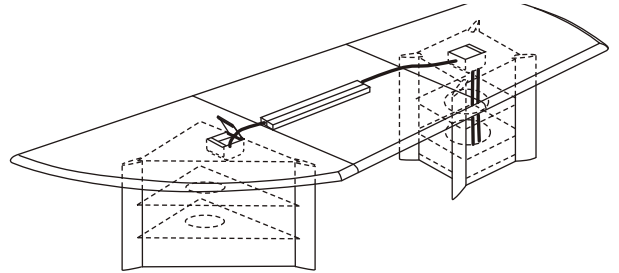

EXAMPLE #2 - ARCED RECTANGLE TOP WITH FORZA PANEL BASES

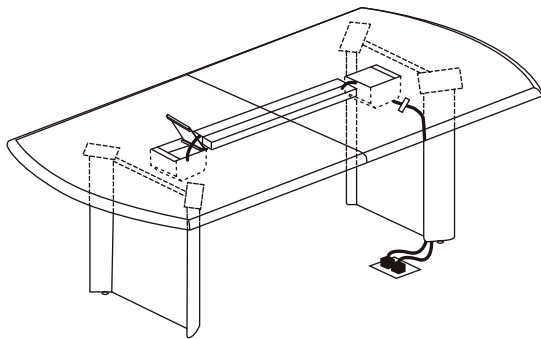

EXAMPLE #5 - OPEN VISIO TOP WITH FORZA LEG BASES

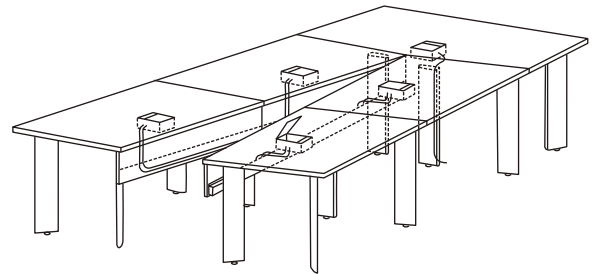

EXAMPLE #3 - ARCED RECTANGLE TOP WITH FORZA LEG BASES

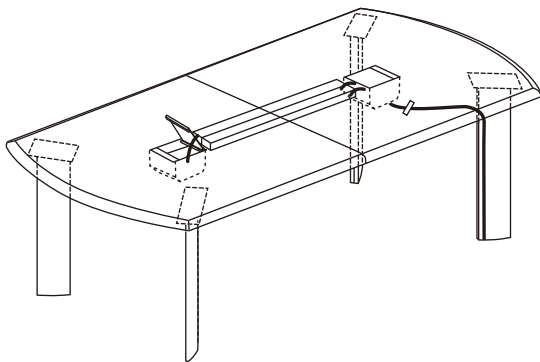

EXAMPLE #6 - VISIO TOP WITH FORZA LEG AND FORZA SQUARE BASES

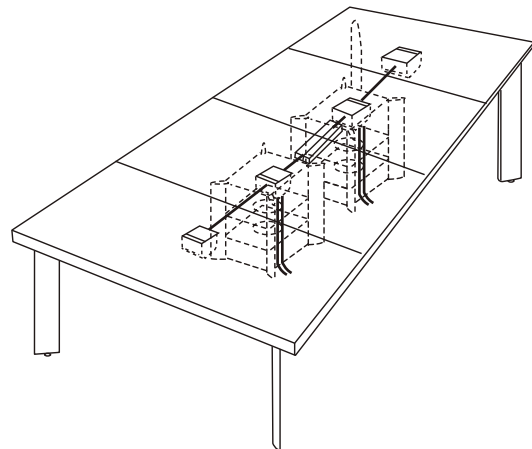

VIRTU | POWER & COMMUNICATION PLANNING

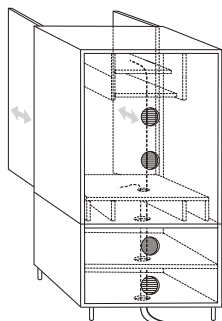

MEDIA CABINET WIRING SAMPLE

VIRTU Media Cabinets feature 2" and 4" diameter vertical and horizontal grommets to accommodate all types of videoconferencing equipment. As well, large 4" diameter air vents are strategically located on the backs of each unit. Dual Media Cabinets can accommodate two television monitors up to 35" wide, Large Media Cabinets accommodate one 35" wide monitor, and Small Media Cabinets can accommodate television monitors up to 27" wide. Cabinets can also accommodate videoconferencing cameras and microphone systems, DVD and VCR players, and projectors. Below is an example of wire management on a VIRTU Media Cabinet.

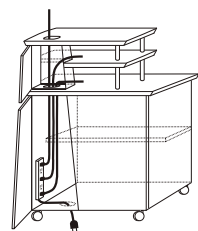

MEDIA CART WIRING SAMPLE

VIRTU Media Carts accommodate laptops or keyboards on the primary surface of the cart, and television monitors up to 27" on the top shelf. DVD and VCR players can be accommodated on all surfaces. Media Carts, depending on the model, come equipped with several vertical and horizontal grommets to provide easy connection between equipment located on the interior and exterior of the cart. Media Carts also feature a standard power bar. Below is an example of wire management on the VIRTU Media Cart.

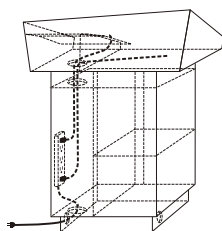

LECTERN WIRING SAMPLE

VIRTU Lecterns offer the presenter various media options. Notebook computers, paper notes, lighting, microphones, pens and pencils, a glass of water... everything for a presenter can be accommodated. The optional Altinex power and data interface system is concealed but easily accessed. The hinged rear door, which is standard on lecterns with front hinged doors, provides access to the interior for a computer CPU to run presentations. An optional power bar is available. Below is an example of wire management on a VIRTU Lectern.

ALTINEX

The Altinex box offers an ideal solution for the power and data requirements of a speaker using the VIRTU Lectern.

Altinex features the following power/data connectors:

- | | | |
|---|------------------------|--|
| A | (1) Stereo Mini | 3.5 mm Mini pass-through connector from computer sound card to amplified sound system |
| B | (1) BNC port | High quality pass-through connector from broadcast video or computer video to video display monitor |
| C | (1) RJ11 port | Connection for Telephone / Modem |
| D | (1) RJ45 port | Connection for Network Connector |
| E | (2) RCA ports | Female RCA type pass-through (Left - Black, Right - Red) cable connectors from stereo audio source to audio system |
| F | (1) 15 Pin HD port | VGA type 15 pin pass-through connector from computer video to display monitor |
| G | (1) Simplex Power port | Power Input |

For more information or questions regarding the Altinex Box, please contact Krug Customer Service or Altinex Technical Support at 1-800-258-4623.

This option is available on VIRTU lecterns at an upcharge of **\$1273 list**.

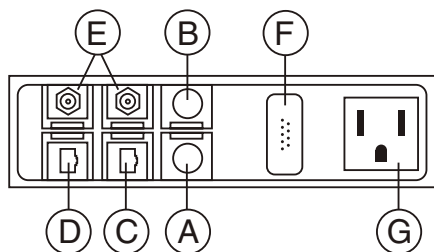

Connexus™ is Krug's proprietary tabletop connectivity solution. When opened, it presents power and data outlets on a convenient angle to the user and provides storage for wiring.

The faceplate of Connexus™ is available in either Glass or Aluminum and sits flush with the tabletop. It is designed to allow wiring to pass through the surface cover in both the open and closed positions. The faceplate opens to a 100° angle from the table top.

Connexus™ utilizes UL standard receptacle outlets. Connexus™ offers 11 pre-configured units with a wide selection of power, data and presentation system outlets, or alternatively can be purchased with just electrical ports with blank data ports. Connexus™ also can be designed and built specifically to meet your connectivity needs by using the snap-in or plate mounted port options.

All corded units can be modified to allow the units to be hard wired by an electrician and data ports can be reconfigured easily when desired. To facilitate this process, the Enclosure Box of each Connexus™ module is easily removable.

*All duplex outlets are contained within a metal box that is attached to the Partition Plate. If additional outlets need to be added in the future, these boxes need to be ordered from Krug to expand the enclosure. All modifications must be done by a qualified electrician.

The label drawing shown below illustrates the way a Connexus™ module is shipped to the user. The Partition Plate is mounted on-site to the underside of the top with the Enclosure Box over top to conceal the module. Please note, enclosure boxes are not required when modules are enclosed in a base. Enclosure boxes are not supplied with Connexus™ modules; they must be ordered separately when required.

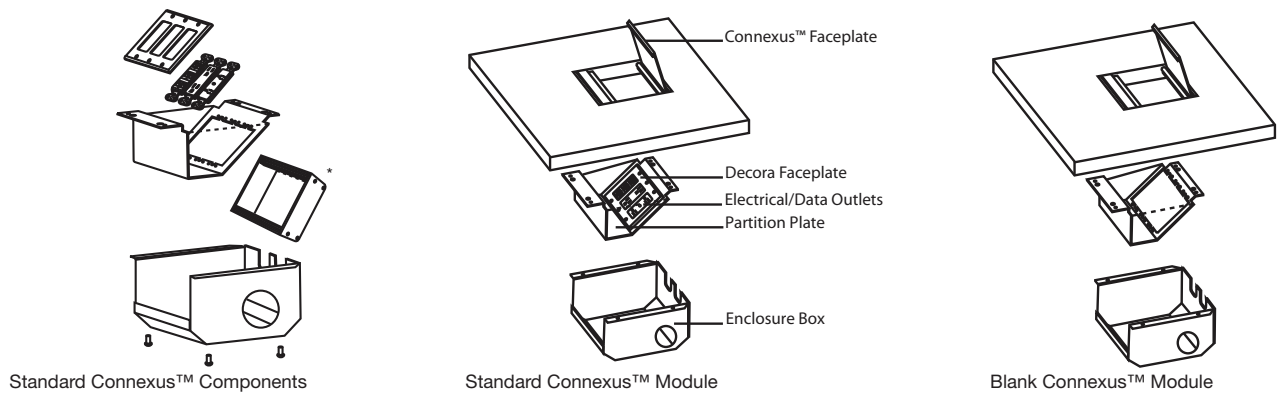

CONNEXUS™ SIZES

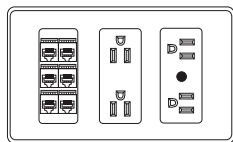

Standard - 3 Gang

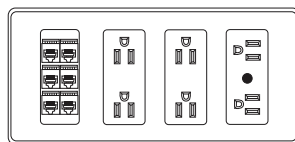

Large - 4 Gang

Connexus™ modules may be specified in Standard or Large sizes.

Standard modules are available in 7 standard configurations or custom configurations. Connexus™ modules in Standard configurations are 6 1/8" x 7 3/8". Depth on Standard module is 4.5".

Large modules are available in 4 standard configurations or custom configurations. Connexus™ modules in Large configurations are 8 1/4" x 7 3/8". Depth on Large module is 4.5".

CONNEXUS™ | PLANNING

Connexus™ modules are wired independently of each other to maximize the amount of electrical devices serviced. All Connexus™ modules may sustain individual loads of 15 amps or 12 amps of continuous load. Each Connexus™ module will require a single isolated circuit to maximize its service capabilities. An optional utility a/c power outlet is available on the back surface of the outlet box.

Connexus™ components are UL and CSA US approved and manufactured in accordance to the National Electrical Code. Hardwiring Connexus™ modules on-site must be performed by a licensed electrician. Connexus™ units can be ordered with an optional utility outlet, which is located on the bottom side of the Connexus™ unit and underneath the work surface. Other Connexus™ products could employ these utility outlets as a source of power. In this scenario, it is solely the responsibility of the end user to assure that proper circuit protection is in place that never exceeds the 15 Ampere Circuit Breaker Rating.

CONNEXUS™

ELECTRICAL CORD LENGTHS

Connexus™ modules come with pre-determined electrical cord lengths that are suited to the size and configuration of each table (16' & 25'). Each will plug into a standard floor monument power source. However, in situations where a table length exceeds our maximum cord length, a second power entry is necessary to avoid daisy-chaining of electrical power. To determine when a second power entry is required follow these steps:

1. Select your Connexus™ locations.
2. Select your Floor Monument Location(s) if they do not already exist in the room.
3. If the number of Connexus™ modules exceed three consecutive positions left or right of the power entry, then an additional power entry will be required.

Note: Connexus™ modules in pairs count as one position.

HARDWIRING ON SITE

For hardwiring on-site by electricians, please use the following schematic:

- ① Power Supply Cord
- ② Strain Relief
- ③ Fork Terminals
- ④ Duplex Receptacles
- ⑤ Outlets with Circuit Breaker Assembly
- ⑥ Handy Box

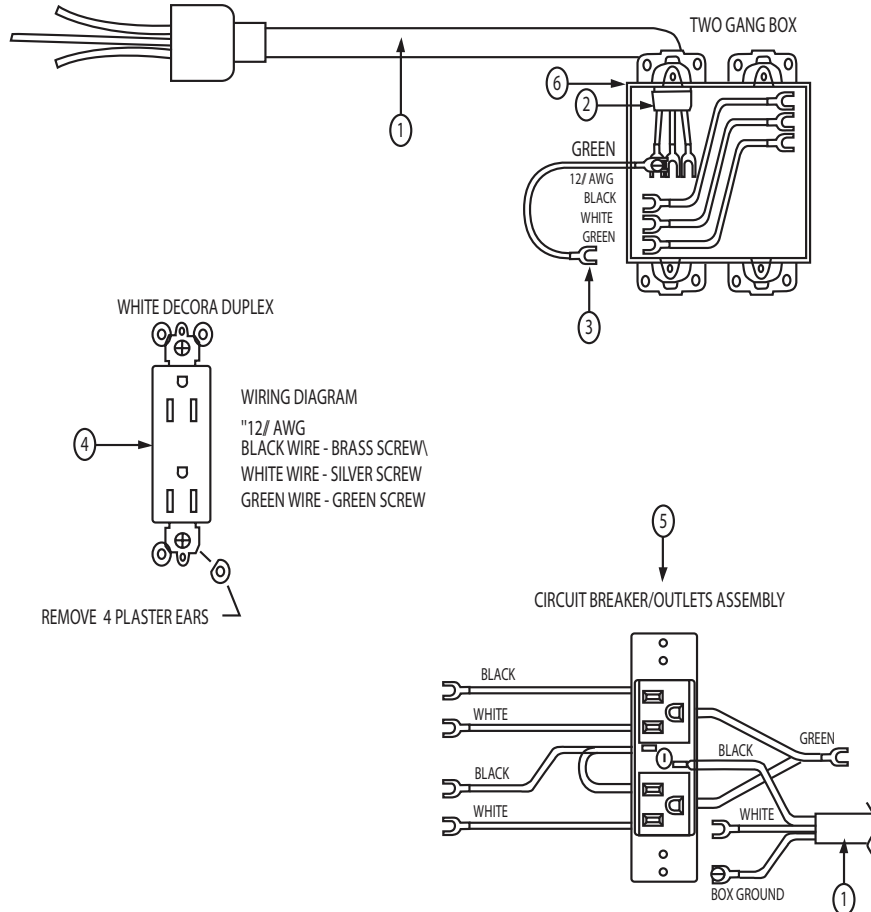

CONNEXUS™ | PRECONFIGURED STANDARD MODULES

Standard - 3 GANG

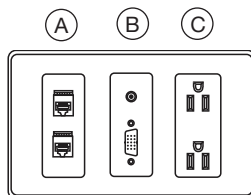
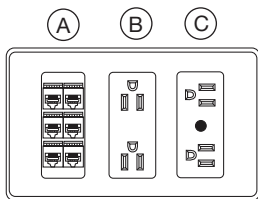
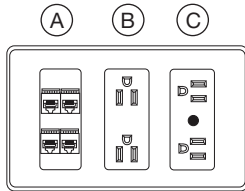
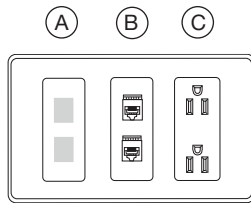
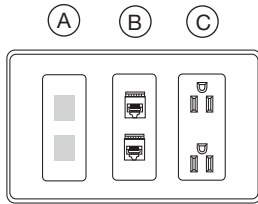

Port Options	Model #	List Price	
		Aluminum	Glass
BASIC DATA	62 CON BD	994	1098
(A) (2) Blanks (for future use)			
(B) (2) RJ45 port (Category 6)			
(C) (2) AC power ports			
BASIC VOICE DATA	62 CON BV	962	1068
(A) (2) Blanks (for future use)			
(B) (1) RJ11 port			
(B) (1) RJ45 port (Category 6)			
(C) (2) AC power ports			
EXPANDED DATA	62 CON ED	1222	1327
(A) (4) RJ45 port (Category 6)			
(B) (2) AC power ports			
(C) (2) AC power ports / with 15 amp circuit breaker			
EXPANDED VOICE/DATA	62 CON	1251	1356
(A) (2) RJ11 port			
(A) (4) RJ45 port (Category 6)			
(B) (2) AC power ports			
(C) (2) AC power ports / with 15 amp circuit breaker			
BASIC MULTIMEDIA	62 CON BM	1131	1236
(A) (1) RJ11 port			
(A) (1) RJ45 port (Category 6)			
(B) (1) 3.5 mm Mini			
(B) (1) VGA Type 15 pin HD			
(C) (2) AC power ports			

ORDERING NOTE: Enclosure box is only required only when the Connexus™ is not positioned over a base. If an enclosure box is required, please clearly state this requirement on your purchase order and add the **\$302** per Connexus™.

CONNEXUS™ | PRECONFIGURED STANDARD MODULES

Standard - 3 GANG

Port Options	Model #	List Price	
		Aluminum	Glass

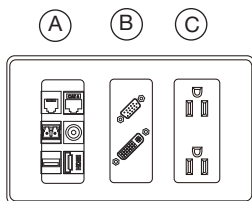

DATA & MULTIMEDIA	62 CON DM	1439	1536
<p>(A)</p> <ul style="list-style-type: none"> (1) RJ11 (1) RJ45 (1) Fiber Optic LC Duplex (1) 3.5mm Stereo Mini (1) USB "A" (1) HDMI <p>(B)</p> <ul style="list-style-type: none"> (1) DVI-I (1) VGA <p>(C)</p> <ul style="list-style-type: none"> (2) AC power ports 			

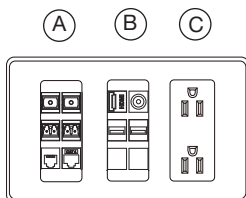

BASIC FIBRE OPTIC & MULTIMEDIA	62 CON BF	1381	1478
<p>(A)</p> <ul style="list-style-type: none"> (2) Fibre Optic SC Simplex (2) Fiber Optic LC Duplex (1) RJ11 (1) RJ45 <p>(B)</p> <ul style="list-style-type: none"> (1) HDMI (1) 3.5mm Stereo Mini (2) USB "A" (2) Blanks <p>(C)</p> <ul style="list-style-type: none"> (2) AC power ports 			

ORDERING NOTE: Enclosure box is only required only when the Connexus™ is not positioned over a base. If an enclosure box is required, please clearly state this requirement on your purchase order and add the **\$302** per Connexus™.

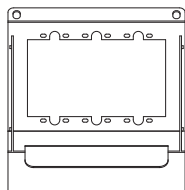

STANDARD BLANK MODULE	62 CON X1	113
Blank Modules does not include the Connexus™ lid.		

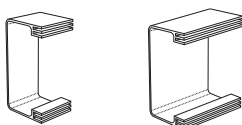

DUPLEX OUTLET ENCLOSURE	62 CON OUTBOX-1	44
To be used when adding duplex outlets to existing Connexus™ Modules.	62 CON OUTBOX-2	57
	62 CON OUTBOX-3	72

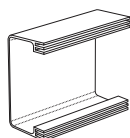

CONNEXUS™ | PRECONFIGURED LARGE MODULES

Large - 4 GANG

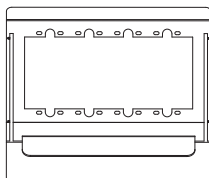
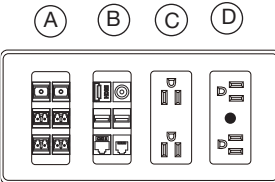
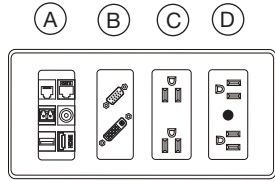
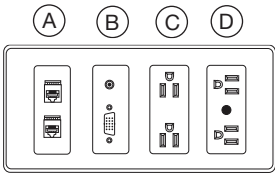
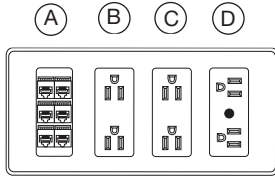

Port Options	Model #	List Price	
		Aluminum	Glass

NETWORK AND POWER CENTRE

62 CON NP

1522

1612

- (A) (6) RJ-45 ports
- (B) (2) AC power ports
- (C) (2) AC power ports
- (D) (2) AC power ports/with 15 amp circuit breaker

BASIC MULTIMEDIA WITH 2X POWER

62 CON B2

1393

1483

- (A) (1) RJ11 port
(1) RJ45 port
- (B) (1) 3.5 mm Mini with 2x Power
(1) VGA type 15 pin HD
- (C) (2) AC power ports
- (D) (2) AC power ports/with 15 amp circuit breaker

DATA & MULTIMEDIA WITH 2X POWER

62 CON DM2

1822

1913

- (A) (1) RJ11 port
(1) RJ45 port
(1) 1 Fiber Optic LC Duplex
(1) 1 3.5mm Stereo Mini
(1) 1 USB "A"
(1) 1 HDMI
- (B) (1) DVI-I
(1) VGA
- (C) (2) AC power ports
- (D) (2) AC power ports/with 15 amp circuit breaker

EXPANDED FIBRE OPTIC AND MULTIMEDIA

62 CON EF

1897

1988

- (A) (2) Fibre Optic SC Simplex
(4) Fiber Optic LC Duplex
- (B) (1) HDMI,
(1) Stereo 3.5 Mini
(2) USB "A",
(1) RJ45
(1) RJ11
- (C) (2) AC power port
- (D) (2) AC power ports/with 15 amp circuit breaker

LARGE BLANK MODULE

62 CON X2

137

Blank Modules does not include the Connexus™ lid.

ORDERING NOTE: Enclosure box is only required when the Connexus™ is not positioned over a base. If an enclosure box is required, please clearly state this requirement on your purchase order and add the **\$302** per Connexus™.

CONNEXUS™ | CUSTOM CONNEXUS™

Planning a custom Connexus™ unit is easy when following these 6 simple steps.

STEP ONE: Select the quantity of AC power ports or AC power ports with USB Charging (select configurations only) that are required.

Power modules must always be positioned starting from the right side of the unit. For example, 3 gang Connexus™ can have a power module located in position C with data ports in position A and B, or power can be located in position B and C with data port in position A, or position A,B and C can have all power ports or all data ports. Please note, 4 gang Connexus™ are not available with power ports located in position A.

On select configurations shown below, USB charging outlets are available. These charging outlets allow a user to charge most personal electronic devices without the need for any special power adapter or a computer - simply plug in your device with any compatible USB cable. This component has 2 USB charging slots that supply 5V DC at 700mA. Comes with a charging indicator light, as well as a standard 120 volt simplex receptacle on the bottom portion of the component.

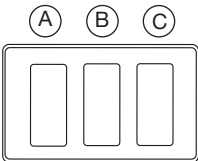
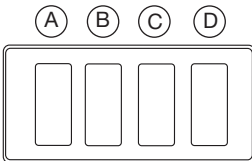
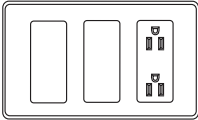
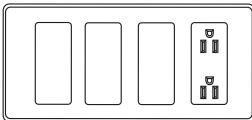
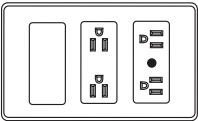
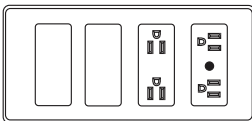
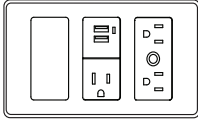
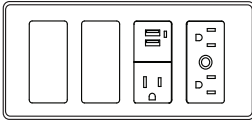
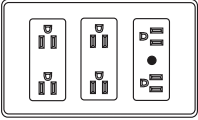
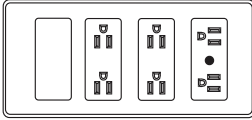
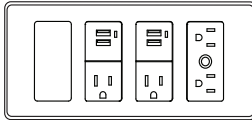
Standard Connexus™	List Price	Large Connexus™	List Price
 <p>3 Gang: Data ports only E300 - Standard Data Ports</p>	77	 <p>4 Gang: Data Ports only E400 - Large Data Ports</p>	159
 <p>3 Gang: AC Power Port E31S - Standard Outlet 530 E31U - Standard & Utility Outlets 565</p>		 <p>4 Gang: AC Power Port E41S - Large Outlet 596 E41U - Large & Utility Outlets 633</p>	
 <p>3 Gang: AC Power Port / AC Power Port with 15 amp circuit breaker E32S - Standard Outlet 694 E32U - Standard & Utility Outlet 731</p>		 <p>4 Gang: AC Power Port / AC Power Port with 15 amp circuit breaker E42S - Large Outlet 778 E42U - Large & Utility Outlets 812</p>	
 <p>3 Gang: AC Power Port Simplex with USB Charging/AC Power Port with 15 amp circuit breaker E32SC - Standard Outlet 919 E32UC - Standard & Utility Outlet 957</p>		 <p>4 Gang: AC Power Port Simplex with USB Charging/AC Power Port with 15 amp circuit breaker E42SC - Standard Outlet 1002 E42UC - Standard & Utility Outlet 1039</p>	
 <p>3 Gang: (2) AC Power Port / AC Power Port with 15 amp circuit breaker E33S - Standard Outlet 844 E33U - Standard & Utility Outlet 882</p>		 <p>4 Gang: (2) AC Power Port / AC Power Port with 15 amp circuit breaker E43S - Large Outlet 830 E43U - Large & Utility Outlets 868</p>	
		 <p>4 Gang: (2) AC Power Port Simplex with USB Charging/AC Power Port with 15 amp circuit breaker E43SC - Standard Outlet 1056 E43UC - Standard & Utility Outlet 1092</p>	

STEP TWO : There are two cord end options available; Plug In and Conduit. The standard Plug In option will connect with any standard floor monument power source. The Conduit option is Liquatite® (a steel inner conduit with a PVC overlay) by Anamet, meant for specific hard wiring applications. Units can come in cord lengths of 16' or 25'. Not Applicable if no power is selected.

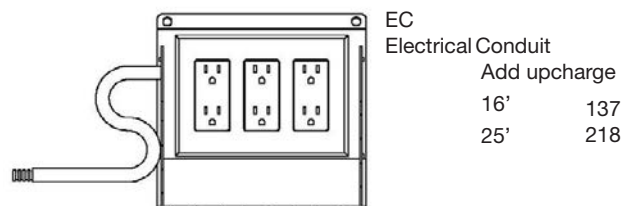
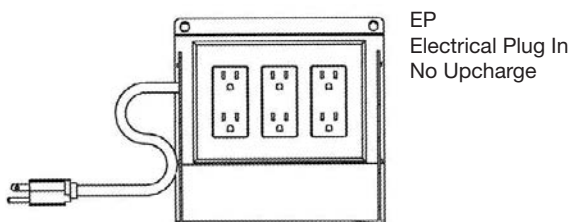

STEP THREE: There are two data options available; Plate mounted ports or Snap-in ports. Snap-in ports are available in configurations of two, four or six. Choose the faceplate below that meets your data requirements. If an odd number of Snap-in ports are required, a blank port needs to be selected when the opening is not in use.

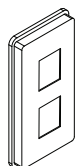

M02
Mounting Plate (2)
accepts two snap in data ports
Add \$37 list

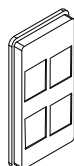

M04
Mounting Plate (4)
accepts four snap in data ports
Add \$37 list

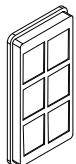

M06
Mounting Plate (6)
accepts six snap in data ports
Add \$37 list

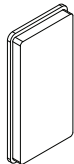

M00
Mounting Plates
Add \$37 list

STEP FOUR: Choose the Plate mounted port or Snap-in ports options for non-powered positions. As an aid, use the chart below to help design and build your Connexus™ to meet the rooms needs. Use the check boxes and list the components on the lines below.

Standard Connexus™

(A)	(B)	(C)
<input type="checkbox"/> POWER	<input type="checkbox"/> POWER/POWER & USB CHARGING	<input type="checkbox"/> POWER
OR	OR	OR
<input type="checkbox"/> PLATE MOUNTED PORT	<input type="checkbox"/> PLATE MOUNTED PORT	<input type="checkbox"/> PLATE MOUNTED PORT
OR	OR	OR
<input type="checkbox"/> SNAP-IN PORTS	<input type="checkbox"/> SNAP-IN PORTS	<input type="checkbox"/> SNAP-IN PORTS
_____	_____	_____
_____	_____	_____
_____	_____	_____

Large Connexus™

(A)	(B)	(C)	(D)
<input type="checkbox"/> POWER	<input type="checkbox"/> POWER/POWER & USB CHARGING	<input type="checkbox"/> POWER/POWER & USB CHARGING	<input type="checkbox"/> POWER
OR	OR	OR	OR
<input type="checkbox"/> PLATE MOUNTED PORT	<input type="checkbox"/> PLATE MOUNTED PORT	<input type="checkbox"/> PLATE MOUNTED PORT	<input type="checkbox"/> PLATE MOUNTED PORT
OR	OR	OR	OR
<input type="checkbox"/> SNAP-IN PORTS	<input type="checkbox"/> SNAP-IN PORTS	<input type="checkbox"/> SNAP-IN PORTS	<input type="checkbox"/> SNAP-IN PORTS
_____	_____	_____	_____
_____	_____	_____	_____
_____	_____	_____	_____

STEP FIVE: Select the Connexus™ Cover (Aluminum or Glass)

Standard Connexus™

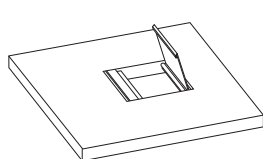

3 GANG

3CCA	Aluminum	\$397 list
3CFG	Glass	\$468 list
3C00	No Lid	

Large Connexus™

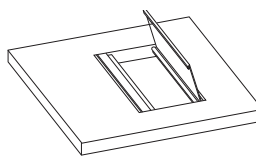

4 GANG

4CCA	Aluminum	\$391 list
4CFG	Glass	\$483 list
4C00	No Lid	

STEP SIX: Enclosure box is only required only when the Connexus™ is not positioned over a base. If an enclosure box is required, please clearly state this requirement on your order and add the **\$302** per Connexus™.

STEP SEVEN: Calculate the total list price for the custom Connexus™ by adding the following prices:

- Connexus™ Box with required AC Power Ports
- Faceplate (Snap-in Ports Only)
- Snap-In Ports or Plate Mounted Data Ports
- Enclosure Box (if required)
- Connexus™ Lid (Aluminum or Glass)



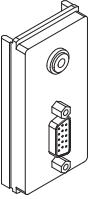
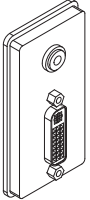
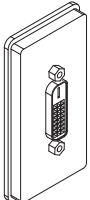
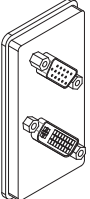
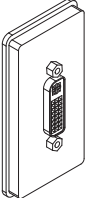
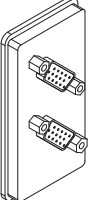
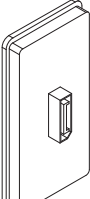

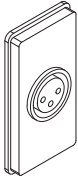
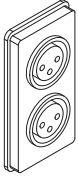
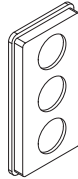
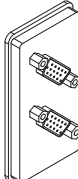
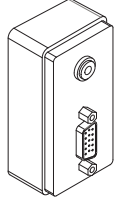
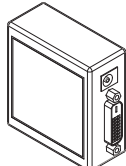

CONNEXUS™ | PORT OPTIONS

PLATE MOUNTED PORTS	Reference Code	Description	List Price
	P01	VGA & 3.5 STEREO MINI - Use for VGA (DB15) connections and for 3.5mm stereo connections. Connector is a female input with screw terminal output (back side of Console interface).	143
	P02	DVI-I DUAL (DIGITAL/ANALOG) & 3.5 STEREO MINI - Use for DVI Integrated - Digital and Analog connections and for 3.5mm stereo connection. The DVI connector is a Dual Link. DVI-I connector is a female-to-female pass through and the 3.5 Mini is a female input with screw terminal output (back side of Console interface).	212
	P03	DVI-D DUAL (DIGITAL) - Use for DVI-D Digital only connection. The connector is a Dual Link. Connector is a female-to-female pass through.	137
	P04	DVI-I DUAL (DIGITAL/ANALOG) & VGA - Use for DVI Integrated - Digital and Analog and for VGA (DB15) connections. The DVI connector is a Dual Link. Both connectors are female-to-female pass through.	271
	P05	DVI-I DUAL (DIGITAL/ANALOG) - Use for DVI Integrated -Digital and Analog connections. DVI connector is a Dual Link. Connector is a female-to-female pass through.	173
	P06	VGA-2 - Use for two VGA (DB15) connections. Both connectors are female-to-female pass through.	168
	P07	DISPLAYPORT - Use for DisplayPort connection. This connector is primarily used to connect a video source to a display device and also carries audio signals, Connector is a female input to a 3' corded output (back side of Console interface) with a male Display Port termination.	168

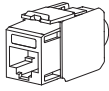

CONNEXUS™ | PORT OPTIONS

PLATE MOUNTED PORTS	Reference Code	Description	List Price
	P08	MICROPHONE XLR STANDARD - Use for standard size XLR microphone connection. Connector is a female input with a 3 pin screw terminal output (back side of Console interface).	228
	P09	MICROPHONE STANDARD XLR -2 - Use for two standard size XLR microphone connections. Each connector is a female input with a 3 pin screw terminal output (back side of Console interface).	333
	P10	3 HOLE CABLE PASS THROUGH - Use for running loose cables from the under side of the table up into the Console interface cavity. Often used with running wires for PolyCom™ devices.	54
	P11	VGA-to-BNCx2 - Use for two VGA (DB15) connections that are input female pass through and are terminated on the output (back side of Console interface) with 5 BNC female pigtail connections, for each VGA connector.	542
	P12	INPUT VGA & 3.5 Stereo (POWERED) - VGA + Audio Line Driver designed for VGA (DB15) connections and for 3.5mm stereo connections. This unit provides a method of transmitting signals to a remote display and audio receiver or amplifier. VGA connector is a female input and comes with cabling for either VGA output, or 5 BNC output and the 3.5 Mini is a female input with screw terminal output (back side of Console interface). A 9 volt DC 500mA power supply is required to power this unit.	1327
PORT ACCESSORIES	Reference Code	Description	List Price
	DVIR	DVI-REPEATER - Is a cable equalizer that automatically compensates for long DVI cable runs. This unit extends the usable cable distance up to 130ft depending on the quality of the cable and the resolution of the video signal. Additionally, it is capable of extending dual link signals allowing for much greater resolutions and refresh rates. This unit comes with a power supply and is generally mounted underneath a table.	1046

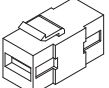
CONNEXUS™ | PORT OPTIONS

SNAP IN PORTS	Reference Code	Description	List Price
	S01W S01B S01R	RJ-45 - Category 6 data connection. This connector is also downwards compatible with Category 5 cabling. Connector is a female input with a #110 punch-down terminal block output (back side of Console interface) for on-site hard wire connection. RJ45-CAT6 (White) RJ45-CAT6 (Blue) RJ45-CAT6 (Red)	47
	S02W S02B S02G S02R S02Y	RJ11 - Telephone type connection. Connector is a female input with a #110 punch-down terminal block output (back side of Console interface) for on-site hard wire connection. RJ11 (White) RJ11-B (Black) RJ11-G (Green) RJ11-R (Red) RJ11-Y (Yellow)	32
	S03	3.5 STEREO MINI - 3.5mm stereo connection. Connector is a female input with screw terminal output (back side of Console interface).	92
	S04	HDMI - High Definition Multimedia Interface connection. Connector carries both HD audio and video data. Connector is a female-to-female pass through.	173
	S05	RCA-LEFT - RCA left audio channel connection. Color coded with black. Connector is a female-to-female pass through.	38
	S06	RCA-RIGHT -RCA right audio channel connection. Color coded with red. Connector is a female-to-female pass through.	38
	S07	RCA- VIDEO - RCA video channel connection. Color coded with yellow. Connector is a female-to-female pass through.	38
	S08	USB-A - Full size USB “A” style connection. Connector is a female-to-female pass through.	61

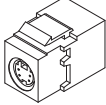
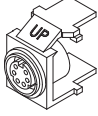
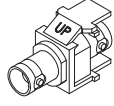
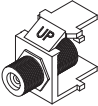
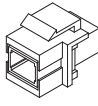
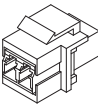
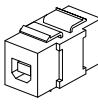
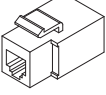
CONNEXUS™ | PORT OPTIONS

SNAP IN PORTS	Reference Code	Description	List Price
	S09	3 PIN MINI XLR - 3 Pin Mini XLR microphone connection. Connector is a female input to a 6' corded output (back side of Console interface) with a 3 Pin Mini XLR male termination.	704
	S10	S-VIDEO - S-Video connection. Connector is a female-to-female pass through.	65
	S11	PS/2 (6 PIN MINI DIN) - PS/2 (mouse, keyboard, other input devices) connections. Connector is a female-to-female pass through.	81
	S12	BNC - BNC style data connection for use with co-axial cable. Connector is a female-to-female pass through.	45
	S13	F-TYPE - F-Type (DSL,Cable) connections, generally for high speed Internet or video applications. Connector is a female-to-female threaded pass through.	37
	S14	FIBER OPTIC SC - Fibre Optic SC Simplex connection. Connector is a female-to-female pass through. Please note that two of these connectors are required to complete the data transmissions to and from the source and destination units.	45
	S15	FIBER OPTIC LC - Fibre Optic LC Duplex connection. Connector is a female-to-female pass through. One connector only is required to complete the data transmissions to and from source and destination units.	88
	S16	USB-B - USB "B" type connection. Connector is a female "B" input to a female "A" output (back side of Console interface). This connector is reversible.	131
	S17	RJ12 (White) - RJ12 style PolyCom™ connection. Connector is a female input with a 6' corded output (back side) of Console interface) with a male RJ12 termination.	281
	S00	BLANK COVER - Blank covers are required when port is not in use.	16

NOTE: Up to 6 snap-in data ports can be ordered for open data positions. Snap-in adaptors can accept 2, 4 or 6 snap-in data ports. Please order a blank port when an odd number of snap-in ports are specified.

VIRTU | CONNEXUS™ LOCATIONS CHARTS

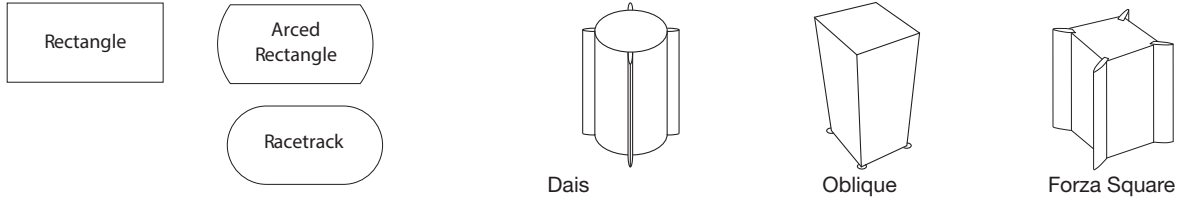

The Connexus™ Locations diagrams below show the available Connexus™ locations for only the top and base configurations shown above. **Please note that the maximum allowable Connexus™ modules per top are shown, and tops may be specified with fewer modules.** Each Connexus™ module has a code to represent its location on the table surface. To specify a Connexus™ module in a particular location, please use the code listed above it. Note that Large Connexus™ modules can only be specified on the outside sections of tops. **Connexus™ locations and quantities may be limited if Floor Monuments already exist at installation site. Please see Floor Monuments section for more information. For large Connexus™ units, please replace “3” in location code with “4”.** Codes that appear above table illustrations represent single center locations, in which unit will face West if on left end of top, and East if on right end of top. Note: For Connexus™ locations other than those shown below, contact Customer Service for upcharge.

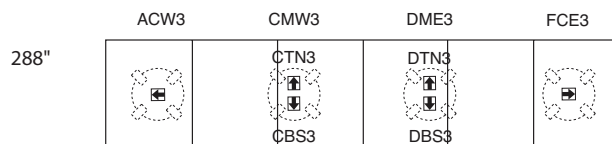
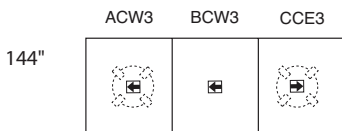
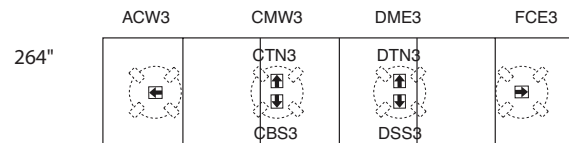
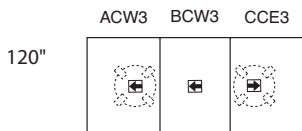
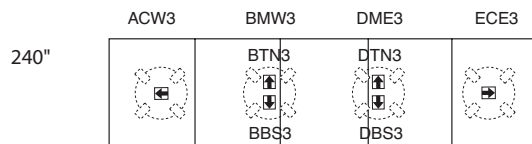
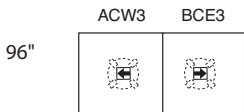
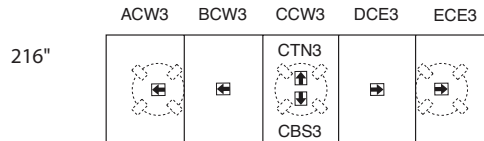
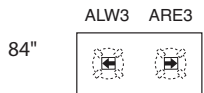
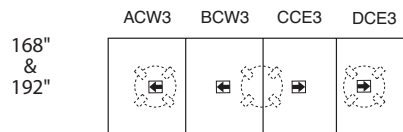
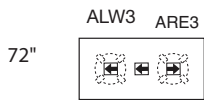

REPRESENTS MODULES THAT WHEN OPENED FACE THE ENDS OF THE TABLE

REPRESENTS MODULES THAT WHEN OPENED FACE THE SIDES OF THE TABLE

VIRTU | CONNEXUS™ LOCATIONS CHARTS

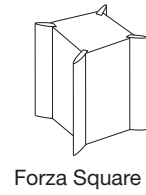
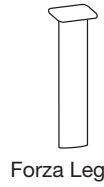
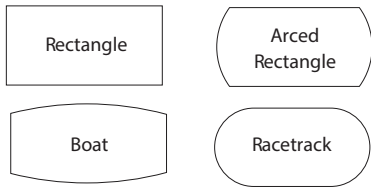

The Connexus™ Locations diagrams below show the available Connexus™ locations for only the top and base configurations shown above. **Please note that the maximum allowable Connexus™ modules per top are shown, and tops may be specified with fewer modules.** Each Connexus™ module has a code to represent its location on the table surface. To specify a Connexus™ module in a particular location, please use the code listed above it. Note that Large Connexus™ modules can only be specified on the outside sections of tops. **Connexus™ locations and quantities may be limited if Floor Monuments already exist at installation site. Please see Floor Monuments section for more information. For large Connexus™ units, please replace “3” in location code with “4”.** Codes that appear above table illustrations represent single center locations, in which unit will face West if on left end of top, and East if on right end of top. Note: For Connexus™ locations other than those shown below, contact Customer Service for upcharge.

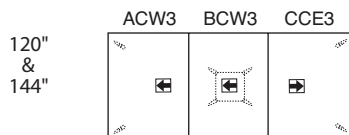
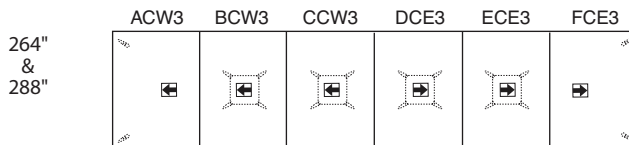
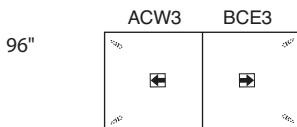
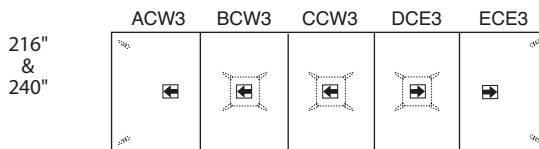
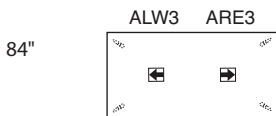
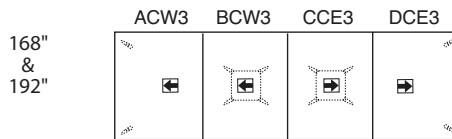
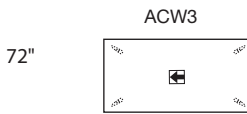

REPRESENTS MODULES THAT WHEN OPENED FACE THE ENDS OF THE TABLE

REPRESENTS MODULES THAT WHEN OPENED FACE THE SIDES OF THE TABLE

VIRTU | CONNEXUS™ LOCATIONS CHARTS

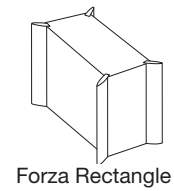
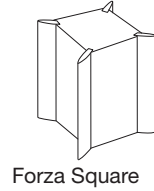
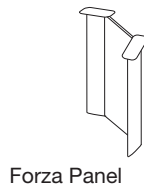
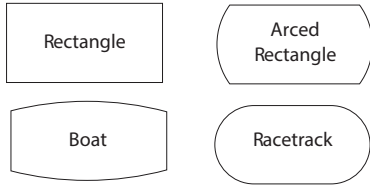

The Connexus™ Locations diagrams below show the available Connexus™ locations for only the top and base configurations shown above. **Please note that the maximum allowable Connexus™ modules per top are shown, and tops may be specified with fewer modules.** Each Connexus™ module has a code to represent its location on the table surface. To specify a Connexus™ module in a particular location, please use the code listed above it. Note that Large Connexus™ modules can only be specified on the outside sections of tops. **Connexus™ locations and quantities may be limited if Floor Monuments already exist at installation site. Please see Floor Monuments section for more information. For large Connexus™ units, please replace “3” in location code with “4”.** Codes that appear above table illustrations represent single center locations, in which unit will face West if on left end of top, and East if on right end of top. Note: For Connexus™ locations other than those shown below, contact Customer Service for upcharge.

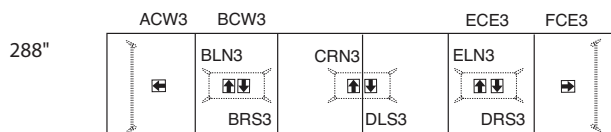
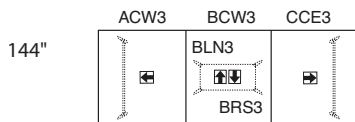
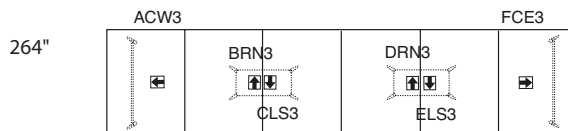
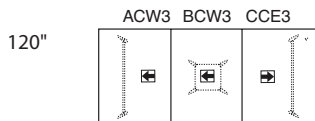
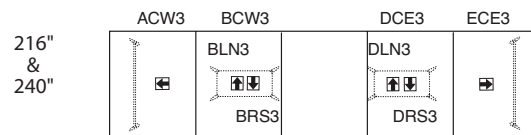
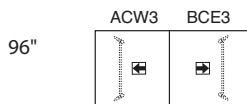
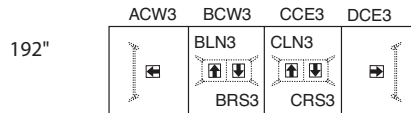
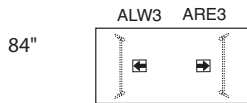
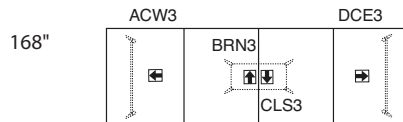
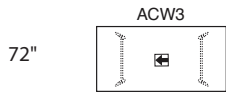

REPRESENTS MODULES THAT WHEN OPENED FACE THE ENDS OF THE TABLE

REPRESENTS MODULES THAT WHEN OPENED FACE THE SIDES OF THE TABLE

VIRTU | CONNEXUS™ LOCATIONS CHARTS

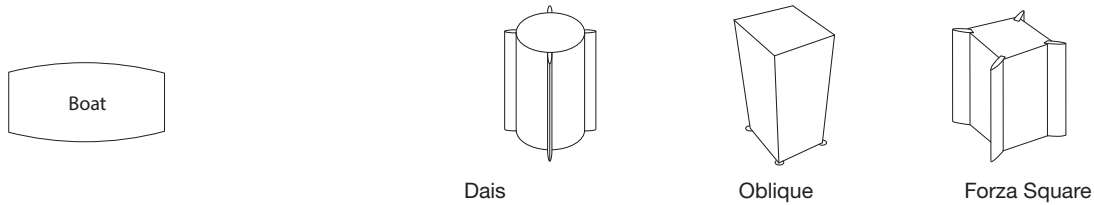

The Connexus™ Locations diagrams below show the available Connexus™ locations for only the top and base configurations shown above. **Please note that the maximum allowable Connexus™ modules per top are shown, and tops may be specified with fewer modules.** Each Connexus™ module has a code to represent its location on the table surface. To specify a Connexus™ module in a particular location, please use the code listed above it. Note that Large Connexus™ modules can only be specified on the outside sections of tops. **Connexus™ locations and quantities may be limited if Floor Monuments already exist at installation site. Please see Floor Monuments section for more information. For large Connexus™ units, please replace “3” in location code with “4”.** Codes that appear above table illustrations represent single center locations, in which unit will face West if on left end of top, and East if on right end of top. Note: For Connexus™ locations other than those shown below, contact Customer Service for upcharge.

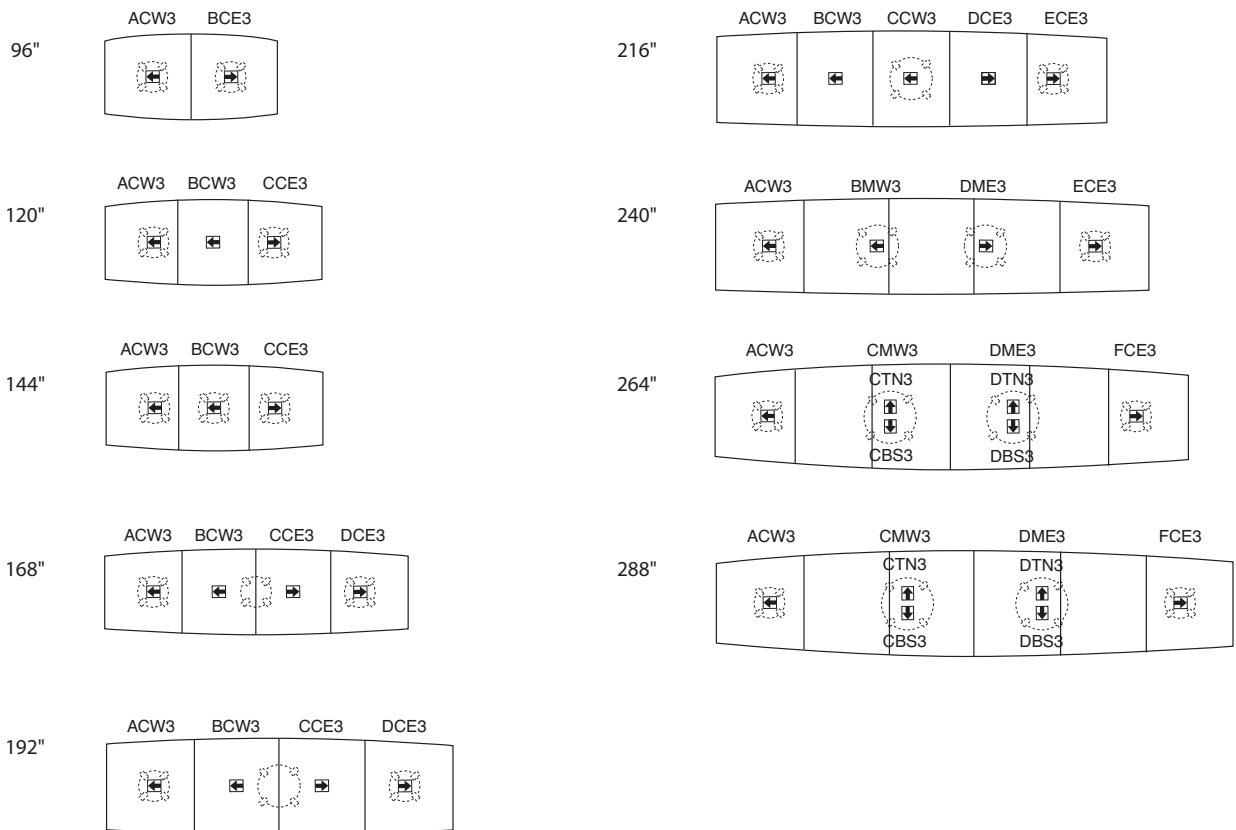

← → REPRESENTS MODULES THAT WHEN OPENED FACE THE ENDS OF THE TABLE

↓ ↑ REPRESENTS MODULES THAT WHEN OPENED FACE THE SIDES OF THE TABLE

VIRTU | CONNEXUS™ LOCATIONS CHARTS

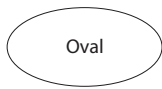

Oval

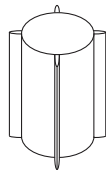

Dais

The Connexus™ Locations diagrams below show the available Connexus™ locations for only the top and base configurations shown above. **Please note that the maximum allowable Connexus™ modules per top are shown, and tops may be specified with fewer modules.** Each Connexus™ module has a code to represent its location on the table surface. To specify a Connexus™ module in a particular location, please use the code listed above it. Note that Large Connexus™ modules can only be specified on the outside sections of tops. **Connexus™ locations and quantities may be limited if Floor Monuments already exist at installation site. Please see Floor Monuments section for more information. For large Connexus™ units, please replace “3” in location code with “4”.** Codes that appear above table illustrations represent single center locations, in which unit will face West if on left end of top, and East if on right end of top. Note: For Connexus™ locations other than those shown below, contact Customer Service for upcharge.

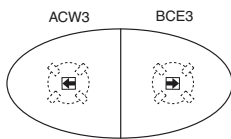

96"

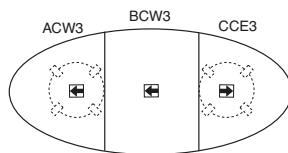

120"

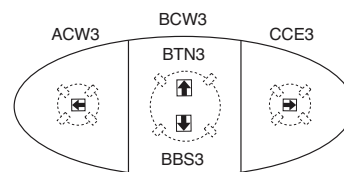

144"



Oval



Forza Leg

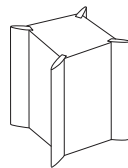

Forza Square

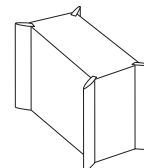

Forza Rectangle

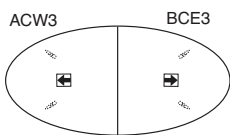

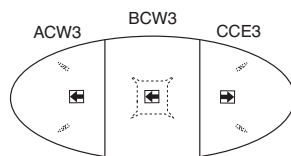

96"



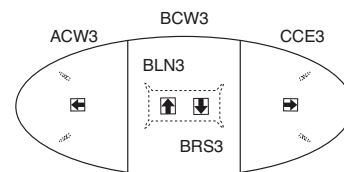

120"



144"

  REPRESENTS MODULES THAT WHEN OPENED FACE THE ENDS OF THE TABLE

  REPRESENTS MODULES THAT WHEN OPENED FACE THE SIDES OF THE TABLE

VIRTU | CONNEXUS™ LOCATIONS CHARTS

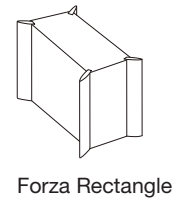
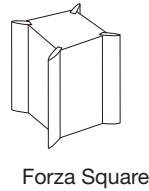
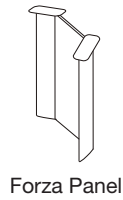
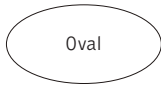

The Connexus™ Locations diagrams below show the available Connexus™ locations for only the top and base configurations shown above. **Please note that the maximum allowable Connexus™ modules per top are shown, and tops may be specified with fewer modules.** Each Connexus™ module has a code to represent its location on the table surface. To specify a Connexus™ module in a particular location, please use the code listed above it. Note that Large Connexus™ modules can only be specified on the outside sections of tops. **Connexus™ locations and quantities may be limited if Floor Monuments already exist at installation site. Please see Floor Monuments section for more information. For large Connexus™ units, please replace “3” in location code with “4”.** Codes that appear above table illustrations represent single center locations, in which unit will face West if on left end of top, and East if on right end of top. Note: For Connexus™ locations other than those shown below, contact Customer Service for upcharge.

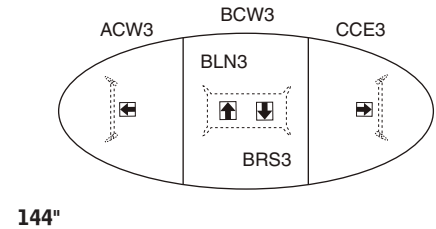
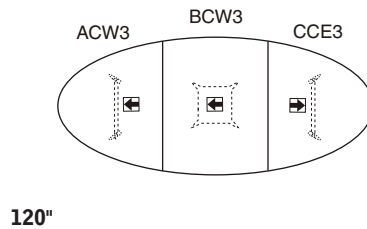
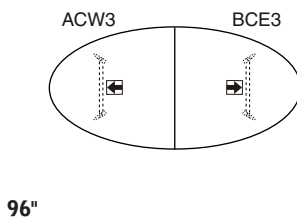

  REPRESENTS MODULES THAT WHEN OPENED FACE THE ENDS OF THE TABLE

  REPRESENTS MODULES THAT WHEN OPENED FACE THE SIDES OF THE TABLE

VIRTU | CONNEXUS™ LOCATIONS CHARTS



Verso

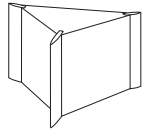

Verso

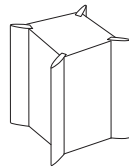

Forza Square

The Connexus™ Locations diagrams below show the available Connexus™ locations for only the top and base configurations shown above. **Please note that the maximum allowable Connexus™ modules per top are shown, and tops may be specified with fewer modules.** Each Connexus™ module has a code to represent its location on the table surface. To specify a Connexus™ module in a particular location, please use the code listed above it. Note that Large Connexus™ modules can only be specified on the outside sections of tops. **Connexus™ locations and quantities may be limited if Floor Monuments already exist at installation site. Please see Floor Monuments section for more information. For large Connexus™ units, please replace “3” in location code with “4”.** Codes that appear above table illustrations represent single center locations, in which unit will face West if on left end of top, and East if on right end of top. Note: For Connexus™ locations other than those shown below, contact Customer Service for upcharge.

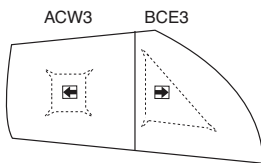

107"

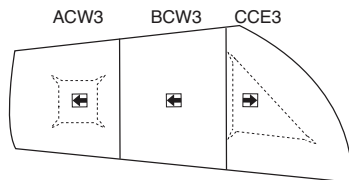

137"

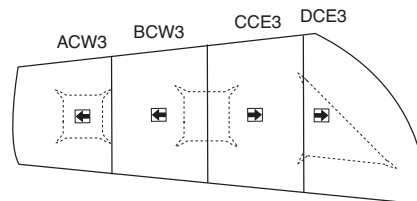

168"



Verso



Forza Leg

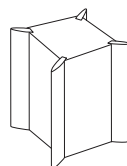

Forza Square

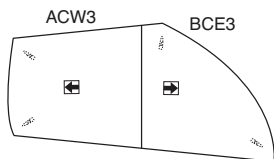

107"

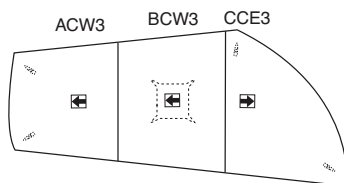

137"

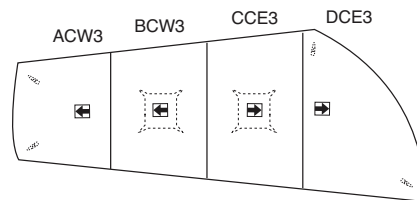

168"



 REPRESENTS MODULES THAT WHEN OPENED FACE THE ENDS OF THE TABLE

 REPRESENTS MODULES THAT WHEN OPENED FACE THE SIDES OF THE TABLE

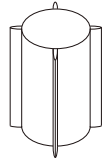
VIRTU | CONNEXUS™ LOCATIONS CHARTS

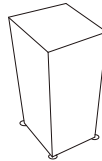

Dais



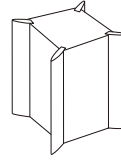

Oblique



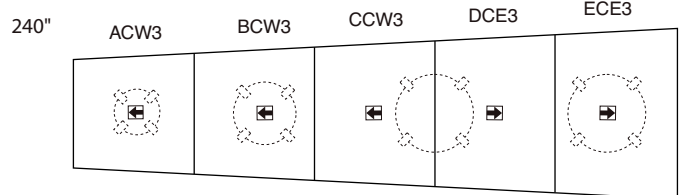
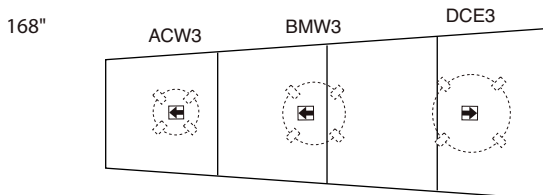
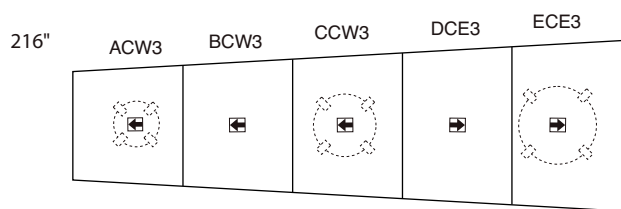
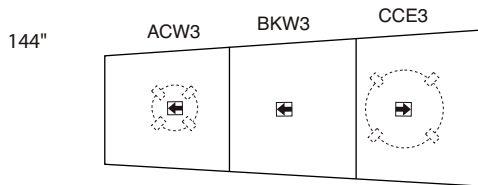
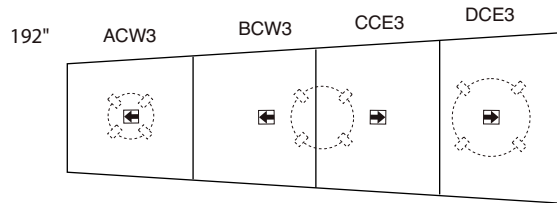
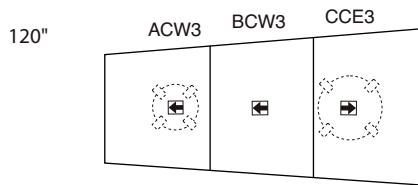

Forza Square

The Connexus™ Locations diagrams below show the available Connexus™ locations for only the top and base configurations shown above. **Please note that the maximum allowable Connexus™ modules per top are shown, and tops may be specified with fewer modules.** Each Connexus™ module has a code to represent its location on the table surface. To specify a Connexus™ module in a particular location, please use the code listed above it. Note that Large Connexus™ modules can only be specified on the outside sections of tops. **Connexus™ locations and quantities may be limited if Floor Monuments already exist at installation site. Please see Floor Monuments section for more information. For large Connexus™ units, please replace “3” in location code with “4”.** Codes that appear above table illustrations represent single center locations, in which unit will face West if on left end of top, and East if on right end of top. Note: For Connexus™ locations other than those shown below, contact Customer Service for upcharge.





 REPRESENTS MODULES THAT
WHEN OPENED FACE THE ENDS
OF THE TABLE

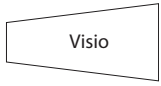

 REPRESENTS MODULES THAT
WHEN OPENED FACE THE SIDES
OF THE TABLE

VIRTU | CONNEXUS™ LOCATIONS CHARTS

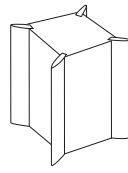

Forza Panel



Forza Square

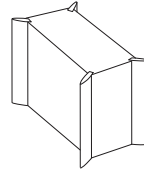

Forza Rectangle

The Connexus™ Locations diagrams below show the available Connexus™ locations for only the top and base configurations shown above. **Please note that the maximum allowable Connexus™ modules per top are shown, and tops may be specified with fewer modules.** Each Connexus™ module has a code to represent its location on the table surface. To specify a Connexus™ module in a particular location, please use the code listed above it. Note that Large Connexus™ modules can only be specified on the outside sections of tops. **Connexus™ locations and quantities may be limited if Floor Monuments already exist at installation site. Please see Floor Monuments section for more information. For large Connexus™ units, please replace “3” in location code with “4”.** Codes that appear above table illustrations represent single center locations, in which unit will face West if on left end of top, and East if on right end of top. Note: For Connexus™ locations other than those shown below, contact Customer Service for upcharge.

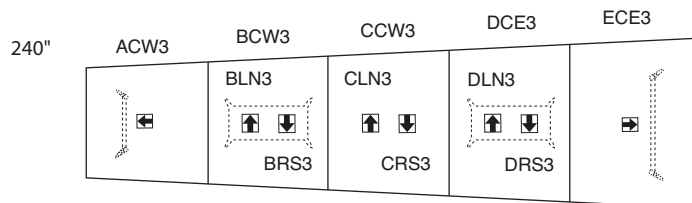
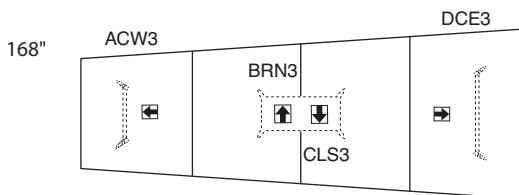
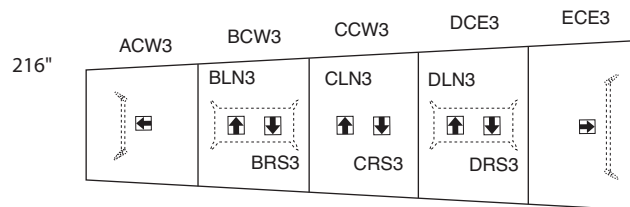
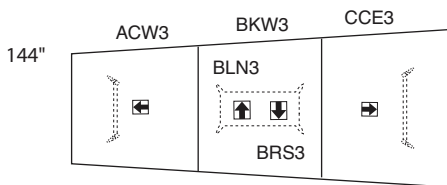
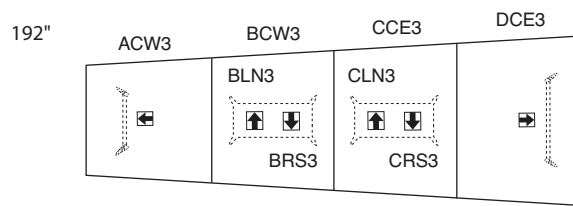
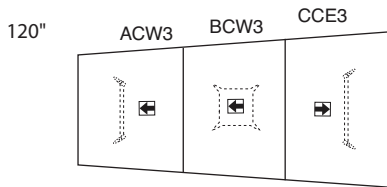

REPRESENTS MODULES THAT WHEN OPENED FACE THE ENDS OF THE TABLE

REPRESENTS MODULES THAT WHEN OPENED FACE THE SIDES OF THE TABLE

VIRTU | CONNEXUS™ | LOCATIONS CHARTS

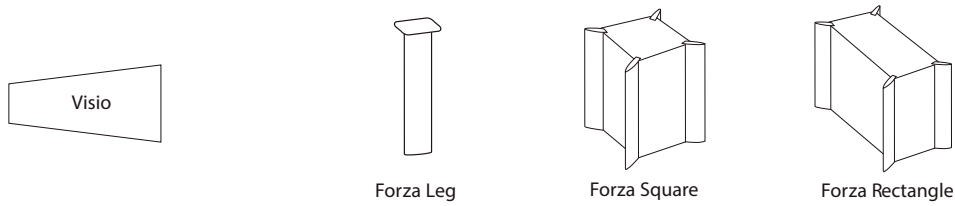

The Connexus™ Locations diagrams below show the available Connexus™ locations for only the top and base configurations shown above. **Please note that the maximum allowable Connexus™ modules per top are shown, and tops may be specified with fewer modules.** Each Connexus™ module has a code to represent its location on the table surface. To specify a Connexus™ module in a particular location, please use the code listed above it. Note that Large Connexus™ modules can only be specified on the outside sections of tops. **Connexus™ locations and quantities may be limited if Floor Monuments already exist at installation site. Please see Floor Monuments section for more information. For large Connexus™ units, please replace “3” in location code with “4”.** Codes that appear above table illustrations represent single center locations, in which unit will face West if on left end of top, and East if on right end of top. Note: For Connexus™ locations other than those shown below, contact Customer Service for upcharge.

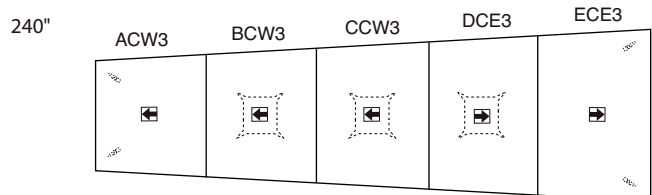
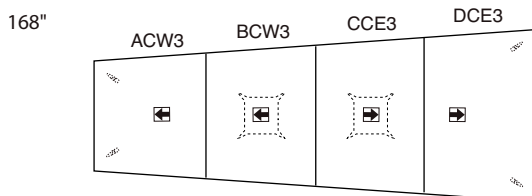
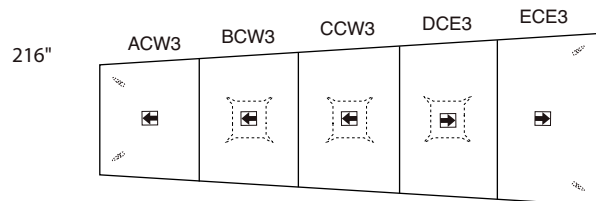
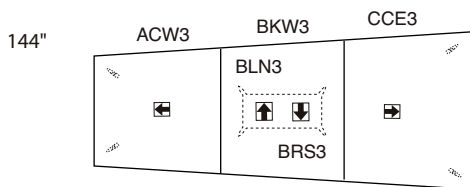
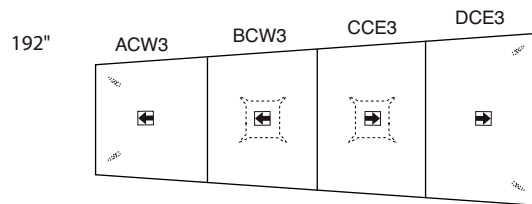
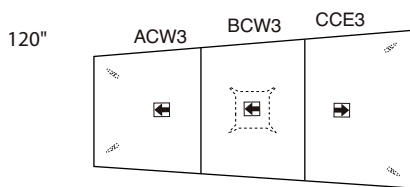

REPRESENTS MODULES THAT WHEN OPENED FACE THE ENDS OF THE TABLE

REPRESENTS MODULES THAT WHEN OPENED FACE THE SIDES OF THE TABLE

VIRTU | CONNEXUS™ LOCATIONS CHARTS

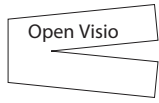

Forza

The Connexus™ Locations diagrams below show the available Connexus™ locations for only the top and base configurations shown above. **Please note that the maximum allowable Connexus™ modules per top are shown, and tops may be specified with fewer modules.** Each Connexus™ module has a code to represent its location on the table surface. To specify a Connexus™ module in a particular location, please use the code listed above it. Note that Large Connexus™ modules can only be specified on the outside sections of tops. **Connexus™ locations and quantities may be limited if Floor Monuments already exist at installation site. Please see Floor Monuments section for more information. For large Connexus™ units, please replace “3” in location code with “4”.** Codes that appear above table illustrations represent single center locations, in which unit will face West if on left end of top, and East if on right end of top. Note: For Connexus™ locations other than those shown below, contact Customer Service for upcharge.

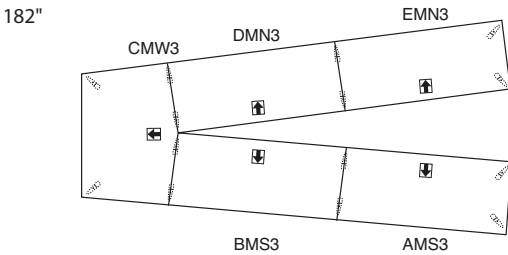
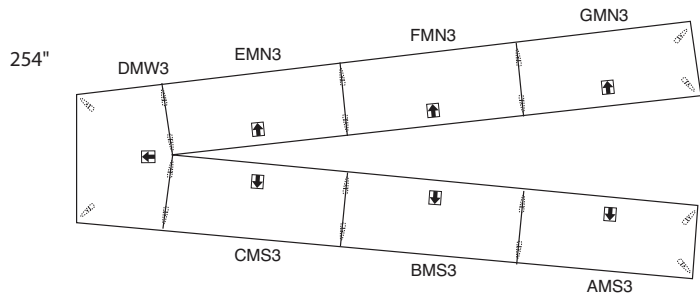
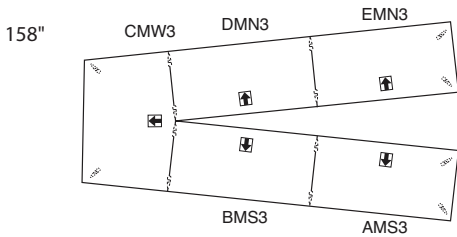
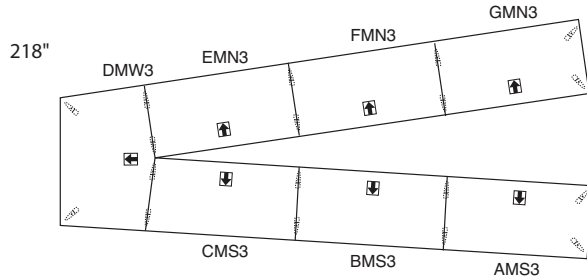
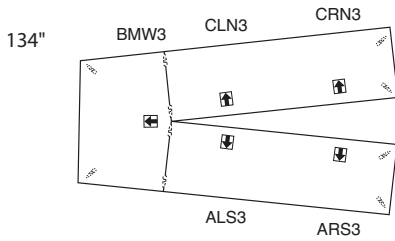

REPRESENTS MODULES THAT WHEN OPENED FACE THE ENDS OF THE TABLE



REPRESENTS MODULES THAT WHEN OPENED FACE THE SIDES OF THE TABLE

VIRTU | CONNEXUS™ | LOCATIONS CHARTS

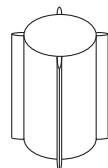
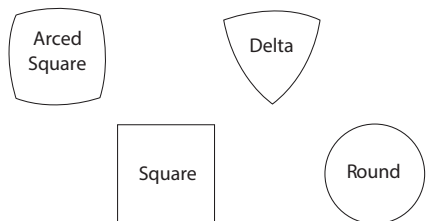

Dais



Forza Leg

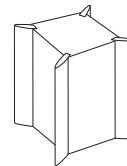

Forza Square

The Connexus™ Location , “C”, is the only code required when specifying a Connexus™ module on a Round, Square, Arced Square or Delta table. For large Connexus™ units, please replace “3” in location code with “4”. Codes that appear above table illustrations represent single center locations, in which unit will face West if on left end of top, and East if on right end of top. Note: For Connexus™ locations other than those shown below, contact Customer Service for upcharge.

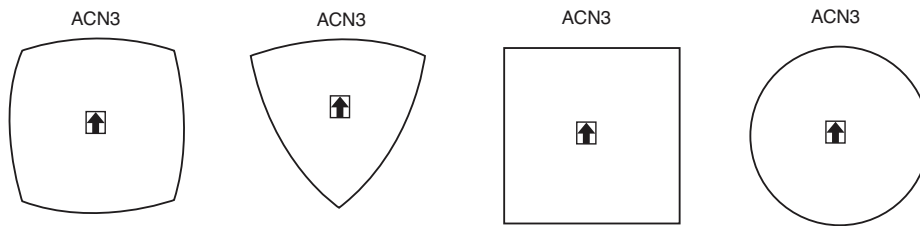

Note: It is recommended that Connexus™ Modules not be specified on 36" and 42" Delta tops and 42" Arced Square, Round and Square tops when used in conjunction with Forza Leg bases due to leg room constraints.

 REPRESENTS MODULES THAT WHEN OPENED FACE THE SIDES OF THE TABLE

VIRTU | FLOOR MONUMENT LOCATIONS

FLOOR MONUMENT LOCATIONS

All VIRTU table bases and casegoods designed for use with office equipment provide wire management with easy door access to floor and wall monuments. This allows for change and updating of wiring throughout the product without having to take furniture apart and re-install it. We've provided in this guide helpful information on the optimum locations of floor monuments in relation to the table base locations, so that you can position each appropriately. Follow the New Monument Locations guidelines to determine these positions. We've also given you steps for determining what locations and quantities of Connexus™ modules are available if floor monuments already exist at the installation site. Follow the Existing Monument Locations guidelines if this applies.

NEW MONUMENT LOCATIONS

Steps to Determine Recommended Floor Monument Location Codes for Tables

1. In the "Chart A" section, locate the page which represents the Base(s) and Top Shape for your table, which are listed at the top of each page.
2. Locate your "Top Size" and "Top Shape" from the chart on that page.
3. On the left, you will see a diagram with "Codes" indicated for Recommended Monument Locations.
4. Select the Code(s) for your preferred Monument Location(s) and note for ordering purposes.

Note: Some restrictions apply in selecting Monument Locations, due to pre-determined electrical cord lengths. See Electrical Cord Lengths details.

Steps to Determine Recommended Monument Location Measurements

1. In the "Chart B" section, locate the page which represents the Bases(s) and Top Shape for your table, which are located at the top of each chart.
2. Locate your "Top Size".
3. Cross reference your table size with the "Codes" that you have selected for your table.

Note: The measurements listed represent the distance in inches that a particular "Code" is from the left edge of your table. The shaded columns, ML and MR, represent the distance in inches that a particular "Code" is from the center line (lengthwise) of the table.

EXISTING MONUMENT LOCATIONS

If your VIRTU Conference Table is to be installed in a room with existing floor monuments, please use the following steps to determine the available location(s) and quantity of Connexus™ modules.

1. Create an overhead view of the room in which your conference table is to be located, including measurements of floor space.
2. Sketch in an outline of your conference table in the position you would like it to be located in the room.
3. Measure the exact positions of the existing floor monuments in relation to the perimeter of your conference table.
4. Follow the steps outlined in Electrical Cord Lengths to determine the available locations(s) and quantity of Connexus™ modules.
5. Submit the overhead view of the room with your purchase order so that Krug can provide the proper electrical cord lengths with your order.

It is recommended that a flush floor mounted monument is specified to best facilitate access into all VIRTU bases. Monument locations listed within "Chart B" provide dimensional information as it relates to the position of the monuments and bases. Enclosed bases have been designed to be placed over top of the monument, while tables supported with Forza Leg and Forza Panel bases have the monuments located offset to the leg. Please note that the measurements listed are the optimum location for Floor Monuments so that wiring does not interfere with the users. The monument will require a minimum of one dedicated receptacle and provision for communication wire passage as well. Monuments with combined electrical capabilities will restrict the number of communication cables for use. For situations requiring large amounts of communication wiring, we highly recommend entering the table through another base from a monument designed for communication wires only. The Floor Monument charts and diagrams are also designed to help determine the proper cord length designations. In order for Krug to supply the proper length of electrical cords for VIRTU Conference tops specified with Connexus™ modules, the user must specify Monument Location Codes which can be found in these drawings. If floor monuments already exist, please provide an overhead room layout, with exact measurements of your conference table and monuments positions, as outlined in Existing Monument Locations.

ELECTRICAL CORD LENGTHS

Connexus™ Modules come with pre-determined electrical cord lengths that are suited to the size and configuration of each table. Each will plug into a standard floor monument power source. However, in situations where a table length exceeds our maximum cord length, a second power entry is necessary to avoid daisy-chaining of electrical power. To determine when a second power entry is required please follow these steps.

1. Select your Connexus™ Location(s).
2. Select your Floor Monument Location(s) if they do not already exist in the room.
3. If the number of Connexus™ Modules exceed three consecutive positions left or right of the power entry, then an additional power entry will be required. Refer to the Connexus™ Diagrams that illustrate the base and tabletop combination of your selection.

Note: Connexus™ Modules in pairs count as one position.

* Open Visio tables require 2 power sources, one per wing, or a single power source located at the apex of the two tables.

Example 1

If the designated Floor Monument location for the table scenario shown below is 1L, the user would be able to power-up any or all of the following Connexus™ locations: ACW3, BCW3 and CCW3.

Example 2

If the designated Floor Monument location for the table scenario shown below is 2R, the user would be able to power-up any or all of the following Connexus™ locations: CCW3, DCE3, ECE3 and FCE3.

Monument Location Scenario



Connexus™ Location Scenario

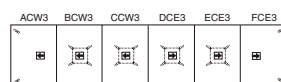





1L 2L 3L 3R 2R 1R
ACW3 BCW3 CCW3 DCE3 ECE3 FCE3

VIRTU | RECOMMENDED FLOOR MONUMENT LOCATIONS

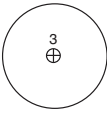
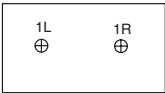
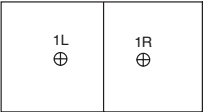
Chart A

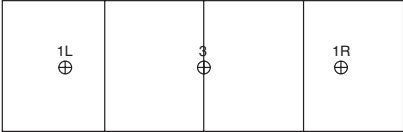
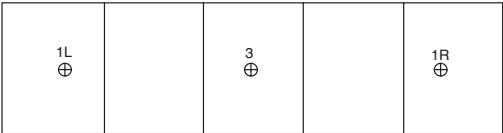
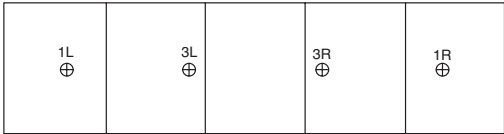
Top Shapes:	<ul style="list-style-type: none"> • Rectangle • Boat • Square 	<ul style="list-style-type: none"> • Arced Rectangle • Round • Arced Square 	<ul style="list-style-type: none"> • Racetrack • Delta
Bases:	<ul style="list-style-type: none"> • Dais 	<ul style="list-style-type: none"> • Forza Square 	<ul style="list-style-type: none"> • Oblique

CODES	TOP SIZE	TOP SHAPES
		Round, Delta, Square, Arced Square
	72-36 84-42	Rectangle, Arced Rectangle, Racetrack
	96-42 96-48-42 96-48	Rectangle, Arced Rectangle, Racetrack, Boat
	120-48 20-48-42 120-54 144-54	Rectangle, Arced Rectangle, Racetrack, Boat
	144-48-42 168-42-42 168-54 192-54 192-54-48	Rectangle, Arced Rectangle, Racetrack, Boat
	216-54-48 216-60	Rectangle, Arced Rectangle, Racetrack, Boat
	240-54-48 240-60	Rectangle, Arced Rectangle, Racetrack, Boat
	264-60 264-60-48 288-60 288-60-48	Rectangle, Arced Rectangle, Racetrack, Boat

VIRTU | RECOMMENDED FLOOR MONUMENT LOCATIONS

Chart A

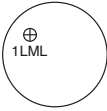
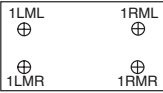
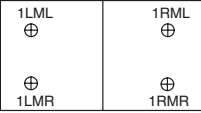
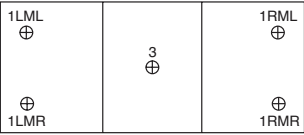
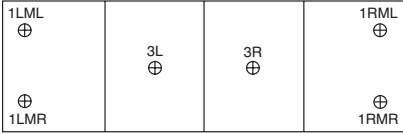
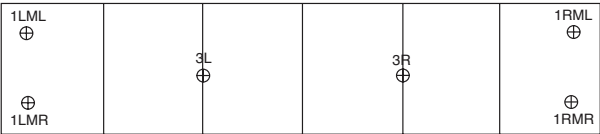
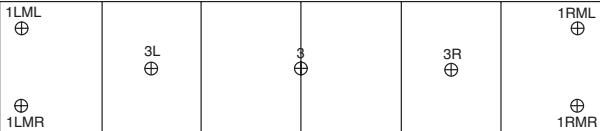

Top Shapes:	<ul style="list-style-type: none"> • Rectangle • Boat • Square 	<ul style="list-style-type: none"> • Arced Rectangle • Round • Arced Square 	<ul style="list-style-type: none"> • Racetrack • Delta
Bases:	<ul style="list-style-type: none"> • Forza Leg 	<ul style="list-style-type: none"> • Forza Leg with Forza Square 	<ul style="list-style-type: none"> • Forza Leg with Forza Rectangle

CODES	TOP SIZE	TOP SHAPES
		Round, Delta, Square, Arced Square
	72-36 84-42	Rectangle, Arced Rectangle, Racetrack
	72-36 84-42 96-42 96-48 96-48-42	Rectangle, Arced Rectangle, Racetrack, Boat
	120-48 120-48-42 120-54 144-48-42 144-54	Rectangle, Arced Rectangle, Racetrack, Boat
	168-48-42 168-54 192-54 192-54-48	Rectangle, Arced Rectangle, Racetrack, Boat
	216-54-48 16-60 240-54-48 240-60	Rectangle, Arced Rectangle, Racetrack, Boat
	264-60 64-60-48 288-60 288-60-48	Rectangle, Arced Rectangle, Racetrack, Boat

VIRTU | RECOMMENDED FLOOR MONUMENT LOCATIONS

Chart A

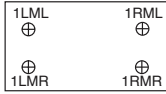
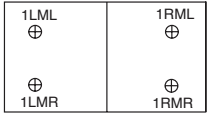
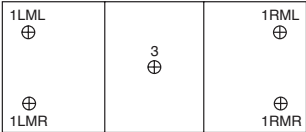
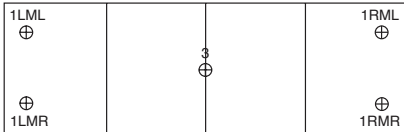
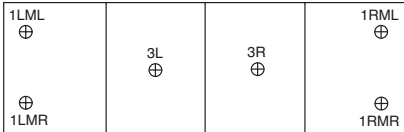
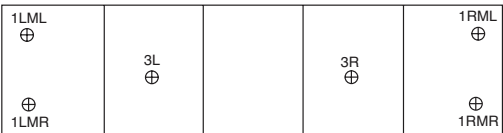
Top Shapes:	• Rectangle	• Arced Rectangle	• Racetrack	• Boat
Bases:	• Forza Panel	• Forza Panel with Forza Square	• Forza Panel with Forza Rectangle	

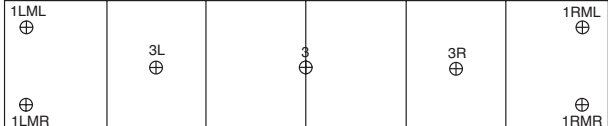
CODES	TOP SIZE	TOP SHAPES
	72-36 84-42	Rectangle, Arced Rectangle, Racetrack
	96-42 96-48-42 96-48	Rectangle, Arced Rectangle, Racetrack, Boat
	120-48 120-48-42 120-54 144-48-42 144-54	Rectangle, Arced Rectangle, Racetrack, Boat
	168-48-42 168-54	Rectangle, Arced Rectangle, Racetrack, Boat
	192-54 192-54-48	Rectangle, Arced Rectangle, Racetrack, Boat
	216-54-48 216-60 240-54-48 240-60	Rectangle, Arced Rectangle, Racetrack, Boat
	264-60 264-60-48	Rectangle, Arced Rectangle, Racetrack, Boat
	288-60 88-60-48	Rectangle, Arced Rectangle, Racetrack, Boat

VIRTU | RECOMMENDED FLOOR MONUMENT LOCATIONS

Chart A

Top Shapes: • Oval

Bases: • Dais

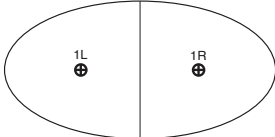
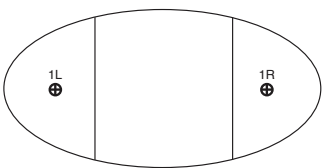
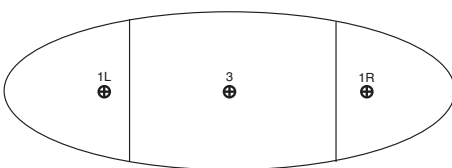
CODES	TOP SIZE
	96-48
	120-54
	

Top Shape: • Oval

Bases:

- Forza Leg
- Forza Panel with Forza Square

- Forza Leg with Forza Square
- Forza Panel

- Forza Leg with Forza Rectangle
- Forza Panel with Forza Rectangle

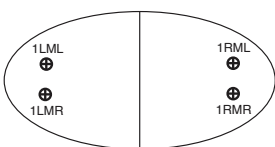
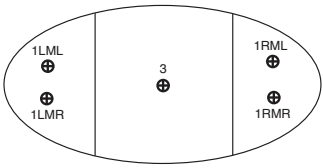
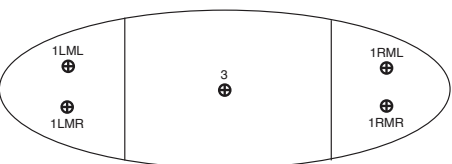
CODES	TOP SIZE
	96-48
	120-54
	144-60

VIRTU | RECOMMENDED FLOOR MONUMENT LOCATIONS

Chart A

Top Shapes: • Verso

Bases: • Forza Square • Verso

CODES

TOP SIZE

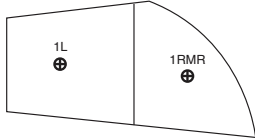

107-57-40

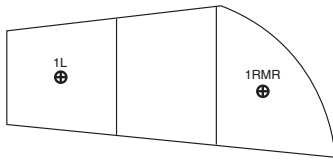

137-63-40

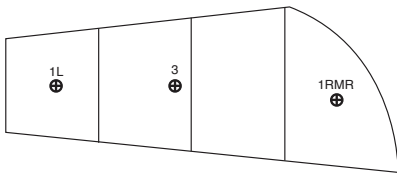

167-70-40

Top Shapes: • Verso

Bases: • Forza Leg • Forza Leg with Forza Square

CODES

TOP SIZE

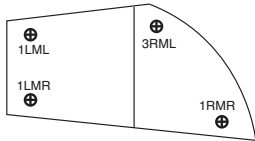

107-57-40

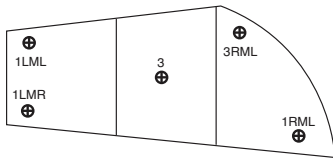

137-63-40

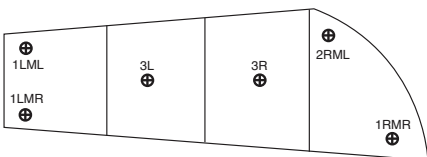

167-70-40

VIRTU | RECOMMENDED FLOOR MONUMENT LOCATIONS

Chart A

Top Shapes: • Visio

Bases: • Forza Square • Dais
• Oblique

CODES

TOP SIZE

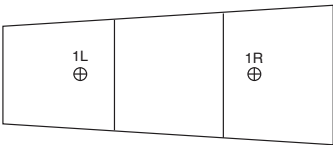

120-60-42
144-60-42

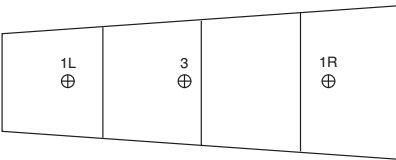

168-60-42

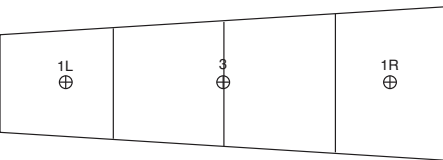

192-66-42

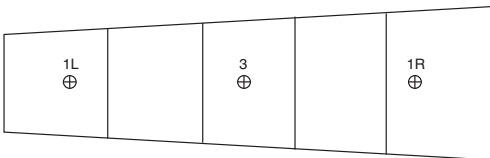

216-73-42

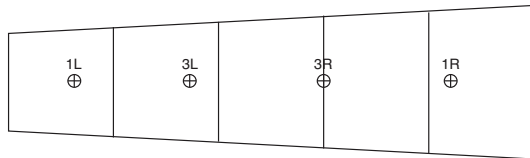

240-76-42

VIRTU | RECOMMENDED FLOOR MONUMENT LOCATIONS

Chart A

Top Shapes: • Visio

Bases: • Forza Leg with Forza Square • Forza Leg with Forza Rectangle
 • Forza Panel with Forza Square • Forza Panel with Rectangle

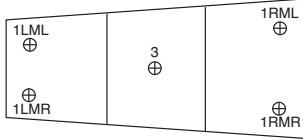
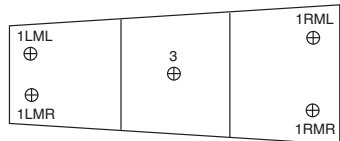
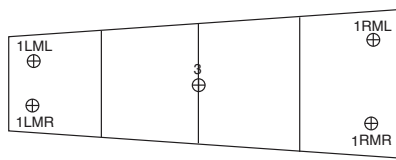
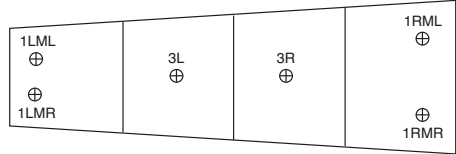
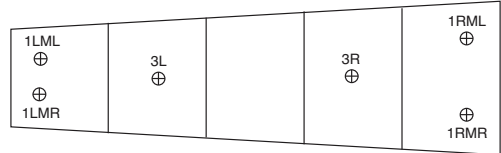
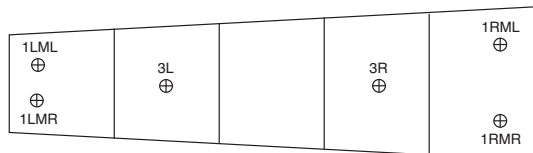
CODES	TOP SIZE
	120-60-42
	144-60-42
	168-60-42
	192-69-42
	216-73-42
	240-76-42

VIRTU | RECOMMENDED FLOOR MONUMENT LOCATIONS

Chart A

Top Shapes: • Open Visio

Bases: • Forza Leg

CODES

TOP SIZE

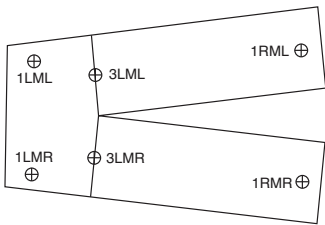

134-80-52
134-92-64

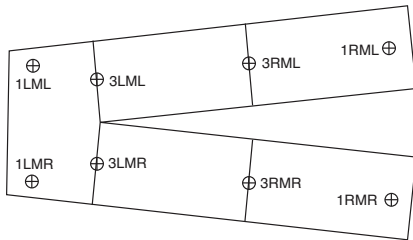

158-85-52
158-96-64
182-90-52
182-102-64

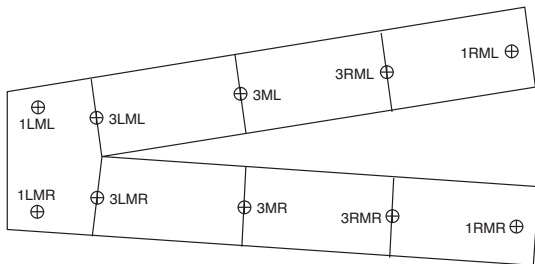

218-97-52
218-109-64
254-105-52
254-117-64

VIRTU | RECOMMENDED FLOOR MONUMENT LOCATIONS

Chart B

Top Shapes:	<ul style="list-style-type: none"> • Rectangle • Delta 	<ul style="list-style-type: none"> • Arced Rectangle • Square 	<ul style="list-style-type: none"> • Racetrack • Arced Square 	<ul style="list-style-type: none"> • Boat • Round
Bases:	<ul style="list-style-type: none"> • Dais 	<ul style="list-style-type: none"> • Forza Square 	<ul style="list-style-type: none"> • Oblique 	

Indicates distance in inches from the left end of table to center of monument

Indicates distance in inches from center line (*lengthwise*) of table to center of monument

	CODES									
	1L	2L	3L	3	3R	2R	1R	ML	MR	
42 dia				21						
42-42 square				21						
42-42 arched square				21						
42 delta				18						
48 dia				24						
48-48 square				24						
48-48 arched square				21						
48 delta										
54 dia				21						
54-54 square				21						
54-54 arched square				21						
54 delta				18						
60 dia				21						
60-60 square				21						
60-60 arched square				21						
60 delta				18						
72-36	18						54			
84-42	24						59			
96-42	26						70			
96-48	26						70			
96-48-42	26						70			
120-48	27						93			
120-48-42	27						93			
120-54	27						93			
144-54	27						117			
144-48-42	27			72			117			
168-54	27			84			141			
168-48-42	27			84			141			
192-54	27			96			165			
192-54-48	27			96			165			
216-54-48	29			108			186			
216-60	29			108			186			
240-54-48	30		90		150		210			
240-60	30		90		150		210			
264-60	30		98		166		234			
264-60-48	30		98		166		234			
288-60	30		107		181		258			
288-60-48	30		107		181		258			

VIRTU | RECOMMENDED FLOOR MONUMENT LOCATIONS

Chart B

Top Shapes: • Rectangle • Arced Rectangle • Racetrack • Boat
 • Delta • Square • Arced Square • Round

Bases: • Dais • Forza Square • Oblique

Indicates distance in inches from the left end of table to center of monument

Indicates distance in inches from center line (*lengthwise*) of table to center of monument

	CODES								
	1L	2L	3L	3	3R	2R	1R	ML	MR
42 dia.	13								
42-42 square	12							12	
42-42 arched square	13							13	
42 delta	14								
48 dia.	13								
48-48 square	12							12	
48-48 arched square	13							13	
48 delta	14								
54 dia.	13								
54-54 square	12							12	
54-54 arched square	13							13	
54 delta	14								
60 dia.	13								
60-60 square	12							12	
60-60 arched square	13							13	
60 delta	14								
72-36	12						59	8	8
84-42	12						71	11	11
96-42	12						83	11	11
96-48	12						83	13	13
120-48	12			60			107	13	13
120-54	12			60			107	17	17
144-54	12			72			131	17	17
168-54	12		63		105		155	17	17
192-54	12		72		120		179	17	17
216-60	12		65	108	151		203	20	20
240-60	12		72	120	168		227	20	20
264-60	12	67	120		144	197	251	20	20
288-60	12	73	120		168	215	275	20	20

VIRTU | RECOMMENDED FLOOR MONUMENT LOCATIONS

Chart B

Top Shape: • Arched Rectangle

Bases: • Forza Leg with Forza Square • Forza Leg with Forza Rectangle

Indicates distance in inches from the left end of table to center of monument

Indicates distance in inches from center line (*lengthwise*) of table to center of monument

	CODES								
	1L	2L	3L	3	3R	2R	1R	ML	MR
72-36	18						53	8	8
84-42	18						66	11	11
96-42	18						77	11	11
96-48	18						77	13	13
120-48	18			60			101	13	13
120-54	18			60			101	17	17
144-54	18			72			125	17	17
168-54	18		63		105		149	17	17
192-54	18		72		120		173	17	17
216-60	18		65	108	151		197	20	20
240-60	18		73	120	167		221	20	20
264-60	18	67	110		154	197	245	20	20
288-60	18	73	120		168	215	269	20	20

Top Shape: • Boat

Bases: • Forza Leg with Forza Square • Forza Leg with Forza Rectangle

	CODES								
	1L	2L	3L	3	3R	2R	1R	ML	MR
96-48-42	12						83	11	11
120-48-42	12			60			107	11	11
144-48-42	12			72			131	11	11
168-48-42	12		63		105		155	11	11
192-54-48	12		72		120		179	14	14
216-54-48	12		65	108	151		203	14	14
240-54-48	12		73	120	167		227	14	14
264-60-48	12	67	110		154	197	251	14	14
288-60-48	12	73	120		168	215	275	14	14

VIRTU | RECOMMENDED FLOOR MONUMENT LOCATIONS

Chart B

Top Shape: • Arched Rectangle

Bases: • Forza Leg with Forza Square • Forza Leg with Forza Rectangle

Indicates distance in inches from the left end of table to center of monument

Indicates distance in inches from center line (*lengthwise*) of table to center of monument

	CODES								
	1L	2L	3L	3	3R	2R	1R	ML	MR
72-36	17						55	6	6
84-42	17						67	8	8
96-42	17						79	8	8
96-48	19						77	11	11
120-48	19			60			101	11	11
120-54	21			60			99	14	14
144-54	21			72			123	14	14
168-54	21		63		105		147	14	14
192-54	21		72		120		171	14	14
216-60	23		65	108	151		193	17	17
240-60	23		73	120	167		217	17	17
264-60	23	67	110		154	197	241	17	17
288-60	23	73	120		168	215	265	17	17

VIRTU | RECOMMENDED FLOOR MONUMENT LOCATIONS

Chart B

Top Shape:	• Rectangle	• Arched Rectangle	• Racetrack	• Boat
Bases:	• Forza Panel	• Forza Leg with Forza Square	• Forza Leg with Forza Rectangle	

Indicates distance in inches from the left end of table to center of monument

Indicates distance in inches from center line (*lengthwise*) of table to center of monument

	CODES									
	1L	2L	3L	3	3R	2R	1R	ML	MR	
72-36	19						53	7	7	
84-42	19						65	7	7	
96-42	20						76	10	10	
96-48	20						76	10	10	
96-48-42	20						76	10	10	
120-48	20			60			100	10	10	
120-48-42	20			60			100	10	10	
120-54	20			60			100	13	13	
144-54	20			72			123	13	13	
144-48-42	20			72			123	13	13	
168-54	20			84			148	13	13	
168-48-42	20			84			148	13	13	
192-54	20		72		120		172	13	13	
192-54-48	20		72		120		172	13	13	
216-54-48	20		87		129		196	13	13	
216-60	20		65		150		196	13	13	
240-54-48	20		78		162		220	13	13	
240-60	20		78		162		220	13	13	
264-60	20		88		175		244	13	13	
264-60-48	20		88		175		244	13	13	
288-60	20		73	144	215		268	13	13	
288-60-48	20		73	144	215		268	13	13	

VIRTU | RECOMMENDED FLOOR MONUMENT LOCATIONS

Chart B

Top Shape: • Oval

Bases: • Dais

Indicates distance in inches from the left end of table to center of monument

Indicates distance in inches from center line (*lengthwise*) of table to center of monument

	CODES								
	1L	2L	3L	3	3R	2R	1R	ML	MR
96-48	25						70		
120-54	28						92		
144-60	27			72			117		

Top Shape: • Oval

Bases: • Forza Leg
• Forza Leg with Forza Square • Forza Leg with Forza Rectangle

Indicates distance in inches from the left end of table to center of monument

Indicates distance in inches from center line (*lengthwise*) of table to center of monument

	CODES								
	1L	2L	3L	3	3R	2R	1R	ML	MR
96-48	24						71	7	7
120-54	27			60			93	10	10
144-60	26			72			118	10	10

Top Shape: • Oval

Bases: • Forza Panel
• Forza Panel with Forza Square • Forza Panel with Forza Rectangle

Indicates distance in inches from the left end of table to center of monument

Indicates distance in inches from center line (*lengthwise*) of table to center of monument

	CODES								
	1L	2L	3L	3	3R	2R	1R	ML	MR
96-48	24						71	7	7
120-54	27			60			93	10	10
144-60	26			72			118	10	10

VIRTU | RECOMMENDED FLOOR MONUMENT LOCATIONS

Chart B

Top Shape: • Verso

Bases: • Forza Square • Verso

Indicates distance in inches from the left end of table to center of monument

Indicates distance in inches from center line (*lengthwise*) of table to center of monument

	CODES								
	1L	2L	3L	3	3R	2R	1R	ML	MR
107-57-40	26						71		5
137-63-40	27						102		6
167-70-40	27			79			130		8

Top Shape: • Verso

Bases: • Forza Leg • Forza Square

Indicates distance in inches from the left end of table to center of monument

Indicates distance in inches from center line (*lengthwise*) of table to center of monument

	CODES								
	1L	2L	3L	3	3R	2R	1R	ML	MR
107-57-40	14				61		95	10 & 13	10 & 20
137-63-40	14			68	91		125	10 & 16	10 & 23
167-70-40	14		60		98	120	154	10 & 19	10 & 27

VIRTU | RECOMMENDED FLOOR MONUMENT LOCATIONS

Chart B

Top Shape: • Visio

Bases: • Dais • Forza Square • Oblique

Indicates distance in inches from the left end of table to center of monument

Indicates distance in inches from center line (*lengthwise*) of table to center of monument

	CODES								
	1L	2L	3L	3	3R	2R	1R	ML	MR
102-60-42	26						93		
144-60-42	26						114		
168-66-42	26			79			138		
192-66-42	24			96			164		
216-73-42	24			108			188		
240-76-42	24		76		144		212		

Top Shape: • Visio

Bases: • Forza Leg with Forza Square • Forza Leg with Forza Square

Indicates distance in inches from the left end of table to center of monument

Indicates distance in inches from center line (*lengthwise*) of table to center of monument

	CODES								
	1L	2L	3L	3	3R	2R	1R	ML	MR
102-60-42	12			60			107	10	10
144-60-42	12			72			131	10	10
168-66-42	12		63		104		155	10	10
192-66-42	12		72		120		179	10	10
216-73-42	12		65	108	151		203	10	10
240-76-42	12		72	120	168		227	10	10

Top Shape: • Visio

Bases: • Forza Panel with Forza Square • Forza Panel with Forza Square

Indicates distance in inches from the left end of table to center of monument

Indicates distance in inches from center line (*lengthwise*) of table to center of monument

	CODES								
	1L	2L	3L	3	3R	2R	1R	ML	MR
102-60-42	21			60			99	7	7
144-60-42	21			72			122	7	7
168-66-42	21			84			147	7	7
192-66-42	21		72		120		170	7	7
216-73-42	21		65		151		194	7	7
240-76-42	21		72		168		218	7	7

VIRTU | RECOMMENDED FLOOR MONUMENT LOCATIONS

Chart B

Top Shape: • Arched Rectangle

Bases: • Forza Leg with Forza Square • Forza Leg with Forza Rectangle

Indicates distance in inches from the left end of table to center of monument

Indicates distance in inches from center line (*lengthwise*) of table to center of monument

	CODES														
	1L	ML	MR	3L	ML	MR	3	ML	MR	3R	ML	MR	1R	ML	MR
134-80-52 (30-96)	13	17	17	37	15	15							124	24	24
134-92-64 (36-96)	13	23	23	38	18	18							124	27	27
158-85-52 (30-60)	13	17	17	37	15	15				97	21	21	148	27	27
158-96-64 (36-60)	13	23	23	38	18	18				97	24	24	148	30	30
179-90-52 (30-72)	13	17	17	37	15	15				109	22	22	172	29	29
179-102-64 (36-72)	13	23	23	38	18	18				109	25	25	172	32	32
218-97-52 (30-60)	13	17	17	37	15	15	97	21	21	157	27	27	208	33	33
218-109-64 (36-60)	13	23	23	38	18	18	97	24	24	157	30	30	208	36	36
254-105-52 (30-72)	13	17	17	37	15	15	109	22	22	180	30	30	243	37	37
254-117-64 (36-72)	13	23	23	38	18	18	109	25	25	180	33	33	243	40	40

Due to the unique shape of Open Visio tables, this Monument Location Chart differs from the other charts

VIRTU | CONFERENCE TABLE ORDERING CHART SAMPLE

Conference Table Ordering Chart Samples

To assist in the specification of VIRTU conference tables we have provided an ordering chart. Shown first is a completed sample chart. This sample chart shows exactly what information is needed to complete an order. The exception is the Connexus™ and Floor Monument areas, as they are not required if Connexus™ modules are not included in the order. You may photocopy the blank chart on bottom of the page and use it exclusively for ordering VIRTU conference tables, attach the charts to the rest of your order, or simply use the chart as a reference to what information is required to complete your conference table order.

SAMPLE

VIRTU Conferencing Table Configuration

Conference Top Model # Base Model #'s	Base Qty	Price for Top and Base(s)		
6258-167-70-40		\$19,632		
6234-14-14-29	1			
6234-20-20-29	1			
6231-23-24-29	1			
Species		Finish	Edge Profile	Metal Finish
Anigre		Clear	Fino	Satin Aluminum
Connexus™ Location	Connexus™ Model #(s)	Price	Monument Locations	Other
AL	62 CON ED - Alum.	1222	1L	
C	62 CON BD - Alum.	994	1L	
AR	62 CON BD - Alum	994	1R	
			Total List \$	\$22,842

VIRTU Conferencing Table Configuration

Conference Top Model # Base Model #'s	Base Qty	Price for Top and Base(s)		
Species		Finish	Edge Profile	Metal Finish
Connexus™ Location	Connexus™ Model #(s)	Price	Monument Locations	Other
			Total List \$	

VIRTU | DUAL MEDIA CABINETS

Description	Model	Cherry/Maple/ Walnut			W	D	H	Shipping Weight	Cubic Feet
			Anigre						
Dual Media Cabinet full height upper bi-fold wood doors lower hinged wood doors	62MC-75307614	12286	13256	75	30	76	645	116	



ORDERING NOTES

Locks are optional on upper and lower wood doors at a price of **\$152 list** per set of two doors.
Interior dimensions for monitor shelf on this unit are: Width=73 1/4" Depth=27 3/4"
Height with camera shelf=30 3/4" Height without camera shelf=39"

Dual Media Cabinet full height upper bi-fold wood doors lower hinged glass doors	62MC-75307614GW	12912	13910	75	30	76	645	116
---	-----------------	-------	-------	----	----	----	-----	-----



ORDERING NOTES

Locks are optional on upper doors at a price of **\$152 list** per set of two doors.
Interior dimensions for monitor shelf on this unit are: Width=73 1/4" Depth=27 3/4"
Height with camera shelf=30 3/4" Height without camera shelf=39"

Dual Media Cabinet full height open top cabinet lower hinged wood doors	62MC-75307613 Media Cabinet full height	10638	11624	75	30	76	570	116
--	---	-------	-------	----	----	----	-----	-----

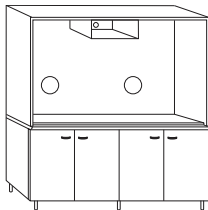

ORDERING NOTES

Locks are optional on lower wood doors at a price of **\$152 list** per set of two doors.
Interior dimensions for monitor shelf on this unit are: Width=73 1/4" Depth=27 3/4"
Height with camera shelf=30 3/4" Height without camera shelf=39"

Dual Media Cabinet full height open top cabinet lower hinged glass doors	62MC-75307613G	11283	12344	75	30	76	570	116
---	----------------	-------	-------	----	----	----	-----	-----

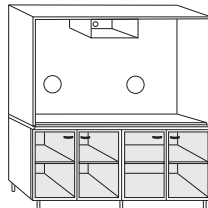

ORDERING NOTES

Interior dimensions for monitor shelf on this unit are: Width=73 1/4" Depth=27 3/4"
Height with camera shelf=30 3/4" Height without camera shelf=39"

ORDERING PROCEDURE

To order, please specify the following:

1. Product model number
2. Wood species and finish
3. Metal finish
4. Special options/features

CODE DESCRIPTION

MC - media cabinet
G - glass doors
W - wood doors

SPECIAL FEATURES

- Dual Media Cabinets will accommodate 2 monitors up to 35" each in width. Please contact Customer Service if dimensions are critical.
- Locks are optional on wood doors at a price of **\$152 list** per lock.
- Casters are optional on Dual Media Cabinets at a price of **\$208 list**.
- Dual Media Cabinets feature removable shelf and grommet for CPU storage.

VIRTU | MEDIA CABINETS

Description	Model	Cherry/Maple/ Walnut			W	D	H	Shipping Weight	Cubic Feet
			Anigre						
Dual Media Cabinet buffet height hinged wood doors	62MC-75303511	6769	7749	75	30	34.5	345	49	

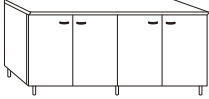

ORDERING NOTES

Locks are optional on wood doors at a price of **\$152 list** per set of two doors.
Casters are optional on Dual Media Cabinets at a price of **\$208 list**.

Dual Media Cabinet buffet height hinged glass doors	62MC-75303511G	7402	8470	75	30	34.5	345	49
---	----------------	------	------	----	----	------	-----	----

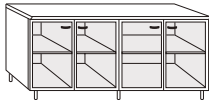

ORDERING NOTES

Casters are optional on Dual Media Cabinets at a price of **\$208 list**.ordering procedure

Large Media Cabinet hinged wood doors lower hinged wood doors (2 Piece Assembly)	62MC-42308514	7072	8088	42	30	85	455	59
---	---------------	------	------	----	----	----	-----	----

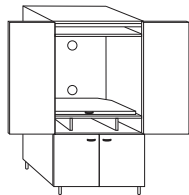

ORDERING NOTES

Upper and lower doors have an optional lock at a price of **\$152 list** per set of two doors.
Interior dimensions for monitor shelf on this unit are:
Width=40 3/16" Depth=28 3/8" Height=33 3/8"
An optional pull-out equipment rack and cable carrier are available on Media Cabinets at a price of **\$3188 list**.

Large Media Cabinet hinged glass doors lower hinged glass doors (2 Piece Assembly)	62MC-42308514GW	7316	8413	42	30	85	455	59
---	-----------------	------	------	----	----	----	-----	----

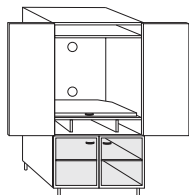

ORDERING NOTES

Upper and lower doors have an optional lock at a price of **\$152 list** per set of two doors.
Interior dimensions for monitor shelf on this unit are:
Width=40 3/16" Depth=28 3/8" Height=33 3/8"
An optional pull-out equipment rack and cable carrier are available on Media Cabinets at a price of **\$3188 list**.

ORDERING PROCEDURE

To order, please specify the following:

1. Product model number
2. Wood species and finish
3. Metal finish
4. Special options/features

CODE DESCRIPTION

MC - media cabinet
G - glass doors

SPECIAL FEATURES

- Dual Media Cabinets will accommodate 2 monitors up to 35" each in width. Please contact Customer Service if dimensions are critical
- Locks are optional on wood doors at a price of **\$152 list** per lock mechanism.
- Bookmatched Birdseye Maple veneer is available on work surfaces of VIRTU cases at an upcharge of **\$76 list** per square foot.

VIRTU | LARGE MEDIA CABINETS

Description	Model	Cherry/Maple/ Walnut			W	D	H	Shipping Weight	Cubic Feet
		Walnut	Anigre						
Large Media Cabinet hinged glass doors lower hinged wood doors (2 Piece Assembly)	62MC-42308514WG	8093	9200		42	30	85	455	59

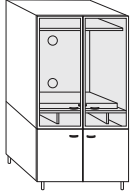

Large Media Cabinet hinged glass doors lower hinged glass doors (2 Piece Assembly)	62MC-42308514G	8491	9593		42	30	85	455	59
---	----------------	------	------	--	----	----	----	-----	----

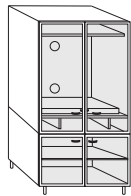

ORDERING NOTES

Interior dimensions for monitor shelf on this unit are:

Width=40 3/16" Depth=28 3/8" Height=33 3/8"

An optional pull-out equipment rack and cable carrier are available on Media Cabinets at a price of **\$3188 list**.

Large Media Cabinet gabled top hinged wood doors lower hinged wood doors (2 Piece Assembly)	.62MC-42308514A	7190	8265		42	30	85	455	61
---	-----------------	------	------	--	----	----	----	-----	----

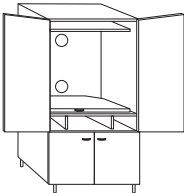

ORDERING NOTES

For security reasons, upper doors have an optional lock at a price of **\$152 list**.

Interior dimensions for monitor shelf on this unit are:

Width=40 3/16" Depth=28 3/8" Height=33 3/8"

An optional pull-out equipment rack and cable carrier are available on Media Cabinets at a price of **\$3188 list**.

Large Media Cabinet gabled top hinged wood doors lower hinged wood doors (2 Piece Assembly)	62MC-42308514GWA	7435	8549		42	30	85	455	61
---	------------------	------	------	--	----	----	----	-----	----

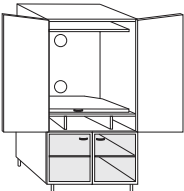

ORDERING NOTES

For security reasons, upper doors have an optional lock at a price of **\$152 list**.

Interior dimensions for monitor shelf on this unit are:

Width=40 3/16" Depth=28 3/8" Height=33 3/8"

An optional pull-out equipment rack and cable carrier are available on Media Cabinets at a price of **\$3188 list**.

ORDERING PROCEDURE

To order, please specify the following:

1. Product model number
2. Wood species and finish
3. Metal finish
4. Special options/features

CODE DESCRIPTION

MC - media cabinet
G - glass doors

SPECIAL FEATURES

- Large Media Cabinets will accommodate monitors up to 35" in width. Please contact Customer Service if dimensions are critical.
- Locks are optional on wood doors at a price of **\$152 list** per lock mechanism.
- Media Cabinets with hinged or pocket doors come equipped with a pullout swivel shelf (which accommodates up to 250 lbs.).

VIRTU | LARGE MEDIA CABINETS

Description	Model	Cherry/Maple/ Walnut			W	D	H	Shipping Weight	Cubic Feet
		Walnut	Anigre						
Large Media Cabinet wood pocket doors wood lower hinged doors (2 Piece Assembly)	62MC-42308502	8390	9650		42	30	85	455	59

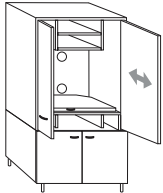

ORDERING NOTES

For security reasons, upper pocket doors have an optional lock at a price of **\$152 list**.
Lower doors feature an optional lock at a price of **\$152 list**.
Interior dimensions for monitor shelf on this unit are:
Width=36 15/16" Depth=28 7/16" Height=30 3/8"

Large Media Cabinet wood pocket doors glass lower hinged doors (2 Piece Assembly)	62MC-42308502GW	8628	9919		42	30	85	455	59
--	-----------------	------	------	--	----	----	----	-----	----

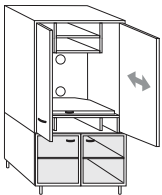

ORDERING NOTES

For security reasons, upper pocket doors have an optional lock at a price of **\$152 list**.
Interior dimensions for monitor shelf on this unit are:
Width=36 15/16" Depth=28 7/16" Height=30 3/8"

Large Media Cabinet glass pocket doors wood lower hinged doors (2 Piece Assembly)	62MC-42308502WG	9312	10806		42	30	85	455	59
--	-----------------	------	-------	--	----	----	----	-----	----

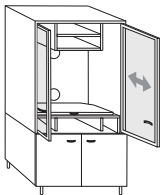

ORDERING NOTES

For security reasons, lower doors have an optional lock at a price of **\$152 list**.
Interior dimensions for monitor shelf on this unit are:
Width=36 15/16" Depth=28 7/16" Height=30 3/8"
Locks are optional on wood doors at a price of **\$152 list** per lock mechanism.

Large Media Cabinet glass pocket doors glass lower hinged doors (2 Piece Assembly)	62MC-42308502G	9556	10987		42	30	85	455	59
---	----------------	------	-------	--	----	----	----	-----	----

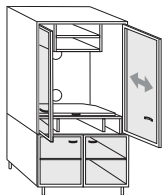

ORDERING NOTES

Interior dimensions for monitor shelf on this unit are:
Width=36 15/16" Depth=28 7/16" Height=30 3/8"
Locks are optional on wood doors at a price of **\$152 list** per lock mechanism.

ORDERING PROCEDURE

To order, please specify the following:

1. Product model number
2. Wood species and finish
3. Metal finish
4. Special options/features

CODE DESCRIPTION

MC - media cabinet
G - glass doors
W - wood doors
A - gabled doors

SPECIAL FEATURES

- Large Media Cabinets will accommodate monitors up to 35" in width. Please contact Customer Service if dimensions are critical.
- Locks are optional on wood doors at a price of **\$152 list** per lock mechanism.
- Media Cabinets with hinged or pocket doors come equipped with a pullout swivel shelf (which accommodates up to 250 lbs.).

Description	Model	Cherry/Maple/ Walnut	Anigre	W	D	H	Shipping Weight	Cubic Feet
Large Media Cabinet open monitor shelf (2 Piece Assembly)	62MC-42308517	6767	7784	42	30	85	440	59

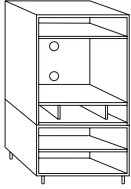

ORDERING NOTES

Interior dimensions for monitor shelf on this unit are:
 Width=40 3/16" Depth=28 5/16" Height=35 7/16"
 Locks are optional on wood doors at a price of **\$152 list** per lock mechanism.
 An optional pull-out equipment rack and cable carrier are available on Media Cabinets at a price of \$3188 list.

Large Media Cabinet open monitor shelf lower hinged wood doors (2 Piece Assembly)	62MC-42308507	6923	7963	42	30	85	445	59
--	---------------	------	------	----	----	----	-----	----

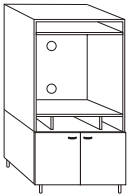

ORDERING NOTES

For security reasons, lower hinged doors have an optional lock at a price of **\$152 list**.
 Interior dimensions for monitor shelf on this unit are:
 Width=40 3/16" Depth=28 5/16" Height=35 7/16"
 An optional pull-out equipment rack and cable carrier are available on Media Cabinets at a price of \$3188 list.

Large Media Cabinet open monitor shelf lower hinged glass doors (2 Piece Assembly)	62MC-42308507G	7130	8198	42	30	85	445	59
---	----------------	------	------	----	----	----	-----	----

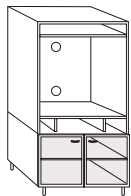

ORDERING NOTES

Interior dimensions for monitor shelf on this unit are:
 Width=40 3/16" Depth=28 5/16" Height=35 7/16"
 An optional pull-out equipment rack and cable carrier are available on Media Cabinets at a price of \$3188 list.

Small Media Cabinet hinged wood doors lower hinged doors - wood (casters optional)	62MC-36247614	5812	6684	36	24	75	235	40
---	---------------	------	------	----	----	----	-----	----

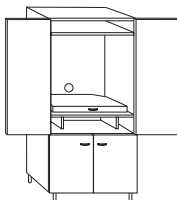

ORDERING NOTES

For security reasons, upper and lower doors have an optional lock at a price of **\$152 list** per set of two doors.
 Interior dimensions for monitor shelf on this unit are:
 Width=34 5/16" Depth=22 15/16" Height=28 9/16"
 Casters are optional on Small Media Cabinets at a price of **\$208 list**.

ORDERING PROCEDURE

To order, please specify the following:

1. Product model number
2. Wood species and finish
3. Metal finish
4. Special options/features

CODE DESCRIPTION

MC - media cabinet
 G - glass doors
 W - wood doors

SPECIAL FEATURES

- Large Media Cabinets will accommodate monitors up to 35" in width. Please contact Customer Service if dimensions are critical.
- Locks are optional on wood doors at a price of **\$152 list** per lock mechanism.
- Media Cabinets with hinged or pocket doors come equipped with a pullout swivel shelf (which accommodates up to 250 lbs.).

VIRTU | MEDIA CABINETS

Description	Model	Cherry/Maple/ Walnut	Anigre	W	D	H	Shipping Weight	Cubic Feet
Small Media Cabinet hinged wood doors glass lower hinged doors	62MC-36247614GW	5979	6873	36	24	75	235	40

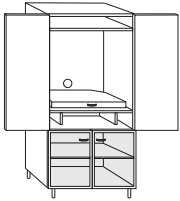

ORDERING NOTES

For security reasons, upper doors have an optional lock at a price of **\$152 list**.
Interior dimensions for monitor shelf on this unit are:
Width=34 5/16" Depth=22 15/16" Height=28 9/16"
Casters are optional on Small Media Cabinets at a price of **\$208 list**.

Small Media Cabinet hinged glass doors wood lower hinged doors (casters optional)	62MC-36247614WG	6188	6988	36	24	75	235	40
--	-----------------	------	------	----	----	----	-----	----

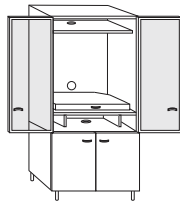

ORDERING NOTES

For security reasons, lower doors have an optional lock at a price of **\$152 list**.
Interior dimensions for monitor shelf on this unit are:
Width=34 5/16" Depth=22 15/16" Height=28 9/16"
Casters are optional on Small Media Cabinets at a price of **\$208 list**.

Small Media Cabinet hinged glass doors glass lower hinged doors (casters optional)	62MC-36247614G	6518	7317	36	24	75	235	40
---	----------------	------	------	----	----	----	-----	----

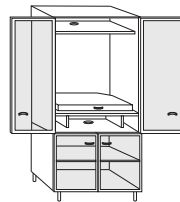

ORDERING NOTES

Interior dimensions for monitor shelf on this unit are:
Width=34 5/16" Depth=22 15/16" Height=28 9/16"

Small Media Cabinet gabled doors hinged wood doors wood lower hinged doors (casters optional)	62MC-36247614A	5714	6568	36	24	75	235	40
---	----------------	------	------	----	----	----	-----	----

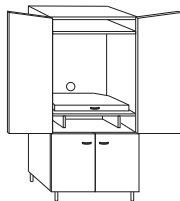

ORDERING NOTES

For security reasons, upper and lower doors have an optional lock at a price of **\$152 list** per set of two doors.
Interior dimensions for monitor shelf on this unit are:
Width=34 5/16" Depth=22 15/16" Height=28 9/16"

ORDERING PROCEDURE

To order, please specify the following:

1. Product model number
2. Wood species and finish
3. Metal finish
4. Special options/features

CODE DESCRIPTION

MC - media cabinet
G - glass doors
W - wood doors
A - gabled doors

SPECIAL FEATURES

- Large Media Cabinets will accommodate monitors up to 35" in width. Please contact Customer Service if dimensions are critical.
- Locks are optional on wood doors at a price of **\$152 list** per lock mechanism.
- Media Cabinets with hinged or pocket doors come equipped with a pullout swivel shelf (which accommodates up to 250 lbs.).

VIRTU | SMALL MEDIA CABINETS

Description	Model	Cherry/Maple/ Walnut			W	D	H	Shipping Weight	Cubic Feet
		Walnut	Anigre						
Small Media Cabinet gabled doors hinged wood doors glass lower hinged doors (casters optional)	62MC-36247614GA	6154	7077		36	24	75	235	40

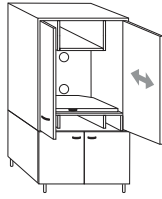

ORDERING NOTES

For security reasons, upper hinged doors have an optional lock at a price of **\$152 list**.

Interior dimensions for monitor shelf on this unit are:

Width=34 5/16" Depth=22 15/16" Height=28 9/16"

Small Media Cabinet wood pocket doors wood lower hinged doors (casters optional)	62MC-36247602	6552	7532		36	24	75	235	40
---	---------------	------	------	--	----	----	----	-----	----

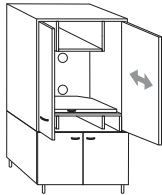

ORDERING NOTES

For security reasons, upper and lower doors have an optional lock at a price of **\$152 list** per set of two doors.

Interior dimensions for monitor shelf on this unit are:

Width=30 15/16" Depth=22 15/16" Height=26"

Small Media Cabinet hinged glass doors glass lower hinged doors (casters optional)	62MC-36247602GW	7037	8092		36	24	75	235	40
---	-----------------	------	------	--	----	----	----	-----	----

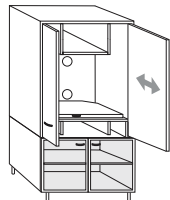

ORDERING NOTES

For security reasons, upper pocket doors have an optional lock at a price of **\$152 list**.

Interior dimensions for monitor shelf on this unit are:

Width=30 15/16" Depth=22 15/16" Height=26"

Small Media Cabinet glass pocket doors wood lower hinged doors (casters optional)	62MC-36247602WG	7417	8543		36	24	75	235	40
--	-----------------	------	------	--	----	----	----	-----	----

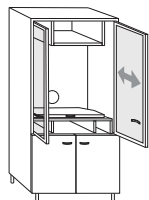

ORDERING NOTES

For security reasons, lower doors have an optional lock at a price of **\$152 list**.

Interior dimensions for monitor shelf on this unit are:

Width=30 15/16" Depth=22 15/16" Height=26"

ORDERING PROCEDURE

To order, please specify the following:

1. Product model number
2. Wood species and finish
3. Metal finish
4. Special options/features

CODE DESCRIPTION

MC - media cabinet
G - glass doors

SPECIAL FEATURES

- Casters are optional on Small Media Cabinets at a price of **\$208 list**.
- Small Media Cabinets are suitable for use with 27" wide monitors. Please contact Customer Service if dimensions are critical.
- Locks are optional on wood doors at a price of **\$152 list** per lock mechanism.
- Media Cabinets with hinged or pocket doors come equipped with a pull-out swivel shelf (which can accommodate up to 250 lbs.).

VIRTU | SMALL MEDIA CABINETS

Description	Model	Cherry/Maple/ Walnut			W	D	H	Shipping Weight	Cubic Feet
		Walnut	Anigre						
Small Media Cabinet glass pocket doors glass lower hinged doors (casters optional)	62MC-36247602G	8307	9508		36	24	75	235	40

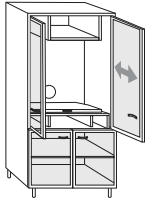

ORDERING NOTES

Interior dimensions for monitor shelf on this unit are:
Width=30 15/16" Depth=22 15/16" Height=26"

Small Media Cabinet Small open shelf (casters optional)	62MC-36247617	5353	6158		36	24	75	225	40
--	---------------	------	------	--	----	----	----	-----	----

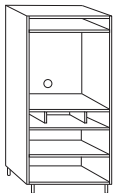

ORDERING NOTES

Interior dimensions for monitor shelf on this unit are:
Width=34 5/16" Depth=22 7/8" Height=30 5/8"

Small Media Cabinet open monitor shelf wood lower hinged doors (casters optional)	62MC-36247607	5562	6397		36	24	75	230	40
--	---------------	------	------	--	----	----	----	-----	----

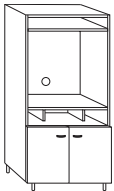

ORDERING NOTES

For security reasons, lower doors have an optional lock at a price of **\$152 list**.
Interior dimensions for monitor shelf on this unit are:
Width=34 5/16" Depth=22 7/8" Height=30 5/8"

Small Media Cabinet open monitor shelf glass lower hinged doors (casters optional)	62MC-36247607G	6008	6909		36	24	75	230	40
---	----------------	------	------	--	----	----	----	-----	----

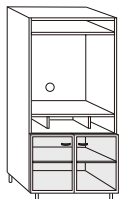

ORDERING NOTES

Interior dimensions for monitor shelf on this unit are:
Width=34 5/16" Depth=22 7/8" Height=30 5/8"

ORDERING PROCEDURE

To order, please specify the following:

1. Product model number
2. Wood species and finish
3. Metal finish
4. Special options/features

CODE DESCRIPTION

MC - media cabinet
G - glass doors
W - wood doors

SPECIAL FEATURES

- Casters are optional on Small Media Cabinets at a price of **\$208 list**.
- Small Media Cabinets are suitable for use with 27" wide monitors. Please contact Customer Service if dimensions are critical.
- Locks are optional on wood doors at a price of **\$152 list** per lock mechanism.
- Media Cabinets with hinged or pocket doors come equipped with a pull-out swivel shelf (which can accommodate up to 250 lbs.).

VIRTU | SMALL MEDIA CABINETS & DISPLAY CABINETS

Description	Model	Cherry/Maple/ Walnut	Anigre	W	D	H	Shipping Weight	Cubic Feet
Monitor cabinet lower hinged wood doors	62MC-36243011	3352	4366	36	24	29.5	170	19



ORDERING NOTES

For security reasons, a lock is optional for this unit at a price of **\$152 list**.

Monitor cabinet lower hinged glass doors	62MC-36243011G	3591	4131	36	24	29.5	170	19
---	----------------	------	------	----	----	------	-----	----



Display Cabinet with ward- robe fixed glass shelves lower wood door	62DC-21247671L	4155	4782	21	24	76	190	24
	62DC-21247671R	4155	4782	21	24	76	190	24

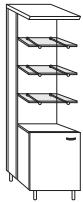

ORDERING NOTES

Locks are optional on both lower door and wardrobe door at a price of **\$152 list** each.

Glass shelves are not fixed to shelf supports.

We recommend that halogen lights be specified on Display Cabinets with glass shelves only.

Available at a price of **\$555 list** each.

Display Cabinet with ward- robe fixed glass shelves lower glass door	62DC-21247671GL	4426	5091	21	24	76	190	24
	62DC-21247671GR	4426	5091	21	24	76	190	24

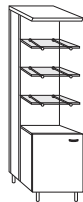

ORDERING NOTES

Wardrobe door features an optional lock at a price of **\$152 list** each.

Glass shelves are not fixed to shelf supports.

We recommend that halogen lights be specified on Display Cabinets with glass shelves only.

Available at a price of **\$555 list** each.

Display Cabinet with ward- robe fixed wood shelves lower wood door	62DC-21247672L	4104	4721	21	24	76	190	24
	62DC-21247672R	4104	4721	21	24	76	190	24

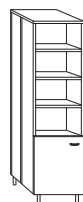

ORDERING NOTES

Locks are optional on both lower door and wardrobe door at a price of **\$152 list** each.

This item is available on the KrugExpress quickship program.

ORDERING PROCEDURE

To order, please specify the following:

1. Product model number
2. Wood species and finish
3. Metal finish
4. Special options/features

CODE DESCRIPTION

MC - media cabinet
G - glass doors
W - wood doors
A - gabled doors

SPECIAL FEATURES

- Casters are optional on Small Media Cabinets at a price of **\$208 list**.
- Small Media Cabinets are suitable for use with 27" wide monitors. Please contact Customer Service if dimensions are critical.
- Locks are optional on wood doors at a price of **\$152 list** per lock mechanism.
- Media Cabinets with hinged or pocket doors come equipped with a pull-out swivel shelf (which can accommodate up to 250 lbs.).

VIRTU | SMALL DISPLAY CABINETS

Description	Model	Cherry/Maple/ Walnut			W	D	H	Shipping Weight	Cubic Feet
		Walnut	Anigre						
Display Cabinet with wardrobe	62DC-21247672GL	4377	5032	21	24	76	190	24	
fixed wood shelves lower glass door	62DC-21247672GR	4377	5032	21	24	76	190	24	

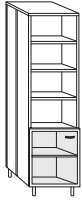

ORDERING NOTES

Wardrobe door features an optional lock at a price of **\$152 list** each.

Display Cabinet with wardrobe	62DC-21247674WGL	4888	5619	21	24	76	195	24
upper glass door lower wood door	62DC-21247674WGR	4888	5619	21	24	76	195	24

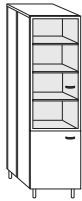

ORDERING NOTES

Lower and wardrobe doors feature an optional lock at a price of **152 list** each.

Display Cabinet with wardrobe	62DC-21247674GL	5121	5891	21	24	76	195	24
upper glass door lower glass door	62DC-21247674GR	5121	5891	21	24	76	195	24



ORDERING NOTES

Lower and wardrobe doors feature an optional lock at a price of **\$152 list** each.

Display Cabinet with wardrobe	62ST-21207613L	4224	4860	21	20	76	145	20
adjust. wood shelves lower wood door	62ST-21207613R	4224	4860	21	20	76	145	20



ORDERING NOTES

Wardrobe door features an optional lock at a price of **\$152 list** each.

ORDERING PROCEDURE

To order, please specify the following:

1. Product model number
2. Wood species and finish
3. Metal finish
4. Special options/features

CODE DESCRIPTION

MC - media cabinet
G - glass doors
W - wood doors

SPECIAL FEATURES

- Casters are optional on Small Media Cabinets at a price of **\$208 list**.
- Small Media Cabinets are suitable for use with 27" wide monitors. Please contact Customer Service if dimensions are critical.
- Locks are optional on wood doors at a price of **\$152 list** per lock mechanism.
- Media Cabinets with hinged or pocket doors come equipped with a pull-out swivel shelf (which can accommodate up to 250 lbs.).

VIRTU | SMALL DISPLAY CABINETS

Description	Model	Cherry/Maple/ Walnut	Anigre	W	D	H	Shipping Weight	Cubic Feet
Display Cabinet with wardrobe	62ST-21207613GL	4499	5173	21	20	76	145	20
adjust. wood shelves lower glass door	62ST-21207613GR	4499	5173	21	20	76	145	20

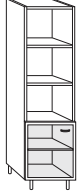

ORDERING NOTES

Lower door features an optional lock at a price of **\$152 list**.
This item is available on the KrugExpress quickship program.

Display/Storage Cabinet upper wood door	62ST-21207614L	4675	5374	21	20	76	150	20
lower wood door	62ST-21207614R	4675	5374	21	20	76	150	20

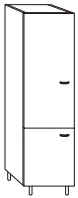

ORDERING NOTES

Upper and lower doors feature an optional lock at a price of **\$152 list** each.
This item is available on the KrugExpress quickship program.

Display/Storage Cabinet upper glass door	62ST-21207614WGL	5009	5761	21	20	76	150	20
lower wood door	62ST-21207614WGR	5009	5761	21	20	76	150	20

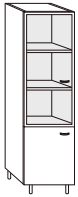

ORDERING NOTES

Lower door features an optional lock at a price of **\$152 list**.

Display/Storage Cabinet upper glass door	62ST-21207614GL	5245	6035	21	20	76	150	20
lower glass door	62ST-21207614GR	5245	6035	21	20	76	150	20

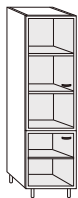

ORDERING PROCEDURE

To order, please specify the following:

1. Product model number
2. Wood species and finish
3. Metal finish
4. Special options/features

CODE DESCRIPTION

DC - display cabinet
G - glass doors
L - door hinged left
R - door hinged right

SPECIAL FEATURES

- We recommend that halogen lights be specified on Display Cabinets with glass shelves only. Available at a price of **\$555 list** each.
- Interior wood shelves are removable.
- Locks are optional on wood doors at a price of **\$152 list** per lock mechanism.
- 21" Display Cabinets feature wardrobes with coat hooks behind the front display.

VIRTU | DISPLAY CABINETS

Description	Model	Cherry/Maple/ Walnut	Anigre	W	D	H	Shipping Weight	Cubic Feet
Display Cabinet with wardrobe fixed glass shelves lower wood doors	62DC-42247671L	5779	6642	42	24	76	270	42
	62DC-42247671R	5779	6642	42	24	76	270	42

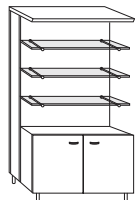

ORDERING NOTES

Lower doors and wardrobe doors feature an optional lock at a price of **\$152 list** each.
Glass shelves are not fixed to shelf supports.
We recommend that halogen lights be specified on Display Cabinets with glass shelves only.
Available at a price of **\$555 list** each.

Display Cabinet with ward- robe fixed wood shelves lower wood doors	62DC-42247672L	5539	6373	42	24	76	270	42
	62DC-42247672R	5539	6373	42	24	76	270	42

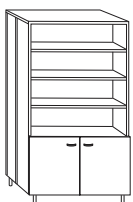

ORDERING NOTES

Lower doors and wardrobe doors feature an optional lock at a price of **\$152 list** each.
This item is available on the KrugExpress quickship program.

Display Cabinet with wardrobe fixed glass shelves lower glass doors	62DC-42247671GL	6029	6936	42	24	76	270	42
	62DC-42247671GR	6029	6936	42	24	76	270	42

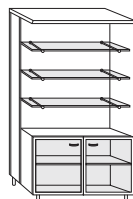

ORDERING NOTES

Wardrobe doors feature an optional lock at a price of **\$152 list**.
Glass shelves are not fixed to shelf supports.
We recommend that halogen lights be specified on Display Cabinets with glass shelves only.
Available at a price of **\$555 list** each.

Display Cabinet with wardrobe fixed wood shelves lower glass doors	62DC-42247672GL	5722	6582	42	24	76	270	42
	62DC-42247672GR	5722	6582	42	24	76	270	42



ORDERING NOTES

Wardrobe doors feature an optional lock at a price of **\$152 list**.

ORDERING PROCEDURE

To order, please specify the following:

1. Product model number
2. Wood species and finish
3. Metal finish
4. Special options/features

CODE DESCRIPTION

DC - display cabinet
W - wood doors
G - glass doors
L - door hinged left
R - door hinged right
ST - storage cabinet

SPECIAL FEATURES

- We recommend that halogen lights be specified on Display Cabinets with glass shelves only. Available at a price of **\$555 list** each.
- Interior wood shelves are removable.
- Locks are optional on wood doors at a price of **\$152 list** per lock mechanism.
- 21" Display Cabinets feature wardrobes with coat hooks behind the front display.

VIRTU | STORAGE CABINETS

Description	Model	Cherry/Maple/ Walnut	Anigre	W	D	H	Shipping Weight	Cubic Feet
Storage Cabinet adjust. wood shelves lower wood doors	62ST-42207613	5562	6397	42	24	76	220	39

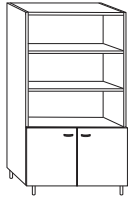

ORDERING NOTES

Lower doors feature an optional lock at a price of **\$152 list**.
This item is available on the KrugExpress quickship program.

Storage Cabinet adjust. wood shelves lower glass doors	62ST-42207613G	6046	6750	42	24	76	220	39
--	----------------	------	------	----	----	----	-----	----



Storage Cabinet with shelves wood doors (42")	62ST-42207611	5524	6352	42	20	76	225	39
	62ST-42247611	5706	6557	42	24	76	265	47

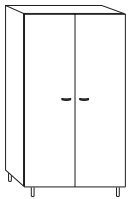

ORDERING NOTES

Wood doors feature an optional lock at a price of **\$152 list**.
This item is available on the KrugExpress quickship program.

Storage Cabinet upper glass shelves lower wood doors	62ST-42207614WG	6122	7042	42	20	76	225	39
	62ST-42247614WG	6491	7464	42	24	76	265	47



ORDERING NOTES

Lower doors feature an optional lock at a price of **\$152 list**.

ORDERING PROCEDURE

To order, please specify the following:

1. Product model number
2. Wood species and finish
3. Metal finish
4. Special options/features

CODE DESCRIPTION

ST - storage cabinet
G - glass doors
L - door hinged left
R - door hinged right
W - wood doors

SPECIAL FEATURES

- Locks are available on wood doors at a price of **\$152 list** per lock mechanism.
- Interior shelves are height adjustable in increments of 1 1/4".
- Interior wood shelves are removable.

VIRTU | STORAGE CABINETS

Description	Model	Cherry/Maple/ Walnut	Anigre	W	D	H	Shipping Weight	Cubic Feet
Storage Cabinet upper wood shelves lower wood doors	62ST-42207614	5830	6707	42	20	76	225	39
	62ST-42247614	6182	7107	42	24	76	265	47

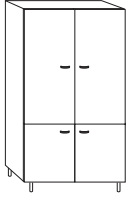

ORDERING NOTES

Upper and lower doors feature an optional combined lock at a price of **\$152 list**.
This item is available on the KrugExpress quickship program.

Storage Cabinet upper glass doors lower glass doors	62ST-42207614G	6884	7915	42	20	76	225	39
	62ST-42247614G	7295	8391	42	24	76	265	47



Storage Cabinet open bookcase	62ST-36207617	4077	4690	36	20	76	190	34
----------------------------------	---------------	------	------	----	----	----	-----	----

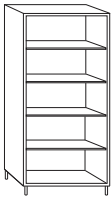

ORDERING NOTES

This item is available on the KrugExpress quickship program.

Storage Cabinet closed bookcase wood doors (36")	62ST-36207611	4441	5106	36	20	76	220	34
--	---------------	------	------	----	----	----	-----	----

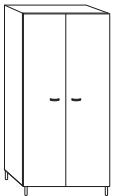

ORDERING NOTES

Wood doors feature an optional lock at a price of **\$152 list**.
This item is available on the KrugExpress quickship program.

ORDERING PROCEDURE

To order, please specify the following:

1. Product model number
2. Wood species and finish
3. Metal finish
4. Special options/features

CODE DESCRIPTION

ST - storage cabinet
G - glass doors

SPECIAL FEATURES

- Locks are available on wood doors at a price of **\$152 list** per lock mechanism.
- Interior shelves are height adjustable in increments of 1 1/4".
- Interior wood shelves are removable.

VIRTU | STORAGE CABINETS & WARDROBES

Description	Model	Cherry/Maple/ Walnut	Anigre	W	D	H	Shipping Weight	Cubic Feet
Storage Cabinet with shelves wood door	62ST-21207611L	3552	4084	21	20	76	150	20
	62ST-21207611R	3552	4084	21	20	76	150	20
	62ST-21247611L	3736	4295	21	24	76	174	24
	62ST-21247611R	3736	4295	21	24	76	174	24

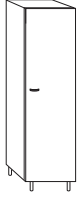

ORDERING NOTES

Wood door features an optional lock at a price of **\$152 list**.
This item is available on the KrugExpress quickship program.

Wardrobe wood doors	62WR-42247601	5483	6307	42	24	76	265	47
------------------------	---------------	------	------	----	----	----	-----	----

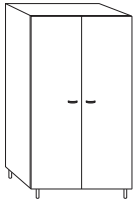

ORDERING NOTES

Wood doors feature an optional lock at a price of **\$152 list**.
Interior is identical to wardrobe with glass doors.
This item is available on the KrugExpress quickship program.

Wardrobe wood door	62WR-21247602L	3483	4005	21	24	76	170	24
	62WR-21247602R	3483	4005	21	24	76	170	24

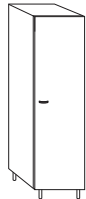

ORDERING NOTES

Wood door features an optional lock at a price of **\$152 list**.
This item is available on the KrugExpress quickship program.

ORDERING PROCEDURE

To order, please specify the following:

1. Product model number
2. Wood species and finish
3. Metal finish
4. Special options/features

CODE DESCRIPTION

ST - storage cabinet

SPECIAL FEATURES

- Locks are available on wood doors at a price of **\$152 list** per lock mechanism.
- Interior shelves are height adjustable in increments of 1 1/4".
- Interior wood shelves are removable.

VIRTU | CREDENZAS

Description	Model	Cherry/Maple/ Walnut		Anigre	W	D	H	Shipping Weight	Cubic Feet
Credenza	62C-75202901*	8438	9699	75	20	29.5	217	27	
Standard Height	62C-75242901*	8623	9917	75	24	29.5	255	32	
wood drawers, wood doors	62C-75202902**	8438	9699	75	20	29.5	217	27	
partial glass top	62C-75242902**	8623	9917	75	24	29.5	255	32	

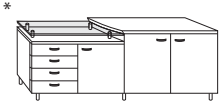

ORDERING NOTES

Wood doors feature an optional lock at a price of **\$152 list**.

Bookmatched Birdseye Maple veneer is available on worksurfaces of VIRTU cases at an upcharge of **\$76 list per square foot**.

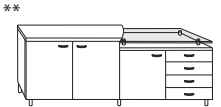

Credenza	62C-75202903*	7787	8955	75	20	29.5	217	27
Standard Height	62C-75242903*	7974	9173	75	24	29.5	255	32
wood doors	62C-75202904**	7787	8955	75	20	29.5	217	27
partial glass top	62C-75242904**	7974	9173	75	24	29.5	255	32

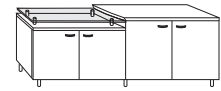

ORDERING NOTES

Wood doors feature an optional lock at a price of **\$152 list**.

Bookmatched Birdseye Maple veneer is available on worksurfaces of VIRTU cases at an upcharge of **\$76 list per square foot**.

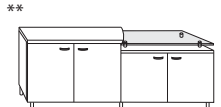

Credenza	62C-75202905	6318	7264	75	20	29.5	217	27
Standard Height	62C-75242905	6519	7493	75	24	29.5	255	32
wood doors								
full wood top								

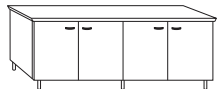

ORDERING NOTES

Wood doors feature an optional lock at a price of **\$152 list**.

Bookmatched Birdseye Maple veneer is available on worksurfaces of VIRTU cases at an upcharge of **\$76 list per square foot**.

This item is available on the KrugExpress quickship program.

Credenza	62C-75202906	7446	8562	75	20	29.5	217	27
Standard Height	62C-75242906	7616	8759	75	24	29.5	255	32
wood doors								
full glass top								

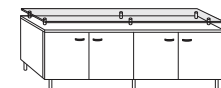

ORDERING NOTES

Wood doors feature an optional lock at a price of **\$152 list**.

ORDERING PROCEDURE

To order, please specify the following:

1. Product model number
2. Wood species and finish
3. Metal finish
4. Special options/features

CODE DESCRIPTION

C - credenza

SPECIAL FEATURES

- Horizontal glass surfaces on Credenzas feature 10 mm thick frosted tempered glass.
- Locks are optional on wood doors at a price of **\$152 list** per lock mechanism.
- Wooden shelves are height adjustable in increments of 1 1/4".
- Bookmatched Birdseye Maple veneer is available on worksurfaces of VIRTU cases at an upcharge of **\$76 list** per square foot.

Description	Model	Cherry/Maple/ Walnut		W	D	H	Shipping Weight	Cubic Feet
			Anigre					
Credenza	62C-75202903G*	8356	9605	75	20	29.5	217	27
Standard Height	62C-75242903G*	8538	9813	75	24	29.5	255	32
glass doors	62C-75202904G**	8356	9605	75	20	29.5	217	27
partial glass top	62C-75242904G**	8538	9813	75	24	29.5	255	32

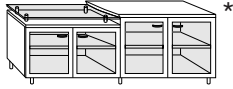

ORDERING NOTES

Bookmatched Birdseye Maple veneer is available on worksurfaces of VIRTU cases at an upcharge of **\$76 list per square foot.**

**

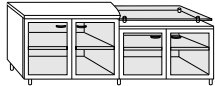

Credenza	62C-75202905G	6888	7923	75	20	29.5	217	27
Standard Height	62C-75242905G	7078	8141	75	24	29.5	255	32
glass doors								
full wood top								

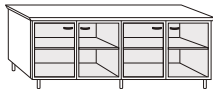

ORDERING NOTES

Bookmatched Birdseye Maple veneer is available on worksurfaces of VIRTU cases at an upcharge of **\$76 list per square foot.**

Credenza	62C-75202906G	7965	9160	75	20	29.5	217	27
Standard Height	62C-75242906G	8153	9376	75	24	29.5	255	32
glass doors								
full glass top								

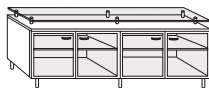

ORDERING PROCEDURE

To order, please specify the following:

1. Product model number
2. Wood species and finish
3. Metal finish
4. Special options/features

CODE DESCRIPTION

C - credenza
G - glass doors

SPECIAL FEATURES

- Horizontal glass surfaces on Credenzas feature 10 mm thick frosted tempered glass.
- Wooden shelves are height adjustable in increments of 1 1/4".
- Bookmatched Birdseye Maple veneer is available on work surfaces of VIRTU cases at an upcharge of **\$76 list** per square foot.

VIRTU | BUFFETS

Description	Model	Cherry/Maple/ Walnut			W	D	H	Shipping Weight	Cubic Feet
		Walnut	Anigre						
Buffet	62BU-75203501*	8618	9983	75	20	34.5	245	31	
wood drawers	62BU-75243501*	8871	10202	75	24	34.5	295	37	
wood doors	62BU-75203502**	8682	9983	75	20	34.5	245	31	
partial glass top	62BU-75243502**	8871	10202	75	24	34.5	295	37	

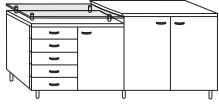

ORDERING NOTES

Wood doors feature an optional lock at a price of **\$152 list**.

Buffets ordered with mini refrigerators have different interior dimensions than those ordered without.

Refrigerators cannot be retrofitted into a unit shipped without a refrigerator.

Bookmatched Birdseye Maple veneer is available on worksurfaces of VIRTU cases at an upcharge of **\$76 list per square foot**.

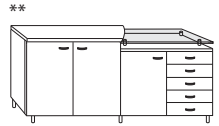

Buffet	62BU-75203503*	8033	9234	75	20	34.5	245	31
wood doors	62BU-75243503*	8221	9455	75	24	34.5	295	37
partial glass top	62BU-75203504**	8033	9234	75	20	34.5	245	31
	62BU-75243504**	8221	9455	75	24	34.5	295	37

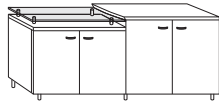

ORDERING NOTES

Wood doors feature an optional lock at a price of **\$152 list** per set of two doors.

Buffets ordered with mini refrigerators have different interior dimensions than those ordered without.

Refrigerators cannot be retrofitted into a unit shipped without a refrigerator.

Bookmatched Birdseye Maple veneer is available on worksurfaces of VIRTU cases at an upcharge of **\$76 list per square foot**.

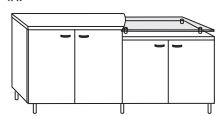

Buffet	62BU-75203505	6567	7547	75	20	34.5	245	31
wood doors	62BU-75243505	6760	7777	75	24	34.5	295	37
full wood top								

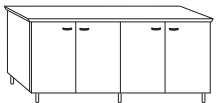

ORDERING NOTES

Wood doors feature an optional lock at a price of **\$152 list** per set of two doors.

Buffets ordered with mini refrigerators have different interior dimensions than those ordered without.

Refrigerators cannot be retrofitted into a unit shipped without a refrigerator.

Bookmatched Birdseye Maple veneer is available on worksurfaces of VIRTU cases at an upcharge of **\$76 list per square foot**.

This item is available on the KrugExpress quickship program.

Buffet	62BU-75203506	7690	8845	75	20	34.5	245	31
wood doors	62BU-75243506	7864	9041	75	24	34.5	295	37
full glass top								

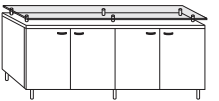

ORDERING NOTES

Wood doors feature an optional lock at a price of **\$152 list** per set of two doors.

Buffets ordered with mini refrigerators have different interior dimensions than those ordered without.

Refrigerators cannot be retrofitted into a unit shipped without a refrigerator.

ORDERING PROCEDURE

To order, please specify the following:

1. Product model number
2. Wood species and finish
3. Metal finish
4. Special options/features

CODE DESCRIPTION

BU - buffet

SPECIAL FEATURES

- Buffets with wood drawers feature a cutlery drawer for serving needs.
- Horizontal glass surfaces on Buffets feature 10 mm thick frosted tempered glass.
- Optional Mini Refrigerators are available on 24" deep units at a price of **\$2638 list**. Please contact Customer Service for specific information.
- Locks are optional on wood doors at a price of **\$152 list** per lock mechanism.
- Bookmatched Birdseye Maple veneer is available on worksurfaces of VIRTU cases at an upcharge of **\$76 list** per square foot.

Description	Model	Cherry/Maple/ Walnut		Anigre	W	D	H	Shipping Weight	Cubic Feet
Buffet	62BU-75203503G*	8597	9885	75	20	34.5	245	31	
glass doors	62BU-75243503G*	8781	10095	75	24	34.5	295	37	
partial glass top	62BU-75203504G**	8597	9885	75	20	34.5	245	31	
*	62BU-75243504G**	8781	10095	75	24	34.5	295	37	

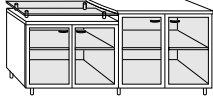

ORDERING NOTES

Buffets ordered with mini refrigerators have different interior dimensions than those ordered without. Refrigerators cannot be retrofitted into a unit shipped without a refrigerator. Bookmatched Birdseye Maple veneer is available on worksurfaces of VIRTU cases at an upcharge of **\$76 list per square foot**.

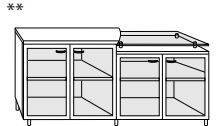

Buffet	62BU-75203505G	7145	8213	75	20	34.5	245	31
glass doors	62BU-75243505G	7322	8418	75	24	34.5	295	37
full wood top								



ORDERING NOTES

Buffets ordered with mini refrigerators have different interior dimensions than those ordered without. Refrigerators cannot be retrofitted into a unit shipped without a refrigerator. Bookmatched Birdseye Maple veneer is available on worksurfaces of VIRTU cases at an upcharge of **\$76 list per square foot**.

Buffet	62BU-75203506G	8209	9440	75	20	34.5	245	31
glass doors	62BU-75243506G	8395	9654	75	24	34.5	295	37
full glass top								

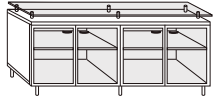

ORDERING NOTES

Buffets ordered with mini refrigerators have different interior dimensions than those ordered without. Refrigerators cannot be retrofitted into a unit shipped without a refrigerator.

ORDERING PROCEDURE

To order, please specify the following:

1. Product model number
2. Wood species and finish
3. Metal finish
4. Special options/features

CODE DESCRIPTION

BU - buffet
G - glass doors

SPECIAL FEATURES

- Buffets with wood drawers feature a cutlery drawer for serving needs.
- Horizontal glass surfaces on Buffets feature 10 mm thick frosted tempered glass.
- Optional Mini Refrigerators are available on 24" deep units at a price of **\$2638 list**. Please contact Customer Service for specific information.
- Locks are optional on wood doors at a price of **\$152 list** per lock mechanism.
- Bookmatched Birdseye Maple veneer is available on worksurfaces of VIRTU cases at an upcharge of **\$76 list** per square foot.

VIRTU | SERVER CART AND MEDIA CART

Description	Model	Cherry/Maple/ Walnut	Anigre	W	D	H	Shipping Weight	Cubic Feet
Server Cart refuse container cutlery drawer glass serving shelf	62MSC-422435	4595	5284	42.25	23.5	34.5	180	23



Mobile Media Cart wood top wood doors	62MMC-402438	4200	4830	40	24.25	38.5	188	22
---	--------------	------	------	----	-------	------	-----	----



ORDERING NOTES

It is recommended that Media Carts be moved by 2 people when A/V equipment is attached.

Mobile Media Cart wood top, wood shelf wood doors	62MMC-402447	4415	5075	40	24.25	46.5	190	28
---	--------------	------	------	----	-------	------	-----	----



ORDERING NOTES

It is recommended that Media Carts be moved by 2 people when A/V equipment is attached.

ORDERING PROCEDURE

To order, please specify the following:

1. Product model number
2. Wood species and finish
3. Metal finish
4. Special options/features

CODE DESCRIPTION

MSC - Mobile Carts
MMC - Mobile Media Cart

SPECIAL FEATURES

- Locks are available on wood doors at a price of **\$152 list** per lock mechanism.
- Interior shelves are height adjustable in increments of 1 1/4".
- Interior wood shelves are removable.

Description	Model	Cherry/Maple/ Walnut			W	D	H	Shipping Weight	Cubic Feet
			Anigre						
Visual Board inclined doors wood doors glass shelf	62VB-3632IGS	3966	4515	36	-	32	73	5	
	62VB-4832IGS	4316	4911	48	-	32	93	6.5	
	62VB-4848IGS	4573	5203	48	-	48	128	10	

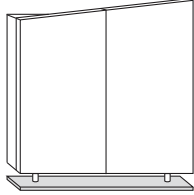

ORDERING NOTES

Includes an upholstered tackboard in grade 1 fabric or optional cork surface. Please specify a tackboard fabric when ordering. Visual Boards also include a flip chart, eraser and four dry erase markers. An optional pull down screen is also available at **\$245 list**.

Visual Board glass doors	62VB-3632G	4447	4996	36	-	32	68	5
	62VB-4832G	4942	5536	48	-	32	88	6.5
	62VB-4848G	5345	5971	48	-	48	123	10

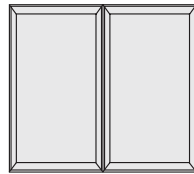

ORDERING NOTES

Visual Board includes four dry erase markers. An optional pull down screen is also available at **\$245 list**. Flip chart and tackboard are not available on this model.

Visual Board gabled doors wood doors	62VB-3632A	3795	4365	36	-	32	73	5.5
	62VB-4832A	4090	4706	48	-	32	93	7
	62VB-4848A	4328	4978	48	-	48	128	10.5

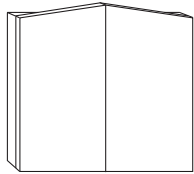

ORDERING NOTES

Includes an upholstered tackboard in grade 1 fabric or optional cork surface. Please specify a tackboard fabric when ordering. Visual Boards also include a flip chart, eraser and four dry erase markers. An optional pull down screen is also available at **\$245 list**.

Visual Board wood doors	62VB-3632	3682	4230	36	-	32	71	5
	62VB-4832	3981	4573	48	-	32	90	6.5
	62VB-4848	4190	4817	48	-	48	125	10

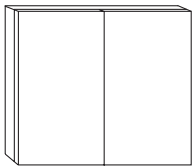

ORDERING NOTES

Includes an upholstered tackboard in grade 1 fabric or optional cork surface. Please specify a tackboard fabric when ordering. Visual Boards also include a flip chart, eraser and four dry erase markers. An optional pull down screen is also available at **\$245 list**.

ORDERING PROCEDURE

To order, please specify the following:

1. Product model number
2. Wood species and finish
3. Metal finish
4. Special options/features

CODE DESCRIPTION

VB - Visual boards
A - gabled Doors
G - glass doors
GS - glass shelf
IGS - inclined glass shelf

SPECIAL FEATURES

- Server Carts come with a cutlery drawer and refuse container.
- Media Carts feature built in a power bar and cable slot for wire management.
- Locks are optional on wood doors at a price of **\$152 list** per lock mechanism.
- Mobile Media Carts will generously accommodate monitors up to 27" in size. Please contact Customer Service if dimensions are critical.
- Server Cart and Media Cart top surface overhang and underside finger groove facilitate movement.

VIRTU | LECTERN

Description	Model	Cherry/Maple/ Walnut	Anigre	W	D	H	Shipping Weight	Cubic Feet
Lectern - floor lectern hardware storage with hinged access door hinged doors glass laptop shelf	62LN-37225011	6209	7137	37	22	50	215	25

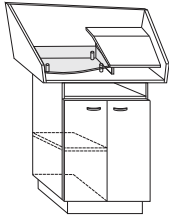

ORDERING NOTES

Lectern features grommets for wire management.
Left side shelf is adjustable on this version. Right side of this version is open.

Lectern - mobile lectern hardware storage with hinged access door hinged doors glass laptop shelf	62LNM-37225011	6361	7317	37	22	50	215	25
---	----------------	------	------	----	----	----	-----	----

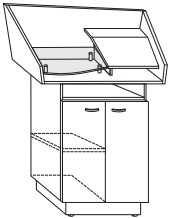

ORDERING NOTES

Lectern features grommets for wire management.
Left side shelf is adjustable on this version. Right side of this version is open.

Lectern - floor lectern hardware storage hinged doors full width worksurface	62LNX-37225011	5870	6795	37	22	50	215	25
---	----------------	------	------	----	----	----	-----	----

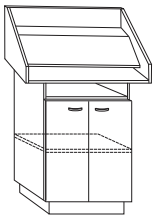

ORDERING NOTES

Lectern features grommets for wire management.
Center shelf on this version is adjustable.

ORDERING PROCEDURE

To order, please specify the following:

1. Product model number
2. Wood species and finish
3. Metal finish
4. Special options/features

CODE DESCRIPTION

LN - Lectern
LNM - Lectern (mobile)
LNX - Lectern with full
width shelf

SPECIAL FEATURES

- See above for special features specific to each Visual board tackboard fabrics
- Please contact Customer Service for information on Grade 1 fabrics suitable for use on Visual Board tackboards.
- COM and other in-stock fabrics may be specified at an upcharge. Please contact Customer Service for details.

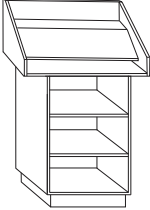
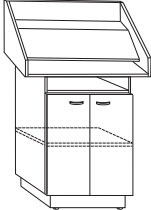
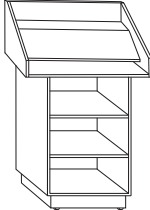
Description	Model	Cherry/Maple/ Walnut			W	D	H	Shipping Weight	Cubic Feet
		Walnut	Anigre						
Lectern - floor lectern open shelves full width worksurface	62LNX-37225017	5916	6884	37	22	50	205	25	
	ORDERING NOTES Lectern features grommets for wire management. Both shelves on this version are adjustable.								
Lectern - mobile lectern hardware storage with hinged access door hinged doors full width worksurface	62LNXM-37225011	6387	7359	37	22	50	215	25	
	ORDERING NOTES Lectern features grommets for wire management.								
Lectern - mobile lectern open shelves full width worksurface	62LNXM-37225017	6137	7108	37	22	50	205	25	
	ORDERING NOTES Lectern features grommets for wire management.								
Logo Plate	62-LOGO-14-7	768		14	0.4	6.3			



The Satin Aluminum Logo Plate comes unattached to the Lectern. It is designed to be provided to a signage company for application of the company logo, with either a vinyl transfer or silk screening. After the signage is complete, the Logo Plate can be attached to the Lectern surface. First, determine the position that the Logo Plate is to be positioned. Remove the black plastic end caps and attach via wood screws. Once secure, snap the Logo Plate over top of the end caps to complete the installation.

ORDERING PROCEDURE

To order, please specify the following:

1. Product model number
2. Wood species and finish
3. Metal finish
4. Special options/features

CODE DESCRIPTION

LNXM - Lectern with full length shelf (mobile)

SPECIAL FEATURES

- Lecterns are designed to accommodate microphones which can be field installed. Please contact Customer Service for more information.
- All hinged doors on Lecterns feature standard locks.

Lectern options

- Altinex Box : price of **\$1273 list.**
- Power Bar : price of **\$208 list.**
- Reference Light : price of **\$443 list.**

VIRTU | ELECTRICAL ACCESSORIES

Description	Model	Price
Altinex Box		1273

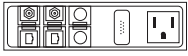

ORDERING NOTES

Please note clearly on order if Altinex is to be added to lectern

Whip Cord	62EX	182
-----------	------	-----



ORDERING NOTES

A short extension cord with standard male/female 3 prong head at either end. Enables Connexus™ use with large transformers, such as the Polycom conference phone, to connect externally from the module.

Power Bar	62PWR01	189
-----------	---------	-----

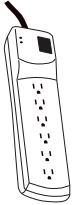

ORDERING NOTES

Power bars feature a 6' long cord, 6 AC power outlets and a circuit breaker. Power bars can be added to table bases, Media Cabinets and Lecterns. Power bars are standard on Media Carts.

Wire Management Trough	62WM-48	82
------------------------	---------	----

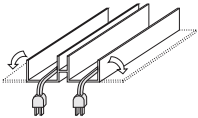

ORDERING PROCEDURE

To order, please specify the following:

1. Product model number

CODE DESCRIPTION

EX - Whip cord
PWR - Power bar

VIRTU | INSTALLATION INSTRUCTIONS

SINGLE SECTION WITH DAIS, FORZA SQUARE & OBLIQUE



COMPONENTS

- 3/4" Hex drive bolt (112164)
- 8 per Dais/Oblique base
- 12 per Verso/Forza Square base

TOOLS REQUIRED

- 5/32" Allen Key or driver

IMPORTANT: If table has Connexus™ modules, install them using their instructions before proceeding.

PROCEDURE

1. Unpack table and all base(s). Find all of the hardware listed. Fasteners are in a bag on the bottom of one section (some fasteners may be shipped with the bases).

MAKE SURE THE CORRECT SIZE AND QUANTITY OF COMPONENTS ARE INCLUDED WITH THE TABLE.

2. Put base(s) in the approximate place where the table will be located in the room. Place over base(s). Align the metal base plates with the inserts in the underside of the top.

3. To fasten bases to the top, insert the 3/4" bolts through the plate on the base and into the inserts. Start threading the bolts by hand to prevent cross-threading. Tighten with Allen key or power driver.

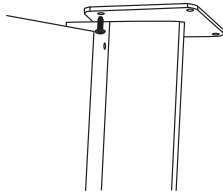

Forza

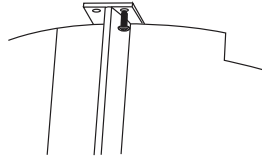

Dais

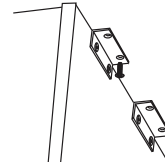

Oblique

4. Attach wire management components to bottom of assembled table. For additional help please contact Customer Service.

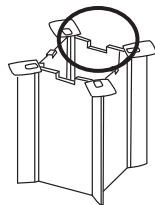

cut outs face towards center of table

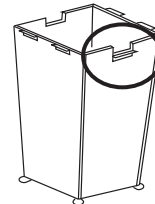

door faces towards center of table

CAUTION: TABLES CAN BE EXTREMELY HEAVY. MAKE SURE THERE ARE SUFFICIENT PEOPLE AVAILABLE TO FLIP TABLE UPRIGHT. DO NOT SUBSTITUTE HARDWARE. IF HARDWARE IS MISSING, CONTACT CUSTOMER SERVICE.

VIRTU | INSTALLATION INSTRUCTIONS

OPEN VISIO



COMPONENTS

- A) 3/4" hex drive bolt (112164)
• 6 per Forza Leg
+ 16 per joint

TOOLS REQUIRED

- 5/32" Allen Key or driver



- B) Tite-joint fastener (10637)
• 3 per joint



- C) Fastener rod (11687)

IMPORTANT: If table has Connexus™ modules, install them using their instructions before proceeding.

PROCEDURE

1. Unpack all table sections and bases. Find all the hardware listed. Fasteners are in a bag on the bottom of one section (some fasteners may be shipped with the bases). **MAKE SURE THE CORRECT SIZE AND QUANTITY OF COMPONENTS ARE INCLUDED WITH THE TABLE.**
2. Place single end section table upside down onto a soft surface. See figure 1.

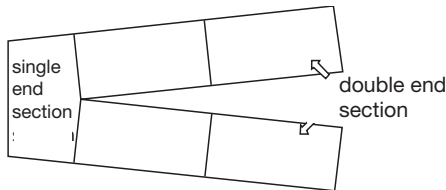

Figure 1

3. Fasten six bases to the top, insert the 3/4" bolts (A) through the plate on the base and into the inserts. Start threading the bolts by hand to prevent cross-threading. Tighten with allen key or power driver.
4. Stand end section upright.
5. Place center table sections upside down onto a soft surface. Identify top section number coding on bottom of sections that is the same as the single end section.
6. Fasten two bases to the top on the other end from the location found in step 5. See figure 2. Insert the 3/4" bolts (A) through the plate on the base and into the inserts. Start threading the bolts by hand to prevent cross-threading. Tighten with allen key or power driver.

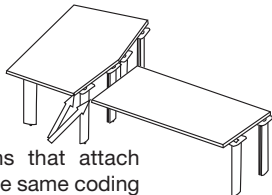
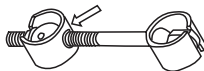

Figure 2

Sections that attach will have same coding underside

7. Stand centre section upright and attach to appropriate side of single end section. Insert the 3/4" bolts (A) through the plate on the base and into the inserts. Start threading the bolts by hand to prevent cross-threading. Tighten with allen key or power driver.
8. Repeat steps 5-7 for double end sections.
9. Assemble the tite-joint fastener as shown in figure 3. Install assembled tite-joint with machining in table sections.



correctly installed

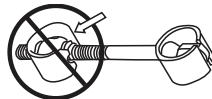

incorrectly installed

10. Flush the edge of the sections and tighten fasteners with rod provided (C). Do not over tighten.
11. Adjust top alignment, if required by slightly loosening tite-joint fasteners and base plate bolts, making the adjustment and re-tightening fasteners and bolts.
12. Attach modesty panels with L-brackets and screws provided.
13. Attach wire management extrusion to modesty panels with screws provided.

For additional help please contact Customer Service.

CAUTION: TABLES CAN BE EXTREMELY HEAVY. MAKE SURE THERE ARE SUFFICIENT PEOPLE AVAILABLE TO FLIP TABLE UPRIGHT. DO NOT SUBSTITUTE HARDWARE. IF HARDWARE IS MISSING, CONTACT CUSTOMER SERVICE.

VIRTU | INSTALLATION INSTRUCTIONS

SINGLE SECTION WITH FORZA LEGS OR PANELS



COMPONENTS

- 3/4" Hex drive bolt (112164)
- 6 per leg/12 per panel

TOOLS REQUIRED

- 5/32" Allen Key or driver

IMPORTANT: If table has Connexus™ modules, install them using their instructions before proceeding.

PROCEDURE

1. Unpack table and all bases. Find all the hardware listed. Fasteners are in a bag on the bottom of one section (some fasteners may be shipped with the bases.) **MAKE SURE THE CORRECT SIZE AND QUANTITY OF COMPONENTS ARE INCLUDED WITH THE TABLE.**
2. Place table upside down onto a soft surface. As shown in Figure 1, invert and position the bases onto the underside of the table and align the metal base plates with the inserts in the underside of the top. **THE BLACK PLASTIC EXTRUSION FACES TOWARDS THE CENTER OF THE TABLE.**

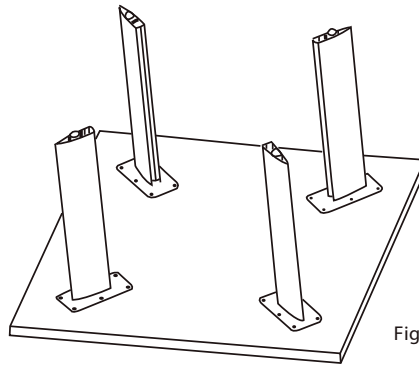

Figure 1

3. To fasten bases to the top, insert the 3/4" bolts through the plate on the base and into the inserts. Start threading the bolts by hand to prevent cross-threading. Tighten with allen key or power driver.
4. Flip assembled table over.
5. Attach wire management components to bottom of assembled table.

For additional help please contact Customer Service.

CAUTION: TABLES CAN BE EXTREMELY HEAVY. MAKE SURE THERE ARE SUFFICIENT PEOPLE AVAILABLE TO FLIP TABLE UPRIGHT. DO NOT SUBSTITUTE HARDWARE. IF HARDWARE IS MISSING, CONTACT CUSTOMER SERVICE.

VIRTU | INSTALLATION INSTRUCTIONS

MULTI-SECTION WITH FORZA LEGS OR PANELS

COMPONENTS

- A) 3/4" Hex drive bolt (112164)
 • 16 per joint
 + (8 per Dais/Oblique)/(12 per Verso/Forza)



TOOLS REQUIRED

- 5/32" Allen Key or driver



- B) Tite-joint fastener (10637)
 • 3 per joint



- C) Fastener rod (11687)

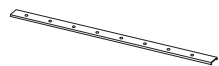

- D) Channel bracket
 • per joint

IMPORTANT: If table has Connexus™ components, install them using their instructions before proceeding.

PROCEDURE

1. Unpack all table sections and bases. Find all the hardware listed. Fasteners are in a bag on the bottom of one section and the channels are wrapped together (some fasteners may be shipped with the bases.) **MAKE SURE THE CORRECT SIZE AND QUANTITY OF COMPONENTS ARE INCLUDED WITH THE TABLE.**
2. Place table upside down onto a soft surface. Arrange top sections by the number coding on bottom of sections.
3. For tables with four (4) or more sections refer to chart for assembly detail. Align the machining in one section with the machining in the adjacent section. Bring the sections tight together.

Top	Top Lengths	Assembly Order	
		Before Flipping	After Flipping
	168 192	ACW3-BCW3 CCE3-DCE3	ACW3/BCW3-CCE3/DCE3
	216 240	ACW3-BCW3 DCE3-ECE3	ACW3/BCW3-CCW3 CCW3-DCE3/ECE3
	264 288	ACW3-BCW3 ECE3-FCE3 CCW3-DCE3	ACW3/BCW3-CCW3/DCE3 CCW3/DCE3-ECE3/FCE3

4. Assemble the tite-joint fastener as shown in figure 1. Install assembled tite-joint with machining in table sections.

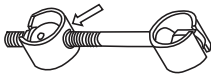

correctly installed

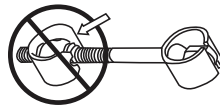

incorrectly installed

5. Flush the edge of the sections and tighten fasteners with rod provided (C). Do not over tighten
6. As shown in Figure 2, align holes in the channel brackets (D) with threaded inserts in the top sections. To fasten the channel brackets, start threading the 3/4" bolts (A) by hand. This will prevent cross-threading the bolt into the inserts, which may cause damage to the table tops.

Figure 2

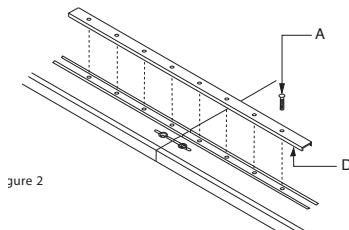

VIRTU | INSTALLATION INSTRUCTIONS

7. As shown in Figure 3, invert and position the bases onto the underside of the outer table sections and align the metal base plates with the inserts in the underside of the top. To fasten bases to the top, insert the 3/4" bolts (A) through the plate on the base and into the inserts. Start threading the bolts by hand to prevent cross-threading. Tighten with allen key or power driver.

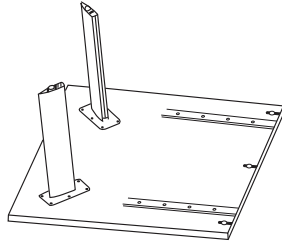
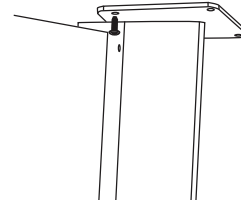
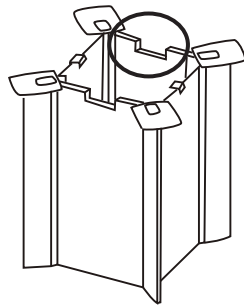

Figure 3



8. If table has center bases put bases in the approximate place where the table will be located in the room. Flip all assembled table sections over and place over center bases (if required). Repeat steps 4-6 (if required) for sections not already attached.



cut outs face towards
center of table

9. Adjust top alignment, if required by slightly loosening tite-joint fasteners and channel bracket bolts, making the adjustment and re-tightening fasteners and bolts.

10. Attach wire management extrusion to bottom of assembled table with screw provided.

For additional help please contact Customer Service.

CAUTION: TABLES CAN BE EXTREMELY HEAVY. MAKE SURE THERE ARE SUFFICIENT PEOPLE AVAILABLE TO FLIP TABLE UPRIGHT. DO NOT SUBSTITUTE HARDWARE. IF HARDWARE IS MISSING, CONTACT CUSTOMER SERVICE.

VIRTU | INSTALLATION INSTRUCTIONS

MULTI-SECTION WITH DAIS, VERSO, FORZA SQUARE & RECTANGLE AND OBLIQUE

COMPONENTS

A) 3/4" Hex drive bolt (112164) 5/32" Allen Key or driver
 • 16 per joint
 + (8 per Dais/Oblique)/(12 per Verso/Forza)

B) Tite-joint fastener (10637)
 • 3 per joint

C) Fastener rod (11687)

D) Channel bracket
 • per joint

TOOLS REQUIRED

IMPORTANT: If table has Connexus™ modules, install them using their instructions before proceeding.

PROCEDURE

1. Unpack all table sections and bases. Find all the hardware listed. Fasteners are in a bag on the bottom of one section and the channels are wrapped together (some fasteners may be shipped with the bases.)
 MAKE SURE THE CORRECT SIZE AND QUANTITY OF COMPONENTS ARE INCLUDED WITH THE TABLE.

2. Place table upside down onto a soft surface. Arrange top sections by the number coding on bottom of sections.

3. For tables with four (4) or more sections refer to chart for assembly detail. Align the machining in one section with the machining in the adjacent section. Bring the sections tight together.

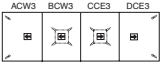
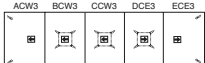
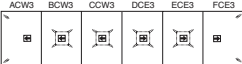
Top	Top Lengths	Assembly Order	
		Before Flipping	After Flipping
	168 192	ACW3-BCW3 CCE3-DCE3	ACW3/BCW3-CCE3/DCE3
	216 240	ACW3-BCW3 DCE3-ECE3	ACW3/BCW3-CCW3 CCW3-DCE3/ECE3
	264 288	ACW3-BCW3 ECE3-FCE3	ACW3/BCW3-CCW3/DCE3 CCW3/DCE3-ECE3/FCE3

4. Assemble the tite-joint fastener as shown in figure 1. Install assembled tite-joint with machining in table sections.

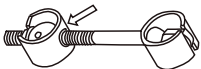

correctly installed

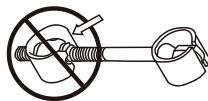

incorrectly installed

5. Flush the edge of the sections and tighten fasteners with rod provided (C). Do not over tighten

6. As shown in Figure 2, align holes in the channel brackets (D) with threaded inserts in the top sections. To fasten the channel brackets, start threading the 3/4" bolts (A) by hand. This will prevent cross-threading the bolt into the inserts, which may cause damage to the table tops.

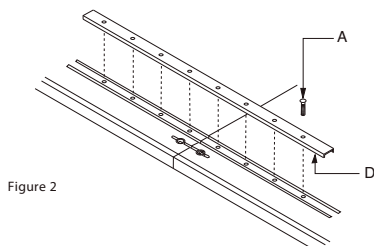
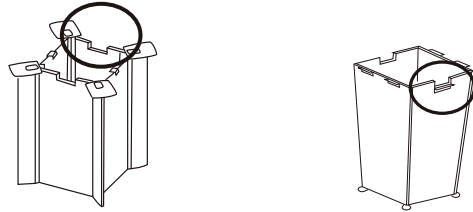

Figure 2

Multi-Section with Dais, Verso, Forza Square & Rectangle and Oblique

7. As shown in Figure 3, invert and position the bases onto the underside of the outer table sections and align the metal base plates with the inserts in the underside of the top. To fasten bases to the top, insert the 3/4" bolts (A) through the plate on the base and into the inserts. Start threading the bolts by hand to prevent cross-threading. Tighten with allen key or power driver.



8. To fasten bases to the top, insert the 3/4" bolts (A) through the plate on the base and into the inserts. Start threading the bolts by hand to prevent cross-threading. Tighten with allen key or power driver.

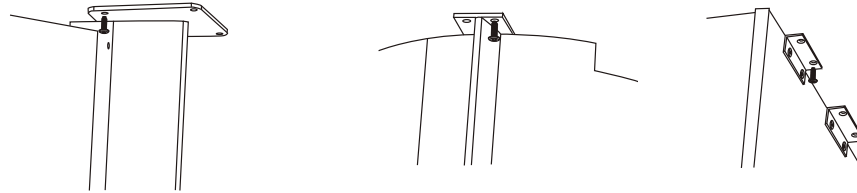

Forza Square
Forza Rectangle
Verso

Dais

Oblique

9. Adjust top alignment, if required by slightly loosening tite-joint fasteners and channel bracket bolts, making the adjustment and re-tightening fasteners and bolts.

10. Attach wire management extrusion to bottom of assembled table with screw provided.

For additional help please contact Customer Service.

CAUTION: TABLES CAN BE EXTREMELY HEAVY. MAKE SURE THERE ARE SUFFICIENT PEOPLE AVAILABLE TO FLIP TABLE UPRIGHT. DO NOT SUBSTITUTE HARDWARE. IF HARDWARE IS MISSING, CONTACT CUSTOMER SERVICE.

VIRTU | INSTALLATION INSTRUCTIONS

CONNEXUS™ INTERFACE INSTALLATION

We recommend that you place the table on a soft surface
SAVE THESE INSTRUCTIONS

Tools Required:
Drill with driver bits or screwdriver
Utility Knife (if required)

INSTALLATION

1. Identify ALL the connexus locations on the top sections and connexus cartons. (They will be labeled with a green tag to indicate the location within the table. For example, ACW3. See Figure 1. Place the cartons (containing the connexus Interface) with the same coded top section carton.
2. Open the top carton that corresponds with the carton that these instructions came from and then remove protective packaging from both top and interface. Do each interface and top section one at a time to prevent mixing interfaces.
3. After unpacking, place the top section with the bottom facing up on a soft surface as to not damage the top.
4. Place the tongue of the corresponding interface into aluminum extrusion in top, see Fig. 2a. Aligning the electrical components in the interface over the door hinge on the aluminum components in the top. The door hinge side of the connexus is labeled with the location code, see Fig. 2b. Screw interface to inserts in the table top with screws shown in Fig. 3.
5. Align the u-shaped cutouts in the cover-box with the electrical components in the interface. Pass the power cord thru one of the u-shaped cutouts. The large flat face of the interface should line up flush with the large opening in the cover-box. Screw cover box to table top with screws shown in Fig. 3.
6. Repeat steps 3 to 5 for each location.
7. Assemble top according to Assembly instructions provided.
8. Attach wire management extrusion to bottom of assembled table. Trough may need to be cut to length. Align the extrusion with the bases and/or the cutout in the cover-box as required with screws provided.

For additional help please contact Customer Service

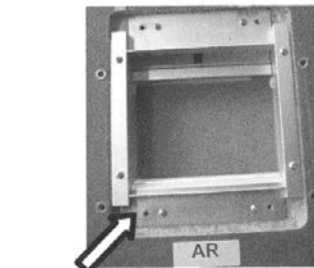
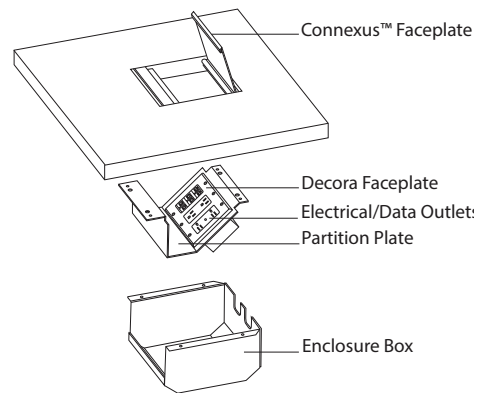

Door hinge **Figure 2b**



Figure 3

VIRTU | INSTALLATION INSTRUCTIONS

On-site RJ45 wire instructions

Category 6 Snap-In Connector Installation Instructions

INTRODUCTION: Leviton Telcom eXtreme 6 products are designed to work as a system to achieve proposed Category 6 component level performance. The Leviton eXtreme 6 Cabling System consists of eXtreme 6 connectors and eXtreme patch cords, as well as “gigabit-rated” cable from a Leviton eXtreme cable partner. If Category 5 components are substituted for eXtreme components, a lesser performance level can be expected.

SAFETY INFORMATION

1. Never install communications wiring or components during a lightning storm.
2. Never install communications components in wet locations unless the components are designed specifically for use in wet locations.
3. Never touch uninsulated wires or terminals unless the wiring has been disconnected at the network interface.
4. Use caution when installing or modifying communications wiring or components.
5. To prevent electrical shock, each opening must be filled with a module or blank filler.

IMPORTANT INSTRUCTIONS

1. Read and understand all instructions.
2. Follow all warnings and instructions marked on the product.
3. Do not use this product near water—e.g., near a tub, wash bowl, kitchen sink or laundry tub, in a wet basement, or near a swimming pool.
4. Never push objects of any kind into this product through cabinet slots, as they may touch dangerous voltages.

SAVE THESE INSTRUCTIONS

1. Remove connector from Connexus interface panel by inserting a small flat screw into top of connector/ faceplate and twist slightly.

Connector should pop out.

2. Remove about 2” of jacket from cable.
3. Determine which wiring scheme (T568A or T568B) and note the associated color codes on the label located between the IDC connector slots. The label also includes connector pin numbers. Refer to Fig 2-1 & 2-2.
4. Route the wires for termination as shown in Fig 3-1. Terminate one pair at a time starting from the side of cable entry. Terminating each pair after placement will prevent crushing the inside pairs with a punch-down tool (not supplied). Lay cable in so that jacket touches edge of connector as shown.*
5. Using a 110 style impact tool set to “low” impact (not supplied), seat the wires into the IDC slots. Maintain wire pair twisting as close as possible to the IDC contact (Must be 1/4” or closer). Use the cutting side of the tool to trim the excess wire flush with the connector body. See Fig 4-1.

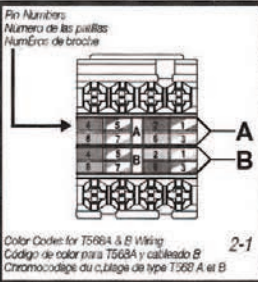

Pin Numbers
Número de las pines
Numéros de broche

Color Codes for T568A & B Wiring
Código de color para T568A y cableado B
Chromocodage du c.âblage de type T568 A et B

2-1

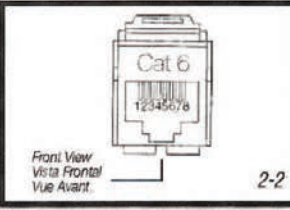

Front View
Vista Frontal
Vue Avant

2-2

T568A & T568B Wiring Standards - Connector Pin/Color Assignments
Normativas de cableado T568A y T568B - Patillas de conexión/Asignaciones de color
Normes de câblage T568A et T568B - Attributions broche / couleur des connecteurs

CABLE ENTRY FROM LEFT
Entrada de cable desde la izquierda
Entrée de câble par la gauche

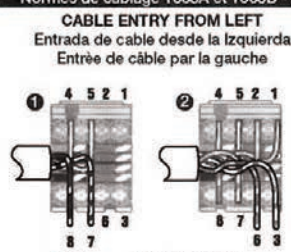

T568A

- 5 WHITE/BLUE
- 4 BLUE/WHITE
- 3 WHITE/ORANGE
- 6 ORANGE/WHITE
- 1 WHITE/GREEN
- 2 GREEN/WHITE
- 7 WHITE/BROWN
- 8 BROWN/WHITE

CABLE ENTRY FROM RIGHT
Entrada de cable desde la derecha
Entrée de câble par la droite

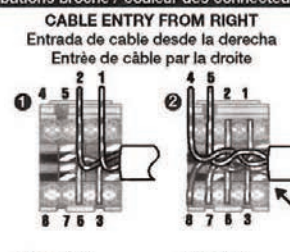

T568A

- Blanco/Azul
- Azul/Blanco
- Naranja/Naranja
- Naranja/Blanco
- Blanco/Verde
- Verde/Blanco
- Blanco/Café
- Café/Blanco

T568B

- 5 WHITE/BLUE
- 4 BLUE/WHITE
- 1 WHITE/ORANGE
- 2 ORANGE/WHITE
- 3 WHITE/GREEN
- 6 GREEN/WHITE
- 7 WHITE/BROWN
- 8 BROWN/WHITE

T568B

- Blanco/Azul
- Azul/Blanco
- Naranja/Naranja
- Naranja/Blanco
- Blanco/Verde
- Verde/Blanco
- Blanco/Café
- Café/Blanco

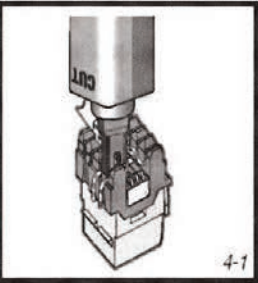

4-1

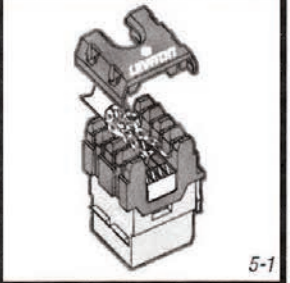

5-1

VIRTU | INSTALLATION INSTRUCTIONS

On site RJ11 wire instructions

Voice grade Snap-In Connector Installation Instructions

SAFETY INFORMATION

1. Never install communications wiring or components during a lightning storm.
2. Never install communications components in wet locations unless the components are designed specifically for use in wet locations.
3. Never touch uninsulated wires or terminals unless the wiring has been disconnected at the network interface.
4. Use caution when installing or modifying communications wiring or components.
5. To prevent electrical shock, each opening must be filled with a module or blank filler.

IMPORTANT INSTRUCTIONS

1. Read and understand all instructions.
2. Follow all warnings and instructions marked on the product.
3. Do not use this product near water—e.g., near a tub, wash bowl, kitchen sink or laundry tub, in a wet basement, or near a swimming pool.
4. Never push objects of any kind into this product through cabinet slots, as they may touch dangerous voltages.

SAVE THESE INSTRUCTIONS

1. Remove connector from Connexus interface panel by inserting a small flat screw into top of connector/ faceplate and twist slightly. Connector should pop out.
2. Remove jacket from cable.
3. Check jack termination label (located on sides of jack) for wiring standard and associated color codes. The label also includes jack pin numbers. (Figure 1)
4. Route the wires for termination as shown in Figure 2.
5. Using a 110 style punch-down tool (not supplied), seat the wires into the IDC slots. With the cutting edge of the tool to the outside, trim the excess wire flush with the jack body. (Figure 3)
6. Place the cap over the termination wires for secure connection and added strain relief. (Figure 4)
7. Insert connector assembly into Connexus interface. Note the “UP” position of the connector.

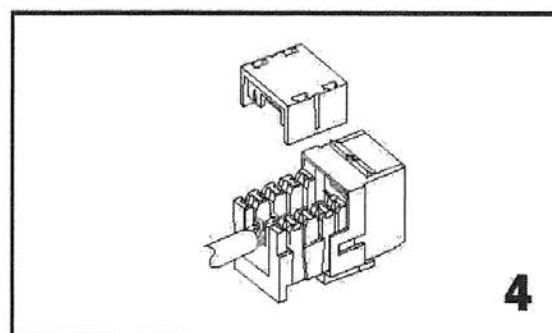
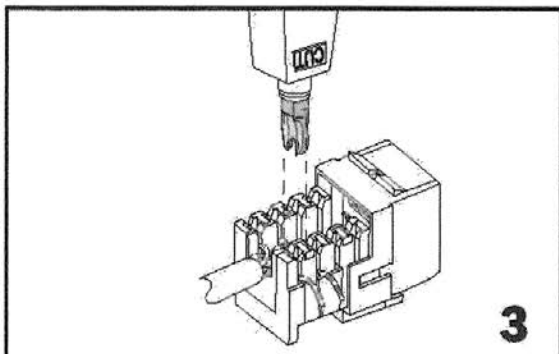
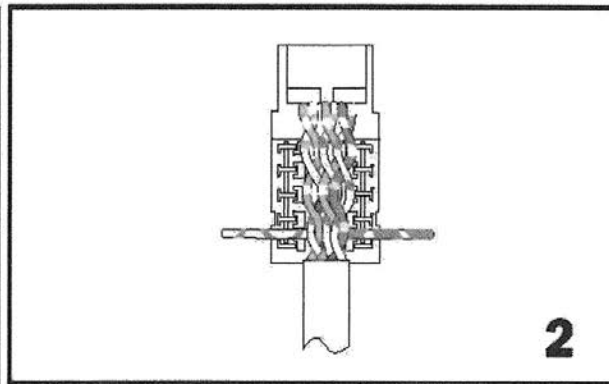
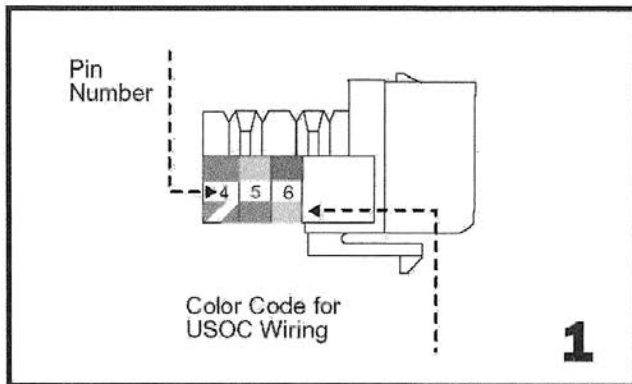

On site electrical outlet wire schematic

1. Power supply
2. Strain relief
3. Fork terminal
4. Duplex receptacles
5. Outlet with breaker assembly
6. Handy box

HARDWIRING ON SITE

For hardwiring on-site by electricians, please use the following schematic:

- ① Power Supply Cord
- ② Strain Relief
- ③ Fork Terminals
- ④ Duplex Receptacles
- ⑤ Outlets with Circuit Breaker Assembly
- ⑥ Handy Box

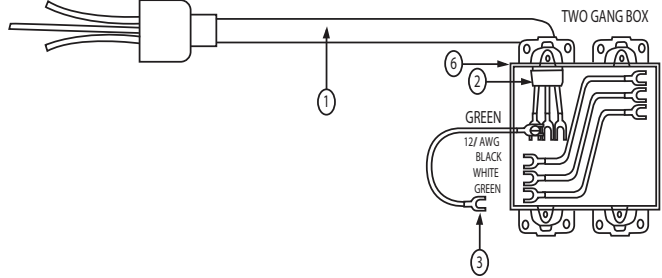

On site RCA cable hookup

1. Determine the correct length of cord (RCA cable is not supplied).
2. Attach appropriate end of cable to the back of Connexus interface connector.
3. Route cable through appropriate wire management.

On site BNC cable hookup

1. Determine the correct length of cord (BNC cable is not supplied).
2. Attach appropriate end of cable to the back of Connexus interface connector.
3. Route cable through appropriate wire management.

On site 15 PIN HD cable hookup

1. Determine the correct length of cord (VGA cable is not supplied).
2. Attach appropriate end of cable to the back of Connexus interface connector. Tighten fasteners if equipped.
3. Route cable through appropriate wire management.

On site DB-9 cable hookup

1. Determine the correct length of cord (Serial cable is not supplied).
2. Attach appropriate end of cable to the back of Connexus interface connector. Tighten fasteners if equipped.
3. Route cable through appropriate wire management.

On site MINI STEREO wiring hookup

1. Determine the correct length of cord (shielded 2 conductor cable is not supplied).
2. Remove about 1" of the wire jacket and about 1/4" of insulation from each wire.
3. Insert wire into terminal block and tighten with a 3/32" flat screw driver. See Fig. 1.
4. Route cable through appropriate wire management.

CIRCUIT BREAKER/OUTLETS ASSEMBLY

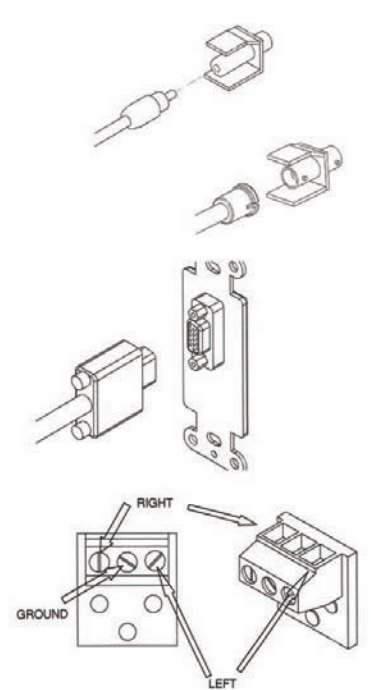
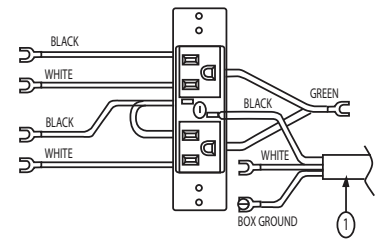

VIRTU | INSTALLATION INSTRUCTIONS

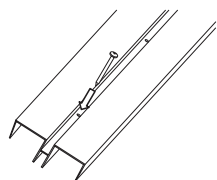

Wire Trough. Used when two or more connexus boxes are installed and with all bases. Trough may need to be cut.

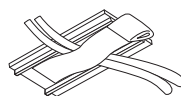

Velcro wire management strap. Used with 6232 & 6238 bases.

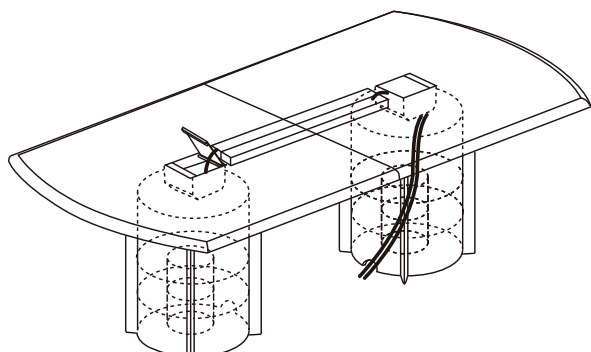

Example of wire management routing for table with 6230 bases using wire trough. Similar routing will work for tables 6234 and 6237 bases.

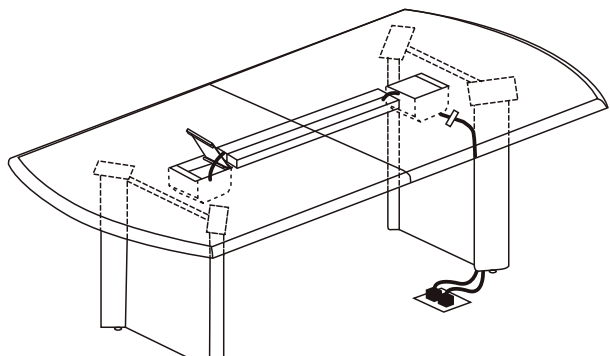

Example of wire management routing for tables with 6232 bases using both the wire trough and Velcro straps.

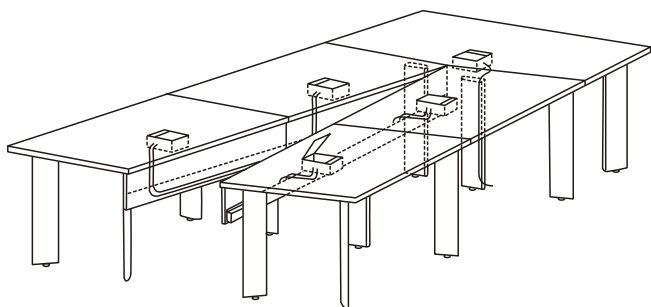

Example of wire management routing for Open Visio tables using the wire trough

Terms and Conditions

Net 30 days on approved credit. A late payment charge of 1% per month will be applied on overdue invoices. This charge will be pro-rated to the number of days past 30 days that the invoice is overdue. All applicable sales taxes are extra. Distribution of this price list does not in itself constitute an offer to sell. Orders can be received only from authorized Krug dealers. Acceptance of any order and terms of sale may be established at the discretion of Krug. Deposits are required on orders received from new accounts as well as on large or special orders. Krug reserves the right to discontinue designs, or to change designs, construction, prices, or materials without notice.

Contact Information

Phone: 1.888.578.KRUG (5784) | Fax: 1.519.748.5177
Purchase Order Fax: 1.888.236.4783
Purchase Order E-mail: orders@krug.ca
Web: www.krug.ca E-mail: solutions@krug.ca

Customer Service Hours

Please note customer service hours are:
8:30 am to 5:00 pm est

Customer Satisfaction

It is the primary goal of Krug and our staff to ensure the complete satisfaction of our customers with our products and performance. If a problem arises with a Krug product after the expiration of the limited warranty period, Krug will exercise its best efforts to achieve the satisfaction of the customer in a manner that is fair to all concerned.

Order Acknowledgments

Each order will be acknowledged via e-mail or fax. This acknowledgment is the final agreement between Krug and the customer, superseding all previous communications regarding the purchase order. Where there is a discrepancy on a purchase order between a product code and a description, Krug will make every effort to resolve the discrepancy, but will be ruled by the product code ordered. Please check all acknowledgments for accuracy, and advise Krug of any discrepancies with a purchase order.

Order Cancellation

Krug reserves the right to not accept or allow cancellation of orders. All products are manufactured on a custom-made, make-to-order basis, and the purchasing, engineering and production of orders begins shortly after order placement - and the customer purchase order is a contract that authorizes Krug to manufacture the products. Acceptance of order cancellation (or partial cancellation) is solely at the discretion of Krug, and is dependent on the extent to which engineering, purchasing and manufacturing has been initiated by the time cancellation is requested. No order cancellations (partial or otherwise) are allowable more than 4 weeks from date of order placement (as order production is unable to be terminated by that point), and full payment of the acknowledged order value is required for any orders cancelled after 4 weeks. Cancellations may be allowable in less than 4 weeks after order placement, depending on the extent to which manufacturing has been initiated. An acceptance of order cancellation requires that the purchaser agrees to make payment for all costs incurred to the point of acceptance of cancellation. Cancellation charges include all costs for purchase of dedicated material and components, engineering costs for non-standard products, and all costs for manufacturing completed to that point, as well as a \$350 net charge for processing of the original order and for processing of cancellation invoicing.

Pricing

Krug endeavors to ensure that all prices in this price list reflect accurately our current prices. However, errors do occur and will be rectified through notices to the field. Krug reserves the right to acknowledge pricing that may be different from the price list.

Storage Charges

Krug reserves the right to assess a nominal storage charge if a customer does not accept shipment of an order within a week of the ship date.

Warranty

Krug warrants the construction and the finish of all our products to be free from defects in materials and workmanship for a period of 10 years from the date of purchase. This warranty is applicable to products in use by their original purchaser. This warranty does not apply to components not manufactured by Krug including textiles, which are subject to the specific warranties of those manufacturers, if any. Textiles (fabric, leather, vinyl, or any other covering material) suppliers do not guarantee their products for durability and color fastness, and nor does Krug. Casters, mechanical and electrical components have a warranty of five years from the date of purchase. The Krug warranty does not apply to COM-specified materials, damage caused by a carrier other than Krug, or variation in wood finishes due to natural wood color variation. Krug cannot be held responsible for variations in fabric dye lots from order to order. All fabric is carefully inspected when it is received, but a degree of variation in color should be expected. Repairs or replacement of any defect covered under this warranty by Krug will be made, at our option and method, at no charge to the original purchaser during the warranty period. Krug's judgement is final and binding with respect to the nature or cause of defects or damage, and the necessity or manner of repair or replacement.

This warranty does not apply to defects or damage resulting from:

- normal wear and tear occurring with the use of the product
- negligence, misuse, excessive use, alteration, improper cleaning or repair
- substitution or use of incorrect or unauthorized components or material
- handling or installation that is incorrect, or that causes damage or defect
- damage incurred by a freight carrier other than Krug
- wearing of finishes and fabrics, and normal variations in materials (including dye lot variations)
- properties of natural materials, including wood and leather
- exposure to environments with uncontrolled temperature and humidity (products must be transported, stored and used in climate-controlled conditions)

Export Packaging

Krug is pleased to provide the option for export packaging on all our products, to provide additional protection from damage. For shipments overseas, a quote for export packaging can be provided, based on the products to be ordered and the delivery destination - please contact Customer Service or Bids & Specification Support for more information and a quotation. KRUG is not responsible for shipment damage occurring on overseas shipments

Export Packaging is STRONGLY RECOMMENDED for:

- (A) all shipments outside of the lower 48 states and Canada.
- (B) all shipments that will be held in storage for an extended period prior to installation.

Important: Please note that Krug will not be responsible for damage claims on product shipped or stored in the above conditions but where export packaging has not been utilized.

Dimensions

Dimensions are in inches and approximate, and subject to change without notice. Contact Customer Service if dimensions are critical.

Installation Support

For assistance please contact Technical Support at 1-888-578-5784 x216 or e-mail installationhelp@krug.ca and you will be directed to the appropriate installation support person.

Custom Capabilities

Over 15% of our orders involve some type of custom work, and we invite our customers to make use of our extensive capabilities. These include:

- 1) Dimensional customization of standard size products
- 2) Custom wood finishes
- 3) For larger orders, completely custom-designed products, as well as non-standard wood species can be specified.

Custom orders may require additional production lead times. Contact Customer Service for more information.

GENERAL INFORMATION

Freight Terms and Conditions

1. All product is shipped FOB the Krug factory. Freight is either pre-paid to the destination or not pre-paid, depending on established customer specific freight terms.
2. Docks at the selected delivery location must be equipped to handle a 53' trailer. If a dock is inadequate for delivery by Krug, Krug will re-deliver to another local location and any additional costs will be charged to the customer.
3. For all deliveries, it is understood that Krug or its agent is making a dock delivery only (equipped to handle a 53' trailer), and any further work of truck unloading, delivery beyond the dock, installation, and removal of packaging is not authorized or paid for by Krug.
4. Drop shipments to the installation site, and timed deliveries, are available on larger shipments (full truckloads or slightly less) at no additional charge. Drop shipments or timed deliveries for smaller shipments may not be available, or if available will require a surcharge. Deliveries on an after hours basis, or on weekends, or any other special requirements, may be subject to a surcharge. Location and contact information, and the requested time of delivery, is required at least one week prior to the acknowledged shipment date. If this information is not provided one week in advance, or if the location or time of the drop shipment is changed less than one week in advance, a surcharge may be applied, and/or the drop shipment may not be scheduled. For deliveries requested Monday to Thursday after 5:00 pm, please apply a surcharge of \$250/shipment. For deliveries requested Monday to Friday before 7:00 am, please apply a surcharge of \$250/shipment. For deliveries requested Friday (after 3:00 pm) or weekends, please apply a surcharge of \$500/shipment. (local times).
5. For all deliveries - whether to the Customer location or drop shipment - any circumstances that result in the delay of our carrier (including unsuitable receiving facilities, or facilities not open or available), service charges will be applied at the rate of \$125/hour. Where re-delivery is necessary because of these circumstances, the full cost of re-delivery will be charged. If Less Than Truck Load is delivering, one hour is allocated to unload. Any additional time required to unload after the first hour is \$125/hour. If a Truck Load is delivering the order, three hours is allocated to unload. Any additional time required to unload is \$125/hour. Direct deliveries to site for large orders are possible, (must exceed \$60,000 net), and accommodate 48 - 53' trailers. Krug is responsible for delivery to the approved delivery address. If an address change is required, this must be authorized by Krug 5 business days prior to ship date. Any additional delivery costs incurred after this time will be charged to the customer.

Product Strength and Durability Testing

All Krug Conference products meet or exceed the testing requirements of ANSI/BIFMA X5.5-2014 or X5.9-2012.



Damaged Shipments

All Krug product is well engineered, carefully inspected, and expertly loaded onto our trucks at our Distribution Center. If you receive any damaged freight, we ask that you do not refuse the shipment. Krug is not responsible for damage to goods that occurs in transit or storage. It is the purchaser and/or receiver's responsibility to examine the goods upon receipt and to notify Krug of any damages, overages or shortages. Any discrepancies should be noted on the Bill of Lading. The delivering carrier will not accept responsibility for shortages or damages if signed "clear". Notification of concealed damage claims must be made to Krug Distribution within 5 days of delivery, along with digital pictures if available. All product and packaging must be available for inspection. Krug liability ceases after 5 business days and Krug will not be responsible for concealed damages if shipments are left unopened. Krug is not responsible for the condition of product that is stored or installed in an environment where temperature and humidity are not controlled.

Field Product Report Authorization

Krug's written authorization, in the form of an FPR number, must be obtained prior to incurring charges of any kind if Krug is expected to pay these charges. This includes authorization for returns, field repairs and replacements, post field repairs, installation and delivery charges. Krug reserves the right to have its representative inspect product related to any request for such authorizations, prior to that authorization being provided. Deductions from invoices paid for any charges to Krug, without prior written authorization in the form of an FPR, will not be accepted. Digital photographs may be required to complete the FPR process.

Care and Maintenance

Wood Finishes - Although Krug's extensive finishing process ensures a durable finish on all our products, there are several steps that can be taken to protect and prolong the life and beauty of the finish. Protect the top by placing felt pads on the bottom of any accessories and mechanical equipment. Rubber and oil will permanently mark surfaces. Use a desk pad to prevent possible damage and imprinting caused by writing instruments and sharp objects. Dust only with a clean, dry cloth, going with the grain. Clean any marks with a damp cloth, using a small quantity of mild soap or detergent. Do not use any wax-based polish, spray or silicone. Eventually, a film will build up and discolor the top. Do not place your furniture in a position of permanent exposure to direct sunlight.

Plastic Laminates - Clean plastic laminates with mild soap and warm water. Do not use steel wool, hot water, or any abrasive cleaning product.

Krug Panel Fabric Program

Tackboards can be upholstered in COM material supplied by the customer, and in a selection of stocked tackboard fabrics supplied by Momentum. The Momentum Panel fabrics are available on Krug Express. They are 100% polyester. For additional information and color selections, please refer to our Panel Fabrics card and Krug's website. www.krug.ca PRODUCTS / FABRICS / PANEL. The Momentum panel fabrics pass ASTM-E84-87 Fire Codes. If memo samples are required please call Momentum at 1-800-366-6839.



PROGRAM DETAILS

KrugExpress orders are ready to ship by the date acknowledged. Delivery and shipping schedules may result in actual shipping of orders at a later date. Statutory holidays and scheduled factory vacations may add to acknowledged lead times of *KrugExpress* orders. Unless otherwise specified on the order, the customer's standard method of shipping Krug products will be utilized.

Available factory capacity for *KrugExpress* is filled by orders received on a "first come, first serve" basis. If the normal *KrugExpress* lead time is not available for your order because available capacity has been filled, you will be immediately advised of the earliest available ready-to-ship date. Please consult your Customer Service representative in advance if you wish to confirm the specific lead time availability for a *KrugExpress* order.

Orders must be received by midnight of a given day for that day to be considered the official day the order is received. Order lead times are acknowledged from the date the order is received, but not including the date the order is received.

KrugExpress orders must be "clean" when received in order to be considered officially received on a given day, and lead times will be acknowledged from the date orders are determined to be "clean".

Changes to *KrugExpress* orders are not allowed under any circumstances. Orders for product on *KrugExpress* must clearly state: "*KrugExpress*".

WOOD FINISHES AND LAMINATES

Standard Wood Finishes:

(See product pages for individual species availability)

SPECIES	FINISH
Cherry	Light Cherry
	Natural Cherry
	American Cherry
	Medium Cherry
	Standard Cherry
	Imperial Cherry
	Appalachian Cherry
	Sable Cherry
Maple	Clear Maple
	Honey Maple
	Wheat Maple
Oak	Light Oak
	SilverGrey on Oak
	Harvest Oak
	Mahogany Oak
	Medium Cherry on Oak
	Mellow Oak
	Walnut on Oak
Espresso on Oak	
Walnut	Natural Walnut
	Regular Walnut
	Mahogany on Walnut
	Dark Walnut
	Cordovan Walnut
SilverGrey on Walnut	
Anigre	Clear Anigre
	Medium Anigre
Palette	Black
	White
	Sand
	Soft Green
	Steel Blue
	Slate

NATURAL CHARACTERISTICS OF WOOD

Wood is a natural product with inherent color variations that will never be fully mitigated by the finishing process. Please anticipate variation in colors within a single unit, from piece to piece, and from Krug wood finish samples. If a very close match is required, a sample must be provided with the order and an upcharge will apply. Exact color matches are not possible.

CUSTOM WOOD FINISHES

Add 10% list to your order for special finishes, minimum upcharge is \$600 list per finish per order. (For example, on all orders up to \$6000 list, an upcharge of \$600 will apply, on orders \$6000 and up add 10% list to your order.) For orders with special finishes, a sample that is a minimum 3" by 3" must be received with the order. Special finishes may add additional lead time to production schedules. Since wood is a natural product, some variations in grain, color and stain acceptance will occur. In our finishing processes, we try to minimize variations, but some variation between samples and finished goods should be anticipated.

FINISH

Conference products feature Krug's finish, a proprietary catalyzed varnish formulation, that has repeatedly shown through independent laboratory testing to be the industry leader in durability and abrasion resistance. The Krug finish looks better longer than competitors and is uniquely suited to the demands of high traffic environments.

WOOD FINISHES TO MATCH STANDARD LAMINATES

Willow on Rift Oak
 Dune on Rift Oak
 Portobello on Rift Oak
 Ash on Rift Oak
 Copper on Cherry
 Shiraz Cherry
 Park Avenue Walnut
 Chocolate on Walnut
 Nutmeg on Walnut
 Dark Walnut
 Hardrock Maple

LAMINATES

Krug's in-stock Laminates are available in 17 different laminate selections. Please note that 4 of the colors (Gingerbread, Portobello, Ash and Willow) have textured finishes and may not be appropriate for use in patient areas due to infection control concerns. Minimum order quantities and extended lead times may apply for exotic laminate colors, please check with customer service. Polymer Edge will be selected to match the worksurface. Krug's previous laminate in-stock program will be phased out as in-stock supply depletes. Please contact customer service for availability.

IN-STOCK LAMINATES

Wood Grain Laminates	High Pressure Laminate Supplier	Textured Wood Grain Laminates	High Pressure Laminate Supplier
Champagne	Tafisa T492CR	Gingerbread	Tafisa T556UR
Hardrock Maple	Formica 86992-58	Portobello	Tafisa T557UR
Dune	Tafisa T491CR	Ash	Tafisa T535AT
Copper	Tafisa T521CR	Willow	Tafisa T543AT
Shiraz Cherry	Tafisa T472CR	Solid Laminates	
Park Avenue Walnut	Wilsonart 7984-38	Designer White	Wilsonart D354-60
Chocolate	Tafisa T498CR	Platinum	Tafisa T202CR
Nutmeg	Tafisa T477CR	Earth	Tafisa T767CR
Dark Walnut	Tafisa T469CR	Charcoal	Tafisa T228CR

PHASE OUT LAMINATES Almond - Black- Shadows - Edgewood Sycamore - Gunstock Walnut

NON-STOCKED LAMINATES

For specific lead time and application questions, please contact Krug Customer Service for your requirement. Upcharges will be applicable for non-stocked laminates, depending on their cost. Non-stock laminates may require a minimum order quantity, please contact customer service. Stocked polymer edges only can be specified for use with non-stocked laminates or tops will be self-edged.



FSC
www.fsc.org
FSC® C021699

The mark of responsible forest



All products are air emissions certified and are available as FSC®

krug

solutions@krug.ca | www.krug.ca | 1.888.578.KRUG