

**ZOLA**  
Price and Specification Guide  
USA



**krug**

Advancing Design Through Innovation

# ZOLA | TABLE OF CONTENTS

## ZOLA | LOUNGE & MODULAR LOUNGE

- 2 Zola Environmental Summary
- 3 Zola Lounge & Modular Features & Options
- 5 Zola Reconfigurability
- 5 Zola Seam Locations
- 6 Zola Sample Configuration
- 7 Zola Lounge Dimensions & COM Requirements
- 8 Zola Lounge Pricing
- 9 Zola Modular Dimensions & COM Requirements
- 10 Zola Modular Pricing
- 12 Zola Seatables
- 13 Zola Modular Replacement Components
- 14 Zola Tablets

## ZOLA | MODULAR CURVE

- 15 Zola Curve Dimensions & COM Requirements
- 17 Zola Modular Curve pricing

## ZOLA PRIVACY | LOUNGE & MODULAR LOUNGE

- 19 Zola Privacy Environmental Summary
- 20 Zola Privacy Features
- 21 Zola Privacy Options
- 22 Zola Privacy Power Locations
- 22 Zola Privacy Connecting Multiple Units
- 23 Zola Privacy Sample Configurations
- 25 Zola Privacy Preconfigured Dimensions & COM Requirements
- 26 Zola Privacy Preconfigured Pricing
- 29 Zola Privacy Modular Dimensions & COM Requirements
- 31 Zola Privacy Modular Pricing
- 37 Zola Privacy Side Panels
- 38 Zola Privacy Semi-Private Side Panels
- 38 Zola Privacy Modular Arms
- 39 Zola Privacy Twin Seats Dimensions & COM Requirements
- 41 Zola Privacy Twin Seats Pricing
- 43 Zola Privacy Twin Seat Side Panels
- 44 Zola Privacy Twin Semi-Private Side Panels
- 44 Zola Privacy Twin Modular Arms

## ZOLA PRIVACY | MODULAR CURVE

- 45 Zola Privacy Curved Dimensions
- 46 Zola Privacy Curved COM Requirements
- 47 Zola Privacy Curved Pricing
- 65 Zola Privacy Twin Curved Dimensions & COM Requirements
- 67 Zola Privacy Twin Curved Pricing
- 75 Zola Tablets

## ZOLA PRIVACY | INLINE WALLS

- 76 Zola Privacy Inline Walls Features & Options
- 77 Zola Privacy Inline Walls Sample Configurations
- 78 Zola Privacy Inline Walls Pricing
- 83 Zola & Zola Privacy Replacement Components

## ZOLA | MODULAR BENCH

- 85 Zola Bench Environmental Summary
- 86 Zola Bench Dimensions & COM Requirements
- 87 Zola Bench Modular & Modular Plus Pricing

## ZOLA | MODULAR CURVE BENCH

- 88 Zola Modular Curve Bench Dimensions & COM Requirements
- 90 Zola Modular Curve Bench Pricing
- 93 Zola Modular Curve Replacement Components

## ZOLA | BEHAVIORAL HEALTH

- 95 Zola Behavioral Health Environmental Summary
- 96 Zola Behavioral Health Features
- 97 Zola Behavioral Health Options
- 98 Zola Behavioral Health Dimensions & COM Requirements
- 99 Zola Behavioral Health Lounge Pricing
- 101 Zola Behavioral Health Freestanding Tables

## ZOLA | TABLES

- 102 Zola Environmental Summary
- 103 Zola Modular Linking Tables
- 105 Zola Freestanding Tables

## GENERAL INFORMATION

- 107 Terms & Conditions
- 107 Warranty
- 109 KRUG Textiles - Upholstery Fabrics
- 111 KRUG Textiles - Leather
- 112 KRUG Textiles - Faux Leather
- 113 Customer's Own Material (COM/COL)
- 113 CAL 133 & Moisture Barrier
- 114 Graded-In Upholstery Programs
- 114 *KRUGEXPRESS* Program
- 115 Finishes
- 115 Standard Laminates
- 116 Metal Finishes
- 116 Urethane Color Options
- 116 Solid Surface Program

LEED CI CREDITS



MATERIAL CONTENT

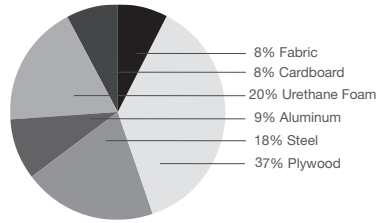

PRE-CONSUMER  
RECYCLED CONTENT = 6%

POST-CONSUMER  
RECYCLED CONTENT = 12.12%

Up to 35.11% of Zola Modular product is recyclable at the end of its useful life.

CONTRIBUTES TO

CREDIT 2.1 - 2.2	Construction Waste Management	1-2 point(s)
CREDIT 3.3	Resource Reuse	1 point
CREDIT 4.1	Recycled Content	1 point
CREDIT 4.5	Low Emitting Materials, Systems & Seating	1 point
CREDIT 5.1	Regional Materials*	1 point
CREDIT 7	Certified Wood (MUST BE REQUESTED)	1 point(s)

\*This credit is only applicable if in total 20% of the combined value of the procurement of construction materials and in the furniture are manufactured within a radius of 500 miles. This credit will apply if the installation of the finished product occurs within 500 miles of Kitchener, Ontario.

level® CERTIFICATION & AIR-EMISSIONS CERTIFICATION



level® CERTIFICATION

BIFMA's e3 Furniture Sustainability Standard is a voluntary, multi-attribute standard that measures the degree of sustainability of furniture. This standard evaluates product and company environmental attributes and compliance systems in a wide range of elements which include Materials, Energy & Atmosphere, Human & Ecosystem Health and Social Responsibility. Zola products have earned level®, BIFMA's sustainability certification program for furniture, certification through third-party verification against the e3 standard.



The mark of responsible forestry

AIR-EMISSIONS

All Zola products are supplied air-emissions certified. Contact customer service for information.

FSC®

In 2005, Krug received Forest Stewardship Council® (FSC®) Chain-of-Custody certification for our manufacturing facilities. The FSC® Chain-of-Custody tracks certified wood from seedling to final sale. It verifies that the material for our FSC® certified products only come from well-managed, FSC®-certified forests and other controlled sources. FSC® is dedicated to the promotion of responsible forest management worldwide helping to take care of forests for future generations. Zola and other Krug products can be specified with FSC® Certification. Contact customer service for further information, pricing and lead times.



Architects, designers, and building professionals can specify FSC®-certified products in order to achieve a point from the US Green Building Council's Leadership in Energy and Environmental Design (LEED) Rating System.

# ZOLA | FEATURES & OPTIONS



## INTENSIVE USE ENVIRONMENTS

Zola has been designed for healthcare and other intensive use environments, with some important features: removable and replaceable upholstery covers, an anti-microbial finish, the option of a urethane arm cap and a standard clean-out between the seat and back. Modular construction allows for complete cleaning and disinfecting of the entire unit, and air emissions certification, make Zola an excellent solution for healthy spaces and caregiving environments.



## ZOLA LOUNGE & ZOLA MODULAR

Zola Lounge chairs are pre-assembled at Krug and cannot be reconfigured into Modular units. Arms and backs cannot be removed from the seat.



## RECONFIGURABILITY

Zola Modular is designed to enable change: components are inter-changeable, reconfigurable, and replaceable. Metal-to-metal bracketry is designed for fast, easy reconfiguring, that does not damage or degrade the product, and new components can be added and added with ease. Both backs and arms can be reconfigured to either side of the unit. Its unique leveller provides exceptional leveling capability over large spans, and on uneven floors. Heavy duty casters provide seating with mobility.



## LINKING BRACKET

The Zola seat-to-seat linking bracket is made of sturdy, powder-coated steel construction in a black finish. This linking bracket is fastened with metal to metal connections from the seat to another seat with hardened steel bolts to ensure exceptional durability and strength. Brackets mount underneath, and do not mar or damage the tables or seats. This feature is not available on the Lounge version.



## REPLACEABILITY

Zola is built to last: its heavy-duty structure is designed for intensive use environments. When any component is damaged or degraded, it can be easily changed out on its own, instead of having to replace or repair an entire unit. Along with its use of recycled and recyclable materials, the replaceability of components means Zola can provide exceptional long term value, and be an investment in sustainability.



## FINISH DURABILITY

The Krug's finish a proprietary catalyzed varnish formulation, has been repeatedly shown, through independent laboratory testing, to be the industry leader in durability and abrasion resistance. The Krug finish looks better longer than competitors, and is uniquely suited to the demands of high traffic environments.



## WALL SAVER

The angle of the Zola Lounge back is designed to keep the back away from the wall, to prevent wear and damage to both the chairs and to the walls of the room. Zola upholstered chairs are built with a 1/2" clearance between the top of the back and the wall for the wall saver design. Please note wall saver is not a feature on the wood back versions.



## CLEAN OUT

Zola chairs have a built-in clean out feature: a space at the back of the seat that allows dirt and debris to fall to the floor for easy clean up and maintenance. The clean out feature was designed so that it does not detract from the comfort or appearance of the product.



## CASTERS

Optional on the Zola Lounge are the choice of: a) Four - 3 1/4" dia hard wheel casters, consisting of two non braking on the front, and two braking on the back. Braking casters have a large, easy access foot activation lever.

b) Two non braking casters on the back, and two legs on the front. Casters are NOT available on the Plus product(s)



## LEGS

Zola legs are Silver Metallic or Matte Black and feature glides that are adjustable up to 1.25", which provide leveling capability over longer spans.



## URETHANE ARM CAP

The optional urethane arm cap provides enhanced durability and protection for the arms. Urethane arm caps are available in two color options; Grey and Taupe. The urethane arm cap is field replaceable if damaged or degraded with the assistance of a skilled upholsterer.



## SOLID SURFACE ARM CAP

The optional Solid Surface Arm Cap provides enhanced durability, protection and cleanability for the arms. This is field replaceable if this becomes damaged or degraded and is available in 8 standard colors.



## FULL DEPTH BENCHES

Modular Curved Benches are offered in two depths. For a flush edge when joining a Modular Curved Bench to Modular seat with back choose the Full Depth.

## PLUS UPGRADE

Zola seating is available with optional Plus Upgrade. Plus Seating has been engineered to support higher weight capacities, accommodating a wider variety of users.

## WEIGHT CAPACITIES

Zola weight capacities are as follows:

One-Seat (Straight or curved)	- 300 lbs
One-Seat Plus	- 750 lbs
Two-seat ( Straight or curved)	- 525lbs
Two-seat Plus	- 975 lbs
Three-seat	- 750 lbs
Three-seat Plus	- 1150 lbs



## TABLETS

Optional Tablets are available on the Zola Lounge & Modular in veneer, clear glass, solid surface, high pressure laminate and palette finishes. The Zola tablet can be fastened to the Zola Lounge & Modular chairs by the Universal Tablet Mount (mounted left or right), to existing legs and features an elliptical shape of 16 1/2" x 11 1/2" x 3/4" in size. The Zola Tablet has a turning radius of 360 degrees, which accommodates any worksurface angle.



## TABLES MATERIALS OPTION

Tables are available in veneer, plastic laminate, and Palette finishes - and an optional Solid Surface top. Tables feature leveling glides on every leg. See 373.



## SOLID SURFACE TOPS

The Solid Surface Top option features Solid Surface material: composed of minerals, acrylic resins and colors, it is a non-porous, scratch and dent-resistant material that does not stain, and does not allow microbes and bacteria to penetrate the surface. Color is throughout the material, so surface scratches are not as visible.



## LINKING TABLES

Zola Linking Tables can be fastened in the field to Zola Modular and Zola Benches with the table to seat bracket without compromising the upholstery. Zola Middle tables have the ability to be easily reconfigured, as they are universal and non-handed. They can be moved to a reverse position in almost any configuration to provide a high level of flexibility when specifying.



## LINKING BRACKETS

The Zola table to seat bracket is made of sturdy, powder-coated steel construction in a Silver Metallic finish to match the legs and casters. This linking bracket is fastened with metal to metal connections from the seat to the table with hardened steel bolts to ensure exceptional durability and strength. Brackets mount underneath, and do not mar or damage the tables or seats. This feature is not available on the Lounge version.



## POWER

The flush-mounted Power unit provides dual power/USB outlets for multiple devices. It can be located on either side of the seat, seat front, (not available on curved fronts) as well as on the front face of tables as standard. See [page 22](#) for locations and [page 83](#) for pricing.



## UNDER-MOUNT POWER

The Under-mount Power unit provides dual power/USB outlets for multiple devices. It can be located below seats and tables. See [page 83](#) for pricing.



## COMBINATION UPHOLSTERY OPTIONS

When combination upholstery is specified with fabric of the same grade or COM, an upcharge for dual fabrics is **\$33 list** per unit and **\$62 list** per unit for three fabrics will be applied. When graded in combination upholstery is selected, use the highest grade upholstery selected or to obtain a quote for blended grading contact Customer Service (please provide the fabrics specified and location of where each fabric is to be applied on the product).

## REPLACEMENT UPHOLSTERY COVERS

Replacement upholstery covers can be easily fitted onto Zola Modular components (with the exception of Zola Curve backs) originally ordered with Removable Upholstery Covers. It is possible to use replacement covers on modular components originally ordered with standard upholstery covers, but this requires some removal of staples and other basic upholstery. Please note that the tailoring of replacement upholstery covers can be less exact and refined in appearance as original upholstery.

## REMOVABLE UPHOLSTERY COVERS

Removable Upholstery Covers are available on most Zola Modular upholstered components, (with the exception of Zola Curve backs) at an upcharge. This feature allows for upholstery covers to be cleaned and disinfected, and allows them to be field-replaced with replacement upholstery covers. Please note that the tailoring of Removable Upholstery Covers can be less exact and refined in appearance than standard upholstery. Replacement and removable covers, (supplied with Velcro) will tailor differently than the permanently stapled upholstery. Overall form and fit is identical, however minor dimensional build up due to the thickness of the velcro can occur. The velcro fastening build up is directed to the least noticeable face (usually the bottom edge of a component) where ever possible.

## MOISTURE BARRIER & CAL 133

California Technical Bulletin 133 is a flammability test for seating. Krug offers a compliance method, in combination with non-flammable upholstery covers, may enable products to meet certification requirements for this test. This process at the same time also provides the products with a Moisture Barrier - a treatment that helps to prevent the passage of liquids and moisture to inside of the upholstered components - thereby conferring sanitary and anti-infection benefits. So when CAL 133 is specified, the product also automatically has a Moisture Barrier, and when a Moisture Barrier is specified, the product also features the compliance method and low flammability features of CAL 133.

The application of this up-charge and the compliance method does not mean that the specific configuration of product and upholstery cover are tested and officially certified as being CAL133 compliant. If the official certification is required, Krug will provide this (through an independent certified testing laboratory) at a charge of \$917 per item, plus the cost of the product to be tested. Lead time for certification testing is typically 4-8 weeks.

Krug assumes no responsibility for the testing of our products in combination with upholstery covers, or for the results of any testing conducted. Some specific configurations of products and upholstery have already been tested. Please contact Customer Service for additional information.

## ZOLA | RECONFIGURABILITY

Zola is designed to enable change: components are inter-changeable, reconfigurable, and replaceable. Metal to metal bracketry and frames are designed for fast, easy reconfiguring, and new components can be added at any time. Its unique leveller provides exceptional levelling capability over large spans, and on uneven floors. Heavy duty casters provide seating with mobility. Each of the 6 sample configurations shown here use exactly the same components - highlighting Zola Modular has the ability to reconfigure again and again, in a myriad of different ways. Joining bracketry is underneath seats and backs, so no surfaces are marred or damaged when connected, and re-connected.

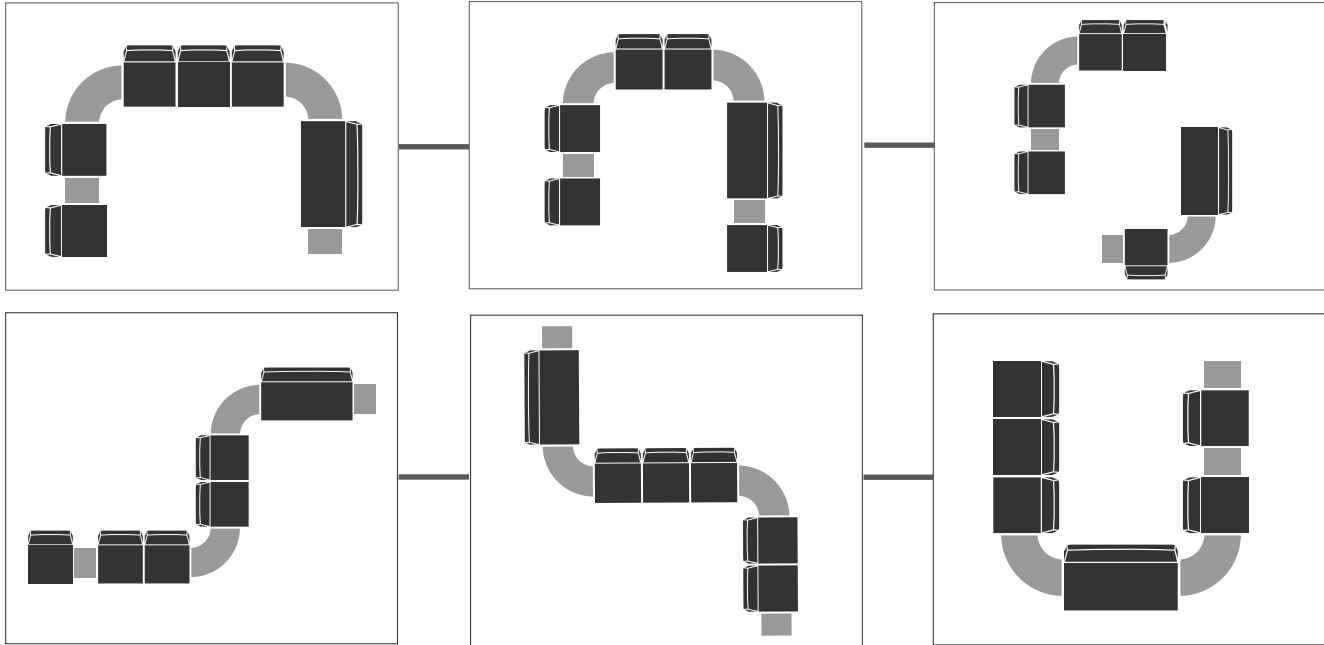

## ZOLA | SEAM LOCATIONS

Due to the curved geometry of the upholstered backs, vertical seams are necessary for quality tailoring of the unit. Patterned Fabrics with "Distinctive details" - such as stripes, squares, straight lines and/or large details, will have noticeable changes in regards to the alignment of the patterns. 90 Degree units -both inside and outside curves are most noticeable. 60, 45 and 30 degree are also subject to this.

Approximate Dimensional Distortions on Patterns:

	Inside Curve	Outside Curve
30 Deg	1 ½"	1"
45 Deg	2"	1 ½"
60 Deg	2 ½"	2"
90 Deg	3"	2 ½"



Zola seat photo indicates location of seam.

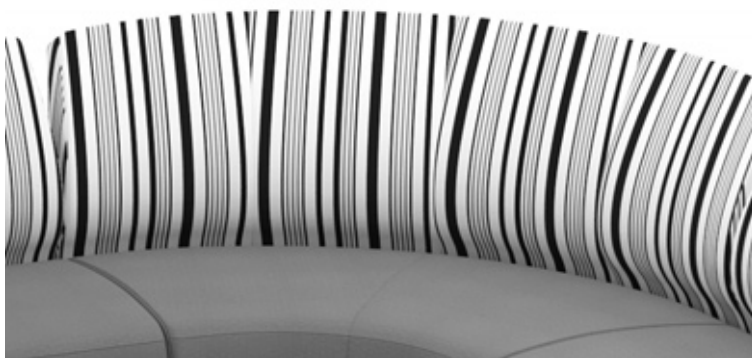

### Inside Curve

Showing colliding stripes at the lumbar portion of the back, and opening stripes at the top and bottom.



### Outside Curve

Showing colliding stripes at the upper and lower portion of the back, with opening stripes at the lumbar.

# ZOLA | SAMPLE CONFIGURATIONS

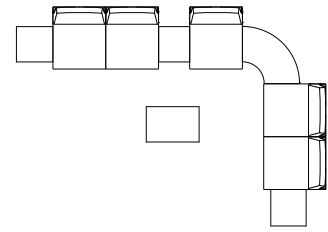
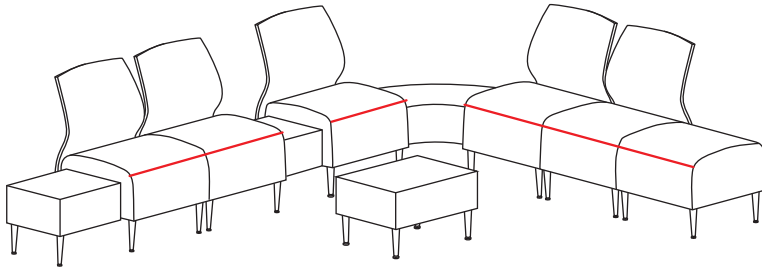

Model	Qty	Price (\$)	Beech
ZOL3 M1201	5	1377	
ZOL3 MS1S1	1	871	
ZOL4 LKM12	1	988	
ZOL4 LKE18	1	1098	
ZOL4 LKC90	1	1283	
ZOL4 241815	1	1187	
<b>Total List</b>		<b>\$12,312</b>	

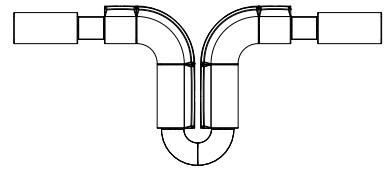
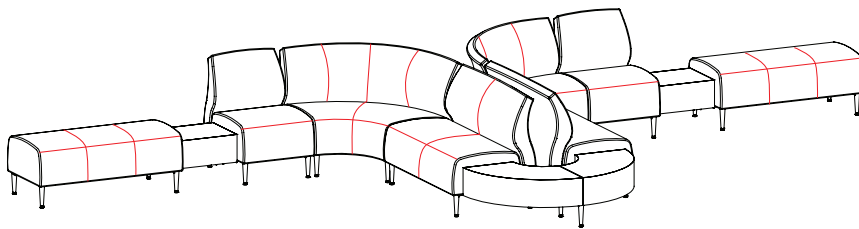

Model	Qty.	Price (\$)
ZOL3 MS2F1	2	1420
ZOL4 LKM18	2	1044
ZOL3 M1101	2	1518
ZOL3 MCIS90D	2	3487
ZOL3 M2101	2	2657
ZOL4 LKC90X2	1	2548
<b>Total List</b>		<b>\$22,800</b>

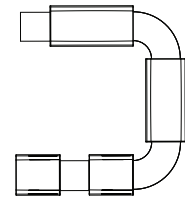
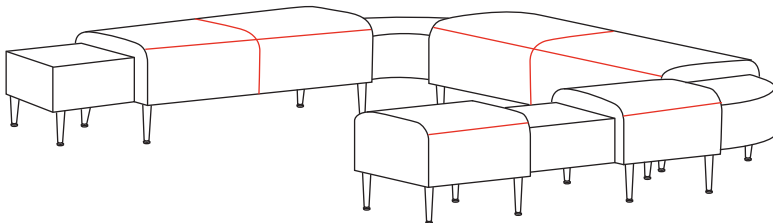

Model	Qty.	Price (\$)
ZOL3 MS1S1	2	871
ZOL3 MS21	2	1218
ZOL4 LKC90	2	1283
ZOL4 LKM18	2	1044
<b>Total List</b>		<b>\$8,832</b>

# ZOLA | LOUNGE

## DIMENSIONS

	Overall Width	Overall Depth	Overall Height	Seat Height	Height of Arms From Floor	Width Between Arms	Seat Depth	Shipping Weight	Cubes
One-Seat	29.25	27	34	18.5	26.75	23	19.25	67	21.5
Two-seat	52.25	27	34	18.5	26.75	46	19.25	90	38
Three-seat	75.25	27	34	18.5	26.75	69	19.25	116	54.5
One-Seat (Plus)	36.25	27	34	18.5	26.75	30	19.25	72	22.6

## COM YARDAGES (Lounge Product Only Available with Arms)

	COM Entire Unit	COM 2 Entire Units	COM 3 Entire Units	COM 4 Entire Units
One-Seat	4	7.25	11.5	14.5
Two-seat	5.5	11	16	21.70
Three-seat	7.1	13.25	19	28
One-Seat (Plus)	4.5	9	13.5	18

## COM YARDAGES (Individual Components)

	COM Yardage Per Seat	COM Yardage Per 2 Seats	COM Yardage Per 3 Seats	COM Yardage Per 4 Seats	COM Yardage Per Back	COM Yardage Per 2 Backs	COM Yardage Per 3 Backs
One-Seat	1.25	2.1	3.35	4.2	1.75	2.75	3.5
Two-seat	1.75	3.4	5.1	6.5	2.5	4.54	6.08
Three-seat	2.5	4.6	7	9	3.5	6.25	9
One-Seat (Plus)	1.25	2.5	3.75	5	1.75	3.5	5.25

## COM YARDAGES (Individual Components)

	COM Yardage Per 4 Backs	COM Yardage Per Arm	COM Yardage Per 2 Arms	COM Yardage Per 3 Arms	COM Yardage Per 4 Arms
One-Seat	5.25	1.5	1.90	2.61	3.3
Two-seat	8.5	1.5	1.90	2.61	3.3
Three-seat	12.5	1.5	1.90	2.61	3.3
One-Seat (Plus)	7	1.5	1.90	2.61	3.3

To calculate the COM Yardage for more than 4 units, take the largest multiple (4 units) and add the closest remainder. See below for example calculations.

- 5 Units = Take the yardage for 4 units and add the yardage for 1 unit
- 6 Units = Take the yardage for 4 units and add the yardage for 2 units
- 7 Units = Take the yardage for 4 units and add the yardage for 3 units
- 8 Units = Take the yardage for 4 units and multiply by 2
- 9 Units = Take the yardage for 4 units, multiply by 2, add yardage for 1 unit
- 10 Units = Take the yardage for 4 units, multiply by 2, add yardage for 2 units
- 20 Units = Take the yardage for 4 units, multiply by 5
- 67 Units = Take the yardage for 4 units, multiply by 16, add yardage for 3 units

## COMBINATION UPHOLSTERY OPTIONS

When combination upholstery is specified with fabric of the same grade or COM, an upcharge for dual fabrics is **\$33 list** per unit and **\$64 list** per unit for three fabrics will be applied. When graded in combination upholstery is selected, use the highest grade upholstery selected or to obtain a quote for blended grading contact Customer Service (please provide the fabrics specified and location of where each fabric is to be applied on the product).

## ORDERING NOTES:

Please note, Zola Lounge chairs are pre-assembled at Krug and cannot be reconfigured into Modular units. Arms and backs cannot be removed from the seat. Zola Lounge chairs cannot be used in conjunction with Zola Linking Tables. Zola Plus Lounge Two-Seats and Three-Seats units have the same dimensions as the Regular Lounge Two-Seats and Three-seats. Zola Lounge chairs are not available with replacement components or covers. These options are only available on the Modular product.

**FEATURES:** For a complete listing of features see [page 3](#).

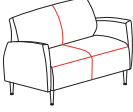
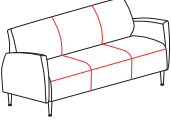

# ZOLA | LOUNGE

DESCRIPTION/MODEL	COM		COL	FABRIC GRADES			LEATHER			
	1	2	3	4	5	6	7	8	9	
	One-Seat ZOL3 F1111	2182	2301	2419	2625	2830	3036	3242	3283	3745
	One-Seat Plus ZOL3 FB1111	2419	2536	2657	2861	3068	3273	3479	3684	3983
<b>NOTE:</b> One-Seat Plus is 30" wide between arms.										
	Two-seat ZOL3 F2111	3223	3376	3517	3739	3960	4182	4401	4623	4971
	Two-seat Plus ZOL3 FB2111	3313	3462	3605	3825	4045	4268	4488	4710	5059
<b>NOTE:</b> The Two-Seat Plus comes standard with a fifth leg for extra support.										
	Three-seat ZOL3 F3111	4379	4602	4821	5263	5708	6149	6594	7036	7793
	Three-seat Plus ZOL3 FB3111	4483	4705	4924	5366	5810	6253	6692	7136	7896
<b>NOTE:</b> The Three-Seat Plus comes standard with a fifth leg for extra support.										

## Zola Option Upcharges

Option	List	Option	A-White	Grades A-Color	B	C
4 Casters (#2 Leg Type below)	107	Solid Surface Arm Cap (per pair)	454	464	489	514
2 Casters/2 Legs (#3 Leg Type below)	77					
Urethane Arm Caps (pair)	242					

**ORDERING NOTES:** See below for caster and arm option selections, please clearly note Urethane or Solid Surface color on the purchase order. See [page 3](#) for more information on Zola options and features. Plus versions are not available with Caster options.

## PRODUCT CODE KEY

Line	Series	Chair Type	Seat Count	Back Type	Arm Type	Leg Type
ZOL Zola	3 Soft Seating	F Freestanding	1 One-Seat	1 Fully Uph Back	1 Uph Arm	1 Standard Leg + Glide
		FB Freestanding Plus Upgrade	2 Two-seat		2 Urethane Arm Cap	2 Casters
			3 Three-seat		3 Solid Surface Arm Cap	3 Combination 2 Front Standard Legs & 2 Rear Casters

# ZOLA | MODULAR

## DIMENSIONS - ARMLESS UNITS

	Overall Width	Overall Depth Uph. Back	Overall Depth Wood Back	Overall Height	Seat Height	Seat Depth	Shipping Weight	Cubes
One-Seat	23	27	24	34	18.5	19.25	57	9.75
Two-seat	46	27	24	34	18.5	19.25	89	17.6
Three-seat	69	27	24	34	18.5	19.25	122	26.3
One-Seat (Plus)	30	27	24	34	18.5	19.25	62	11.5

## DIMENSIONS - WITH ARMS

	Overall Width	Overall Depth	Overall Height	Seat Height	Seat Depth	Shipping Weight	Cubes
One-Seat	29	27	34	18.5	19.25	88	9.75
Two-seat	52	27	34	18.5	19.25	120	17.6
Three-seat	75	27	34	18.5	19.25	154	26.3
One-Seat (Plus)	36	27	34	18.5	19.25	96	11.5

## COM YARDAGES - ARMLESS UNITS

	COM Yardage Entire Unit wo/ Arms	COM Yardage 2 Entire Units wo/ Arms	COM Yardage 3 Entire Units wo/ Arms	COM Yardage 4 Entire Units wo/ Arms
One-Seat	2.2	4.6	6.38	8.8
Two-seat	3.8	7.9	10.75	14.5
Three-seat	5.75	11	16	22
One-Seat (Plus)	3.0	6.3	9.5	13.86

## COM YARDAGES - WITH ARMS

	COM Yardage Entire Unit w/ Arms	COM Yardage 2 Entire Units w/ Arms	COM Yardage 3 Entire Units w/ Arms	COM Yardage 4 Entire Units w/ Arms
One-Seat	4	7.25	11.5	14.5
Two-seat	5.5	11	16	21.7
Three-seat	7.1	13.25	19	28
One-Seat (Plus)	4.5	9	13.5	18.3

## COM YARDAGES - Individual Components

	COM Arms (Left & Right)	COM Yardage Per Back	COM Yardage Per 2 Backs	COM Yardage Per 3 Backs	COM Yardage Per 4 Backs	COM Yardage Per Seat	COM Yardage Per 2 Seats	COM Yardage Per 3 Seats	COM Yardage Per 4 Seats
One-Seat	1.90	1.75	2.75	3.5	5.25	1.25	2.1	3.4	4.2
Two-seat	1.90	2.5	4.5	6.08	8.5	1.7	3.4	5.1	6.5
Three-seat	1.90	3.5	6.25	9	12.5	2.5	4.6	7	9
One-Seat (Plus)	1.90	1.8	3.5	5.25	7	1.25	2.6	3.75	5.5

To calculate the COM Yardage for more than 4 units, take the largest multiple (4 units) and add the closest remainder. See below for example calculations.

- 5 Units = Take the yardage for 4 units and add the yardage for 1 unit
- 6 Units = Take the yardage for 4 units and add the yardage for 2 units
- 7 Units = Take the yardage for 4 units and add the yardage for 3 units
- 8 Units = Take the yardage for 4 units and multiply by 2
- 9 Units = Take the yardage for 4 units, multiply by 2, add yardage for 1 unit
- 10 Units = Take the yardage for 4 units, multiply by 2, add yardage for 2 units
- 20 Units = Take the yardage for 4 units, multiply by 5
- 67 Units = Take the yardage for 4 units, multiply by 16, add yardage for 3 units

Zola Modular Plus Two-Seats and Three-Seats units have the same dimensions as the Regular Modular Two-Seats and Three-seats.

## COMBINATION UPHOLSTERY OPTIONS

When combination upholstery is specified with fabric of the same grade or COM, an upcharge for dual fabrics is **\$33 list** per unit and **\$64 list** per unit for three fabrics will be applied. When graded in combination upholstery is selected, use the highest grade upholstery selected or to obtain a quote for blended grading contact Customer Service (please provide the fabrics specified and location of where each fabric is to be applied on the product).

## PACKAGING

All Modular Units, and tables will be shipped KD (Knocked Down)

## Upcharge for Removable Upholstery Covers:

Option Upcharge	\$ List	Option Upcharge	\$ List
Arms (Right or Left)	77	One-Seat - seat	47
Interim Arm	61	Two-seat - seat	68
One-Seat - back	68	Three-seat - seat	85
Two-seat - back	97	One-Seat Plus - seat	61
Three-seat - back	121		
One-Seat Plus - back	77		

**FEATURES:** For a complete listing of features see 208.

For pricing information on Zola Tables see [page 102](#), Zola Benches see [page 85](#) and Zola Tablets see [page 14](#).

# ZOLA | MODULAR -WOOD BACK



DESCRIPTION/MODEL/SPECIES	COM		COL		FABRIC GRADES			LEATHER			
	1	2	3	4	5	6	7	8	9		
	One-Seat, Wood or Palette Back, Armless										
	ZOL3 MW1201	Beech	1377	1409	1440	1504	1566	1631	1692	1755	1852
		Maple/Cherry	1416	1447	1480	1540	1606	1668	1732	1796	1890
		Palette	1377	1409	1440	1504	1566	1631	1692	1755	1852

	One-Seat, Wood or Palette Back w/ Upholstered Pad, Armless										
	ZOL3 MW1301	Beech	1597	1644	1676	1755	1818	1883	1946	2010	2135
		Maple/Cherry	1638	1685	1715	1796	1858	1922	1985	2048	2173
		Palette	1597	1644	1676	1755	1818	1883	1946	2010	2135

**ORDERING NOTE:** Zola Modular seating with wood backs are designed to be Armless. Zola Modular Arms can be specified on units wood back only as a special, please contact customer service for assistance.

ZOLA OPTION UPCHARGES	\$ List
4 Casters (#2 Leg Type below)	107
2 Casters/2 Legs (#3 Leg Type below)	74

**ORDERING NOTES:** Please note when Zola Modular Chairs are ordered, each chair is automatically supplied with two seat to seat brackets (ZOL3 RLKB2). All Modular Units, and tables will be shipped KD (knocked down).

DESCRIPTION/MODEL	SPECIES	COM		COL		FABRIC GRADES			LEATHER		COM YARDAGE	SHIPPING		
		1	2	3	4	5	6	7	8	9		WEIGHT	CUBES	
	One-Seat Wood/Palette Back w/ UPH Pad													
	ZOL3 MB13	Beech	619	633	648	680	714	744	778	0.6	808	21	853	3.1
		Maple/Cherry	665	680	696	729	760	791	808	0.6	840	21	904	3.1
		Palette	619	633	648	680	714	744	778	0.6	808	25	853	3.1
	One-Seat Wood/Palette Back													
	ZOL3 MB12	Beech	428								-	19	3.1	
		Maple/Cherry	468								-	19	3.1	
		Palette	428								-	23	3.1	

## PRODUCT CODE KEY

Line	Series	Chair Type	Seat Count	Back Type	Arm Type	Leg Type
ZOL Zola	3 Soft Seating	MW Modular Wood Back	1 One-Seat	2 Wood Back 3 Wood Back with Uph Pad	0 Armless	1 Standard Leg + Glide 2 Casters 3 Combination 2 Front Standard Legs & 2 Rear Casters

# ZOLA | MODULAR

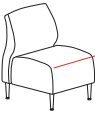
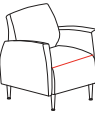
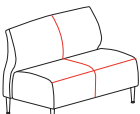
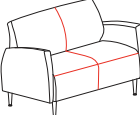
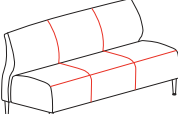
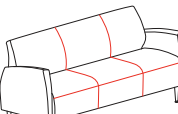
DESCRIPTION/MODEL	COM		COL	FABRIC GRADES				LEATHER			
	1	2	3	4	5	6	7	8	9		
	One-Seat, Upholstered Back Armless ZOL3 M1101	n/a	1518	1597	1676	1818	1960	2105	2244	2387	2640
	One-Seat Plus, Upholstered Back, Armless ZOL3 MB1101	n/a	1644	1692	1772	1914	2056	2197	2341	2483	2738
<b>ORDERING NOTES:</b> One-Seat Plus seat is 30" wide.											
	One-Seat, Upholstered Back with Arms ZOL3 M1111		2324	2443	2554	2760	2964	3167	3376	3580	3890
	One-Seat Plus, Upholstered Back with Arms ZOL3 MB1111		2451	2568	2681	2884	3092	3294	3501	3708	4014
<b>ORDERING NOTES:</b> One-Seat Plus is 30" wide between the arms.											
	Two-seat, Upholstered Back Armless ZOL3 M2101	n/a	2657	2806	2948	3167	3390	3610	3831	4057	4401
	Two-seat Plus, Upholstered Back, Armless ZOL3 MB2101	n/a	2743	2893	3036	3257	3477	3699	3920	4142	4488
	Two-seat, Upholstered Back with Arms ZOL3 M2111		3462	3610	3756	3977	4197	4420	4639	4861	5210
	Two-seat Plus, Upholstered Back with Arms ZOL3 MB2111		3547	3699	3843	4064	4286	4505	4728	4948	5296
	Three-seat, Upholstered Back Armless ZOL3 M3101		3812	4033	4252	4694	5139	5581	6023	6466	7225
	Three-seat Plus Upholstered Back Armless ZOL3 MB3101		3914	4133	4355	4796	5241	5684	6124	6568	7327
	Three-seat, Upholstered Back with Arms ZOL3 M3111	n/a	4615	4838	5059	5502	5943	6387	6829	7270	8031
	Three-seat Plus Upholstered Back with Arms ZOL3 MB3111	n/a	4719	4941	5160	5604	6046	6491	6931	7373	8131



**ORDERING NOTES:** See below for caster and arm option selections, please clearly note Urethane or Solid Surface color selection on the purchase order. Two-seat & Three-seat Plus versions are with a fifth leg or support. Plus versions are not available with Caster options. Please note when Zola Modular Chairs are ordered, each chair is automatically supplied with two seat to seat brackets (ZOL3 RLKB2). All Modular Units, and tables will be shipped KD (knocked down).

Zola Option Upcharges	List	Option	Grades			
			A-White	A-Color	B	C
4 Casters (#2 Leg Type below)	107	Solid Surface Arm Cap (per arm)	227	231	244	257
2 Casters/2 Legs (#3 Leg Type below)	77	Solid Surface Arm Cap (per pair)	454	464	489	514
Urethane Arm Caps (pair)	242	Solid Surface Arm Cap - Interim (per arm)	185	186	189	193

## PRODUCT CODE KEY

Line	Series	Chair Type	Seat Count	Back Type	Arm Type	Leg Type
ZOL	3	M	1	1	0	1
Zola	Lounge	Modular	One-Seat	Fully Uph Back	Armless	Standard Leg + Glide
		MB	2		1	2
		Modular Plus Upgrade	Two-seat		Uph Arm	4 Casters
			3		2	3
			Three-seat		Urethane Arm Cap	Combination 2 Front Standard Legs & 2 Rear Casters
					3	
					Solid Surface Arm Cap	

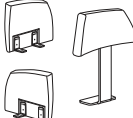
## ZOLA | MODULAR BACKS & ARMS

DESCRIPTION/MODEL	COM		COL	FABRIC GRADES			LEATHER			COM	SHIPPING	
	1	2	3	4	5	6	7	8	9	YARDAGE	WEIGHT	CUBES
 Left, Right, or Interim Arm ZOL3 MAL ZOL3 MAR ZOL3 MAI	491	532	569	651	729	808	886	963	1074	1.5	19	3.1
	348	365	381	411	444	477	509	538	586	0.33	13	1.8
	Left, Right, or Interim Arm - Urethane Cap											
 ZOL3 MALU ZOL3 MARU ZOL3 MAIU	619	658	696	778	853	934	1014	1092	1202	1.5	20.5	3
	443	457	476	497	537	568	599	632	678	0.33	13	1.8

### ORDERING NOTES:



The Interim Arm was designed to fit in between two seating units and therefore shortens the width between arms by 1" per seating unit. The interim Arm does not compromise the overall width of the combined benches. Zola Arms (left or right) are specified when seated. To specify Solid Surface Arm Cap add a "3" to the end of the model above, example ZOL3 MAL3, and clearly state color choice. (See [page 116](#) for color selection)

Option	Grades			
	A-White	A-Color	B	C
Solid Surface Arm Cap (per arm)	227	231	244	257
Solid Surface Arm Cap (per pair)	454	464	489	514
Solid Surface Arm Cap - Interim (per arm)	185	186	189	193

DESCRIPTION/MODEL	SPECIES	COM		COL	FABRIC GRADES			LEATHER			COM	SHIPPING	
		1	2	3	4	5	6	7	8	9	YARDAGE	WEIGHT	CUBES
 UPH Back ZOL3 MB11* ZOL3 MB21 ZOL3 MB31 ZOL3 MBB11		783	846	910	1036	1164	1289	1572	1699	1852	1.75	23	5.2
		1030	1116	1202	1377	1551	1724	1897	2072	2278	2.5	39	9.4
		1251	1359	1473	1692	1913	2135	2356	2579	2847	3.5	54	14
		871	934	997	1122	1251	1377	1504	1631	1796	2	28	6.1



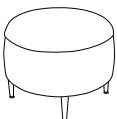

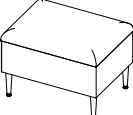



**ORDERING NOTES:** The Two-seat & Three-seat Upholstered Backs are used for the Two-seat & Three-seat Plus units as well. Only Upholstered Backs can be used on Plus units.

## ZOLA | SEATABLES

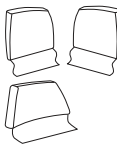

DESCRIPTION	MODEL	COM		COL	FABRIC GRADES			LEATHER			COM	WEIGHT	CUBE
		1	2	3	4	5	6	7	8	9	YARDAGE		
 Round Seatable ZOL5-18D ZOL5-24D ZOL5-30D		693	716	739	771	809	843	879	928	974	1.3	18	5.2
		894	943	994	1064	1143	1215	1297	1396	1497	1.5	26	8.5
		1124	1181	1240	1318	1412	1492	1583	1695	1810	1.7	38	10.5
	 Square Seatable ZOL5-1818 ZOL5-2424		759	805	848	912	984	1048	1120	1210	1303	1.3	27
		905	956	1004	1074	1155	1227	1307	1408	1508	1.5	38	8.5
 Rectangular Seatable ZOL5-2418 ZOL5-4824			832	875	921	985	1059	1120	1194	1284	1374	1.3	31
		1178	1240	1303	1389	1487	1572	1672	1798	1922	2.4	62	12.6

**ORDERING NOTES:** Height from floor is 17.5".

# ZOLA | MODULAR - REPLACEMENT COMPONENTS

DESCRIPTION/MODEL	SPECIES	COM		COL	FABRIC GRADES			LEATHER		COM YARDAGE	SHIPPING			
		1	2	3	4	5	6	7	8		9	WEIGHT	CUBES	
	Replacement Modular One-Seat Wood Back													
	ZOL3 RBM12	Beech	365								-	19	3.1	
		Maple/Cherry	405								-	19	3.1	
		Palette	365								-	23	3.1	
	Replacement Modular One-Seat Wood Back w/ Upholstered Pad													
	ZOL3 RBM13	Beech	556	569	586	619	651	680	714	744	791	0.6	21	3.1
		Maple/Cherry	601	619	633	665	696	729	744	778	840	0.6	21	3.1
		Palette	556	569	586	619	651	680	714	744	791	0.6	25	3.1
		Replacement Back Pad -only ZOL3 RP	223	239	255	284	318	348	381	411	458	0.6	1.6	2
	Replacement Upholstered Back													
	ZOL3 RBM11*		721	783	846	974	1098	1227	1510	1638	1788	1.75	23	5.2
	ZOL3 RBM21		963	1053	1139	1314	1485	1662	1835	2010	2214	2.5	39	9.4
	ZOL3 RBM31		1187	1297	1409	1631	1852	2072	2294	2516	2781	3.5	54	14
	ZOL3 RBBM11		808	871	934	1061	1187	1314	1440	1566	1732	2	28	6.1
<b>ORDERING NOTES:</b> Modular Upholstered Replacement Backs are supplied with velcro upholstery that allows for assembly of existing "L" brackets on site prior to assembly to the bench. Replacement Backs do not include mounting brackets and legs and Replacement Seat/Benches do not include legs and joining brackets. The hardware can be transferred from the original component to the replacement component. If new hardware is required, Modular Arms/Backs/Benches should be ordered.														
	Right or Left Replacement Upholstered Arm													
	ZOL3 RAMR		435	477	514	595	672	752	832	910	1019	1.5	14	3
	ZOL3 RAML													
	ZOL3 RAMRU		562	601	641	721	799	878	957	1036	1146	1.5	15.5	3
	ZOL3 RAMLU													
<b>ORDERING NOTES:</b> Zola Replacement arms (left or right) are specified when seated. Replacement Modular Arms are sent without modular hardware. Replacement Arms do not include mounting brackets. ZOL3 RAMRU & ZOL3 RAMLU are replacement arms with urethane cap. Zola replacement arms are available with Solid Surface Arm Caps, see option upcharge chart on <a href="#">page 12</a> . Wood back units are not designed to be specified with standard Zola arms. Arms can be specified on wood back units only as a special - please contact Customer Service for assistance.														
	Replacement Upholstered Seat													
	ZOL3 RSM1*		778	822	871	957	1044	1134	1218	1305	1482	1.33	25	5.2
	ZOL3 RSM2		1122	1178	1232	1354	1473	1589	1708	1827	2024	1.75	39	9.4
	ZOL3 RSM3		1463	1540	1620	1788	1954	2118	2283	2451	2657	2.5	50	14
	ZOL3 RSMB1		1004	1053	1098	1195	1289	1384	1480	1572	1715	1.75	26	6.1
	ZOL3 RSMB2		1202	1266	1330	1447	1566	1685	1803	1922	2118	1.75	39	9.4
	ZOL3 RSMB3		1755	1835	1914	2056	2197	2341	2483	2625	2847	2.5	50	14
	Back Cover													
	ZOL3 RCB1*		302	365	428	556	680	808	934	1061	1266	2	2.8	1.7
	ZOL3 RCB2		411	509	601	791	982	1170	1359	1551	1788	3	3.6	1.7
	ZOL3 RCB3		509	633	760	1014	1266	1518	1772	2024	2341	3.75	4.3	1.7
	ZOL3 RCBB1		336	397	458	586	714	840	963	1092	1283	2	2.8	1.7
	Arm Covers Right, Left or Interim													
	ZOL3 RCAR		270	318	365	458	556	651	744	840	963	1.5	2.5	1.7
	ZOL3 RCAL													
	ZOL3 RCAI		176	190	207	239	270	302	334	365	405	0.33	1.5	1.7
	ZOL3 RCARU ZOL3 RCALU		270	318	365	458	556	651	744	840	963	1.5	2.5	1.7
<b>ORDERING NOTES:</b> Replacement Arm Covers (left or right) are specified as seated. ZOL3 RCARU & ZOL3 RCALU are arm covers for arms with the urethane arm cap option.														
	Seat Cover													
	ZOL3 RCS1*		270	318	365	458	556	651	744	840	982	1.33	2.3	1.7
	ZOL3 RCS2		348	411	477	601	729	853	982	1108	1314	1.75	2.6	1.7
	ZOL3 RCS3		444	521	601	680	760	840	916	997	1122	2.5	3.8	1.7
	ZOL3 RCSB1		411	468	521	633	744	853	963	1074	1232	1.75	2.6	1.7

# ZOLA | MODULAR - REPLACEMENT COMPONENTS & TABLETS

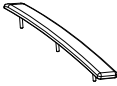
DESCRIPTION/MODEL	PRICE	SHIPPING WEIGHT	CUBES
 Caster Without Brake ZOL3 RC1	58	0.4	0125
<b>ORDERING NOTE:</b> Casters cannot be ordered as replacement items for plus units.			
 Caster With Brake ZOL3 RC2	70	0.4	0.125
<b>ORDERING NOTE:</b> Casters cannot be ordered as replacement items for plus units.			
 Urethane Arm Cap ZOL3 AUR	127	1.5	0.3
ZOL3 AUL		1.5	0.3
Urethane Arm Cap - Interim Arm ZOL3 AIU	94	1.0	0.3

	Grades				SHIPPING WEIGHT	CUBES
	A-White	A-Color	B	C		
 Solid Surface Arm Cap (per arm) ZOL3 ASR	227	231	244	257	1.5	0.3
ZOL3 ASL						
Solid Surface Arm Cap - Interim (per arm) ZOL3 ASI	185	186	189	193	1.0	0.3

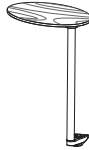
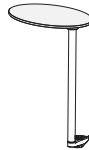
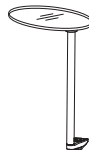
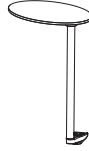
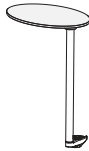
DESCRIPTION	MODEL	SPECIES	PRICE	WEIGHT	CUBE
 Wood Tablet ZOL3 T1		Beech Maple /Cherry	514 538	12	2
 Tablet with Palette Finish ZOL3 T2		n/a	411	12	2
 Clear Glass Tablet ZOL3 T3		n/a	783	13	2
 Laminate Tablet ZOL3 T4		n/a	532	12	2
<b>ORDERING NOTES:</b> The laminate tablet comes standard with a polymer edge. Please note Zola Tablets are universally handed and do not need to be specified right or left when ordering.					
	Solid Surface Tablet - Grade A White ZOL3 T5AW	n/a	641	14	2
	Solid Surface Tablet - Grade A Color ZOL3 T5AC	n/a	651	14	2
	Solid Surface Tablet - Grade B ZOL3 T5B	n/a	686	14	2
	Solid Surface Tablet - Grade C ZOL3 T5C	n/a	741	14	2

# ZOLA | MODULAR CURVE

## DIMENSIONS INSIDE CURVE

	Overall Width	Overall Depth	Overall Height	Seat Height	Seat Depth	Shipping Weight	Cubes
<b>Single seat</b>							
30°	36	28.5	34	18.5	22.5	50	18
45°	42	29	34	18.5	22.5	54	19
60°	48	29	34	18.5	22.5	57	22
90°	59	31	34	18.5	22.5	69	26
<b>Double seat</b>							
30°	58	30	34	18.5	22.5	90	32
45°	64	31	34	18.5	22.5	97.2	33
60°	70	33	34	18.5	22.5	102.6	39
90°	81	36	34	18.5	22.5	124.2	46

## COM Yardages

	COM Yardage Entire Unit	COM Yardage 2 Entire Units	COM Yardage 3 Entire Units	COM Yardage 4 Entire Units
<b>Single seat</b>				
30°	3.70	7.4	11.1	14.8
45°	4.40	8.8	13.2	17.6
60°	4.40	8.8	13.2	17.6
90°	4.61	9.2	13.83	18.44
<b>Double seat</b>				
30°	6.3	12.6	18.9	25.2
45°	6.4	12.8	19.2	25.6
60°	8.2	16.4	24.6	32.8
90°	8.2	16.4	24.6	32.8

## COM Yardages - Individual Components

	COM Yardage Per Back	COM Yardage Per 2 Backs	COM Yardage Per 3 Backs	COM Yardage Per 4 Backs	COM Yardage Per Seat	COM Yardage Per 2 Seats	COM Yardage Per 3 Seats	COM Yardage Per 4 Seats
<b>Single seat</b>								
30°	1.9	3.8	5.7	7.6	1.8	3.6	5.4	7.2
45°	2.6	5.2	7.8	10.4	1.8	3.6	5.4	7.2
60°	2.6	5.2	7.8	10.4	1.8	3.6	5.4	7.2
90°	2.8	5.6	8.4	11.2	1.8	3.6	5.4	7.2
<b>Double seat</b>								
30°	2.9	5.8	8.7	11.6	3.4	6.8	10.2	13.6
45°	3	6.0	9.0	12.0	3.4	6.8	10.2	13.6
60°	4.8	8.8	13.5	17.4	3.4	6.8	10.2	13.6
90°	4.8	8.8	13.5	17.4	3.4	6.8	10.2	13.6

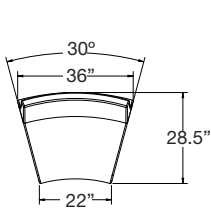

Single Seat, Uph 30° Inside Curve

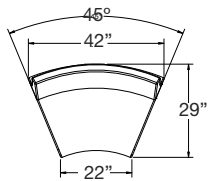

Single Seat, Uph 45° Inside Curve

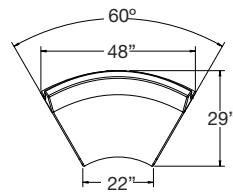

Single Seat, Uph 60° Inside Curve

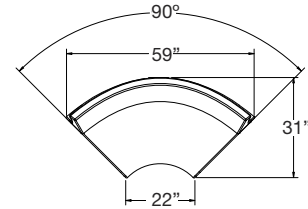

Single Seat, Uph 90° Inside Curve

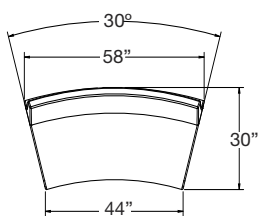

Double Seat, Uph 30° Inside Curve

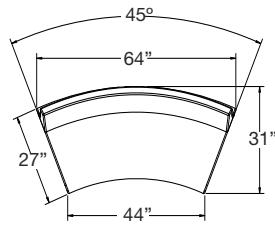

Double Seat, Uph 45° Inside Curve

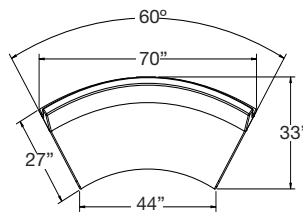

Double Seat, Uph 60° Inside Curve

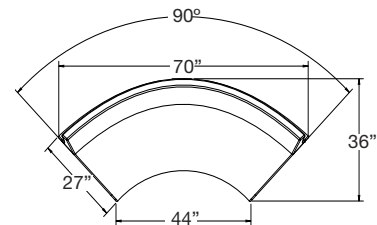

Double Seat, Uph 90° Inside Curve

## Upcharge for Removable Upholstery Covers:

Option	\$ List	Option	\$ List
Single-seat curve 30° seat	61	Double-seat curve 30° seat	93
Single-seat curve 45° seat	64	Double-seat curve 45° seat	101
Single-seat curve 60° seat	86	Double-seat curve 60° seat	123
Single-seat curve 90° seat	113	Double-seat curve 90° seat	127



## DIMENSIONS OUTSIDE CURVE

	Overall Width	Overall Depth	Overall Height	Seat Height	Seat Depth	Shipping Weight	Cubes
<b>Single seat</b>							
30°	33.75	28.25	34	18.5	22.5	48	23
45°	38.75	28.75	34	18.5	22.5	49	24
60°	43.5	29.25	34	18.5	22.5	50	29
90°	52	29.75	34	18.5	22.5	51	34
<b>Double seat</b>							
30°	55.75	29.75	34	18.5	22.5	83	36
45°	60.75	31	34	18.5	22.5	84	40
60°	65.75	32.25	34	18.5	22.5	86	45
90°	74	34.5	34	18.5	22.5	96	56

## COM Yardages

	COM Yardage Entire Unit	COM Yardage 2 Entire Units	COM Yardage 3 Entire Units	COM Yardage 4 Entire Units
<b>Single seat</b>				
30°	3.32	6.14	9.46	12.28
45°	3.32	6.14	9.46	12.28
60°	3.32	6.14	9.46	12.28
90°	3.32	6.14	9.46	12.28
<b>Double seat</b>				
30°	6.50	13.0	19.5	26.0
45°	6.50	13.0	19.5	26.0
60°	6.50	13.0	19.5	26.0
90°	6.50	13.0	19.5	26.0

## COM Yardages - Individual Components

	COM Yardage Per Back	COM Yardage Per 2 Backs	COM Yardage Per 3 Backs	COM Yardage Per 4 Backs	COM Yardage Per Seat	COM Yardage Per 2 Seats	COM Yardage Per 3 Seats	COM Yardage Per 4 Seats
<b>Single seat</b>								
30°	1.7	2.95	4.65	5.9	1.8	3.6	5.4	7.2
45°	1.7	2.95	4.65	5.9	1.8	3.6	5.4	7.2
60°	1.7	2.95	4.65	5.9	1.8	3.6	5.4	7.2
90°	1.7	2.95	4.65	5.9	1.8	3.6	5.4	7.2
<b>Double seat</b>								
30°	3.1	6.2	9.3	12.4	3.4	6.8	10.2	13.6
45°	3.1	6.2	9.3	12.4	3.4	6.8	10.2	13.6
60°	3.1	6.2	9.3	12.4	3.4	6.8	10.2	13.6
90°	3.1	6.2	9.3	12.4	3.4	6.8	10.2	13.6
6.8	10.2	13.6						

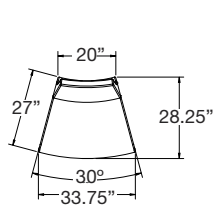

Single Seat, Uph 30° Outside Curve

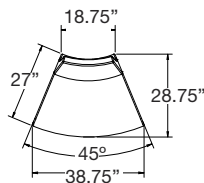

Single Seat, Uph 45° Outside Curve

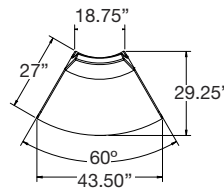

Single Seat, Uph 60° Outside Curve

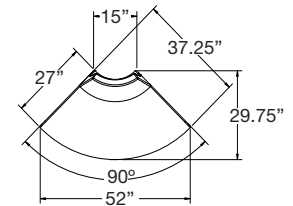

Single Seat, Uph 90° Outside Curve

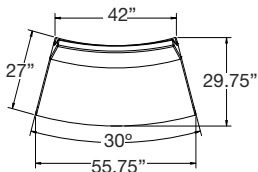

Double Seat, Uph 30° Outside Curve

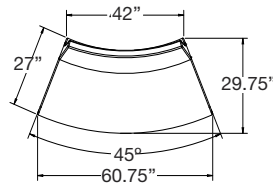

Double Seat, Uph 45° Outside Curve

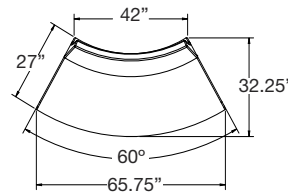

Double Seat, Uph 60° Outside Curve

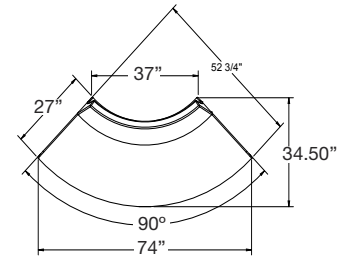







Double Seat, Uph 90° Outside Curve

## Upcharge for Removable Upholstery Covers:

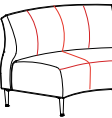
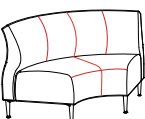
Option	\$ List	Option	\$ List
Single-seat curve 30° seat	61	Double-seat curve 30° seat	93
Single-seat curve 45° seat	64	Double-seat curve 45° seat	101
Single-seat curve 60° seat	86	Double-seat curve 60° seat	123
Single-seat curve 90° seat	113	Double-seat curve 90° seat	127

# ZOLA | MODULAR CURVE

DESCRIPTION/MODEL	COM		COL		FABRIC GRADES			LEATHER		
	1	2	3	4	5	6	7	8	9	
	Single-Seat, 30° Inside Curve ZOL3 MCIS30D1	2302	2432	2559	2741	2947	3131	3336	3592	3851
	Single-Seat, 30° Inside Curve Plus ZOL3 MCBIS30D1	2399	2530	2657	2838	3045	3226	3432	3691	3949
	Single-Seat, 45° Inside Curve ZOL3 MCIS45D1	2709	2873	3038	3271	3538	3770	4037	4369	4704
	Single-Seat, 45° Inside Curve Plus ZOL3 MCBIS45D1	2818	2984	3147	3383	3648	3880	4146	4480	4813
	Single-Seat, 60° Inside Curve ZOL3 MCIS60D1	3069	3235	3399	3634	3899	4131	4397	4730	5063
	Single-Seat, 60° Inside Curve Plus ZOL3 MCBIS60D1	3193	3358	3523	3759	4024	4257	4522	4855	5188
	Single-Seat, 90° Inside Curve ZOL3 MCIS90D1	3487	3696	3904	4196	4530	4821	5155	5574	5993
	Single-Seat, 90° Inside Curve Plus ZOL3 MCBIS90D1	3652	3862	4068	4362	4694	4987	5320	5740	6159
	Single-Seat, 30° Outside Curve ZOL3 MCOS30D1	2072	2190	2304	2465	2654	2817	3001	3235	3465
	Single-Seat, 30° Outside Curve Plus ZOL3 MCBOS30D1	2169	2286	2403	2564	2748	2913	3097	3331	3562
	Single-Seat, 45° Outside Curve ZOL3 MCOS45D1	2436	2586	2738	2946	3185	3395	3634	3934	4233
	Single-Seat, 45° Outside Curve Plus ZOL3 MCBOS45D1	2546	2696	2847	3056	3294	3505	3743	4044	4341
	Single-Seat, 60° Outside Curve ZOL3 MCOS60D1	2763	2911	3061	3270	3510	3718	3958	4258	4557
	Single-Seat, 60° Outside Curve Plus ZOL3 MCBOS60D1	2888	3036	3187	3396	3635	3844	4083	4381	4681
	Single-Seat, 90° Outside Curve ZOL3 MCOS90D1	3137	3323	3513	3774	4077	4340	4641	5017	5393
	Single-Seat, 90° Outside Curve Plus ZOL3 MCBOS90D1	3303	3489	3679	3940	4242	4506	4809	5183	5559

**ORDERING NOTES:** Please note when Zola Modular Chairs are ordered, each chair is automatically supplied with two seat to seat brackets (ZOL3 RLKB2). All Modular Units, and tables will be shipped KD (knocked down).

## PRODUCT CODE KEY

Line	Series	Chair Type	Curve Style	Seat Count	Seat Degree	Leg Type
ZOL	3	MC	I	S	30D	1
Zola	Soft Seating	Modular	Inside Curve	Single	30 Degree	Standard Leg + Glide
		MCB	O	D	45D	
		Modular Plus Upgrade	Outside Curve	Double	45 Degree	
					60D	
					60 Degree	
					90D	
					90 Degree	

# ZOLA | MODULAR CURVE

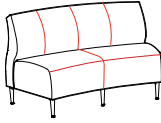
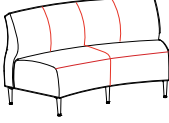
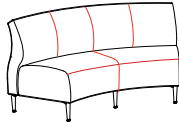
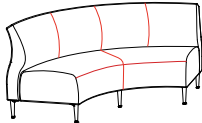
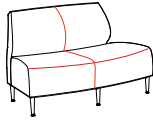
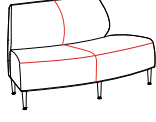
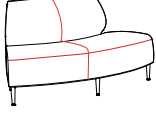
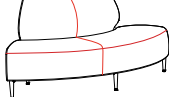
DESCRIPTION/MODEL	COM		COL		FABRIC GRADES			LEATHER	
	1	2	3	4	5	6	7	8	9
 Double-Seat, 30° Inside Curve ZOL3 MCID30D1	4028	4252	4481	4795	5157	5473	5836	6289	6739
	4182	4405	4633	4947	5309	5628	5989	6441	6893
 Double-Seat, 45° Inside Curve ZOL3 MCID45D1	4736	5028	5318	5722	6188	6598	7064	7644	8225
	4917	5209	5497	5903	6369	6778	7242	7822	8406
 Double-Seat, 60° Inside Curve ZOL3 MCID60D1	5367	5659	5948	6357	6821	7229	7696	8276	8858
	5560	5852	6141	6549	7016	7421	7888	8469	9051
 Double-Seat, 90° Inside Curve ZOL3 MCID90D1	6099	6465	6831	7342	7925	8438	9022	9755	10485
	6319	6686	7049	7564	8146	8658	9244	9975	10705
 Double-Seat, 30° Outside Curve ZOL3 MCOD30D1	3626	3828	4033	4316	4643	4928	5254	5659	6069
	3777	3980	4185	4468	4795	5080	5405	5811	6221
 Double-Seat, 45° Outside Curve ZOL3 MCOD45D1	4263	4525	4786	5152	5571	5938	6357	6881	7402
	4442	4706	4966	5331	5751	6117	6536	7060	7582
 Double-Seat, 60° Outside Curve ZOL3 MCOD60D1	4831	5093	5355	5720	6139	6506	6925	7447	7971
	5023	5286	5548	5914	6333	6699	7119	7641	8164
 Double-Seat, 90° Outside Curve ZOL3 MCOD90D1	5488	5819	6146	6607	7134	7594	8121	8781	9438
	5708	6039	6366	6828	7356	7815	8342	8999	9657

**ORDERING NOTES:** Please note when Zola Modular Chairs are ordered, each chair is automatically supplied with two seat to seat brackets (ZOL3 RLKB2). All Modular Units, and tables will be shipped KD (knocked down).

## PRODUCT CODE KEY

Line	Series	Chair Type	Curve Style	Seat Count	Seat Degree	Leg Type
ZOL	3	MC	I	S	30D	1
Zola	Soft Seating	Modular	Inside Curve	Single	30 Degree	Standard Leg + Glide
		MCB	O	D	45D	
		Modular Plus Upgrade	Outside Curve	Double	45 Degree	
					60D	
					60 Degree	
					90D	
					90 Degree	

# ZOLA PRIVACY | ENVIRONMENTAL SUMMARY

## LEED CI CREDIT



MATERIAL CONTENT:

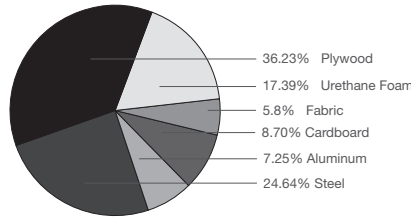

PRE-CONSUMER RECYCLED CONTENT = 6.34%

POST-CONSUMER RECYCLED CONTENT = 14.09%

Up to 40.58% of this Zola product is recyclable at the end of its useful life.

CONTRIBUTES TO		
CREDIT 2.1 - 2.2	Construction Waste Management	1-2 point(s)
CREDIT 3.3	Resource Reuse	1 point
CREDIT 4.1	Recycled Content	1 point
CREDIT 4.5	Low Emitting Materials, Systems & Seating	1 point
CREDIT 5.1	Regional Materials*	1 point
CREDIT 7	Certified Wood (MUST BE REQUESTED)	1 point(s)

\*This credit is only applicable if in total 20% of the combined value of the procurement of construction materials and in the furniture are manufactured within a radius of 500 miles. This credit will apply if the installation of the finished product occurs within 500 miles of Kitchener, Ontario.

## level® CERTIFICATION & AIR EMISSIONS CERTIFICATION



### level® CERTIFICATION

BIFMA's e3 Furniture Sustainability Standard is a voluntary, multi-attribute standard that measures the degree of sustainability of furniture. This standard evaluates product and company environmental attributes and compliance systems in a wide range of elements which include Materials, Energy & Atmosphere, Human & Ecosystem Health and Social Responsibility. Zola Privacy products have earned level®, BIFMA's sustainability certification program for furniture, certification through third-party verification against the e3 standard.



The mark of responsible forestry

### AIR EMISSIONS

All Zola Privacy products are supplied air-emissions certified. Contact customer service for information.

### FSC®

In 2005, Krug received Forest Stewardship Council® (FSC®) Chain-of-Custody certification for our manufacturing facilities. The FSC® Chain-of-Custody tracks certified wood from seedling to final sale. It verifies that the material for our FSC® certified products only come from well-managed, FSC®-certified forests and other controlled sources. FSC® is dedicated to the promotion of responsible forest management worldwide helping to take care of forests for future generations. Jordan and other Krug products can be specified with FSC® Certification. Contact customer service for further information, pricing and lead times.



Architects, designers, and building professionals can specify FSC®-certified products in order to achieve a point from the US Green Building Council's Leadership in Energy and Environmental Design (LEED) Rating System.

# ZOLA PRIVACY | FEATURES & OPTIONS

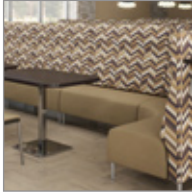

## REPLACEABILITY

Zola is built to last: its heavy-duty structure is designed for intensive use environments. When any component is damaged or degraded, it can be easily changed out on its own, instead of having to replace or repair an entire unit. Along with its use of recycled and recyclable materials, the replaceability of components means Zola can provide exceptional long-term value, and be an investment in sustainability.

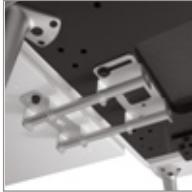

## RECONFIGURABILITY

Zola is designed to enable change: components are inter-changeable, reconfigurable, and replaceable. Metal-to-metal brackets are designed for fast, easy reconfiguring, that does not damage or degrade the product, and new components can be added and added with ease. Arms can be added and reconfigured to either side of the unit. Its unique leveler provides exceptional leveling capability over large spans, and on uneven floors.



## PRECONFIGURED

Zola Privacy can be specified in select preconfigured stand-alone arrangements. The offering includes one, two and three seat units in both Mid Height and Full Height styles. The units are pre-assembled with either full depth or semi-private side panels.



## INTENSIVE USE ENVIRONMENTS

Zola has been designed for healthcare and other intensive use environments, with some important features: removable and replaceable upholstery covers, an anti-microbial finish, the option of a urethane arm cap and a standard clean-out between the seat and back. Modular construction allows for complete cleaning and disinfecting of the entire unit, and air emissions certification, make Zola an excellent solution for healthy spaces and care-giving environments. Plus styles are included in the offering.



## BACK CONNECTION

The Zola Privacy back linking connectors are made of sturdy steel construction. It is a two part bracket fastened with metal-to-metal connections. Brackets are not visible when units are linked. Linked backs can only be reconfigured in the same start/center/end positions.



## LINKING SEAT-TO-SEAT

The Zola seat-to-seat linking bracket is powder-coated steel construction in a black finish. This linking bracket is fastened with metal-to-metal connections from the seat to another seat with hardened steel bolts to ensure exceptional durability and strength. Brackets mount underneath, and do not mar or damage the tables or seats.



## LINKING TABLE-TO-SEAT

The Zola table-to-seat bracket is powder-coated steel in a Silver Metallic finish to match the legs and casters. This linking bracket is fastened with metal-to-metal connections from the seat to the table.



## CLEAN OUT

Zola Lounge chairs have a built-in clean out feature: a space at the back of the seat that allows liquid, dirt and debris to fall to the floor for easy clean up and maintenance. The clean out feature was designed so that it does not detract from the comfort or appearance of the product.



## LEGS

The legs offered on Zola Lounge are Silver Metallic or Matte Black and feature glides that are adjustable up to 1.25", which provide leveling capability over longer spans. Caster leg is not available.



## TWIN BACK

Zola Privacy is available in unique Twin Back models for both straight and curves styles. The one piece back-to-back design provides a clean, minimal solution for space division and maximizing seating.

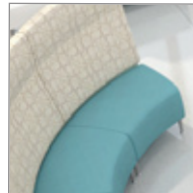

## COMBINATION UPHOLSTERY OPTIONS

When combination upholstery is specified with fabric of the same grade or COM, an upcharge for dual fabrics is **\$33 list** per unit and **\$64 list** per unit for three fabrics will be applied. When graded in combination upholstery is selected, use the highest grade upholstery selected or to obtain a quote for blended grading contact Customer Service (please provide the fabrics specified and location of where each fabric is to be applied on the product).



## ANTI-MICROBIAL FINISH

Zola wood surfaces come with an anti-microbial finish that inhibits the growth of some molds and mildews. Surfaces coated in this finish support the reduction of fungal growth, and spores from germs, microbes and bacteria.

## FINISH DURABILITY

Krug's finish, a proprietary catalyzed varnish formulation, has been repeatedly shown, through independent laboratory testing, to be the industry leader in durability and abrasion resistance. The Krug finish looks better longer than competitors, and is uniquely suited to the demands of high traffic environments.

## PLUS UPGRADE

Zola seating is available with optional Plus Upgrade. Plus Seating has been engineered to support higher weight capacities, accommodating a wider variety of users.

## WEIGHT CAPACITIES

Zola weight capacities are as follows:

- One-Seat (Straight or curved) - 300 lbs
- One-Seat plus - 750 lbs
- Two-seat (Straight or curved)- 525lbs
- Two-seat plus - 975 lbs
- Three-seat - 750 lbs
- Three-seat plus - 1150 lbs

## ZOLA PRIVACY | OPTIONS



### PRIVACY SCREEN

Zola Privacy Screens are made of durable frosted acrylic and can be mounted to both mid and full height backs. Steel mounting hardware enables screens to be replaced in the field.



### TABLET

Optional Tablets are available in veneer, clear glass, laminate, solid surface and palette finishes. The Zola can be fastened by the Universal Tablet Mount (mounted left or right), to the single Zola leg, it is not able to mount on the Zola dual leg. The Zola Tablet has a turning radius of 360 degrees.



### TABLES

Tables are available in veneer, high pressure laminate or Palette finishes - and an optional solid surface top. An optional flush-mounted Table PowerDoc provides dual power/USB outlets for multiple devices can be located on the front face of Middle or End Tables (not available on curvilinear models). PowerDoc's have a 10' cord.



### MODULAR ARM

Modular arms can attach to the left or right ends of seating units as well as interim locations between units. They are fully upholstered and can optionally be trimmed with urethane or solid surface arm caps.



### URETHANE ARM CAP

The optional urethane arm cap provides enhanced durability and protection for the arms. Urethane arm caps are available in two color options; Grey and Taupe. The urethane arm cap is field replaceable if damaged or degraded.



### SOLID SURFACE ARM CAP

The optional Solid Surface Arm Cap provides enhanced durability, protection and cleanability for the arms. This is field replaceable if this becomes damaged or degraded and is available in 8 standard colors.



### SHELVES & POWER

Back-mounted shelves can be specified in either 30", 36" or 42" and are available in veneer, laminate and Palette finishes (Solid surface overlay also available - contact customer service) The surface-mounted Shelf PowerDoc provides dual power/USB outlets for multiple devices. Units with Shelf Power are not available with Removable Cover option.



### SEAT POWER

The flush-mounted power unit provides dual power/USB outlets for multiple devices. It can be located on either side of the seat, or on the seat front (not available on curved fronts). See [page 83](#) for pricing. Power unit color is white. Units with Seat Power are not available with Removable Cover option.



### PRIVATE MODULAR SIDE PANEL

Side Panels can be specified (in either of two heights) as Start, Center and End locations of configurations to provide an additional degree of privacy and enclosure, and a resting corner position for users - a beneficial element in study, work and waiting area settings. Side Panels will only connect to Center seating units.



### SEMI-PRIVATE MODULAR SIDE PANEL

Semi-Private Side Panels are shallower in depth than standard Side Panels and available in Mid and Full Height back styles. They are specified as Start, Center and Ends and only connect to Center seating units.

In configurations such as banquette settings with tables, they can offer users privacy while still permitting side entry to the seating.



### REPLACEMENT UPHOLSTERY COVERS

Replacement upholstery covers can be easily fitted onto Zola Modular components (with the exception of Zola Curve backs) originally ordered with Removable Upholstery Covers. It is possible to use replacement covers on modular components originally ordered with standard upholstery covers, but this requires some removal of staples and other basic upholstery. Please note that the tailoring of replacement upholstery covers can be less exact and refined in appearance than original upholstery.



### REMOVABLE UPHOLSTERY COVERS

Removable Upholstery Covers are available on most Zola Modular upholstered components, (with the exception of Zola Curve backs) at an upcharge. This feature allows for upholstery covers to be cleaned and disinfected, and allows them to be field-replaced with replacement upholstery covers. Please note that the tailoring of Removable Upholstery Covers can be less exact and refined in appearance than standard upholstery. Replacement and removeable covers, (supplied with Velcro) will tailor differently than the permanently stapled upholstery. Overall form and fit is identical, however minor dimensional build up due to the thickness of the Velcro can occur. The Velcro fastening build up is directed to the least noticeable face (usually the bottom edge of a component) where ever possible.

### MOISTURE BARRIER & CAL 133

California Technical Bulletin 133 is a flammability test for seating. Krug offers a compliance method, in combination with non-flammable upholstery covers, may enable products to meet certification requirements for this test. This process at the same time also provides the products with a Moisture Barrier - a treatment that helps to prevent the passage of liquids and moisture to inside of the upholstered components - thereby conferring sanitary and anti-infection benefits. So when CAL 133 is specified, the product also automatically has a Moisture Barrier, and when a Moisture Barrier is specified, the product also features the compliance method and low flammability features of CAL 133.

The application of this up-charge and the compliance method does not mean that the specific configuration of product and upholstery cover are tested and officially certified as being CAL133 compliant. If the official certification is required, Krug will provide this (through an independent certified testing laboratory) at a charge of \$917 per item, plus the cost of the product to be tested. Lead time for certification testing is typically 4-8 weeks.

Krug assumes no responsibility for the testing of our products in combination with upholstery covers, or for the results of any testing conducted. Some specific configurations of products and upholstery have already been tested. Please contact Customer Service for additional information.

## ZOLA PRIVACY | POWER LOCATIONS

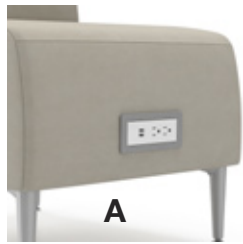

### Seat Power

When ordering Seat Power clearly indicate required location using:

A - for front center of seat (not available on curved fronts)

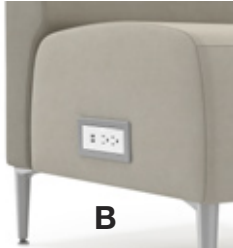

B - for left side of seat (facing)

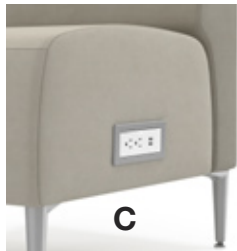

C - for right side of seat (facing)

D - for both left and right of seat

Units with Power are not available with Removable Cover option.



### Shelf Power

Located mid-position on the shelf surface. Units with Shelf Power are not available with Removable Cover option.



### Table Power

Located on the front face of the table as standard. To specify, clearly mark on the order and add **\$589 list**.



### Under-mount Power

The Under-mount Power unit provides dual power/USB outlets for multiple devices. It can be located below seats and tables.

## ZOLA PRIVACY | CONNECTING MULTIPLE UNITS

### SEATING

Start, Center and End multiple units are used to configure continuous runs of seating. Units are specified from left to right (facing). Configurations must include one Start Unit and one End Unit and can be connected to any number of Center Units. Back connecting hardware is concealed once connected to the adjoining unit.

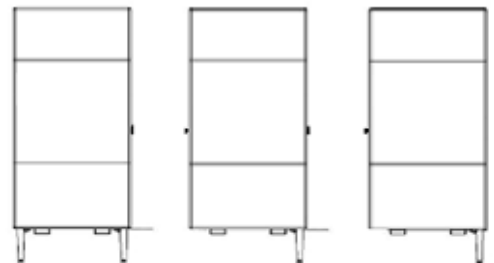

### SIDE PANELS

Start, Center and End Panels are configured in combination with Center Seating only. Start and Center Panel kits contain additional legs which connect to the Center Seat Unit.

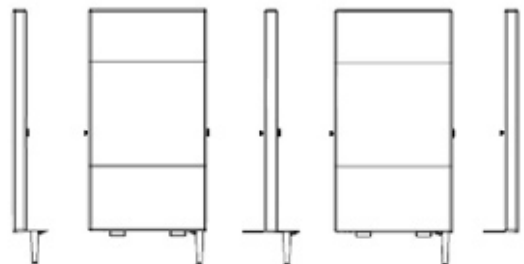

# ZOLA PRIVACY | SAMPLE CONFIGURATIONS & PRICING

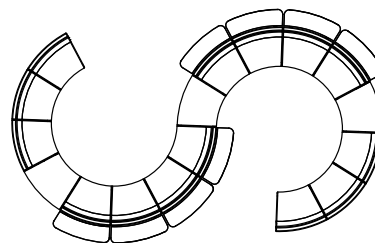
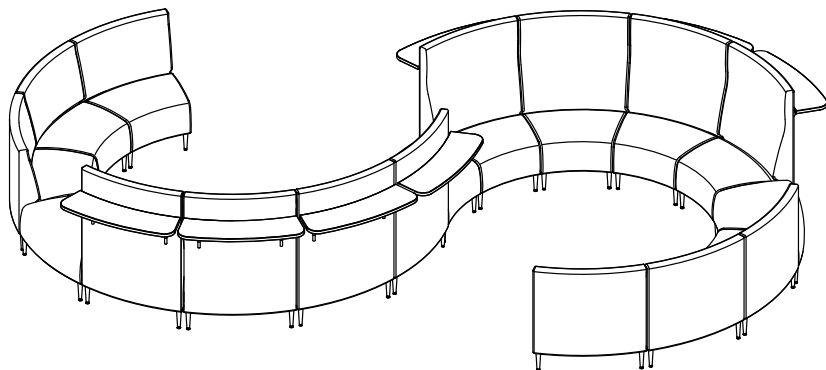

Model	Qty	Price (ea)
ZOP3-MCIS30DM0E	2	3273
ZOP3-MCIS30DM0C	2	3273
ZOP3-MCIS30DM0S	2	3273
ZOL3-MCS30DF1	3	1376
ZOP3-MCIS30DF1E	2	4047
ZOP3-MCIS30DF1C	4	4047
ZOP3-MCIS30DF1S	2	4047

**Total \$56,142**

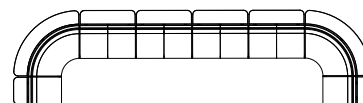
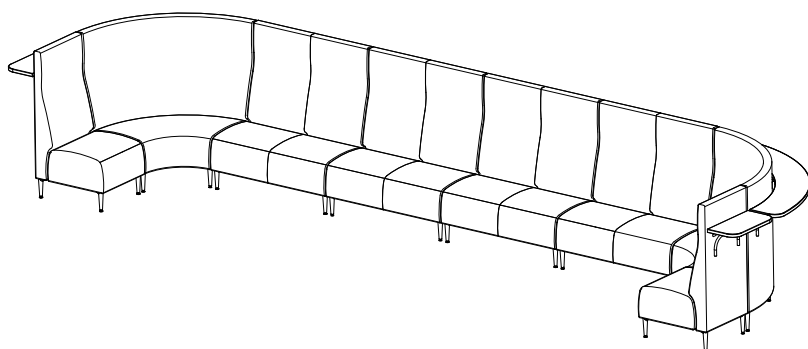

Model	Qty	Price (ea)
ZOP3-M1F1S	1	2364
ZOP3-MCIS90DF1C	2	5866
ZOP3-M2F1C	4	3563
ZOP3-M1F1S	1	2364

**Total \$30,712**

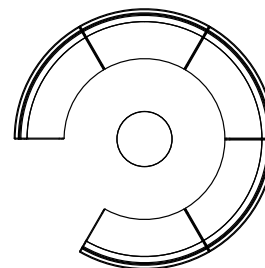
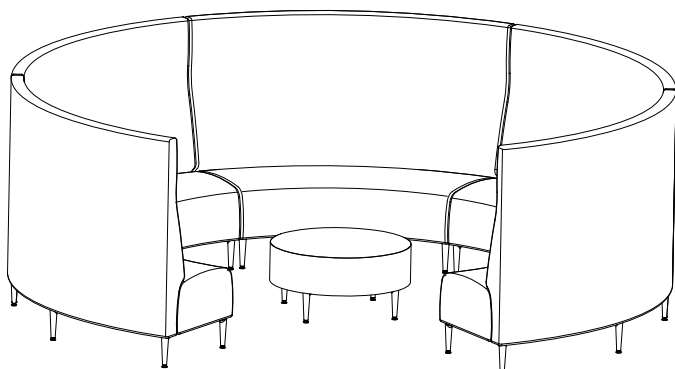

Model	Qty	Price (ea)
ZOP3-MCID60DF0S	1	5910
ZOP3-MCID60DF0C	3	5910
ZOP3-MCID60DF0E	1	5910
ZOL4-30D15	1	1391

**Total \$30,941**



# ZOLA PRIVACY | SAMPLE CONFIGURATIONS & PRICING

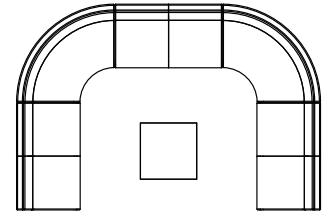
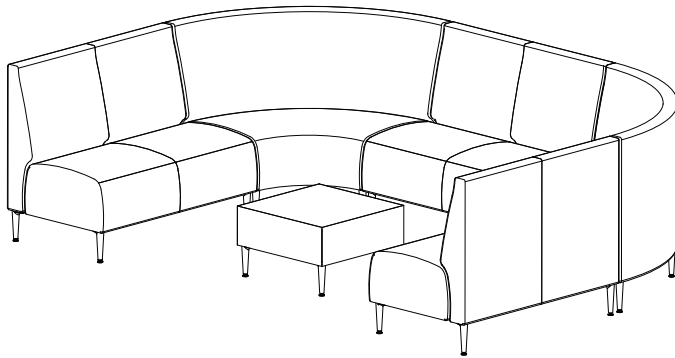

Model	Qty	Price (\$)
ZOP3-M2M0S	1	2595
ZOP3-MCIS90DM0C	2	4571
ZOP3-M2M0C	1	2595
ZOP3-M2M0E	1	2595
ZOL4-242415	1	1187

**Total \$18,114**

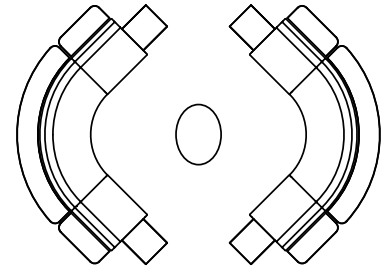
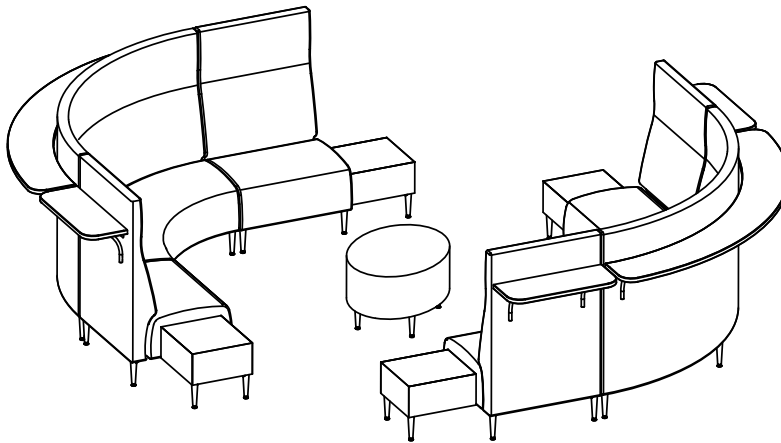

Model	Qty	Price (\$)
ZOL4-LKE18	4	1098
ZOP3-MB1F1S	2	2866
ZOP3-MCID90DF1C	2	7873
ZOP3-MB1F1E	2	2866
ZOL4 E482915	1	2016

**Total \$33,618**

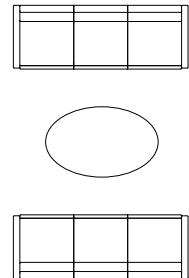
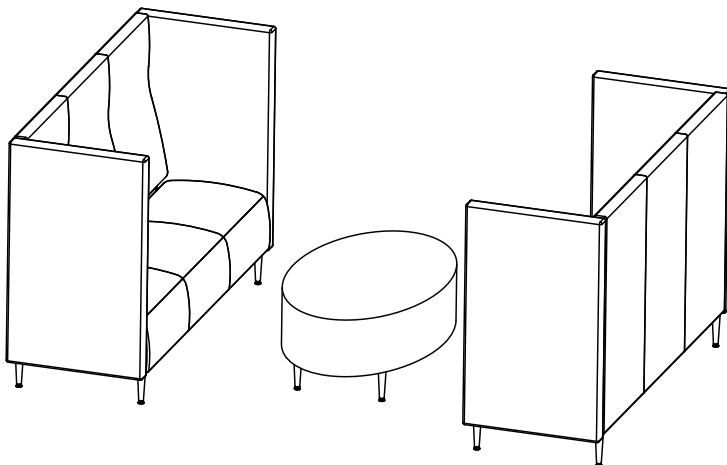

Model	Qty	Price (\$)
ZOP3-MPF0S	2	946
ZOP3-M3F0C	2	3972
ZOP3-MPF0E	2	946
ZOP4-E482915	1	2016

**Total \$13,744**

# ZOLA PRIVACY | PRECONFIGURED - DIMENSIONS & COM REQUIREMENTS

## DIMENSIONS

	Overall Width	Width Between Panels	Overall Depth	Overall Height	Seat Height	Seat Depth	Shipping Weight	Cubes
<b>Preconfigured Full Height Back</b>								
One-Seat Plus	36	30	27	50	18.5	19.25	134	28.3
Two-seat	52	46	27	50	18.5	19.25	161	40.4
Three-seat	75	69	27	50	18.5	19.25	194	57.5
<b>Preconfigured Mid Height Back</b>								
One-Seat Plus	36	30	27	37.5	18.5	19.25	114	20.4
Two-seat	52	46	27	37.5	18.5	19.25	141	29.1
Three-seat	75	69	27	37.5	18.5	19.25	174	41.3

## COM YARDAGES

	Yardage Entire Unit	Yardage 2 Entire Units	Yardage 3 Entire Units	Yardage 4 Entire Units
<b>Preconfigured Full Height Back/Privacy Panel</b>				
One-Seat Plus	9.59	13.78	17.97	22.16
Two-seat	11.48	16.13	20.83	26.56
Three-seat	13.56	21.32	29.38	37.04
<b>Preconfigured Mid Height Back/Privacy Panel</b>				
One-Seat Plus	7.31	10.96	14.61	18.26
Two-seat	8.49	12.22	16.72	21.20
Three-seat	10.60	18.36	26.42	34.08
<b>Preconfigured Full Height Back/Semi-Private Panel</b>				
One-Seat Plus	6.63	10.82	15.01	19.20
Two-seat	8.52	13.17	17.87	23.60
Three-seat	10.60	18.36	25.42	34.08
<b>Preconfigured Mid Height Back/Semi-Private Panel</b>				
One-Seat Plus	5.41	9.06	12.71	16.36
Two-seat	6.59	10.32	14.82	19.30
Three-seat	8.48	14.80	21.42	27.20

# ZOLA PRIVACY | PRECONFIGURED

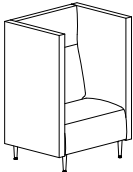
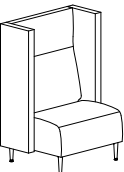
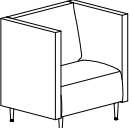
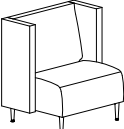
DESCRIPTION/MODEL	COM		COL		FABRIC GRADES			LEATHER	
	1	2	3	4	5	6	7	8	9
 One-Seat Plus with Private Modular Side Panel and Full Height Back ZOP3-PCB1MPF0	3956	4268	4583	5132	5708	6258	6835	7463	8461
 One-Seat Plus with Semi-Private Modular Side Panel and Full Height Back ZOP3-PCB1SMPF0	3229	3455	3683	4059	4461	4838	5241	5695	6347
 One-Seat Plus with Private Modular Side Panel and Mid Height Back ZOP3-PCB1MPM0	3489	3717	3943	4339	4752	5142	5559	6014	6715
 One-Seat Plus with Semi-Private Modular Side Panel and Mid Height Back ZOP3-PCB1SMPM0	2983	3166	3354	3663	3994	4302	4634	5005	5539

## ORDERING NOTES:

Zola Privacy Preconfigured is available in straight units with upholstered side panels. The One-Seat size is offered in 30" only, Plus upgrade is included (23" is not available). PowerDoc is optional on seat front only please mark clearly on the order and add upcharge listed below. PowerDoc's have a 10' cord.

## ZOLA PRIVACY OPTION UPCHARGES





### \$ List

CAL 133 & Moisture Barrier (per yard)	64
Seat Power (per power unit)	641
Plus Upgrade option	included
Combination Upholstery - dual fabrics	33
Combination Upholstery -Three fabrics	64

## PRODUCT CODE KEY

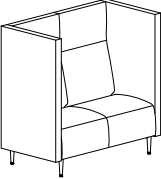
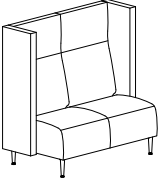
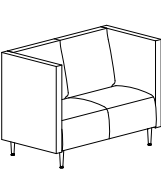
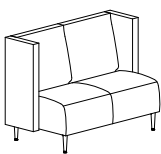
Line	Series	Type	Seat	Side Panel	Height
ZOP	3	PCB	1	MP	F0
Zola Privacy	Lounge	Pre-Configured Plus	One-Seat (30")	Private Modular Side Panel	Full Height
			2	SMP	M0
			Two-Seat	Semi-Private Modular Side Panel	Mid Height
			3		
			Three-Seat		

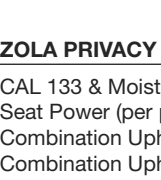
# ZOLA PRIVACY | PRECONFIGURED

DESCRIPTION/MODEL	COM		COL		FABRIC GRADES			LEATHER	
	1	2	3	4	5	6	7	8	9
	Two-Seat with Private Modular Side Panel and Full Height Back								
	ZOP3-PC2MPF0	4571	4947	5327	5970	6653	7295	7977	8739
	Two-Seat Plus with Private Modular Side Panel and Full Height Back								
	ZOP3-PCB2MPF0	4702	5078	5456	6099	6783	7424	8107	8868
	Two-Seat with Semi-Private Modular Side Panel and Full Height Back								
	ZOP3-PC2SMPF0	3843	4134	4426	4897	5407	5876	6386	6970
	Two-Seat Plus with Semi-Private Modular Side Panel and Full Height Back								
	ZOP3-PCB2SMPF0	3972	4265	4557	5027	5537	6007	6515	7101
	Two-Seat with Private Modular Side Panel and Mid Height Back								
	ZOP3-PC2MPM0	3780	4059	4337	4811	5307	5775	6276	6836
	Two-Seat Plus with Private Modular Side Panel and Mid Height Back								
	ZOP3-PCB2MPM0	3909	4189	4467	4941	5437	5905	6406	6965
	Two-Seat with Semi-Private Modular Side Panel and Mid Height Back								
	ZOP3-PC2SMPM0	3271	3510	3746	4133	4548	4933	5349	5825
	Two-Seat Plus with Semi-Private Modular Side Panel and Mid Height Back								
	ZOP3-PCB2SMPM0	3403	3640	3877	4264	4679	5064	5481	5956

## ORDERING NOTES:

Zola Privacy Preconfigured is available in straight units with upholstered side panels. PowerDoc is optional on seat front only please mark clearly on the order and add upcharge listed below. PowerDoc's have a 10' cord.



## ZOLA PRIVACY OPTION UPCHARGES \$ List

CAL 133 & Moisture Barrier (per yard)	64
Seat Power (per power unit)	641
Combination Upholstery - dual fabrics	33
Combination Upholstery -Three fabrics	64

## PRODUCT CODE KEY

Line	Series	Type	Seat	Side Panel	Height
ZOP	3	PC	1	MP	F0
Zola Privacy	Lounge	Pre-Configured	One-Seat (30")	Private Modular Side Panel	Full Height
		PCB	2	SMP	M0
		Pre-Configured Plus Upgrade	Two-Seat	Semi-Private Modular Side Panel	Mid Height
			3		
			Three-Seat		

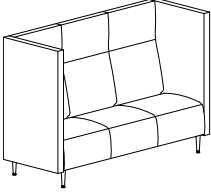
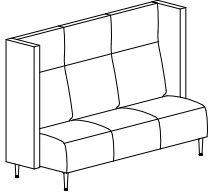
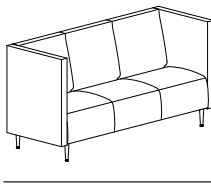
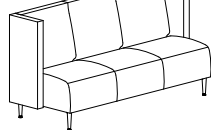
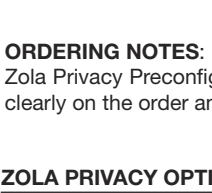
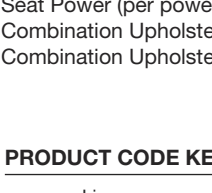
# ZOLA PRIVACY | PRECONFIGURED

DESCRIPTION/MODEL	COM		COL		FABRIC GRADES			LEATHER	
	1	2	3	4	5	6	7	8	9
	Three-Seat with Private Modular Side Panel and Full Height Back								
	ZOP3-PC3MPF0	5495	5940	6390	7131	7923	8663	9457	10354
	Three-Seat Plus with Private Modular Side Panel and Full Height Back								
	ZOP3-PCB3MPF0	5691	6136	6585	7327	8119	8859	9652	10548
	Three-Seat with Semi-Private Modular Side Panel and Full Height Back								
	ZOP3-PC3SMPF0	4768	5128	5488	6057	6678	7243	7864	8587
	Three-Seat Plus with Semi-Private Modular Side Panel and Full Height Back								
	ZOP3-PCB3SMPF0	4964	5322	5684	6253	6872	7441	8059	8783
	Three-Seat with Private Modular Side Panel and Mid Height Back								
	ZOP3-PC3MPM0	4903	5244	5584	6148	6750	7309	7911	8595
	Three-Seat Plus with Private Modular Side Panel and Mid Height Back								
	ZOP3-PCB3MPM0	5098	5441	5781	6344	6945	7504	8107	8790
	Three-Seat with Semi-Private Modular Side Panel and Mid Height Back								
	ZOP3-PC3SMPM0	4396	4696	4995	5471	5990	6466	6985	7586
	Three-Seat Plus with Semi-Private Modular Side Panel and Mid Height Back								
	ZOP3-PCB3SMPM0	4591	4891	5191	5666	6185	6662	7180	7781

## ORDERING NOTES:

Zola Privacy Preconfigured is available in straight units with upholstered side panels. PowerDoc is optional on seat front only please mark clearly on the order and add upcharge listed below. PowerDoc's have a 10' cord.

## ZOLA PRIVACY OPTION UPCHARGES

\$ List

CAL 133 & Moisture Barrier (per yard)	64
Seat Power (per power unit)	641
Combination Upholstery - dual fabrics	33
Combination Upholstery -Three fabrics	64

## PRODUCT CODE KEY

Line	Series	Type	Seat	Side Panel	Height
ZOP	3	PC	1	MP	F0
Zola Privacy	Lounge	Pre-Configured	One-Seat (30")	Private Modular Side Panel	Full Height
		PCB	2	SMP	M0
		Pre-Configured Plus Upgrade	Two-Seat	Semi-Private Modular Side Panel	Mid Height
			3		
			Three-Seat		

# ZOLA PRIVACY | MODULAR - DIMENSIONS & COM REQUIREMENTS

## DIMENSIONS

	Overall Width	Overall Depth	Depth w/ Shelf	Overall Height	Height w/Screen	Overall Seat Height	Seat Depth	Shipping Weight	Cubes
<b>Full Height Back</b>									
One-Seat	23	27	39	50	62.5	18.5	20.25	69	10.6
Two-seat	46	27	39	50	62.5	18.5	20.25	114	20.8
Three-seat	69	27	39	50	62.5	18.5	20.25	165	31.0
One-Seat (Plus)	30	27	39	50	62.5	18.5	20.25	81	13.8
<b>Mid Height Back</b>									
One-Seat	23	27	39	37.5	50	18.5	20.25	65	9.8
Two-seat	46	27	39	37.5	50	18.5	20.25	107	19.1
Three-seat	69	27	39	37.5	50	18.5	20.25	154	28.5
One-Seat (Plus)	30	27	39	37.5	50	18.5	20.25	76	12.6
<b>Modular Corner Seat with Full Height Back</b>									
One-Seat	27	27	40	50	62.5	18.5	20.25	104	26
One-Seat (Plus)	27	27	40	50	62.5	18.5	20.25	104	26
<b>Modular Corner Seat with Mid Height Back</b>									
One-Seat	27	27	40	37.5	50	18.5	20.25	93	26
One-Seat (Plus)	27	27	40	37.5	50	18.5	20.25	93	26

## COM YARDAGES

	Yardage Entire Unit	Yardage 2 Entire Units	Yardage 3 Entire Units	Yardage 4 Entire Units	Yardage per Back	Yardage per 2 Backs	Yardage per 3 Backs	Yardage per 4 Backs	Yardage per Seat	Yardage per 2 Seats	Yardage per 3 Seats	Yardage per 4 Seats
<b>Full Height Back</b>												
One-Seat	4.1	6.45	10.55	12.9	2.85	4.35	7.2	8.7	1.25	2.1	3.35	4.2
Two-seat	6.08	10.73	16.76	21.16	4.33	7.33	11.66	14.66	1.75	3.4	5.1	6.5
Three-seat	8.16	15.92	23.98	31.64	5.66	11.32	16.98	22.64	2.5	4.6	7	9
One-Seat (Plus)	4.19	8.38	12.57	16.76	2.94	5.88	8.82	11.76	1.25	2.5	3.75	5
<b>Mid Height Back</b>												
One-Seat	3.25	5.2	8.45	10.4	2	3.1	4.2	6.2	1.25	2.1	3.35	4.2
Two-seat	4.83	8.56	13.34	16.82	3.08	5.16	8.24	10.32	1.75	3.4	5.1	6.5
Three-seat	6.72	13.04	19.66	25.88	4.22	8.44	12.66	16.88	2.5	4.6	7	9
One-Seat (Plus)	3.65	7.3	10.95	14.6	2.4	4.8	7.2	9.6	1.25	2.5	3.75	5
<b>Modular Corner Seat with Full Height Back</b>												
One-Seat	7.79	12	18	24	5.70	11.4	16.9	22.4	2.00	4	6	8
One-Seat (Plus)	7.79	12	18	24	5.70	11.4	16.9	22.4	2.00	4	6	8
<b>Modular Corner Seat with Mid Height Back</b>												
One-Seat	6.40	12	18	24	4.00	8	12	18	2.00	4	6	8
One-Seat (Plus)	6.40	12	18	24	4.00	8	12	18	2.00	4	6	8

## ZOLA PRIVACY PLUS OPTION UPCHARGES

### \$ List

Plus Upgrade Two-Seat	129
Plus Upgrade Three-Seat	195

NOTE: One-Seat Plus pricing includes Plus Upgrade, for Two-Seat and Three-Seat add a "B" to the model number and the option upcharge (per power unit) above.

# ZOLA PRIVACY | MODULAR - PANELS & ARMS -DIMENSIONS & COM REQUIREMENTS

## DIMENSIONS & COM REQUIREMENTS

		Overall Width	Overall Depth	Overall Height	Shipping Weight	Cubes	COM 1-unit	COM 2-units	COM 3-units	COM 4-units	COM 5-units	COM 6-units
Side Panel, Single, Full Height No Screen												
ZOP3-MPF0S	Start	2.75	27	43.90	38	3	2.7	5.38	8.06	10.75	13.44	16.13
ZOP3-MPF0C	Center	2.75	27	43.90	38	3	2.7	5.38	8.06	10.75	13.44	16.13
ZOP3-MPF0E	End	2.75	27	43.90	38	3	2.7	5.38	8.06	10.75	13.44	16.13
Side Panel, Single, Full Height with Screen												
ZOP3-MPF2S	Start	2.75	27	56.5	40	3	2.7	5.38	8.06	10.75	13.44	16.13
ZOP3-MPF2C	Center	2.75	27	56.5	40	3	2.7	5.38	8.06	10.75	13.44	16.13
ZOP3-MPF2E	End	2.75	27	56.5	40	3	2.7	5.38	8.06	10.75	13.44	16.13
Side Panel, Single, Mid Height No Screen												
ZOP3-MPM0S	Start	2.75	27	31.38	26	2	1.99	3.99	5.98	7.97	9.97	11.96
ZOP3-MPM0C	Center	2.75	27	31.38	26	2	1.99	3.99	5.98	7.97	9.97	11.96
ZOP3-MPM0E	End	2.75	27	31.38	26	2	1.99	3.99	5.98	7.97	9.97	11.96
Side Panel, Single, Mid Height with Screen												
ZOP3-MPM2S	Start	2.75	27	43.88	28	2	1.99	3.99	5.98	7.97	9.97	11.96
ZOP3-MPM2C	Center	2.75	27	43.88	28	2	1.99	3.99	5.98	7.97	9.97	11.96
ZOP3-MPM2E	End	2.75	27	43.88	28	2	1.99	3.99	5.98	7.97	9.97	11.96
Semi-Private Side Panel, Single, Full Height												
ZOP3-MSPF0S	Start	2.75	14.25	44	26	1.5	1.27	2.55	3.83	5.11	6.39	7.67
ZOP3-MSPF0C	Center	2.75	14.25	44	26	1.5	1.27	2.55	3.83	5.11	6.39	7.67
ZOP3-MSPF0E	End	2.75	14.25	44	21	1.5	1.27	2.55	3.83	5.11	6.39	7.67
Semi-Private Side Panel, Single, Mid Height												
ZOP3-MSPM0S	Start	2.75	14.25	31.4	19	1	.88	1.99	2.92	3.72	4.65	5.56
ZOP3-MSPM0C	Center	2.75	14.25	31.4	23	1	.88	1.99	2.92	3.72	4.65	5.56
ZOP3-MSPM0E	End	2.75	14.25	31.4	19	1	.88	1.99	2.92	3.72	4.65	5.56
Modular Upholstered Arm												
ZOP3-MAUPHL*		3	14.5	19.75	25	1.1	1.33	2.11	2.8	3.56	4.44	5
ZOP3-MAUPHR		3	14.5	19.75	25	1.1	1.33	2.11	2.8	3.56	4.44	5
ZOP3-MAUPHC		3	14.5	19.75	25	1.1	1.33	2.11	2.8	3.56	4.44	5
Modular Upholstered Arm w/Urethane Cap												
ZOP3-MAUREL		3	14.5	20.25	28	1.1	1.33	2.11	2.8	3.56	4.44	5
ZOP3-MAURER*		3	14.5	20.25	28	1.1	1.33	2.11	2.8	3.56	4.44	5
ZOP3-MAUREC		3	14.5	20.25	28	1.1	1.33	2.11	2.8	3.56	4.44	5
Modular Upholstered Arm w/Solid Surface Cap												
ZOP3-MASSCL		3	14.5	20.25	28	1.1	1.33	2.11	2.8	3.56	4.44	5
ZOP3-MASSCR		3	14.5	20.25	28	1.1	1.33	2.11	2.8	3.56	4.44	5
ZOP3-MASSCI*		3	14.5	20.25	28	1.1	1.33	2.11	2.8	3.56	4.44	5

# ZOLA PRIVACY | MODULAR

DESCRIPTION/MODEL/SPECIES	COM		COL	FABRIC GRADES			LEATHER		
	1	2	3	4	5	6	7	8	9
 One-Seat, Full Height Back ZOP3-M1F0F	1924	2060	2195	2388	2610	2804	3025	3294	3581

 One-Seat, Full Height Back with Shelf Option ZOP3-M1F1_	Beech/Laminate	2364	2500	2636	2829	3052	3244	3463	3736	4022
	Maple/Palette	2460	2594	2732	2924	3144	3340	3560	3829	4116

**ORDERING NOTES:** When ordering units with shelf option please clearly specify on your order the required shelf height - 42", 36" or 30". Freestanding, Start and End units with the shelf option require counterbalance weight added to each seat unit, please add **303 list** upcharge per unit. Units with shelf option are not available with Removable Back Cover option.

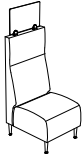
 One-Seat, Full Height Back with Privacy Screen Option ZOP3-M1F2F	2209	2342	2479	2671	2892	3087	3307	3578	3865
---	------	------	------	------	------	------	------	------	------

**ORDERING NOTES:** Units with Privacy Screen Option are not available with Removable Back Cover option.

 One-Seat, Mid Height Back ZOP3-M1M0F	1811	1918	2026	2176	2348	2502	2673	2888	3109
---	------	------	------	------	------	------	------	------	------

 One-Seat, Mid Height Back with Shelf Option ZOP3-M1M1_	Beech/Laminate	2252	2357	2464	2615	2789	2942	3114	3327	3547
	Maple/Palette	2346	2452	2560	2713	2883	3036	3209	3424	3643

**ORDERING NOTES:** When ordering units with shelf option please clearly specify on your order the required shelf height - 42", 36" or 30". Freestanding, Start and End units with the shelf option require counterbalance weight added to each seat unit, please add **303 list** upcharge per unit. Units with shelf option are not available with Removable Back Cover option.

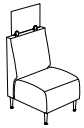
 One-Seat, Mid Height Back with Privacy Screen Option ZOP3-M1M2F	2092	2198	2307	2460	2632	2783	2957	3169	3390
--	------	------	------	------	------	------	------	------	------

**ORDERING NOTES:** Units with Privacy Screen Option are not available with Removable Back Cover option.

## Zola Privacy Option Upcharges

	\$ List		\$ List
Moisture Barrier & CAL 133(per yard)	64	Seat Power (per unit)	641
Removable Seat Covers One-Seat	47	Shelf Power	599
Removable Back Covers One-Seat	68	Table Power	589
Dual Leg (for Multiple unit configurations)	80	Combination Upholstery - dual fabrics	33

## PRODUCT CODE KEY

Line	Series	Chair Type	Seat Count	Back Type	Leg Type
ZOP	3	M	1	F0	F
Zola	Lounge	Modular	One Seat	Full Height Back	Freestanding Unit
			2	F1	S
			Two Seat	Full Height Back with Shelf Option	Start Unit
			3	F2	C
			Three Seat	Full Height Back with Privacy Screen Option	Center Unit
				M0	E
				Mid Height Back	End Unit
				M1	
				Mid Height Back with Shelf Option	
				M2	
				Mid Height Back with Privacy Screen Option	



# ZOLA PRIVACY | MODULAR

DESCRIPTION/MODEL/SPECIES	COM		COL		FABRIC GRADES			LEATHER	
	1	2	3	4	5	6	7	8	9

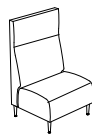

One-Seat Plus, Full Height Back  
ZOP3-MB1F0F

2413	2549	2684	2879	3099	3292	3513	3785	4070
------	------	------	------	------	------	------	------	------



One-Seat Plus, Full Height Back with Shelf Option

ZOP3-MB1F1\_ Beech/Laminate  
Maple/Palette

2866	3001	3137	3330	3553	3744	3965	4237	4525
2963	3097	3235	3428	3647	3843	4063	4334	4618

**ORDERING NOTES:** When ordering units with shelf option please clearly specify on your order the required shelf height - 42", 36" or 30". Freestanding, Start and End units with the shelf option require counterbalance weight added to each seat unit, please add **303 list** upcharge per unit. Units with shelf option are not available with Removable Back Cover option.



One-Seat Plus, Full Height Back with Privacy Screen Option

ZOP3-MB1F2F

2770	2906	3040	3236	3456	3648	3870	4141	4427
------	------	------	------	------	------	------	------	------

**ORDERING NOTES:** Units with Privacy Screen Option are not available with Removable Back Cover option.



One-Seat Plus, Mid Height Back

ZOP3-MB1M0F

2304	2411	2518	2670	2844	2994	3166	3382	3603
------	------	------	------	------	------	------	------	------



One-Seat Plus, Mid Height Back with Shelf Option

ZOP3-MB1M1\_ Beech/Laminate  
Maple/Palette

2757	2863	2970	3122	3294	3448	3620	3834	4057
2853	2959	3068	3219	3390	3542	3715	3931	4152

**ORDERING NOTES:** When ordering units with shelf option please clearly specify on your order the required shelf height - 42", 36" or 30". Freestanding, Start and End units with the shelf option require counterbalance weight added to each seat unit, please add **303 list** upcharge per unit. Units with shelf option are not available with Removable Back Cover option.

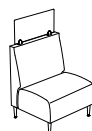

One-Seat Plus, Mid Height Back with Privacy Screen Option

ZOP3-MB1M2F

2661	2768	2877	3028	3200	3352	3523	3739	3959
------	------	------	------	------	------	------	------	------

**ORDERING NOTES:** Units with Privacy Screen Option are not available with Removable Back Cover option.

## Zola Privacy Option Upcharges

\$ List







\$ List

Moisture Barrier & CAL 133(per yard)	64	Seat Power (per unit)	641
Removable Seat Covers One-Seat	47	Shelf Power	599
Removable Back Covers One-Seat	68	Table Power	589
Dual Leg (for Multiple unit configurations)	80	One-Seat Plus includes Plus Upgrade	

## PRODUCT CODE KEY

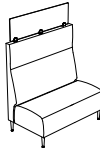
Line	Series	Chair Type	Seat Count	Back Type	Leg Type
ZOP	3	M	1	F0	F
Zola	Lounge	Modular	One Seat	Full Height Back	Freestanding Unit
		MB	2	F1	S
		Modular Plus Upgrade	Two Seat	Full Height Back with Shelf Option	Start Unit
			3	F2	C
			Three Seat	Full Height Back with Privacy Screen Option	Center Unit
				M0	E
				Mid Height Back	End Unit
				M1	
				Mid Height Back with Shelf Option	
				M2	
				Mid Height Back with Privacy Screen Option	

# ZOLA PRIVACY | MODULAR

DESCRIPTION/MODEL/SPECIES	COM		COL	FABRIC GRADES			LEATHER		
	1	2	3	4	5	6	7	8	9
 Two-Seat, Full Height Back ZOP3-M2F0F	3029	3231	3430	3717	4044	4334	4658	5061	5490
 Two-Seat, Full Height Back Shelf Option ZOP3-M2F1_ Beech/Laminate	3563	3763	3963	4252	4580	4867	5192	5595	6023
Maple/Palette	3663	3864	4064	4352	4679	4967	5292	5693	6122
<b>ORDERING NOTES:</b> When ordering units with shelf option please clearly specify on your order the required shelf height - 42", 36" or 30". Freestanding, Start and End units with the shelf option require counterbalance weight added to each seat unit, please add <b>303 list</b> upcharge per unit. Units with shelf option are not available with Removable Back Cover option.									
 Two-Seat, Full Height Back with Privacy Screen Option ZOP3-M2F2F	3519	3718	3920	4207	4534	4822	5006	5549	5978
<b>ORDERING NOTES:</b> Units with Privacy Screen Option are not available with Removable Back Cover option.									
 Two-Seat, Mid Height Back ZOP3-M2M0F	2595	2754	2913	3141	3399	3628	3886	4205	4537
 Two-Seat, Mid Height Back with Shelf Option ZOP3-M2M1_ Beech/Laminate	3132	3290	3449	3678	3934	4162	4421	4738	5072
Maple/Palette	3231	3388	3546	3774	4035	4261	4520	4838	5171
<b>ORDERING NOTES:</b> When ordering units with shelf option please clearly specify on your order the required shelf height - 42", 36" or 30". Freestanding, Start and End units with the shelf option require counterbalance weight added to each seat unit, please add <b>303 list</b> upcharge per unit. Units with shelf option are not available with Removable Back Cover option.									
 Two-Seat, Mid Height Back with Privacy Screen Option ZOP3-M2M2F	3087	3245	3404	3633	3891	4117	4377	4693	5030
<b>ORDERING NOTES:</b> Units with Privacy Screen Option are not available with Removable Back Cover option.									

## Zola Privacy Option Upcharges

	\$ List	\$ List
Moisture Barrier & CAL 133(per yard)	64	Seat Power (per unit)
Removable Seat Covers One-Seat	68	Shelf Power
Removable Back Covers One-Seat	97	Table Power
Dual Leg (for Multiple unit configurations)	80	Plus Upgrade Two-Seat (B)
Combination Upholstery - dual fabrics	33	

## PRODUCT CODE KEY

Line	Series	Chair Type	Seat Count	Back Type	Leg Type
ZOP	3	M	1	F0	F
Zola	Lounge	Modular	One Seat	Full Height Back	Freestanding Unit
		MB	2	F1	S
		Modular Plus Upgrade	Two Seat	Full Height Back with Shelf Option	Start Unit
			3	F2	C
			Three Seat	Full Height Back with Privacy Screen Option	Center Unit
				M0	E
				Mid Height Back	End Unit
				M1	
				Mid Height Back with Shelf Option	
				M2	
				Mid Height Back with Privacy Screen Option	

# ZOLA PRIVACY | MODULAR

DESCRIPTION/MODEL/SPECIES	COM		COL	FABRIC GRADES			LEATHER		
	1	2	3	4	5	6	7	8	9



Three-Seat, Full Height Back ZOP3-M3F0F	3983	4252	4524	4906	5345	5730	6166	6707	7271
--	------	------	------	------	------	------	------	------	------

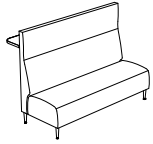

Three-Seat, Full Height Back Shelf Option ZOP3-M3F1_									
Beech/Laminate	4610	4879	5149	5534	5971	6358	6793	7332	7899
Maple/Palette	4713	4984	5255	5638	6077	6463	6897	7437	8005

**ORDERING NOTES:** When ordering units with shelf option please clearly specify on your order the required shelf height - 42", 36" or 30". Freestanding, Start and End units with the shelf option require counterbalance weight added to each seat unit, please add **303 list** upcharge per unit. Units with shelf option are not available with Removable Back Cover option.



Three-Seat, Full Height Back with Privacy Screen Option ZOP3-M3F2F	4683	4952	5220	5608	6045	6431	6867	7405	7972
---	------	------	------	------	------	------	------	------	------

**ORDERING NOTES:** Units with Privacy Screen Option are not available with Removable Back Cover option.

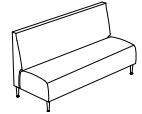

Three-Seat, Mid Height Back ZOP3-M3M0F	3748	3972	4192	4510	4870	5190	5552	5994	6466
---	------	------	------	------	------	------	------	------	------



Three-Seat, Mid Height Back Shelf Option ZOP3-M3M1_									
Beech/Laminate	4377	4599	4818	5138	5498	5815	6180	6621	7092
Maple/Palette	4481	4705	4923	5242	5604	5920	6284	6725	7197

**ORDERING NOTES:** When ordering units with shelf option please clearly specify on your order the required shelf height - 42", 36" or 30". Freestanding, Start and End units with the shelf option require counterbalance weight added to each seat unit, please add **303 list** upcharge per unit. Units with shelf option are not available with Removable Back Cover option.



Three-Seat, Mid Height Back with Privacy Screen Option ZOP3-M3M2F	4449	4670	4891	5211	5572	5890	6252	6692	7164
--	------	------	------	------	------	------	------	------	------

**ORDERING NOTES:** Units with Privacy Screen Option are not available with Removable Back Cover option.







## Zola Privacy Option Upcharges

	\$ List	\$ List
Moisture Barrier & CAL 133(per yard)	64	Seat Power (per unit)
Removable Seat Covers Three-Seat	85	Shelf Power
Removable Back Covers Three-Seat	121	Table Power
Dual Leg (for Multiple unit configurations)	80	Plus Upgrade Three-Seat (B)
Combination Upholstery - dual fabrics	33	195

## PRODUCT CODE KEY

Line	Series	Chair Type	Seat Count	Back Type	Leg Type
ZOP Zola	3 Lounge	M Modular	1 One Seat	F0 Full Height Back	F Freestanding Unit
		MB Modular Plus Upgrade	2 Two Seat	F1 Full Height Back with Shelf Option	S Start Unit
			3 Three Seat	F2 Full Height Back with Privacy Screen Option	C Center Unit
				M0 Mid Height Back	E End Unit
				M1 Mid Height Back with Shelf Option	
				M2 Mid Height Back with Privacy Screen Option	

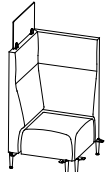
# ZOLA PRIVACY | MODULAR

DESCRIPTION/MODEL/SPECIES	COM		COL	FABRIC GRADES			LEATHER		
	1	2	3	4	5	6	7	8	9
 Modular Corner Seat with Full Height Back ZOP3-MCF0	4058	4290	4522	4846	5219	5546	5917	6382	6848
 Modular Corner Seat, Full Height Back with Shelves ZOP3-MCF1LR	4937	5169	5403	5727	6099	6424	6796	7262	7729
Beech/Laminate	5033	5264	5497	5823	6196	6521	6893	7358	7822
Maple/Palette									
 Modular Corner Seat, Full Height Back with single shelf left* ZOP3-MCF1L	4744	4988	5233	5574	5966	6308	6697	7185	7333
Beech/Laminate	4749	4992	5236	5579	5970	6312	6703	7190	7337
Maple/Palette									
 Modular Corner Seat, Full Height Back with single shelf right ZOP3-MCF1R	4744	4988	5233	5574	5966	6308	6697	7185	7333
Beech/Laminate	4749	4992	5236	5579	5970	6312	6703	7190	7337
Maple/Palette									
 Modular Corner Seat, Full Height Back with Privacy Screens ZOP3-MCF2LR	4624	4857	5089	5414	5787	6113	6484	6948	7416
 Modular Corner Seat, Full Height Back with Privacy Screen Left ZOP3-MCF2L	4573	4816	5061	5404	5793	6136	6524	7015	7161
 Modular Corner Seat, Full Height Back with Privacy Screen Right ZOP3-MCF2R	4573	4816	5061	5404	5793	6136	6524	7015	7161

## Zola Privacy Option Upcharges





## \$ List

Moisture Barrier & CAL 133(per yard)	64
Shelf Power	599
Dual Leg (for Multiple unit configurations)	80
Plus Upgrade- Corner Seat	64
Combination Upholstery - dual fabrics	33

## PRODUCT CODE KEY

Line	Series	Chair Type	Back Type	Shelf/Screen
ZOP Zola	3 Lounge	MC Modular Corner Seat	F0 Full Height Back	L Left Side
		MCB Modular Corner Seat Plus	F1 Full Height Back with Shelf Option	R Right Side
			F2 Full Height Back with Privacy Screen Option	LR Left & Right Sides

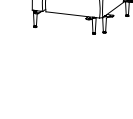
# ZOLA PRIVACY | MODULAR

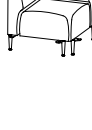
DESCRIPTION/MODEL/SPECIES	COM		COL	FABRIC GRADES			LEATHER		
	1	2	3	4	5	6	7	8	9
 Modular Corner Seat with Mid Height Back ZOP3-MCM0	3263	3455	3646	3916	4222	4491	4798	5183	5568
 Modular Corner Seat, Mid Height Back with Shelves ZOP3-MCM1LR									
Beech/Laminate	4141	4335	4527	4795	5103	5370	5679	6061	6447
Maple/Palette	4237	4429	4622	4890	5197	5468	5773	6158	6542
 Modular Corner Seat, Mid Height Back with Single Shelf left* ZOP3-MCM1L									
Beech/Laminate	3909	4112	4313	4595	4919	5201	5524	5925	6052
Maple/Palette	3914	4116	4385	4600	4922	5205	5528	5929	6055
 Modular Corner Seat, Mid Height Back with Single Shelf Right ZOP3-MCM1R									
Beech/Laminate	3909	4112	4313	4595	4919	5201	5524	5925	6052
Maple/Palette	3914	4116	4385	4600	4922	5205	5528	5929	6055
 Modular Corner Seat, Mid Height Back with Privacy Screens ZOP3-MCM2LR	3829	4022	4214	4483	4790	5059	5366	5748	6135
 Modular Corner Seat, Full Height Back with Privacy Screen Left* ZOP3-MCM2L	3738	3940	4141	4423	4746	5030	5351	5755	5880
 Modular Corner Seat, Full Height Back with Privacy Screen Right ZOP3-MCM2R	3738	3940	4141	4423	4746	5030	5351	5755	5880





## Zola Privacy Option Upcharges \$ List

Moisture Barrier & CAL 133(per yard)	64
Shelf Power	599
Dual Leg (for Multiple unit configurations)	80
Plus Upgrade- Corner Seat	64
Combination Upholstery - dual fabrics	33

## PRODUCT CODE KEY

Line	Series	Chair Type	Back Type	Shelf/Screen
ZOP	3	MC	M0	L
Zola	Lounge	Modular Corner Seat	Mid Height Back	Left Side
		MCB	M1	R
		Modular Corner Seat Plus	Mid Height Back with Shelf Option	Right Side
			M2	LR
			Mid Height Back with Privacy Screen Option	Left & Right Sides

# ZOLA PRIVACY | SIDE PANELS

DESCRIPTION/MODEL	COM		COL			FABRIC GRADES			LEATHER		
	1	2	3	4	5	6	7	8	9		
	Side Panel, Single, Full Height No Screen										
	ZOP3-MPF0S	Start	948	1036	1124	1304	1481	1660	1836	2016	2370
	ZOP3-MPF0C	Center	1222	1310	1398	1578	1753	1932	2109	2286	2642
	ZOP3-MPF0E	End	948	1036	1124	1304	1481	1660	1836	2016	2370
	Side Panel, Single, Full Height with Screen										
	ZOP3-MPF2S	Start	1243	1332	1420	1597	1776	1954	2132	2310	2665
	ZOP3-MPF2C	Center	1515	1606	1693	1871	2051	2228	2406	2584	2938
	ZOP3-MPF2E	End	1243	1332	1420	1597	1776	1954	2132	2310	2665
	Side Panel, Single, Mid Height No Screen										
	ZOP3-MPM0S	Start	767	829	888	1011	1131	1251	1372	1492	1732
	ZOP3-MPM0C	Center	1052	1110	1170	1290	1412	1533	1653	1773	2016
	ZOP3-MPM0E	End	767	829	888	1011	1131	1251	1372	1492	1732
	Side Panel, Single, Mid Height with Screen										
	ZOP3-MPM2S	Start	1063	1122	1183	1306	1425	1547	1667	1788	2029
	ZOP3-MPM2C	Center	1346	1405	1465	1587	1706	1827	1947	2066	2310
	ZOP3-MPM2E	End	1063	1122	1183	1306	1425	1547	1667	1788	2029

**ORDERING NOTE:** Side Panels will only connect to Center seating units. Units with Privacy Screen Option are not available with Removable Back Cover option.

## PRODUCT CODE KEY

Line	Series	Chair Type	Height	Position
ZOP	3	MP	F0	S
Zola	Lounge	Modular Side Panel	Full Height	Start
			F2	C
			Full Height with Privacy Screen Option	Center
			M0	E
			Mid Height	End
			M2	
			Mid Height with Privacy Screen Option	

# ZOLA PRIVACY | SEMI-PRIVATE SIDE PANELS & MODULAR ARMS

DESCRIPTION/MODEL	COM		COL		FABRIC GRADES			LEATHER			
	1	2	3	4	5	6	7	8	9		
	Semi-Private Side Panel, Single, Full Height										
	ZOP3-MSPF0S	Start	583	628	674	765	856	949	1039	1132	1314
	ZOP3-MSPF0C	Center	857	905	952	1041	1134	1224	1315	1407	1589
	ZOP3-MSPF0E	End	583	628	674	765	856	949	1039	1132	1314

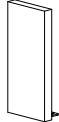
	Semi-Private Side Panel, Single, Mid Height										
	ZOP3-MSPM0S	Start	514	555	592	672	751	829	909	987	1143
	ZOP3-MSPM0C	Center	796	835	875	955	1033	1111	1191	1269	1428
	ZOP3-MSPM0E	End	514	555	592	672	751	829	909	987	1143

**ORDERING NOTE:** Semi-Private Side Panels will only connect to Center seating units.

### PRODUCT CODE KEY

Line	Series	Chair Type	Height	Position
ZOP	3	MSP	F0	S
Zola	Lounge	Modular Semi-Private Side Panel	Full Height	Start
			M0	C
			Mid Height	Center
				E
				End

# ZOLA PRIVACY | MODULAR ARMS

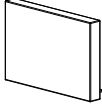
DESCRIPTION/MODEL	COM		COL		FABRIC GRADES			LEATHER			
	1	2	3	4	5	6	7	8	9		
	Modular Upholstered Arm										
	ZOP3-MAUPLH*		702	740	778	853	930	1004	1081	1155	1307
	ZOP3-MAUPHR		702	740	778	853	930	1004	1081	1155	1307
	ZOP3-MAUPHC		784	823	859	935	1012	1087	1163	1239	1390

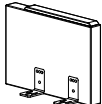
	Modular Upholstered Arm w/Urethane Cap										
	ZOP3-MAUREL		840	878	914	990	1066	1141	1218	1292	1445
	ZOP3-MAURER*		840	878	914	990	1066	1141	1218	1292	1445
	ZOP3-MAUREC		906	942	981	1058	1134	1207	1284	1358	1510

**ORDERING NOTE:** To specify Solid Surface Arm Caps on Modular Upholstered Arms, please add upcharge below and change UPH in the model number to SSC.

Zola Option Upcharges	Grades		
	A-White	A-Color	B C
Solid Surface Arm Cap (per arm)	129	136	151 157

### PRODUCT CODE KEY

Line	Series	Type	Arm	Position
ZOP	3	MA	UPH	L
Zola	Lounge	Modular Arm	Upholstered	Left Hand Facing
			URE	R
			Upholstered Arm w/Urethane Cap	Right Hand facing
			SSC	C
			Upholstered Arm w/Solid Surface Cap	Center

# ZOLA PRIVACY | TWIN - DIMENSIONS & COM REQUIREMENTS

## DIMENSIONS

	Overall Width	Width with Arms	Overall Depth	Depth w/ Shelf	Overall Height	Overall Height w/Screen	Seat Height	Seat Depth	Shipping Weight	Cubes
<b>Twin Full Height Back</b>										
One-Seat	23	29	52	n/a	50	62.5	18.5	20.25	102	21.0
Two-seat	46	52	52	n/a	50	62.5	18.5	20.25	171	41.2
Three-seat	69	75	52	n/a	50	62.5	18.5	20.25	241	61.3
One-Seat (Plus)	30	36	52	n/a	50	62.5	18.5	20.25	128	27.1
<b>Twin Mid Height Back</b>										
One-Seat	23	29	52	n/a	37.5	50	18.5	20.25	99	15.1
Two-seat	46	52	52	n/a	37.5	50	18.5	20.25	166	29.6
Three-seat	69	75	52	n/a	37.5	50	18.5	20.25	234	44.1
One-Seat (Plus)	30	36	52	n/a	37.5	50	18.5	20.25	124	19.5

## COM YARDAGES

	Yardage Entire Unit	Yardage 2 Entire Units	Yardage 3 Entire Units	Yardage 4 Entire Units	Yardage per Back	Yardage per 2 Backs	Yardage per 3 Backs	Yardage per 4 Backs	Yardage per Seat	Yardage per 2 Seats	Yardage per 3 Seats	Yardage per 4 Seats
<b>Twin Full Height Back</b>												
One-Seat	5.03	8.73	13.76	17.46	2.93	4.53	7.46	9.06	2.1	4.2	6.3	8.4
Two-seat	7.93	14.23	22.16	28.46	4.53	7.73	12.26	15.46	3.4	6.5	9.9	13
Three-seat	10.48	20.76	31.24	41.52	5.88	11.76	17.64	23.52	4.6	9	13.6	18
One-Seat (Plus)	5.6	11.2	16.8	22.4	3.1	6.2	9.3	12.4	2.5	5	7.5	10
<b>Twin Mid Height Back</b>												
One-Seat	4.3	7.52	11.82	15.04	2.2	3.32	5.52	6.64	2.1	4.2	6.3	8.4
Two-seat	6.84	12.38	19.22	24.76	3.44	5.88	9.32	11.76	3.4	6.5	9.9	13
Three-seat	8.9	17.6	26.5	35.2	4.3	8.6	12.9	17.2	4.6	9	13.6	18
One-Seat (Plus)	5	10	15	20	2.5	5	7.5	10	2.5	5	7.5	10

## ZOLA PRIVACY PLUS UPGRADE OPTION UPCHARGES

	\$ List
Plus Upgrade Twin Two-Seat	259
Plus Upgrade Twin Three-Seat	388

NOTE: Twin One-Seat Plus pricing includes Plus Upgrade, for Two-Seat and Three-Seat add a "B" to the model number and the option upcharge (per unit) above.







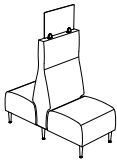

# ZOLA PRIVACY | TWIN MODULAR PANELS & MODULAR ARMS

## DIMENSIONS & COM REQUIREMENTS

		Overall Width	Overall Depth	Overall Height	Shipping Weight	Cubes	COM 1-unit	COM 2-units	COM 3-units	COM 4-units	COM 5-units	COM 6-units
Side Panel, Single, Full Height No Screen												
ZOP3-MPTF0U	Universal	2.75	51.5	43.9	66	6	4	5.5	9.34	12.03	14.72	18.7
ZOP3-MPTF0C	Center	2.75	51.5	43.9	66	6	4	5.5	9.34	12.03	14.72	18.7
Side Panel, Single, Full Height with Screen												
ZOP3-MPTF2U	Universal	2.75	51.5	56.4	68	6	4	5.5	9.34	12.03	14.72	18.7
ZOP3-MPTF2C	Center	2.75	51.5	56.4	68	6	4	5.5	9.34	12.03	14.72	18.7
Side Panel, Single, Mid Height No Screen												
ZOP3-MPTM0U	Universal	2.75	51.5	31.38	46	4	2.92	4.92	6.91	8.90	10.9	13.82
ZOP3-MPTM0C	Center	2.75	51.5	31.38	46	4	2.92	4.92	6.91	8.90	10.9	13.82
Side Panel, Single, Mid Height with Screen												
ZOP3-MPTM2U	Universal	2.75	51.5	43.88	48	4	2.92	4.92	6.91	8.90	10.9	13.82
ZOP3-MPTM2C	Center	2.75	51.5	43.88	48	4	2.92	4.92	6.91	8.90	10.9	13.82
Twin Semi-Private Side Panel, Single, Full Height												
ZOP3-MSPTF0U	Universal	2.75	26.5	44	43	2.5	2.69	5.38	8.06	10.75	13.44	16.13
ZOP3-MSPTF0C	Center	2.75	26.5	44	52	2.5	2.69	5.38	8.06	10.75	13.44	16.13
Twin Semi-Private Side Panel, Single, Mid Height												
ZOP3-MSPTM0U	Universal	2.75	26.5	31.4	32	1.7	1.75	3.99	5.98	7.97	9.97	11.96
ZOP3-MSPTM0C	Center	2.75	26.5	31.4	39	1.7	1.75	3.99	5.98	7.97	9.97	11.96
Twin Modular Upholstered Arm												
ZOP3-MATUPHU		3	14.5	19.75	22	2.5	2.11	3.56	5	6.5	7.9	9.33
ZOP3-MATUPHC		3	14.5	19.75	22	2.5	2.11	3.56	5	6.5	7.9	9.33
Twin Modular Upholstered Arm w/Urethane Cap												
ZOP3-MATUREU		3	14.5	20.25	16	1.8	2.11	3.56	5	6.5	7.9	9.33
ZOP3-MATUREC		3	14.5	20.25	16	1.8	2.11	3.56	5	6.5	7.9	9.33
Twin Modular Upholstered Arm w/Solid Surface Cap												
ZOP3-MATSSCU		3	14.5	20.25	16	1.8	2.11	3.56	5	6.5	7.9	9.33
ZOP3-MATSSCC		3	14.5	20.25	16	1.8	2.11	3.56	5	6.5	7.9	9.33

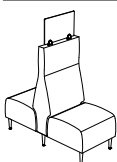







# ZOLA PRIVACY | TWIN SEATS

DESCRIPTION/MODEL	COM		COL		FABRIC GRADES			LEATHER	
	1	2	3	4	5	6	7	8	9
 Twin One-Seat, Full Height Back ZOP3-MT1F0F	2851	3016	3184	3424	3691	3932	4203	4533	4888
 Twin One-Seat, Full Height Back with Privacy Screen Option ZOP3-MT1F2F	3134	3299	3465	3707	3975	4214	4484	4816	5170
<b>ORDERING NOTES:</b> Units with Privacy Screen Option are not available with Removable Back Cover option.									
 Twin One-Seat, Mid Height Back ZOP3-MT1M0F	2713	2853	2995	3200	3430	3635	3866	4149	4454
 Twin One-Seat, Mid Height Back with Privacy Screen Option ZOP3-MT1M2F	2994	3136	3278	3483	3712	3918	4147	4432	4735
<b>ORDERING NOTES:</b> Units with Privacy Screen Option are not available with Removable Back Cover option.									
 Twin One-Seat Plus, Full Height Back ZOP3-MBT1F0F	3816	3982	4147	4389	4656	4897	5167	5498	5853
 Twin One-Seat Plus, Full Height Back with Privacy Screen Option ZOP3-MBT1F2F	4172	4339	4505	4744	5012	5255	5524	5856	6210
<b>ORDERING NOTES:</b> Units with Privacy Screen Option are not available with Removable Back Cover option.									
 Twin One-Seat Plus, Mid Height Back ZOP3-MBT1M0F	3664	3806	3949	4152	4381	4587	4817	5103	5404
 Twin One-Seat Plus, Mid Height Back with Privacy Screen Option ZOP3-MBT1M2F	4021	4162	4306	4507	4738	4944	5174	5457	5761
<b>ORDERING NOTES:</b> Units with Privacy Screen Option are not available with Removable Back Cover option.									

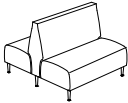
## PRODUCT CODE KEY

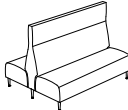
Line	Series	Chair Type	Seat Count	Back Type	Leg Type
ZOP Zola	3 Lounge	MT Modular Twin	1 One Seat	F0 Full Height Back	F Freestanding Unit
		MTB Modular Twin Plus Upgrade (page 39)	2 Two Seat	F2 Full Height Back with Privacy Screen Option	S Start Unit
			3 Three Seat	M0 Mid Height Back	C Center Unit
				M2 Mid Height Back with Privacy Screen Option	E End Unit

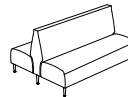

# ZOLA PRIVACY | TWIN SEATS

DESCRIPTION/MODEL	COM		COL		FABRIC GRADES			LEATHER	
	1	2	3	4	5	6	7	8	9
 Twin Two-Seat, Full Height Back ZOP3-MT2F0F	4235	4496	4756	5143	5578	5966	6399	6921	7516
 Twin Two-Seat, Full Height Back Privacy Screen Option ZOP3-MT2F2F	4723	4986	5245	5635	6069	6456	6889	7411	8008
<b>ORDERING NOTES:</b> Units with Privacy Screen Option are not available with Removable Back Cover option.									
 Twin Two-Seat, Mid Height Back ZOP3-MT2M0F	4029	4256	4480	4809	5174	5502	5868	6318	6808
 Twin Two-Seat, Mid Height Back with Privacy Screen Option ZOP3-MT2M2F	4520	4744	4970	5296	5664	5992	6359	6808	7298
<b>ORDERING NOTES:</b> Units with Privacy Screen Option are not available with Removable Back Cover option.									
 Twin Three-Seat, Full Height Back ZOP3-MT3F0F	5819	6155	6489	6962	7504	7977	8516	9186	9878
 Twin Three-Seat, Full Height Back Privacy Screen Option ZOP3-MT3F2F	6518	6854	7186	7660	8203	8678	9217	9885	10575
<b>ORDERING NOTES:</b> Units with Privacy Screen Option are not available with Removable Back Cover option.									
 Twin Three-Seat, Mid Height Back ZOP3-MT3M0F	5355	5649	5941	6363	6839	7260	7735	8324	8944
 Twin Three-Seat, Mid Height Back with Privacy Screen Option ZOP3-MT3M2F	6054	6348	6641	7064	7539	7961	8435	9023	9645
<b>ORDERING NOTES:</b> Units with Privacy Screen Option are not available with Removable Back Cover option.									

## PRODUCT CODE KEY

Line	Series	Chair Type	Seat Count	Back Type	Leg Type
ZOP Zola	3 Lounge	MT Modular Twin	1 One Seat	F0 Full Height Back	F Freestanding Unit
		MTB Modular Twin Plus Upgrade (page 39)	2 Two Seat	F2 Full Height Back with Privacy Screen Option	S Start Unit
			3 Three Seat	M0 Mid Height Back	C Center Unit
				M2 Mid Height Back with Privacy Screen Option	E End Unit

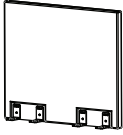
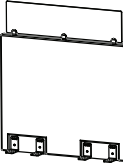
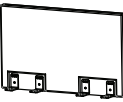
# ZOLA PRIVACY | TWIN - SIDE PANELS

DESCRIPTION/MODEL	COM		COL			FABRIC GRADES			LEATHER	
	1	2	3	4	5	6	7	8	9	
 Twin Side Panel, Full Height No Screen ZOP3-MPTF0U Universal End ZOP3-MPTF0C Center	1428	1559	1691	1955	2218	2483	2745	3010	3536	
	2139	2272	2405	2668	2932	3193	3457	3720	4248	
	<hr/>									
 Twin Side Panel,, Full Height with Screen ZOP3-MPTF2U Universal End ZOP3-MPTF2C Center	2006	2138	2271	2533	2798	3061	3324	3589	4114	
	2718	2851	2984	3246	3510	3772	4037	4297	4828	
	<hr/>									
 Twin Side Panel, Med. Height No Screen - ZOP3-MPTM0U Universal End ZOP3-MPTM0C Center	1187	1275	1363	1543	1720	1898	2077	2254	2610	
	1897	1988	2077	2254	2432	2610	2788	2965	3322	
	<hr/>									
 Twin Side Panel, Med. Height with Screen ZOP3-MPTM2U Universal End ZOP3-MPTM2C Center	1767	1855	1944	2122	2301	2479	2657	2833	3188	
	2478	2567	2657	2833	3011	3188	3367	3543	3902	

**ORDERING NOTE:** Side Panels will only connect to Center seating units. Units with Privacy Screen Option are not available with Removable Back Cover option. See [page 40](#) for dimensions and COM.

## PRODUCT CODE KEY

Line	Series	Chair Type	Height	Position
ZOP	3	MPT	F0	U
Zola	Lounge	Modular Side Panel Twin	Full Height	Universal (S or E)
			F2	C
			Full Height with Privacy Screen Option	Center /Interim
			M0	
			Mid Height	
			M2	
			Mid Height with Privacy Screen Option	

# ZOLA PRIVACY | TWIN SEMI-PRIVATE SIDE PANELS & MODULAR ARMS

DESCRIPTION/MODEL	COM		COL			FABRIC GRADES			LEATHER		
	1	2	3	4	5	6	7	8	9		
	Twin Semi-Private Side Panel, Single, Full Height										
	ZOP3-MSPTF0U	Universal	1012	1092	1172	1286	1415	1528	1659	1819	1981
	ZOP3-MSPTF0C	Center	1724	1804	1885	1999	2129	2240	2370	2532	2694

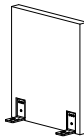
	Twin Semi-Private Side Panel, Single, Mid Height										
	ZOP3-MSPTM0U	Universal	868	919	973	1045	1131	1203	1288	1393	1497
	ZOP3-MSPTM0C	Center	1581	1633	1686	1758	1842	1915	2001	2106	2211

**ORDERING NOTE:** Semi-Private Side Panels will only connect to Center seating units. See [page 40](#) for dimensions and COM.

## PRODUCT CODE KEY

Line	Series	Type	Height	Position
ZOP	3	MSPT	F0	U
Zola	Lounge	Modular Arm Twin	Full Height	Universal (S or E)
			M0	C
			Mid Height	Center /Interim

# ZOLA PRIVACY | TWIN MODULAR ARMS

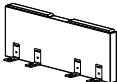
DESCRIPTION/MODEL	COM		COL			FABRIC GRADES			LEATHER		
	1	2	3	4	5	6	7	8	9		
	Twin Modular Upholstered Arm										
	ZOP3-MATUPHU		1120	1197	1262	1349	1451	1539	1641	1768	1894
	ZOP3-MATUPHC		1846	1909	1974	2062	2164	2253	2354	2481	2608
	Twin Modular Upholstered Arm w/Urethane Cap										
	ZOP3-MATUREU		1252	1329	1393	1481	1582	1670	1772	1899	2026
	ZOP3-MATUREC		1979	2041	2106	2193	2295	2384	2485	2612	2739

**ORDERING NOTE:** To specify Solid Surface Arm Caps on Modular Upholstered Arms, please add upcharge below and change UPH in the model number to SSC.

Zola Option Upcharges	Grades			
	A-White	A-Color	B	C
Solid Surface Arm Cap (per arm)	276	288	318	328

## PRODUCT CODE KEY

Line	Series	Type	Arm	Position
ZOP	3	MAT	UPH	U
Zola	Lounge	Modular Arm Twin	Upholstered	Universal (S or E)
			URE	C
			Upholstered Arm w/Urethane Cap	Center /Interim
			SSC	
			Upholstered Arm w/Solid Surface Cap	

# ZOLA PRIVACY | CURVED - DIMENSIONS

## DIMENSIONS

	Overall Width	Width with Arms	Overall Depth	Depth w/ Shelf	Overall Height	Overall Height w/Screen	Seat Height	Seat Depth	Shipping Weight	Cubes
<b>Curved Single-Seat - Full Height Back</b>										
30° Inside Curve	36	42	28.5	40.5	50	62.5	18.5	20.25	73	15
45° Inside Curve	42.5	48.5	29	41	50	62.5	18.5	20.25	81	19
60° Inside Curve	48.5	54.5	30	42	50	62.5	18.5	20.25	89	24
90° Inside Curve	59	65	31.5	43.5	50	62.5	18.5	20.25	111	36
30° Outside Curve	33.5	39.5	28.5	40.5	50	62.5	18.5	20.25	65	12
45° Outside Curve	39	45	29	41	50	62.5	18.5	20.25	67	13
60° Outside Curve	43.5	49.5	29	41	50	62.5	18.5	20.25	70	15
90° Outside Curve	52	58	30	42	50	62.5	18.5	20.25	75	16
<b>Curved Single-Seat - Mid Height Back</b>										
30° Inside Curve	36	42	28.5	40.5	37.5	50	18.5	20.25	68	13
45° Inside Curve	42.5	48.5	29	41	37.5	50	18.5	20.25	76	16
60° Inside Curve	48.5	54.5	30	42	37.5	50	18.5	20.25	83	20
90° Inside Curve	59	65	31.5	43.5	37.5	50	18.5	20.25	103	28
30° Outside Curve	33.5	39.5	28.5	40.5	37.5	50	18.5	20.25	62	10
45° Outside Curve	39	45	29	41	37.5	50	18.5	20.25	64	12
60° Outside Curve	43.5	49.5	29	42	37.5	50	18.5	20.25	67	13
90° Outside Curve	52	58	30	43.5	37.5	50	18.5	20.25	73	14
<b>Curved Double-Seat - Full Height Back</b>										
30° Inside Curve	58	64	30	42	50	62.5	18.5	20.25	117	28
45° Inside Curve	64.5	70.5	31.5	43.5	50	62.5	18.5	20.25	124	37
60° Inside Curve	70.5	76.5	33	45	50	62.5	18.5	20.25	132	46
90° Inside Curve	81	87	36	48	50	62.5	18.5	20.25	151	65
30° Outside Curve	55.5	61.5	29.5	41.5	50	62.5	18.5	20.25	101	24
45° Outside Curve	61	67	31	43	50	62.5	18.5	20.25	104	28
60° Outside Curve	65.5	71.5	32	44	50	62.5	18.5	20.25	110	32
90° Outside Curve	74.5	80.5	34.5	46.5	50	62.5	18.5	20.25	121	37
<b>Curved Double-Seat - Mid Height Back</b>										
30° Inside Curve	58	64	30	42	37.5	50	18.5	20.25	110	24
45° Inside Curve	64.5	70.5	31.5	43.5	37.5	50	18.5	20.25	116	31
60° Inside Curve	70.5	76.5	33	45	37.5	50	18.5	20.25	123	38
90° Inside Curve	81	87	36	48	37.5	50	18.5	20.25	141	52
30° Outside Curve	55.5	61.5	29.5	41.5	37.5	50	18.5	20.25	96	21
45° Outside Curve	61	67	31	43	37.5	50	18.5	20.25	99	25
60° Outside Curve	65.5	71.5	32	44	37.5	50	18.5	20.25	105	28
90° Outside Curve	74.5	80.5	34.5	46.5	37.5	50	18.5	20.25	115	32

### Upcharge for Plus Upgrade Option:

Option	\$ List	Option	\$ List
Plus Upgrade -Single-seat curve 30° seat	96	Plus Upgrade -Double-seat curve 30° seat	152
Plus Upgrade -Single-seat curve 45° seat	111	Plus Upgrade -Double-seat curve 45° seat	180
Plus Upgrade -Single-seat curve 60° seat	123	Plus Upgrade -Double-seat curve 60° seat	193
Plus Upgrade -Single-seat curve 90° seat	165	Plus Upgrade -Double-seat curve 90° seat	220

# ZOLA PRIVACY | CURVED - COM REQUIREMENTS







## COM YARDAGES

	Yardage Entire Unit	Yardage 2 Entire Units	Yardage 3 Entire Units	Yardage 4 Entire Units	Yardage per Back	Yardage per 2 Backs	Yardage per 3 Backs	Yardage per 4 Backs	Yardage per Seat	Yardage per 2 Seats	Yardage per 3 Seats	Yardage per 4 Seats
<b>Curved Single-Seat - Full Height Back</b>												
30° Inside Curve	5.2	10.4	15.6	20.8	3.4	6.8	10.2	13.6	1.8	3.6	5.4	7.2
45° Inside Curve	6.3	11.1	15.9	22.2	4.5	7.5	10.5	15	1.8	3.6	5.4	7.2
60° Inside Curve	6.7	12.2	17.67	24.37	4.9	8.6	12.27	17.17	1.8	3.6	5.4	7.2
90° Inside Curve	8.3	16.6	24.9	33.2	6.5	13	19.5	26	1.8	3.6	5.4	7.2
30° Outside Curve	5.3	9.2	13.1	18.4	3.5	5.6	7.7	11.2	1.8	3.6	5.4	7.2
45° Outside Curve	5.3	9.2	13.1	18.4	3.5	5.6	7.7	11.2	1.8	3.6	5.4	7.2
60° Outside Curve	5.3	9.2	13.1	18.4	3.5	5.6	7.7	11.2	1.8	3.6	5.4	7.2
90° Outside Curve	5.3	9.2	13.1	18.4	3.5	5.6	7.7	11.2	1.8	3.6	5.4	7.2
<b>Curved Single-Seat - Mid Height Back</b>												
30° Inside Curve	4.6	9.2	13.8	18.4	2.8	5.6	8.4	11.2	1.8	3.6	5.4	7.2
45° Inside Curve	5.1	9.1	13.15	18.7	3.3	5.5	7.75	11.5	1.8	3.6	5.4	7.2
60° Inside Curve	5.68	10.5	15.2	20.91	3.88	6.9	9.8	13.71	1.8	3.6	5.4	7.2
90° Inside Curve	6.5	13	19.5	26	4.7	9.4	14.1	18.8	1.8	3.6	5.4	7.2
30° Outside Curve	4.7	8.5	12.3	17	2.9	4.9	6.9	9.8	1.8	3.6	5.4	7.2
45° Outside Curve	4.7	8.5	12.3	17	2.9	4.9	6.9	9.8	1.8	3.6	5.4	7.2
60° Outside Curve	4.7	8.5	12.3	17	2.9	4.9	6.9	9.8	1.8	3.6	5.4	7.2
90° Outside Curve	4.7	8.5	12.3	17	2.9	4.9	6.9	9.8	1.8	3.6	5.4	7.2
<b>Curved Double-Seat - Full Height Back</b>												
30° Inside Curve	8.67	17.34	26.01	34.68	5.27	10.54	15.81	21.08	3.4	6.8	10.2	13.6
45° Inside Curve	9.37	18.74	28.11	37.48	5.97	11.94	17.91	23.88	3.4	6.8	10.2	13.6
60° Inside Curve	10.73	20.13	29.53	40.26	7.33	13.33	19.33	26.66	3.4	6.8	10.2	13.6
90° Inside Curve	11.15	20.93	30.73	41.88	7.75	14.13	20.53	28.28	3.4	6.8	10.2	13.6
30° Outside Curve	8.15	14.88	21.61	29.76	4.75	8.08	11.41	16.16	3.4	6.8	10.2	13.6
45° Outside Curve	8.15	14.88	21.61	29.76	4.75	8.08	11.41	16.16	3.4	6.8	10.2	13.6
60° Outside Curve	8.15	14.88	21.45	29.6	4.75	8.08	11.25	16	3.4	6.8	10.2	13.6
90° Outside Curve	8.15	14.88	21.61	29.76	4.75	8.08	11.41	16.16	3.4	6.8	10.2	13.6
<b>Curved Double-Seat - Mid Height Back</b>												
30° Inside Curve	7.8	15.6	23.4	31.2	4.4	8.8	13.2	17.6	3.4	6.8	10.2	13.6
45° Inside Curve	8.09	16.18	24.27	32.36	4.69	9.38	14.07	18.76	3.4	6.8	10.2	13.6
60° Inside Curve	8.9	16.8	24.7	33.6	5.5	10	14.5	20	3.4	6.8	10.2	13.6
90° Inside Curve	8.9	16.8	24.7	33.6	5.5	10	14.5	20	3.4	6.8	10.2	13.6
30° Outside Curve	7.15	13.25	19.7	26.5	3.75	6.45	9.5	12.9	3.4	6.8	10.2	13.6
45° Outside Curve	7.15	13.25	19.7	26.5	3.75	6.45	9.5	12.9	3.4	6.8	10.2	13.6
60° Outside Curve	6.8	12.6	18.4	25.2	3.4	5.8	8.2	11.6	3.4	6.8	10.2	13.6
90° Outside Curve	7.15	13.25	19.7	26.5	3.75	6.45	9.5	12.9	3.4	6.8	10.2	13.6

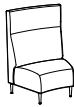
### Upcharge for Removable Upholstery Covers:

Option	\$ List	Option	\$ List
Single-seat curve 30° seat	61	Double-seat curve 30° seat	93
Single-seat curve 45° seat	64	Double-seat curve 45° seat	101
Single-seat curve 60° seat	86	Double-seat curve 60° seat	123
Single-seat curve 90° seat	113	Double-seat curve 90° seat	127

# ZOLA PRIVACY | CURVED

DESCRIPTION/MODEL/SPECIES	COM		COL		FABRIC GRADES			LEATHER	
	1	2	3	4	5	6	7	8	9
 Single-Seat, 30° Inside Curve, Full Height Back ZOP3-MCIS30DF0F	3430	3618	3806	4068	4369	4634	4931	5308	5684
 Single-Seat, 30° Inside Curve, Full Height Back with Shelf ZOP3-MCIS30DF1_ Beech/Laminate	4047	4236	4423	4686	4987	5250	5549	5925	6300
Maple/Palette	4141	4328	4515	4781	5080	5344	5642	6019	6394
<b>ORDERING NOTE:</b> When ordering a back with Shelf option please clearly specify on your order the required Shelf Height - 42", 36" or 30" and chose required leg type below. Freestanding, Start and End units with the shelf option require counterbalance weight added to each seat unit, please add <b>303 list</b> upcharge per unit.									
 Single-Seat, 30° Inside Curve, Full Height Back with Privacy Screen ZOP3-MCIS30DF2F	4023	4212	4398	4664	4962	5227	5527	5902	6277
 Single-Seat, 30° Inside Curve, Mid Height Back ZOP3-MCIS30DM0F	3273	3437	3604	3834	4098	4328	4592	4922	5250
 Single-Seat, 30° Inside Curve, Mid Height Back with Shelf ZOP3-MCIS30DM1_ Beech/Laminate	3892	4058	4221	4454	4715	4946	5211	5539	5868
Maple/Palette	3984	4149	4315	4545	4811	5038	5303	5634	5962
<b>ORDERING NOTE:</b> When ordering a back with Shelf option please clearly specify on your order the required Shelf Height - 36" or 30" and chose required leg type below. Freestanding, Start and End units with the shelf option require counterbalance weight added to each seat unit, please add <b>303 list</b> upcharge per unit.									
 Single-Seat, 30° Inside Curve, Mid Height Back with Privacy Screen Option ZOP3-MCIS30DM2F	3867	4033	4197	4427	4691	4922	5187	5516	5844







Zola Privacy Option Upcharges	\$ List		\$ List
Moisture Barrier & CAL 133(per yard)	64	Plus Upgrade - Single-Seat, 30° Curve	96
Seat Power (per unit)	641	Dual Leg (for Multiple unit configurations)	80
Shelf Power	599	Removable Seat Covers -Single-Seat, 30° Curve	61
Table Power	589	<b>Note:</b> Removable back covers are not available on curved backs	
Combination Upholstery - dual fabrics	33		

## PRODUCT CODE KEY

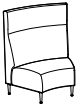
Line	Series	Chair Type	Curve Style	Seat Degree	Back Type	Leg Type
ZOP Zola	3 Lounge	MC Modular Curve	IS Inside Curve -Single	30D	F0 Full Height Back	F Freestanding Unit
		MCB Modular Curve Plus	ID Inside Curve -Double	45D	F1 Full Height Back with Shelf Option	S Start Unit
			OS Outside Curve -Single	60D	F2 Full Height Back with Privacy Screen Option	C Center Unit
			OD Outside Curve -Double	90D	M0 Mid Height Back	E End Unit
					M1 Mid Height Back with Shelf Option	
					M2 Mid Height Back with Privacy Screen Options	



# ZOLA PRIVACY | CURVED

DESCRIPTION/MODEL/SPECIES	COM		COL	FABRIC GRADES			LEATHER		
	1	2	3	4	5	6	7	8	9
 Single-Seat, 45° Inside Curve, Full Height Back ZOP3-MCIS450DF0F	3847	4057	4263	4565	4904	5209	5548	5964	6418
 Single-Seat, 45° Inside Curve, Full Height Back with Shelf ZOP3-MCIS45DF1_ Beech/Laminate	4483	4690	4898	5201	5539	5841	6184	6599	7051
Maple/Palette	4576	4785	4993	5295	5635	5938	6280	6691	7148
<b>ORDERING NOTE:</b> When ordering a back with Shelf option please clearly specify on your order the required Shelf Height - 42", 36" or 30" and chose required leg type below. Freestanding, Start and End units with the shelf option require counterbalance weight added to each seat unit, please add <b>303 list</b> upcharge per unit.									
 Single-Seat, 45° Inside Curve, Full Height Back with Privacy Screen ZOP3-MCIS45DF2F	4447	4655	4863	5167	5506	5809	6149	6565	7018
 Single-Seat, 45° Inside Curve, Mid Height Back ZOP3-MCIS45DM0F	3642	3811	3979	4215	4486	4722	4994	5329	5673
 Single-Seat, 45° Inside Curve, Mid Height Back with Shelf ZOP3-MCIS45DM1_ Beech/Laminate	4278	4444	4614	4848	5121	5360	5631	5965	6307
Maple/Palette	4371	4539	4709	4945	5216	5453	5722	6059	6402
<b>ORDERING NOTE:</b> When ordering a back with Shelf option please clearly specify on your order the required Shelf Height - 36" or 30" and chose required leg type below. Freestanding, Start and End units with the shelf option require counterbalance weight added to each seat unit, please add <b>303 list</b> upcharge per unit.									
 Single-Seat, 45° Inside Curve, Mid Height Back with Privacy Screen Option ZOP3-MCIS45DM2F	4243	4411	4580	4816	5086	5323	5595	5931	6271







## Zola Privacy Option Upcharges

	\$ List		\$ List
Moisture Barrier & CAL 133(per yard)	64	Plus Upgrade -Single-Seat, 45° Curve	111
Seat Power (per unit)	641	Dual Leg (for Multiple unit configurations)	80
Shelf Power	599	Removable Seat Covers -Single-Seat, 45° Curve	64
Table Power	589	<b>Note:</b> Removable back covers are not available on curved backs	
Combination Upholstery - dual fabrics	33		

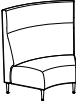
## PRODUCT CODE KEY

Line	Series	Chair Type	Curve Style	Seat Degree	Back Type	Leg Type
ZOP Zola	3 Lounge	MC Modular Curve	IS Inside Curve -Single	30D	F0 Full Height Back	F Freestanding Unit
		MCB Modular Curve Plus	ID Inside Curve -Double	45D	F1 Full Height Back with Shelf Option	S Start Unit
			OS Outside Curve -Single	60D	F2 Full Height Back with Privacy Screen Option	C Center Unit
			OD Outside Curve -Double	90D	M0 Mid Height Back	E End Unit
					M1 Mid Height Back with Shelf Option	
					M2 Mid Height Back with Privacy Screen Options	

# ZOLA PRIVACY | CURVED







DESCRIPTION/MODEL/SPECIES	COM		COL	FABRIC GRADES			LEATHER		
	1	2	3	4	5	6	7	8	9
 Single-Seat, 60° Inside Curve, Full Height Back ZOP3-MCIS60DF0F	4371	4634	4891	5267	5696	6067	6492	7012	7567
 Single-Seat, 60° Inside Curve, Full Height Back with Shelf ZOP3-MCIS60DF1_ Beech/Laminate	5185	5444	5705	6080	6504	6879	7303	7822	8380
Maple/Palette	5281	5541	5800	6179	6600	6974	7399	7920	8474
<b>ORDERING NOTE:</b> When ordering a back with Shelf option please clearly specify on your order the required Shelf Height - 42", 36" or 30" and chose required leg type below. Freestanding, Start and End units with the shelf option require counterbalance weight added to each seat unit, please add <b>303 list</b> upcharge per unit.									
 Single-Seat, 60° Inside Curve, Full Height Back with Privacy Screen ZOP3-MCIS60DF2F	4974	5236	5496	5870	6293	6670	7093	7615	8169
 Single-Seat, 60° Inside Curve, Mid Height Back ZOP3-MCIS60DM0F	4164	4350	4537	4801	5103	5364	5664	6039	6416
 Single-Seat, 60° Inside Curve, Mid Height Back with Shelf ZOP3-MCIS60DM1_ Beech/Laminate	4977	5164	5351	5614	5914	6179	6477	6852	7229
Maple/Palette	5072	5259	5447	5712	6009	6271	6574	6946	7324
<b>ORDERING NOTE:</b> When ordering a back with Shelf option please clearly specify on your order the required Shelf Height - 36" or 30" and chose required leg type below. Freestanding, Start and End units with the shelf option require counterbalance weight added to each seat unit, please add <b>303 list</b> upcharge per unit.									
 Single-Seat, 60° Inside Curve, Mid Height Back with Privacy Screen Option ZOP3-MCIS60DM2F	4767	4953	5141	5406	5705	5968	6268	6642	7019

Zola Privacy Option Upcharges	\$ List	\$ List
Moisture Barrier & CAL 133 (per yard)	64	Plus Upgrade - Single-Seat, 60° Curve 123
Seat Power (per unit)	641	Dual Leg (for Multiple unit configurations) 80
Shelf Power	599	Removable Seat Covers -Single-Seat, 60° Curve 86
Table Power	589	<b>Note:</b> Removable Back Cover are not available on curved backs
Combination Upholstery - dual fabrics	33	

## PRODUCT CODE KEY

Line	Series	Chair Type	Curve Style	Seat Degree	Back Type	Leg Type
ZOP	3	MC	IS	30D	F0	F
Zola	Lounge	Modular Curve	Inside Curve -Single		Full Height Back	Freestanding Unit
		MCB	ID	45D	F1	S
		Modular Curve Plus	Inside Curve -Double		Full Height Back with Shelf Option	Start Unit
			OS	60D	F2	C
			Outside Curve -Single		Full Height Back with Privacy Screen Option	Center Unit
			OD	90D	M0	E
			Outside Curve -Double		Mid Height Back	End Unit
					M1	
					Mid Height Back with Shelf Option	
					M2	
					Mid Height Back with Privacy Screen Options	

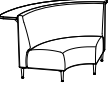
# ZOLA PRIVACY | CURVED

DESCRIPTION/MODEL/SPECIES	COM		COL		FABRIC GRADES			LEATHER	
	1	2	3	4	5	6	7	8	9
 Single-Seat, 90° Inside Curve, Full Height Back ZOP3-MCIS90DF0F	4992	5263	5538	5920	6359	6742	7180	7728	8275
 Single-Seat, 90° Inside Curve, Full Height Back with Shelf ZOP3-MCIS90DF1_	Beech/Laminate 5866	6139	6412	6795	7234	7616	8055	8599	9147
	Maple/Palette 5964	6237	6511	6894	7331	7713	8152	8698	9246
<b>ORDERING NOTE:</b> When ordering a back with Shelf option please clearly specify on your order the required Shelf Height - 42", 36" or 30" and chose required leg type below. Freestanding, Start and End units with the shelf option require counterbalance weight added to each seat unit, please add <b>303 list</b> upcharge per unit.									
 Single-Seat, 90° Inside Curve, Full Height Back with Privacy Screen ZOP3-MCIS90DF2F	5943	6216	6492	6872	7311	7695	8131	8679	9225
 Single-Seat, 90° Inside Curve, Mid Height Back ZOP3-MCIS90DM0F	4571	4786	5000	5299	5641	5943	6286	6713	7144
 Single-Seat, 90° Inside Curve, Mid Height Back with Shelf ZOP3-MCIS90DM1_	Beech/Laminate 5444	5660	5873	6174	6516	6818	7159	7587	8015
	Maple/Palette 5544	5758	5971	6270	6612	6914	7258	7684	8115
<b>ORDERING NOTE:</b> When ordering a back with Shelf option please clearly specify on your order the required Shelf Height - 36" or 30" and chose required leg type below. Freestanding, Start and End units with the shelf option require counterbalance weight added to each seat unit, please add <b>303 list</b> upcharge per unit.									
 Single-Seat, 90° Inside Curve, Mid Height Back with Privacy Screen Option ZOP3-MCIS90DM2F	5524	5739	5953	6252	6595	6895	7237	7662	8093







### Zola Privacy Option Upcharges

	\$ List	\$ List
Moisture Barrier & CAL 133 (per yard)	64	Plus Upgrade - Single-Seat, 90° Curve 165
Seat Power (per unit)	641	Dual Leg (for Multiple unit configurations) 80
Shelf Power	599	Removable Seat Covers -Single-Seat, 90° Curve 113
Table Power	589	<b>Note:</b> Removable Back Cover are not available on curved backs
Combination Upholstery - dual fabrics	33	

### PRODUCT CODE KEY

Line	Series	Chair Type	Curve Style	Seat Degree	Back Type	Leg Type
ZOP Zola	3 Lounge	MC Modular Curve	IS Inside Curve -Single	30D	F0 Full Height Back	F Freestanding Unit
		MCB Modular Curve Plus	ID Inside Curve -Double	45D	F1 Full Height Back with Shelf Option	S Start Unit
			OS Outside Curve -Single	60D	F2 Full Height Back with Privacy Screen Option	C Center Unit
			OD Outside Curve -Double	90D	M0 Mid Height Back	E End Unit
					M1 Mid Height Back with Shelf Option	
					M2 Mid Height Back with Privacy Screen Options	

# ZOLA PRIVACY | CURVED







DESCRIPTION/MODEL/SPECIES	COM		COL		FABRIC GRADES			LEATHER		
	1	2	3	4	5	6	7	8	9	
 Single-Seat, 30° Outside Curve, Full Height Back ZOP3-MCOS30DF0F	3252	3431	3609	3859	4145	4395	4680	5036	5392	
 Single-Seat, 30° Outside Curve, Full Height Back with Shelf ZOP3-MCOS30DF1_ Beech/Laminate	3554	3732	3910	4160	4444	4693	4979	5337	5692	
Maple/Palette	3642	3819	3999	4248	4533	4784	5068	5425	5782	
<b>ORDERING NOTE:</b> When ordering a back with Shelf option please clearly specify on your order the required Shelf Height - 42", 36" or 30" and chose required leg type below. Freestanding, Start and End units with the shelf option require counterbalance weight added to each seat unit, please add <b>303 list</b> upcharge per unit.										
 Single-Seat, 30° Outside Curve, Full Height Back with Privacy Screen ZOP3-MCOS30DF2F	3607	3786	3963	4214	4500	4749	5034	5391	5746	
 Single-Seat, 30° Outside Curve, Mid Height Back ZOP3-MCOS30DM0F	3135	3290	3445	3664	3914	4131	4380	4690	5007	
 Single-Seat, 30° Outside Curve, Mid Height Back with Shelf ZOP3-MCOS30DM1_ Beech/Laminate	3433	3589	3743	3962	4213	4429	4680	4990	5307	
Maple/Palette	3522	3679	3831	4053	4299	4520	4769	5079	5394	
<b>ORDERING NOTE:</b> When ordering a back with Shelf option please clearly specify on your order the required Shelf Height - 36" or 30" and chose required leg type below. Freestanding, Start and End units with the shelf option require counterbalance weight added to each seat unit, please add <b>303 list</b> upcharge per unit.										
 Single-Seat, 30° Outside Curve, Mid Height Back with Privacy Screen Option ZOP3-MCOS30DM2F	3489	3643	3797	4019	4267	4485	4735	5043	5362	

Zola Privacy Option Upcharges	\$ List	\$ List
Moisture Barrier & CAL 133 (per yard)	64	Plus Upgrade - Single-Seat, 30° Curve
Seat Power (per unit)	641	Dual Leg (for Multiple unit configurations)
Shelf Power	599	Removable Seat Covers -Single-Seat, 30° Curve
Table Power	589	<b>Note:</b> Removable back covers are not available on curved backs
Combination Upholstery - dual fabrics	33	

## PRODUCT CODE KEY

Line	Series	Chair Type	Curve Style	Seat Degree	Back Type	Leg Type
ZOP	3	MC	IS	30D	F0	F
Zola	Lounge	Modular Curve	Inside Curve -Single		Full Height Back	Freestanding Unit
		MCB	ID	45D	F1	S
		Modular Curve Plus	Inside Curve -Double		Full Height Back with Shelf Option	Start Unit
			OS	60D	F2	C
			Outside Curve -Single		Full Height Back with Privacy Screen Option	Center Unit
			OD	90D	M0	E
			Outside Curve -Double		Mid Height Back	End Unit
					M1	
					Mid Height Back with Shelf Option	
					M2	
					Mid Height Back with Privacy Screen Options	

# ZOLA PRIVACY | CURVED







DESCRIPTION/MODEL/SPECIES	COM		COL	FABRIC GRADES			LEATHER		
	1	2	3	4	5	6	7	8	9
 Single-Seat, 45° Outside Curve, Full Height Back ZOP3-MCOS45DF0F	3508	3685	3864	4113	4398	4648	4932	5288	5646
 Single-Seat, 45° Outside Curve, Full Height Back with Shelf ZOP3-MCOS45DF1_ Beech/Laminate	3803	3981	4158	4407	4693	4944	5230	5584	5941
Maple/Palette	3892	4068	4247	4499	4784	5033	5318	5674	6031
<b>ORDERING NOTE:</b> When ordering a back with Shelf option please clearly specify on your order the required Shelf Height - 42", 36" or 30" and chose required leg type below. Freestanding, Start and End units with the shelf option require counterbalance weight added to each seat unit, please add <b>303 list</b> upcharge per unit.									
 Single-Seat, 45° Outside Curve, Full Height Back with Privacy Screen ZOP3-MCOS45DF2F	3859	4038	4215	4466	4752	5002	5286	5641	5999
 Single-Seat, 45° Outside Curve, Mid Height Back ZOP3-MCOS45DM0F	3382	3536	3690	3909	4158	4378	4628	4937	5254
 Single-Seat, 45° Outside Curve, Mid Height Back with Shelf ZOP3-MCOS45DM1_ Beech/Laminate	3678	3830	3985	4205	4455	4672	4922	5232	5547
Maple/Palette	3766	3920	4074	4292	4542	4762	5010	5320	5636
<b>ORDERING NOTE:</b> When ordering a back with Shelf option please clearly specify on your order the required Shelf Height - 36" or 30" and chose required leg type below. Freestanding, Start and End units with the shelf option require counterbalance weight added to each seat unit, please add <b>303 list</b> upcharge per unit.									
 Single-Seat, 45° Outside Curve, Mid Height Back with Privacy Screen Option ZOP3-MCOS45DM2F	3735	3890	4042	4261	4510	4730	4979	5288	5605

Zola Privacy Option Upcharges	\$ List	\$ List
Moisture Barrier & CAL 133 (per yard)	64	Plus Upgrade - Single-Seat, 45° Curve 111
Seat Power (per unit)	641	Dual Leg (for Multiple unit configurations) 80
Shelf Power	599	Removable Seat Covers -Single-Seat, 45° Curve 64
Table Power	589	<b>Note:</b> Removable back covers are not available on curved backs
Combination Upholstery - dual fabrics	33	

## PRODUCT CODE KEY

Line	Series	Chair Type	Curve Style	Seat Degree	Back Type	Leg Type
ZOP Zola	3 Lounge	MC Modular Curve	IS Inside Curve -Single	30D	F0 Full Height Back	F Freestanding Unit
		MCB Modular Curve Plus	ID Inside Curve -Double	45D	F1 Full Height Back with Shelf Option	S Start Unit
			OS Outside Curve -Single	60D	F2 Full Height Back with Privacy Screen Option	C Center Unit
			OD Outside Curve -Double	90D	M0 Mid Height Back	E End Unit
					M1 Mid Height Back with Shelf Option	
					M2 Mid Height Back with Privacy Screen Options	

# ZOLA PRIVACY | CURVED







DESCRIPTION/MODEL/SPECIES	COM		COL		FABRIC GRADES			LEATHER	
	1	2	3	4	5	6	7	8	9
 Single-Seat, 60° Outside Curve, Full Height Back ZOP3-MCOS60DF0F	3655	3831	4011	4261	4546	4795	5082	5437	5793
 Single-Seat, 60° Outside Curve, Full Height Back with Shelf ZOP3-MCOS60DF1_ Beech/Laminate	3948	4125	4305	4553	4838	5086	5370	5727	6083
Maple/Palette	4036	4213	4393	4641	4927	5176	5463	5815	6174
<b>ORDERING NOTES:</b> When ordering a back with Shelf option please clearly specify on your order the required Shelf Height - 42", 36" or 30" and chose required leg type below. Freestanding, Start and End units with the shelf option require counterbalance weight added to each seat unit, please add <b>303 list</b> upcharge per unit.									
 Single-Seat, 60° Outside Curve, Full Height Back with Privacy Screen ZOP3-MCOS60DF2F	3988	4168	4347	4595	4882	5131	5416	5769	6127
 Single-Seat, 60° Outside Curve, Mid Height Back ZOP3-MCOS60DM0F	3535	3690	3846	4064	4313	4532	4781	5091	5407
 Single-Seat, 60° Outside Curve, Mid Height Back with Shelf ZOP3-MCOS60DM1_ Beech/Laminate	3825	3982	4138	4354	4604	4822	5071	5384	5696
Maple/Palette	3915	4070	4224	4443	4692	4914	5160	5471	5786
<b>ORDERING NOTE:</b> When ordering a back with Shelf option please clearly specify on your order the required Shelf Height - 36" or 30" and chose required leg type below. Freestanding, Start and End units with the shelf option require counterbalance weight added to each seat unit, please add <b>303 list</b> upcharge per unit.									
 Single-Seat, 60° Outside Curve, Mid Height Back with Privacy Screen Option ZOP3-MCOS60DM2F	3869	4024	4180	4397	4646	4866	5113	5425	5741

Zola Privacy Option Upcharges	\$ List	\$ List
Moisture Barrier & CAL 133 (per yard)	64	Plus Upgrade - Single-Seat, 60° Curve 123
Seat Power (per unit)	641	Dual Leg (for Multiple unit configurations) 80
Shelf Power	599	Removable Seat Covers -Single-Seat, 60° Curve 86
Table Power	589	<b>Note:</b> Removable back covers are not available on curved backs
Combination Upholstery - dual fabrics	33	

## PRODUCT CODE KEY

Line	Series	Chair Type	Curve Style	Seat Degree	Back Type	Leg Type
ZOP Zola	3 Lounge	MC Modular Curve	IS Inside Curve -Single	30D	F0 Full Height Back	F Freestanding Unit
		MCB Modular Curve Plus	ID Inside Curve -Double	45D	F1 Full Height Back with Shelf Option	S Start Unit
			OS Outside Curve -Single	60D	F2 Full Height Back with Privacy Screen Option	C Center Unit
			OD Outside Curve -Double	90D	M0 Mid Height Back	E End Unit
					M1 Mid Height Back with Shelf Option	
					M2 Mid Height Back with Privacy Screen Options	

# ZOLA PRIVACY | CURVED

DESCRIPTION/MODEL/SPECIES	COM		COL	FABRIC GRADES			LEATHER		
	1	2	3	4	5	6	7	8	9
 Single-Seat, 90° Outside Curve, Full Height Back ZOP3-MCOS90DF0F	4405	4586	4763	5011	5298	5547	5833	6188	6545
 Single-Seat, 90° Outside Curve, Full Height Back with Shelf ZOP3-MCOS90DF1_ Beech/Laminate	4686	4866	5043	5293	5579	5828	6113	6470	6828
Maple/Palette	4773	4952	5131	5381	5664	5914	6199	6556	6913
<b>ORDERING NOTE:</b> When ordering a back with Shelf option please clearly specify on your order the required Shelf Height - 42", 36" or 30" and chose required leg type below. Freestanding, Start and End units with the shelf option require counterbalance weight added to each seat unit, please add <b>303 list</b> upcharge per unit.									
 Single-Seat, 90° Outside Curve, Full Height Back with Privacy Screen ZOP3-MCOS90DF2F	4737	4918	5095	5344	5631	5878	6163	6520	6877
 Single-Seat, 90° Outside Curve, Mid Height Back ZOP3-MCOS90DM0F	3949	4103	4258	4477	4725	4944	5192	5503	5821
 Single-Seat, 90° Outside Curve, Mid Height Back with Shelf ZOP3-MCOS90DM1_ Beech/Laminate	4229	4382	4537	4757	5007	5223	5473	5784	6102
Maple/Palette	4315	4469	4623	4843	5093	5310	5560	5869	6186
<b>ORDERING NOTE:</b> When ordering a back with Shelf option please clearly specify on your order the required Shelf Height - 36" or 30" and chose required leg type below. Freestanding, Start and End units with the shelf option require counterbalance weight added to each seat unit, please add <b>303 list</b> upcharge per unit.									
 Single-Seat, 90° Outside Curve, Mid Height Back with Privacy Screen Option ZOP3-MCOS90DM2F	4279	4433	4588	4810	5057	5275	5525	5834	6153







## Zola Privacy Option Upcharges

	\$ List	\$ List
Moisture Barrier & CAL 133 (per yard)	64	Plus Upgrade - Single-Seat, 90° Curve 165
Seat Power (per unit)	641	Dual Leg (for Multiple unit configurations) 80
Shelf Power	599	Removable Seat Covers -Single-Seat, 90° Curve 113
Table Power	589	<b>Note:</b> Removable back covers are not available on curved backs
Combination Upholstery - dual fabrics	33	

## PRODUCT CODE KEY

Line	Series	Chair Type	Curve Style	Seat Degree	Back Type	Leg Type
ZOP Zola	3 Lounge	MC Modular Curve	IS Inside Curve -Single	30D	F0 Full Height Back	F Freestanding Unit
		MCB Modular Curve Plus	ID Inside Curve -Double	45D	F1 Full Height Back with Shelf Option	S Start Unit
			OS Outside Curve -Single	60D	F2 Full Height Back with Privacy Screen Option	C Center Unit
			OD Outside Curve -Double	90D	M0 Mid Height Back	E End Unit
					M1 Mid Height Back with Shelf Option	
					M2 Mid Height Back with Privacy Screen Options	

# ZOLA PRIVACY | CURVED

DESCRIPTION/MODEL/SPECIES	COM		COL		FABRIC GRADES			LEATHER	
	1	2	3	4	5	6	7	8	9
 Double-Seat, 30° Inside Curve, Full Height Back ZOP3-MCID30DF0F	4943	5245	5548	5973	6461	6884	7368	7973	8581
 Double-Seat, 30° Inside Curve, Full Height Back with Shelf ZOP3-MCID30DF1_ Beech/Laminate	5715	6017	6319	6745	7230	7655	8141	8745	9353
Maple/Palette	5811	6114	6418	6842	7329	7754	8236	8843	9447
<b>ORDERING NOTE:</b> When ordering a back with Shelf option please clearly specify on your order the required Shelf Height - 42", 36" or 30" and chose required leg type below. Freestanding, Start and End units with the shelf option require counterbalance weight added to each seat unit, please add <b>303 list</b> upcharge per unit.									
 Double-Seat, 30° Inside Curve, Full Height Back with Privacy Screen ZOP3-MCID30DF2F	5888	6190	6494	6918	7403	7829	8312	8918	9525
 Double-Seat, 30° Inside Curve, Mid Height Back ZOP3-MCID30DM0F	4678	4932	5191	5552	5964	6322	6734	7248	7762
 Double-Seat, 30° Inside Curve, Mid Height Back with Shelf ZOP3-MCID30DM1_ Beech/Laminate	5448	5705	5964	6322	6734	7093	7506	8017	8535
Maple/Palette	5546	5802	6060	6420	6832	7191	7603	8117	8632
<b>ORDERING NOTE:</b> When ordering a back with Shelf option please clearly specify on your order the required Shelf Height - 36" or 30" and chose required leg type below. Freestanding, Start and End units with the shelf option require counterbalance weight added to each seat unit, please add <b>303 list</b> upcharge per unit.									
 Double-Seat, 30° Inside Curve, Mid Height Back with Privacy Screen Option ZOP3-MCID30DM2F	5620	5878	6137	6496	6909	7267	7680	8193	8706

## Zola Privacy Option Upcharges





	\$ List		\$ List
Moisture Barrier & CAL 133 (per yard)	64	Plus Upgrade - Double-Seat, 30° Curve	152
Seat Power (per unit)	641	Dual Leg (for Multiple unit configurations)	80
Shelf Power	599	Removable Seat Covers -Double-Seat, 30° Curve	93
Table Power	589	<b>Note:</b> Removable back covers are not available on curved backs	
Combination Upholstery - dual fabrics	33		

## PRODUCT CODE KEY

Line	Series	Chair Type	Curve Style	Seat Degree	Back Type	Leg Type
ZOP Zola	3 Lounge	MC Modular Curve	IS Inside Curve -Single	30D	F0 Full Height Back	F Freestanding Unit
		MCB Modular Curve Plus	ID Inside Curve -Double	45D	F1 Full Height Back with Shelf Option	S Start Unit
			OS Outside Curve -Single	60D	F2 Full Height Back with Privacy Screen Option	C Center Unit
			OD Outside Curve -Double	90D	M0 Mid Height Back	E End Unit
					M1 Mid Height Back with Shelf Option	
					M2 Mid Height Back with Privacy Screen Options	

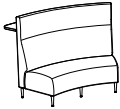

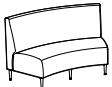
# ZOLA PRIVACY | CURVED

DESCRIPTION/MODEL/SPECIES	COM		COL	FABRIC GRADES			LEATHER		
	1	2	3	4	5	6	7	8	9
 Double-Seat, 45° Inside Curve, Full Height Back ZOP3-MCID45DF0F	5360	5666	5975	6411	6909	7343	7839	8457	9086
 Double-Seat, 45° Inside Curve, Full Height Back with Shelf ZOP3-MCID45DF1_ Beech/Laminate	6161	6469	6779	7214	7711	8146	8643	9261	9887
Maple/Palette	6260	6568	6877	7314	7809	8247	8741	9359	9988
<b>ORDERING NOTE:</b> When ordering a back with Shelf option please clearly specify on your order the required Shelf Height - 42", 36" or 30" and chose required leg type below. Freestanding, Start and End units with the shelf option require counterbalance weight added to each seat unit, please add <b>303 list</b> upcharge per unit.									
 Double-Seat, 45° Inside Curve, Full Height Back with Privacy Screen ZOP3-MCID45DF2F	6313	6621	6931	7367	7863	8298	8792	9412	10041
 Double-Seat, 45° Inside Curve, Mid Height Back ZOP3-MCID45DM0F	5103	5367	5635	6014	6444	6822	7255	7787	8340
 Double-Seat, 45° Inside Curve, Mid Height Back with Shelf ZOP3-MCID45DM1_ Beech/Laminate	5904	6170	6438	6817	7248	7625	8056	8590	9143
Maple/Palette	6003	6269	6537	6914	7345	7725	8155	8688	9241
<b>ORDERING NOTE:</b> When ordering a back with Shelf option please clearly specify on your order the required Shelf Height - 36" or 30" and chose required leg type below. Freestanding, Start and End units with the shelf option require counterbalance weight added to each seat unit, please add <b>303 list</b> upcharge per unit.									
 Double-Seat, 45° Inside Curve, Mid Height Back with Privacy Screen Option ZOP3-MCID45DM2F	6055	6322	6587	6968	7399	7778	8207	8741	9295







## Zola Privacy Option Upcharges

	\$ List	\$ List
Moisture Barrier & CAL 133 (per yard)	64	Plus Upgrade - Double-Seat, 45° Curve
Seat Power (per unit)	641	Dual Leg (for Multiple unit configurations)
Shelf Power	599	Removable Seat Covers -Double-Seat, 45° Curve
Table Power	589	<b>Note:</b> Removable back covers are not available on curved backs
Combination Upholstery - dual fabrics	33	

## PRODUCT CODE KEY

Line	Series	Chair Type	Curve Style	Seat Degree	Back Type	Leg Type
ZOP Zola	3 Lounge	MC Modular Curve	IS Inside Curve -Single	30D	F0 Full Height Back	F Freestanding Unit
		MCB Modular Curve Plus	ID Inside Curve -Double	45D	F1 Full Height Back with Shelf Option	S Start Unit
			OS Outside Curve -Single	60D	F2 Full Height Back with Privacy Screen Option	C Center Unit
			OD Outside Curve -Double	90D	M0 Mid Height Back	E End Unit
					M1 Mid Height Back with Shelf Option	
					M2 Mid Height Back with Privacy Screen Options	

# ZOLA PRIVACY | CURVED



DESCRIPTION/MODEL/SPECIES	COM		COL		FABRIC GRADES			LEATHER	
	1	2	3	4	5	6	7	8	9
 Double-Seat, 60° Inside Curve, Full Height Back ZOP3-MCID60DF0F	5910	6263	6616	7127	7704	8215	8791	9499	10262
 Double-Seat, 60° Inside Curve, Full Height Back with Shelf ZOP3-MCID60DF1_ Beech/Laminate	6766	7122	7476	7986	8563	9074	9652	10358	11121
Maple/Palette	6867	7219	7573	8085	8662	9172	9751	10458	11219
<b>ORDERING NOTE:</b> When ordering a back with Shelf option please clearly specify on your order the required Shelf Height - 42", 36" or 30" and chose required leg type below. Freestanding, Start and End units with the shelf option require counterbalance weight added to each seat unit, please add <b>303 list</b> upcharge per unit.									
 Double-Seat, 60° Inside Curve, Full Height Back with Privacy Screen ZOP3-MCID60DF2F	6869	7222	7577	8088	8666	9174	9754	10460	11224
 Double-Seat, 60° Inside Curve, Mid Height Back ZOP3-MCID60DM0F	5588	5884	6175	6595	7069	7487	7963	8548	9161
 Double-Seat, 60° Inside Curve, Mid Height Back with Shelf ZOP3-MCID60DM1_ Beech/Laminate	6447	6742	7035	7452	7927	8344	8820	9408	10020
Maple/Palette	6545	6840	7132	7550	8026	8445	8918	9506	10120
<b>ORDERING NOTE:</b> When ordering a back with Shelf option please clearly specify on your order the required Shelf Height - 36" or 30" and chose required leg type below. Freestanding, Start and End units with the shelf option require counterbalance weight added to each seat unit, please add <b>303 list</b> upcharge per unit.									
 Double-Seat, 60° Inside Curve, Mid Height Back with Privacy Screen Option ZOP3-MCID60DM2F	6549	6842	7135	7553	8029	8447	8920	9508	10123

Zola Privacy Option Upcharges	\$ List	\$ List
Moisture Barrier & CAL 133 (per yard)	64	Plus Upgrade - Double-Seat, 60° Curve 183
Seat Power (per unit)	641	Dual Leg (for Multiple unit configurations) 80
Shelf Power	599	Removable Seat Covers -Double-Seat, 60° Curve 123
Table Power	589	<b>Note:</b> Removable back covers are not available on curved backs
Combination Upholstery - dual fabrics	33	

## PRODUCT CODE KEY

Line	Series	Chair Type	Curve Style	Seat Degree	Back Type	Leg Type
ZOP Zola	3 Lounge	MC Modular Curve	IS Inside Curve -Single	30D	F0 Full Height Back	F Freestanding Unit
		MCB Modular Curve Plus	ID Inside Curve -Double	45D	F1 Full Height Back with Shelf Option	S Start Unit
			OS Outside Curve -Single	60D	F2 Full Height Back with Privacy Screen Option	C Center Unit
			OD Outside Curve -Double	90D	M0 Mid Height Back	E End Unit
					M1 Mid Height Back with Shelf Option	
					M2 Mid Height Back with Privacy Screen Options	

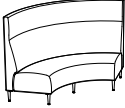
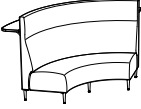
# ZOLA PRIVACY | CURVED

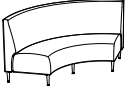
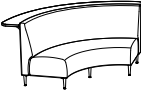
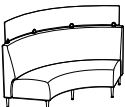
DESCRIPTION/MODEL/SPECIES	COM		COL	FABRIC GRADES			LEATHER		
	1	2	3	4	5	6	7	8	9
 Double-Seat, 90° Inside Curve, Full Height Back ZOP3-MCID90DF0F	6937	7303	7673	8211	8813	9354	9959	10694	11512
 Double-Seat, 90° Inside Curve, Full Height Back with Shelf ZOP3-MCID90DF1_ Beech/Laminate Maple/Palette	7873 7973	8239 8341	8610 8709	9147 9249	9753 9853	10291 10390	10895 10994	11630 11732	12448 12549
 Double-Seat, 90° Inside Curve, Full Height Back with Privacy Screen ZOP3-MCID90DF2F	7942	8308	8678	9217	9818	10358	10963	11699	12514
 Double-Seat, 90° Inside Curve, Mid Height Back ZOP3-MCID90DM0F	6441	6735	7028	7446	7921	8340	8813	9403	10014
 Double-Seat, 90° Inside Curve, Mid Height Back with Shelf ZOP3-MCID90DM1_ Beech/Laminate Maple/Palette	7379 7480	7674 7773	7966 8067	8385 8485	8859 8959	9277 9379	9753 9853	10339 10440	10953 11051
 Double-Seat, 90° Inside Curve, Mid Height Back with Privacy Screen Option ZOP3-MCID90DM2F	7446	7740	8033	8450	8925	9342	9818	10408	11018

**ORDERING NOTE:** When ordering a back with Shelf option please clearly specify on your order the required Shelf Height - 42", 36" or 30" and chose required leg type below. Freestanding, Start and End units with the shelf option require counterbalance weight added to each seat unit, please add **303 list** upcharge per unit.

**ORDERING NOTE:** When ordering a back with Shelf option please clearly specify on your order the required Shelf Height - 36" or 30" and chose required leg type below. Freestanding, Start and End units with the shelf option require counterbalance weight added to each seat unit, please add **303 list** upcharge per unit.

### Zola Privacy Option Upcharges

	\$ List		\$ List
Moisture Barrier & CAL 133 (per yard)	64	Plus Upgrade - Double-Seat, 90° Curve	220
Seat Power (per unit)	641	Dual Leg (for Multiple unit configurations)	80
Shelf Power	599	Removable Seat Covers - Double-Seat, 90° Curve	127
Table Power	589	<b>Note:</b> Removable back covers are not available on curved backs	
Combination Upholstery - dual fabrics	33		

### PRODUCT CODE KEY

Line	Series	Chair Type	Curve Style	Seat Degree	Back Type	Leg Type
ZOP Zola	3 Lounge	MC Modular Curve	IS Inside Curve -Single	30D	F0 Full Height Back	F Freestanding Unit
		MCB Modular Curve Plus	ID Inside Curve -Double	45D	F1 Full Height Back with Shelf Option	S Start Unit
			OS Outside Curve -Single	60D	F2 Full Height Back with Privacy Screen Option	C Center Unit
			OD Outside Curve -Double	90D	M0 Mid Height Back	E End Unit
					M1 Mid Height Back with Shelf Option	
					M2 Mid Height Back with Privacy Screen Options	

# ZOLA PRIVACY | CURVED

DESCRIPTION/MODEL/SPECIES	COM		COL	FABRIC GRADES			LEATHER		
	1	2	3	4	5	6	7	8	9
 Double-Seat, 30° Outside Curve, Full Height Back ZOP3-MCOD30DFOF	4593	4879	5166	5563	6020	6419	6873	7445	8015

 Double-Seat, 30° Outside Curve, Full Height Back with Shelf ZOP3-MCOD30DF1_ Beech/Laminate	5155	5441	5726	6126	6582	6981	7437	8008	8579
Maple/Palette	5248	5534	5821	6219	6676	7073	7531	8099	8670

**ORDERING NOTES:** When ordering a back with Shelf option please clearly specify on your order the required Shelf Height - 42", 36" or 30" and chose required leg type below. Freestanding, Start and End units with the shelf option require counterbalance weight added to each seat unit, please add **303 list** upcharge per unit.

 Double-Seat, 30° Outside Curve, Full Height Back with Privacy Screen ZOP3-MCOD30DF2F	5192	5478	5764	6163	6620	7018	7474	8044	8615
---	------	------	------	------	------	------	------	------	------

 Double-Seat, 30° Outside Curve, Mid Height Back ZOP3-MCOD30DMOF	4398	4637	4873	5206	5586	5918	6296	6770	7245
--	------	------	------	------	------	------	------	------	------

 Double-Seat, 30° Outside Curve, Mid Height Back with Shelf ZOP3-MCOD30DM1_ Beech/Laminate	4961	5199	5436	5767	6147	6480	6859	7333	7808
Maple/Palette	5054	5292	5529	5861	6242	6574	6953	7427	7900

**ORDERING NOTES:** When ordering a back with Shelf option please clearly specify on your order the required Shelf Height - 36" or 30" and chose required leg type below. Freestanding, Start and End units with the shelf option require counterbalance weight added to each seat unit, please add **303 list** upcharge per unit.







 Double-Seat, 30° Outside Curve, Mid Height Back with Privacy Screen Option ZOP3-MCOD30DM2F	4998	5236	5472	5806	6185	6518	6896	7371	7844
---	------	------	------	------	------	------	------	------	------

Zola Privacy Option Upcharges	\$ List		\$ List
Moisture Barrier & CAL 133 (per yard)	64	Plus Upgrade - Double-Seat, 30° Curve	152
Seat Power (per unit)	641	Dual Leg (for Multiple unit configurations)	80
Shelf Power	599	Removable Seat Covers -Double-Seat, 30° Curve	93
Table Power	589	<b>Note:</b> Removable back covers are not available on curved backs	
Combination Upholstery - dual fabrics	33		

## PRODUCT CODE KEY

Line	Series	Chair Type	Curve Style	Seat Degree	Back Type	Leg Type
ZOP Zola	3 Lounge	MC Modular Curve	IS Inside Curve -Single	30D	F0 Full Height Back	F Freestanding Unit
		MCB Modular Curve Plus	ID Inside Curve -Double	45D	F1 Full Height Back with Shelf Option	S Start Unit
			OS Outside Curve -Single	60D	F2 Full Height Back with Privacy Screen Option	C Center Unit
			OD Outside Curve -Double	90D	M0 Mid Height Back	E End Unit
					M1 Mid Height Back with Shelf Option	
					M2 Mid Height Back with Privacy Screen Options	

# ZOLA PRIVACY | CURVED

DESCRIPTION/MODEL/SPECIES	COM		COL	FABRIC GRADES			LEATHER		
	1	2	3	4	5	6	7	8	9
 Double-Seat, 45° Outside Curve, Full Height Back ZOP3-MCOD45DFOF	4798	5084	5368	5767	6225	6624	7080	7651	8221
 Double-Seat, 45° Outside Curve, Full Height Back with Shelf ZOP3-MCOD45DF1_ Beech/Laminate	5362	5646	5932	6331	6788	7185	7642	8212	8784
Maple/Palette	5454	5740	6024	6422	6881	7281	7734	8306	8875
<b>ORDERING NOTE:</b> When ordering a back with Shelf option please clearly specify on your order the required Shelf Height - 42", 36" or 30" and chose required leg type below. Freestanding, Start and End units with the shelf option require counterbalance weight added to each seat unit, please add <b>303 list</b> upcharge per unit.									
 Double-Seat, 45° Outside Curve, Full Height Back with Privacy Screen ZOP3-MCOD45DF2F	5397	5684	5969	6366	6823	7222	7680	8250	8820
 Double-Seat, 45° Outside Curve, Mid Height Back ZOP3-MCOD45DMOF	4581	4817	5056	5388	5766	6099	6478	6954	7428
 Double-Seat, 45° Outside Curve, Mid Height Back with Shelf ZOP3-MCOD45DM1_ Beech/Laminate	5142	5381	5616	5947	6330	6661	7042	7515	7989
Maple/Palette	5236	5472	5712	6043	6421	6754	7134	7609	8083
<b>ORDERING NOTE:</b> When ordering a back with Shelf option please clearly specify on your order the required Shelf Height - 36" or 30" and chose required leg type below. Freestanding, Start and End units with the shelf option require counterbalance weight added to each seat unit, please add <b>303 list</b> upcharge per unit.									
 Double-Seat, 45° Outside Curve, Mid Height Back with Privacy Screen Option ZOP3-MCOD45DM2F	5181	5418	5656	5986	6365	6697	7079	7552	8028

## Zola Privacy Option Upcharges

	\$ List		\$ List
Moisture Barrier & CAL 133 (per yard)	64	Plus Upgrade - Double-Seat, 45° Curve	180
Seat Power (per unit)	641	Dual Leg (for Multiple unit configurations)	80
Shelf Power	599	Removable Seat Covers - Double-Seat, 45° Curve	101
Table Power	589	<b>Note:</b> Removable back covers are not available on curved backs	
Combination Upholstery - dual fabrics	33		

## PRODUCT CODE KEY

Line	Series	Chair Type	Curve Style	Seat Degree	Back Type	Leg Type
ZOP	3	MC	IS	30D	F0	F
Zola	Lounge	Modular Curve	Inside Curve -Single		Full Height Back	Freestanding Unit
		MCB	ID	45D	F1	S
		Modular Curve Plus	Inside Curve -Double		Full Height Back with Shelf Option	Start Unit
			OS	60D	F2	C
			Outside Curve -Single		Full Height Back with Privacy Screen Option	Center Unit
			OD	90D	M0	E
			Outside Curve -Double		Mid Height Back	End Unit
					M1	
					Mid Height Back with Shelf Option	
					M2	
					Mid Height Back with Privacy Screen Options	

# ZOLA PRIVACY | CURVED

DESCRIPTION/MODEL/SPECIES	COM		COL	FABRIC GRADES			LEATHER		
	1	2	3	4	5	6	7	8	9
 Double-Seat, 60° Outside Curve, Full Height Back ZOP3-MCOD60DFOF	5050	5336	5619	6019	6474	6873	7331	7900	8471

 Double-Seat, 60° Outside Curve, Full Height Back with Shelf ZOP3-MCOD60DF1_	Beech/Laminate	5609	5894	6181	6579	7035	7435	7890	8460	9028
	Maple/Palette	5702	5986	6270	6670	7125	7524	7982	8552	9120

**ORDERING NOTE:** When ordering a back with Shelf option please clearly specify on your order the required Shelf Height - 42", 36" or 30" and chose required leg type below. Freestanding, Start and End units with the shelf option require counterbalance weight added to each seat unit, please add **303 list** upcharge per unit.

 Double-Seat, 60° Outside Curve, Full Height Back with Privacy Screen ZOP3-MCOD60DF2F	5647	5933	6218	6616	7072	7472	7928	8499	9067
---	------	------	------	------	------	------	------	------	------

 Double-Seat, 60° Outside Curve, Mid Height Back ZOP3-MCOD60DMOF	4798	5035	5274	5607	5985	6317	6696	7173	7646
--	------	------	------	------	------	------	------	------	------

 Double-Seat, 60° Outside Curve, Mid Height Back with Shelf ZOP3-MCOD60DM1_	Beech/Laminate	5360	5595	5833	6164	6543	6875	7257	7731	8205
	Maple/Palette	5450	5686	5924	6256	6634	6968	7346	7821	8296

**ORDERING NOTE:** When ordering a back with Shelf option please clearly specify on your order the required Shelf Height - 36" or 30" and chose required leg type below. Freestanding, Start and End units with the shelf option require counterbalance weight added to each seat unit, please add **303 list** upcharge per unit.

 Double-Seat, 60° Outside Curve, Mid Height Back with Privacy Screen Option ZOP3-MCOD60DM2F	5395	5634	5870	6206	6582	6914	7294	7768	8241
---	------	------	------	------	------	------	------	------	------







## Zola Privacy Option Upcharges

	\$ List		\$ List
Moisture Barrier & CAL 133 (per yard)	64	Plus Upgrade - Double-Seat, 60° Curve	193
Seat Power (per unit)	641	Dual Leg (for Multiple unit configurations)	80
Shelf Power	599	Removable Seat Covers - Double-Seat, 60° Curve	123
Table Power	589	<b>Note:</b> Removable back covers are not available on curved backs	
Combination Upholstery - dual fabrics	33		

## PRODUCT CODE KEY

Line	Series	Chair Type	Curve Style	Seat Degree	Back Type	Leg Type
ZOP Zola	3 Lounge	MC Modular Curve	IS Inside Curve -Single	30D	F0 Full Height Back	F Freestanding Unit
		MCB Modular Curve Plus	ID Inside Curve -Double	45D	F1 Full Height Back with Shelf Option	S Start Unit
			OS Outside Curve -Single	60D	F2 Full Height Back with Privacy Screen Option	C Center Unit
			OD Outside Curve -Double	90D	M0 Mid Height Back	E End Unit
					M1 Mid Height Back with Shelf Option	
					M2 Mid Height Back with Privacy Screen Options	

# ZOLA PRIVACY | CURVED

DESCRIPTION/MODEL/SPECIES	COM		COL	FABRIC GRADES			LEATHER		
	1	2	3	4	5	6	7	8	9
 Double-Seat, 90° Outside Curve, Full Height Back ZOP3-MCOD90DF0F	5659	5944	6229	6628	7084	7484	7940	8511	9080
 Double-Seat, 90° Outside Curve, Full Height Back with Shelf ZOP3-MCOD90DF1_ Beech/Laminate	6212	6497	6784	7182	7638	8038	8493	9064	9632
	Maple/Palette	6304	6587	6873	7271	7730	8129	8584	9157
<b>ORDERING NOTES:</b> When ordering a back with Shelf option please clearly specify on your order the required Shelf Height - 42", 36" or 30" and chose required leg type below. Freestanding, Start and End units with the shelf option require counterbalance weight added to each seat unit, please add <b>303 list</b> upcharge per unit.									
 Double-Seat, 90° Outside Curve, Full Height Back with Privacy Screen ZOP3-MCOD90DF2F	6247	6534	6819	7216	7674	8073	8529	9099	9668
 Double-Seat, 90° Outside Curve, Mid Height Back ZOP3-MCOD90DM0F	5507	5833	6159	6663	7216	7722	8276	8930	9737
 Double-Seat, 90° Outside Curve, Mid Height Back with Shelf ZOP3-MCOD90DM1_ Beech/Laminate	6060	6387	6713	7216	7770	8276	8830	9482	10291
	Maple/Palette	6154	6477	6805	7310	7863	8367	8919	9573
<b>ORDERING NOTES:</b> When ordering a back with Shelf option please clearly specify on your order the required Shelf Height - 36" or 30" and chose required leg type below. Freestanding, Start and End units with the shelf option require counterbalance weight added to each seat unit, please add <b>303 list</b> upcharge per unit.									
 Double-Seat, 90° Outside Curve, Mid Height Back with Privacy Screen Option ZOP3-MCOD90DM2F	6097	6421	6749	7255	7807	8310	8865	9517	10328





## Zola Privacy Option Upcharges

	\$ List		\$ List
Moisture Barrier & CAL 133 (per yard)	64	Plus Upgrade - Double-Seat, 90° Curve	220
Seat Power (per unit)	641	Dual Leg (for Multiple unit configurations)	80
Shelf Power	599	Removable Seat Covers - Double-Seat, 90° Curve	127
Table Power	589	<b>Note:</b> Removable back covers are not available on curved backs	
Combination Upholstery - dual fabrics	33		

## PRODUCT CODE KEY

Line	Series	Chair Type	Curve Style	Seat Degree	Back Type	Leg Type
ZOP	3	MC	IS	30D	F0	F
Zola	Lounge	Modular Curve	Inside Curve -Single		Full Height Back	Freestanding Unit
		MCB	ID	45D	F1	S
		Modular Curve Plus	Inside Curve -Double		Full Height Back with Shelf Option	Start Unit
			OS	60D	F2	C
			Outside Curve -Single		Full Height Back with Privacy Screen Option	Center Unit
			OD	90D	M0	E
			Outside Curve -Double		Mid Height Back	End Unit
					M1	
					Mid Height Back with Shelf Option	
					M2	
					Mid Height Back with Privacy Screen Options	

# ZOLA PRIVACY | SIDE PANELS

DESCRIPTION/MODEL/SPECIES	COM		COL			FABRIC GRADES			LEATHER	
	1	2	3	4	5	6	7	8	9	
 Side Panel, Single, Full Height No Screen ZOP3-MPF0S Start ZOP3-MPF0C Center ZOP3-MPF0E End	948	1036	1124	1304	1481	1660	1836	2016	2370	
	1222	1310	1398	1578	1753	1932	2109	2286	2642	
	948	1036	1124	1304	1481	1660	1836	2016	2370	
 Side Panel, Single, Full Height with Screen ZOP3-MPF2S Start ZOP3-MPF2C Center ZOP3-MPF2E End	1243	1332	1420	1597	1776	1954	2132	2310	2665	
	1515	1606	1693	1871	2051	2228	2406	2584	2938	
	1243	1332	1420	1597	1776	1954	2132	2310	2665	
 Side Panel, Single, Mid Height No Screen ZOP3-MPM0S Start ZOP3-MPM0C Center ZOP3-MPM0E End	767	829	888	1011	1131	1251	1372	1492	1732	
	1052	1110	1170	1290	1412	1533	1653	1773	2016	
	767	829	888	1011	1131	1251	1372	1492	1732	
 Side Panel, Single, Mid Height with Screen ZOP3-MPM2S Start ZOP3-MPM2C Center ZOP3-MPM2E End	1063	1122	1183	1306	1425	1547	1667	1788	2029	
	1346	1405	1465	1587	1706	1827	1947	2066	2310	
	1063	1122	1183	1306	1425	1547	1667	1788	2029	

**ORDERING NOTE:** Side Panels will only connect to Center seating units. Units with Privacy Screen Option are not available with Removable Back Cover option. See [page 30](#) for Dimensions and COM.

## PRODUCT CODE KEY

Line	Series	Chair Type	Height	Position
ZOP	3	MP	F0	S
Zola	Lounge	Modular Side Panel	Full Height	Start
			F2	C
			Full Height with Privacy Screen Option	Center
			M0	E
			Mid Height	End
			M2	
			Mid Height with Privacy Screen Option	



# ZOLA PRIVACY | SEMI-PRIVATE SIDE PANELS & MODULAR ARMS

DESCRIPTION/MODEL	COM		COL			FABRIC GRADES			LEATHER		
	1	2	3	4	5	6	7	8	9		
	Semi-Private Side Panel, Single, Full Height										
	ZOP3-MSPF0S	Start	583	628	674	765	856	949	1039	1132	1314
	ZOP3-MSPF0C	Center	857	905	952	1041	1134	1224	1315	1407	1589
	ZOP3-MSPF0E	End	583	628	674	765	856	949	1039	1132	1314

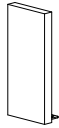
DESCRIPTION/MODEL	COM		COL			FABRIC GRADES			LEATHER		
	1	2	3	4	5	6	7	8	9		
	Semi-Private Side Panel, Single, Mid Height										
	ZOP3-MSPM0S	Start	514	555	592	672	751	829	909	987	1143
	ZOP3-MSPM0C	Center	796	835	875	955	1033	1111	1191	1269	1428
	ZOP3-MSPM0E	End	514	555	592	672	751	829	909	987	1143

**ORDERING NOTE:** Semi-Private Side Panels will only connect to Center seating units.

### PRODUCT CODE KEY

Line	Series	Chair Type	Height	Position
ZOP	3	MSP	F0	S
Zola	Lounge	Modular Semi-Private Side Panel	Full Height	Start
			M0	C
			Mid Height	Center
				E
				End

# ZOLA PRIVACY | MODULAR ARMS

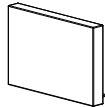
DESCRIPTION/MODEL	COM		COL			FABRIC GRADES			LEATHER		
	1	2	3	4	5	6	7	8	9		
	Modular Upholstered Arm										
	ZOP3-MAUPLH*		702	740	778	853	930	1004	1081	1155	1307
	ZOP3-MAUPHR		702	740	778	853	930	1004	1081	1155	1307
	ZOP3-MAUPHC		784	823	859	935	1012	1087	1163	1239	1390

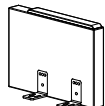
DESCRIPTION/MODEL	COM		COL			FABRIC GRADES			LEATHER		
	1	2	3	4	5	6	7	8	9		
	Modular Upholstered Arm w/Urethane Cap										
	ZOP3-MAUREL		840	878	914	990	1066	1141	1218	1292	1445
	ZOP3-MAURER*		840	878	914	990	1066	1141	1218	1292	1445
	ZOP3-MAUREC		906	942	981	1058	1134	1207	1284	1358	1510

**ORDERING NOTE:** To specify Solid Surface Arm Caps on Modular Upholstered Arms, please add upcharge below and change UPH in the model number to SSC.

Zola Option Upcharges	Grades			
	A-White	A-Color	B	C
Solid Surface Arm Cap (per arm)	129	136	151	157

### PRODUCT CODE KEY

Line	Series	Type	Arm	Position
ZOP	3	MA	UPH	L
Zola	Lounge	Modular Arm	Upholstered	Left Hand Facing
			URE	R
			Upholstered Arm w/Urethane Cap	Right Hand facing
			SSC	C
			Upholstered Arm w/Solid Surface Cap	Center

# ZOLA PRIVACY | TWIN CURVED - DIMENSIONS & COM REQUIREMENTS

## DIMENSIONS

	Overall Width	Width with Arms	Overall Depth	Overall Height	Height w/Screen	Overall Seat Height	Seat Depth	Shipping Weight	Cubes
<b>Twin Curved Single-Seat - Full Height Back</b>									
30° Curve	49	55	53.5	50	62.5	18.5	20.25	127	31
45° Curve	61.5	67.5	54	50	62.5	18.5	20.25	146	42
60° Curve	73.5	79.5	55	50	62.5	18.5	20.25	164	55
90° Curve	94.5	100.5	56.5	50	62.5	18.5	20.25	207	79
<b>Twin Curved Single-Seat - Mid Height Back</b>									
30° Curve	49	55	53.5	37.5	50	18.5	20.25	122	27
45° Curve	61.5	67.5	54	37.5	50	18.5	20.25	140	37
60° Curve	73.5	79.5	55	37.5	50	18.5	20.25	158	48
90° Curve	94.5	100.5	56.5	37.5	50	18.5	20.25	200	68
<b>Twin Curved Double-Seat - Full Height Back</b>									
30° Curve	71	77	55	50	62.5	18.5	20.25	199	55
45° Curve	83.5	89.5	56	50	62.5	18.5	20.25	215	73
60° Curve	95.5	101.5	58	50	62.5	18.5	20.25	237	92
<b>Twin Curved Double-Seat - Mid Height Back</b>									
30° Curve	71	77	55	37.5	50	18.5	20.25	199	48
45° Curve	83.5	89.5	56	37.5	50	18.5	20.25	215	64
60° Curve	95.5	101.5	58	37.5	50	18.5	20.25	237	81







## COM YARDAGES

	Yardage Entire Unit	Yardage 2 Entire Units	Yardage 3 Entire Units	Yardage 4 Entire Units	Yardage per Back	Yardage per 2 Backs	Yardage per 3 Backs	Yardage per 4 Backs
<b>Curved Single-Seat - Full Height Back</b>								
30° Curve	8.6	15.6	24.2	31.2	4.8	8	12.8	16
45° Curve	9.6	17.6	27.2	35.2	4.8	8	12.8	16
60° Curve	11.53	20.8	31.2	41.6	6.33	10.4	15.6	20.8
90° Curve	11.83	24.50	36.75	48.70	6.33	13.5	20.25	27
<b>Curved Single-Seat - Mid Height Back</b>								
30° Curve	7.63	13.85	21.48	27.7	3.83	6.25	10.08	12.5
45° Curve	8.63	15.85	24.48	31.7	3.83	6.25	10.08	12.5
60° Curve	10.2	18.4	27.6	36.8	5	8	12	16
90° Curve	10.5	21	31.5	41.7	5	10	15	20
<b>Curved Double-Seat - Full Height Back</b>								
30° Curve	12.96	27.1	40.65	54.2	6.16	13.5	20.25	27
45° Curve	13.13	27.1	40.65	54.2	6.33	13.5	20.25	27
60° Curve	13.23	27.3	40.95	54.6	6.33	13.5	20.25	27
90° Curve								
<b>Curved Double-Seat - Mid Height Back</b>								
30° Curve	11.63	23.60	35.4	47.2	4.83	10	15	20
45° Curve	11.8	23.6	35.4	47.2	5	10	15	20
60° Curve	11.9	23.8	35.7	47.6	5	10	15	20

## ZOLA PRIVACY | TWIN CURVED - COM REQUIREMENTS

	Yardage 1 Seat-Small Seat	Yardage 2 Seat-Small Seats	Yardage 3 Seat-Small Seats	Yardage 4 Seat-Small Seats	Yardage 1 Seat-Large Seat	Yardage 2 Seat-Large Seats	Yardage 3 Seat-Large Seats	Yardage 4 Seat-Large Seats
<b>Curved Single-Seat - Full Height Back</b>								
30° Curve	1.8	3.6	5.4	7.2	2	4	6	8
45° Curve	1.8	3.6	5.4	7.2	3	6	9	12
60° Curve	1.8	3.6	5.4	7.2	3.4	6.8	10.2	13.6
90° Curve	1.8	3.6	5.4	7.2	3.7	7.4	11.10	14.5
<b>Curved Single-Seat - Mid Height Back</b>								
30° Curve	1.8	3.6	5.4	7.2	2	4	6	8
45° Curve	1.8	3.6	5.4	7.2	3	6	9	12
60° Curve	1.8	3.6	5.4	7.2	3.4	6.8	10.2	13.6
90° Curve	1.8	3.6	5.4	7.2	3.7	7.4	11.1	14.5
<b>Curved Double-Seat - Full Height Back</b>								
30° Curve	3.4	6.8	10.2	13.6	3.4	6.8	10.2	13.6
45° Curve	3.4	6.8	10.2	13.6	3.4	6.8	10.2	13.6
60° Curve	3.4	6.8	10.2	13.6	3.5	7	10.5	14
<b>Curved Double-Seat - Mid Height Back</b>								
30° Curve	3.4	6.8	10.2	13.6	3.4	6.8	10.2	13.6
45° Curve	3.4	6.8	10.2	13.6	3.4	6.8	10.2	13.6
60° Curve	3.4	6.8	10.2	13.6	3.4	7	10.5	14

# ZOLA PRIVACY | TWIN CURVED

DESCRIPTION/MODEL	COM		COL	FABRIC GRADES			LEATHER		
	1	2	3	4	5	6	7	8	9
 Twin Single-Seat, 30° Curve, Full Height Back ZOP3-MCTS30DF0F	5204	5517	5830	6268	6767	7208	7709	8335	8960
 Twin Single-Seat, 30° Curve, Full Height Back with Privacy Screen Option ZOP3-MCTS30DF2F	5796	6111	6422	6862	7362	7800	8302	8930	9555
 Twin Single-Seat, 30° Curve, Mid Height Back ZOP3-MCTS30DM0F	4930	5213	5494	5888	6336	6731	7180	7741	8305
 Twin Single-Seat, 30° Curve, Mid Height Back with Privacy Screen Option ZOP3-MCTS30DM2F	5525	5806	6085	6480	6931	7323	7773	8337	8896
 Twin Single-Seat, 45° Curve, Full Height Back ZOP3-MCTS45DF0F	5867	6191	6519	6977	7498	7953	8477	9130	9781
 Twin Single-Seat, 45° Curve, Full Height Back with Privacy Screen Option ZOP3-MCTS45DF2F	6468	6793	7120	7577	8098	8555	9079	9730	10382







## Zola Privacy Option Upcharges

	\$ List		\$ List
Moisture Barrier & CAL 133 (per yard)	64	Plus Upgrade - Twin Single-Seat, 30° Curve	287
Seat Power (per unit)	641	Plus Upgrade - Twin Single-Seat, 45° Curve	345
Shelf Power	599	Removable Seat Covers -Twin Single-Seat, 30° Curve	155
Table Power	589	Removable Seat Covers -Twin Single-Seat, 45° Curve	166
Dual Leg (for Multiple unit configurations)	80	<b>Note:</b> Removable back covers are not available on curved backs	

## PRODUCT CODE KEY

Line	Series	Chair Type	Curve Style	Seat Degree	Back Type	Leg Type
ZOP Zola	3 Lounge	MCT Modular Curve Twin	S Small Radius- Single Width	30D	F0 Full Height Back	F Freestanding Unit
		MCTB Modular Curve Twin Plus	D Small Radius- Double Width	45D	F2 Full Height Back with Privacy Screen Option	S Start Unit
				60D	M0 Mid Height Back	C Center Unit
				90D	M2 Mid Height Back with Privacy Screen Options	E End Unit

# ZOLA PRIVACY | TWIN CURVED

DESCRIPTION/MODEL	COM		COL	FABRIC GRADES			LEATHER		
	1	2	3	4	5	6	7	8	9
 Twin Single-Seat, 45° Curve, Mid Height Back ZOP3-MCTS45DMOF	5556	5850	6142	6556	7027	7438	7909	8499	9087
 Twin Single-Seat, 45° Curve, Mid Height Back with Privacy Screen Option ZOP3-MCTS45DM2F	5531	5812	6093	6489	6938	7331	7781	8342	8905
 Twin Single-Seat, 60° Curve, Full Height Back ZOP3-MCTS60DFOF	6662	7045	7430	7966	8580	9116	9729	10495	11261
 Twin Single-Seat, 60° Curve, Full Height Back with Privacy Screen Option ZOP3-MCTS60DF2F	7266	7649	8033	8569	9184	9719	10333	11098	11866
 Twin Single-Seat, 60° Curve, Mid Height Back ZOP3-MCTS60DMOF	6304	6644	6983	7460	8002	8477	9020	9697	10379
 Twin Single-Seat, 60° Curve, Mid Height Back with Privacy Screen Option ZOP3-MCTS60DM2F	7480	7913	8345	8955	9650	10259	10953	11820	12688





### Zola Privacy Option Upcharges

	\$ List	\$ List
Moisture Barrier & CAL 133 (per yard)	64	Plus Upgrade - Twin Single-Seat, 45° Curve 345
Seat Power (per unit)	641	Plus Upgrade - Twin Single-Seat, 60° Curve 404
Shelf Power	599	Removable Seat Covers -Twin Single-Seat, 45° Curve 166
Table Power	589	Removable Seat Covers -Twin Single-Seat, 60° Curve 212
Dual Leg (for Multiple unit configurations)	80	<b>Note:</b> Removable back covers are not available on curved backs

### PRODUCT CODE KEY

Line	Series	Chair Type	Curve Style	Seat Degree	Back Type	Leg Type
ZOP Zola	3 Lounge	MCT Modular Curve Twin	S Small Radius- Single Width	30D	F0 Full Height Back	F Freestanding Unit
		MCTB Modular Curve Twin Plus	D Small Radius- Double Width	45D	F2 Full Height Back with Privacy Screen Option	S Start Unit
				60D	M0 Mid Height Back	C Center Unit
				90D	M2 Mid Height Back with Privacy Screen Options	E End Unit

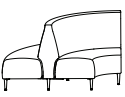
# ZOLA PRIVACY | TWIN CURVED

DESCRIPTION/MODEL/SPECIES	COM		COL	FABRIC GRADES			LEATHER		
	1	2	3	4	5	6	7	8	9
 Twin Single-Seat, 90° Curve, Full Height Back ZOP3-MCTS90DF0F	8312	8702	9091	9644	10270	10818	11446	12225	13017
 Twin Single-Seat, 90° Curve, Full Height Back with Privacy Screen Option ZOP3-MCTS90DF2F	9265	9654	10044	10594	11223	11769	12396	13175	13969
 Twin Single-Seat, 90° Curve, Mid Height Back ZOP3-MCTS90DM0F	7814	8159	8506	8994	9550	10040	10594	11286	11991
 Twin Single-Seat, 90° Curve, Mid Height Back with Privacy Screen Option ZOP3-MCTS90DM2F	7447	7838	8230	8775	9398	9945	10570	11349	12130





## Zola Privacy Option Upcharges

	\$ List		\$ List
Moisture Barrier & CAL 133 (per yard)	64	Plus Upgrade - Twin Single-Seat, 90° Curve	516
Seat Power (per unit)	641	Dual Leg (for Multiple unit configurations)	80
Shelf Power	599	Removable Seat Covers -Twin Single-Seat, 90° Curve	240
Table Power	589	<b>Note:</b> Removable back covers are not available on curved backs	

## PRODUCT CODE KEY

Line	Series	Chair Type	Curve Style	Seat Degree	Back Type	Leg Type
ZOP Zola	3 Lounge	MCT Modular Curve Twin	S Small Radius- Single Width	30D	F0 Full Height Back	F Freestanding Unit
		MCTB Modular Curve Twin Plus	D Small Radius- Double Width	45D	F2 Full Height Back with Privacy Screen Option	S Start Unit
				60D	M0 Mid Height Back	C Center Unit
				90D	M2 Mid Height Back with Privacy Screen Options	E End Unit

# ZOLA PRIVACY | TWIN CURVED

DESCRIPTION/MODEL/SPECIES	COM		COL	FABRIC GRADES			LEATHER		
	1	2	3	4	5	6	7	8	9
 Twin Double-Seat, 30° Curve, Full Height Back ZOP3-MCTD30DF0F	6875	7311	7743	8350	9046	9654	10348	11216	12086
 Twin Double-Seat, 30° Curve, Full Height Back with Privacy Screen Option ZOP3-MCTD30DF2F	7820	8256	8688	9296	9991	10598	11293	12163	13029
 Twin Double-Seat, 30° Curve, Mid Height Back ZOP3-MCTD30DM0F	6496	6886	7279	7822	8447	8993	9619	10399	11179
 Twin Double-Seat, 30° Curve, Mid Height Back with Privacy Screen Option ZOP3-MCTD30DM2F	7441	7833	8222	8768	9393	9938	10564	11344	12122





## Zola Privacy Option Upcharges

	\$ List	\$ List
Moisture Barrier & CAL 133 (per yard)	64	Plus Upgrade - Twin Double-Seat, 30° Curve 404
Seat Power (per unit)	641	Dual Leg (for Multiple unit configurations) 80
Shelf Power	599	Removable Seat Covers -Twin Double-Seat, 30° Curve 186
Table Power	589	<b>Note:</b> Removable back covers are not available on curved backs

## PRODUCT CODE KEY

Line	Series	Chair Type	Curve Style	Seat Degree	Back Type	Leg Type
ZOP Zola	3 Lounge	MCT Modular Curve Twin	S Small Radius- Single Width	30D	F0 Full Height Back	F Freestanding Unit
		MCTB Modular Curve Twin Plus	D Small Radius- Double Width	45D	F2 Full Height Back with Privacy Screen Option	S Start Unit
				60D	M0 Mid Height Back	C Center Unit
				90D	M2 Mid Height Back with Privacy Screen Options	E End Unit

# ZOLA PRIVACY | TWIN CURVED

DESCRIPTION/MODEL/SPECIES	COM		COL	FABRIC GRADES			LEATHER		
	1	2		4	5	6	7	8	9
 Twin Double-Seat, 45° Curve, Full Height Back ZOP3-MCTD45DF0F	7754	8198	8645	9269	9983	10606	11320	12211	13105
 Twin Double-Seat, 45° Curve, Full Height Back with Privacy Screen Option ZOP3-MCTD45DF2F	8706	9156	9600	10222	10937	11561	12274	13167	14058
 Twin Double-Seat, 45° Curve, Mid Height Back ZOP3-MCTD45DM0F	7346	7750	8152	8715	9358	9919	10564	11367	12171
 Twin Double-Seat, 45° Curve, Mid Height Back with Privacy Screen Option ZOP3-MCTD45DM2F	8304	8703	9108	9668	10312	10875	11517	12320	13127

### ORDERING NOTES:

The 90° size is not available in a Double-Seat unit, order two 45° degree single units.



Zola Privacy Option Upcharges	\$ List		\$ List
Moisture Barrier & CAL 133 (per yard)	64	Plus Upgrade - Twin Double-Seat, 45° Curve	458
Seat Power (per unit)	641	Dual Leg (for Multiple unit configurations)	80
Shelf Power	599	Removable Seat Covers - Twin Double-Seat, 45° Curve	204
Table Power	589	<b>Note:</b> Removable back covers are not available on curved backs	

### PRODUCT CODE KEY

Line	Series	Chair Type	Curve Style	Seat Degree	Back Type	Leg Type
ZOP Zola	3 Lounge	MCT Modular Curve Twin	S Small Radius- Single Width	30D	F0 Full Height Back	F Freestanding Unit
		MCTB Modular Curve Twin Plus	D Small Radius- Double Width	45D	F2 Full Height Back with Privacy Screen Option	S Start Unit
				60D	M0 Mid Height Back	C Center Unit
				90D	M2 Mid Height Back with Privacy Screen Options	E End Unit

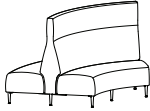
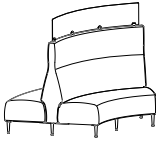
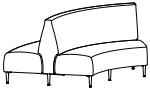

# ZOLA PRIVACY | TWIN CURVED

DESCRIPTION/MODEL/SPECIES	COM		COL		FABRIC GRADES			LEATHER	
	1	2	3	4	5	6	7	8	9
 Twin Double-Seat, 60° Curve, Full Height Back ZOP3-MCTD60DF0F	8458	8912	9363	9996	10721	11353	12079	12983	13887
 Twin Double-Seat, 60° Curve, Full Height Back with Privacy Screen Option ZOP3-MCTD60DF2F	9418	9873	10324	10958	11680	12315	13038	13944	14848
 Twin Double-Seat, 60° Curve, Mid Height Back ZOP3-MCTD60DM0F	7994	8404	8811	9383	10039	10609	11264	12083	12897
 Twin Double-Seat, 60° Curve, Mid Height Back with Privacy Screen Option ZOP3-MCTD60DM2F	8955	9363	9772	10344	10995	11568	12225	13042	13858

## Zola Privacy Option Upcharges

	\$ List		\$ List
Moisture Barrier & CAL 133 (per yard)	64	Plus Upgrade - Twin Double-Seat, 60° Curve	543
Seat Power (per unit)	641	Dual Leg (for Multiple unit configurations)	80
Shelf Power	599	Removable Seat Covers -Twin Double-Seat, 60° Curve	248
Table Power	589	<b>Note:</b> Removable back covers are not available on curved backs	

## PRODUCT CODE KEY

Line	Series	Chair Type	Curve Style	Seat Degree	Back Type	Leg Type
ZOP Zola	3 Lounge	MCT Modular Curve Twin	S Small Radius- Single Width	30D	F0 Full Height Back	F Freestanding Unit
		MCTB Modular Curve Twin Plus	D Small Radius- Double Width	45D	F2 Full Height Back with Privacy Screen Option	S Start Unit
				60D	M0 Mid Height Back	C Center Unit
				90D	M2 Mid Height Back with Privacy Screen Options	E End Unit

# ZOLA PRIVACY | TWIN SIDE PANELS

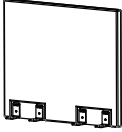
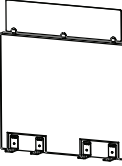
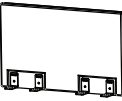
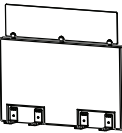
DESCRIPTION/MODEL	COM		COL			FABRIC GRADES			LEATHER	
	1	2	3	4	5	6	7	8	9	
 Twin Side Panel, Full Height No Screen ZOP3-MPTF0U Universal End ZOP3-MPTF0C Center	1428	1559	1691	1955	2218	2483	2745	3010	3536	
	2139	2272	2405	2668	2932	3193	3457	3720	4248	
	<hr/>									
 Twin Side Panel, Full Height with Screen ZOP3-MPTF2U Universal End ZOP3-MPTF2C Center	2006	2138	2271	2533	2798	3061	3324	3589	4114	
	2718	2851	2984	3246	3510	3772	4037	4297	4828	
	<hr/>									
 Twin Side Panel, Med. Height No Screen - ZOP3-MPTM0U Universal End ZOP3-MPTM0C Center	1187	1275	1363	1543	1720	1898	2077	2254	2610	
	1897	1988	2077	2254	2432	2610	2788	2965	3322	
	<hr/>									
 Twin Side Panel, Med. Height with Screen ZOP3-MPTM2U Universal End ZOP3-MPTM2C Center	1767	1855	1944	2122	2301	2479	2657	2833	3188	
	2478	2567	2657	2833	3011	3188	3367	3543	3902	
	<p><b>ORDERING NOTE:</b> Side Panels will only connect to Center seating units. Units with Privacy Screen Option are not available with Removable Back Cover option. See <a href="#">page 40</a> for dimensions &amp; C.O.M.</p>									

## PRODUCT CODE KEY

Line	Series	Chair Type	Height	Position
ZOP	3	MPT	F0	U
Zola	Lounge	Modular Side Panel Twin	Full Height	Universal (S or E)
			F2	C
			Full Height with Privacy Screen Option	Center /Interim
			M0	
			Mid Height	
			M2	
			Mid Height with Privacy Screen Option	

# ZOLA PRIVACY | TWIN SEMI-PRIVATE SIDE PANELS & MODULAR ARMS

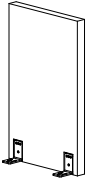
DESCRIPTION/MODEL	COM		COL	FABRIC GRADES			LEATHER		
	1	2	3	4	5	6	7	8	9
 Twin Semi-Private Side Panel, Single, Full Height ZOP3-MSPTF0U Universal ZOP3-MSPTF0C Center	1012	1092	1172	1286	1415	1528	1659	1819	1981
	1724	1804	1885	1999	2129	2240	2370	2532	2694

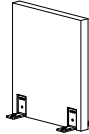
 Twin Semi-Private Side Panel, Single, Mid Height ZOP3-MSPTM0U Universal ZOP3-MSPTM0C Center	868	919	973	1045	1131	1203	1288	1393	1497
	1581	1633	1686	1758	1842	1915	2001	2106	2211

**ORDERING NOTE:** Semi-Private Side Panels will only connect to Center seating units. See [page 40](#) for dimensions and COM.

## PRODUCT CODE KEY

Line	Series	Type	Height	Position
ZOP Zola	3 Lounge	MSPT Modular Arm Twin	F0 Full Height  M0 Mid Height	U Universal (S or E)  C Center /Interim

# ZOLA PRIVACY | TWIN MODULAR ARMS

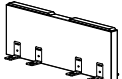
DESCRIPTION/MODEL	COM		COL	FABRIC GRADES			LEATHER		
	1	2	3	4	5	6	7	8	9
 Twin Modular Upholstered Arm ZOP3-MATUPHU ZOP3-MATUPHC	1120	1197	1262	1349	1451	1539	1641	1768	1894
	1846	1909	1974	2062	2164	2253	2354	2481	2608
	 Twin Modular Upholstered Arm w/Urethane Cap ZOP3-MATUREU ZOP3-MATUREC	1252	1329	1393	1481	1582	1670	1772	1899
1979		2041	2106	2193	2295	2384	2485	2612	2739

**ORDERING NOTE:** To specify Solid Surface Arm Caps on Modular Upholstered Arms, please add upcharge below and change UPH in the model number to SSC.

Zola Option Upcharges	Grades			
	A-White	A-Color	B	C
Solid Surface Arm Cap (per arm)	276	288	318	328

## PRODUCT CODE KEY

Line	Series	Type	Arm	Position
ZOP Zola	3 Lounge	MAT Modular Arm Twin	UPH Upholstered  URE Upholstered Arm w/Urethane Cap  SSC Upholstered Arm w/Solid Surface Cap	U Universal (S or E)  C Center /Interim

# ZOLA PRIVACY | TABLETS

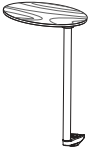
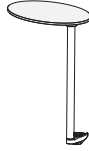
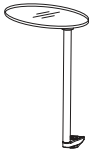
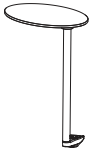
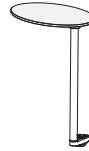
DESCRIPTION	MODEL	SPECIES	PRICE	WEIGHT	CUBE
	Wood Tablet ZOL3 T1	Beech Maple /Cherry	514 538	12	2
	Tablet with Palette Finish ZOL3 T2	n/a	411	12	2
	Clear Glass Tablet ZOL3 T3	n/a	783	13	2
	Laminate Tablet ZOL3 T4	n/a	532	12	2
	<b>ORDERING NOTES:</b> The laminate tablet comes standard with a polymer edge. Please note Zola Tablets are universally handed and do not need to be specified right or left when ordering.				
	Solid Surface Tablet - Grade A White ZOL3 T5AW	n/a	641	14	2
	Solid Surface Tablet - Grade A Color ZOL3 T5AC	n/a	651	14	2
	Solid Surface Tablet - Grade B ZOL3 T5B	n/a	686	14	2
	Solid Surface Tablet - Grade C ZOL3 T5C	n/a	741	14	2

# ZOLA PRIVACY | INLINE WALLS | FEATURES & OPTIONS



## RECONFIGURABILITY

Inline Walls can be reconfigured within Zola Privacy seating configurations. Inline walls are comprised of 3 module types, a left and a right corner unit plus a center unit and are available in two depths - Inline Wall at 12 inches and Inline Table Wall at 28 inches. Inline Wall corner units and Inline Table Walls must connect to Start, Center or End seating unit.



## BACK CONNECTION

Inline Corner Walls and Inline Tables connect to Zola Privacy seating using steel brackets. Seating must be specified as start, center or ends.



## LEGS

The legs offered on Zola Lounge are Silver Metallic or Matte Black and feature glides that are adjustable up to 1.25", which provide leveling capability over longer spans. Caster leg is not available.



## MEDIA & POWER

Inline walls can be optioned with Media provisions and Powerdocs.



## RUNOFF TABLES

Run-off tables are used in combination with Inline Walls and provide a fixed occasional height table between two seating units. They feature a single tapered metal leg with adjustable glide.



## LAMINATE OR WOOD OPTIONS

Inline walls are offered in wood and laminate surfaces. They create a straight wall partition between two opposing seating units. Walls are available in Mid and Full Height back styles and are 12" in depth at the base.



## SOLID SURFACE OVERLAY

The Solid Surface top option is priced as an upcharge to existing table price. Zola Solid Surface tables have a 1/2" thickness on top of the existing table, with a 1 mm overhang (soft radius vertical edge). Please see [page 116](#) for color options.

# ZOLA PRIVACY | INLINE WALLS | SAMPLE CONFIGURATIONS

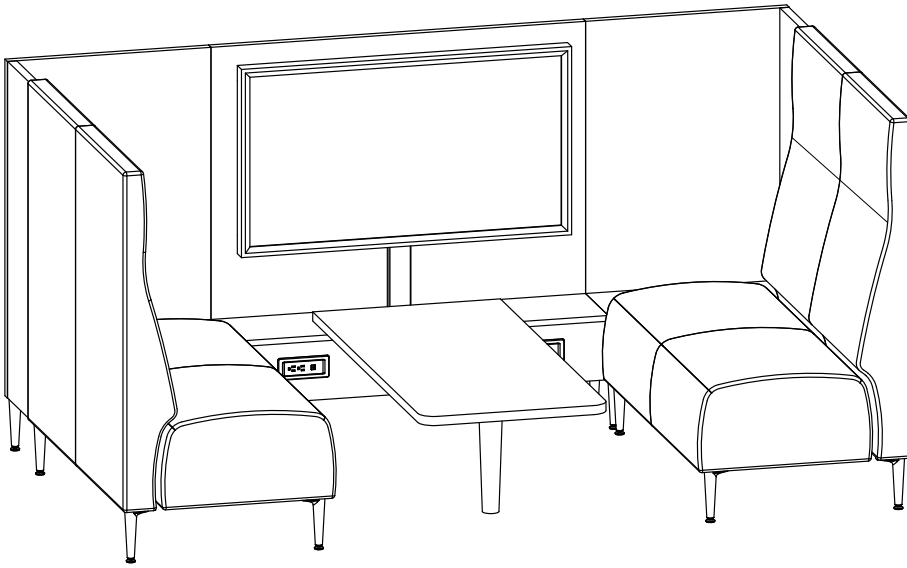

Model	Qty	Price (\$)
ZOP3-M2F0F	2	3029
ZOP3-IWF048MP	1	2404
ZOP3-ICWF0L	1	1697
ZOP3-ICWF0R	1	1697
ZOP3-RO48532416	1	1066
<b>Total</b>		<b>\$12,922</b>

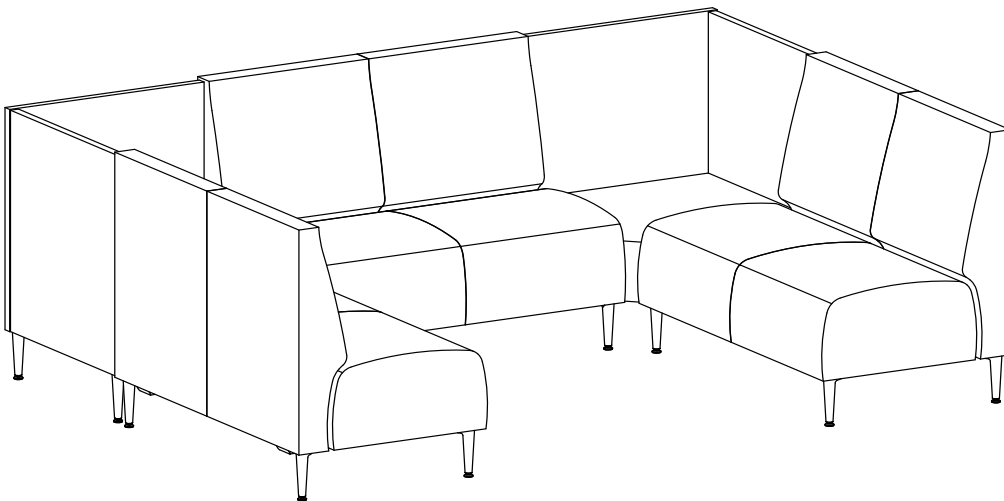

Model	Qty	Price (\$)
ZOP3-M2M0F	3	2595
ZOP3-ICTWM0L	1	1715
ZOP3-ICTWM0R	1	1715
<b>Total</b>		<b>\$11,215</b>

# ZOLA PRIVACY | INLINE WALLS

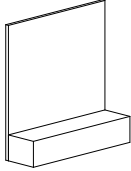
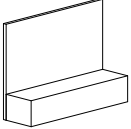
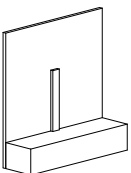
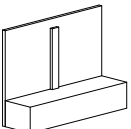
DESCRIPTION/MODEL	THERMOFUSED LAMINATE	HIGH PRESSURE LAMINATE	CHERRY MAPLE BEECH	W	D	H	WEIGHT	CUBE
	Inline Wall, Full Height 42" ZOP3-IWF042N	1172	1985	1673	42	12	50	107 19
	Inline Wall, Full Height 48" ZOP3-IWF048N	1262	2167	1774	48	12	50	121 21.5
	Inline Wall, Full Height 54" ZOP3-IWF054N	1349	2255	1875	54	12	50	135 24
	Inline Wall, Full Height 60" ZOP3-IWF060N	1437	2343	1974	60	12	50	147 26.5
	Inline Wall, Mid Height 42" ZOP3-IWM042N	1095	1683	1588	42	12	37	92 13.5
	Inline Wall, Mid Height 48" ZOP3-IWM048N	1184	1863	1688	48	12	37	102 15.25
	Inline Wall, Mid Height 54" ZOP3-IWM054N	1271	1953	1789	54	12	37	116 17
	Inline Wall, Mid Height 60" ZOP3-IWM060N	1359	2040	1886	60	12	37	126 18.75
	Inline Wall Media, Full Height 42" ZOP3-IWF042M	1318	2131	1820	42	12	50	107 19
	Inline Wall Media, Full Height 48" ZOP3-IWF048M	1407	2313	1921	48	12	50	121 21.5
	Inline Wall Media, Full Height 54" ZOP3-IWF054M	1494	2401	2019	54	12	50	135 24
	Inline Wall Media, Full Height 60" ZOP3-IWF060M	1583	2488	2119	60	12	50	147 26.5
	Inline Wall Media, Mid Height 42" ZOP3-IWM042M	1242	1827	1734	42	12	37	92 13.5
	Inline Wall Media, Mid Height 48" ZOP3-IWM048M	1330	2010	1834	48	12	37	102 15.25
	Inline Wall Media, Mid Height 54" ZOP3-IWM054M	1417	2096	1934	54	12	37	116 17
	Inline Wall Media, Mid Height 60" ZOP3-IWM060M	1506	2186	2033	60	12	37	126 18.75

**ORDERING NOTE:** Inline Walls only connect to Inline Corner Walls.

## PRODUCT CODE KEY

Line	Series	Chair Type	Height	Size	Power/Media
ZOP	3	IW	F0	42	N
Zola	Lounge	Inline Wall	Full Height	42"	None
			M0	48	P
			Mid Height	48"	PowerDoc
				54	M
				54"	Media
				60	MP
				60"	PowerDoc & Media

# ZOLA PRIVACY | INLINE WALLS WITH POWER

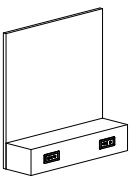
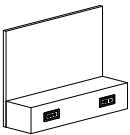
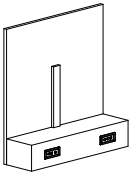
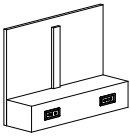
DESCRIPTION/MODEL	THERMOFUSED LAMINATE	HIGH PRESSURE LAMINATE	CHERRY MAPLE BEECH	W	D	H	WEIGHT	CUBE
	Inline Wall w/Power Docs, Full Height 42" ZOP3-IWF042P	2169	2982	2671	42	12	50	150 19
	Inline Wall w/Power Docs, Full Height 48" ZOP3-IWF048P	2257	3163	2770	48	12	50	212 21.5
	Inline Wall w/Power Docs, Full Height 54" ZOP3-IWF054P	2345	3251	2870	54	12	50	135 24
	Inline Wall w/Power Docs, Full Height 60" ZOP3-IWF060P	2433	3340	2970	60	12	50	147 26.5
	Inline Wall w/Power Docs, Mid Height 42" ZOP3-IWM042P	2091	2678	2585	42	12	37	92 13.5
	Inline Wall w/Power Docs, Mid Height 48" ZOP3-IWM048P	2180	2860	2684	48	12	37	102 15.5
	Inline Wall w/Power Docs, Mid Height 54" ZOP3-IWM054P	2268	2948	2785	54	12	37	116 17
	Inline Wall w/Power Docs, Mid Height 60" ZOP3-IWM060P	2356	3036	2883	60	12	37	126 18.75
	Inline Wall Media w/Power Docs, Full Height 42" ZOP3-IWF042MP	2316	3127	2817	42	12	50	150 19
	Inline Wall Media w/Power Docs, Full Height 48" ZOP3-IWF048MP	2404	3310	2917	48	12	50	212 21.5
	Inline Wall Media w/Power Docs, Full Height 54" ZOP3-IWF054MP	2491	3397	3015	54	12	50	135 24
	Inline Wall Media w/Power Docs, Full Height 60" ZOP3-IWF060MP	2580	3486	3116	60	12	50	147 26.5
	Inline Wall Media w/Power Docs, Mid Height 42" ZOP3-IWM042MP	2238	2823	2730	42	12	37	92 13.5
	Inline Wall Media w/Power Docs, Mid Height 48" ZOP3-IWM048MP	2326	3007	2830	48	12	37	102 15.5
	Inline Wall Media w/Power Docs, Mid Height 54" ZOP3-IWM054MP	2413	3093	2929	54	12	37	116 17
	Inline Wall Media w/Power Docs, Mid Height 60" ZOP3-IWM060MP	2503	3182	3030	60	12	37	126 18.75

**ORDERING NOTE:** Inline Walls only connect to Inline Corner Walls.

## PRODUCT CODE KEY

Line	Series	Chair Type	Height	Size	Power/Media
ZOP Zola	3 Lounge	IW Inline Wall	F0 Full Height	42 42"	N None
			M0 Mid Height	48 48"	P PowerDoc
				54 54"	M Media
				60 60"	MP PowerDoc & Media



# ZOLA PRIVACY | INLINE CORNER WALLS

DESCRIPTION/MODEL	THERMOFUSED LAMINATE	HIGH PRESSURE LAMINATE	CHERRY MAPLE BEECH	W	D	H	WEIGHT	CUBE
 Inline Corner Wall, Full Height ZOP3-ICWF0L ZOP3-ICWF0R	1697	2388	2045	26.5	12	50	85	14.75
	1697	2388	2045	26.5	12	50	85	14.75

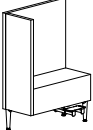
 Inline Corner Wall, Mid Height ZOP3-ICWM0L ZOP3-ICWM0R	1638	2278	1976	26.5	12	37	70	11
	1638	2278	1976	26.5	12	37	70	11

## ZOLA INLINE WALLS SOLID SURFACE OVERLAY UPCHARGES

Option	Grades			
	A-White	A-Color	B	C
ZOP3-IWF042N	427	446	556	662
ZOP3-IWF048N	478	500	622	745
ZOP3-IWF054N	530	555	693	829
ZOP3-IWF060N	555	607	761	913

### ORDERING NOTES:

The Solid Surface top option is priced as an upcharge to existing table price. Please add a "S" to the end of the model number and the upcharge listed below. Zola Solid Surface tables have a 1/2" thickness on top of the existing table, with a 1 mm overhang (soft radius vertical edge). Please see [page 116](#) for color options.

**ORDERING NOTE:** Inline Walls only connect to Inline Corner Walls.

### PRODUCT CODE KEY

Line	Series	Chair Type	Height	Position
ZOP Zola	3 Lounge	ICW Inline Corner Wall	F0 Full Height	L Left
			M0 Mid Height	R Right

# ZOLA PRIVACY | INLINE TABLE WALLS

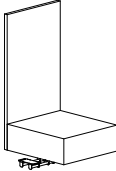
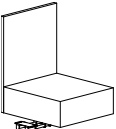
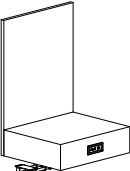
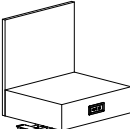
DESCRIPTION/MODEL	THERMOFUSED LAMINATE	HIGH PRESSURE LAMINATE	CHERRY MAPLE BEECH	W	D	H	WEIGHT	CUBE
 Inline Table Wall, Full Height 23" ZOP3-ITWF023N	987	1582	1494	23	25.7	50	100	21
	Inline Table Wall, Full Height 30" ZOP3-ITWF030N	1163	1946	1684	30	25.7	50	125
 Inline Table Wall, Mid Height 23" ZOP3-ITWM023N	910	1279	1408	23	25.7	37	90	15
	Inline Table Wall, Mid Height 30" ZOP3-ITWM030N	1086	1643	1596	30	25.7	37	115
 Inline Table Wall w/Power Docs, Full Height 23" ZOP3-ITWF023P	1984	2579	2491	23	25.7	50	100	21
	Inline Table Wall w/Power Docs, Full Height 30" ZOP3-ITWF030P	2160	2943	2680	30	25.7	50	125
 Inline Table Wall w/Power Docs, Mid Height 23" ZOP3-ITWM023P	1906	2274	2405	23	25.7	37	90	15
	Inline Table Wall w/Power Docs, Mid Height 30" ZOP3-ITWM030P	2083	2639	2592	30	25.7	37	115

**ORDERING NOTE:** For reverse grain direction on table surfaces use list price and note Reverse Grain on p.o.

## PRODUCT CODE KEY

Line	Series	Chair Type	Height	Size	Power/Media
ZOP Zola	3 Lounge	ITW Inline Table Wall	F0 Full Height	23 23"	N None
			M0 Mid Height	30 30"	P Power

# ZOLA PRIVACY | INLINE CORNER TABLE WALLS & INLINE RUN-OFF TABLES

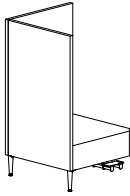
DESCRIPTION/MODEL	THERMOFUSED LAMINATE	HIGH PRESSURE LAMINATE	CHERRY MAPLE BEECH	W	D	H	WEIGHT	CUBE
	Inline Corner Table Wall, Full Height							
	ZOP3-ICTWF0L	1776	2678	2178	28	28	50	140 31
	ZOP3-ICTWF0R	1776	2678	2178	28	28	50	140 31

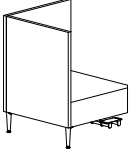
	Inline Corner Table Wall, Mid Height							
	ZOP3-ICTWM0L	1715	2566	2108	28	28	37	127 23
	ZOP3-ICTWM0R	1715	2566	2108	28	28	37	127 23

## ZOLA INLINE TABLE WALLS SOLID SURFACE OVERLAY UPCHARGES

Option	Grades			
	A-White	A-Color	B	C
ZOP3-ITWF023N	483	508	632	756
ZOP3-ITWF030N	605	635	796	957
ZOP3-ITWM023N	483	508	632	756
ZOP3-ITWM030N	605	635	796	957
ZOP3-ITWF023P	483	508	632	756
ZOP3-ITWF030P	605	635	796	957
ZOP3-ITWM023P	483	508	632	756
ZOP3-ITWM030P	605	635	796	957
ZOP3-ICTWF0	607	637	801	961
ZOP3-ICTWM0	607	637	801	961

### ORDERING NOTES:

The Solid Surface top option is priced as an upcharge to existing table price. Please add a "S" to the end of the model number and the upcharge listed below. Zola Solid Surface tables have a 1/2" thickness on top of the existing table, with a 1 mm overhang (soft radius vertical edge). Please see [page 116](#) for color options.







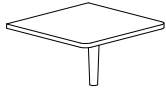



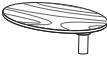

### PRODUCT CODE KEY

Line	Series	Chair Type	Height	Position
ZOP	3	ICTW	F0	L
Zola	Lounge	Inline Corner Table Wall	Full Height	Left
			M0	R
			Mid Height	Right



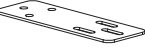
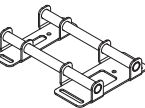

DESCRIPTION/MODEL	THERMOFUSED LAMINATE	HIGH PRESSURE LAMINATE	CHERRY MAPLE BEECH	W	D	H	WEIGHT	CUBE
	Run-off Table for 48" Inline Wall							
	ZOL4-RO48-302416	904	1279	1389	30	24	16	25 3.75
	ZOL4-RO48-372416	954	1380	1455	37	24	16	30 4.5
	ZOL4-RO48-532416	1066	1615	1603	53	24	16	40.5 5.75
	ZOL4-RO48-762416	1231	1953	1818	76	24	16	56 7.5

	Run-off Table for 54" Inline Wall							
	ZOL4-RO54-303016	957	1252	1459	30	30	16	35 4.25
	ZOL4-RO54-373016	1018	1379	1540	37	30	16	41 5.25
	ZOL4-RO54-533016	1163	1671	1728	53	30	16	54 6.75
	ZOL4-RO54-763016	1370	2092	1995	76	30	16	74 8.75

# ZOLA | COLLECTION COMPONENTS

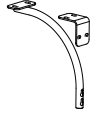
DESCRIPTION/MODEL	PRICE	WEIGHT	CUBE
 Wood Tablet & Mounting Plate Only ZOL3 RT1    Beech Maple /Cherry	381	5	0.32
	405	5	0.32
 Painted Tablet & Mounting Plate Only ZOL3 RT2    n/a	278	5	0.32
 Clear Glass Tablet & Mounting Plate Only ZOL3 RT3    n/a	651	6	0.32
 Laminate Tablet & Mounting Plate Only ZOL3 RT4    n/a	397	5	0.32
 Solid Surface Tablet & Mounting Plate Only ZOL3 RT5    Grade - A-White Grade - A-Color Grade - B Grade - C	539		
	547		
	577		
	624		
<b>ORDERING NOTES:</b> The Zola replacement tablets on this page include the top with mounting plate only.			
 Leg ZOL3 RLS	58	1	0.125
 Caster Leg ZOL3 RLC	39	0.4	0.125
 Dual leg ZOL3 RDL	100	1	0.125
 Leg Glide (4) ZOL3 RLG	24	0.2	0.01
 Replacement Seat-to-Seat Bracket ZOL3 RLKB2	95	1	0.125
<b>NOTE:</b> Zola Modular Seats are ordered, each seat is automatically supplied with two seat to seat brackets			
 Replacement Table-to-Seat Bracket ZOL3 RLKB1	114	3	0.125
 ZOL3-POWERDOC1 - Undermount	570	3	0.375
Can be field installed to the underside of Seats and Tables as a replacement part or installed on units not previously specified with a Powerdoc. Standard with 2 Power and 2 USB outlets. PowerDoc's have a 10' cord.			
 ZOL3-POWERDOC2	647	3	0.375
Replacement unit only for Seats, Benches or Square/Rectangular tables which were originally ordered with this power option. Standard with 2 Power and 2 USB outlets. PowerDoc's have a 10' cord.			
 Wire Manager Shroud ZOL3 WM10	120	1	0.375
<b>ORDERING NOTES:</b> Comes in a 10' length when ordered. Can be cut to size on site.			

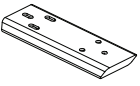
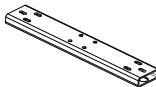
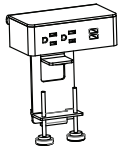
## ZOLA PRIVACY | COMPONENTS

DESCRIPTION/MODEL	PRICE	WEIGHT	CUBE
 <p>Replacement Shelf Support Bracket Kit ( includes 90deg bracket, curved bracket, fasteners) ZOP3-RSSB</p>	67	2	0.32
 <p>Back Alignment Hardware Kit (includes male &amp; female bracket, fasteners) ZOP3-LKBC</p>	58	2	0.32
 <p>Privacy Screen Hardware (includes bracket, fasteners) ZOP3-RSH</p>	74	2	0.32
 <p>Back-to-Seat Linking hardware ZOP3-RLKS</p>	169	3	0.32
 <p>Twin Back-to-Seat Linking Hardware ZOP3-RLKT</p>	187	4	0.32
 <p>ZOP3-POWERDOC3 - Shelves only Replacement unit only for Shelves which were originally ordered with this power option. Standard with 2 Power and 2 USB outlets.</p>	661	3	0.375
 <p>Wire Manager for Inline Media Wall ZOL3 WM</p>	187	1	0.375

# ZOLA BENCH | ENVIRONMENTAL SUMMARY

## LEED CI CREDITS

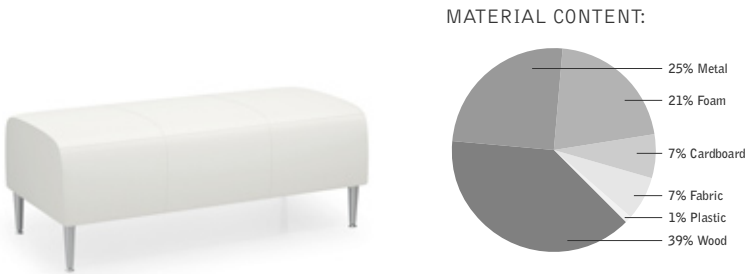

**MATERIAL CONTENT:**

- 25% Metal
- 21% Foam
- 7% Cardboard
- 7% Fabric
- 1% Plastic
- 39% Wood

**PRE-CONSUMER RECYCLED CONTENT = 6.43%**

**POST-CONSUMER RECYCLED CONTENT = 16.25%**

Up to 38.93% of this Zola product is recyclable at the end of its useful life.

CONTRIBUTES TO		
CREDIT 2.1 - 2.2	Construction Waste Management	1-2 point(s)
CREDIT 3.3	Resource Reuse	1 point
CREDIT 4.1	Recycled Content	1 point
CREDIT 4.5	Low Emitting Materials, Systems & Seating	1 point
CREDIT 5.1	Regional Materials*	1 point
CREDIT 7	Certified Wood (MUST BE REQUESTED)	1 point(s)

\*This credit is only applicable if in total 20% of the combined value of the procurement of construction materials and in the furniture are manufactured within a radius of 500 miles. This credit will apply if the installation of the finished product occurs within 500 miles of Kitchener, Ontario.

## level® CERTIFICATION, AIR EMISSIONS AND FSC® CERTIFICATION



### level® CERTIFICATION

BIFMA's e3 Furniture Sustainability Standard is a voluntary, multi-attribute standard that measures the degree of sustainability of furniture. This standard evaluates product and company environmental attributes and compliance systems in a wide range of elements which include Materials, Energy & Atmosphere, Human & Ecosystem Health and Social Responsibility. Zola Bench products have earned level®, BIFMA's sustainability certification program for furniture, certification through third-party verification against the e3 standard.



FSC  
www.fsc.org  
FSC® C021899

The mark of responsible forestry

### AIR EMISSIONS

All Zola Bench products are supplied air emissions-certified. Contact customer service for information.

### FSC®

In 2005, Krug received Forest Stewardship Council® (FSC®) Chain-of-Custody certification for our manufacturing facilities. The FSC® Chain-of-Custody tracks certified wood from seedling to final sale. It verifies that the material for our FSC® certified products only come from well-managed, FSC®-certified forests and other controlled sources. FSC® is dedicated to the promotion of responsible forest management worldwide helping to take care of forests for future generations. Zola and other Krug products can be specified with FSC® Certification. Contact customer service for further information, pricing and lead times.



Architects, designers, and building professionals can specify FSC®-certified products in order to achieve a point from the U.S. Green Building Council's Leadership in Energy and Environmental Design (LEED) Rating System.

## ZOLA | MODULAR & MODULAR PLUS BENCH STANDARD DEPTH

### DIMENSIONS

	Overall Width	Overall Depth	Overall (Seat) Height	Shipping Weight	Cubes
One-Seat	23	22.25	18.5	28	5.2
Two-seat	46	22.25	18.5	48	9.4
Three-seat	69	22.25	18.5	64	14
One-Seat (Plus)	30	22.25	18.5	31	6.1
Two-seat (Plus)	46	22.25	18.5	48	9.4
Three-seat (Plus)	69	22.25	18.5	64	14

### COM YARDAGES

	COM Yardage Bench	COM Yardage 2 Benches	COM Yardage 3 Benches	COM Yardage 4 Benches
One-Seat	1.25	2	2.75	4
Two-seat	1.70	3.5	4.91	6.6
Three-seat	2.5	4.5	7	8.9
One-Seat (Plus)	1.25	2.6	3.98	5.3

To calculate the COM Yardage for more than 4 units, take the largest multiple (4 units) and add the closest remainder.

See below for example calculations.

5 Units = Take the yardage for 4 units and add the yardage for 1 unit

7 Units = Take the yardage for 4 units and add the yardage for 3 units

8 Units = Take the yardage for 4 units and multiple by 2

9 Units = Take the yardage for 4 units, multiply by 2, add yardage for 1 unit

10 Units = Take the yardage for 4 units, multiply by 2, add yardage for 2 units

20 Units = Take the yardage for 4 units, multiply by 5

## ZOLA | MODULAR & MODULAR PLUS BENCH FULL DEPTH

### DIMENSIONS

	Overall Width	Overall Depth	Seat Height	Shipping Weight	Cubes
One-Seat	23	26	18.5	33	11.5
Two-seat	46	26	18.5	55	21
Three-seat	69	26	18.5	72	32
One-Seat (Plus)	30	26	18.5	45	16
Two-seat (Plus)	46	26	18.5	57	21
Three-seat (Plus)	69	26	18.5	75	32

### COM YARDAGES

	COM Yardage Bench	COM Yardage 2 Benches	COM Yardage 3 Benches	COM Yardage 4 Benches
One-Seat	1.4	2.2	3.6	4.4
Two-seat	1.85	3.7	5.6	7.4
Three-seat	2.8	5.6	8.4	11.2
One-Seat (Plus)	1.85	3.7	5.6	7.4
Two-seat (Plus)	1.85	3.7	5.6	7.4
Three-seat (Plus)	2.8	5.6	8.4	11.2

To calculate the COM Yardage for more than 4 units, take the largest multiple (4 units) and add the closest remainder.

See below for example calculations.

5 Units = Take the yardage for 4 units and add the yardage for 1 unit

7 Units = Take the yardage for 4 units and add the yardage for 3 units

8 Units = Take the yardage for 4 units and multiple by 2

9 Units = Take the yardage for 4 units, multiply by 2, add yardage for 1 unit





10 Units = Take the yardage for 4 units, multiply by 2, add yardage for 2 units

20 Units = Take the yardage for 4 units, multiply by 5



### Upcharge for Removable Upholstery Covers:

Option	\$ List	Option	\$ List
Arms (Right or Left)	77	One-Seat standard depth seat	47
Interim Arm	61	Two-seat standard depth seat	68
One-Seat back	68	Three-seat standard depth seat	85
Two-seat back	97	One-Seat plus standard depth seat	61
Three-seat back	121	One-Seat full depth seat	52
One-Seat plus back	78	Two-seat full depth seat	74
		Three-seat full depth seat	85
		One-Seat plus full depth seat	67

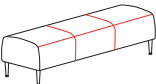
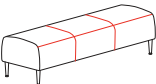
## ZOLA | MODULAR & MODULAR PLUS BENCH STANDARD DEPTH

DESCRIPTION/MODEL	COM		COL	FABRIC GRADES			LEATHER		
	1	2	3	4	5	6	7	8	9
 One-Seat ZOL3 MS1S1	871	916	963	1053	1139	1227	1314	1398	1535
 One-Seat Plus ZOL3 MSB1S1	1098	1146	1195	1289	1384	1480	1572	1668	1810
<b>ORDERING NOTES:</b> One-Seat Plus Bench is 30" wide.									
 Two-Seat ZOL3 MS2S1	1218	1272	1330	1447	1566	1685	1803	1922	2118
 Two-Seat Plus ZOL3 MSB2S1	1297	1359	1422	1540	1662	1778	1897	2017	2214
<b>ORDERING NOTES:</b> The Two-Seat Plus comes standard with a fifth leg for extra support.									
 Three-Seat ZOL3 MS3S1	1558	1638	1715	1883	2048	2214	2381	2548	2748
 Three-Seat Plus ZOL3 MSB3S1	1852	1928	2010	2148	2294	2434	2579	2718	2946
<b>ORDERING NOTES:</b> The Three-Seat Plus comes standard with a fifth leg for extra support.									

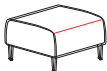
## ZOLA | MODULAR & MODULAR PLUS BENCH FULL DEPTH

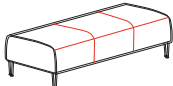
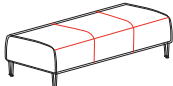
DESCRIPTION/MODEL	COM		COL	FABRIC GRADES			LEATHER		
	1	2	3	4	5	6	7	8	9
 One-Seat ZOL3 MS1F1	961	1011	1058	1121	1198	1263	1336	1431	1555
 One-Seat Plus ZOL3 MSB1F1	1158	1222	1284	1371	1467	1557	1657	1778	1905
<b>ORDERING NOTES:</b> One-Seat Plus Bench is 30" wide.									
 Two-Seat ZOL3 MS2F1	1420	1482	1545	1632	1730	1817	1918	2040	2166
 Two-Seat Plus ZOL3 MSB2F1	1474	1536	1597	1685	1781	1870	1968	2238	2218
<b>ORDERING NOTES:</b> The Two-Seat Plus comes standard with a fifth leg for extra support.									
 Three-Seat ZOL3 MS3F1	1921	2016	2108	2236	2388	2522	2671	2859	3047
 Three-Seat Plus ZOL3 MSB3F1	1988	2085	2176	2310	2460	2591	2742	2928	3117
<b>ORDERING NOTES:</b> The Three-Seat Plus comes standard with a fifth leg for extra support.									

**ORDERING NOTES:** Zola Bench Seating is available with 4 casters, for an upcharge of **\$107 list** per chair. Please add a '2' at the end of the model number for casters ie; ZOL31112. Zola Bench Seating is available with 2 legs and 2 casters version, for an upcharge of **\$77 list** per chair. Please add a '3' at the end of the model number for leg/caster version ie; ZOL3F1113. Please note, plus versions are not available with caster options.

### PRODUCT CODE KEY

Line	Series	Chair Type	Seat Count	Seat Depth	Leg Type
ZOL Zola	3 Soft Seating	MS Modular	1 One Seat	S Standard Depth	1 Standard Leg & Glide
		MSB Modular Plus	2 Two Seat	F Full Depth	2 Casters
			3 Three Seat		3 2 Legs & 2 Casters



# ZOLA | MODULAR CURVE BENCH

## DIMENSIONS INSIDE CURVE

	Overall Width	Overall Depth	Seat Height	Seat Depth	Shipping Weight	Cubes
<b>Single seat</b>						
30°	36	28.5	18.5	22.5	50	18
45°	42	29	18.5	22.5	54	19
60°	48	29	18.5	22.5	57	22
90°	59	31	18.5	22.5	69	26
<b>Double seat</b>						
30°	58	30	18.5	22.5	90	32
45°	64	31	18.5	22.5	97.2	33
60°	70	33	18.5	22.5	102.6	39
90°	81	36	18.5	22.5	124.2	46

## COM Yardages

	COM Yardage Entire Unit	COM Yardage 2 Entire Units	COM Yardage 3 Entire Units	COM Yardage 4 Entire Units
<b>Single seat</b>				
30°	3.70	7.4	11.1	14.8
45°	4.40	8.8	13.2	17.6
60°	4.40	8.8	13.2	17.6
90°	4.61	9.2	13.83	18.44
<b>Double seat</b>				
30°	6.3	12.6	18.9	25.2
45°	6.4	12.8	19.2	25.6
60°	8.2	16.4	24.6	32.8
90°	8.2	16.4	24.6	32.8

## COM Yardages - Individual Components

	COM Yardage Per Back	COM Yardage Per 2 Backs	COM Yardage Per 3 Backs	COM Yardage Per 4 Backs	COM Yardage Per Seat	COM Yardage Per 2 Seats	COM Yardage Per 3 Seats	COM Yardage Per 4 Seats
<b>Single seat</b>								
30°	1.9	3.8	5.7	7.6	1.8	3.6	5.4	7.2
45°	2.6	5.2	7.8	10.4	1.8	3.6	5.4	7.2
60°	2.6	5.2	7.8	10.4	1.8	3.6	5.4	7.2
90°	2.8	5.6	8.4	11.2	1.8	3.6	5.4	7.2
<b>Double seat</b>								
30°	2.9	5.8	8.7	11.6	3.4	6.8	10.2	13.6
45°	3	6.0	9.0	12.0	3.4	6.8	10.2	13.6
60°	4.8	8.8	13.5	17.4	3.4	6.8	10.2	13.6
90°	4.8	8.8	13.5	17.4	3.4	6.8	10.2	13.6

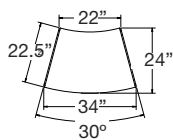

One-Seat, Uph 30° Inside Curve

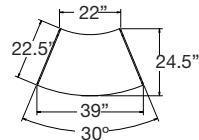

One-Seat, Uph 45° Inside Curve

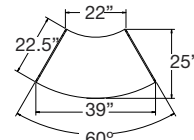

One-Seat, Uph 60° Inside Curve

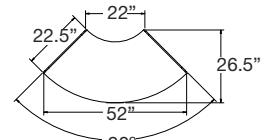

One-Seat, Uph 90° Inside Curve

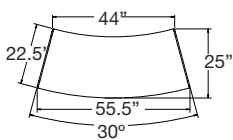

Two-Seat, Uph 30° Inside Curve

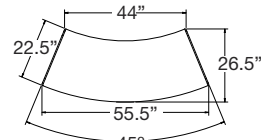

Two-Seat, Uph 45° Inside Curve

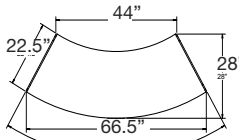

Two-Seat, Uph 60° Inside Curve

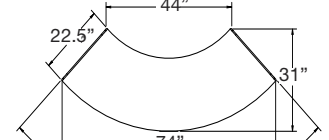

Two-Seat, Uph 90° Inside Curve

## Upcharge for Removable Upholstery Covers:

Option	\$ List	Option	\$ List
Single-seat curve 30° seat	61	Double-seat curve 30° seat	93
Single-seat curve 45° seat	64	Double-seat curve 45° seat	101
Single-seat curve 60° seat	86	Double-seat curve 60° seat	123
Single-seat curve 90° seat	113	Double-seat curve 90° seat	126

# ZOLA | MODULAR CURVE BENCH

## DIMENSIONS OUTSIDE CURVE

	Overall Width	Overall Depth	Seat Height	Seat Depth	Shipping Weight	Cubes
<b>Single seat</b>						
30°	33.75	28.25	18.5	22.5	48	23
45°	38.75	28.75	18.5	22.5	49	24
60°	43.5	29.25	18.5	22.5	50	29
90°	52	29.75	18.5	22.5	51	34
<b>Double seat</b>						
30°	55.75	29.75	18.5	22.5	83	36
45°	60.75	31	18.5	22.5	84	40
60°	65.75	32.25	18.5	22.5	86	45
90°	74	34.5	18.5	22.5	96	56

## COM Yardages

	COM Yardage Entire Unit	COM Yardage 2 Entire Units	COM Yardage 3 Entire Units	COM Yardage 4 Entire Units
<b>Single seat</b>				
30°	3.32	6.14	9.46	12.28
45°	3.32	6.14	9.46	12.28
60°	3.32	6.14	9.46	12.28
90°	3.32	6.14	9.46	12.28
<b>Double seat</b>				
30°	6.50	13.0	19.5	26.0
45°	6.50	13.0	19.5	26.0
60°	6.50	13.0	19.5	26.0
90°	6.50	13.0	19.5	26.0

## COM Yardages - Individual Components

	COM Yardage Per Back	COM Yardage Per 2 Backs	COM Yardage Per 3 Backs	COM Yardage Per 4 Backs	COM Yardage Per Seat	COM Yardage Per 2 Seats	COM Yardage Per 3 Seats	COM Yardage Per 4 Seats
<b>Single seat</b>								
30°	1.7	2.95	4.65	5.9	1.8	3.6	5.4	7.2
45°	1.7	2.95	4.65	5.9	1.8	3.6	5.4	7.2
60°	1.7	2.95	4.65	5.9	1.8	3.6	5.4	7.2
90°	1.7	2.95	4.65	5.9	1.8	3.6	5.4	7.2
<b>Double seat</b>								
30°	3.1	6.2	9.3	12.4	3.4	6.8	10.2	13.6
45°	3.1	6.2	9.3	12.4	3.4	6.8	10.2	13.6
60°	3.1	6.2	9.3	12.4	3.4	6.8	10.2	13.6
90°	3.1	6.2	9.3	12.4	3.4	6.8	10.2	13.6

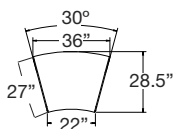

One-Seat, Uph 30° Curve

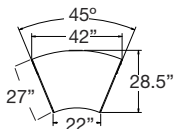

One-Seat, Uph 45° Curve

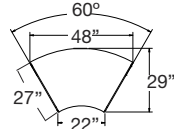

One-Seat, Uph 60° Curve

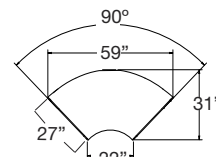

One-Seat, Uph 90° Curve

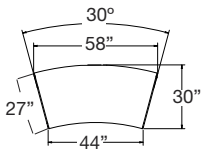

Two-Seat, Uph 30° Curve

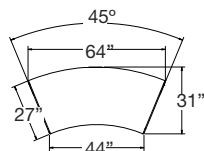

Two-Seat, Uph 45° Curve

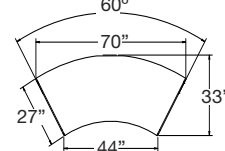

Two-Seat, Uph 60° Curve

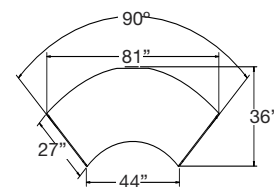









Two-Seat, Uph 90° Curve

## Upcharge for Removable Upholstery Covers:

Option	\$ List	Option	\$ List
Single-seat curve 30° seat	61	Double-seat curve 30° seat	93
Single-seat curve 45° seat	64	Double-seat curve 45° seat	101
Single-seat curve 60° seat	86	Double-seat curve 60° seat	123
Single-seat curve 90° seat	113	Double-seat curve 90° seat	126

# ZOLA | MODULAR CURVE BENCH





DESCRIPTION/MODEL	COM		COL	FABRIC GRADES			LEATHER		
	1	2	3	4	5	6	7	8	9
 Single-Seat, 30° Curve, Standard Depth ZOL3 MCS30DS1	1251	1361	1478	1634	1813	1970	2149	2378	2602
 Single-Seat, 45° Curve, Standard Depth ZOL3 MCS45DS1	1361	1528	1691	1922	2186	2415	2678	3008	3336
 Single-Seat, 60° Curve, Standard Depth ZOL3 MCS60DS1	1539	1705	1869	2100	2360	2591	2854	3184	3513
 Single-Seat, 90° Curve, Standard Depth ZOL3 MCS90DS1	1776	1956	2136	2390	2681	2934	3222	3587	3949
 Single-Seat, 30° Curve, Full Depth ZOL3 MCS30DF1	1376	1499	1623	1797	1995	2168	2368	2613	2861
 Single-Seat, 45° Curve, Full Depth ZOL3 MCS45DF1	1501	1680	1861	2113	2405	2657	2946	3307	3669
 Single-Seat, 60° Curve, Full Depth ZOL3 MCS60DF1	1693	1875	2056	2308	2596	2851	3138	3501	3864
 Single-Seat, 90° Curve, Full Depth ZOL3 MCS90DF1	1954	2149	2352	2631	2948	3229	3545	3946	4343

**ORDERING NOTES:** Please note when Zola Modular Benches are ordered, each bench is automatically supplied with two seat to seat brackets (ZOL3 RLKB2). All Modular Units, and tables will be shipped KD (knocked down). Modular Curved Benches are offered in two depths. For a flush edge when joining a Modular Curved Bench to Modular seat with back choose the Full Depth.

## PRODUCT CODE KEY

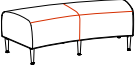
Line	Series	Chair Type	Seat Count	Seat Degree	Seat Depth	Leg Type
ZOL Zola	3 Soft Seating	MC Modular	S Single	30D 30 Degree	S Standard	1 Standard Leg + Glide
		MCB Modular Plus	D Double	45D 45 Degree	F Full	
				60D 60 Degree		
				90D 90 Degree		

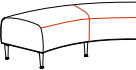
# ZOLA | MODULAR CURVE BENCH

DESCRIPTION/MODEL	COM		COL	FABRIC GRADES			LEATHER		
	1	2	3	4	5	6	7	8	9
 Double-Seat, 30° Curve, Standard Depth ZOL3 MCD30DS1	2190	2385	2584	2858	3173	3452	3766	4160	4555
 Double-Seat, 45° Curve, Standard Depth ZOL3 MCD45DS1	2385	2672	2959	3363	3820	4223	4684	5259	5834
 Double-Seat, 60° Curve, Standard Depth ZOL3 MCD60DS1	2694	2983	3269	3671	4131	4533	4994	5569	6142
 Double-Seat, 90° Curve, Standard Depth ZOL3 MCD90DS1	3105	3424	3740	4184	4691	5135	5640	6273	6909

### Upcharge for Removable Upholstery Covers:

Option	\$ List
Double-seat curve 30° seat	93
Double-seat curve 45° seat	101
Double-seat curve 60° seat	123
Double-seat curve 90° seat	127

**ORDERING NOTES:** Please note when Zola Modular Benches are ordered, each bench is automatically supplied with two seat to seat brackets (ZOL3 RLKB2). All Modular Units, and tables will be shipped KD (knocked down). Modular Curved Benches are offered in two depths. For a flush edge when joining a Modular Curved Bench to Modular seat with back choose the Full Depth.

### PRODUCT CODE KEY

Line	Series	Chair Type	Seat Count	Seat Degree	Seat Depth	Leg Type
ZOL Zola	3 Soft Seating	MC Modular	S Single	30D 30 Degree	S Standard	1 Standard Leg + Glide
		MCB Modular Plus	D Double	45D 45 Degree	F Full	
				60D 60 Degree		
				90D 90 Degree		

# ZOLA | MODULAR CURVE BENCH

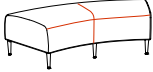
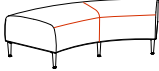
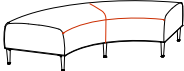
DESCRIPTION/MODEL	COM		COL		FABRIC GRADES			LEATHER	
	1	2	3	4	5	6	7	8	9
 Double-Seat, 30° Curve, Full Depth ZOL3 MCD30DF1	2516	2742	2969	3287	3648	3966	4331	4784	5236
 Double-Seat, 45° Curve, Full Depth ZOL3 MCD45DF1	2742	3073	3403	3866	4395	4859	5388	6048	6709
 Double-Seat, 60° Curve, Full Depth ZOL3 MCD60DF1	3099	3429	3760	4221	4752	5214	5742	6405	7066
 Double-Seat, 90° Curve, Full Depth ZOL3 MCD90DF1	3573	3935	4297	4812	5393	5904	6486	7215	7945

## Upcharge for Removable Upholstery Covers:







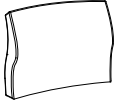

Option	\$ List
Double-seat curve 30° seat	93
Double-seat curve 45° seat	101
Double-seat curve 60° seat	123
Double-seat curve 90° seat	127

**ORDERING NOTES:** Please note when Zola Modular Benches are ordered, each bench is automatically supplied with two seat to seat brackets (ZOL3 RLKB2). All Modular Units, and tables will be shipped KD (knocked down). Modular Curved Benches are offered in two depths. For a flush edge when joining a Modular Curved Bench to Modular seat with back choose the Full Depth.

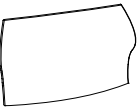
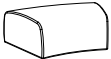

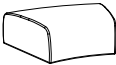
## PRODUCT CODE KEY

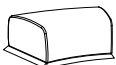
Line	Series	Chair Type	Seat Count	Seat Degree	Seat Depth	Leg Type
ZOL Zola	3 Soft Seating	MC Modular	S Single	30D 30 Degree	S Standard	1 Standard Leg + Glide
		MCB Modular Plus	D Double	45D 45 Degree	F Full	
				60D 60 Degree		
				90D 90 Degree		

# ZOLA | MODULAR CURVE BENCH - REPLACEMENT COMPONENTS

DESCRIPTION	MODEL	COM		COL			FABRIC GRADES			LEATHER			COM	YARDAGE	WEIGHT	CUBE
		1	2	3	4	5	6	7	8	9						
	Replacement Back Single-seat Inside Curve															
	ZOL3 RMCBIS30D	1168	1247	1330	1443	1569	1686	1815	1977	2136	1.9	20	8			
	ZOL3 RMCBIS45D	1355	1443	1533	1659	1801	1924	2066	2244	2423	2.6	22	8			
	ZOL3 RMCBIS60D	1647	1772	1893	2064	2257	2431	2628	2870	3113	2.6	23	10			
	ZOL3 RMCBIS90D	1841	1967	2094	2272	2476	2652	2854	3109	3363	2.8	28	11			
	Replacement Back Double-seat Inside Curve															
	ZOL3 RMCBID30D	2042	2185	2324	2524	2747	2947	3172	3456	3739	2.8	38	13			
	ZOL3 RMCBID45D	2369	2524	2681	2898	3147	3367	3617	3929	4239	3	42	13.5			
	ZOL3 RMCBID60D	2884	3099	3313	3610	3954	4252	4595	5022	5448	4.8	43	16			
	ZOL3 RMCBID90D	3220	3444	3665	3975	4331	4641	4995	5440	5884	4.8	52.5	18			
	Replacement Back Single-seat Outside Curve															
	ZOL3 RMCBOS30D	1053	1122	1197	1298	1415	1515	1633	1778	1923	1.7	15	5.0			
	ZOL3 RMCBOS45D	1218	1298	1380	1492	1620	1732	1861	2020	2182	1.7	17	7.0			
	ZOL3 RMCBOS60D	1458	1593	1704	1858	2033	2190	2361	2584	2803	1.7	20	9.0			
	ZOL3 RMCBOS90D	1659	1772	1885	2045	2228	2386	2569	2798	3028	1.7	25	9.0			
	Replacement Back Double-seat Outside Curve															
	ZOL3 RMCBOD30D	1839	1965	2092	2271	2473	2652	2857	3111	3366	3.1	30	9.0			
	ZOL3 RMCBOD45D	2133	2272	2412	2610	2833	3030	3252	3535	3816	3.1	34	11.0			
	ZOL3 RMCBOD60D	2596	2789	2983	3249	3559	3827	4133	4520	4903	3.1	35	14.0			
	ZOL3 RMCBOD90D	2898	3099	3299	3578	3896	4177	4498	4897	5295	3.1	40	14.0			
	Replacement Seat Single-seat Standard Depth Curve															
	ZOL3 RMCSS30DS	1143	1258	1372	1529	1708	1866	2046	2272	2496	1.8	30	11			
	ZOL3 RMCSS45DS	1258	1421	1443	1816	2080	2312	2570	2902	3231	1.8	32	12			
	ZOL3 RMCSS60DS	1437	1598	1765	1993	2255	2487	2747	3077	3408	1.8	34	13			
	ZOL3 RMCSS90DS	1636	1816	1998	2252	2539	2794	3082	3446	3809	1.8	41	16			
	Replacement Seat Double-seat Standard Depth Curve															
	ZOL3 RMCSD30DS	2084	2280	2478	2751	3069	3344	3662	4057	4449	3.4	52.2	19.5			
	ZOL3 RMCSD45DS	2280	2567	2854	3257	3714	4118	4579	5605	5727	3.4	56	21			
	ZOL3 RMCSD60DS	2589	2878	3163	3565	4027	4427	4888	5464	6039	3.4	60	23			
	ZOL3 RMCSD90DS	2966	3283	3602	4042	4551	4994	5502	6136	6767	3.4	72	28			
	Replacement Seat Single-seat Full Depth Curve															
	ZOL3 RMCSS30DF	1270	1393	1518	1691	1890	2063	2263	2507	2757	1.94	36	13.5			
	ZOL3 RMCSS45DF	1394	1573	1755	2010	2298	2552	2839	3202	3563	1.94	39	14.5			
	ZOL3 RMCSS60DF	1589	1771	1951	2202	2492	2744	3035	3397	3759	1.94	41	15.5			
	ZOL3 RMCSS90DF	1813	2012	2211	2491	2807	3090	3405	3804	4205	1.94	49	19			
	Replacement Seat Double-seat Full Depth Curve															
	ZOL3 RMCSD30DF	2410	2637	2863	3182	3543	3862	4223	4678	5131	3.7	63	24			
	ZOL3 RMCSD45DF	2637	2968	3297	3761	4289	4754	5281	5941	6603	3.7	69	25.5			
	ZOL3 RMCSD60DF	2992	3322	3654	4116	4645	5109	5636	6297	6960	3.7	72	27			
	ZOL3 RMCSD90DF	3431	3795	4160	4669	5256	5764	6347	7074	7806	3.7	86	33.5			
	Replacement Seat Cover Single-seat Standard Depth Curve															
	ZOL3 RMCBSCS30DS	223	279	337	416	510	590	680	796	912	1.8	2.5	1			
	ZOL3 RMCBSCS45DS	229	286	344	424	516	597	689	805	917	1.8	3.1	1			
	ZOL3 RMCBSCS60DS	265	321	380	458	552	632	725	840	955	1.8	3.7	1.5			
	ZOL3 RMCBSCS90DS	287	345	404	483	573	655	746	864	978	1.8	4.3	1.5			
	Replacement Seat Cover Double-seat Standard Depth Curve															
	ZOL3 RMCBSCD30DS	388	494	603	757	930	1083	1257	1474	1691	3.4	4.8	1.5			
	ZOL3 RMCBSCD45DS	394	507	614	765	939	1090	1265	1482	1698	3.4	5.9	1.5			
	ZOL3 RMCBSCD60DS	446	556	664	815	988	1140	1314	1533	1748	3.4	7.0	2.5			
	ZOL3 RMCBSCD90DS	464	571	679	833	1008	1161	1333	1551	1768	3.4	8.2	2.5			

# ZOLA | MODULAR CURVE - REPLACEMENT COMPONENTS

DESCRIPTION	MODEL	COM		COL	FABRIC GRADES			LEATHER			COM		
		1	2	3	4	5	6	7	8	9	YARDAGE	WEIGHT	CUBE
	Replacement Seat Cover Single-seat Full Depth Curve												
	ZOL3 RMCBSCS30DF	246	312	380	470	571	665	768	898	1030	1.94	2.9	1
	ZOL3 RMCBSCS45DF	256	320	386	478	582	672	778	906	1036	1.94	3.6	1
	ZOL3 RMCBSCS60DF	295	359	424	515	620	710	812	943	1073	1.94	4.3	1.5
	ZOL3 RMCBSCS90DF	313	380	444	536	640	730	835	962	1094	1.94	4.9	1.5
	Replacement Seat Cover Double-seat Full Depth Curve												
	ZOL3 RMCBSCD30DF	433	557	680	853	1054	1228	1423	1672	1922	3.7	5.5	1.5
	ZOL3 RMCBSCD45DF	441	565	689	865	1062	1236	1434	1683	1929	3.7	6.8	1.5
	ZOL3 RMCBSCD60DF	493	619	743	915	1116	1289	1487	1735	1984	3.7	8.1	2.5
	ZOL3 RMCBSCD90DF	530	654	778	952	1147	1320	1522	1771	2017	3.7	9.4	2.5

# ZOLA BEHAVIORAL HEALTH | ENVIRONMENTAL SUMMARY

## LEED CI CREDITS

HEALTHCARE DISCOUNT APPLIES TO THESE PRODUCTS



MATERIAL CONTENT:

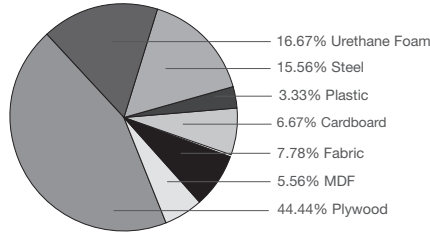

PRE-CONSUMER RECYCLED CONTENT = 2.78%

POST-CONSUMER RECYCLED CONTENT = 9.71%

Up to 22.22% of this Zola Behavioral Health product is recyclable at the end of its useful life.

CONTRIBUTES TO		
CREDIT 2.1 - 2.2	Construction Waste Management	1-2 point(s)
CREDIT 3.3	Resource Reuse	1 point
CREDIT 4.1	Recycled Content	1 point
CREDIT 4.5	Low Emitting Materials, Systems & Seating	1 point
CREDIT 5.1	Regional Materials*	1 point
CREDIT 7	Certified Wood (MUST BE REQUESTED)	1 point(s)

\*This credit is only applicable if in total 20% of the combined value of the procurement of construction materials and in the furniture are manufactured within a radius of 500 miles. This credit will apply if the installation of the finished product occurs within 500 miles of Kitchener, Ontario.

## level® CERTIFICATION, AIR EMISSIONS AND FSC® CERTIFICATION



### level® CERTIFICATION

BIFMA's e3 Furniture Sustainability Standard is a voluntary, multi-attribute standard that measures the degree of sustainability of furniture. This standard evaluates product and company environmental attributes and compliance systems in a wide range of elements which include Materials, Energy & Atmosphere, Human & Ecosystem Health and Social Responsibility. Zola Behavioral Health products have earned level®, BIFMA's sustainability certification program for furniture, certification through third-party verification against the e3 standard.



The mark of responsible forestry

### AIR-EMISSIONS

All Zola Behavioral Health products are supplied air-emissions certified. Contact customer service for information.

### FSC®

In 2005, Krug received Forest Stewardship Council® (FSC®) Chain-of-Custody certification for our manufacturing facilities. The FSC® Chain-of-Custody tracks certified wood from seedling to final sale. It verifies that the material for our FSC® certified products only come from well-managed, FSC®-certified forests and other controlled sources. FSC® is dedicated to the promotion of responsible forest management worldwide helping to take care of forests for future generations. Jordan and other Krug products can be specified with FSC® Certification. Contact customer service for further information, pricing and lead times.



Architects, designers, and building professionals can specify FSC®-certified products in order to achieve a point from the U.S. Green Building Council's Leadership in Energy and Environmental Design (LEED) Rating System.



# ZOLA BEHAVIORAL HEALTH | FEATURES

HEALTHCARE DISCOUNT APPLIES TO THESE PRODUCTS



## TAMPER-RESISTANT HARDWARE

This is utilized on all connection points of the product that are (or potentially) accessible, hindering components from being removed or the product being dis-assembled. The unique tools for these fasteners are available from Krug for any maintenance and component replacement.



## INACCESSIBLE STAPLES

All staples on this product are covered and made inaccessible with a secondary barrier, which is fastened with tamper-resistant hardware.



## LIGATURE RISK REDUCTION

This product has been designed to minimize the ability to use it for ligature - the closed arm panels, the elimination of legs, and the option of Restricted Access Upholstery significantly reduce the points on the product that could be used for ligature.



## SPRINGLESS SEAT CONSTRUCTION

A very comfortable and durable sit is achieved without internal metal components such as springs - the high resiliency foam and heavy-duty suspension sheet webbing are materials used to deter harm or damage.

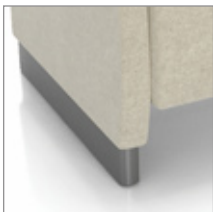

## ARM PANEL BASE

This product has no legs (which could be used to cause harm or damage, or for ligature); instead the bottom portion of each arm panel is a 3" vinyl-clad runner. The durable covering is tightly secured, easy to clean, and will resist damage caused by cleaning equipment, etc.

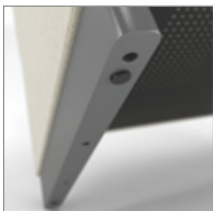

## SECURED GLIDES

The glides are epoxied and nailed in place to hinder their removal. They can be field-replaced with the use of tools.



## WALL SAVER

The position of the back in relation to the base of this product is designed so the back won't impact when the chairs are pushed against the wall - avoiding potential damage to both the chairs and walls.



## RESTRICTED ACCESS UPHOLSTERY

This feature provides complete closure and elimination of the normal gap between upholstered seat, back and arm panels in the seat area of the product - hindering the use of these areas for hiding weapons and contraband. This option further reduces the ability to utilize the product for ligature.

## FINISH DURABILITY

The Krug 's proprietary catalyzed varnish formulation, has been repeatedly shown, through independent laboratory testing, to be the industry leader in durability and abrasion resistance. The Krug finish looks better longer than competitors, and is uniquely suited to the demands of healthcare environments.

## LATEX FREE

Krug products are made with latex-free materials to prevent the allergic reaction that latex causes in some people.

## WEIGHT CAPACITIES

Zola Behavioral Health weight capacities are as follows:

- One Seat - 300lbs
- Two Seat - 525
- Three Seat - 750
- One Seat Plus - 750
- Two Seat Plus - 975
- Three Seat Plus - 1150

## ADDITIONAL FEATURES

- Lifetime warranty
- Certified to meet CAL 117 with most fabrics

## ZOLA BEHAVIORAL HEALTH | OPTIONS

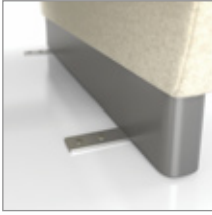

### FLOOR ANCHORING

This can be provided when the product is ordered, or can be added in the field. In both cases, the fastening hardware attaching the steel floor anchoring brackets to the product is tamper-resistant.

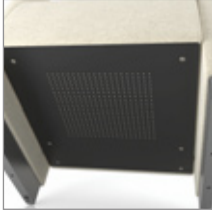

### STEEL BOTTOM SHIELD

This hinders access to the interior frame and components. The powdercoated heavy-gauge steel has venting to allow circulation (venting holes are small enough to hinder use for concealment or ligature), and is fastened with tamper-resistant hardware. The Bottom Shield also adds weight to the product.

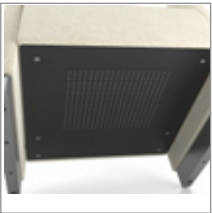

### WEIGHTING

The option of additional weighting can be specified, to specific weight requirements. Additional weighting is achieved through steel plating that is fastened to the interior side of the Steel Bottom Shield, making it secure and inaccessible. This option increases total shipping weight to 87lbs.



### PLUS UPGRADE

The offering includes a standard plus-size 1-seater model, as well as the option to specify plus weight rating for all other models in the offering - this provides a weight rating that exceeds 750 lbs, and includes additional seat support and an additional back leg on the 2- and 3-seat models only.



### REMOVABLE/REPLACEABLE UPHOLSTERY

Removable upholstery covers can be specified on this product, to facilitate cleaning and assist with infection control. They utilize tamper-resistant hardware, and inaccessible staples. Replacement upholstery covers have the same features, and can be field installed with tamper-resistant fastener tools.



### TABLES

A range of occasional tables designed specifically for behavioral health environments is included in this product offering, with a similar range of features and options to provide safety and security to patients and care-givers.

### CAL133 & MOISTURE BARRIER

California Technical Bulletin 133 is a flammability test for seating. Krug offers a compliance method, in combination with non-flammable upholstery covers, may enable products to meet certification requirements for this test. This process at the same time also provides the products with a Moisture Barrier - a treatment that helps to prevent the passage of liquids and moisture to inside of the upholstered components - thereby conferring sanitary and anti-infection benefits. So when CAL 133 is specified, the product also automatically has a Moisture Barrier, and when a Moisture Barrier is specified, the product also features the compliance method and low flammability features of CAL 133.

The application of this up-charge and the compliance method does not mean that the specific configuration of product and upholstery cover are tested and officially certified as being CAL133 compliant. If the official certification is required, Krug will provide this (through an independent certified testing laboratory) at a charge of \$917 per item, plus the cost of the product to be tested. Lead time for certification testing is typically 4-8 weeks. Krug assumes no responsibility for the testing of our products in combination with upholstery covers, or for the results of any testing conducted. Some specific configurations of products and upholstery have already been tested. Please contact Customer Service for additional information.

# ZOLA BEHAVIORAL HEALTH | LOUNGE

## DIMENSIONS

	Overall Width	Overall Depth	Overall Height	Seat Height	Height of Arms From Floor	Width Between Arms	Seat Depth	Shipping Weight	Cubes
One-Seat	29.25	27	34	18.5	26.75	23	19.25	67	21.5
Two-seat	52.25	27	34	18.5	26.75	46	19.25	90	38
Three-seat	75.25	27	34	18.5	26.75	69	19.25	116	54.5
One-Seat (Plus)	36.25	27	34	18.5	26.75	30	19.25	72	22.6

## COM YARDAGES (Lounge Product Only Available with Arms)

	COM Entire Unit	COM 2 Entire Units	COM 3 Entire Units	COM 4 Entire Units
One-Seat	4.5	8.25	13	16.5
Two-seat	6	12	17.5	23.7
Three-seat	7.6	14.25	20.5	30
One-Seat (Plus)	5	10	15	20

## COM YARDAGES (Individual Components)

	COM Yardage Per Seat	COM Yardage Per 2 Seats	COM Yardage Per 3 Seats	COM Yardage Per 4 Seats	COM Yardage Per Back	COM Yardage Per 2 Backs	COM Yardage Per 3 Backs
One-Seat	1.25	2.1	3.35	4.2	1.75	2.75	3.5
Two-seat	1.75	3.4	5.1	6.5	2.5	4.54	6.08
Three-seat	2.5	4.6	7	9	3.5	6.25	9
One-Seat (Plus)	1.25	2.5	3.75	5	1.75	3.5	5.25

## COM YARDAGES (Individual Components cont'd)

	COM Yardage Per 4 Backs	COM Yardage Per Arm	COM Yardage Per 2 Arms	COM Yardage Per 3 Arms	COM Yardage Per 4 Arms
One-Seat	5.25	1.75	2.4	3.3	4.2
Two-seat	8.5	1.75	2.4	3.3	4.2
Three-seat	12.5	1.75	2.4	3.3	4.2
One-Seat (Plus)	7	1.75	2.4	3.3	4.2

## Upcharge for Removable Upholstery Covers:

Option Upcharge	\$ List	Option Upcharge	\$ List
Arms (Right or Left)	77	One-Seat seat	47
One-Seat back	68	Two-seat seat	68
Two-seat back	97	Three-seat seat	85
Three-seat back	121	One-Seat plus seat	61
One-Seat plus back	77		

## Zola Behavioral Health Option Upcharges \$ List

CAL 133 & Moisture Barrier (per yard)	64
Floor Anchoring Hardware	94
One-Seat Metal Bottom Shield (to min 80lbs)	115
One-Seat Plus Metal Bottom Shield (to min 80lbs)	134
Two-seat Metal Bottom Shield (to min 80lbs)	170
Three-seat Metal Bottom Shield (to min 80lbs)	242
Urethane Arm Caps (pair)	242

HEALTHCARE DISCOUNT APPLIES TO THESE PRODUCTS

# ZOLA BEHAVIORAL HEALTH | LOUNGE

HEALTHCARE DISCOUNT APPLIES TO THESE PRODUCTS

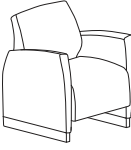
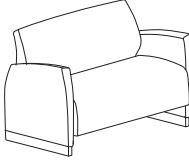
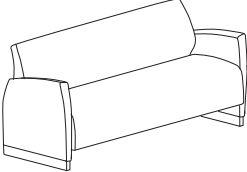
DESCRIPTION	MODEL	COM		COL			FABRIC GRADES			LEATHER	
		1	2	3	4	5	6	7	8	9	
	One-Seat ZOL3 BHF1221	2661	2814	2967	3219	3478	3730	3991	4098	4630	
	Two-Seat ZOL3 BHF2221	3802	3984	4160	4425	4702	4970	5246	5532	5950	
	Three-Seat ZOL3 BHF3221	5049	5302	5556	6048	6541	7032	7527	8036	8863	

**Upcharge for Removable Upholstery Covers:**

Option Upcharge	\$ List	Option Upcharge	\$ List
Arms (Right or Left)	77	One-Seat seat	47
One-Seat back	68	Two-seat seat	68
Two-seat back	97	Three-seat seat	85
Three-seat back	121	One-Seat plus seat	61
One-Seat plus back	77		

**Zola Behavioral Health Option Upcharges \$ List**

CAL 133 & Moisture Barrier (per yard)	64
Floor Anchoring Hardware	94
One-Seat Metal Bottom Shield (to min 80lbs)	115
One-Seat Plus Metal Bottom Shield (to min 80lbs)	134
Two-seat Metal Bottom Shield (to min 80lbs)	170
Three-seat Metal Bottom Shield (to min 80lbs)	242
Urethane Arm Caps (pair)	242
Combination Upholstery - dual fabrics	33
Combination Upholstery -Three fabrics	64

**PRODUCT CODE KEY**

Line	Series	Chair Type	Seat Count	Back Type	Arm Type	Leg Type
ZOL Zola	3-BH Soft Seating	F Freestanding	1 One Seat	2 Upholstered Back - no gap	2 Upholstered Arms - no gap	1 3" Runner
		FB Freestanding Plus	2 Two Seat			
			3 Three Seat			

# ZOLA BEHAVIORAL HEALTH | PLUS LOUNGE

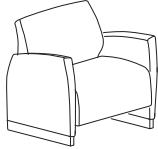
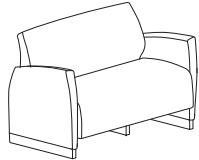
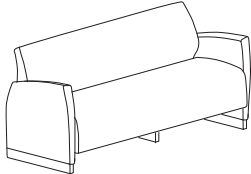
DESCRIPTION	MODEL	COM		COL			FABRIC GRADES			LEATHER	
		1	2	3	4	5	6	7	8	9	
	One-Seat Plus ZOL3 BHFB1221	2951	3100	3255	3508	3764	4020	4277	4551	4917	
	Two-Seat Plus ZOL3 BHFB2221	3886	4074	4246	4515	4790	5056	5332	5622	6036	
	Three-Seat Plus ZOL3 BHFB3221	5150	5406	5657	6151	6644	7133	7631	8140	8964	

**ORDERING NOTE:** The Two-Seat Plus comes standard with center support.

Zola Behavioral Health Option Upcharges	\$ List
CAL 133 & Moisture Barrier (per yard)	64
Floor Anchoring Hardware	94
One-Seat Metal Bottom Shield (to min 80lbs)	115
One-Seat Plus Metal Bottom Shield (to min 80lbs)	134
Two-seat Metal Bottom Shield (to min 80lbs)	170
Three-seat Metal Bottom Shield (to min 80lbs)	242
Urethane Arm Caps (pair)	242
Combination Upholstery - dual fabrics	33
Combination Upholstery -Three fabrics	64

## ZOLA BEHAVIORAL HEALTH | REPLACEMENT COMPONENTS

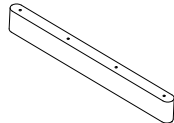
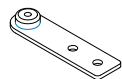
Description	Model	Price	Weight	Cube
	Replacement Arm Panel Base ZOL3RBCS	169	6	.5
	Replacement Floor Mounting Bracket (set of 4) ZOL3RFMB	113	2	.5



### PRODUCT CODE KEY

Line	Series	Chair Type	Seat Count	Back Type	Arm Type	Leg Type
ZOL Zola	3-BH Soft Seating	F Freestanding	1 One Seat	2 Upholstered Back - no gap	2 Upholstered Arms - no gap	1 3" Runner
		FB Freestanding Plus	2 Two Seat			
			3 Three Seat			

HEALTHCARE DISCOUNT APPLIES TO THESE PRODUCTS

# ZOLA BEHAVIORAL HEALTH | FREESTANDING TABLES

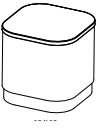
HEALTHCARE DISCOUNT APPLIES TO THESE PRODUCTS

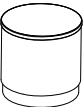
Description	Model	Maple	Beech	Laminate side Laminate top PVC edge	Wood side Laminate top w/ PVC edge Maple	Wood side Laminate top w/ PVC edge Beech	Wood side Laminate top w/ Wood edge Maple	Wood side Laminate top w/ Wood edge Beech
		Palette						
	Square Tables							
	ZOL4-BH181818	1390	1351	1109	1318	1356	1374	1411
	ZOL4-BH242418	1779	1756	1403	1673	1728	1743	1795
	Rectangular Tables							
	ZOL4-BH241818	1604	1573	1254	1512	1558	1569	1618
	ZOL4-BH482418	2696	2642	2155	2515	2593	2611	2692
	Round Tables							
	ZOL4-BH18D18	1199	1245	1276	1109	1228	1237	1355
	ZOL4-BH24D18	1465	1522	1612	1377	1506	1458	1588
ZOL4-BH30D18	2838	2719	2996	2745	2705	2851	2808	

## Zola Behavioral Health Option Upcharges \$ List

Floor Anchoring Hardware	91
ZOL4-BH181818 - Weighting to min 80lbs	348
ZOL4-BH242418 - Weighting to min 80lbs	239
ZOL4-BH241818 - Weighting to min 80lbs	129
ZOL4-BH482418 - standard exceeds 80lbs	n/a
ZOL4-BH18D18 - Weighting to min 80lbs	388
ZOL4-BH24D18 - Weighting to min 80lbs	239
ZOL4-BH30D18 - standard exceeds 80lbs	n/a

**ORDERING NOTE:** Additional weight levels are available, contact customer service for quotes.

## TABLE DIMENSIONS

Model	W	D	H	Weight	Weight with Solid Surface top	Cube	
Square Tables	ZOL4-BH181818	18	18	18	39	48	4.0
	ZOL4-BH242418	24	18	18	64	80	5.2
Rectangular Tables	ZOL4-BH241818	24	24	18	51	63	6.9
	ZOL4-BH482418	48	24	18	123	156	13.5
Round Tables	ZOL4-BH18D18	18	-	18	30	38	4.0
	ZOL4-BH24D18	24	-	18	49	62	6.9
	ZOL4-BH30D18	30	-	18	77	98	10.6

# ZOLA TABLES | ENVIRONMENTAL SUMMARY

## LEED CI CREDITS



MATERIAL CONTENT:

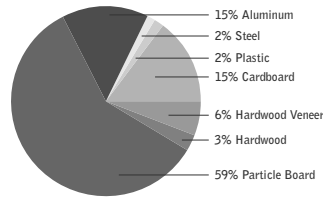

PRE-CONSUMER  
RECYCLED CONTENT = 58.82%

POST-CONSUMER  
RECYCLED CONTENT = 17.25%

Up to 29.41% of this Zola product is recyclable at the end of its useful life.

### CONTRIBUTES TO

CREDIT 2.1 - 2.2	Construction Waste Management	1-2 point(s)
CREDIT 3.3	Resource Reuse	1 point
CREDIT 4.1	Recycled Content	1 point
CREDIT 4.2	Recycled Content	1 point
CREDIT 4.5	Low Emitting Materials, Systems & Seating	1 point
CREDIT 5.1	Regional Materials*	1 point
CREDIT 7	Certified Wood (MUST BE REQUESTED)	1 point(s)

\*This credit is only applicable if in total 20% of the combined value of the procurement of construction materials and in the furniture are manufactured within a radius of 500 miles. This credit will apply if the installation of the finished product occurs within 500 miles of Kitchener, Ontario.

## level® CERTIFICATION, AIR EMISSIONS AND FSC® CERTIFICATION



### level® CERTIFICATION

BIFMA's e3 Furniture Sustainability Standard is a voluntary, multi-attribute standard that measures the degree of sustainability of furniture. This standard evaluates product and company environmental attributes and compliance systems in a wide range of elements which include Materials, Energy & Atmosphere, Human & Ecosystem Health and Social Responsibility. Zola products have earned level®, BIFMA's sustainability certification program for furniture, certification through third-party verification against the e3 standard.



FSC  
www.fsc.org  
FSC® C021099

The mark of responsible forestry

### AIR EMISSIONS

All Zola products are supplied air emissions-certified. Contact customer service for information.

### FSC®

In 2005, Krug received Forest Stewardship Council® (FSC®) Chain-of-Custody certification for our manufacturing facilities. The FSC® Chain-of-Custody tracks certified wood from seedling to final sale. It verifies that the material for our FSC® certified products only come from well-managed, FSC®-certified forests and other controlled sources. FSC® is dedicated to the promotion of responsible forest management worldwide helping to take care of forests for future generations. Jordan and other Krug products can be specified with FSC® Certification. Contact customer service for further information, pricing and lead times.



Architects, designers, and building professionals can specify FSC®-certified products in order to achieve a point from the U.S. Green Building Council's Leadership in Energy and Environmental Design (LEED) Rating System.

# ZOLA | TABLES FEATURES

## TABLES MATERIALS OPTION

Tables are available in veneer, plastic laminate, and Palette finishes - and an optional solid surface top. Tables feature leveling glides on every leg.

## SOLID SURFACE TOPS

The Solid Surface Top option features Solid Surface material:

composed of minerals, acrylic resins and colors, it is a non-porous, scratch and dent-resistant material that does not stain, and does not allow microbes and bacteria to penetrate the surface. Color is throughout the material, so surface scratches are not as visible.

## POWER OPTION

The flush-mounted Power unit provides dual power/USB outlets for multiple devices. It can be located on the front face of Middle or End Tables (not available on curvilinear models) To specify, clearly mark on the order and add **\$561 list.**

## UNDER-MOUNT POWER OPTION

The Under-mount Power unit provides dual power/USB outlets for multiple devices. It can be located below tables. See [page 83](#) for pricing.

# ZOLA | MODULAR LINKING TABLES

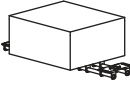
DESCRIPTION	MODEL	BEECH	MAPLE	LAMINATE TOP	LAMINATE TOP W/	W	D	H	WEIGHT	CUBE
		PALETTE LAMINATE	CHERRY	W/BEECH SIDES	MAPLE/CHERRY SIDES					
	Middle Linking Modular Table									
	ZOL4 LKM12	988	1036	1088	1140	12	16	-	22	2.8
	ZOL4 LKM18	1044	1098	1147	1209	18	16	-	24	4.5
	ZOL4 LKM24	1074	1155	1181	1270	24	16	-	29	5.7

**ORDERING NOTE:** Middle Linking Modular Table ships with 2 KB1 brackets.

	Rectangular End Table Square Corner									
	ZOL4 LKE12	1053	1108	1158	1218	12	16	14.75	19	2.8
	ZOL4 LKE18	1098	1155	1209	1270	18	16	14.75	23	4.5
	ZOL4 LKE24	1146	1202	1263	1323	24	16	14.75	28	5.7

**ORDERING NOTE:** End Linking Modular Table ships with 1 KB1 bracket.

	End Table Rounded Corner									
	ZOL4 ECLKH12	1199	1246	1232	1284	12	12	14.75	18	2.5
	ZOL4 ECLKH18	1295	1347	1342	1395	18	12	14.75	24	3

**ORDERING NOTE:** End Linking Modular Table ships with 1 KB1 bracket.

	Curvilinear 30° Table									
	ZOL4 LKC30	1019	1074	1122	1181	16	16.5	-	15	2.3

	Curvilinear 45° Table									
	ZOL4 LKC45	1098	1155	1209	1270	16	17	-	17	2.9



**ORDERING NOTES:** Middle Linking Tables are automatically supplied with two ZOL3 RLKB1 (table to seat bracket) brackets for fastening to benches. End tables are automatically supplied with one ZOL3 RLKB1 (table to seat bracket) bracket for fastening to benches. When fastening two linking tables (ZOL4 LKC90X2) together, mounting hardware will be provided when ordered, that will include one leg per table (to a maximum of two legs), which will be mounted on the adjoining seam. Please note in model ZOL4 LKH12, the "12" corresponds to the length of the table.

Zola Solid Surface Upcharges	Grades			
	A-White	A-Color	B	C
ZOL4-LKM12	218	229	260	295
ZOL4-LKM18	269	286	332	383
ZOL4-LKM24	381	406	522	621
ZOL4-LKE12	218	229	260	295
ZOL4-LKE18	269	286	332	383
ZOL4-LKE24	381	406	522	621
ZOL4-ECLKH12	218	229	260	295
ZOL4-ECLKH18	269	286	332	383
ZOL4-LKC30	246	260	299	340
ZOL4-LKC45	308	328	384	446

The Solid Surface top option is priced as an upcharge to existing table price. Please add a "S" to the end of the model number and then add the upcharge listed under Solid Surface ie: ZOL4 18D15S. Zola Solid Surface tables have a 1/2" thickness on top of the existing table, with a 1 mm overhang (soft radius vertical edge).

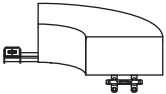
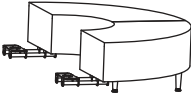

# ZOLA | MODULAR LINKING TABLES

DESCRIPTION	MODEL	BEECH PALETTE LAMINATE	MAPLE CHERRY	LAMINATE TOP W/BEECH SIDES	LAMINATE TOP W/ MAPLE/CHERRY SIDES	W	D	H	WEIGHT	CUBE
	Curvilinear 60° Table ZOL4 LKC60	1146	1209	1263	1332	16	17.5	-	20	3.7
	Curvilinear 90° Table ZOL4 LKC90	1283	1354	1411	1487	16	19	-	24	5.4
	Curvilinear 90°x2 Table ZOL4 LKC90X2	2548	2625	2802	2886	16	19	-	55	10
	Curvilinear Table ZOL4 LKH12	1116	1170	1228	1288	16	19	14.75	18	2.3

**ORDERING NOTES:** Middle Linking Tables are automatically supplied with two ZOL3 RLKB1 (table to seat bracket) brackets for fastening to benches. End tables are automatically supplied with one ZOL3 RLKB1 (table to seat bracket) bracket for fastening to benches. When fastening two linking tables (ZOL4 LKC90X2) together, mounting hardware will be provided when ordered, that will include one leg per table (to a maximum of two legs), which will be mounted on the adjoining seam. Zola Middle tables have the ability to be easily reconfigured, as they are universal and non-handed. They can be moved to a reverse position in almost any configuration to provide a high level of flexibility when specifying.

Zola Solid Surface Upcharges	Grades			
	A-White	A-Color	B	C
ZOL4-LKC60	379	402	473	559
ZOL4-LKC90	562	596	719	857
ZOL4-LKC90X2	894	933	1141	1378
ZOL4-LKH12	218	229	260	295

The Solid Surface top option is priced as an upcharge to existing table price. Please add a "S" to the end of the model number and then add the upcharge listed under Solid Surface ie: ZOL4 18D15S. Zola Solid Surface tables have a 1/2" thickness on top of the existing table, with a 1 mm overhang (soft radius vertical edge).

## CURVILINEAR TABLE DIMENSIONS

ZOL4 LKC30

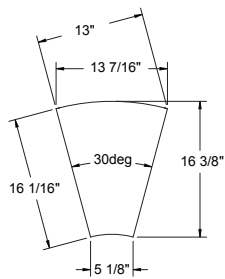

ZOL4 LKC60

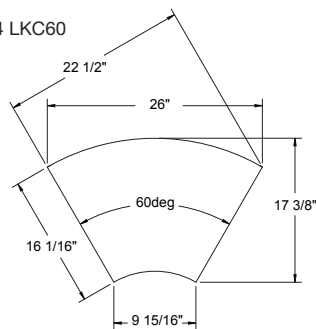

ZOL4 LKC45

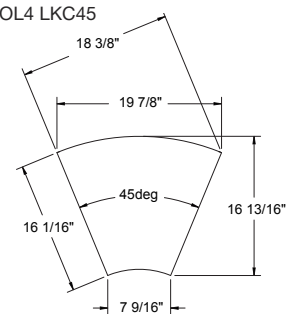

ZOL4 LKC90

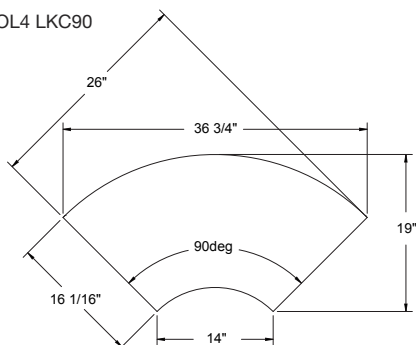

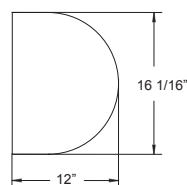

ZOL4 LKH12

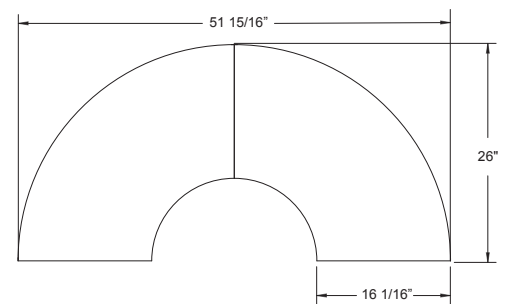

ZOL4 LKC90X2

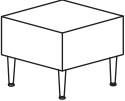
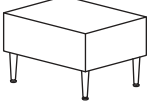
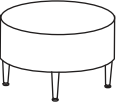

# ZOLA | FREESTANDING TABLES

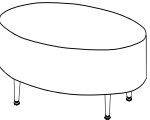
DESCRIPTION	MODEL	BEECH PALETTE LAMINATE	MAPLE CHERRY	LAMINATE TOP W/BEECH SIDES	LAMINATE TOP W/ MAPLE/CHERRY SIDES	W	D	H	WEIGHT	CUBE
	Square Tables									
	ZOL4 181815	1098	1155	1209	1270	18	18	14.75	24	3
	ZOL4 242415	1187	1251	1305	1374	24	24	14.75	34	5
	Rectangular Tables									
	ZOL4 241815	1139	1203	1253	1327	24	18	14.75	28	4
	ZOL4 482415	1359	1443	1495	1587	48	24	14.75	56	10
	Round Tables									
	ZOL4 18D15	1170	1244	1288	1367	18	-	14.75	16	3
	ZOL4 24D15	1251	1318	1374	1452	24	-	14.75	23	5
	ZOL4 30D15	1391	1474	1530	1619	30	-	14.75	34	8
	Square Table - Round Corners									
	ZOL4 EC181815	1275	1328	1320	1376	18	18	14.75	21	3
	ZOL4 EC241815	1434	1492	1493	1555	24	18	14.75	25	4
	ZOL4 EC242415	1578	1639	1686	1752	24	24	14.75	30	5
	ZOL4 EC482415	2264	2354	2408	2504	48	24	14.75	51	10
	Ellipse Table									
	ZOL4 E241815	1327	1378	1499	1559	24	18	14.75	22	4
	ZOL4 E322415	1610	1673	1788	1858	32	24	14.75	32	7
	ZOL4 E482915	2016	2096	2254	2345	48	29	14.75	53	12

Zola Solid Surface Upcharges	Grades			
	A-White	A-Color	B	C
ZOL4 1818	287	301	352	409
ZOL4 2424	460	469	560	662
ZOL4 2418	343	364	433	510
ZOL4 4824	771	791	970	1170
ZOL4 18D	274	290	339	396
ZOL4 24D	410	443	533	633
ZOL4 30D	658	716	942	1136
ZOL4 EC1818	287	301	352	409
ZOL4 EC2418	343	364	433	510
ZOL4 EC2424	460	469	560	662
ZOL4 EC4824	771	791	970	1170
ZOL4 E2418	343	364	433	510
ZOL4 E3224	543	581	699	834
ZOL4 E4829	908	949	1164	1405

The Solid Surface top option is priced as an upcharge to existing table price. Please add a "S" to the end of the model number and then add the upcharge listed under Solid Surface ie: ZOL4 18D15S. Zola Solid Surface tables have a 1/2" thickness on top of the existing table, with a 1 mm overhang (soft radius vertical edge).

# ZOLA | FREESTANDING TABLES

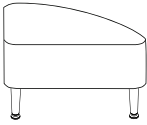
DESCRIPTION	MODEL	BEECH PALETTE LAMINATE	MAPLE CHERRY	LAMINATE TOP W/BEECH SIDES	LAMINATE TOP W/ MAPLE/CHERRY SIDES	W	D	H	WEIGHT	CUBE	
	Triangular Tables - Rounded Corners										
	ZOL4 CR45D1815	1192	1240	1207	1257	15.75	18	14.75	17	2.5	
	ZOL4 CR45D2415	1354	1408	1404	1459	20.5	24	14.75	22	4.5	
	ZOL4 CR45D2915	1639	1705	1734	1803	25	29	14.75	27	7	
	ZOL4 CR90D1815	1465	1526	1529	1585	17.5	18	14.75	23	3	
	ZOL4 CR90D2415	1730	1801	1813	1885	36.25	24	14.75	29	7.5	
	ZOL4 CR90D2915	2066	2148	2109	2194	44.5	29	14.75	35	11	

Zola Solid Surface Upcharges	Grades			
	A-White	A-Color	B	C
ZOL4 CR45D18	270	286	333	386
ZOL4 CR45D24	403	432	512	602
ZOL4 CR45D29	542	573	687	815
ZOL4 CR90D18	339	371	441	518
ZOL4 CR90D24	576	613	740	885
ZOL4 CR90D29	815	846	1033	1242

The Solid Surface top option is priced as an upcharge to existing table price. Please add a "S" to the end of the model number and then add the upcharge listed under Solid Surface ie: ZOL4 18D15S. Zola Solid Surface tables have a 1/2" thickness on top of the existing table, with a 1 mm overhang (soft radius vertical edge).

## TRIANGULAR TABLE DIMENSIONS

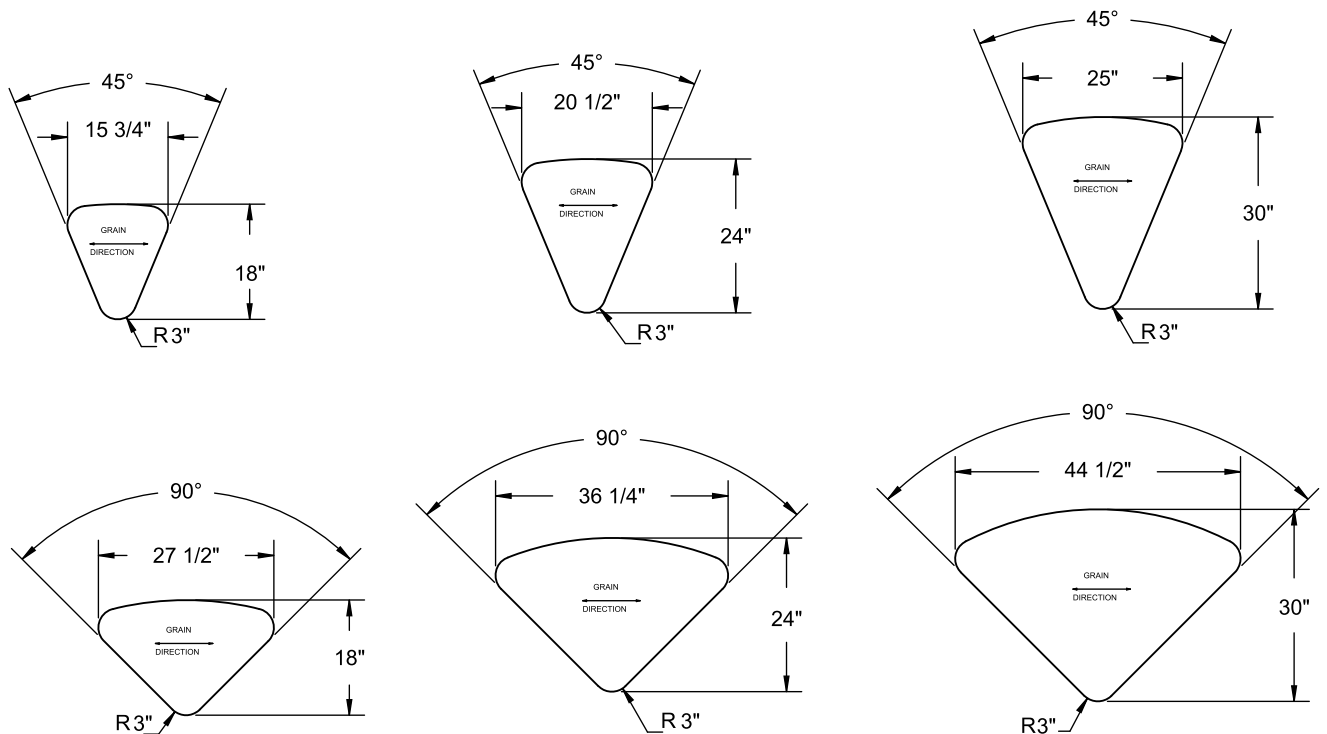

# GENERAL INFORMATION

## Terms and Conditions

Net 30 days on approved credit. A late payment charge of 1% per month will be applied on overdue invoices. This charge will be pro-rated to the number of days past 30 days that the invoice is overdue. All applicable sales taxes are extra. Distribution of this price list does not in itself constitute an offer to sell. Orders can be received only from authorized Krug dealers. Acceptance of any order and terms of sale may be established at the discretion of Krug. Deposits are required on orders received from new accounts as well as on large or special orders. Krug reserves the right to discontinue designs, or to change designs, construction, prices, or materials without notice.

## Contact Information

Phone: 1.888.578.KRUG (5784) | Fax: 1.519.748.5177

Purchase Order Fax: 1.888.236.4783

Purchase Order E-mail: orders@krug.ca

Web: www.krug.ca E-mail: solutions@krug.ca

## Customer Service Hours

Please note customer service hours are:

8:30 am to 5:00 pm est

## Customer Satisfaction

It is the primary goal of Krug and our staff to ensure the complete satisfaction of our customers with our products and performance. If a problem arises with a Krug product after the expiration of the limited warranty period, Krug will exercise its best efforts to achieve the satisfaction of the customer in a manner that is fair to all concerned.

## Order Acknowledgments

Each order will be acknowledged via e-mail or fax. This acknowledgment is the final agreement between Krug and the customer, superseding all previous communications regarding the purchase order. Where there is a discrepancy on a purchase order between a product code and a description, Krug will make every effort to resolve the discrepancy, but will be ruled by the product code ordered. Please check all acknowledgments for accuracy, and advise Krug of any discrepancies with a purchase order.

## Order Cancellation

Krug reserves the right to not accept or allow cancellation of orders. All products are manufactured on a custom-made, make-to-order basis, and the purchasing, engineering and production of orders begins shortly after order placement - and the customer purchase order is a contract that authorizes Krug to manufacture the products. Acceptance of order cancellation (or partial cancellation) is solely at the discretion of Krug, and is dependent on the extent to which engineering, purchasing and manufacturing has been initiated by the time cancellation is requested. No order cancellations (partial or otherwise) are allowable more than 4 weeks from date of order placement (as order production is unable to be terminated by that point), and full payment of the acknowledged order value is required for any orders cancelled after 4 weeks. Cancellations may be allowable in less than 4 weeks after order placement, depending on the extent to which manufacturing has been initiated. An acceptance of order cancellation requires that the purchaser agrees to make payment for all costs incurred to the point of acceptance of cancellation. Cancellation charges include all costs for purchase of dedicated material and components, engineering costs for non-standard products, and all costs for manufacturing completed to that point, as well as a \$367 net charge for processing of the original order and for processing of cancellation invoicing.

## Pricing

Krug endeavors to ensure that all prices in this price list reflect accurately our current prices. However, errors do occur and will be rectified through notices to the field. Krug reserves the right to acknowledge pricing that may be different from the price list.

## Storage Charges

Krug reserves the right to assess a nominal storage charge if a customer does not accept shipment of an order within a week of the ship date.

## Warranty

Krug warrants the construction and the finish of all our products to be free from defects in materials and workmanship for a period of 10 years from the date of purchase. This warranty is applicable to products in use by their original purchaser. This warranty does not apply to components not manufactured by Krug including textiles, which are subject to the specific warranties of those manufacturers, if any. Textiles (fabric, leather, vinyl, or any other covering material) suppliers do not guarantee their products for durability and color fastness, and nor does Krug. Casters, mechanical and electrical components have a warranty of five years from the date of purchase. The Krug warranty does not apply to COM-specified materials, damage caused by a carrier other than Krug, or variation in wood finishes due to natural wood color variation. Krug cannot be held responsible for variations in fabric dye lots from order to order. All fabric is carefully inspected when it is received, but a degree of variation in color should be expected. Repairs or replacement of any defect covered under this warranty by Krug will be made, at our option and method, at no charge to the original purchaser during the warranty period. Krug's judgement is final and binding with respect to the nature or cause of defects or damage, and the necessity or manner of repair or replacement.

This warranty does not apply to defects or damage resulting from:

- normal wear and tear occurring with the use of the product
- negligence, misuse, excessive use, alteration, improper cleaning or repair
- substitution or use of incorrect or unauthorized components or material
- handling or installation that is incorrect, or that causes damage or defect
- damage incurred by a freight carrier other than Krug
- wearing of finishes and fabrics, and normal variations in materials (including dye lot variations)
- properties of natural materials, including wood and leather
- exposure to environments with uncontrolled temperature and humidity (products must be transported, stored and used in climate-controlled conditions)

## Blanket Wrapping

Krug will blanket wrap larger seating orders at customer's request. Please indicate on your purchase order and contact Customer Service.

## Export Packaging

Krug is pleased to provide the option for export packaging on all our products, to provide additional protection from damage. For shipments overseas, a quote for export packaging can be provided, based on the products to be ordered and the delivery destination - please contact Customer Service or Bids & Specification Support for more information and a quotation. KRUG is not responsible for shipment damage occurring on overseas shipments

Export Packaging is STRONGLY RECOMMENDED for:

- (A) all shipments outside of the lower 48 states and Canada.
- (B) all shipments that will be held in storage for an extended period prior to installation.

**Important:** Please note that Krug will not be responsible for damage claims on product shipped or stored in the above conditions but where export packaging has not been utilized.

## Dimensions

Dimensions are in inches and approximate, and subject to change without notice. Contact Customer Service if dimensions are critical.

## Installation Support

For assistance please contact Technical Support at 1-888-578-5784 x216 or e-mail installationhelp@krug.ca and you will be directed to the appropriate installation support person.

# GENERAL INFORMATION

## Freight Terms and Conditions

1. All product is shipped FOB the Krug factory. Freight is either pre-paid to the destination or not pre-paid, depending on established customer specific freight terms.
2. Docks at the selected delivery location must be equipped to handle a 53' trailer. If a dock is inadequate for delivery by Krug, Krug will re-deliver to another local location and any additional costs will be charged to the customer.
3. For all deliveries, it is understood that Krug or its agent is making a dock delivery only (equipped to handle a 53' trailer), and any further work of truck unloading, delivery beyond the dock, installation, and removal of packaging is not authorized or paid for by Krug.
4. Drop shipments to the installation site, and timed deliveries, are available on larger shipments (full truckloads or slightly less) at no additional charge. Drop shipments or timed deliveries for smaller shipments may not be available, or if available will require a surcharge. Deliveries on an after hours basis, or on weekends, or any other special requirements, may be subject to a surcharge. Location and contact information, and the requested time of delivery, is required at least one week prior to the acknowledged shipment date. If this information is not provided one week in advance, or if the location or time of the drop shipment is changed less than one week in advance, a surcharge may be applied, and/or the drop shipment may not be scheduled. For deliveries requested Monday to Thursday after 5:00 pm, please apply a surcharge of \$262/shipment. For deliveries requested Monday to Friday before 7:00 am, please apply a surcharge of \$262/shipment. For deliveries requested Friday (after 3:00 pm) or weekends, please apply a surcharge of \$525/shipment (local times).
5. For all deliveries - whether to the Customer location or drop shipment - any circumstances that result in the delay of our carrier (including unsuitable receiving facilities, or facilities not open or available), service charges will be applied at the rate of \$125/hour. Where re-delivery is necessary because of these circumstances, the full cost of re-delivery will be charged. If Less Than Truck Load is delivering, one hour is allocated to unload. Any additional time required to unload after the first hour is \$125/hour. If a Truck Load is delivering the order, three hours is allocated to unload. Any additional time required to unload is \$125/hour. Direct deliveries to site for large orders are possible, (must exceed \$60,000 net), and accommodate 48 - 53' trailers. Krug is responsible for delivery to the approved delivery address. If an address change is required, this must be authorized by Krug 5 business days prior to ship date. Any additional delivery costs incurred after this time will be charged to the customer.

## Product Strength and Durability Testing

All management seating meets or exceeds the testing requirements of ANSI/BIFMA X5.1-2011. All lounge seating meets or exceeds the testing requirements of FNAE-80-214A. Specific test results and documentation are available on request.



## Damaged Shipments

All Krug product is well engineered, carefully inspected, and expertly loaded onto our trucks at our Distribution Center. If you receive any damaged freight, we ask that you do not refuse the shipment. Krug is not responsible for damage to goods that occurs in transit or storage. It is the purchaser and/or receiver's responsibility to examine the goods upon receipt and to notify Krug of any damages, overages or shortages. Any discrepancies should be noted on the Bill of Lading. The delivering carrier will not accept responsibility for shortages or damages if signed "clear". Notification of concealed damage claims must be made to Krug Distribution within 5 days of delivery, along with digital pictures if available. All product and packaging must be available for inspection. Krug liability ceases after 5 business days and Krug will not be responsible for concealed damages if shipments are left unopened. Krug is not responsible for the condition of product that is stored or installed in an environment where temperature and humidity are not controlled.

## Field Product Report Authorization

Krug's written authorization, in the form of an FPR number, must be obtained prior to incurring charges of any kind if Krug is expected to pay these charges. This includes authorization for field repairs and replacements, installation and delivery charges. Krug reserves the right to have its representative inspect product related to any request for such authorizations, prior to that authorization being provided. Deductions from invoices paid for any charges to Krug, without prior written authorization in the form of an FPR, will not be accepted. Digital photographs may be required to complete the FPR process.

## Returns

No merchandise may be returned without Krug's prior written consent. In the event of an authorized return, a Field Product Report (FPR) number will be issued, and a restocking charge will apply. Return transportation charges must be prepaid. Unauthorized returns will not be accepted and will be returned freight collect. All merchandise being returned must be properly packaged in its original or comparable replacement packaging to ensure protection of the product during handling and transportation. Returns on orders duplicated by the customer must be received in their original packaging to be accepted. Product being returned where Krug has authorized its liability for replacement or repair will be thoroughly inspected on its return, and the results compared to the reason for the return stated on the FPR. Any discrepancies, such as additional damage, signs of usage, missing parts, etc., will result in an adjustment to the amount of credit issued.

## Custom Capabilities

Over 15% of our orders involve some type of custom work, and we invite our customers to make use of our extensive capabilities.

These include:

- 1) Dimensional customization of standard size products
- 2) Custom finishes
- 3) For larger orders, completely custom-designed products, as well as non-standard wood species can be specified.

Custom orders may require additional production lead times. Contact Engineering at the e-mail address [engquotes@krug.ca](mailto:engquotes@krug.ca).

## Care and Maintenance Leather

Leather is a natural product and requires very little care during use. Most stains can be removed with a clean dry cloth. For stubborn spots and stains, use a mild non-detergent cleaner, rinse well and let air dry naturally. Do not use saddle soap, cleaning solvents, furniture polish, oils, varnish, abrasive cleaners, soaps or ammonia waters.

## Fabric Upholstery

Professional upholstery cleaning is recommended.

## Flammability Standards for Krug Fabric Program

- Passes State of California Technical Bulletin CAL 117-2013

# KRUG TEXTILES - UPHOLSTERY FABRICS



## Krug Textiles - Stocked Fabric Program

### Grade 1

#### ARLO



308 MIDNIGHT



306 PETROL



908 CHARCOAL



93 SEAL



601 PEARL



84 NUTMEG



62 OATMEAL



90 LIMESTONE

#### FRANKLIN



47 CAMEL



3009 MIDNIGHT



67 FAWN



97 CINDER



94 METAL



909 BLACK



9004 CHARCOAL



308 PETROL



108 ORCHID

#### COMRADE

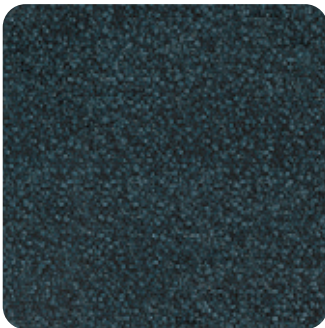

309 MIDNIGHT



84 TEAK



63 LINEN

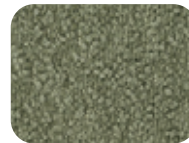

24 ALPINE



905 IRON



601 SNOW



57 MARIGOLD

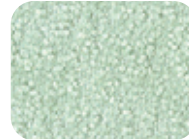

31 DUCK EGG

#### FELICITY



601 IVORY



305 SKY



603 TAUPE



93 COAL



405 HENNA



64 PUTTY



62 FAWN



36 BLUEBERRY

Krug Textiles - Stocked Fabric Program

Grade 2

**GRADY**



25 CAPER



31 SKY



604 FLAX



901 CHAR

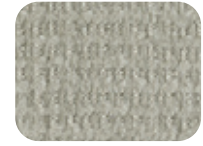

93 GRAY

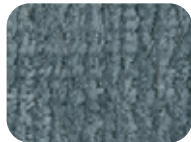

34 SLATE



84 TEAK



98 NICKLE

**YATES**



84 BIRCH



44 CLAY



87 TAUPE

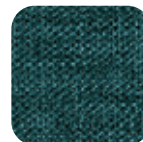

25 JUNIPER

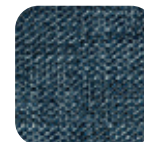

305 INDIGO



109 CRANBERRY



803 TOAST



92 ZINC



91 SILVER



908 CHARCOAL

**MCCOY**



608 TUNDRA



601 CREME



908 CHARCOAL



62 COPPER



108 CORDOVAN



32 ROBIN'S EGG



94 MERCURY



84 BARK

**ORIS**

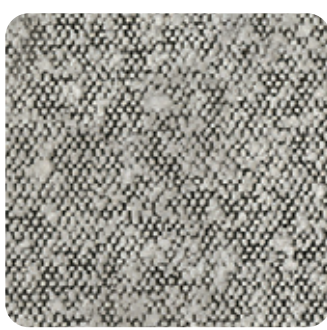

908 DOMINO



604 BARK



601 CREAM

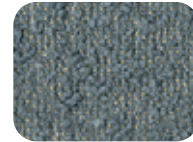

306 DELFT



902 ZINC



305 MIDNIGHT



64 PUTTY

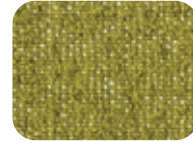

205 CHARTREUSE

# KRUG TEXTILES - UPHOLSTERY FABRICS



## Krug Textiles - Stocked Fabric Program

### Grade 3

#### MORITZ

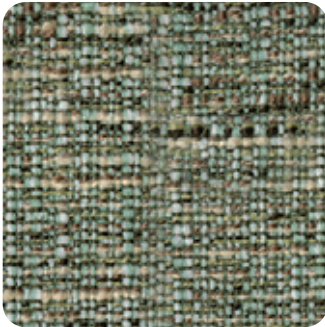

205 SPEARMINT

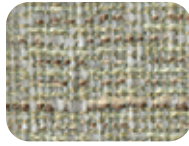

61 OYSTER

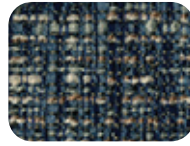

306 CADET

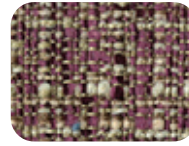

104 MULBERRY



31 AEGEAN

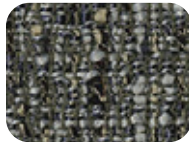

9008 CHARCOAL



82 CLAY



304 CAPRI

#### LORENZO

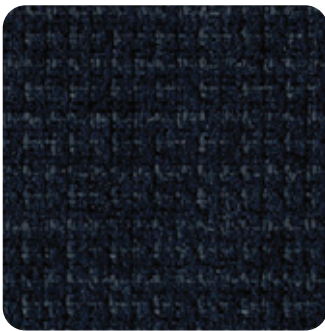

306 INDIGO



24 ALPINE



64 LINEN



91 FLANNEL

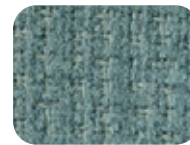

32 MIST



601 CREAM



106 HENNA



604 STUCCO

#### BISCOTTI



302 CAPRI



45 SPICE



61 DESERT



91 GRANITE

#### INTRIGUE



601 OYSTER



27 OLIVE



4003 OCHRE



908 CHARCOAL



3009 MIDNIGHT



805 PECAN



608 STUCCO



605 STRAW



**Krug Textiles - Faux Leather Program - Grade 2**



**Krug Textiles - Leather Program - Grade 8**

Please contact Customer Service for specific information on leathers, available colors and lead times.

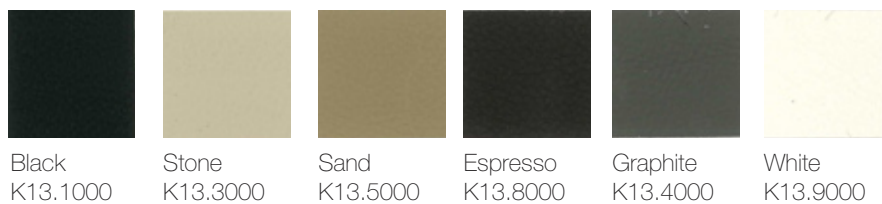

**Krug Textiles - Cut fabric NET price per yard**

Grade 1	\$22
Grade 2	\$34
Grade 3	\$46

**LATEX FREE**

Krug products are made with latex-free materials to prevent the allergic reaction that latex causes in some people.

# CUSTOMER'S OWN MATERIAL - C.O.M.

## Customer's Own Material (COM/COL)

COM/COL must be received three weeks prior to the acknowledged ship date. Orders with COM/COL not received by the required deadline will be delayed. A description of the upholstery cover, including supplier name, pattern name, upholstery cover name and color number must be included with the purchase order.

COM/COL testing requires 3 business days and samples are to be directed to Customer Service. The customer has the option of providing the sample COM/COL before, at time of order, or once the sample COM/COL is received. If the customer does not send a sample for approval in advance of sending actual material, Krug will not be responsible for the cost of any upholstery cover or other material that it determines to be unsuitable for the product or our process.

When the COM/COL upholstery cover is received at Krug, it must be clearly identified with the upholstery cover name and color, and tagged with name of the Krug customer and purchase order number. Krug will inspect all COM/COL upholstery covers when received to determine if it will be suitable for upholstery. Where Krug feels that the upholstery cover or leather specified will compromise the quality or integrity of our products, customers will be contacted to direct these concerns. Further, Krug reserves the right to refuse to accept and use any COM upholstery covers or leathers that will compromise our products in any way that is unacceptable to Krug. Krug cannot assume responsibility for the durability or tailoring quality of customer's own material.

Yardage specified in this price guide is approximate. In the case of multiple product orders, multiply the number of items by the COM yardage specified to determine upholstery cover required, unless otherwise indicated. Additional yardage may be needed if the material is less than 54" wide, or patterned or striped and requires matching. All COMs are cut "up the roll" unless otherwise stated by the customer. All striped upholstery covers will be applied vertically unless otherwise stated by the customer and after approval by Krug. Krug will not be responsible for directional or positional problems with its application of COM material, unless it has been provided with explicit instructions by the customer. Special instructions should be sent to Krug Customer Service, including a sample (or photocopy) of the upholstery cover. Krug is not responsible for instructions sent with the upholstery cover rolls, or for the method of upholstery if no instructions have been provided.

Price increases and freight charges to COM/COL acquired on the customer's behalf will be passed onto the customer.

## Application of Directional Upholstery cover

Some COM upholstery covers will be considered directional by Krug even though they are not considered directional by the supplier. All COMs are automatically cut "up the roll" unless otherwise stated by the customer (please see below).



Standard-Cut  
"up the roll"

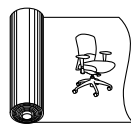

Non-Standard-Cut  
across the roll "railroad"

## COM/COL Shipping Procedures

For seating COM/COL upholstery covers, please send upholstery covers to:

Krug Inc.  
111 Ahrens Street  
Kitchener, Ontario  
Canada N2H 4C2

**Attention: RECEIVER**

COM/COL orders cannot be scheduled into production until the upholstery cover has arrived and inspection is complete.

All packages must be clearly marked

**"For Customs Clearance by Willson International Custom Brokers".**

According to the North American Free Trade Agreement (NAFTA), goods shipped between the United States and Canada can qualify for exemption from all duties, or for a reduction in duties, if the goods can be proven to originate in either the United States, Canada or Mexico.

Canada Customs requires that a [NAFTA Certificate of Origin](#) and a [Commercial Invoice](#) be completed and sent with the upholstery cover shipment. The Commercial Invoice must clearly state the description of the upholstery cover, the selling price, the make-up or content, and the purchaser. The absence of these two documents will delay the shipments at the U.S./Canada border, thereby potentially delaying the customer order. If the total value of the shipment is less than \$1200 U.S., Customs will accept a Low Value Statement of Origin in place of the NAFTA Certificate of Origin. The Low Value Statement must be signed by a representative of the exporting company. This statement may either be included on the commercial invoice or attached to the invoice. Krug is happy to answer any questions or concerns about COM/COL shipping procedures and the required documents.

## CAL 133 & Moisture Barrier

California Technical Bulletin 133 is a flammability test for seating. Krug offers a compliance method which, in combination with non-flammable upholstery covers, may enable the products to meet certification requirements for this test. This process at the same time also provides the products with a Moisture Barrier - a treatment that helps to prevent the passage of liquids and moisture to inside of upholstered components - thereby conferring sanitary and anti-infection benefits. So when CAL 133 is specified, the product also automatically has a Moisture Barrier, and when a Moisture Barrier is specified, the product also features the compliance method and low flammability features of CAL 133.

The application of this upcharge and the compliance method does not mean that the specific configuration of product and upholstery cover are tested and officially certified as being CAL 133 compliant. If official certification is required, Krug will provide this (through an independent certified testing laboratory) at a charge of \$917 per item, plus the cost of the product to be tested. Lead time for certification testing is typically 4-8 weeks. Krug assumes no responsibility for the testing of our products in combination with upholstery covers, or for the results of any testing conducted. Some specific configurations of product and upholstery have already been tested. Please contact Customer Service for additional information.

## C.O.L. Yardage

To calculate C.O.L. yardage required, please use the following conversions based on COM yardage: Leather must be ordered in square footage.

- 17 square feet in a yard
- Approx. 3 yards in a hide
- Approx. 51 square feet in a hide
- Please use grade 3 pricing for COL

## Upholstery Cover Yardage Calculation

To calculate yardage required for COM and other non-standard upholstery cover orders, please contact Krug Customer Service at 1.888.578.5784. Unless otherwise stated, upholstery cover rolls are assumed to be a minimum 54" wide. Please use the guide below to calculate the percentage of extra upholstery cover required to cover large repeats. The repeat is calculated by adding both the vertical and horizontal measurements together and then referring to the chart below for extra yardage required.

		2"-14"	15"-19"	20"-27"	28"-36"
FABRIC	Plain	Repeat	Repeat	Repeat	Repeat
54	0%	10%	15%	20%	25%
53-50	16%	20%	25%	30%	35%
48	16%	25%	30%	35%	40%
45	40%	50%	55%	60%	65%
36	50%	60%	65%	70%	75%

# GRADED-IN UPHOLSTERY PROGRAMS

Krug has partnered with several textile brands to grade in their offerings, designed to provide a wide range of upholstery selections for our seating products.

Upholstery pricing and availability is subject to change without notice. We grade this upholstery according to the pricing of the fabric suppliers - when their pricing changes, the Krug grade may change.

When placing an order, a Krug customer must specify the complete upholstery number, along with the appropriate Krug model number and finish. Krug will supply the complete product at the prices listed. Orders specifying graded-in upholstery cannot be cancelled once the upholstery has been ordered.

## Upholstery Grades

To determine the price of a product for graded-in upholstery, use the reference lists located on Krug's website under - Products - Textiles, to view the upholstery grade (1-9). Krug is not responsible for the discontinuation of this upholstery. Please contact Customer Service for information on upholstery not listed.

When two upholstery selections are specified for use on seating, the higher grade upholstery price will apply to the order.

High Performance upholstery; Polyurethane, Vinyl or Crypton, is particularly suitable for healthcare and other intensive-use environments.

## Upholstery Samples

If you require additional samples or memos for presentation, please contact fabric supplier directly.

## Flammability Standards

- Tunnel Test Surface Ratings Class A rating
- Class 1 UFAC
- Passes State of California Technical Bulletin 117-Section E

Please contact fabric supplier directly for further flammability information pertaining to specific upholstery.

## Special Conditions

Acknowledgments will give the estimated delivery date of the finished product. Some upholstery is imported, and availability may affect estimated delivery time. For large projects, please contact fabric supplier directly for availability of yardage.

# KRUGEXPRESS PROGRAM

## PROGRAM DETAILS

*KrugExpress* orders are ready to ship by the date acknowledged. Delivery and shipping schedules may result in actual shipping of orders at a later date. Statutory holidays and scheduled factory vacations may add to acknowledged lead times of *KrugExpress* orders. Unless otherwise specified on the order, the customer's standard method of shipping Krug products will be utilized.

Available factory capacity for *KrugExpress* is filled by orders received on a "first come, first serve" basis. If the normal *KrugExpress* lead time is not available for your order because available capacity has been filled, you will be immediately advised of the earliest available ready-to-ship date. Please consult your Customer Service representative in advance if you wish to confirm the specific lead time availability for a *KrugExpress* order.

Orders must be received by midnight of a given day for that day to be considered the official day the order is received. Order lead times are acknowledged from the date the order is received, but not including the date the order is received.

*KrugExpress* orders must be "clean" when received in order to be considered officially received on a given day, and lead times will be acknowledged from the date orders are determined to be "clean". Changes to *KrugExpress* orders are not allowed under any circumstances.

Orders for product on *KrugExpress* must clearly state: "*KrugExpress*".

COM and graded-in upholstery is available on Krug Express. Orders are scheduled on Krug Express, and given the best available date, when the upholstery is received at Krug. Some conditions apply.

## SEATING PROGRAM

Orders for seating products on the *KrugExpress* program may be subject to quantity maximums. Please contact Krug Customer Service for more information.

Quantity maximums are dependent upon available capacity, in order to insure that we ship all orders on time.

Please note that the CAL 133 option is not available on *KrugExpress*.

# ZOLA | FINISHES

## WOOD FINISHES

Standard wood finishes are:

### Finishes on Beech

- Light Oak
- Harvest Oak
- Mahogany
- Mellow Oak
- Espresso
- Cordovan Walnut
- Natural Walnut
- Regular Walnut
- SilverGrey on Walnut
- Dark Walnut
- Clear Beech
- Medium Anigre

### Finishes on Cherry

- Appalachian Cherry
- American Cherry
- Imperial Cherry
- Sable Cherry
- Light Cherry
- Medium Cherry
- Natural Cherry
- Standard Cherry

### Finishes on Maple

- Clear Maple
- Honey Maple
- Wheat Maple

### PALETTE

Palette finishes available for applicable products.

- Black
- White
- Soft Green
- Steel Blue
- Slate

## NATURAL CHARACTERISTICS OF WOOD

Wood is a natural product with inherent color variations that will never be fully mitigated by the finishing process. Please anticipate variation in colors within a single unit, from piece to piece, and from Krug wood finish samples. If a very close match is required, a sample must be provided with the order and an upcharge will apply. Exact color matches are not possible.

### Custom Wood Finishes

Add 10% list to your order for special finishes, minimum upcharge is \$600 list per finish per order. (For example, on all orders up to \$6000 list, an upcharge of \$600 will apply, on orders \$6000 and up add 10% list to your order.)

Special finish upcharges on seating products are calculated on a grade 1 value. For orders with special finishes, a sample that is a minimum 3” by 3” must be received with the order. Special finishes may add additional lead time to production schedules. Since wood is a natural product, some variations in grain, color and stain acceptance will occur. In our finishing processes, we try to minimize variations, but some variation between samples and finished goods should be anticipated.

### Dual Finishes

Add 10% list per item if specifying dual finish.

### Standard Wood Finishes

No upcharge will be applied when specifying a finish available as standard on one species onto maple seating and occasional tables. Clear finishes are not available on other species since they are a clear finish on top of the natural veneer color.

## WOOD FINISHES TO MATCH STANDARD LAMINATES

- Willow on Beech
- Copper on Beech
- Shiraz Cherry on Beech
- Park Avenue Walnut on Beech
- Chocolate on Beech
- Nutmeg on Beech
- Portobello on Beech
- Ash on Beech
- Dune on Maple

## LAMINATES

Krug’s in-stock Laminates are available in 17 different laminate selections. Please note that 4 of the colors (Gingerbread, Portobello, Ash and Willow) have textured finishes and may not be appropriate for use in patient areas due to infection control concerns. Minimum order quantities and extended lead times may apply for exotic laminate colors, please check with customer service. Polymer Edge will be selected to match the worksurface. Krug’s previous laminate in-stock program will be phased out as in-stock supply depletes. Please contact customer service for availability.

### IN-STOCK LAMINATES

Wood Grain Laminates	High Pressure Laminate Supplier	Textured Wood Grain Laminates	High Pressure Laminate Supplier
Champagne	Tafisa T492CR	Gingerbread	Tafisa T556UR
Hardrock Maple	Formica 86992-58	Portobello	Tafisa T557UR
Dune	Tafisa T491CR	Ash	Tafisa T535AT
Copper	Tafisa T521CR	Willow	Tafisa T543AT
Shiraz Cherry	Tafisa T472CR	<b>Solid Laminates</b>	
Park Avenue Walnut	Wilsonart 7984-38	Designer White	Wilsonart D354-60
Chocolate	Tafisa T498CR	Platinum	Tafisa T202CR
Nutmeg	Tafisa T477CR	Earth	Tafisa T767CR
Dark Walnut	Tafisa T469CR	Charcoal	Tafisa T228CR

### PHASE OUT LAMINATES

Almond - Black- Shadows - Edgewood Sycamore - Gunstock Walnut

### Non-Stocked Laminates

For specific lead time and application questions, please contact Krug Customer Service for your requirement. Upcharges will be applicable for non-stocked laminates, depending on their cost. Non-stock laminates may require a minimum order quantity, please contact customer service. Stocked polymer edges only can be specified for use with non-stocked laminates or tops will be self-edged.

**METAL FINISHES**

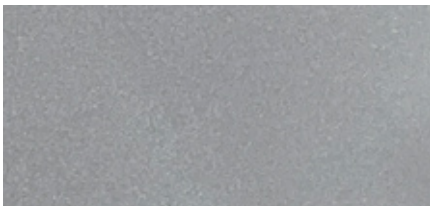

Silver Metallic



Matte Black

**URETHANE COLOR OPTIONS**



Taupe



Grey



Black

**SOLID SURFACE PROGRAM**

The Solid Surface option provides an enhanced durability, protection and cleanability. It is available in 8 standard colors and is replaceable if it becomes damaged or degraded. See individual products for list upcharge chart.

**GROUP GRADE A - WHITE**



Glacier White

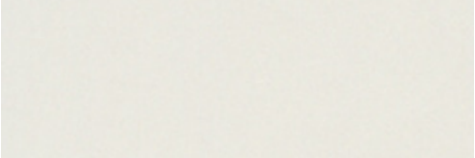

Cameo White

**GROUP GRADE A - COLOR**



Bisque

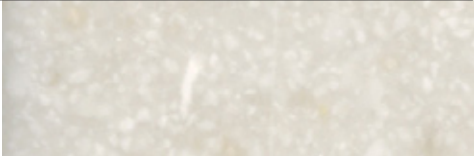

Linen

**GROUP GRADE B**

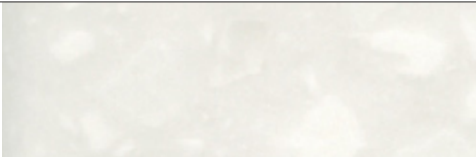

Antarctica



Savannah

**GROUP GRADE C**



Dove



Deep Night Sky



FSC  
www.fsc.org  
FSC® C021699

The mark of responsible forestry



All products are air emissions certified and are available as FSC® certified

# krug

solutions@krug.ca | www.krug.ca | 1.888.578.KRUG